

ASUS[®] MEW-AM

Socket 370 Intel[®] 810
microATX Motherboard

USER'S MANUAL

USER'S NOTICE

No part of this manual, including the products and software described in it, may be reproduced, transmitted, transcribed, stored in a retrieval system, or translated into any language in any form or by any means, except documentation kept by the purchaser for backup purposes, without the express written permission of ASUSTeK COMPUTER INC. ("ASUS").

ASUS PROVIDES THIS MANUAL "AS IS" WITHOUT WARRANTY OF ANY KIND, EITHER EXPRESS OR IMPLIED, INCLUDING BUT NOT LIMITED TO THE IMPLIED WARRANTIES OR CONDITIONS OF MERCHANTABILITY OR FITNESS FOR A PARTICULAR PURPOSE. IN NO EVENT SHALL ASUS, ITS DIRECTORS, OFFICERS, EMPLOYEES OR AGENTS BE LIABLE FOR ANY INDIRECT, SPECIAL, INCIDENTAL, OR CONSEQUENTIAL DAMAGES (INCLUDING DAMAGES FOR LOSS OF PROFITS, LOSS OF BUSINESS, LOSS OF USE OR DATA, INTERRUPTION OF BUSINESS AND THE LIKE), EVEN IF ASUS HAS BEEN ADVISED OF THE POSSIBILITY OF SUCH DAMAGES ARISING FROM ANY DEFECT OR ERROR IN THIS MANUAL OR PRODUCT.

Product warranty or service will not be extended if: (1) the product is repaired, modified or altered, unless such repair, modification or alteration is authorized in writing by ASUS; or (2) the serial number of the product is defaced or missing.

Products and corporate names appearing in this manual may or may not be registered trademarks or copyrights of their respective companies, and are used only for identification or explanation and to the owners' benefit, without intent to infringe.

- QuickStart and JumperFree are trademarks of ASUSTeK Computer Inc.
- Intel, LANDesk, and Pentium are registered trademarks of Intel Corporation.
- IBM and OS/2 are registered trademarks of International Business Machines.
- Symbios is a registered trademark of Symbios Logic Corporation.
- Windows and MS-DOS are registered trademarks of Microsoft Corporation.
- Adobe and Acrobat are registered trademarks of Adobe Systems Incorporated.

The product name and revision number are both printed on the product itself. Manual revisions are released for each product design represented by the digit before and after the period of the manual revision number. Manual updates are represented by the third digit in the manual revision number.

For previous or updated manuals, BIOS, drivers, or product release information, contact ASUS at <http://www.asus.com.tw> or through any of the means indicated on the following page.

SPECIFICATIONS AND INFORMATION CONTAINED IN THIS MANUAL ARE FURNISHED FOR INFORMATIONAL USE ONLY, AND ARE SUBJECT TO CHANGE AT ANY TIME WITHOUT NOTICE, AND SHOULD NOT BE CONSTRUED AS A COMMITMENT BY ASUS. ASUS ASSUMES NO RESPONSIBILITY OR LIABILITY FOR ANY ERRORS OR INACCURACIES THAT MAY APPEAR IN THIS MANUAL, INCLUDING THE PRODUCTS AND SOFTWARE DESCRIBED IN IT.

Copyright © 1999 ASUSTeK COMPUTER INC. All Rights Reserved.

Product Name: **ASUS MEW-AM**
Manual Revision: **1.01 E415**
Release Date: **June 1999**

ASUS CONTACT INFORMATION

ASUSTeK COMPUTER INC. (Asia-Pacific)

Marketing

Address: 150 Li-Te Road, Peitou, Taipei, Taiwan 112
Telephone: +886-2-2894-3447
Fax: +886-2-2894-3449
Email: info@asus.com.tw

Technical Support

Tel (English): +886-2-2894-3447 ext. 706
Tel (Chinese): +886-2-2894-3447 ext. 111
Fax: +886-2-2895-9254
Email: tsd@asus.com.tw
Newsgroup: news2.asus.com.tw
WWW: www.asus.com.tw
FTP: ftp.asus.com.tw/pub/ASUS

ASUS COMPUTER INTERNATIONAL (America)

Marketing

Address: 6737 Mowry Avenue, Mowry Business Center, Building 2
Newark, CA 94560, USA
Fax: +1-510-608-4555
Email: info-usa@asus.com.tw

Technical Support

Fax: +1-510-608-4555
BBS: +1-510-739-3774
Email: tsd-usa@asus.com.tw
WWW: www.asus.com
FTP: ftp.asus.com.tw/pub/ASUS

ASUS COMPUTER GmbH (Europe)

Marketing

Address: Harkort Str. 25, 40880 Ratingen, BRD, Germany
Telephone: 49-2102-445011
Fax: 49-2102-442066
Email: sales@asuscom.de

Technical Support

Hotline: 49-2102-499712
BBS: 49-2102-448690
Email: tsd@asuscom.de
WWW: www.asuscom.de
FTP: ftp.asuscom.de/pub/ASUSCOM

CONTENTS

| | |
|---|-----------|
| 1. INTRODUCTION | 7 |
| 1.1 How this manual is organized | 7 |
| 1.2 Item Checklist | 7 |
| 2. FEATURES | 8 |
| 2.1 The ASUS MEW-AM Motherboard | 8 |
| 2.1.1 Specifications | 8 |
| 2.1.3 Performance | 9 |
| 2.2 ASUS MEW-AM Part Definitions | 10 |
| 2.3 ASUS MEW-AM Part Locations | 11 |
| 3. HARDWARE SETUP | 12 |
| 3.1 Motherboard Layout | 12 |
| 3.3 Hardware Setup Procedure | 13 |
| 3.2 Layout Contents | 13 |
| 3.4 Motherboard Settings | 14 |
| 3.5.1 General DIMM Notes | 15 |
| 3.5 System Memory (DIMM) | 15 |
| 3.5.2 DIMM Memory Installation | 16 |
| 3.6 Central Processing Unit (CPU) | 17 |
| 3.7 Expansion Cards | 18 |
| 3.7.1 Expansion Card Installation Procedure | 18 |
| 3.8 External Connectors | 19 |
| 3.9 Power Connection Procedures | 27 |
| 4.1 Managing and Updating Your BIOS | 28 |
| 4.1.1 Upon First Use of the Computer System | 28 |

CONTENTS

| | |
|--|-----------|
| 4. BIOS SETUP | 28 |
| 4.1 Flash Memory Writer Utility | 28 |
| 4.1.1 Main Menu | 28 |
| 4.1.2 Updating BIOS Procedures (only when necessary) | 29 |
| 4.2 BIOS Setup Program | 31 |
| 4.2.1 BIOS Menu Bar | 32 |
| 4.2.2 Legend Bar | 32 |
| 4.3 Main Menu | 34 |
| 4.3.1 Primary & Secondary Master/Slave | 35 |
| 4.3.2 Keyboard Features | 38 |
| 4.4 Advanced Menu | 40 |
| 4.4.1 I/O Device Configuration | 41 |
| 4.5 Security Menu | 42 |
| 4.6 Power Menu | 44 |
| General Power Settings | 44 |
| Power-Up Events | 44 |
| 4.7 Boot Menu | 45 |
| Boot Sequence | 45 |
| 4.8 Exit Menu | 46 |

FCC & DOC COMPLIANCE

Federal Communications Commission Statement

This device complies with FCC Rules Part 15. Operation is subject to the following two conditions:

- This device may not cause harmful interference, and
- This device must accept any interference received, including interference that may cause undesired operation.

This equipment has been tested and found to comply with the limits for a Class B digital device, pursuant to Part 15 of the FCC Rules. These limits are designed to provide reasonable protection against harmful interference in a residential installation. This equipment generates, uses and can radiate radio frequency energy and, if not installed and used in accordance with manufacturer's instructions, may cause harmful interference to radio communications. However, there is no guarantee that interference will not occur in a particular installation. If this equipment does cause harmful interference to radio or television reception, which can be determined by turning the equipment off and on, the user is encouraged to try to correct the interference by one or more of the following measures:

- Re-orient or relocate the receiving antenna.
- Increase the separation between the equipment and receiver.
- Connect the equipment to an outlet on a circuit different from that to which the receiver is connected.
- Consult the dealer or an experienced radio/TV technician for help.

WARNING! Any changes or modifications to this product not expressly approved by the manufacturer could void any assurances of safety or performance and could result in violation of Part 15 of the FCC Rules.

Canadian Department of Communications Statement

This digital apparatus does not exceed the Class B limits for radio noise emissions from digital apparatus set out in the Radio Interference Regulations of the Canadian Department of Communications.

This Class B digital apparatus complies with Canadian ICES-003.

Cet appareil numérique de la classe B est conforme à la norme NMB-003 du Canada.

1. INTRODUCTION

1.1 How this manual is organized

This manual is divided into the following sections:

- | | |
|--------------------------|--|
| 1) INTRODUCTION | Manual information and checklist |
| 2) FEATURES | Product information and specifications |
| 3) HARDWARE SETUP | Instructions on setting up the motherboard |
| 4) BIOS SETUP | Instructions on setting up the BIOS software |

1.2 Item Checklist

Check that your package is complete. If you discover damaged or missing items, please contact your retailer.

- (1) ASUS Motherboard
- (1) Serial COM2 connector with bracket
- (1) 40-pin ribbon cable for internal UltraDMA/33 IDE drives
- (1) 80-wire ribbon cable for internal UltraDMA/66 or UltraDMA/33 IDE drives
(Note: The 80-wire cable has a 40-pin connector.)
- (1) Ribbon cable for (1) 5.25" and (2) 3.5" floppy drives
- (1) Bag of spare jumper caps
- (1) Support CD with drivers and utilities
- (1) This Motherboard User's Manual

2. FEATURES

2.1 The ASUS MEW-AM Motherboard

The MEW-AM motherboard from ASUS is designed for the new PC user who wants simple features in a small package.

2.1.1 Specifications

- **Latest Intel Socket 370 Processor Support!** Supports Intel's Celeron processor designed for Socket 370 and packaged in **Plastic Pin Grid Array (PPGA)**.
- **Latest Intel 810-DC100 Chipset!** The 810-DC100 (GMCH+ICH) supports 66/100MHz FSB, UltraDMA/66, and 4MB 32-bit 100MHz SDRAM display cache controller.
- **Integrated Graphics!** Controller supports 3D hyper pipelined architecture, parallel data processing and compression, precise pixel interpolation, full 2D hardware acceleration, and motion video acceleration. Optional onboard 4MB SDRAM display cache allows up to 1024x768x16bit color for 3D graphics and 1600x1200x8bit color for 2D graphics.
- **ASUS Graphics Driver!** You can gain about 12% performance over that of the standard graphics driver (2D highend graphics WinMark) using ASUS' custom graphics driver. ASUS custom graphics driver also provides more features and provides selection of higher refresh rates and resolutions.
- **Versatile Memory Support!** DRAM controller supports asymmetrical addressing and two DIMM sockets support Intel PC100-compliant SDRAMs (16, 32, 64, 128, or 256MB) up to 512MB. (supports a maximum of 4 sides)
- **Latest Low Pin Count Multi-I/O:** Provides two high-speed UART compatible serial ports and one parallel port with EPP and ECP capabilities.
- **Integrated IDE!** Controller supports UltraDMA/66 up to 66MB/s, UltraDMA/33 up to 33MB/s, and PIO Mode 4 up to 17MB/s.
- **Desktop Management Interface (DMI) V2.3!** Supports DMI through BIOS, which allows hardware to communicate within a standard protocol creating a higher level of compatibility. (Requires DMI-enabled components.)
- **Peripheral Wake-Up!** Supports Wake-On-LAN, Wake-On-Ring, Keyboard Wake-Up, and BIOS Wake-Up.
- **Firmware Hub!** Provides security and other latest power computing features.
- **Smart BIOS!** 4Mb firmware gives a new easy-to-use interface which provides more control and protection over the motherboard. Provides boot block write protection and HD/SCSI/MO/ZIP/CD/Floppy boot selection. Hardware random number generator supports new security software for data protection and secured Internet transactions.
- **Enhanced ACPI & Anti-Boot Virus Protection!** Programmable BIOS (Flash EEPROM), offering enhanced ACPI for Windows 98 compatibility, built-in firmware-based virus protection, and autodetection of most devices for virtually automatic setup.

2. FEATURES

- **Highest Audio Quality!** AC'97 DAC/ADC (software audio) built into the audio CODEC reduces noise to improve audio quality and performance for a SNR (signal to noise ratio) of +90dB. These features greatly improve voice synthesis and recognition. If more quality is required, an optional onboard Crystal PCI audio improves audio quality beyond software audio.

2.1.3 Performance

- **UltraPerformance!** Onboard IDE Bus Master controller with two connectors that support four IDE devices in two channels. Supports UltraDMA/66, UltraDMA/33 (IDE DMA Mode 2), PIO Modes 3 & 4, and supports Enhanced IDE devices, such as Tape Backup, CD-ROM, CD-R/RW, and LS-120 drives.
- **Dual Speeds!** CPU frequency can operate at either 66MHz or 100MHz while system memory operates at either 100MHz or 66MHz. (100MHz CPU with 66MHz SDRAM setting not supported) This asynchronous design can optimize the VGA performance under shared memory configuration. Of course 100MHz/100MHz synchronous host/DRAM clock is recommended for maximum performance.
- **Double or Quadruple the IDE Transfer Speed!** IDE transfers using UltraDMA/33 Bus Master IDE can handle rates up to 33MB/s and up to 66MB/s using UltraDMA/66 technology. The best of all is that these new technology is compatible with existing ATA-2 IDE specifications so there is no need to upgrade current IDE devices or cables.
- **Concurrent PCI!** Concurrent PCI allows multiple PCI transfers from PCI master buses to memory to CPU.
- **SDRAM Optimized Performance!** ASUS smart series motherboards support the new generation memory, Synchronous Dynamic Random Access Memory (SDRAM), which increases the data transfer rate to 800MB/s max using PC100 SDRAM.
- **ACPI Ready!** ACPI (Advanced Configuration and Power Interface) is also implemented on all ASUS smart series motherboards. ACPI provides more Energy Saving Features for future operating systems (OS) supporting OS Direct Power Management (OSPM) functionality. With these features implemented in the OS, PCs can be ready around the clock, yet satisfy all the energy saving standards. To fully utilize the benefits of ACPI, an ACPI-supported OS such as Windows 98 must be used.
- **Extreme Graphics!** The integrated motion compensation allows for smooth MPEG1 or MPEG2 video playback. Fast 3D graphics engine allows for an exciting gameplay experience.

2. FEATURES

2.2 ASUS MEW-AM Part Definitions

The following are part descriptions for the motherboard parts shown on the next page.

- 1 Socket 370 for Intel Celeron 370 processors
- 2 DIMM Sockets
- 3 ATX Power Connector for connection to an ATX power supply
- 4 Four Mbit Firmware Hub (programmable BIOS)
- 5 Floppy Disk Drive Connector
- 6 Primary and Secondary IDE Connectors
- 7 Low Pin Count Multi-I/O Chipset
- 8 Wake-On-LAN Connector
- 9 Intel I/O Controller Hub (ICH)
- 10 Intel 810-DC100 (GMCH-DC100) Integrated Graphics Chipset
- 11 High-speed 4MB SDRAM for integrated AGP VGA
- 12 Serial COM2 Header
- 13 Four PCI Slots
- 14 Crystal Audio Chipset (optional)
- 15 AC'97 V2.1 Audio CODEC
- 16 Joystick, Midi, Line Out, Line In, Microphone In Connectors (optional)
- 17 VGA Monitor Output Connector
- 18 Parallel Connector
- 19 Serial COM1 Connector
- 20 USB Connectors
- 21 PS/2 Mouse, PS/2 Keyboard Connectors

2. FEATURES

2.3 ASUS MEW-AM Part Locations

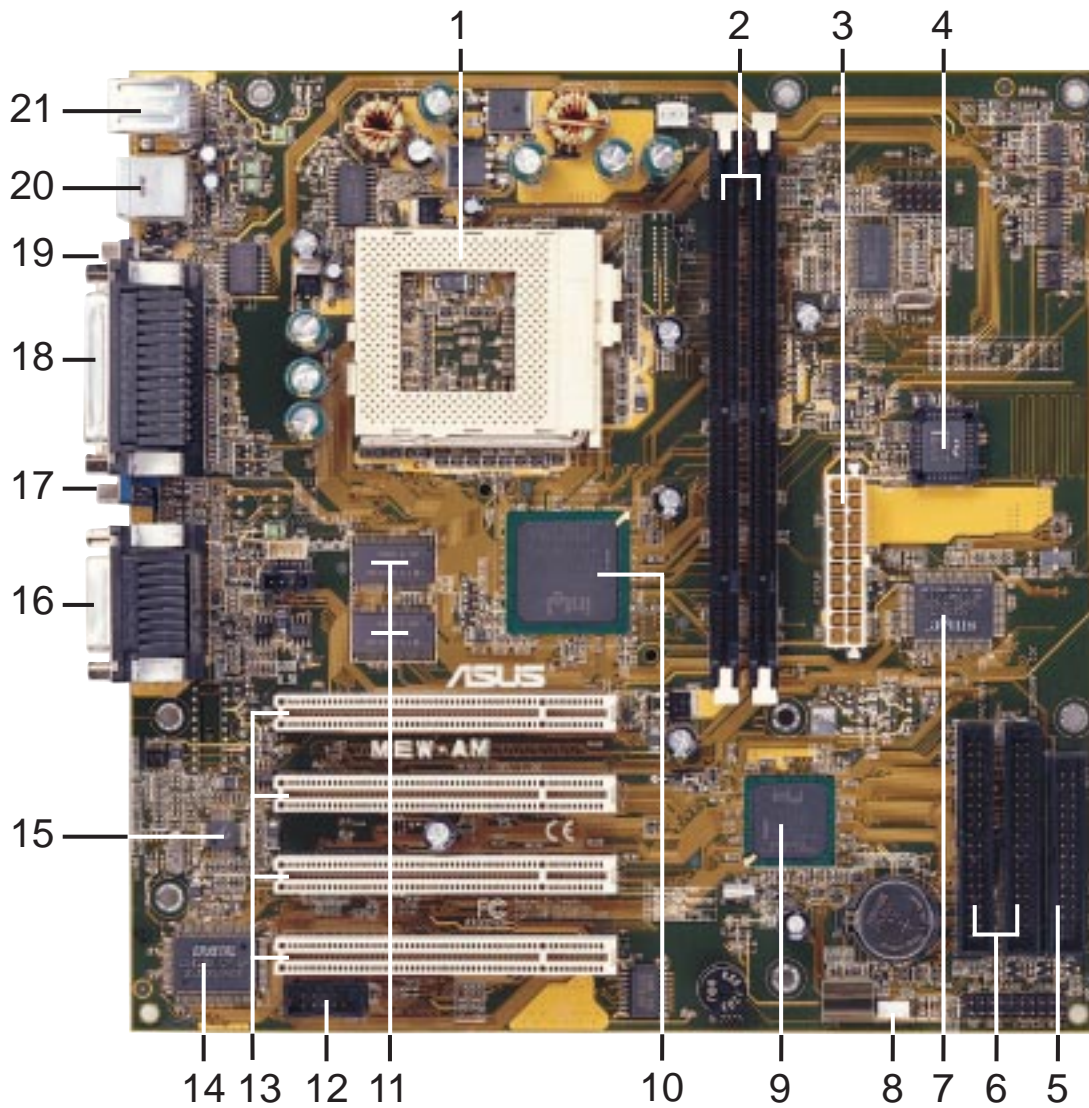

2. FEATURES
Part Locations

3. HARDWARE SETUP

3.1 Motherboard Layout

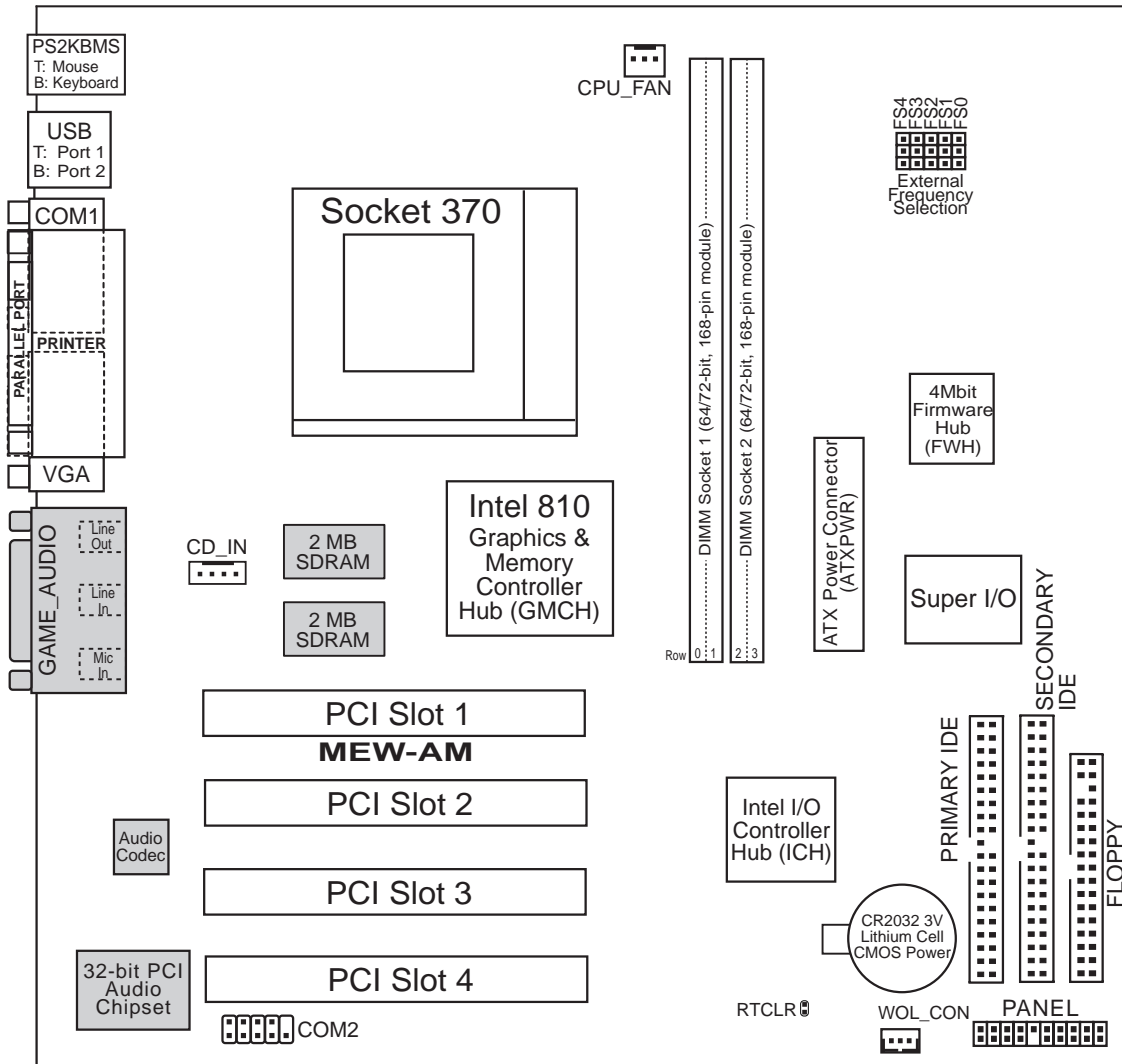

(Grayed items are optional at the time of purchase.)

3. HARDWARE SETUP

3.2 Layout Contents

Motherboard Settings

- 1) FS0, FS1, FS2, FS3, FS4 p.14 CPU External Clock (BUS) Frequency Setting

Expansion Slots

- 1) DIMM1, DIMM2 p.15 168-Pin DIMM Memory Support
2) Socket 370 p.17 Central Processing Unit (CPU) Socket
3) PCI1, PCI2, PCI3, PCI4 p.18 32-bit PCI Bus Expansion Slots

Connectors

- 1) PS2KBMS p.19 PS/2 Mouse Connector (6-pin female)
2) PS2KBMS p.19 PS/2 Keyboard Connector (6-pin female)
3) USB p.20 Universal Serial Bus Ports 1 & 2 (Two 4-pin female)
4) PRINTER p.20 Parallel Port Connector (25-pin female)
5) COM1 p.20 Serial Port COM1 Connector (9-pin male)
6) VGA p.21 Monitor (VGA) Output Connector (15-pin female)
7) GAME_AUDIO p.21 Joystick/MIDI Connector (15-pin female) (optional)
8) GAME_AUDIO p.21 Audio Port Connectors (Three 1/8" female) (optional)
9) PRIMARY/SECONDARY IDE p.22 Primary/Secondary IDE Connectors (Two 40-1pins)
10) FLOPPY p.22 Floppy Disk Drive Connector (34-1pins)
11) WOL_CON p.23 Wake-On-LAN Connector (3 pins)
12) COM2 p.23 Serial Port COM2 Header (10-1 pins)
13) CPU_FAN p.24 CPU Fan Connectors (3 pins)
14) LED (PANEL) p.25 System Message LED (2 pins)
15) KEYLOCK (PANEL) p.25 Keyboard Lock Switch Lead (2 pins)
16) EXSMI (PANEL) p.25 System Management Interrupt Switch Lead (2 pins)
17) SPEAKER (PANEL) p.25 System Warning Speaker Connector (4 pins)
18) PWRSW (PANEL) p.25 ATX Power / Soft-Off Switch Lead (2 pins)
19) HDLED (PANEL) p.25 IDE Activity LED (2 pins)
20) PLED (PANEL) p.25 System Power LED Lead (3-1 pins)
21) RESET (PANEL) p.25 Reset Switch Lead (2 pins)
22) CD_IN p.26 Internal Audio Connector (4-pins) (optional)
23) ATXPWR p.26 ATX Power Supply Connector (20 pins)

3.3 Hardware Setup Procedure

Before using your computer, you must complete the following steps:

- **Check Motherboard Settings**
- **Install Memory Modules**
- **Install the Central Processing Unit (CPU)**
- **Install Expansion Cards**
- **Connect Ribbon Cables, Panel Wires, and Power Supply**

3. HARDWARE SETUP

3.4 Motherboard Settings

WARNING! Computer motherboards and expansion cards contain very delicate Integrated Circuit (IC) chips. To protect them against damage from static electricity, you should follow some precautions whenever you work on your computer.

1. Unplug your computer when working on the inside.
2. Use a grounded wrist strap before handling computer components. If you do not have one, touch both of your hands to a safely grounded object or to a metal object, such as the power supply case.
3. Hold components by the edges and try not to touch the IC chips, leads or connectors, or other components.
4. Place components on a grounded antistatic pad or on the bag that came with the component whenever the components are separated from the system.

1) CPU External Frequency Setting (FS0, FS1, FS2, FS3, FS4)

Current PCI bus is limited to 33MHz, Socket 370 Celeron processors limited to 66MHz, and SDRAM limited to the DIMM type 66/100/133MHz. (66MHz SDRAM is not supported on this motherboard.) Other settings are for experienced users only.

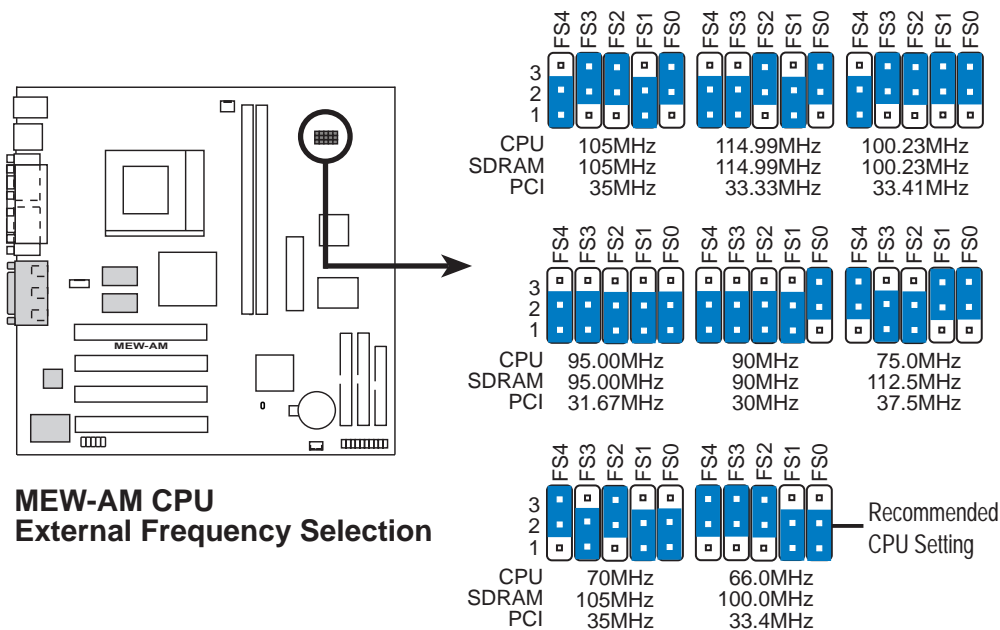

NOTE: For updated processor settings, please visit ASUS' web site (see ASUS CONTACT INFORMATION)

WARNING! CPU frequencies above 66MHz exceed the specifications for current Celeron processors and are not guaranteed to be stable. Premature wearing of the processor may result when overclocking. Be sure that the DIMM you use can handle the specified SDRAM MHz or else bootup will not be possible.

3. HARDWARE SETUP

3.5 System Memory (DIMM)

NOTE: No hardware or BIOS setup is required after adding or removing memory. This motherboard uses only Dual Inline Memory Modules (DIMMs). Sockets are available for **3.3Volt** (power level) unbuffered Synchronous Dynamic Random Access Memory (SDRAM).

This chipset does not support ECC. However, ECC memory modules may still be used, but the ECC function will not be available.

Install memory in any combination as follows:

| Location | 168-pin DIMM SDRAM | | Total Memory |
|---------------------|--|----|--------------|
| DIMM1 (Rows 0&1) | Single-Sided/Double-Sided 16, 32, 64, 128MB, or 256MB | x1 | |
| DIMM2 (Rows 2&3) | Single-Sided/Double-Sided 16, 32, 64, 128MB, or 256MB | x1 | |
| | Total System Memory (Max 512MB) | = | |

NOTE: At the time this User's Manual was written, 256MB DIMM's are only available as Double-Sided registered memory (128Mbit cells). Using 2x2x2 SDRAM can greatly improve the onboard graphics' performance.

3.5.1 General DIMM Notes

- This motherboard operates at 100MHz, therefore PC100-compliant modules must be used because of the strict timing issues involved under this speed.
- ASUS motherboards support SPD (Serial Presence Detect) DIMMs. This is the memory of choice for best performance vs. stability.
- SDRAM chips are generally thinner with higher pin density than EDO (Extended Data Output) chips.
- BIOS shows SDRAM memory on bootup screen.
- Single-sided DIMMs come in 16, 32, 64,128MB; double-sided come in 32, 64, 128, 256MB.

3. HARDWARE SETUP

3.5.2 DIMM Memory Installation

Insert the module(s) as shown. Because the number of pins are different on either side of the breaks, the module will only fit in the orientation shown. DIMM modules are longer and have different pin contact on each side and therefore have a higher pin density. SIMM modules have the same pin contact on both sides.

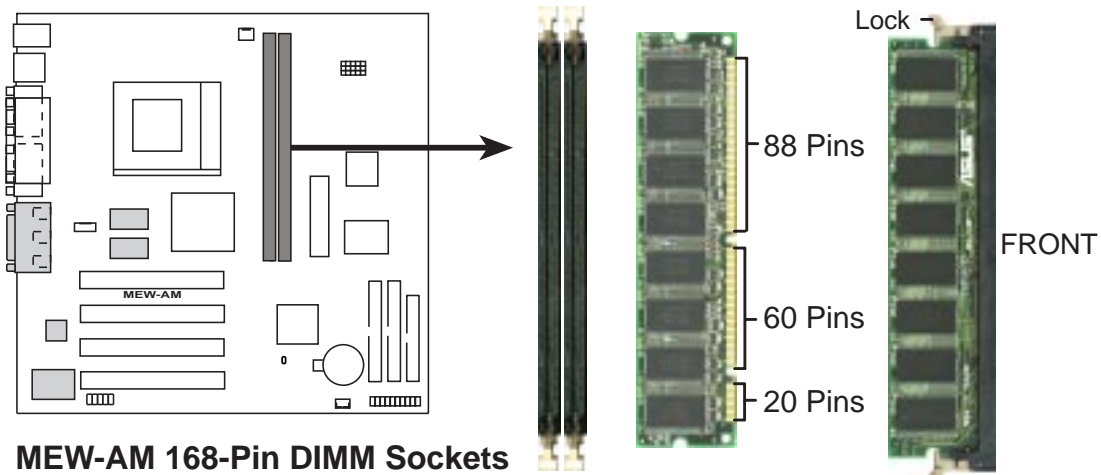

MEW-AM 168-Pin DIMM Sockets

The DIMMs must be **3.3V Unbuffered** for this motherboard. To determine the DIMM type, check the notches on the DIMMs (see figure below).

168-Pin DIMM Notch Key Definitions (3.3V)

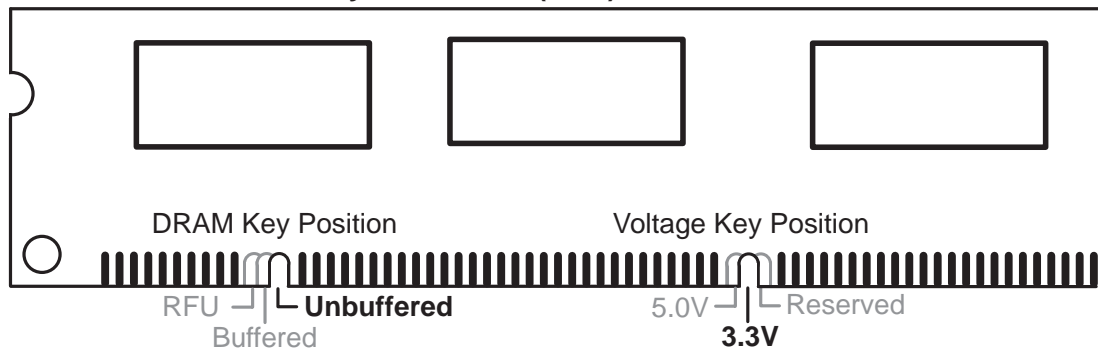

The notches on the DIMM module will shift between left, center, or right to identify the type and also to prevent the wrong type from being inserted into the DIMM slot on the motherboard. You must ask your retailer the correct DIMM type before purchasing. This motherboard supports four clock signals per DIMM slot.

3. HARDWARE SETUP

3.6 Central Processing Unit (CPU)

The motherboard provides a ZIF Socket 370. The CPU that came with the motherboard should have a fan attached to it to prevent overheating. If this is not the case, then purchase a fan before you turn on your system.

WARNING! Be sure that there is sufficient air circulation across the processor's heatsink by regularly checking that your CPU fan is working. Without sufficient circulation, the processor could overheat and damage both the processor and the motherboard. You may install an auxiliary fan, if necessary.

To install a CPU, first turn off your system and remove its cover. Locate the ZIF socket and open it by first pulling the lever sideways away from the socket then upwards to a 90-degree angle. Insert the CPU with the correct orientation as shown. The notched corner should point towards the end of the lever. Because the CPU has a corner pin for two of the four corners, the CPU will only fit in the orientation as shown. The picture is for reference only; you should have a CPU fan that covers the face of the CPU. With the added weight of the CPU fan, no force is required to insert the CPU. Once completely inserted, close the socket's lever while holding down the CPU.

NOTE: Do not forget to set the correct Bus Frequency and Multiple (frequency multiple setting is available only on unlocked processors) for your Socket 370 processor or else boot-up may not be possible.

CAUTION! Be careful not to scrape the motherboard when mounting a clamp-style processor fan or else damage may occur to the motherboard.

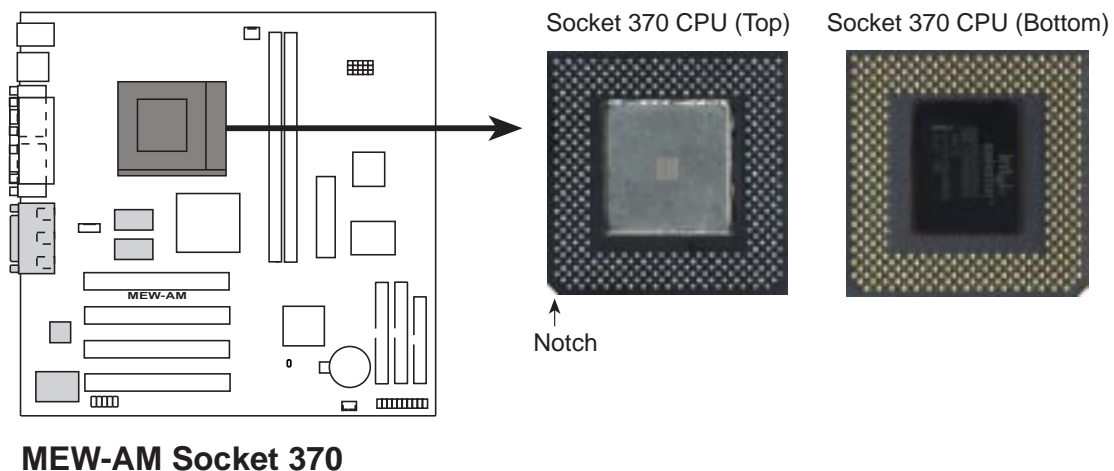

3. HARDWARE SETUP

3.7 Expansion Cards

WARNING! Make sure that you unplug your power supply when adding or removing expansion cards or other system components. Failure to do so may cause severe damage to both your motherboard and expansion cards.

3.7.1 Expansion Card Installation Procedure

1. Read the documentation for your expansion card and make any necessary hardware or software settings for your expansion card, such as jumpers or switches.
2. Remove your computer system's cover and the bracket plate with screw on the slot you intend to use. Keep the bracket for possible future use.
3. Carefully align the card's connectors and press firmly.
4. Secure the card on the slot with the screw you removed above.
5. Replace the computer system's cover.
6. Set up the BIOS if necessary.
7. Install the necessary software drivers for your expansion card.

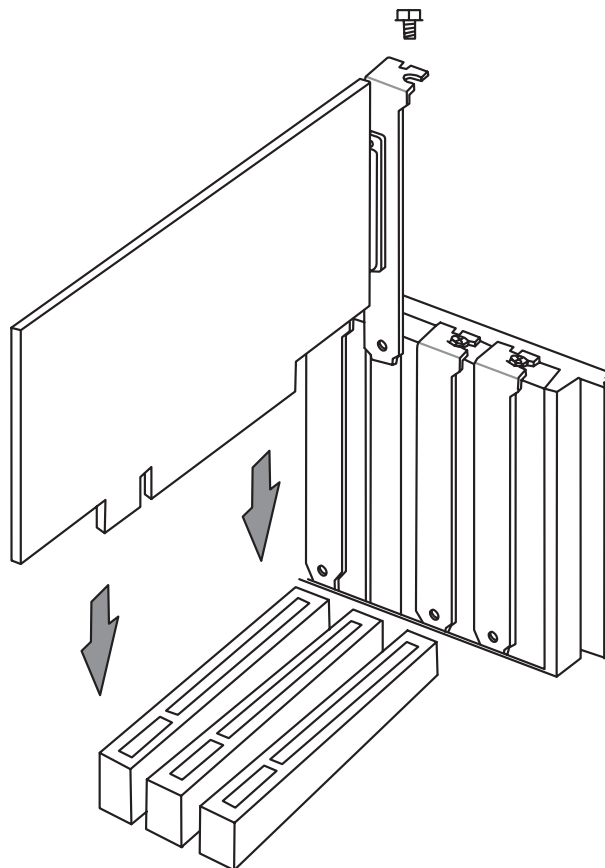

3. HARDWARE SETUP

3.8 External Connectors

WARNING! Some pins are used for connectors or power sources. These are clearly distinguished from jumpers in the Motherboard Layout. Placing jumper caps over these connector pins will cause damage to your motherboard.

IMPORTANT: Ribbon cables should always be connected with the red stripe to Pin 1 on the connectors. Pin 1 is usually on the side closest to the power connector on hard drives and CD-ROM drives, but may be on the opposite side on floppy disk drives. Check the connectors before installation because there may be exceptions. Look on IDE ribbon cable must be less than 46 cm (18 in.), with the second drive connector no more than 15 cm (6 in.) from the first connector.

1) PS/2 Mouse Connector (6-pin PS2KBMS)

The system will direct IRQ12 to the PS/2 mouse if one is detected. If one is not detected, expansion cards can use IRQ12.

PS/2 Mouse (6-pin Female)

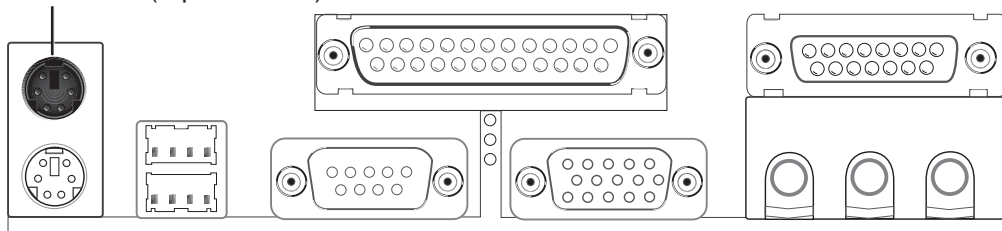

2) PS/2 Keyboard Connector (6-pin PS2KBMS)

This connection is for a standard keyboard using an PS/2 plug (mini DIN). **This connector will not allow standard AT size (large DIN) keyboard plugs. You may use a DIN to mini DIN adapter on standard AT keyboards.**

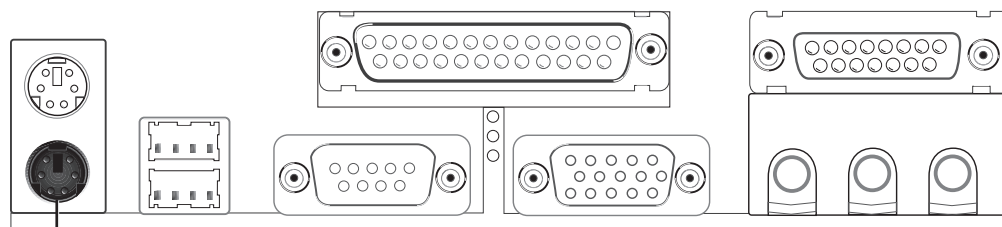

PS/2 Keyboard (6-pin Female)

3. HARDWARE SETUP

3) Universal Serial BUS Ports 1 & 2 (two 4-pin USB)

Two USB ports are available for connecting USB devices.

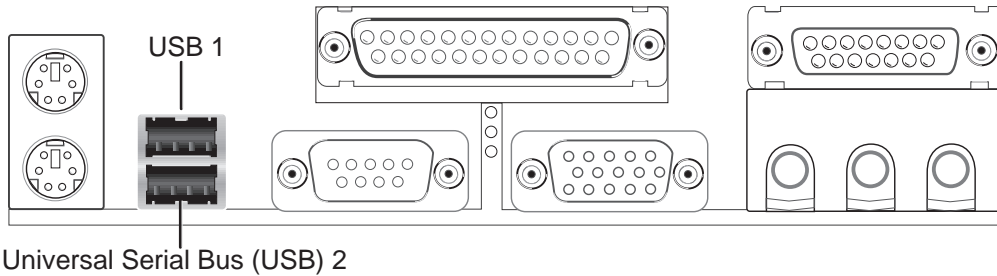

4) Parallel Port Connector (25-pin PRINTER)

The parallel connector is used for a single parallel device such as a printer or a portable drive. See **Parallel Port** in *4.4.1 I/O Device Configuration* for settings.

NOTE: Serial printers must be connected to the serial port.

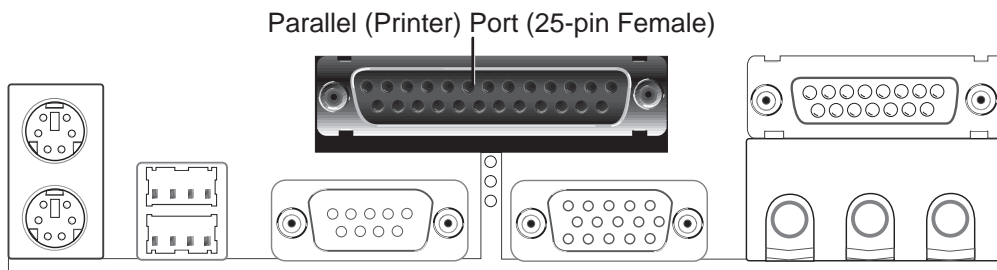

5) Serial Port COM1 Connector (9-pin COM1)

One serial port is ready for a mouse or other serial devices. A second serial port is available using a serial port bracket connected from the motherboard to an expansion slot opening. See **Serial Port A or B** in *4.4.1 I/O Device Configuration* for settings.

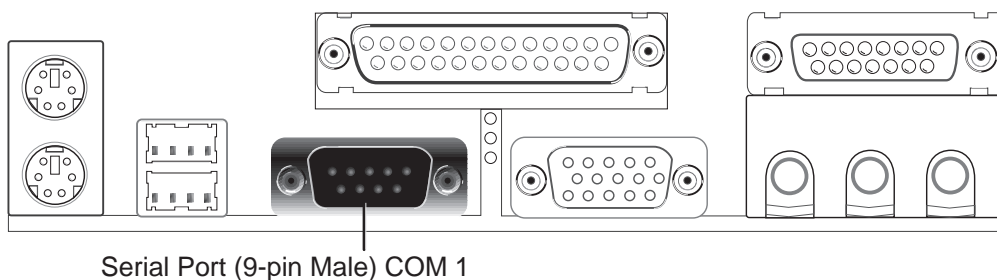

3. HARDWARE SETUP

6) Monitor Output Connector (15-pin VGA)

This connector is for output to a VGA-compatible device.

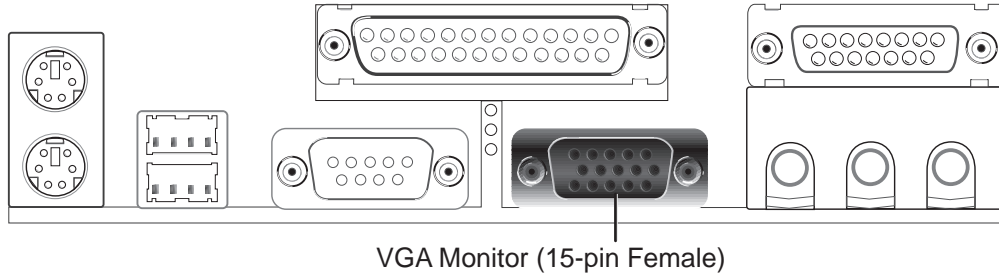

7) Joystick/MIDI Connector (15-pin GAME_AUDIO) (optional)

You may connect game joysticks or game pads to this connector for playing games. Connect MIDI devices for playing or editing professional audio.

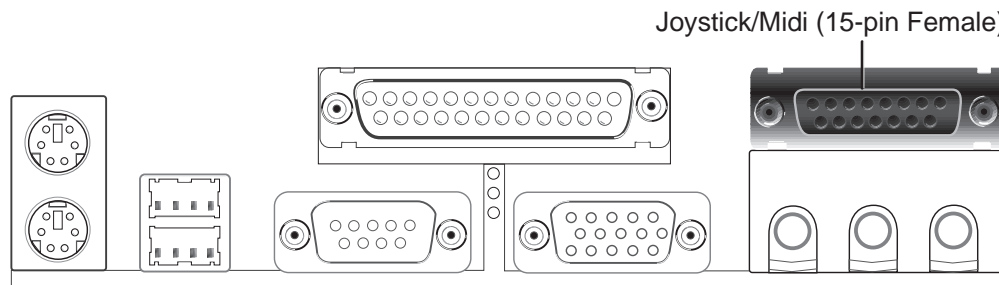

NOTE: The onboard game port is to be used only if you are not using any PCI or ISA audio card with a game port.

8) Audio Port Connectors (Three 1/8" GAME_AUDIO) (optional)

Line Out (lime) can be connected to headphones or preferably powered speakers. **Line In** (light blue) allows tape players or other audio sources to be recorded by your computer or played through the **Line Out** (lime). **Mic** (pink) allows microphones to be connected for inputting voice.

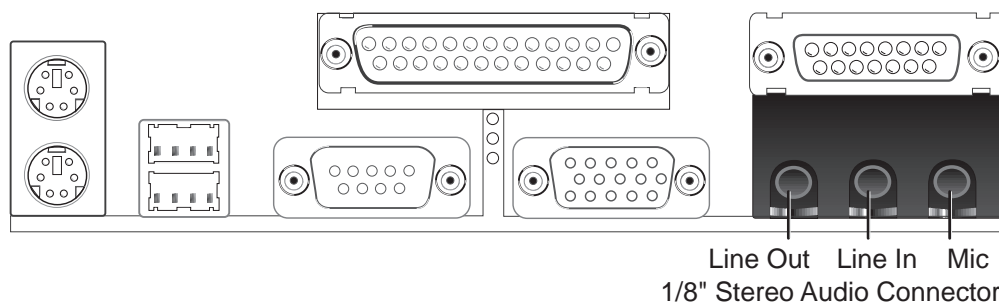

3. HARDWARE SETUP

9) Primary / Secondary IDE Connectors (Two 40-1pin IDE)

These connectors support the provided IDE hard disk ribbon cable. After connecting the single end to the board, connect the two plugs at the other end to your hard disk(s). If you install two hard disks, you must configure the second drive to Slave mode by setting its jumper accordingly. Please refer to your hard disk documentation for the jumper settings. **(Pin 20 is removed to prevent inserting in the wrong orientation when using ribbon cables with pin 20 plugged).**

TIP: You may configure two hard disks to be both Masters with two ribbon cables – one for the primary IDE connector and another for the secondary IDE connector and select the boot disk through **Boot Sequence** in **4.7 Boot Menu**.

IMPORTANT: UltraDMA/66 IDE devices must use an 80-wire IDE cable or else devices will automatically be limited to UltraDMA/33 mode.

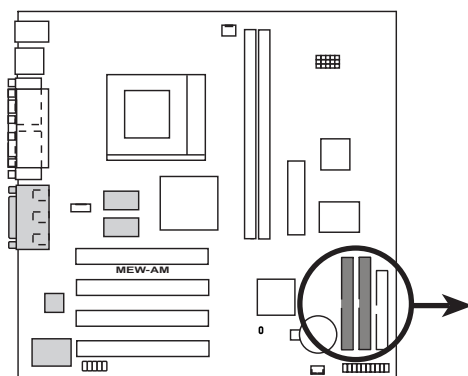

MEW-AM IDE Connectors

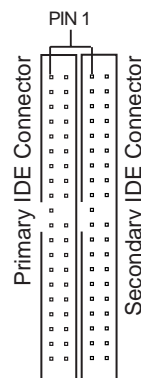

NOTE: Orient the red markings on the IDE ribbon cable to PIN 1

10) Floppy Disk Drive Connector (34-1pin FLOPPY)

This connector supports the provided floppy drive ribbon cable. After connecting the single end to the board, connect the two plugs on the other end to the floppy drives. **(Pin 5 is removed to prevent inserting in the wrong orientation when using ribbon cables with pin 5 plugged).**

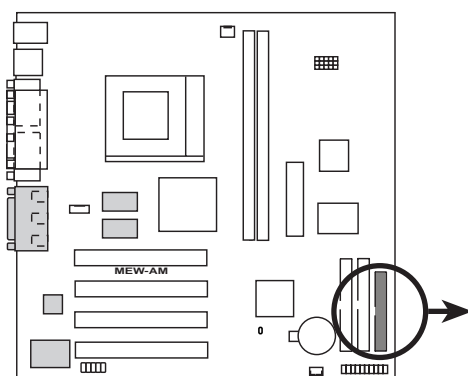

MEW-AM Floppy Disk Drive Connector

NOTE: Orient the red markings on the floppy ribbon cable to PIN 1



3. HARDWARE SETUP

11) Wake-On-LAN Connector (3-pin WOL_CON)

This connector connects to a LAN card with a Wake-On-LAN output, such as the ASUS PCI-L101 Ethernet card. The connector powers up the system when a wakeup packet or signal is received through the LAN card.

IMPORTANT: This feature requires that your system has an ATX power supply with at least 720mA +5V standby power.

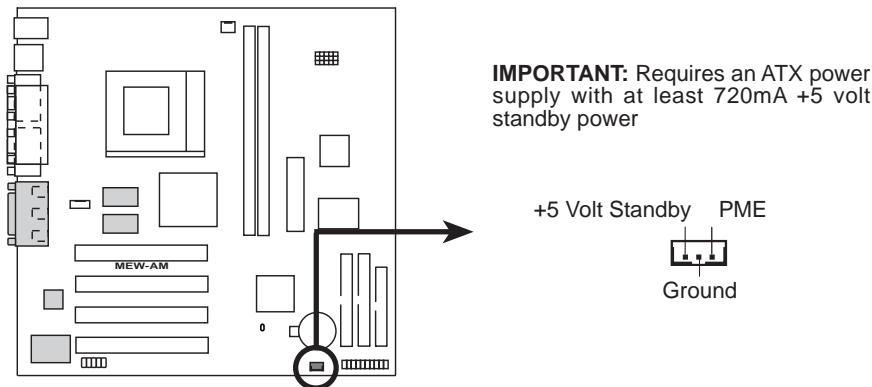

MEW-AM Wake-On-LAN Connector

12) Serial Port COM 2 Header (10-1 pin COM2)

The optional serial port bracket can be used to add an additional serial port for additional serial devices.

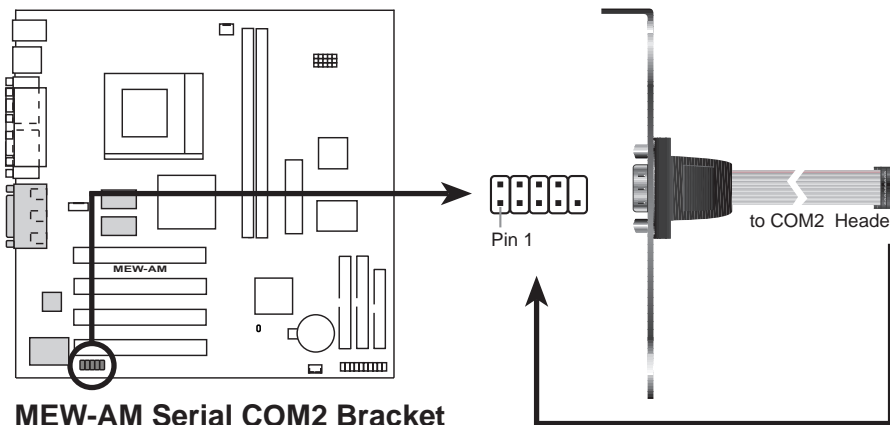

MEW-AM Serial COM2 Bracket

3. HARDWARE SETUP

13) CPU Fan Connectors (3-pin CPU_FAN)

This connector supports a cooling fan of 350mA (4.2 Watts) or less. Orientate the fan so that the heat sink fins allow airflow to go across the onboard heat sink(s) instead of the expansion slots. Depending on the fan manufacturer, the wiring and plug may be different. The red wire should be positive, while the black should be ground. Connect the fan's plug to the board taking into consideration the polarity of the connector.

NOTE: The "Rotation" signal cannot be monitored on this motherboard.

WARNING! The CPU and/or motherboard will overheat if there is no airflow across the CPU and onboard heatsinks. Damage may occur to the motherboard and/or the CPU fan if these pins are incorrectly used. **These are not jumpers, do not place jumper caps over these pins.**

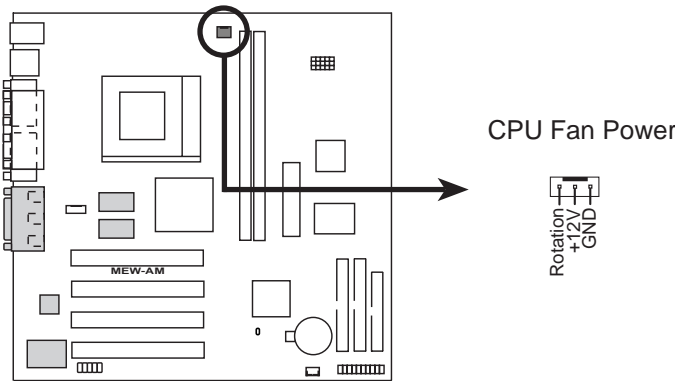

MEW-AM 12-Volt Cooling Fan Power

The following PANEL illustration is used for items 14-21

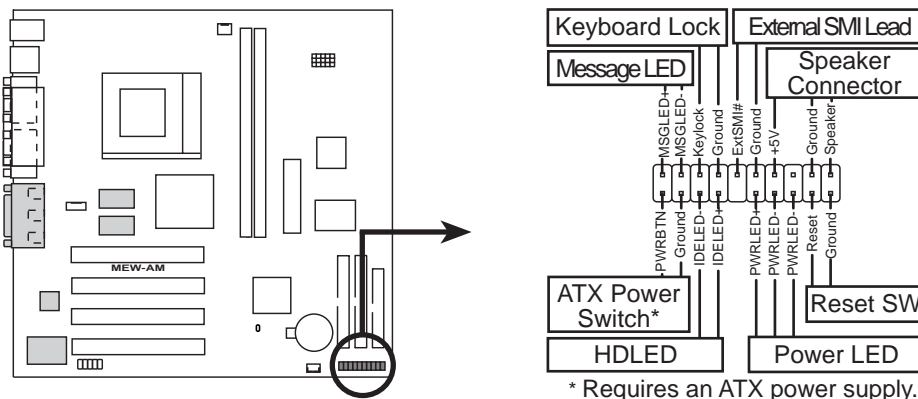

MEW-AM System Panel Connectors

* Requires an ATX power supply.

3. HARDWARE SETUP

14) Message LED Lead (2-pin LED)

This indicates whether the system is in normal mode or standby (suspend) mode. The LED will be dark in normal mode and will light in standby (suspend) mode.

15) Keyboard Lock Switch Lead (2-pin KEYLOCK)

This 2-pin connector connects to the case-mounted key switch to allow keyboard locking.

16) System Management Interrupt Lead (2-pin EXSMI)

This allows the user to manually place the system into a suspend mode or “Green” mode, where system activity is decreased to save electricity and expand the life of certain components when the system is not in use. This 2-pin connector connects to the case-mounted suspend switch. If you do not have a switch for the connector, you may use the “Turbo Switch.” SMI is activated when it detects a *short to open* moment and therefore leaving it shorted will not cause any problems. This may require one or two presses depending on the position of the switch. The keyboard can always allow wake-up but not the SMI lead.

17) System Warning Speaker Connector (4-pin SPEAKER)

This 4-pin connector connects to the case-mounted speaker. You may leave this disconnected if you connect the chassis speaker to the INT_SPKA. All three sources (LINE_OUT, INT_SPKA, SPEAKER) will allow you to here system beeps and warnings. Only LINE_OUT will allow you to hear system beeps before the integrated audio has been properly initialized.

18) ATX Power Switch Lead (2-pin PWRSW)

The system power is controlled by a momentary switch connected to this lead. Pressing the button once will switch the system between ON and SOFT OFF. Pushing the switch while in the ON mode for more than 4 seconds will turn the system off. The system power LED shows the status of the system’s power.

19) IDE Activity LED (2-pin HDLED)

This connector supplies power to the cabinet’s IDE activity LED. Read and write activity by devices connected to the Primary or Secondary IDE connectors will cause the LED to light up.

20) System Power LED Lead (3-1 pin PLED)

This 3-1 pin connector connects the system power LED, which lights when the system is powered ON and turns OFF when it is in standby (suspend) mode.

21) Reset Switch Lead (2-pin RESET)

This 2-pin connector connects to the case-mounted reset switch for rebooting your computer without having to turn off your power switch. This is a preferred method of rebooting to prolong the life of the system’s power supply.

3. HARDWARE SETUP

22) Internal Audio Connector (4-pin CD_IN) (optional)

These connectors allow you to receive stereo audio input from such sound sources as a CD-ROM, TV tuner, or MPEG card.

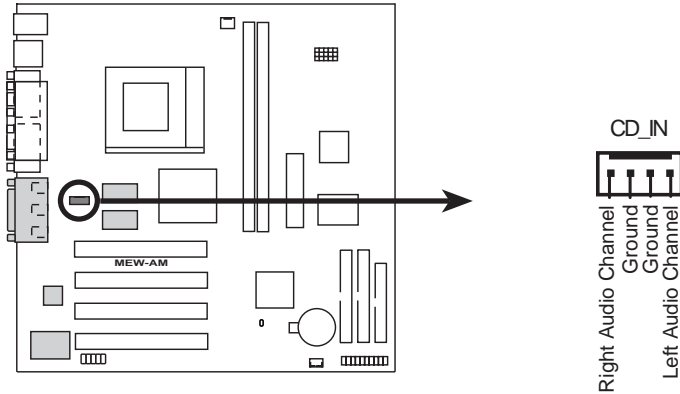

MEW-AM Internal Audio Connector

23) ATX Power Supply Connector (20-pin block ATXPWR)

This connector connects to an ATX power supply. The plug from the power supply will only insert in one orientation because of the different hole sizes. Find the proper orientation and push down firmly making sure that the pins are aligned.

IMPORTANT: Make sure that your ATX power supply can supply at least 10mA on the +5-volt standby lead (+5VSB). You may experience difficulty in powering ON your system if your power supply cannot support the load. For Wake-On-LAN support, your ATX power supply must supply at least 720mA +5VSB.

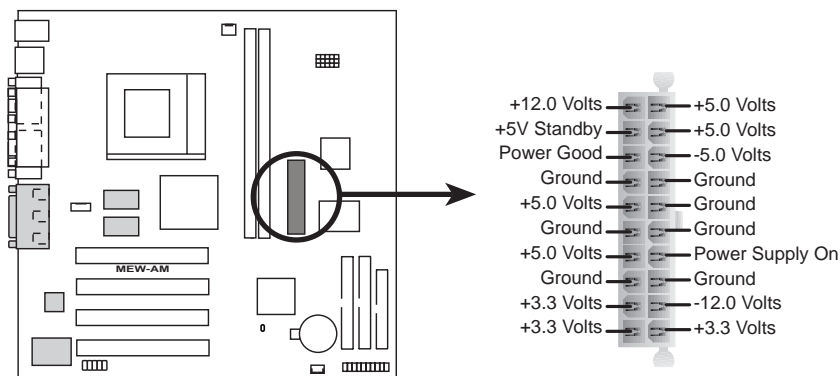

MEW-AM ATX Power Connector

3. HARDWARE SETUP

3.9 Power Connection Procedures

1. After all connections are made, close the system case cover.
2. Be sure that all switches are off (in some systems, marked with ○).
3. Connect the power supply cord to the power supply located on the back of your system case according to your system user's manual.
4. Connect the power cord to a power outlet that is equipped with a surge protector.
5. You may then turn on your devices in the following order:
 - a. Your monitor
 - b. External SCSI devices (starting with the last device on the chain)
 - c. Your system power

For ATX power supplies, you need to switch ON the power supply if a switch is provided as well as press the ATX power switch on the front of the case.

6. The power LED on the front panel of the system case will light. For ATX power supplies, the system LED will light when the ATX power switch is pressed. The LED on the monitor may light up or switch between orange and green after the system's if it complies with "green" standards or if it has a power standby feature. The system will then run power-on tests. While the tests are running, additional messages will appear on the screen. If you do not see anything within 30 seconds from the time you turn on the power, the system may have failed a power-on test. Check your jumper settings and connections again or call your retailer for assistance.
 7. During power-on, hold down <Delete> to enter BIOS setup. Follow the instructions in **4. BIOS SETUP**.
- * **Powering Off your computer:** You must first exit or shut down your operating system before switching off the power switch. For ATX power supplies, you can press the ATX power switch after exiting or shutting down your operating system. If you use Windows 95/98, click the **Start** button, click **Shut Down**, and then click **Shut down the computer?**. The power supply should turn off after Windows shuts down.

NOTE: The message "You can now safely turn off your computer" will not appear when shutting down with ATX power supplies.

4. BIOS SETUP

4.1 Managing and Updating Your BIOS

4.1.1 Upon First Use of the Computer System

It is recommended that you save a copy of the original motherboard BIOS along with a Flash Memory Writer utility (AFLASH.EXE) to a bootable floppy disk in case you need to reinstall the BIOS later. **AFLASH.EXE** is a Flash Memory Writer utility that updates the BIOS by uploading a new BIOS file to the programmable flash ROM on the motherboard. This file works only in DOS mode. To determine the BIOS version of your motherboard, check the last four numbers of the code displayed on the upper left-hand corner of your screen during bootup. Larger numbers represent a newer BIOS file.

1. Type **FORMAT A:/S** at the DOS prompt to create a bootable system floppy disk. **DO NOT** copy AUTOEXEC.BAT & CONFIG.SYS to the disk.
2. Type **COPY D:\AFLASH\AFLASH.EXE A:** (assuming D is your CD-ROM drive) to copy AFLASH.EXE to the just created boot disk.

NOTE: AFLASH works only in DOS mode. It will not work with DOS prompt in Windows and will not work with certain memory drivers that may be loaded when you boot from your hard drive. It is recommended that you reboot using a floppy.

3. Reboot your computer from the floppy disk. **NOTE:** BIOS setup must specify “Floppy” as the first item in the boot sequence.
4. In DOS mode, type **A:\AFLASH <Enter>** to run AFLASH.

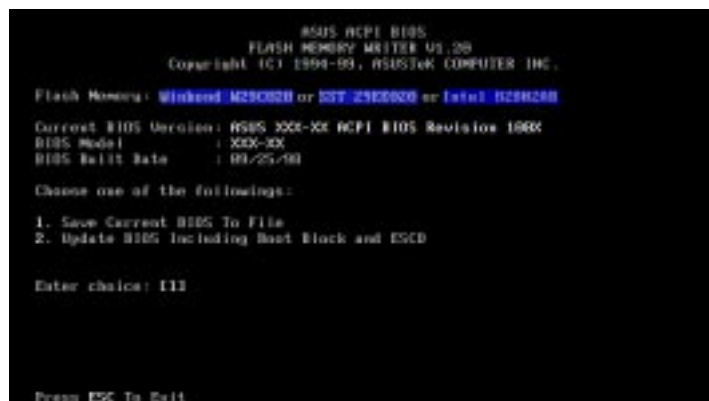

IMPORTANT! If “unknown” is displayed after **Flash Memory:**, the memory chip is either not programmable or is not supported by the ACPI BIOS and therefore, cannot be programmed by the Flash Memory Writer utility.

4. BIOS SETUP

5. Select **1. Save Current BIOS to File** from the Main menu and press <Enter>. The **Save Current BIOS To File** screen appears.

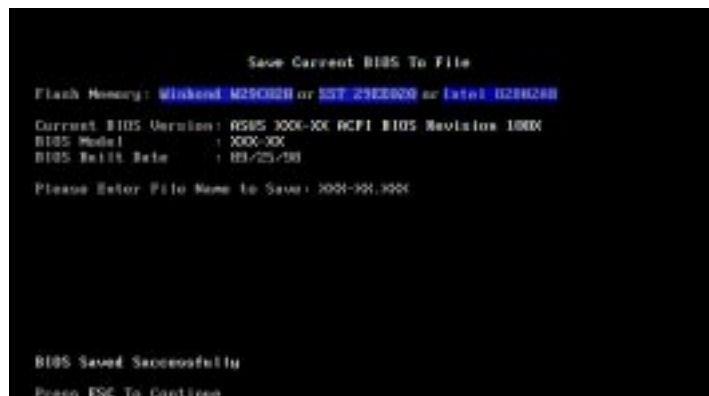

6. Type a filename and the path, for example, **A:\XXX-XX.XXX** and then press <Enter>.

4.1.2 Updating BIOS Procedures (only when necessary)

1. Download an updated ASUS BIOS file from the Internet (WWW or FTP) (see ASUS CONTACT INFORMATION on page 3 for details) and save to the disk you created earlier.
2. Boot from the disk you created earlier.
3. At the “A:” prompt, type **AFLASH** and then press <Enter>.
4. At the **Main Menu**, type **2** and then press <Enter>. The **Update BIOS Including Boot Block and ESCD** screen appears.
5. Type the filename of your new BIOS and the path, for example, **A:\XXX-XX.XXX**, and then press <Enter>.

NOTE: To cancel this operation, press <Enter>.



4. BIOS SETUP

- When prompted to confirm the BIOS update, press **Y** to start the update.

```
Update BIOS Including Boot Block and ESCD
Flash Memory: Winbond W25Q08 or SST 25Q08 or Intel I25N08
BIOS Version
CURRENT 3 ASUS 300-00 ACPI BIOS Revision 100K
Flash.ame3 ASUS 300-00 ACPI BIOS Revision 100K
BIOS Model
CURRENT 3 300-00
Flash.ame3 300-00
Date of BIOS Build
CURRENT 3 05/25/08
D30001.0003 05/23/08
Notice: Boot Block is different. Check size of 1001.B10 is 720K.
See you soon 05/03 7:01
Press ESC To Return to Main Menu
```

- The utility starts to program the new BIOS information into the flash ROM. The boot block will be updated automatically only when necessary. This will minimize the chance of a failed updating. When the programming is finished, *Flashed Successfully* will be displayed.

```
Update BIOS Including Boot Block and ESCD
Flash Memory: Winbond W25Q08 or SST 25Q08 or Intel I25N08
BIOS Version
CURRENT 3 ASUS 300-00 ACPI BIOS Revision 100K
Flash.ame3 ASUS 300-00 ACPI BIOS Revision 100K
BIOS Model
CURRENT 3 300-00
Flash.ame3 300-00
Date of BIOS Build
CURRENT 3 05/25/08
D30001.0003 05/23/08
Notice: Boot Block is different. Check size of 1001.B10 is 720K.
See you soon 05/03 7:01
Block Erasing --- 8888
Programming --- 3FFF
Flashed Successfully
Press ESC To Continue
```

- Follow the onscreen instructions to continue.

```
ASUS ACPI BIOS
FLASH MEMORY WRITER V01.20
Copyright (C) 1996-05, AMISTEC COMPUTER INC.
Flash Memory: Winbond W25Q08 or SST 25Q08 or Intel I25N08
Current BIOS Version: ASUS 300-00 ACPI BIOS Revision 100K
BIOS Model : 300-00
BIOS Build Date : 05/25/08
Choose one of the following:
1. Save Current BIOS To File
2. Update BIOS Including Boot Block and ESCD
Enter choice: 1
You have flashed the EPROM. It is recommended that you turn off
the power, enter SETUP and LOAD Setup Defaults to have CMOS
updated with new BIOS when exits.
Press ESC To Exit
```

WARNING! If you encounter problems while updating the new BIOS, DO NOT turn off your system since this might prevent your system from booting up. Just repeat the process, and if the problem still persists, update the original BIOS file you saved to disk above. If the Flash Memory Writer utility was not able to successfully update a complete BIOS file, your system may not be able to boot up. If this happens, your system will need servicing.

4. BIOS SETUP

4.2 BIOS Setup Program

This motherboard supports a programmable BIOS that can be updated using the provided utility as described in *4.1 Managing and Updating Your BIOS*.

The utility is used if you are installing a motherboard, reconfiguring your system, or prompted to “**Run Setup**”. This section describes how to configure your system using this utility.

Even if you are not prompted to use the Setup program, at some time in the future you may want to change the configuration of your computer. For example, you may want to enable the Security Password Feature or make changes to the power management settings. It will then be necessary to reconfigure your system using the BIOS Setup program so that the computer can recognize these changes and record them in the CMOS RAM of the BIOS.

The BIOS on the motherboard stores the Setup utility. When you start up the computer, the system provides you with the opportunity to run this program. This appears during the Power-On Self Test (POST). Press <Delete> to call up the Setup utility. If you are a little bit late in pressing the mentioned key, POST will continue with its test routines, thus preventing you from calling up Setup. If you still need to call Setup, restart the system by pressing <Ctrl> + <Alt> + <Delete>, or by pressing the Reset button on the system chassis. You can also restart by turning the system off and then back on again. But do so only if the first two methods fail.

The Setup program has been designed to make it as easy to use as possible. It is a menu-driven program, which means you can scroll through the various sub-menus and make your selections among the predetermined choices.

To access the BIOS Setup program, press the <Delete> key after the computer has run through its POST.

NOTE: Because the BIOS software is constantly being updated, the following BIOS screens and descriptions are for reference purposes only and may not reflect your BIOS screens exactly.

4. BIOS SETUP

4.2.1 BIOS Menu Bar

The top of the screen has a menu bar with the following selections:

- MAIN** Use this menu to make changes to the basic system configuration.
- ADVANCED** Use this menu to enable and make changes to the advanced features.
- POWER** Use this menu to configure and enable Power Management features.
- BOOT** Use this menu to configure the default system device used to locate and load the Operating System.
- EXIT** Use this menu to exit the current menu or specify how to exit the Setup program.

To access the menu bar items, press the right or left arrow key on the keyboard until the desired item is highlighted.

4.2.2 Legend Bar

At the bottom of the Setup screen you will notice a legend bar. The keys in the legend bar allow you to navigate through the various setup menus. The following table lists the keys found in the legend bar with their corresponding alternates and functions.

| Navigation Key(s) | Function Description |
|--------------------------|--|
| <F1> or <Alt + H> | Displays the General Help screen from anywhere in the BIOS Setup |
| <Esc> | Jumps to the Exit menu or returns to the main menu from a sub-menu |
| ← or → (keypad arrow) | Selects the menu item to the left or right |
| ↑ or ↓ (keypad arrows) | Moves the highlight up or down between fields |
| - (minus key) | Scrolls backward through the values for the highlighted field |
| + (plus key) or spacebar | Scrolls forward through the values for the highlighted field |
| <Enter> | Brings up a selection menu for the highlighted field |
| <Home> or <PgUp> | Moves the cursor to the first field |
| <End> or <PgDn> | Moves the cursor to the last field |
| <F5> | Resets the current screen to its Setup Defaults |
| <F10> | Saves changes and exits Setup |

4. BIOS SETUP

General Help

In addition to the Item Specific Help window, the BIOS setup program also provides a General Help screen. This screen can be called up from any menu by simply pressing <F1> or the <Alt> + <H> combination. The General Help screen lists the legend keys with their corresponding alternates and functions.

Saving Changes and Exiting the Setup Program

See *4.8 Exit Menu* for detailed information on saving changes and exiting the setup program.

Scroll Bar

When a scroll bar appears to the right of a help window, it indicates that there is more information to be displayed that will not fit in the window. Use <PgUp> and <PgDn> or the up and down arrow keys to scroll through the entire help document. Press <Home> to display the first page, press <End> to go to the last page. To exit the help window, press <Enter> or <Esc>.

Sub-Menu

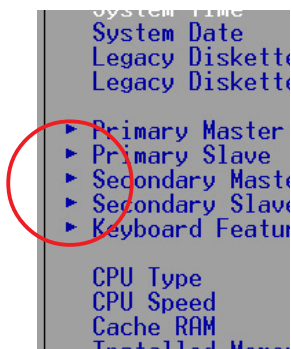

Note that a right pointer symbol (as shown in the left view) appears to the left of certain fields. This pointer indicates that a sub-menu can be launched from this field. A sub-menu contains additional options for a field parameter. To call up a sub-menu, simply move the highlight to the field and press <Enter>. The sub-menu will then immediately appear. Use the legend keys to enter values and move from field to field within a sub-menu just as you would within a menu. Use the <Esc> key to return to the main menu.

Take some time to familiarize yourself with each of the legend keys and their corresponding functions. Practice navigating through the various menus and sub-menus. If you accidentally make unwanted changes to any of the fields, use the set default hot key <F5>. While moving around through the Setup program, note that explanations appear in the Item Specific Help window located to the right of each menu. This window displays the help text for the currently highlighted field.

NOTE: The item heading in square brackets represents the default setting for that field.

4. BIOS SETUP

4.3 Main Menu

When the Setup program is accessed, the following screen appears:

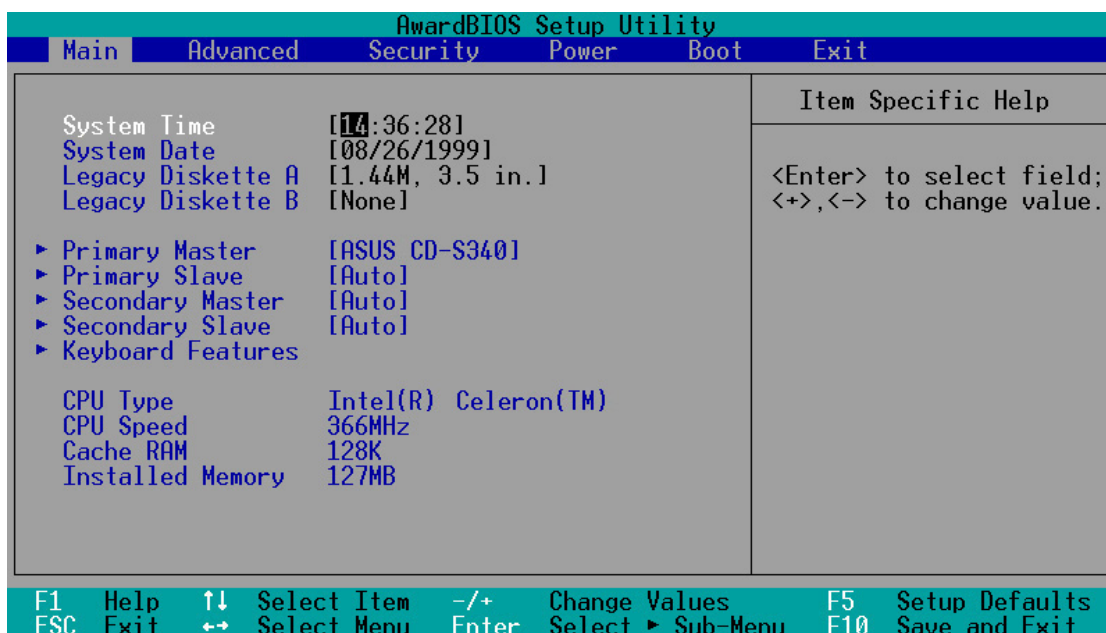

System Time [XX:XX:XX]

Sets your system to the time that you specify (usually the current time). The format is hour, minute, second. Valid values for hour, minute and second are **Hour: (00 to 23)**, **Minute: (00 to 59)**, **Second: (00 to 59)**. Use the <Tab> or <Shift> + <Tab> keys to move between the hour, minute, and second fields.

System Date [XX/XX/XXXX]

Sets your system to the date that you specify (usually the current date). The format is month, day, year. Valid values for month, day, and year are **Month: (1 to 12)**, **Day: (1 to 31)**, **Year: (100 year range)**. Use the <Tab> or <Shift> + <Tab> keys to move between the month, day, and year fields.

Legacy Diskette A [1.44M, 3.5 in.], Legacy Diskette B [None]

Sets the type of floppy drives installed. Configuration options: [None] [360K, 5.25 in.] [1.2M , 5.25 in.] [720K , 3.5 in.] [1.44M, 3.5 in.] [2.88M, 3.5 in.]

4. BIOS SETUP

4.3.1 Primary & Secondary Master/Slave

| AwardBIOS Setup Utility | | |
|--|------------|--|
| Main | | |
| Primary Master [Auto] | | Item Specific Help |
| Type | [Auto] | <Enter> to select the type of the IDE drive. [User Type HDD] allows you to set each entry on your own. |
| Cylinders | [1023] | |
| Head | [64] | |
| Sector | [63] | |
| CHS Capacity | 2111MB | |
| Maximum LBA Capacity | 2111MB | |
| Multi-Sector Transfers | [Maximum] | |
| SMART Monitoring | [Disabled] | |
| PIO Mode | [4] | |
| ULTRA DMA Mode | [2] | |
| F1 Help ↑↓ Select Item -/+ Change Values F5 Setup Defaults | | |
| ESC Exit ↔ Select Menu Enter Select ▶ Sub-Menu F10 Save and Exit | | |

NOTE: Before attempting to configure a hard disk drive, make sure you have the configuration information supplied by the manufacturer of the drive. Incorrect settings may cause your system to not recognize the installed hard disk. To allow the BIOS to detect the drive type automatically, select [Auto].

Type [Auto]

Select [Auto] to automatically detect an IDE hard disk drive. If automatic detection is successful, the correct values will be filled in for the remaining fields on this sub-menu. If automatic detection fails, your hard disk drive may be too old or too new. You can try updating your BIOS or enter the IDE hard disk drive parameters manually.

NOTE: After the IDE hard disk drive information has been entered into BIOS, new IDE hard disk drives must be partitioned (such as with FDISK) and then formatted before data can be read from and write on. Primary IDE hard disk drives must have its partition set to *active* (also possible with FDISK).

Other options for the **Type** field are:

[None] - to disable IDE devices

4. BIOS SETUP

IMPORTANT: If your hard disk was already formatted on an older previous system, incorrect parameters may be detected. You will need to enter the correct parameters manually or use low-level format if you do not need the data stored on the hard disk. If the parameters listed differ from the ones used when the disk was formatted, the disk will not be readable. If the auto-detected parameters do not match the ones that should be used for your disk, you should enter the correct ones manually by setting [User Type HDD].

[User Type HDD]

The screenshot shows the 'AwardBIOS Setup Utility' interface. The 'Main' menu is selected, and the 'Primary Master [User Type HDD]' option is highlighted. The configuration table is as follows:

| Primary Master [User Type HDD] | | Item Specific Help |
|--------------------------------|-----------------|--|
| Type | [User Type HDD] | <Enter> to select the type of the IDE drive. [User Type HDD] allows you to set each entry on your own. |
| Translation Method | [LBA] | |
| Cylinders | [1023] | |
| Head | [64] | |
| Sector | [63] | |
| CHS Capacity | 2111MB | |
| Maximum LBA Capacity | 2111MB | |
| Multi-Sector Transfers | [Maximum] | |
| SMART Monitoring | [Disabled] | |
| PIO Mode | [4] | |
| ULTRA DMA Mode | [2] | |

At the bottom, a legend lists the following function keys: F1 Help (up/down arrows), ESC Exit (left/right arrows), Select Item (dash/underscore), Select Menu (Enter), Change Values (dash/underscore), Select Sub-Menu (right arrow), F5 Setup Defaults, and F10 Save and Exit.

Manually enter the number of cylinders, heads and sectors per track for your drive. Refer to your drive documentation or look on the drive for this information. If no drive is installed or if you are removing a drive and not replacing it, select [None].

Translation Method [LBA]

Select the hard disk drive type in this field. When Logical Block Addressing is enabled, 28-bit addressing of the hard drive is used without regard for cylinders, heads, or sectors. Note that Logical Block Access may decrease the access speed of the hard disk. However, LBA Mode is necessary for drives with greater than 504MB in storage capacity. Configuration options: [LBA] [LARGE] [Normal] [Match Partition Table] [Manual]

Cylinders

This field configures the number of cylinders. Refer to your drive documentation to determine the correct value to enter into this field. **NOTE:** To make changes to this field, the **Type** field must be set to [User Type HDD] and the **Translation Method** field must be set to [Manual].

4. BIOS SETUP

Head

This field configures the number of read/write heads. Refer to your drive documentation to determine the correct value to enter into this field. **NOTE:** To make changes to this field, the **Type** field must be set to [User Type HDD] and the **Translation Method** field must be set to [Manual].

Sector

This field configures the number of sectors per track. Refer to your drive documentation to determine the correct value to enter into this field. **NOTE:** To make changes to this field, the **Type** field must be set to [User Type HDD] and the **Translation Method** field must be set to [Manual].

CHS Capacity

This field shows the drive's maximum CHS capacity calculated automatically by the BIOS from the drive information you entered.

Maximum LBA Capacity

This field shows the drive's maximum LBA capacity calculated automatically by the BIOS from the drive information you entered.

Multi-Sector Transfers [Maximum]

This option automatically sets the number of sectors per block to the highest number supported by the drive. This field can also be configured manually. Note that when this field is automatically configured, the set value may not always be the fastest value for the drive. Refer to the documentation that came with your hard drive to determine the optimal value and set it manually. **NOTE:** To make changes to this field, the **Type** field must be set to [User Type HDD]. Configuration options: [Disabled] [2 Sectors] [4 Sectors] [8 Sectors] [16 Sectors] [32 Sectors] [Maximum]

SMART Monitoring [Disabled]

This allows the enabling or disabling of the S.M.A.R.T. (Self-Monitoring, Analysis and Reporting Technology) system which utilizes internal hard disk drive monitoring technology. This feature is normally disabled because system resources used in this feature may decrease system performance. Configuration options: [Disabled] [Enabled]

PIO Mode [4]

This option lets you set a PIO (Programmed Input/Output) mode for the IDE device. Modes 0 through 4 provide successively increased performance. Configuration options: [0] [1] [2] [3] [4]

Ultra DMA Mode [Disabled]

Ultra DMA capability allows improved transfer speeds and data integrity for compatible IDE devices. Set to [Disabled] to suppress Ultra DMA capability. **NOTE:** To make changes to this field, the **Type** field must be set to [User Type HDD]. Configuration options: [0] [1] [2] [3] [4] [Disabled]

4. BIOS SETUP

Other options for “Type:” are:

[CD-ROM] - for IDE CD-ROM drives

[LS-120] - for LS-120 compatible floppy disk drives

[ZIP-100] - for ZIP-100 compatible disk drives

[MO] - for IDE magneto optical disk drives

[Other ATAPI Device] - for IDE devices not listed here

After using the legend keys to make your selections on this sub-menu, press the <Esc> key to exit back to the Main menu. When the Main menu appears, you will notice that the drive size appear in the field for the hard disk drive that you just configured.

4.3.2 Keyboard Features

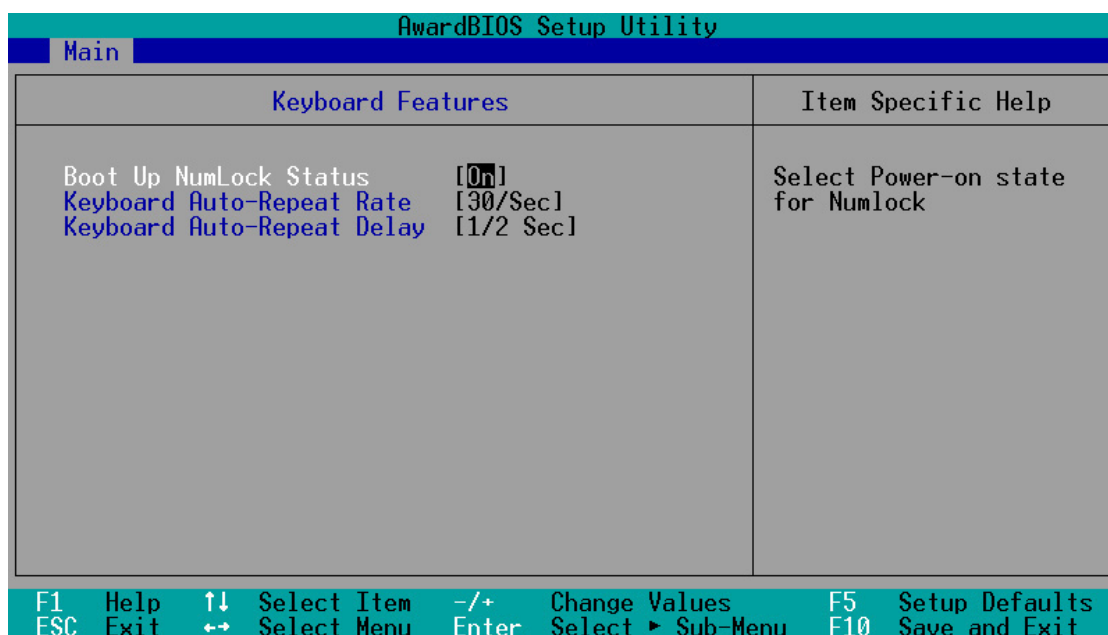

Boot Up NumLock Status [On]

This field controls the state of the NumLock key when the system boots. When switched on, the numeric keypad generates numbers instead of controlling cursor operations. Configuration options: [Off] [On]

4. BIOS SETUP

Keyboard Auto-Repeat Rate [30/Sec]

This field controls the speed at which the system registers repeated keystrokes. Configuration options: [6/Sec] [8/Sec] [10/Sec] [12/Sec] [15/Sec] [20/Sec] [24/Sec] [30/Sec]

Keyboard Auto-Repeat Delay [1/2 Sec]

This field sets the delay before keystrokes begin to repeat. Configuration options: [1/4 Sec] [1/2 Sec] [3/4 Sec] [1 Sec]

CPU Type, CPU Speed, Cache RAM, Installed Memory

These fields display the CPU and memory information detected by the system during bootup. You do not need to make changes to these fields. These are display only fields.

4. BIOS SETUP

4.4 Advanced Menu

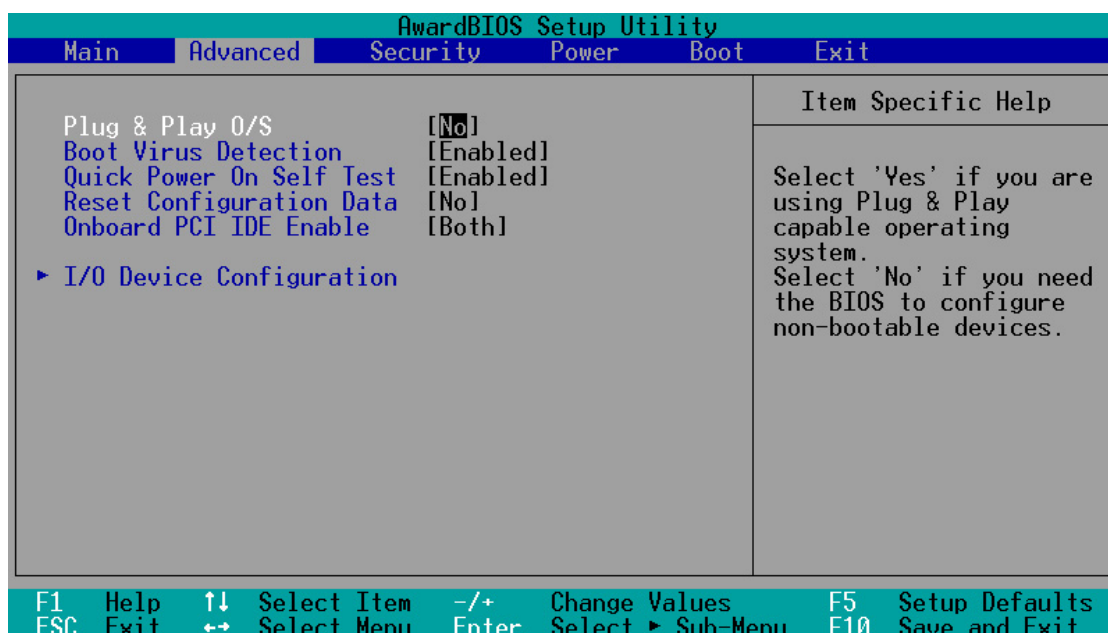

Plug & Play O/S [No]

This field allows you to use a Plug-and-Play (PnP) operating system to configure the PCI bus slots instead of using the BIOS. When [Yes] is selected, interrupts may be reassigned by the OS. When a non-PnP OS is installed or you want to prevent reassigning of interrupt settings, select the default setting of [No]. Configuration options: [No] [Yes]

Boot Virus Detection [Enabled]

This field allows you to set boot virus detection, ensuring a virus-free boot sector. This new antivirus solution is unlike native BIOS tools, which offer limited virus protection typically by write-protecting the partition table. With this new solution, your computer is protected against boot virus threats earlier in the boot cycle, that is, before they have a chance to load into your system. This ensures your computer boots to a clean operating system. The system halts and displays a warning message when it detects a virus. If this occurs, you can either allow the operation to continue or use a virus-free bootable floppy disk to restart and investigate your system. Because of conflicts with new operating systems, for example, during installation of new software, you may have to set this to [Disabled] to prevent write errors. Configuration options: [Disabled] [Enabled]

Quick Power On Self Test [Enabled]

This field speeds up the Power-On Self Test (POST) routine by skipping retesting a second, and third time. A complete test of the system memory can be done on the first test. Configuration options: [Disabled] [Enabled]

4. BIOS SETUP

Reset Configuration Data [No]

The Extended System Configuration Data (ESCD) contains information about non-PnP devices and holds the complete record of how the system was configured the last time it was booted. Set this field to [Yes] only when you want to clear the ESCD. Configuration options: [No] [Yes]

Onboard PCI IDE Enable [Both]

You can select to enable the primary IDE channel, secondary IDE channel, both, or disable both channels (for systems with only SCSI drives). Configuration options: [Both] [Primary] [Secondary] [Disabled]

4.4.1 I/O Device Configuration

| AwardBIOS Setup Utility | |
|---------------------------|--|
| Advanced | |
| I/O Device Configuration | Item Specific Help |
| Serial Port A [3F8H/IRQ4] | Configure serial port A using options: [Disabled] No Configuration [xxx/IRQx] User Configuration |
| Serial Port B [2F8H/IRQ3] | |
| Parallel Port [378H/IRQ7] | |
| Mode [EPP1.9+SPP] | |

F1 Help ↑↓ Select Item -/+ Change Values F5 Setup Defaults
ESC Exit ←→ Select Menu Enter Select ► Sub-Menu F10 Save and Exit

Serial Port A [3F8H/IRQ4], Serial Port B [2F8H/IRQ3]

These fields allow you to set the addresses for the onboard serial connectors. Serial Port A and Serial Port B must have different addresses. Configuration options: [3F8H/IRQ4] [2F8H/IRQ3] [3E8H/IRQ4] [2E8H/IRQ3] [Disabled]

Parallel Port [378H/IRQ7]

This field sets the address of the onboard parallel port connector. If you disable this field, **Parallel Port Mode** configuration will not be available. Configuration options: [Disabled] [378H/IRQ7] [278H/IRQ5]

Parallel Port Mode [EPP1.9+SPP]

This field allows you to set the operation mode of the parallel port. Configuration options: [SPP] [EPP1.9+SPP] [ECP] [ECP+EPP1.9] [Mono-directional] [EPP1.7+SPP] [ECP+EPP1.7]

4. BIOS SETUP
I/O Device Config.

4. BIOS SETUP

4.5 Security Menu

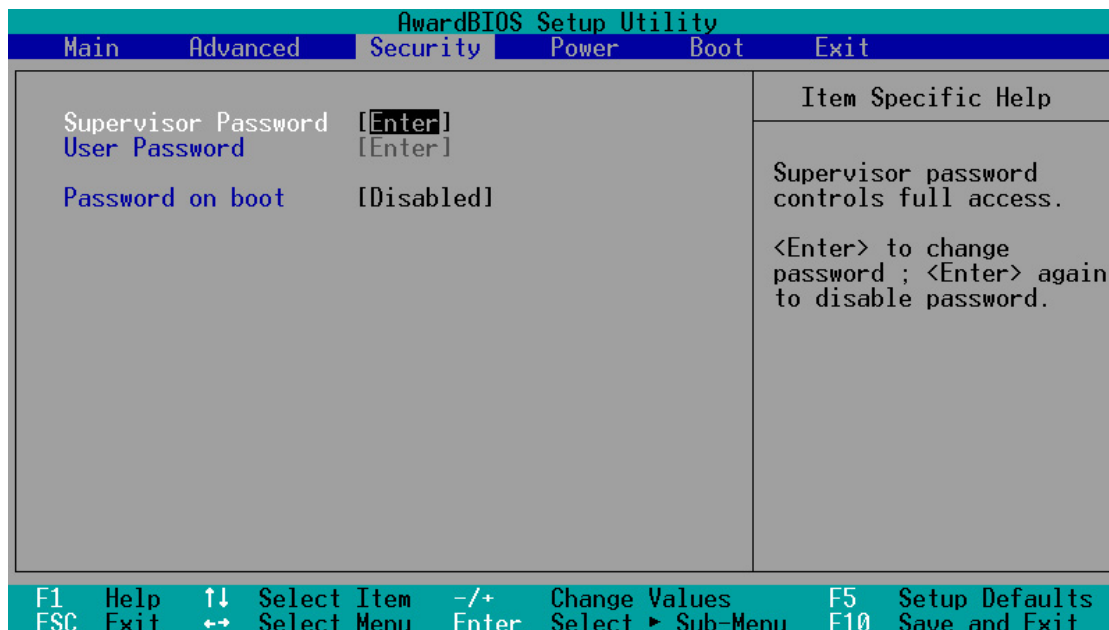

Supervisor Password, User Password

The BIOS Setup program allows you to specify two separate passwords: a Supervisor password and a User password. The passwords control access to the BIOS during system startup. When enabled, the Supervisor password is required for entering the BIOS Setup program and having full access to all Security menu options.

To set the password, highlight the appropriate field and press <Enter>. Type in a password and press <Enter>. You can type up to eight alphanumeric characters. Symbols and other keys are ignored. To confirm the password, type the password again and press the <Enter>.

To clear the password, highlight this field and press <Enter>. The same dialog box as above will appear. Press <Enter> and the password will be disabled.

4. BIOS SETUP

Forgot the password?

If you forgot the password, you can clear the password by erasing the CMOS Real Time Clock (RTC) RAM. The RAM data containing the password information is powered by the onboard button cell battery. To erase the RTC RAM: (1) Unplug your computer, (2) Short the solder points, (3) Turn ON your computer, (4) Hold down <Delete> during bootup and enter BIOS setup to re-enter user preferences.

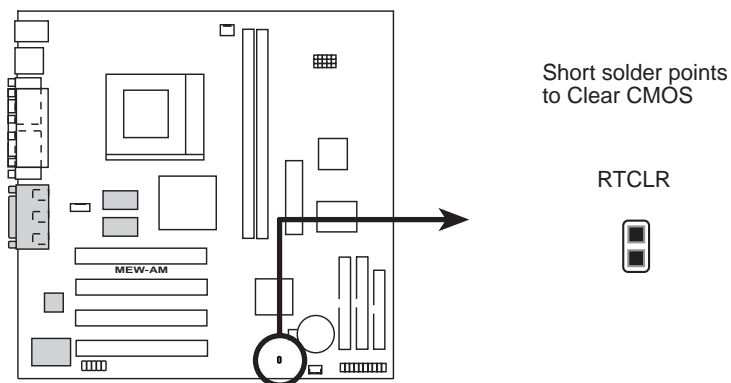

MEW-AM Clear RTC RAM

4. BIOS SETUP

4.6 Power Menu

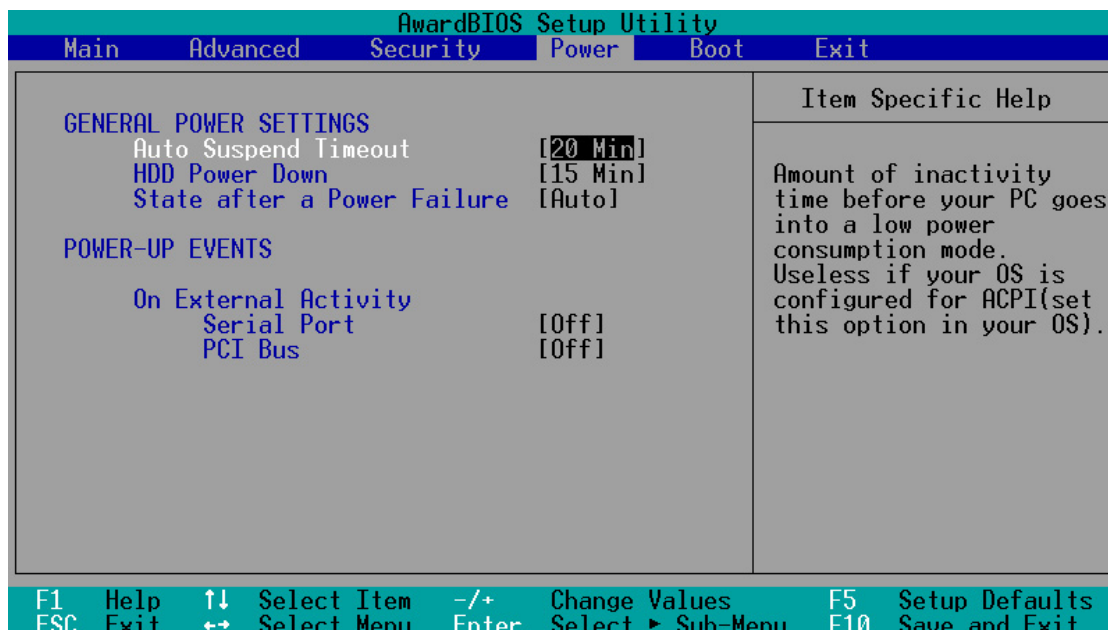

General Power Settings

Auto Suspend Timeout [20 Min]

This field sets the time period of inactivity before the system goes into suspend mode. Configuration options: [Off] [1~2 Min] [2~3 Min]...[1 Hour]

HDD Power Down [15 Min]

This field shuts down any IDE hard disk drives in the system after a period of inactivity as set in this user-configurable field. This feature does not affect SCSI hard drives. Configuration options: [Disabled] [1 Min] [2 Min] ...[15 Min]

State after a Power Failure [Auto]

This allows you to set whether you want your system to reboot after the power has been interrupted. [Off] leaves your system off and [On] reboots your system. [Auto] returns your computer back to the state it was in before the power failure. Configuration options: [Off] [Auto] [On]

Power-Up Events

On External Activity

Serial Port [Off]

This feature allows your computer to be powered up from Soft-off mode when the device connecting to the serial port (such as an external modem) receives a call. Configuration options: [Off] [On]

PCI Bus [Off]

This feature allows your computer to be powered up from Soft-off mode when a PCI device (such as a modem or network card) receives a call. Configuration options: [Off] [On]

4. BIOS SETUP

4.7 Boot Menu

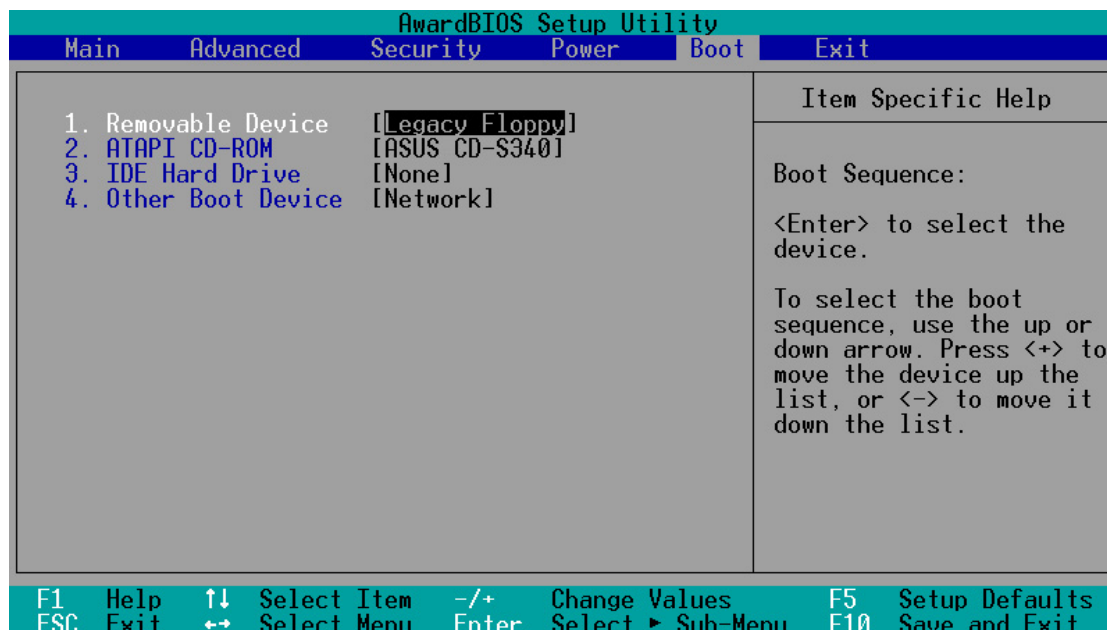

Boot Sequence

The Boot menu allows you to select among the four possible types of boot devices listed using the up and down arrow keys. By using the <+> or <Space> key, you can promote devices and by using the <-> key, you can demote devices. Promotion or demotion of devices alters the priority which the system uses to search for a boot device on system power up. Configuration options: [Removable Devices] [ATAPI CD-ROM] [IDE Hard Drive] [Other Boot Device]

Removable Device [Legacy Floppy]

Configuration options: [Disabled] [Legacy Floppy] [LS120] [ZIP-100] [ATAPI MO]

ATAPI CD-ROM

This field allows you to select which ATAPI CD-ROM drive to use in the boot sequence. Pressing [Enter] will show the product IDs of all your connected ATAPI CD-ROM drives.

IDE Hard Drive

This field allows you to select which IDE hard disk drive to use in the boot sequence. Pressing [Enter] will show the product IDs of all connected IDE hard disk drives.

Other Boot Device Select [Network]

Configuration options: [Disabled] [Network] [SCSI Boot Device]

4. BIOS SETUP

4.8 Exit Menu

Once you have made all of your selections from the various menus in the Setup program, you should save your changes and exit Setup. Select **Exit** from the menu bar to display the following menu:

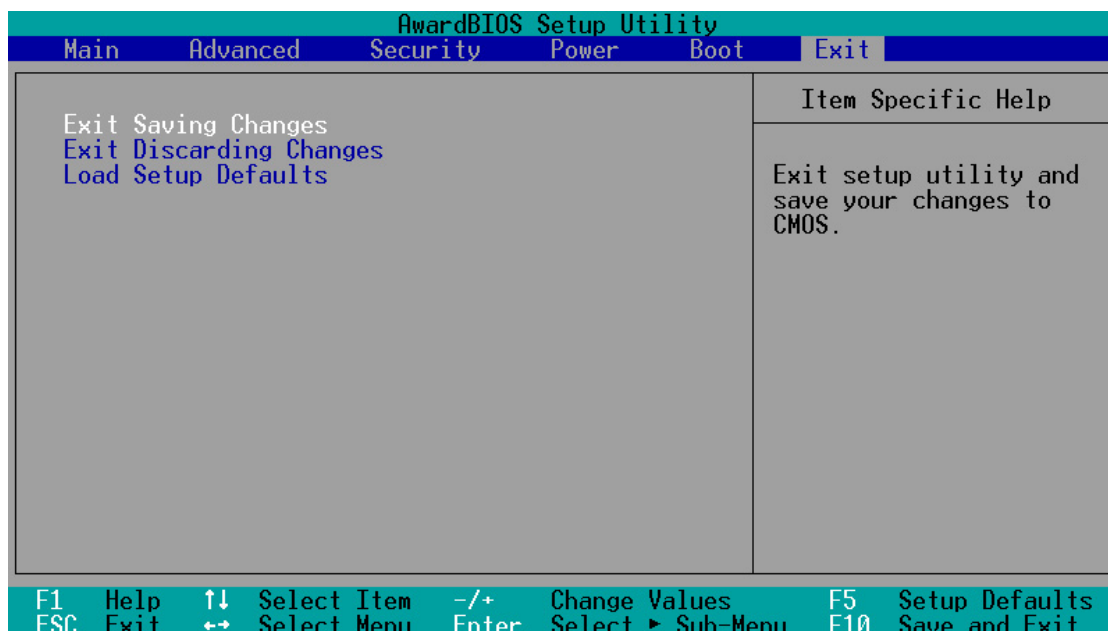

NOTE: Pressing <Esc> does not exit this menu. You must select one of the options from this menu or <F10> from the legend bar to exit this menu.

Exit Saving Changes

Once you are finished making your selections, choose this option from the Exit menu to ensure the values you selected are saved to the CMOS RAM. The CMOS RAM is sustained by an onboard backup battery and stays on even when the PC is turned off. Once this option is selected, a confirmation is asked. Select [Yes] to save changes and exit.

NOTE: If you attempt to exit the Setup program without saving your changes, the program will prompt you with a message asking if you want to save your changes before exiting. Pressing <Enter> will then save changes while exiting.

Exit Discarding Changes

This option should only be used if you do not want to save the changes you have made to the Setup program. If you have made changes to fields other than system date, system time, and password, the system will ask for confirmation before exiting.

Load Setup Defaults

This option allows you to load the default values for each of the parameters on the Setup menus. When this option is selected or if <F5> is pressed, a confirmation is requested. Select [Yes] to load default values. You can now select **Exit Saving Changes** or make other changes before saving the values to the non-volatile RAM.

Free Manuals Download Website

<http://myh66.com>

<http://usermanuals.us>

<http://www.somanuals.com>

<http://www.4manuals.cc>

<http://www.manual-lib.com>

<http://www.404manual.com>

<http://www.luxmanual.com>

<http://aubethermostatmanual.com>

Golf course search by state

<http://golfingnear.com>

Email search by domain

<http://emailbydomain.com>

Auto manuals search

<http://auto.somanuals.com>

TV manuals search

<http://tv.somanuals.com>