

# ASUS<sup>®</sup>

## V-Series M2V890

*ASUS PC (Desktop Barebone)*

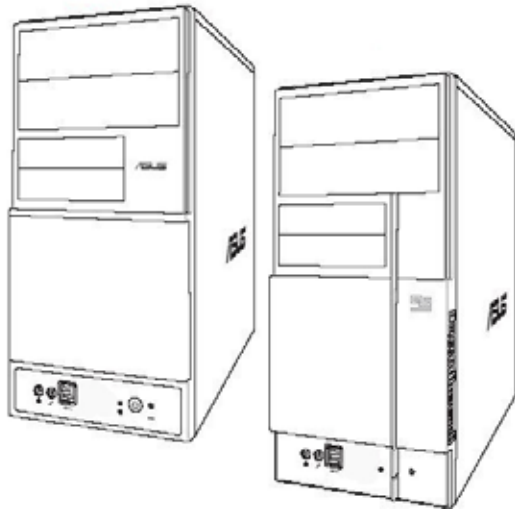

E2747

First Edition V1  
September 2006

**Copyright © 2006 ASUSTeK COMPUTER INC. All Rights Reserved.**

No part of this manual, including the products and software described in it, may be reproduced, transmitted, transcribed, stored in a retrieval system, or translated into any language in any form or by any means, except documentation kept by the purchaser for backup purposes, without the express written permission of ASUSTeK COMPUTER INC. ("ASUS").

Product warranty or service will not be extended if: (1) the product is repaired, modified or altered, unless such repair, modification or alteration is authorized in writing by ASUS; or (2) the serial number of the product is defaced or missing.

ASUS PROVIDES THIS MANUAL "AS IS" WITHOUT WARRANTY OF ANY KIND, EITHER EXPRESS OR IMPLIED, INCLUDING BUT NOT LIMITED TO THE IMPLIED WARRANTIES OR CONDITIONS OF MERCHANTABILITY OR FITNESS FOR A PARTICULAR PURPOSE. IN NO EVENT SHALL ASUS, ITS DIRECTORS, OFFICERS, EMPLOYEES OR AGENTS BE LIABLE FOR ANY INDIRECT, SPECIAL, INCIDENTAL, OR CONSEQUENTIAL DAMAGES (INCLUDING DAMAGES FOR LOSS OF PROFITS, LOSS OF BUSINESS, LOSS OF USE OR DATA, INTERRUPTION OF BUSINESS AND THE LIKE), EVEN IF ASUS HAS BEEN ADVISED OF THE POSSIBILITY OF SUCH DAMAGES ARISING FROM ANY DEFECT OR ERROR IN THIS MANUAL OR PRODUCT.

SPECIFICATIONS AND INFORMATION CONTAINED IN THIS MANUAL ARE FURNISHED FOR INFORMATIONAL USE ONLY, AND ARE SUBJECT TO CHANGE AT ANY TIME WITHOUT NOTICE, AND SHOULD NOT BE CONSTRUED AS A COMMITMENT BY ASUS. ASUS ASSUMES NO RESPONSIBILITY OR LIABILITY FOR ANY ERRORS OR INACCURACIES THAT MAY APPEAR IN THIS MANUAL, INCLUDING THE PRODUCTS AND SOFTWARE DESCRIBED IN IT.

Products and corporate names appearing in this manual may or may not be registered trademarks or copyrights of their respective companies, and are used only for identification or explanation and to the owners' benefit, without intent to infringe.

# Table of contents

Notices .....	vi
Safety information .....	vii
About this guide.....	viii
System package contents.....	x

## Chapter 1: System Introduction

1.1 Welcome! .....	1-2
1.2 Front panel .....	1-2
1.3 Rear panel.....	1-4
1.4 Internal components.....	1-7

## Chapter 2: Basic Installation

2.1 Preparation .....	2-2
2.2 Before you proceed .....	2-2
2.3 Removing the side cover and front panel assembly .....	2-3
2.4 Central Processing Unit (CPU) .....	2-4
2.4.1 Overview .....	2-4
2.4.2 Installing CPU .....	2-4
2.4.3 Installing the heatsink and fan .....	2-6
2.5 Installing a DIMM .....	2-8
2.5.1 Memory configurations .....	2-8
2.5.2 Installing a DDR2 DIMM .....	2-10
2.5.3 Removing a DDR2 DIMM.....	2-10
2.6 Expansion slots .....	2-11
2.6.1 Installing an expansion card .....	2-11
2.6.2 Configuring an expansion card .....	2-11
2.6.3 PCI Express x 1 slot .....	2-13
2.6.4 PCI slots .....	2-13
2.6.5 PCI Express x 16 slot .....	2-13
2.7 Installing an optical drive .....	2-14
2.8 Installing a hard disk drive .....	2-15
2.9 Installing a floppy disk drive.....	2-18
2.10 Removing the bay covers and reinstalling the front panel assembly and side cover.....	2-19

# Table of contents

## Chapter 3: Starting up

3.1	Installing an operating system.....	3-2
3.2	Powering up .....	3-2
3.3	Support CD information .....	3-3
3.3.1	Running the support CD.....	3-3
3.3.2	Drivers menu.....	3-4
3.3.3	Utilities Disk .....	3-5
3.3.4	Make Disk menu .....	3-6
3.3.5	ASUS Contact information .....	3-7

## Chapter 4: Motherboard Information

4.1	Introduction .....	4-2
4.2	Motherboard layout .....	4-2
4.3	Jumpers .....	4-3
4.4	Connectors .....	4-4

## Chapter 5: BIOS Setup

5.1	Managing and updating your BIOS .....	5-2
5.1.1	Creating a bootable floppy disk .....	5-2
5.1.2	ASUS EZ Flash utility.....	5-3
5.1.3	AFUDOS utility .....	5-4
5.1.4	ASUS Update utility .....	5-6
5.2	BIOS setup program.....	5-9
5.2.1	BIOS menu screen.....	5-10
5.2.2	Menu bar .....	5-10
5.2.3	Navigation keys.....	5-10
5.2.4	Menu items .....	5-11
5.2.5	Sub-menu items.....	5-11
5.2.6	Configuration fields.....	5-11
5.2.7	Pop-up window.....	5-11
5.2.8	Scroll bar.....	5-13
5.2.9	General help .....	5-11

# Table of contents

5.3	Main menu.....	5-12
5.3.1	System Time .....	5-12
5.3.2	System Date .....	5-12
5.3.3	Legacy Diskette A .....	5-12
5.3.4	Primary and Secondary IDE Master/Slave .....	5-13
5.3.5	System Information.....	5-14
5.4	Advanced menu .....	5-15
5.4.1	USB configuration .....	5-15
5.4.2	CPU Configuration .....	5-16
5.4.3	Chipset.....	5-17
5.4.4	SouthBridge VIA VT8237A Configuration.....	5-21
5.4.5	PCI PnP .....	5-22
5.5	Power menu .....	5-24
5.5.1	Suspend Mode .....	5-24
5.5.2	ACPI 2.0 Support .....	5-24
5.5.3	ACPI APIC Support .....	5-24
5.5.4	APM Configuration .....	5-24
5.5.5	Hardware monitor .....	5-26
5.6	Boot menu .....	5-27
5.6.1	Boot Device Priority .....	5-27
5.6.2	Boot Settings Configuration .....	5-28
5.6.3	Security.....	5-29
5.7	Exit menu.....	5-31

# Notices

## Federal Communications Commission Statement

This device complies with Part 15 of the FCC Rules. Operation is subject to the following two conditions:

- This device may not cause harmful interference, and
- This device must accept any interference received including interference that may cause undesired operation.

This equipment has been tested and found to comply with the limits for a Class B digital device, pursuant to Part 15 of the FCC Rules. These limits are designed to provide reasonable protection against harmful interference in a residential installation. This equipment generates, uses and can radiate radio frequency energy and, if not installed and used in accordance with manufacturer's instructions, may cause harmful interference to radio communications. However, there is no guarantee that interference will not occur in a particular installation. If this equipment does cause harmful interference to radio or television reception, which can be determined by turning the equipment off and on, the user is encouraged to try to correct the interference by one or more of the following measures:

- Reorient or relocate the receiving antenna.
- Increase the separation between the equipment and receiver.
- Connect the equipment to an outlet on a circuit different from that to which the receiver is connected.



---

**WARNING!** The use of shielded cables for connection of the monitor to the graphics card is required to assure compliance with FCC regulations. Changes or modifications to this unit not expressly approved by the party responsible for compliance could void the user's authority to operate this equipment.

---

## Canadian Department of Communications Statement

This digital apparatus does not exceed the Class B limits for radio noise emissions from digital apparatus set out in the Radio Interference Regulations of the Canadian Department of Communications.

**This class B digital apparatus complies with Canadian ICES-003.**

# Safety information

## Electrical safety

- To prevent electrical shock hazard, disconnect the power cable from the electrical outlet before relocating the system.
- When adding or removing devices to or from the system, ensure that the power cables for the devices are unplugged before the signal cables are connected.
- If the power supply is broken, do not try to fix it by yourself. Contact a qualified service technician or your retailer.

## Operation safety

- Before installing devices into the system, carefully read all the documentation that came with the package.
- Before using the product, make sure all cables are correctly connected and the power cables are not damaged. If you detect any damage, contact your dealer immediately.
- To avoid short circuits, keep paper clips, screws, and staples away from connectors, slots, sockets and circuitry.
- Avoid dust, humidity, and temperature extremes. Do not place the product in any area where it may become wet. Place the product on a stable surface.
- If you encounter technical problems with the product, contact a qualified service technician or your retailer.

### *Lithium-Ion Battery Warning*

**CAUTION:** Danger of explosion if battery is incorrectly replaced. Replace only with the same or equivalent type recommended by the manufacturer. Dispose of used batteries according to the manufacturer's instructions.

**VORSICHT:** Explosionsgefahr bei unsachgemäßen Austausch der Batterie. Ersatz nur durch denselben oder einem vom Hersteller empfohlenem ähnlichen Typ. Entsorgung gebrauchter Batterien nach Angaben des Herstellers.

### *LASER PRODUCT WARNING*

**CLASS 1 LASER PRODUCT**

# About this guide

## Audience

This guide provides general information and installation instructions about the ASUS V-Series M2V890 barebone system. This guide is intended for experienced users and integrators with hardware knowledge of personal computers.

## How this guide is organized

This guide contains the following parts:

### 1. Chapter 1: System introduction

This chapter gives a general description of the ASUS V-Series M2V890 barebone system. The chapter lists the system features, including introduction on the front and rear panel, and internal components.

### 2. Chapter 2: Basic installation

This chapter provides step-by-step instructions on how to install components in the system.

### 3. Chapter 3: Starting up

This chapter helps you power up the system and install drivers and utilities from the support CD.

### 4. Chapter 4: Motherboard information

This chapter gives information about the motherboard that comes with the system. This chapter includes the motherboard layout, jumper settings, and connector locations.

### 5. Chapter 5: BIOS setup

This chapter tells how to change system settings through the BIOS Setup menus and describes the BIOS parameters.



## Conventions used in this guide



**WARNING:** Information to prevent injury to yourself when trying to complete a task.



**CAUTION:** Information to prevent damage to the components when trying to complete a task.



**IMPORTANT:** Instructions that you **MUST** follow to complete a task.



**NOTE:** Tips and additional information to aid in completing a task.

## Where to find more information

Refer to the following sources for additional information and for product and software updates.

### 1. **ASUS Websites**

The ASUS websites worldwide provide updated information on ASUS hardware and software products. Refer to the ASUS contact information.

### 2. **Optional Documentation**

Your product package may include optional documentation, such as warranty flyers, that may have been added by your dealer. These documents are not part of the standard package.

# System package contents

Check your ASUS V-Series M2V890 barebone system package for the following items.



---

If any of the items is damaged or missing, contact your retailer immediately.

---

Item description
<b>1. ASUS V-Series M2V890 barebone system</b> with
<ul style="list-style-type: none"><li>ASUS motherboard</li><li>250 W PFC power supply unit</li><li>ASUS chassis</li></ul>
<b>2. Cable</b>
<ul style="list-style-type: none"><li>AC power cable</li></ul>
<b>3. Support CD</b>
<b>4. User guide</b>

# Chapter 1

This chapter gives a general description of the ASUS V-Series M2V890 Barebone System. The chapter lists the system features including introduction on the front and rear panel, and internal components.

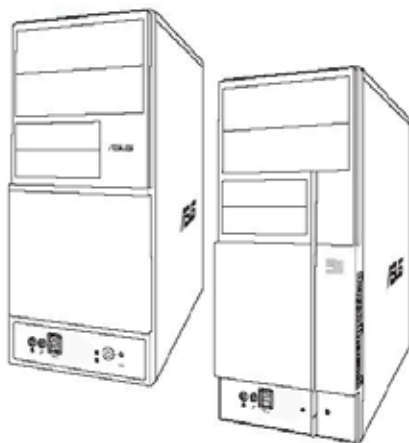

# System introduction

# 1.1 Welcome!

Thank you for choosing the ASUS V-Series M2V890!

The ASUS V-Series M2V890 is an all-in-one barebone system with a versatile home entertainment feature.

The system comes in a stylish mini-tower casing and powered by the ASUS motherboard that supports the AMD Athlon™ 64 X2/AMD Athlon™ 64/AMD Sempron™ processor in a 940-pin AM2 socket.

The system supports up to 2 GB of system memory using DDR2-667/533 DIMMs. VIA integrated graphics, Serial ATA, USB 2.0, and 8-channel audio feature the system and take you ahead in the world of power computing.

# 1.2 Front panel

The front panel includes the optical drive bays, floppy disk drive slot, power button, and several I/O ports are located at the front panel.

- 1. 5.25-inch drive bay cover
- 2. 3.5-inch drive bay cover
- 3. Headphone port
- 4. Microphone port
- 5. USB 2.0 ports\*
- 6. HDD LED
- 7. Power button
- 8. Reset button

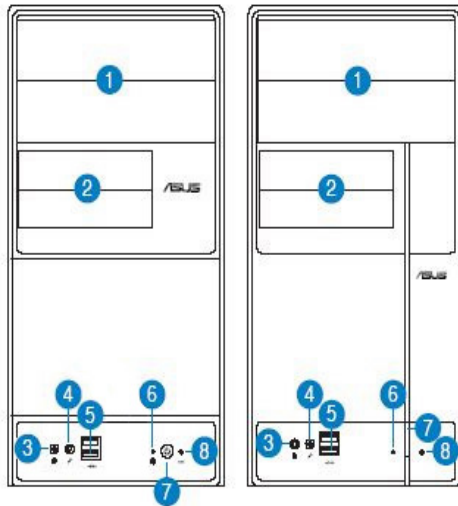

1. **5.25-inch drive bay covers.** These bays are for IDE optical drives.
2. **3.5-inch drive bay covers.** These slots are for 3.5-inch floppy or hard disk drives.
3. **Headphone port.** This Line In (green) port connects a headphone with a stereo mini-plug.
4. **Microphone port.** This Mic (pink) port connects a microphone.
5. **USB 2.0 ports.** These Universal Serial Bus 2.0 (USB 2.0) ports are available for connecting USB 2.0 devices such as a mouse, printer, scanner, camera, PDA, and others.
6. **HDD LED.** This LED lights up when data is read from or written to the hard disk drive.
7. **Power button.** Press this button to turn the system on.
8. **Reset button.** Press this button to reboot the system without turning off the power.

## 1.3 Rear panel

The system rear panel includes the power connector and several I/O ports that allow convenient connection of devices.

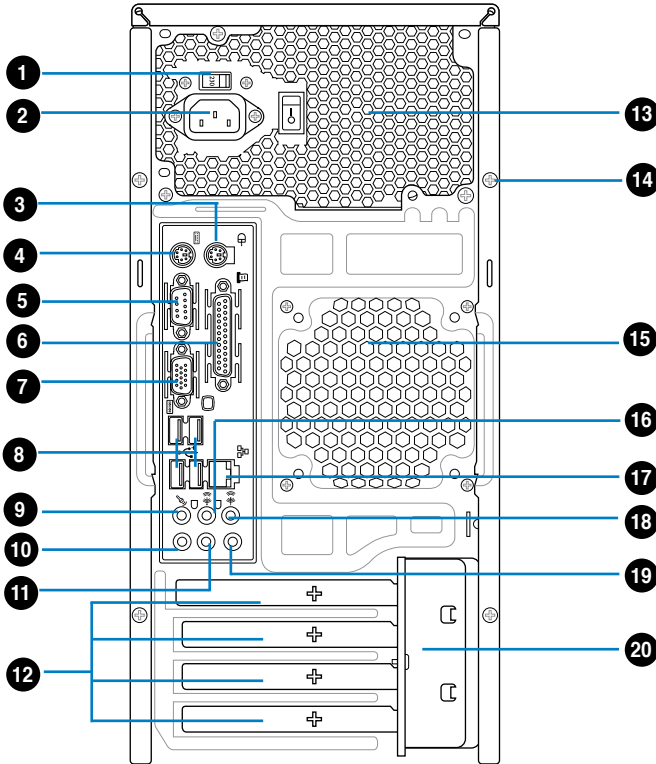

1. **Voltage selector.** This switch allows you to adjust the system input voltage according to the voltage supply in your area. See the section “Voltage selector” on page 1-6 before adjusting this switch.
2. **Power connector.** This connector is for the power cable and plug.
3. **PS/2 mouse port.** This port is for a PS/2 mouse.
4. **PS/2 keyboard port.** This port is for a PS/2 keyboard.

5. **COM port.** This 15-pin port is for a VGA monitor or other VGA-compatible devices.
6. **Parallel port.** This 25-pin port connects a parallel printer, a scanner, or other devices.
7. **Video Graphics Adapter (VGA) port.** This port is for a VGA monitor or other VGA-compatible devices.
8. **USB 2.0 ports.** These 4-pin Universal Serial Bus (USB) ports are available for connecting USB 2.0 devices.
9. **Side Speaker Out port (gray).** This port connects the side speakers in an 8-channel audio configuration.
10. **Microphone port (pink).** This port connects a microphone.
11. **Line Out port (lime).** This port connects a headphone or a speaker. In 4-channel and 6-channel configuration, the function of this port becomes Front Speaker Out.
12. **Expansion slot metal brackets.** Remove these brackets when installing expansion cards.
13. **Power supply unit fan vent.** This vent is for the PSU fan that provides ventilation inside the power supply unit.
14. **Cover screw.** Remove the cover screws on the rear panel when installing expansion cards.
15. **Chassis fan vent.** This vent is for the fan that provides ventilation inside the system chassis.
16. **Rear Speaker Out port (black).** This port connects the rear speakers in a 4-channel, 6-channel, or 8-channel audio configuration.
17. **LAN (RJ-45) port.** Supported by Realtek® Gigabit LAN controller, this port allows Gigabit connection to a Local Area Network (LAN) through a network hub. Refer to the table below for the LAN port LED indications.
18. **Center/Subwoofer port (orange).** This port connects the center/subwoofer speakers.
19. **Line In port (light blue).** This port connects the tape, CD, DVD player, or other audio sources.
20. **Metal bracket lock.** Remove the metal bracket lock on the rear panel when installing expansion cards.



Refer to the audio configuration table below for the function of the audio ports in 2, 4, 6, or 8-channel configuration.

## Audio 2, 4, 6, or 8-channel configuration

Port	Headset 2-channel	4-channel	6-channel	8-channel
Light Blue	Line In	Line In	Line In	Line In
Lime	Line Out	Front Speaker Out	Front Speaker Out	Front Speaker Out
Pink	Mic In	Mic In	Mic In	Mic In
Orange	–	–	Center/Subwoofer	Center/Subwoofer
Black	–	Rear Speaker Out	Rear Speaker Out	Rear Speaker Out
Gray	–	–	–	Side Speaker Out

## Voltage selector

The system's power supply unit has a 115 V/230 V voltage selector switch located beside the power connector. Use this switch to select the appropriate system input voltage according to the voltage supply in your area.

If the voltage supply in your area is 100-127 V, set this switch to 115 V.

If the voltage supply in your area is 200-240 V, set this switch to 230 V.

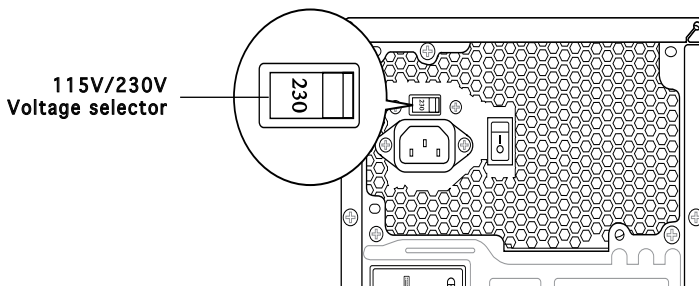

Setting the switch to 115V in a 230V environment or 230V in a 115V environment will seriously damage the system!



## 1.4 Internal components

The illustration below is the internal view of the system when you remove the top cover and the power supply unit. The installed components are labeled for your reference. Proceed to Chapter 2 for instructions on installing additional system components.

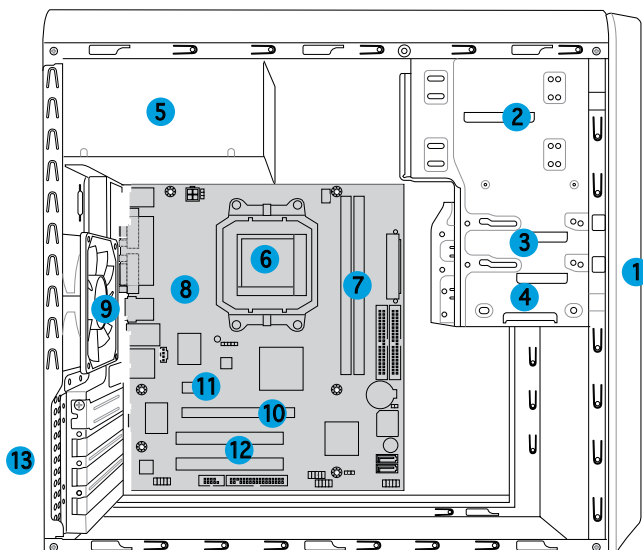

- |                                 |                          |
|---------------------------------|--------------------------|
| 1. Front panel cover            | 8. ASUS motherboard      |
| 2. 5.25-inch optical drive bays | 9. Chassis fan           |
| 3. Hard disk drive bay          | 10. PCI Express x16 slot |
| 4. Floppy disk drive bay        | 11. PCI Express x1 slot  |
| 5. Power supply unit            | 12. PCI slots            |
| 6. CPU socket                   | 13. Metal bracket lock   |
| 7. DIMM sockets                 |                          |



# Chapter 2

This chapter provides step-by-step instructions on how to install components in the system.

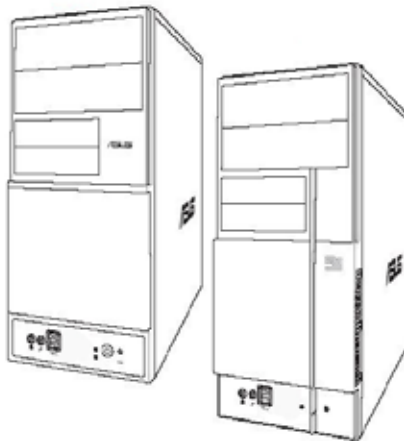

# Basic installation

## 2.1 Preparation

Before you proceed, make sure that you have all the components you plan to install in the system.

### Basic components to install

1. Central Processing Unit (CPU)
2. DDR2 Dual Inline Memory Module (DIMM)
3. Expansion card(s)
4. Hard disk drive
5. Optical drive
6. Floppy disk drive

### Tool

Phillips (cross) screw driver

## 2.2 Before you proceed

Take note of the following precautions before you install components into the system.



- Use a grounded wrist strap or touch a safely grounded object or a metal object, such as the power supply case, before handling components to avoid damaging them due to static electricity.
- Hold components by the edges to avoid touching the ICs on them.
- Whenever you uninstall any component, place it on a grounded antistatic pad or in the bag that came with the component.

The motherboard comes with an onboard standby power LED. This LED lights up to indicate that the system is ON, in sleep mode or in soft-off mode, and not powered OFF. Unplug the power cable from the power outlet and make sure that the standby power LED is OFF before installing any system component.

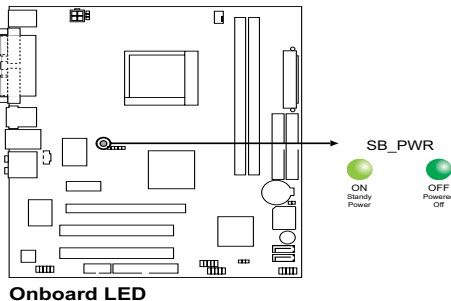

## 2.3 Removing the side cover and front panel assembly

1. Remove the cover screws on the rear panel.
2. Pull the side cover toward the rear panel until its hooks disengage from the chassis tab holes. Set the side cover aside.
3. Locate the front panel assembly hooks, then lift them until they disengage from the chassis.
4. Swing the front panel assembly to the right, until the hinge-like tabs on the right side of the assembly are exposed.
5. Remove the front panel assembly, then set aside.

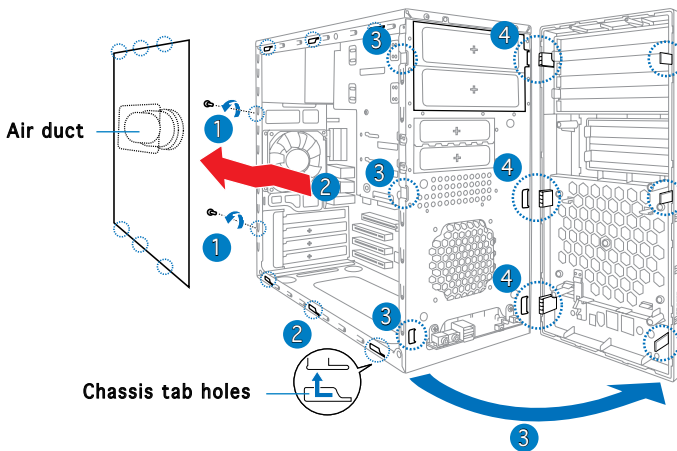

## 2.4 Central Processing Unit (CPU)

### 2.4.1 Overview

The motherboard comes with a 940-pin AM2 socket designed for the AMD Athlon™ 64 X2/AMD Athlon™ 64/AMD Sempron™ processor.



Make sure you use a CPU is designed for the AM2 socket. The CPU fits in only one correct orientation. DO NOT force the CPU into the socket to prevent bending the connectors on the socket and damaging the CPU!

### 2.4.2 Installing CPU

To install a CPU:

1. Locate the CPU socket on the motherboard.

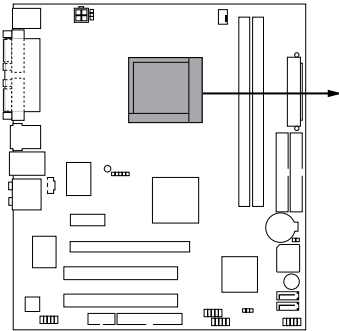

**CPU Socket AM2**

2. Unlock the socket by pressing the lever sideways, then lift it up to a 90°-100° angle.

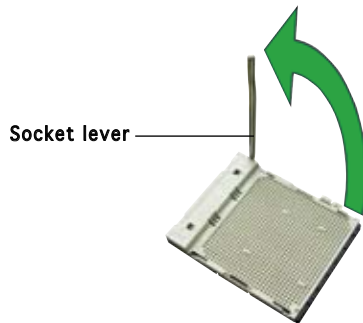

Make sure that the socket lever is lifted up to 90°-100° angle, otherwise the CPU does not fit in completely.

- Position the CPU above the socket such that the CPU corner with the gold triangle matches the socket corner with a small triangle.
- Carefully insert the CPU into the socket until it fits in place.

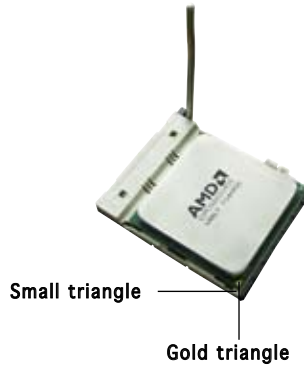

The CPU fits only in one correct orientation. DO NOT force the CPU into the socket to prevent bending the pins and damaging the CPU!

- When the CPU is in place, push down the socket lever to secure the CPU. The lever clicks on the side tab to indicate that it is locked.
- Install a CPU heatsink and fan following the instructions that came with the heatsink package.
- Connect the CPU fan cable to the CPU\_FAN connector on the motherboard.

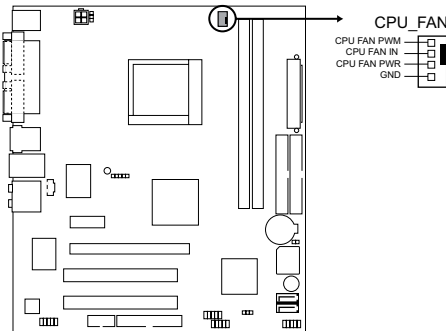

**CPU Fan connector**



Do not forget to connect the CPU fan connector! Hardware monitoring errors can occur if you fail to plug this connector.

### 2.4.3 Installing the heatsink and fan

The AMD Athlon™ 64 X2/AMD Athlon™ 64/AMD Sempron™ processor require a specially designed heatsink and fan assembly to ensure optimum thermal condition and performance.



---

Make sure that you use only qualified heatsink and fan assembly.

---

Follow these steps to install the CPU heatsink and fan.

1. Place the heatsink on top of the installed CPU, making sure that the heatsink fits properly on the retention module base.



- The retention module base is already installed on the motherboard upon purchase.
  - You do not have to remove the retention module base when installing the CPU or installing other motherboard components.
  - If you purchased a separate CPU heatsink and fan assembly, make sure that a Thermal Interface Material is properly applied to the CPU heatsink or CPU before you install the heatsink and fan assembly.
- 

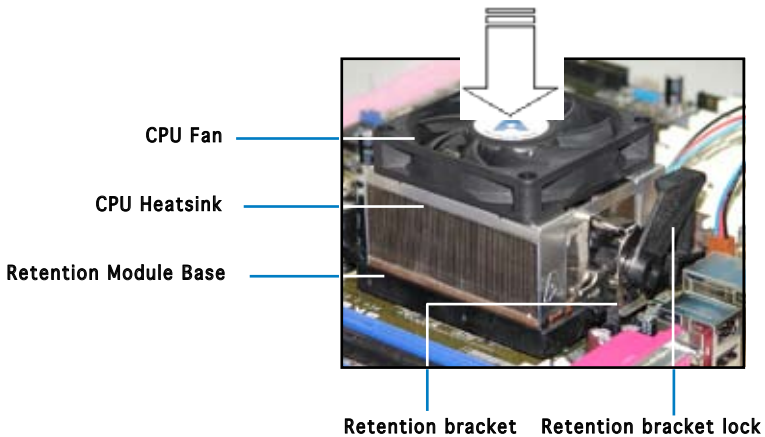

---

Your boxed CPU heatsink and fan assembly should come with installation instructions for the CPU, heatsink, and the retention mechanism. If the instructions in this section do not match the CPU documentation, follow the latter.

---



2. Attach one end of the retention bracket to the retention module base.

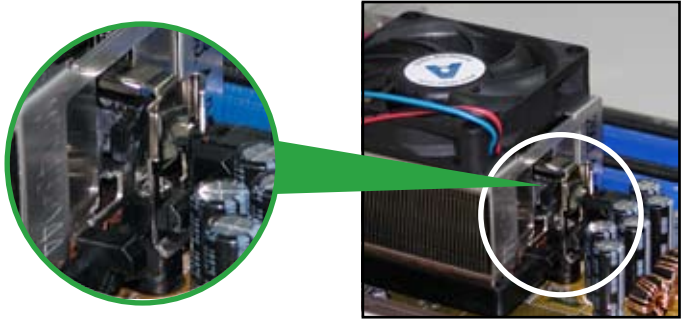

3. Align the other end of the retention bracket (near the retention bracket lock) to the retention module base. A clicking sound denotes that the retention bracket is in place.



Make sure that the fan and heatsink assembly perfectly fits the retention mechanism module base; otherwise, you cannot snap the retention bracket in place.



4. Push down the retention bracket lock on the retention mechanism to secure the heatsink and fan to the module base.

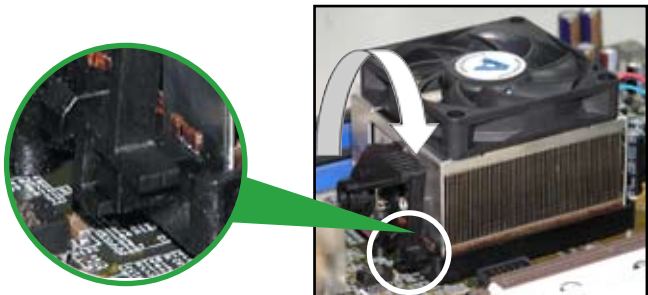

## 2.5 Installing a DIMM

The system motherboard comes with two Double Data Rate 2 (DDR2) Dual Inline Memory Module (DIMM) sockets.

The following figure illustrates the location of the sockets:

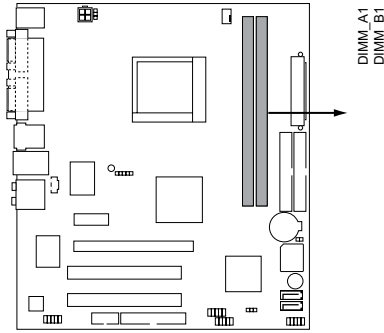

**240-pin DDR2 DIMM Sockets**

### 2.5.1 Memory configurations

You may install 256 MB, 512 MB, and 1 GB unbuffered ECC/non-ECC DDR2 DIMMs into the DIMM sockets.



---

For optimum compatibility, we recommend that you obtain memory modules from the same vendor. Visit the ASUS website ([www.asus.com](http://www.asus.com)) for the latest Qualified Vendors List..

---

## Qualified Vendors Lists (QVL)

Model	Side(s)	Chip Number	Size	Part Number
Kingston	SS	E5116AB-5C-E	256MB	KVR533D2N4/256
Kingston	SS	E5116AF-5C-E	256MB	KVR533D2N4/256
Kingston	DS	HY5PSS6821	512MB	KVR533D2N4/512
Kingston	DS	D6408TE7BL-37	1G	KVR533D2N4/1G
Kingston	SS	E2508AB-6E-E	256MB	KVR667D2N5/256
Kingston	SS	D6408TE8WL-27	512MB	KVR667D2N5/512
Kingston	SS	E5108AE-6E-E	512MB	KVR667D2E5/512
Samsung	SS	K4T51083QB-GCD5	512MB	M378T6553BG0-CD5
Samsung	SS	K4T51083QC	512MB	KR M378T6553CZ0-CE6
Samsung	DS	K4T56083QF-ZCE6	512MB	KR M378T6453FZ0-CE6
Samsung	SS	K4T51083QC-ZCE6	1G	KR M378T2953CZ0-CE6
Infineon	SS	HYB18T512160AF-3.7AFSS31270	256MB	HYS64T32000HU-3.7-A
Infineon	SS	HYB18T512800AC37SSS11511	512MB	HYS64T64000GU-3.7-A
Infineon	SS	HYB18T512800AF37SSS12079	512MB	HYS64T64000HU-3.7-A
Infineon	SS	HYB18T512800AF37FSS29334	512MB	HYS64T64000HU-3.7-A
Infineon	SS	HYB18T5128000AF-3SSSS27416	512MB	HYS64T32000HU-3S-A
Infineon	SS	HYB18T512800AF3SFSS05346	512MB	HYS64T64000HU-3S-A
Infineon	DS	HYB18T512800AF3SSSS28104	1G	HYS64T128020HU-3S-A
Micron	DS	D9BOM	512MB	MT 16HTF6464AG-53EB2
Micron	DS	D9CRZ	1G	MT 16HTF12864AY-53EA1
Corsair	DS	MIII0052532M8CEC	512MB	V5S12MB533D2
HY	SS	HY5P512821AFP-Y4	512MB	HYMP564U64AP8-Y4 AA
Kingmax	SS	KKEA88B4IAK-37	512MB	KLBC28F-A8KB4
Kingmax	SS	E5116AB-5C-E	256MB	KLBB68F-36EP4
Kingmax	SS	E5108AE-6E-E	512MB	KLCC28F-A8EB5
VDATA	SS	VD29608A8A-3EC20615	512MB	M2GVD5G3H31A4I1C52
VDATA	DS	VD29608A8A-3EC20620	1G	M2GVD5G3I41C4I1C52

Side(s): SS - Single-sided DS - Double-sided



Visit the ASUS website for the latest DDR2-667/533 MHz QVL.

## 2.5.2 Installing a DDR2 DIMM



Make sure to unplug the power supply before adding or removing DIMMs or other system components. Failure to do so may cause severe damage to both the motherboard and the components.

1. Unlock a DDR2 DIMM socket by pressing the retaining clips outward.
2. Align a DIMM on the socket such that the notch on the DIMM matches the break on the socket.

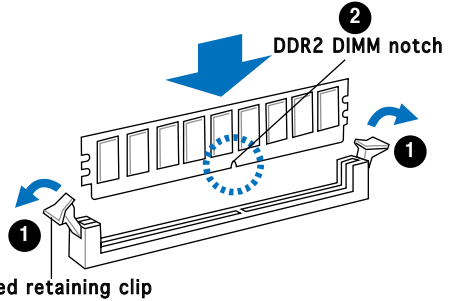

A DDR2 DIMM is keyed with a notch so that it fits in only one direction. DO NOT force a DIMM into a socket to avoid damaging the DIMM.

3. Firmly insert the DIMM into the socket until the retaining clips snap back in place and the DIMM is properly seated.

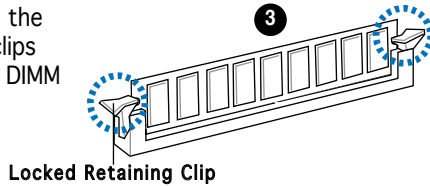

## 2.5.3 Removing a DDR2 DIMM

Follow these steps to remove a DIMM.

1. Simultaneously press the retaining clips outward to unlock the DIMM.

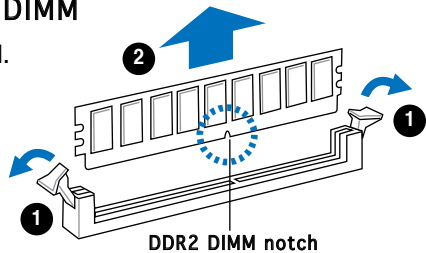

Support the DIMM lightly with your fingers when pressing the retaining clips. The DIMM might get damaged when it flips out with extra force.

2. Remove the DIMM from the socket.

## 2.6 Expansion slots

In the future, you may need to install expansion cards. The following sub-sections describe the slots and the expansion cards that they support.



---

Make sure to unplug the power cord before adding or removing expansion cards. Failure to do so may cause you physical injury and damage motherboard components.

---

### 2.6.1 Installing an expansion card

To install an expansion card:

1. Before installing the expansion card, read the documentation that came with it and make the necessary hardware settings for the card.
2. Remove the system unit cover (if your motherboard is already installed in a chassis).
3. Remove the bracket opposite the slot that you intend to use. Keep the screw for later use.
4. Align the card connector with the slot and press firmly until the card is completely seated on the slot.
5. Secure the card to the chassis with the screw you removed earlier.
6. Replace the system cover.

### 2.6.2 Configuring an expansion card

After installing the expansion card, configure it by adjusting the software settings.

1. Turn on the system and change the necessary BIOS settings, if any. See Chapter 5 for information on BIOS setup.
2. Assign an IRQ to the card. Refer to the tables on the next page.
3. Install the software drivers for the expansion card.



---

When using PCI cards on shared slots, ensure that the drivers support “Share IRQ” or that the cards do not need IRQ assignments. Otherwise, conflicts will arise between the two PCI groups, making the system unstable and the card inoperable. Refer to the table on the next page for details.

---

## Standard interrupt assignments

IRQ	Priority	Standard Function
0	1	System Timer
1	2	Keyboard Controller
2	-	Re-direct to IRQ#9
3	11	IRQ holder for PCI steering*
4	12	Communications Port (COM1)*
5	13	IRQ holder for PCI steering*
6	14	Floppy Disk Controller
7	15	Printer Port (LPT1)*
8	3	System CMOS/Real Time Clock
9	4	IRQ holder for PCI steering*
10	5	IRQ holder for PCI steering*
11	6	IRQ holder for PCI steering*
12	7	PS/2 Compatible Mouse Port*
13	8	Numeric Data Processor
14	9	Primary IDE Channel
15	10	Secondary IDE Channel

\* These IRQs are usually available for ISA or PCI devices.

## IRQ assignments for this motherboard

	A	B	C	D
PCI slot 1	used	—	—	—
PCI slot 2	—	used	—	—



When using PCI cards on shared slots, ensure that the drivers support “Share IRQ” or that the cards do not need IRQ assignments. Otherwise, conflicts will arise between the two PCI groups, making the system unstable and the card inoperable.

### 2.6.3 PCI Express x1 slot

This motherboard supports PCI Express x1 network cards, SCSI cards and other cards that comply with the PCI Express specifications. The following figure shows a network card installed on the PCI Express x1 slot.

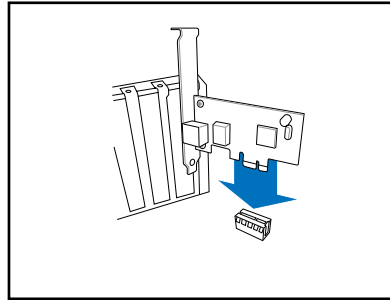

### 2.6.4 PCI slots

The PCI slots support cards such as a LAN card, SCSI card, USB card, and other cards that comply with PCI specifications. The figure shows a LAN card installed on a PCI slot.

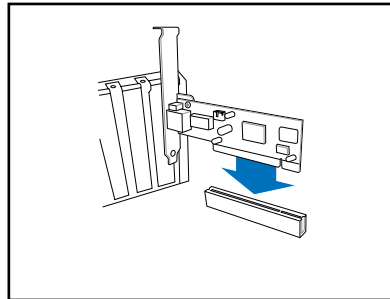

### 2.6.5 PCI Express x16 slot

This motherboard supports PCI Express x16 graphic cards that comply with the PCI Express specifications. The figure shows a graphics card installed on the PCI Express x16 slot.

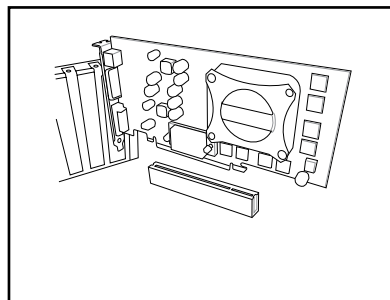

## 2.7 Installing an optical drive

Refer to the instructions in this section if you wish to install a new optical drive.

Follow these steps to install an optical drive:

1. Place the chassis upright.
2. Remove the drive slot metal plate cover.
3. Insert the optical drive into the upper 5.25-inch drive bay and carefully push the optical drive into the bay until its screw holes align with the holes on the bay as shown.
4. Secure the optical drive with two screws on both sides of the bay.

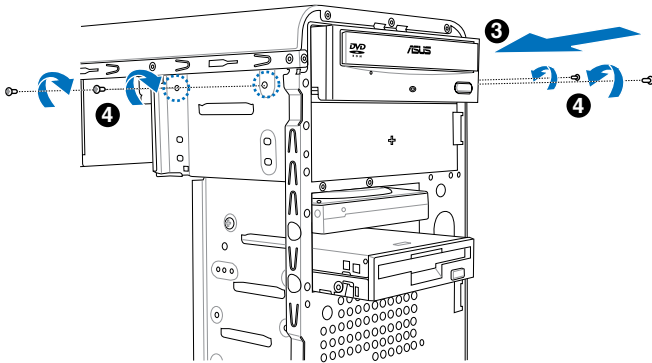

5. Connect the audio (A), IDE (B), and power (C) plugs to connectors at the back of the drive.
6. Connect the other end of the IDE ribbon cable to the secondary IDE connector (labeled SEC\_IDE) on the motherboard. See page 4-6 for the location of this connector.
7. Remove the dummy drive slot cover from the front panel.
8. Replace the front panel. Refer to section “2.10 Removing the bay covers and reinstalling the front panel assembly and side cover” on page 2-19 for details.

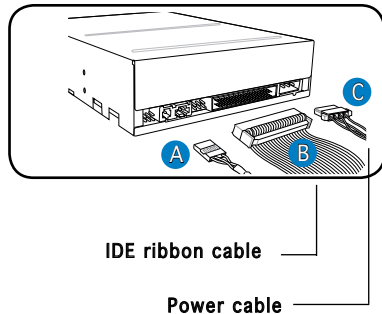





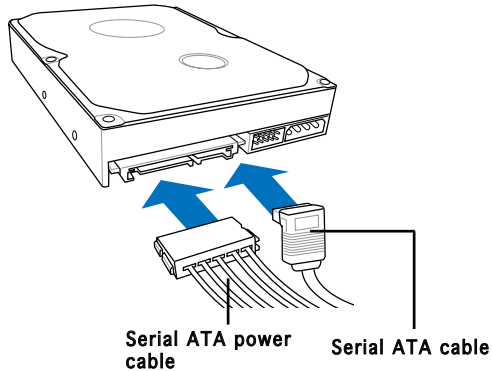

5. Connect one end of the Serial ATA cable to the SATA connector at the back of the drive, then connect the other end to a Serial ATA connector on the motherboard. See page 4-5 for the location of the Serial ATA connectors.
6. Connect a 15-pin Serial ATA power plug from the power supply unit to the 15-pin power connector at the back of the drive.

- OR -

Connect a 4-pin (female) power plug from the power supply unit to the 4-pin (male) power connector at the back of the drive.



---

If your Serial ATA HDD has both 4-pin and 15-pin connectors at the back, use either the 15-pin SATA power adapter plug **OR** the legacy 4-pin power connector. **DO NOT** use both to prevent damage to components and to keep the system from becoming unstable.

---

To install an IDE hard disk drive:

1. Follow steps 1-4 of the previous section.
2. Connect the blue interface of the IDE ribbon cable to the primary IDE connector (blue connector labeled PRI\_IDE) on the motherboard. See page 4-6 for the location of the connector.

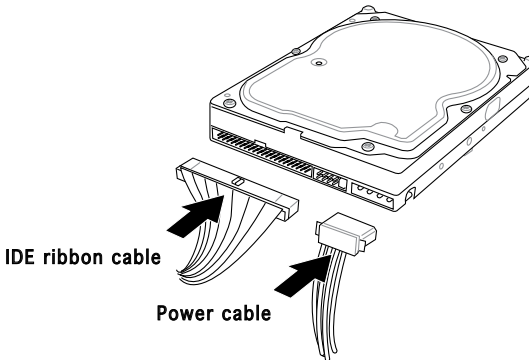

- 
- If you will install only one hard disk drive, make sure to configure your hard disk drive as Master device before connecting the IDE cable and power plug. Refer to the HDD documentation on how to set the drive as a Master device.
  - If you will install two IDE hard disk drives, configure the other device as Slave.
- 

3. Connect the gray interface of the IDE ribbon cable to the IDE connector on the drive.
4. If you install two IDE hard disk drives, connect the black interface of the IDE ribbon cable to the IDE connector on the second (Slave) IDE hard disk drive.
5. Connect a 4-pin power plug from the power supply unit to the power connector at the back of the drive(s).

## 2.9 Installing a floppy disk drive

The V-Series M2V890 Barebone system comes with one 3.25-inch drive bay for a floppy disk drive.

To install a floppy disk drive:

1. Remove the front panel cover.



For instructions on how to remove the front panel cover, refer to page 2-3 of section “2.3 Removing the side cover and front panel assembly”.

2. Carefully insert the floppy disk drive into the floppy drive bay until the screw holes align with the holes on the bay.
3. Secure the floppy disk drive with two screws on both sides.

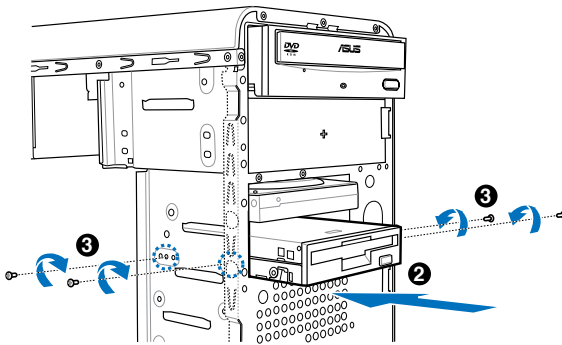

4. Connect the floppy disk drive signal cable to the signal connector at the back of the drive.

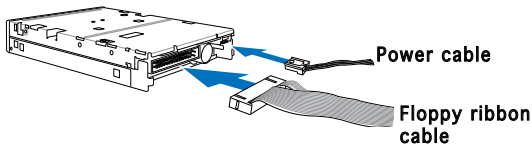

5. Connect the other end of the signal cable to the floppy disk drive connector on the motherboard. See page 4-4 for the location of the floppy disk drive connector.
6. Connect a 4-pin power cable from the power supply unit to the power connector at the back of the floppy disk drive.

## 2.10 Removing the bay covers and reinstalling the front panel assembly and side cover

If you installed an optical and/or floppy disk drive, remove the bay cover(s) on the front panel assembly before reinstalling it to the chassis. To do this:

1. Locate the bay cover locks.
2. Press the locks outward to release the bay cover.
3. Push the bay cover inward, then set it aside.
4. Follow the same instructions to remove the 3.5" drive bay cover.

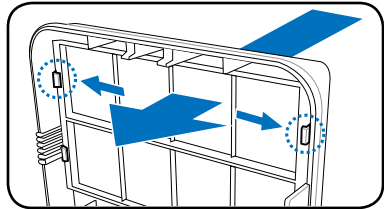

To reinstall the front panel assembly and side cover:

1. Insert the front panel assembly hinge-like tabs to the holes on the right side of the chassis.
2. Swing the front panel assembly to the left, then insert the hooks to the chassis until the front panel assembly fits in place.
3. Insert the six side cover hooks into the chassis tab holes .
4. Push the side cover to the direction of the front panel until it fits in place.
5. Secure the cover with two screws you removed earlier.



If the air duct interferes with the CPU fan, adjust the air duct accordingly.

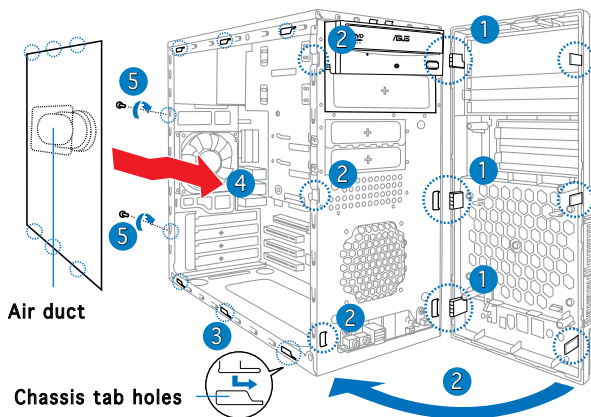



# Chapter 3

This chapter helps you power up the system and install drivers and utilities from the support CD.

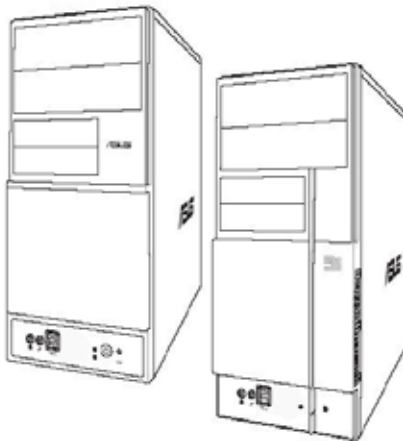

# Starting up

### 3.1 Installing an operating system

The barebone system supports Windows® 2000/XP operating systems (OS). Always install the latest OS version and corresponding updates so you can maximize the features of your hardware.



- Motherboard settings and hardware options vary. Use the setup procedures presented in this chapter for reference only. Refer to your OS documentation for detailed information.
- Make sure that you install Windows® 2000 Service Pack 4 or the Windows® XP Service Pack 1 or later versions before installing the drivers for better compatibility and system stability.

### 3.2 Powering up

Press the system power button (⏻) to enter the OS.

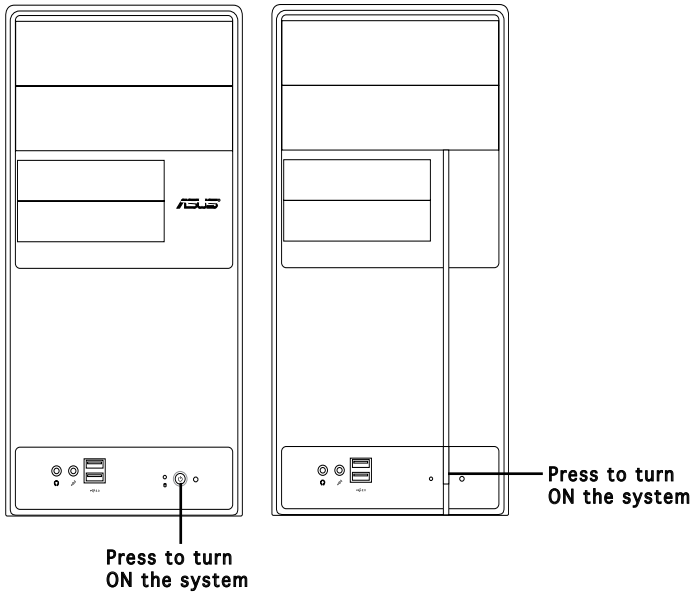



## 3.3 Support CD information

The support CD that came with the system contains useful software and several utility drivers that enhance the system features.



- Screen display and driver options may not be the same for different operating system versions.
- The contents of the support CD are subject to change at any time without notice. Visit the ASUS website for updates.

### 3.3.1 Running the support CD

To begin using the support CD, place the CD in your optical drive. The CD automatically displays the Drivers menu if Autorun is enabled in your computer.



Click an icon to display support CD/motherboard information

Click an item to install



If Autorun is NOT enabled in your computer, browse the contents of the support CD to locate the file ASSETUP.EXE from the BIN folder. Double-click the ASSETUP.EXE to run the CD.

### 3.3.2 Drivers menu

The drivers menu shows the available device drivers if the system detects installed devices. Install the necessary drivers to activate the devices.



#### **AMD Cool 'n' Quiet Driver**

Installs the AMD Cool 'n' Quiet driver.

#### **VIA Chipset Driver Program**

Installs the VIA chipset driver program.

#### **VIA S3G Display Driver**

Installs the VIA S3G display driver.

#### **Realtek Audio Driver**

Installs the Realtek® audio driver.

#### **Realtek RTL8100S LAN Driver**

Installs the Realtek® RTL8100S LAN driver.



---

The screen display and drivers option may not be the same for different operating system versions.

---

### 3.3.3 Utilities menu

The Utilities menu shows the applications and other software that the motherboard supports.



#### **ASUS Cool 'n' Quiet Utility**

Installs the ASUS Cool 'n' Quiet utility.

#### **ASUS Update**

The ASUS Update utility allows you to update the motherboard BIOS in a Windows® environment. This utility requires an Internet connection either through a network or an Internet Service Provider (ISP).

#### **ADOBE Acrobat Reader V7.0**

The Adobe® Acrobat® Reader V7.0 is for opening, viewing, and printing documents in Portable Document Format (PDF).

#### **Microsoft DirectX 9.0c**

The Microsoft® DirectX® 9.0c is a multimedia technology that enhances computer graphics and sounds. DirectX® improves the multimedia features of your computer so you can enjoy watching TV and movies, capturing videos, or playing games on your computer.



---

Microsoft® Windows® XP Service Pack 2 already includes Microsoft® DirectX® 9.0c. If your system is Microsoft® Windows® XP Service Pack 2-embedded, skip Microsoft® DirectX® 9.0c installation.

---

## Anti-Virus utility

The anti-virus utility scans, identifies, and removes computer viruses. View the online help for detailed information.

## ASUS Screen Saver

Installs the ASUS screen saver.



---

The screen display and utilities option may not be the same for different operating system versions.

---

### 3.3.4 Make Disk menu

The Make Disk menu allows you to make a RAID driver disk.



### VIA VT8237 RAID Controller Driver

Allows you to create a VIA® VT8237 RAID driver disk.

### 3.3.5 ASUS Contact information

Click the Contact tab to display the ASUS contact information. You can also find this information on the inside front cover of this user guide.





# Chapter 4

This chapter gives information about the motherboard that comes with the system. This chapter includes the motherboard layout, jumper settings, and connector locations.

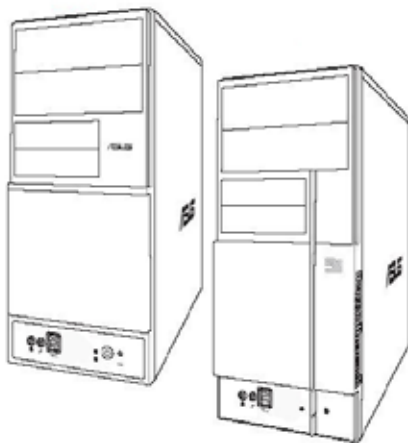

# Motherboard information

# 4.1 Introduction

The V-Series M2V890 barebone system comes with an ASUS motherboard. This chapter provides technical information about the motherboard for future upgrades or system reconfiguration.

# 4.2 Motherboard layout

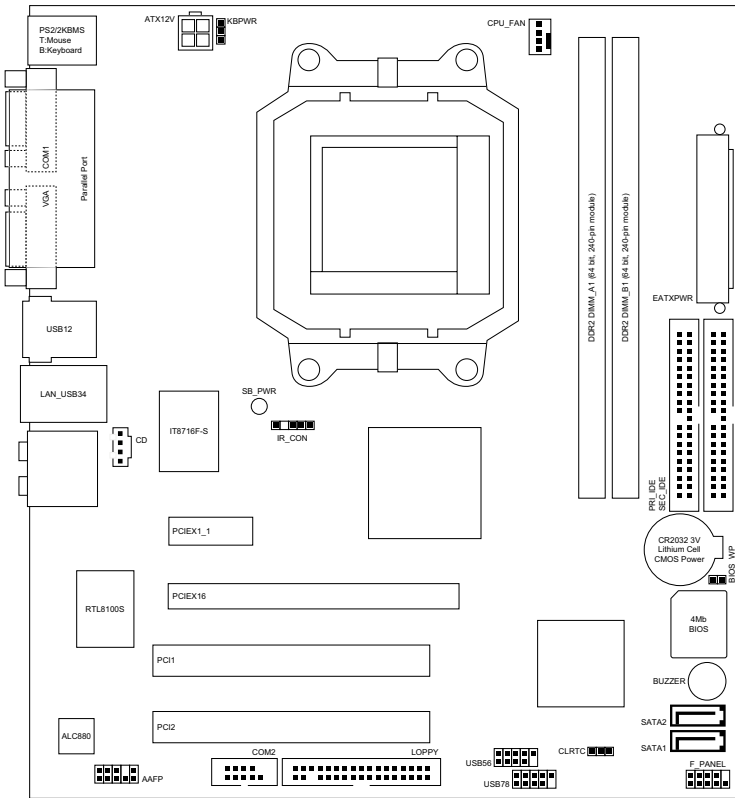



## 4.3 Jumpers

### 1. Clear RTC RAM (CLRTC)

This jumper allows you to clear the Real Time Clock (RTC) RAM in CMOS. You can clear the CMOS memory of date, time, and system setup parameters by erasing the CMOS RTC RAM data. The onboard button cell battery powers the RAM data in CMOS, which include system setup information such as system passwords.

To erase the RTC RAM:

1. Turn OFF the computer and unplug the power cord.
2. Remove the onboard battery.
3. Move the jumper cap from pins 1-2 (default) to pins 2-3. Keep the cap on pins 2-3 for about 5-10 seconds, then move the cap back to pins 1-2.
4. Reinstall the battery.
5. Plug the power cord and turn ON the computer.
6. Hold down the <Del> key during the boot process and enter BIOS setup to re-enter data.



Except when clearing the RTC RAM, never remove the cap on CLRTC jumper default position. Removing the cap will cause system boot failure!

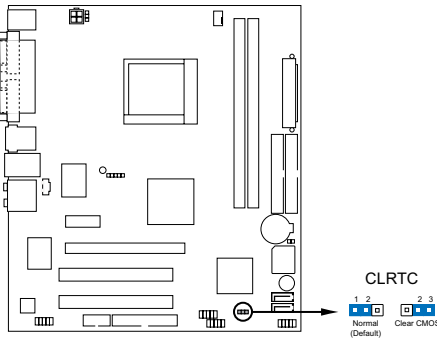

**Clear RTC RAM**



- You do not need to clear the RTC when the system hangs due to overclocking. For system failure due to overclocking, use the C.P.R. (CPU Parameter Recall) feature. Shut down and reboot the system so the BIOS can automatically reset parameter settings to default values.
- Due to the chipset limitation, AC power off is required prior using C.P.R. function. You must turn off and on the power supply or unplug and plug the power cord before reboot the system.

### 3. Keyboard power (3-pin KBPWR)

This jumper allows you to enable or disable the keyboard wake-up feature. Set this jumper to pins 2-3 (+5VSB) to wake up the computer when you press a key on the keyboard (the default is the Space Bar). This feature requires an ATX power supply that can supply at least 500 mA on the +5VSB lead, and a corresponding setting in the BIOS.

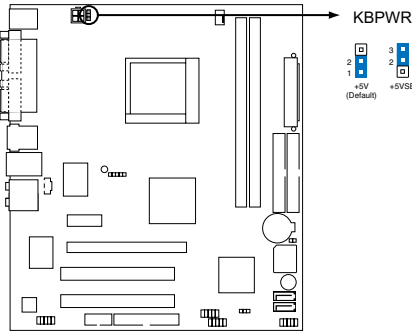

Fan connectors

## 4.4 Connectors

### 1. Floppy disk drive connector (34-1 pin FLOPPY)

This connector is for the provided floppy disk drive (FDD) signal cable. Insert one end of the cable to this connector, then connect the other end to the signal connector at the back of the floppy disk drive.



Pin 5 on the connector is removed to prevent incorrect cable connection when using a FDD cable with a covered Pin 5.

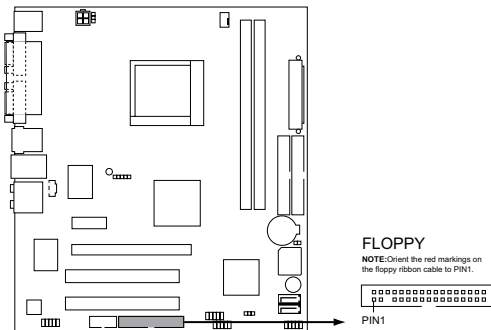

Floppy disk drive connector

## 2. Serial ATA connectors (7-pin SATA1, SATA2)

These connectors are for the Serial ATA signal cables for Serial ATA hard disk and optical disk drives that allows up to 150 MB/s data transfer rates, faster than the standard parallel ATA with 133 MB/s (Ultra DMA133).

If you install Serial ATA hard disk drives, you can create a RAID 0, RAID 1, and JBOD configuration through the onboard VIA® VT8237R Plus controller.

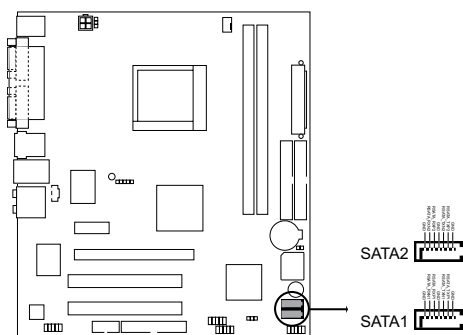

**SATA connectors**



---

Install the Windows® 2000 Service Pack 4 or the Windows® XP Service Pack1 before using Serial ATA.

---



- For detailed instructions on how to configure RAID 0, 1, and JBOD, refer to the RAID manual in the support CD.
  - The RAID function of these connectors is set to [Disabled] by default. See section “5.4.4 Onboard Device Configuration” for details.
-

### 3 IDE connector (40-1 pin PRI\_EIDE)

The onboard IDE connectors are for Ultra DMA 133/100/66 signal cable(s). There are three connectors on each Ultra DMA 133/100/66 signal cable: blue, black, and gray. Connect the blue connector to the motherboard's IDE connector, then select one of the following modes to configure your device(s).

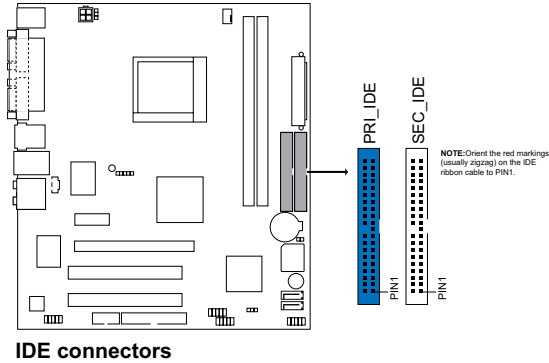

	Drive jumper setting	Mode of device(s)	Cable connector
Single device	Cable-Select or Master	-	Black
Two devices	Cable-Select	Master	Black
		Slave	Gray
	Master	Master	Black or gray
	Slave	Slave	



- Pin 20 on the IDE connector is removed to match the covered hole on the Ultra DMA cable connector. This prevents incorrect insertion when you connect the IDE cable.
- Use the 80-conductor IDE cable for Ultra DMA 133/100/66 IDE devices.



If any device jumper is set as “Cable-Select”, make sure all other device jumpers have the same setting.

### 4. CPU Fan Connectors (4-pin CPU\_FAN)

The fan connectors support cooling fans of 350mA~740mA (8.88W max.) or a total of 1A~2.22A (26.64W max.) at +12V. Connect the fan cables to the fan connectors on the motherboard, making sure that the black wire of each cable matches the ground pin of the connector.

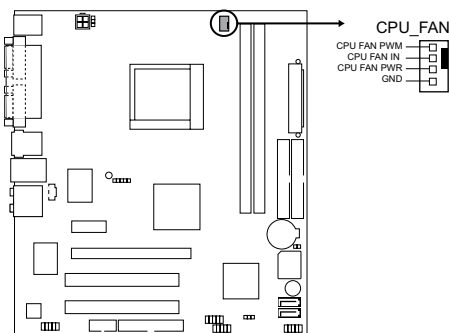

**Fan connectors**



Do not forget to connect the fan cables to the fan connectors. Insufficient air flow inside the system may damage the motherboard components. These are not jumpers! Do not place jumper caps on the fan connectors!

## 5. USB connectors (10-1 pin USB56, USB 78)

These connectors are for USB 2.0 ports. Connect the USB module cable to any of these connectors, then install the module to a slot opening at the back of the system chassis. These USB connectors comply with USB 2.0 specification that supports up to 480 Mbps connection speed.

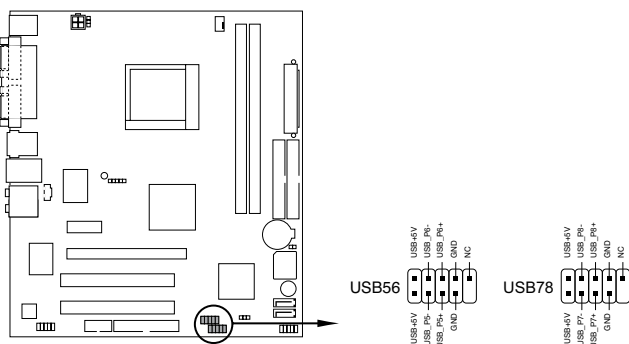

**USB connectors**



Never connect a **1394 cable** to the USB connectors. Doing so will damage the motherboard!



The USB module is purchased separately.

## 6. ATX power connectors (24-pin EATXPWR, 4-pin ATX12V)

These connectors are for an ATX power supply. The plugs from the power supply are designed to fit these connectors in only one orientation. Find the proper orientation and push down firmly until the connectors completely fit.



- We recommend that you use an ATX 12 V Specification 2.0-compliant power supply unit (PSU) with a minimum of 300 W power rating. This PSU type has 24-pin and 4-pin power plugs.
- If you intend to use a PSU with 20-pin and 4-pin power plugs, make sure that the 20-pin power plug can provide at least 15 A on +12 V and that the PSU has a minimum power rating of 300 W. The system may become unstable or may not boot up if the power is inadequate.
- Do not forget to connect the 4-pin ATX +12 V power plug; otherwise, the system will not boot up.
- We recommend that you use a PSU with higher power output when configuring a system with more power-consuming devices. The system may become unstable or may not boot up if the power is inadequate.
- You must install a PSU with a higher power rating if you intend to install additional devices.

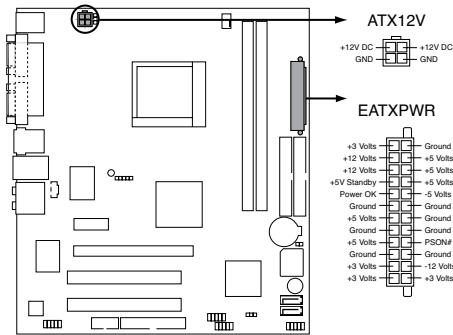

**ATX power connectors**

## 7. Front panel audio connector (10-1 pin AAFP)

This connector is for a chassis-mounted front panel audio I/O module that supports the Azalia audio standard. Connect one end of the front panel audio I/O module cable to this connector.

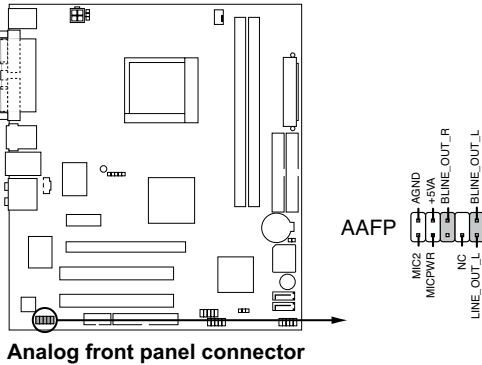

## 8. Serial port connector (10-1 pin COM2)

This connector is for serial (COM) port. Connect the serial port module cable to this connector, then install the module to a slot opening at the back of the system chassis.



The serial port bracket (COM) is purchased separately.

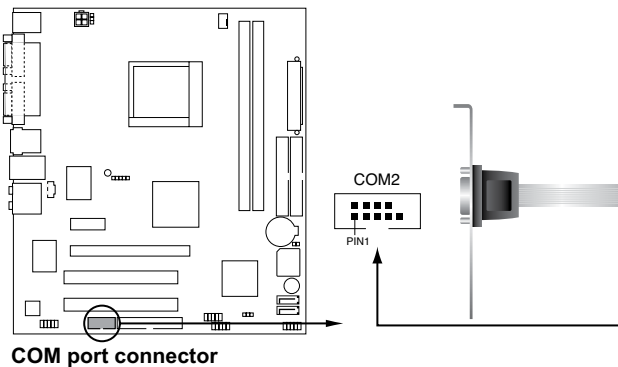

## 9. System panel connector (2x5 10 pin F\_PANEL)

This connector supports several chassis-mounted functions.

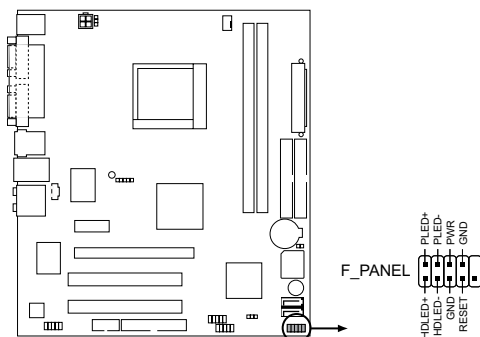

**System panel connector**

- **System power LED**  
This 3-pin connector is for the system power LED. Connect the chassis power LED cable to this connector. The system power LED lights up when you turn on the system power, and blinks when the system is in sleep mode.
- **Hard disk drive activity LED**  
This 2-pin connector is for the HDD Activity LED. Connect the HDD Activity LED cable to this connector. The IDE LED lights up or flashes when data is read from or written to the HDD.
- **System warning speaker**  
This 4-pin connector is for the chassis-mounted system warning speaker. The speaker allows you to hear system beeps and warnings.
- **Power/Soft-off button**  
This connector is for the system power button. Pressing the power button turns the system ON or puts the system in SLEEP or SOFT-OFF mode depending on the BIOS settings. Pressing the power switch for more than four seconds while the system is ON turns the system OFF.
- **Reset button**  
This 2-pin connector is for the chassis-mounted reset button for system reboot without turning off the system power.



## 10. Optical drive audio In connector (4-pin CD)

This connector allows you to receive stereo audio input from sound sources such as a CD-ROM, TV tuner, or MPEG card.

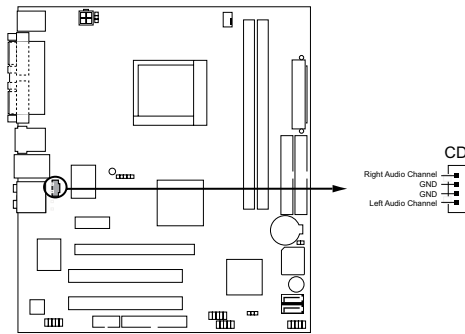

**Internal audio connector**



# Chapter 5

This chapter tells how to change system settings through the BIOS Setup menus and describes the BIOS parameters.

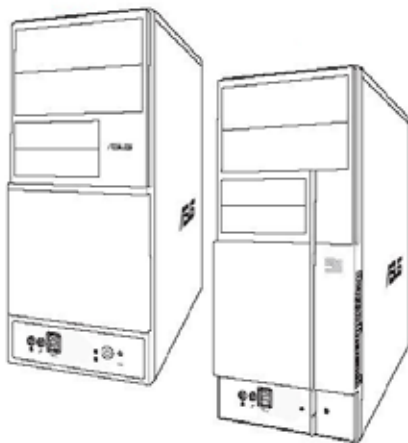

# BIOS setup

## 5.1 Managing and updating your BIOS

The following utilities allow you to manage and update the motherboard Basic Input/Output System (BIOS) setup.

1. **ASUS EZ Flash** (Updates the BIOS using a floppy disk during POST.)
2. **ASUS AFUDOS** (Updates the BIOS using a bootable floppy disk in DOS mode.)
3. **ASUS Update** (Updates the BIOS in Windows® environment.)

Refer to the corresponding sections for details on these utilities.



- 
- Save a copy of the original motherboard BIOS file to a bootable floppy disk in case you need to restore the BIOS in the future. Copy the original motherboard BIOS using the AFUDOS utility.
  - Visit the ASUS website ([www.asus.com](http://www.asus.com)) and download the latest BIOS file for this motherboard using the ASUS Update utility.
- 

### 5.1.1 Creating a bootable floppy disk

1. Do either one of the following to create a bootable floppy disk.  
DOS environment
  - a. Insert a 1.44MB floppy disk into the drive.
  - b. At the DOS prompt, type `format A:/S` then press <Enter>.Windows® XP environment
  - a. Insert a 1.44 MB floppy disk to the floppy disk drive.
  - b. Click **Start** from the Windows® desktop, then select **My Computer**.
  - c. Select the 3 1/2 Floppy Drive icon.
  - d. Click **File** from the menu, then select **Format. A Format 3 1/2 Floppy Disk** window appears.
  - e. Select **Create an MS-DOS startup disk** from the format options field, then click **Start**.

#### Windows® 2000 environment

To create a set of boot disks for Windows® 2000:

- a. Insert a formatted, high density 1.44 MB floppy disk into the drive.
- b. Insert the Windows® 2000 CD to the optical drive.
- c. Click **Start**, then select **Run**.
- d. From the Open field, type **D:\bootdisk\makeboot a:** assuming that D: is your optical drive.
- e. Press <Enter>, then follow screen instructions to continue.

2. Copy the original or the latest motherboard BIOS file to the bootable floppy disk.

### 5.1.2 ASUS EZ Flash utility

The ASUS EZ Flash feature allows you to update the BIOS without having to go through the long process of booting from a floppy disk and using a DOS-based utility. The EZ Flash utility is built-in the BIOS chip so it is accessible by pressing <Alt> + <F2> during the Power-On Self-Test (POST).

To update the BIOS using EZ Flash:

1. Visit the ASUS website ([www.asus.com](http://www.asus.com)) to download the latest BIOS file for your motherboard and rename the downloaded file as M2VTVM.ROM. Save the BIOS file to a floppy disk.
2. Reboot the system.
3. To launch EZ Flash, press <Alt+F2> during POST to display the following.

```
User recovery requested. Starting BIOS recovery...  
Checking for floppy...
```



- If there is no floppy disk in the drive, the error message “Floppy not found!” appears.
- If the correct BIOS file is not in the floppy disk, the error message “Floppy not found!” is displayed. Make sure to rename the downloaded BIOS file as “M2VTVM.ROM”.

4. Insert the floppy disk that contains the BIOS file. If all the necessary files are found in the floppy disk, EZ Flash performs the BIOS update process and automatically reboots the system when done.



DO NOT shut down or reset the system while updating the BIOS! Doing so can cause system boot failure!

```
User recovery requested. Starting BIOS recovery...  
Checking for floppy...  
Floppy found!  
Reading file "M2VTVM.ROM". Completed.  
Start flashing...  
Flashed successfully. Rebooting.
```

### 5.1.3 AFUDOS utility

The AFUDOS utility allows you to update the BIOS file in DOS environment using a bootable floppy disk with the updated BIOS file. This utility also allows you to copy the current BIOS file that you can use as backup when the BIOS fails or gets corrupted during the updating process.

#### Copying the current BIOS

To copy the current BIOS file using the AFUDOS utility:



- Make sure that the floppy disk is not write-protected and has at least 600 KB free space to save the file.
- The succeeding BIOS screens are for reference only. The actual BIOS screen displays may not be exactly the same as shown.

1. Copy the AFUDOS utility (afudos.exe) from the motherboard support CD to the bootable floppy disk you created earlier.
2. Boot the system in DOS mode, then at the prompt type:

**afudos /o[filename]**

where the [filename] is any user-assigned filename not more than eight alphanumeric characters for the main filename and three alphanumeric characters for the extension name.

```
A:\>afudos /oOLDBIOS1.ROM
```

Main filename    Extension name

3. Press <Enter>. The utility copies the current BIOS file to the floppy disk.

```
A:\>afudos /oOLDBIOS1.rom
AMI Firmware Update Utility - Version 1.19 (ASUS V2.07 (03.11.24BB))
Copyright (C) 2002 American Megatrends, Inc. All rights reserved.
Reading flash ..... done
Write to file..... ok
A:\>
```

The utility returns to the DOS prompt after copying the current BIOS file.

## Updating the BIOS file

To update the BIOS file using the AFUDOS utility:

1. Visit the ASUS website ([www.asus.com](http://www.asus.com)) and download the latest BIOS file for the motherboard. Save the BIOS file to a bootable floppy disk.



---

Write the BIOS filename on a piece of paper. You need to type the exact BIOS filename at the DOS prompt.

---

2. Copy the AFUDOS utility (`afudos.exe`) from the motherboard support CD to the bootable floppy disk you created earlier.
3. Boot the system in DOS mode, then at the prompt type:

```
afudos /i[filename]
```

where [filename] is the latest or the original BIOS file on the bootable floppy disk.

```
A:\>afudos /im2VTVM.ROM
```

4. The utility verifies the file and starts updating the BIOS.
5. The utility returns to the DOS prompt after the BIOS update process is completed. Reboot the system from the hard disk drive.

```
A:\>afudos /im2VTVM.ROM
AMI Firmware Update Utility - Version 1.19 (ASUS V2.07(03.11.24BB))
Copyright (C) 2002 American Megatrends, Inc. All rights reserved.

WARNING!! Do not turn off power during flash BIOS
Reading file ..... done
Reading flash ..... done

Advance Check .....
Erasing flash ..... done
Writing flash ..... done
Verifying flash .... done

Please restart your computer

A:\>
```



---

The BIOS information on the screen is for reference only. What you see on your screen may not be exactly the same as shown.

---



---

Do not shut down or reset the system while updating the BIOS to prevent system boot failure!

---

## 5.1.4 ASUS Update utility

The ASUS Update is a utility that allows you to manage, save, and update the motherboard BIOS in Windows® environment. The ASUS Update utility allows you to:

- Save the current BIOS file
- Download the latest BIOS file from the Internet
- Update the BIOS from an updated BIOS file
- Update the BIOS directly from the Internet, and
- View the BIOS version information.

This utility is available in the support CD that comes with the motherboard package.



---

ASUS Update requires an Internet connection either through a network or an Internet Service Provider (ISP).

---

## Installing ASUS Update

To install ASUS Update:

1. Place the support CD in the optical drive. The Drivers menu appears.
2. Click the Utilities tab, then click Install ASUS Update. See page 3-3 for the Utilities screen menu.
3. The ASUS Update utility is copied to your system.



---

Quit all Windows® applications before you update the BIOS using this utility.

---



## Updating the BIOS through the Internet

To update the BIOS through the Internet:

1. Launch the ASUS Update utility from the Windows® desktop by clicking **Start > Programs > ASUS > ASUSUpdate > ASUSUpdate**. The ASUS Update main window appears.

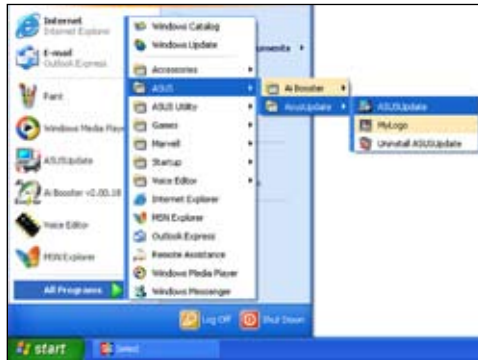

2. Select your desired update method, then click Next.



3. If you select updating/ downloading from the Internet, select the ASUS FTP site nearest you to avoid network traffic, or choose Auto Select. Click Next.



4. From the FTP site, select the BIOS version that you wish to download. Click Next.
5. Follow the instructions on the succeeding screens to complete the update process.



6. If you select the option to update the BIOS from a file, a window prompts you to locate the file. Select the file, click Open, then follow the screen instructions to complete the update process.

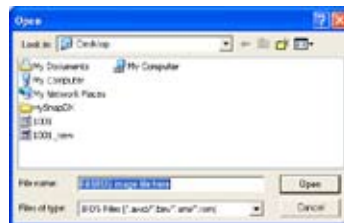

## 5.2 BIOS setup program

This motherboard supports a programmable Low-Pin Count (LPC) chip that you can update using the provided utility described in section “5.1 Managing and updating your BIOS.”

Use the BIOS Setup program when you are installing a motherboard, reconfiguring your system, or prompted to “Run Setup.” This section explains how to configure your system using this utility.

Even if you are not prompted to use the Setup program, you can change the configuration of your computer in the future. For example, you can enable the security password feature or change the power management settings. This requires you to reconfigure your system using the BIOS Setup program so that the computer can recognize these changes and record them in the CMOS RAM of the LPC chip.

The LPC chip on the motherboard stores the Setup utility. When you start up the computer, the system provides you with the opportunity to run this program. Press <Del> during the Power-On Self-Test (POST) to enter the Setup utility; otherwise, POST continues with its test routines.

If you wish to enter Setup after POST, restart the system by pressing <Ctrl> + <Alt> + <Del>, or by pressing the reset button on the system chassis. You can also restart by turning the system off and then back on. Do this last option only if the first two failed.

The Setup program is designed to make it as easy to use as possible. Being a menu-driven program, it lets you scroll through the various sub-menus and make your selections from the available options using the navigation keys.



- 
- The default BIOS settings for this motherboard apply for most conditions to ensure optimum performance. If the system becomes unstable after changing any BIOS settings, load the default settings to ensure system compatibility and stability. Select the **Load Setup Defaults** item under the Exit Menu. See section “5.7 Exit Menu.”
  - The BIOS setup screens shown in this section are for reference purposes only, and may not exactly match what you see on your screen.
  - Visit the ASUS website ([www.asus.com](http://www.asus.com)) to download the latest BIOS file for this motherboard and .
-

## 5.2.1 BIOS menu screen

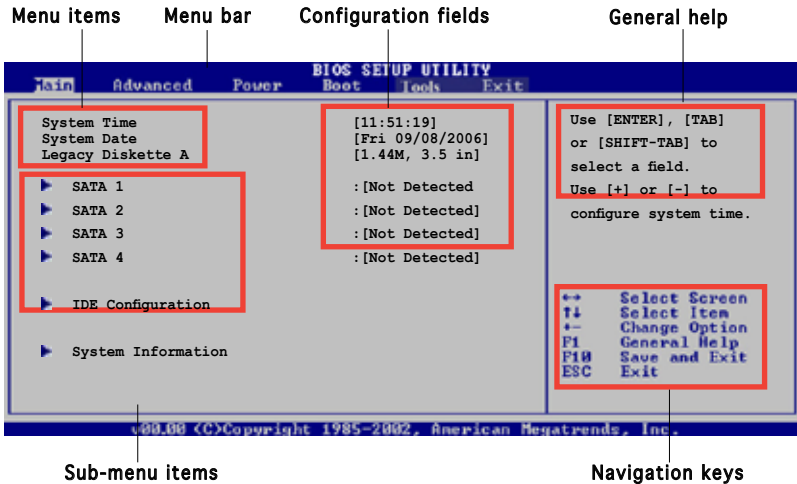

## 5.2.2 Menu bar

The menu bar on top of the screen has the following main items:

- Main** For changing the basic system configuration
- Advanced** For changing the advanced system settings
- Power** For changing the advanced power management (APM) configuration
- Boot** For changing the system boot configuration
- Exit** For selecting the exit options and loading default settings

To select an item on the menu bar, press the right or left arrow key on the keyboard until the desired item is highlighted.

## 5.2.3 Navigation keys

At the bottom right corner of a menu screen are the navigation keys for that particular menu. Use the navigation keys to select items in the menu and change the settings.



Some of the navigation keys differ from one screen to another.

## 5.2.4 Menu items

The highlighted item on the menu bar displays the specific items for that menu. For example, selecting **Main** shows the Main menu items.

The other items (Advanced, Power, Boot, and Exit) on the menu bar have their respective menu items.

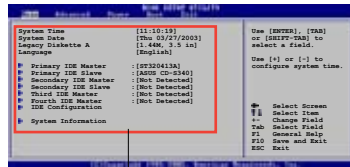

Main menu items

## 5.2.5 Sub-menu items

A solid triangle before each item on any menu screen means that the item has a sub-menu. To display the sub-menu, select the item and press <Enter>.

## 5.2.6 Configuration fields

These fields show the values for the menu items. If an item is user-configurable, you can change the value of the field opposite the item. You cannot select an item that is not user-configurable.

A configurable field is enclosed in brackets, and is highlighted when selected. To change the value of a field, select it then press <Enter> to display a list of options. Refer to “5.2.7 Pop-up window.”

## 5.2.7 Pop-up window

Select a menu item then press <Enter> to display a pop-up window with the configuration options for that item.

## 5.2.8 Scroll bar

A scroll bar appears on the right side of a menu screen when there are items that do not fit on the screen. Press the Up/Down arrow keys or <Page Up> /<Page Down> keys to display the other items on the screen.

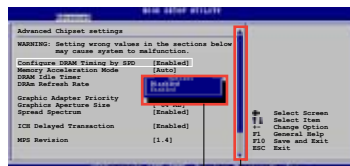

Pop-up window

Scroll bar

## 5.2.9 General help

At the top right corner of the menu screen is a brief description of the selected item.

## 5.3 Main menu

When you enter the BIOS Setup program, the Main menu screen appears, giving you an overview of the basic system information.



Refer to section “5.2.1 BIOS menu screen” for information on the menu screen items and how to navigate through them.

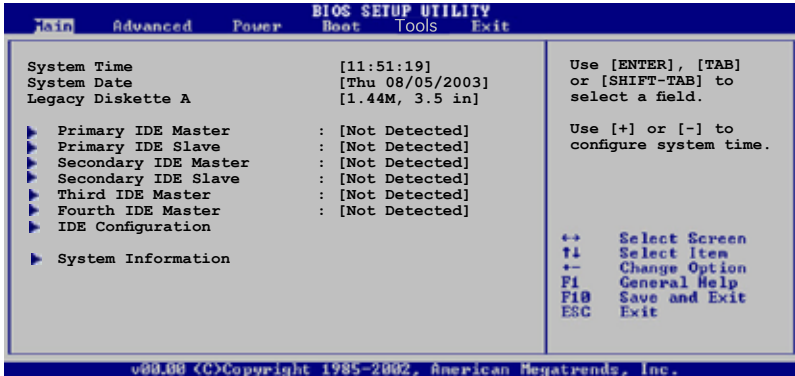

### 5.3.1 System Time [xx:xx:xxxx]

Allows you to set the system time.

### 5.3.2 System Date [Day xx/xx/xxxx]

Allows you to set the system date.

### 5.3.3 Legacy Diskette A [1.44M, 3.5 in.]

Sets the type of floppy drive installed. Configuration options: [Disabled] [360K, 5.25 in.] [1.2M , 5.25 in.] [720K , 3.5 in.] [1.44M, 3.5 in.] [2.88M, 3.5 in.]

### 5.3.4 Primary and Secondary IDE Master/Slave

While entering Setup, the BIOS automatically detects the presence of IDE devices. There is a separate sub-menu for each IDE device. Select a device item then press <Enter> to display the IDE device information.

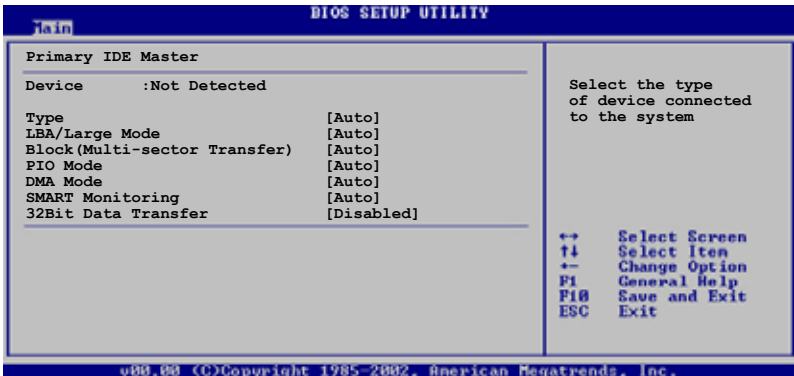

The values opposite the dimmed items (Device, Vendor, Size, LBA Mode, Block Mode, PIO Mode, Async DMA, Ultra DMA, and SMART monitoring) are auto-detected by BIOS and are not user-configurable. These items show N/A if no IDE device is installed in the system.

#### Type [Auto]

Selects the type of IDE drive. Setting to Auto allows automatic selection of the appropriate IDE device type. Select CDROM if you are specifically configuring a CD-ROM drive. Select ARMD (ATAPI Removable Media Device) if your device is either a ZIP, LS-120, or MO drive. Configuration options: [Not Installed] [Auto] [CDROM] [ARMD]

#### LBA/Large Mode [Auto]

Enables or disables the LBA mode. Setting to Auto enables the LBA mode if the device supports this mode, and if the device was not previously formatted with LBA mode disabled. Configuration options: [Disabled] [Auto]

#### Block (Multi-sector Transfer) [Auto]

Enables or disables data multi-sectors transfers. When set to Auto, the data transfer from and to the device occurs multiple sectors at a time if the device supports multi-sector transfer feature. When set to [Disabled], the data transfer from and to the device occurs one sector at a time. Configuration options: [Disabled] [Auto]

## PIO Mode [Auto]

Selects the PIO mode.

Configuration options: [Auto] [0] [1] [2] [3] [4]

## DMA Mode [Auto]

Selects the DMA mode. Configuration options: [Auto] [SWDMA0]

[SWDMA1] [SWDMA2] [MWDMA0] [MWDMA1] [MWDMA2] [UDMA0]

[UDMA1] [UDMA2] [UDMA3] [UDMA4] [UDMA5]

## SMART Monitoring [Auto]

Sets the Smart Monitoring, Analysis, and Reporting Technology.

Configuration options: [Auto] [Disabled] [Enabled]

## 32Bit Data Transfer [Disabled]

Enables or disables 32-bit data transfer.

Configuration options: [Disabled] [Enabled]

## 5.3.5 System Information

This menu gives you an overview of the general system specifications. The BIOS automatically detects the items in this menu.

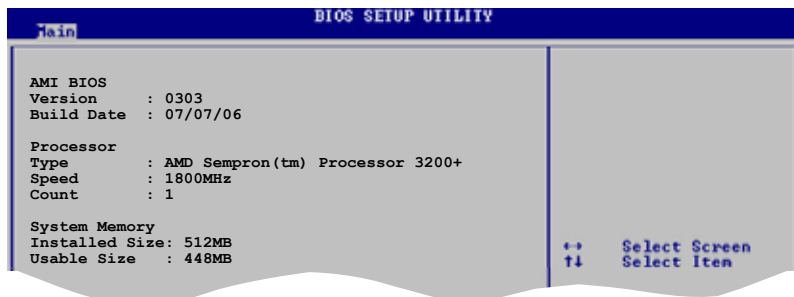

### AMI BIOS

Displays the auto-detected BIOS information

### Processor

Displays the auto-detected CPU specification

### System Memory

Displays the auto-detected system memory



## 5.4 Advanced menu

The Advanced menu items allow you to change the settings for the CPU and other system devices.



Take caution when changing the settings of the Advanced menu items. Incorrect field values can cause the system to malfunction.

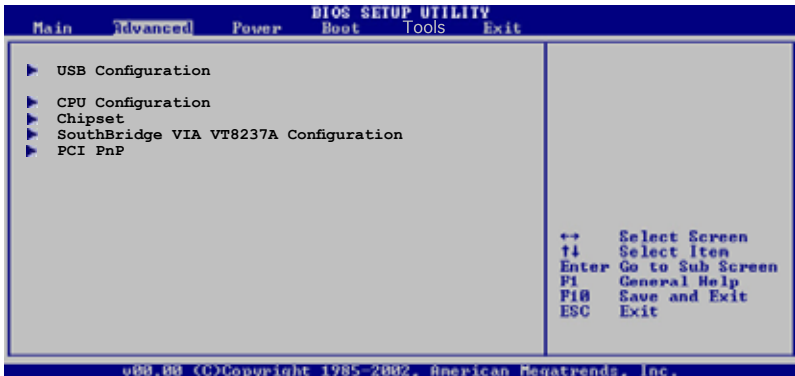

### 5.4.1 USB Configuration

The items in this menu allows you to change the USB-related features. Select an item then press <Enter> to display the configuration options.

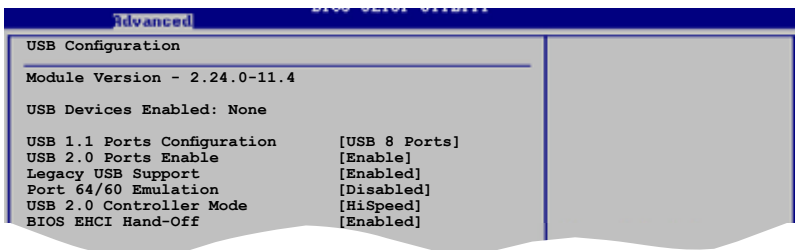

The Module Version and USB Devices Enabled items show the auto-detected values. If no USB device is detected, the item shows None.

### USB 1.1 Ports Configuration [USB 8 Ports]

Allows you to configure the USB ports.

Configuration options: [Disabled] [USB 2 Ports] [USB 4 Ports] [USB 6 Ports] [USB 8 Ports]

### USB 2.0 Ports Enable [Enable]

Allows you to enable or disable the USB 2.0 ports.

Configuration options: [Disabled] [Enable]

## Legacy USB Support [Enabled]

Allows you to enable or disable support for USB devices on legacy operating systems (OS). Setting to Auto allows the system to detect the presence of USB devices at startup. If detected, the USB controller legacy mode is enabled. If no USB device is detected, the legacy USB support is disabled. Configuration options: [Disabled] [Enabled] [Auto]

## Port 64/60 Emulation [Enabled]

Allows you to enable or disable the Port 64/60 Emulation. Configuration options: [Disabled] [Enabled].

## USB 2.0 Controller Mode [HiSpeed]

Allows you to configure the USB 2.0 controller in HiSpeed (480 Mbps) or Full Speed (12 Mbps). Configuration options: [HiSpeed] [Full Speed]

## BIOS EHCI Hand-Off [Enabled]

Allows you to enable or disable the BIOS EHCI hand-off support. Configuration options: [Disabled] [Enabled]

## 5.4.2 CPU Configuration

The items in this menu show the CPU-related information that the BIOS automatically detects.

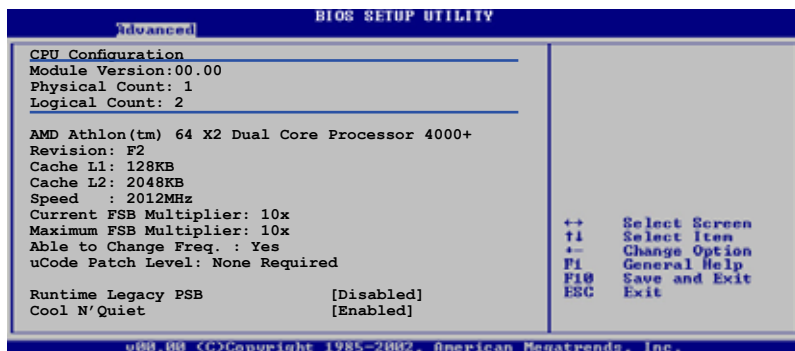

## Runtime Legacy PSB [Disabled]

Enables or disables the Hardware Prefetcher feature. Configuration options: [Disabled] [Enabled]

## Cool N'Quiet [Enabled]

Enables or disables the AMD Cool 'n' Quiet! technology feature. Configuration options: [Disabled] [Enabled]

## 5.4.3 Chipset

The Chipset menu allows you to change the advanced chipset settings. Select an item then press <Enter> to display the sub-menu.

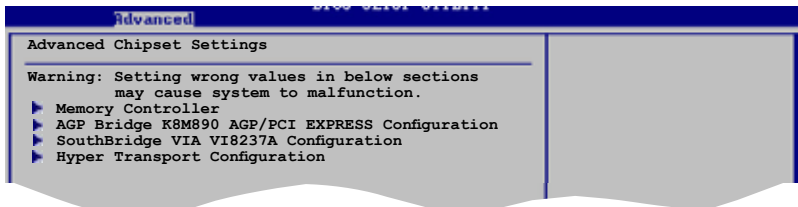

### NorthBridge Configuration

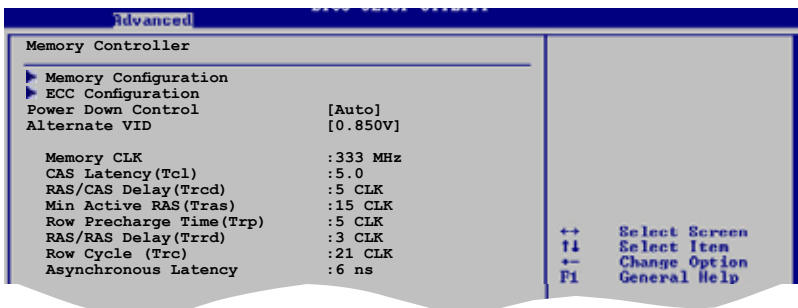

### Memory Configuration

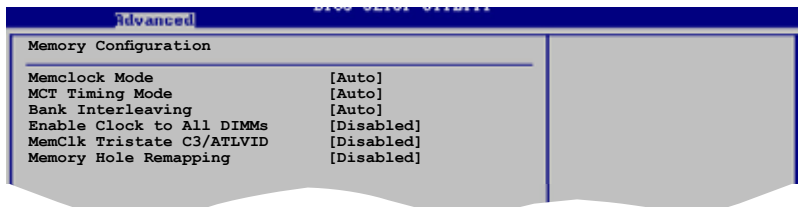

#### *Memclock Mode [Auto]*

Allows you to set the memory clock mode. Set by the code using [Auto] or select [Manual] to set using one of the standard values.

Configuration options: [Auto] [Manual] [Limit]

### MCT Timing Mode [Auto]

Appears only when the Parallel Port Mode is set to [ECP]. This item allows you to set the Parallel Port ECP DMA.

Configuration options: [DMA0] [DMA1] [DMA3]

### Bank Interleaving [Auto]

Sets whether to allow memory accesses to be spread out over BANKS on the same node or across nodes, decreasing access contention.

Configuration options: [Disabled] [Enabled]

### Enable Clock to All DIMMs [Disabled]

Allows you to enable or disable clock to all DIMMs.

Configuration options: [Disabled] [Enabled]

### MemClk Tristate C3/ATLVID [Disabled]

Allows you to enable or disable the MemCLK Tri-Stating During C3 and Alt VID. Configuration options: [Disabled] [Enabled]

### Memory Hole Remapping [Disabled]

Allows you to enable or disable Memory Remapping around the memory hole. Configuration options: [Disabled] [Enabled]

## ECC Configuration

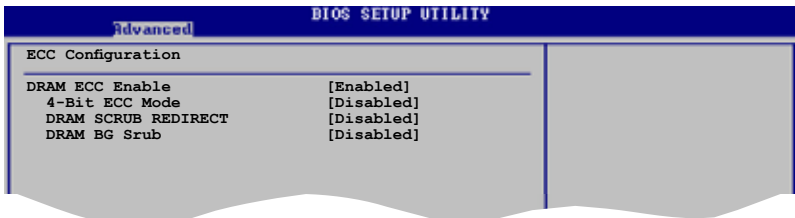

### DRAM ECC Enable [Disabled]

Enables or disables the DRAM ECC that allows hardware to report and correct memory errors automatically to maintain system integrity.

Configuration options: [Disabled] [Enabled]



---

The following item appears only when the **DRAM ECC** item is set to [Enabled].

---

#### 4-Bit ECC Mode [Disabled]

Enables or disables the 4-Bit ECC mode.  
Configuration options: [Disabled] [Enabled]

#### DRAM SCRUB REDIRECT [Disabled]

Sets the system to correct DRAM ECC Errors immediately when they occur, even if background scrubbing is on. Configuration options:  
[Disabled] [Enabled]

#### DRAM BG Scrub [Disabled]

Disables or sets the DRAM scrubbing functionality that corrects and rewrites memory errors so later reads are correct. During this while the memory is not being used improves performance. Configuration options:  
[Disabled] [40ns] [80ns] [160ns] [320ns] [640ns] [1.28us] [2.56us]  
[5.12us] [10.2us] [20.5us] [41.0us] [81.9us] [163.8us] [327.7us]  
[655.4us]

### **Power Down Control [Auto]**

Allows DIMMs to enter power down mode by deasserting the clock enable signal when DIMMs are not in use. Configuration options: [Auto] [Disabled]

### **Alternate VID [0.850V]**

Specifies the alternate VID while in low power states.  
Configuration options: [1.050V] [1.025V] [1.000V] [0.975V] [0.950V]  
[0.925V] [0.900V] [0.875V] [0.850V] [0.825V] [0.800V]

## AGP Bridge K8M890 AGP/PCI EXPRESS Configuration

Advanced		BIOS SETUP UTILITY	
OnChip VGA Frame Buffer Size	[64MB]		
Primary Graphics Adapter	[PCIE VGA]		
VLink Mode Supported	[Auto]		
AGP Mode	[AGP 8X]		
Graphics Aperture Size	[128MB]		

### OnChip VGA Frame Buffer Size [64MB]

Sets the onchip VGA frame buffer size. Configuration options: [64MB] [128MB] [256MB]

### Primary Graphics Adapter [PCIE VGA]

Switches the PCI Bus scanning order while searching for a video card. This allows you to select the type of Primary VGA in case of multiple video controllers. Configuration options: [PCI] [PCIE VGA] [Integrated VGA]

### VLink Mode Supported [Auto]

Sets the VLink 8X support. Configuration options: [Auto] [Mode 0] [Mode 1] [Mode 2] [Mode 3] [Mode 4]

### AGP Mode [8X]

Allows you to change the AGP mode for the onboard VGA. Configuration options: [AGP 8X] [AGP 4X]

### Graphics Aperture Size [128MB]

Allows you to select the size of mapped memory for onboard VGA graphic data. Configuration options: [32MB] [64MB] [128MB] [256MB]

## Hyper Transport AGP

Advanced		BIOS SETUP UTILITY	
Hyper Transport AGP Configuration			
(K8/NPT) to (AGP) Freq Auto	[Enabled]		

### Hyper Transport AGP Configuration [Enabled]

Allows you to enable or disable the K8/NPT to AGP frequency selection by CPU capability. Configuration options: [Enabled] [Disabled]

## 5.4.4 SouthBridge VIA VT8237A Configuration

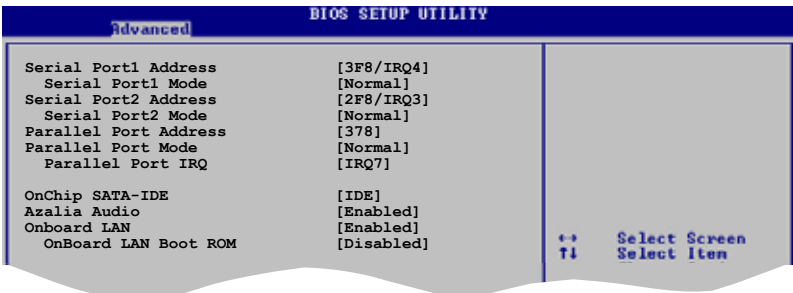

### Serial Port1 Address [3F8/IRQ4]

Allows you to select the Serial Port1 base address.

Configuration options: [Disabled] [3F8/IRQ4] [3E8/IRQ4] [2E8/IRQ3]

### Serial Port1 Mode [Normal]

Allows you to select the Serial Port1 mode.

Configuration options: [Normal] [IrDA] [ASK IR]

### Serial Port2 Address [2F8/IRQ3]

Allows you to select the Serial Port1 base address.

Configuration options: [Disabled] [2F8/IRQ3] [3E8/IRQ4] [2E8/IRQ3]

### Serial Port2 Mode [Normal]

Allows you to select the Serial Port2 mode.

Configuration options: [Normal] [IrDA] [ASK IR]

## Parallel Port Address [378]

Allows you to select the Parallel Port base addresses.

Configuration options: [Disabled] [378] [278] [3BC]

## Parallel Port Mode [Normal]

Allows you to select the Parallel Port mode.

Configuration options: [Normal] [EPP] [ECP] [EPP+ECP]

### ECP Mode DMA Channel [DMA3]

Allows you to select the Parallel Port ECP DMA.

Configuration options: [DMA0] [DMA1] [DMA3]

## Parallel Port IRQ [IRQ7]

Allows you to select the Parallel Port IRQ.

Configuration options: [IRQ5] [IRQ7]

## OnChip SATA-IDE [IDE]

Allows you to disable or set the onchip SATA-IDE.

Configuration options: [Disabled] [IDE] [RAID]

## Azalia Audio [Enabled]

Enables or disables the Azalia audio controller.

Configuration options: [Enabled] [Disabled]

## Onboard LAN [Enabled]

Enables or disables the onboard LAN controller.

Configuration options: [Enabled] [Disabled]

## Onboard LAN Boot ROM [Disabled]

Enables or disables the onboard LAN Boot ROM.

Configuration options: [Enabled] [Disabled]

## 5.4.5 PCI PnP

The PCI PnP menu items allow you to change the advanced settings for PCI/PnP devices. The menu includes setting IRQ and DMA channel resources for either PCI/PnP or legacy ISA devices, and setting the memory size block for legacy ISA devices.



Take caution when changing the settings of the PCI PnP menu items. Incorrect field values can cause the system to malfunction.

---





### Plug and Play O/S [No]

When set to [No], BIOS configures all the devices in the system. When set to [Yes] and if you install a Plug and Play operating system, the operating system configures the Plug and Play devices not required for boot. Configuration options: [No] [Yes]

### PCI Latency Timer [64]

Allows you to select the value in units of PCI clocks for the PCI device latency timer register. Configuration options: [32] [64] [96] [128] [160] [192] [224] [248]

### Allocate IRQ to PCI VGA [Yes]

When set to [Yes], BIOS assigns an IRQ to PCI VGA card if the card requests for an IRQ. When set to [No], BIOS does not assign an IRQ to the PCI VGA card even if requested. Configuration options: [No] [Yes]

### Palette Snooping [Disabled]

When set to [Enabled], the palette snooping feature informs the PCI devices that an ISA graphics device is installed in the system so that the latter can function correctly. Configuration options: [Disabled] [Enabled]

### IRQ xx [Available]

When set to [Available], the specific IRQ is free for PCI/PnP devices to use. When set to [Reserved], the IRQ is reserved for legacy ISA devices. Configuration options: [Available] [Reserved]

## 5.5 Power menu

The Power menu items allow you to change the settings for the Advanced Configuration and Power Interface (ACPI) and the Advanced Power Management (APM). Select an item then press <Enter> to display the configuration options.

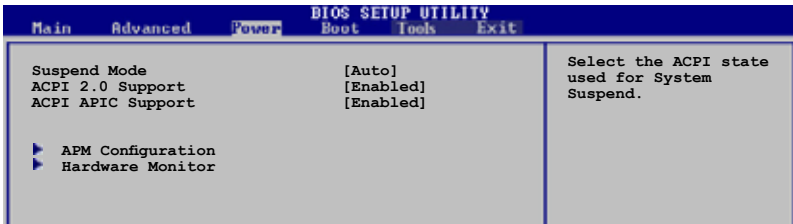

### 5.5.1 Suspend Mode [Auto]

Allows you to select the Advanced Configuration and Power Interface (ACPI) state to be used for system suspend. Configuration options: [S1(POS) Only] [S3 Only] [Auto]

### 5.5.2 ACPI 2.0 Support [Enabled]

Allows you to add more tables for Advanced Configuration and Power Interface (ACPI) 2.0 specifications. Configuration options: [Disabled] [Enabled]

### 5.5.3 ACPI APIC Support [Enabled]

Allows you to enable or disable the Advanced Configuration and Power Interface (ACPI) support in the Application-Specific Integrated Circuit (ASIC). When set to Enabled, the ACPI APIC table pointer is included in the RSDT pointer list. Configuration options: [Disabled] [Enabled]

### 5.5.4 APM Configuration

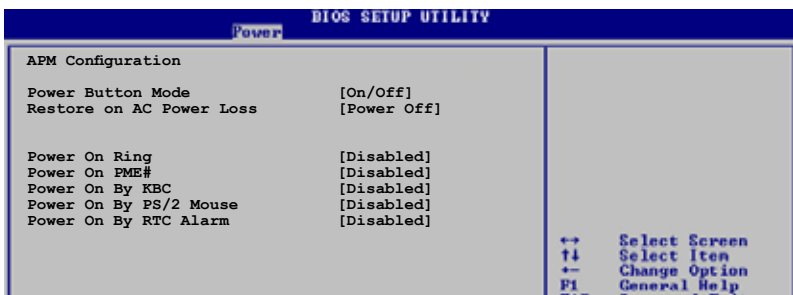

## Power Button Mode [On/Off]

Allows the system to go into On/Off mode or suspend mode when the power button is pressed. Configuration options: [On/Off] [Suspend]

## Restore on AC Power Loss [Power Off]

When set to Power Off, the system goes into off state after an AC power loss. When set to Power On, the system goes on after an AC power loss. When set to Last State, the system goes into either off or on state, whatever the system state was before the AC power loss. Configuration options: [Power Off] [Power On] [Last State]

## Power On Ring [Disabled]

Allows either settings of [Enabled] or [Disabled] for powering up the computer when the external modem receives a call while the computer is in Soft-off mode. Configuration options: [Disabled] [Enabled]



---

The computer cannot receive or transmit data until the computer and applications are fully running. Thus, connection cannot be made on the first try. Turning an external modem off and then back on while the computer is off causes an initialization string that turns the system power on.

---

## Power On PME# [Disabled]

Allows you to enable or disable the PME#-wake up feature. Configuration options: [Disabled] [Enabled]

## Power On By KBC [Disabled]

Allows you to enable or disable the keyboard wake-up feature. This feature requires an ATX power supply that provides at least 1A on the +5VSB lead. Configuration options: [Disabled] [Enabled]

## Power On By PS/2 Mouse [Disabled]

When set to [Enabled], this parameter allows you to use the PS/2 mouse to turn on the system. This feature requires an ATX power supply that provides at least 1A on the +5VSB lead. Configuration options: [Disabled] [Enabled]

## Power On By RTC Alarm [Disabled]

Allows you to enable or disable RTC to generate a wake event. When this item is set to Enabled, the items RTC Alarm Date, RTC Alarm Hour, RTC Alarm Minute, and RTC Alarm Second appear with set values. This feature requires an ATX power supply that provides at least 1A on the +5VSB lead. Configuration options: [Disabled] [Enabled]

## 5.5.5 Hardware Monitor

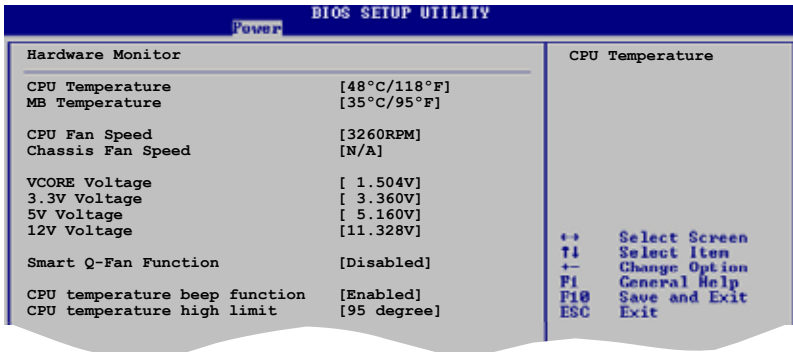

### CPU Temperature [xxx°C/xxx°F]

### MB Temperature [xxx°C/xxx°F]

The onboard hardware monitor automatically detects and displays the motherboard and CPU temperatures. Select Ignored if you do not wish to display the detected temperatures.

### CPU Fan Speed [xxxxRPM] or [N/A]

### Chassis Fan Speed [xxxxRPM] or [N/A]

The onboard hardware monitor automatically detects and displays the CPU and chassis fan speeds in rotations per minute (RPM). If any of the fans is not connected to the motherboard, the specific field shows N/A.

### VCORE Voltage, +3.3V Voltage, +5V Voltage, +12V Voltage

The onboard hardware monitor automatically detects the voltage output through the onboard voltage regulators.

### Smart Q-Fan function [Disabled]

Allows you to enable or disable the smart Q-fan control function. When this field is set to [Enabled], the item Fan Auto Mode Start Speed, Fan Auto Mode Start Speed Temp, and Fan Auto Mode Full Speed Temp items appear. Configuration options: [Disabled] [Enabled]

### Fan Auto Mode Start Speed [40%]

Sets the fan auto mode start speed. Configuration options: [20%] [40%] [60%] [80%]

### Fan Auto Mode Start Speed Temp [25°C]

Sets the fan auto mode start speed temperature. Configuration options: [25°C] [26°C] - [50°C]

## Fan Auto Mode Full Speed Temp [55°C]

Sets the fan auto mode full speed temperature.  
Configuration options: [55°C] [56°C] - [75°C]

## CPU temperature beep function [Enabled]

Enables or disables the CPU temperature beep function.  
Configuration options: [Enabled] [Disabled]

## CPU temperature high limit [95 degree]

Disables or sets the CPU temperature high limit.  
Configuration options: [Disabled] [95 Degree] [85 Degree] [75 Degree] [65 Degree]

## 5.6 Boot menu

The Boot menu items allow you to change the system boot options. Select an item then press <Enter> to display the sub-menu.

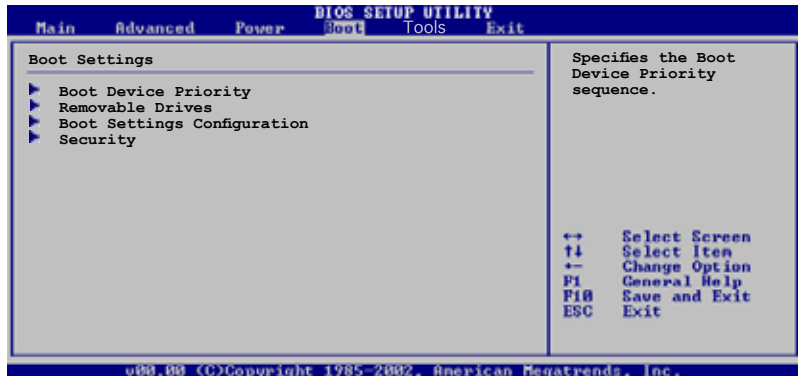

### 5.6.1 Boot Device Priority

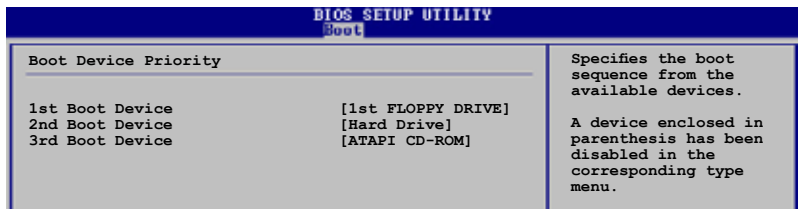

### 1st ~ xxth Boot Device [1st Floppy Drive]

These items specify the boot device priority sequence from the available devices. The number of device items that appear on the screen depends on the the number of devices installed in the system.

Configuration options: [xxxxx Drive] [Disabled]

## 5.6.2 Boot Settings Configuration

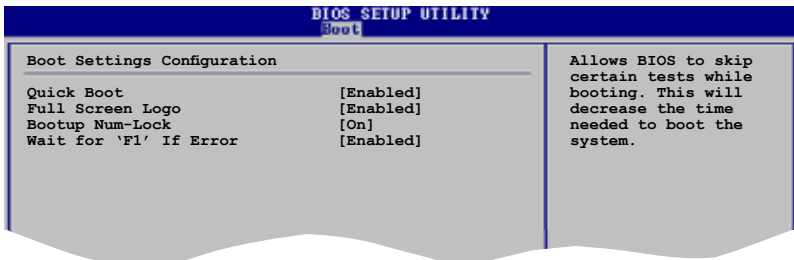

### Quick Boot [Enabled]

Enabling this item allows the BIOS to skip some power on self tests (POST) while booting to decrease the time needed to boot the system. When set to [Disabled], BIOS performs all the POST items.

Configuration options: [Disabled] [Enabled]

### Full Screen Logo [Enabled]

This allows you to enable or disable the full screen logo display feature.

Configuration options: [Disabled] [Enabled]



---

Set this item to [Enabled] to use the ASUS MyLogo2™ feature.

---

### Bootup Num-Lock [On]

Allows you to select the power-on state for the NumLock.

Configuration options: [Off] [On]

### Wait for 'F1' If Error [Enabled]

When set to Enabled, the system waits for the F1 key to be pressed when error occurs. Configuration options: [Disabled] [Enabled]

## 5.6.3 Security

The Security menu items allow you to change the system security settings. Select an item then press <Enter> to display the configuration options.

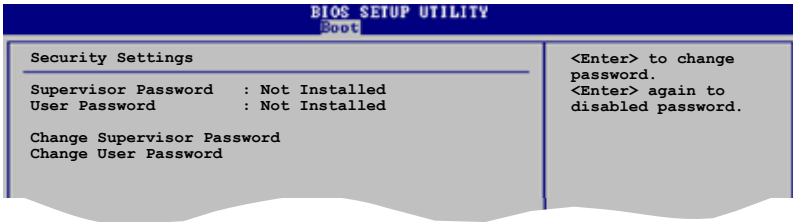

### Change Supervisor Password

Select this item to set or change the supervisor password. The Supervisor Password item on top of the screen shows the default **Not Installed**. After you set a password, this item shows **Installed**.

To set a Supervisor Password:

1. Select the Change Supervisor Password item and press <Enter>.
2. From the password box, type a password composed of at least six letters and/or numbers, then press <Enter>.
3. Confirm the password when prompted.

The message "Password Installed" appears after you successfully set your password.

To change the supervisor password, follow the same steps as in setting a user password.

To clear the supervisor password, select the Change Supervisor Password then press <Enter>. The message "Password Uninstalled" appears.



If you forget your BIOS password, you can clear it by erasing the CMOS Real Time Clock (RTC) RAM. See section "4.3 Jumpers" for information on how to erase the RTC RAM.

After you have set a supervisor password, the other items appear to allow you to change other security settings.

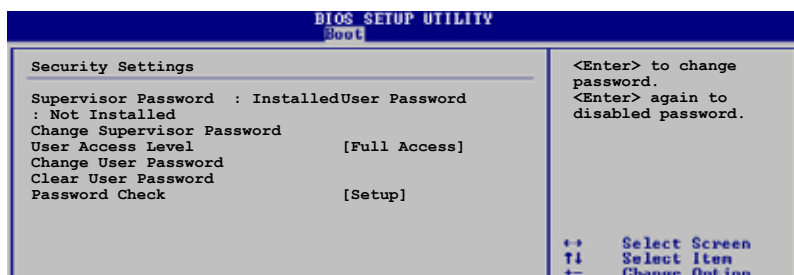

## User Access Level [Full Access]

This item allows you to select the access restriction to the Setup items. Configuration options: [No Access] [View Only] [Limited] [Full Access]

**No Access** prevents user access to the Setup utility.

**View Only** allows access but does not allow change to any field.

**Limited** allows changes only to selected fields, such as Date and Time.

**Full Access** allows viewing and changing all the fields in the Setup utility.

## Change User Password

Select this item to set or change the user password. The User Password item on top of the screen shows the default **Not Installed**. After you set a password, this item shows **Installed**.

To set a User Password:

1. Select the Change User Password item and press <Enter>.
2. On the password box that appears, type a password composed of at least six letters and/or numbers, then press <Enter>.
3. Confirm the password when prompted.

The message "Password Installed" appears after you set your password successfully.

To change the user password, follow the same steps as in setting a user password.

## Change User Password

Select this item to set or change the user password.



## Password Check [Setup]

When set to [Setup], BIOS checks for user password when accessing the Setup utility. When set to [Always], BIOS checks for user password both when accessing Setup and booting the system.  
Configuration options: [Setup] [Always]

## 5.7 Exit menu

The Exit menu items allow you to load the optimal or failsafe default values for the BIOS items, and save or discard your changes to the BIOS items.



Pressing <Esc> does not immediately exit this menu. Select one of the options from this menu or <F10> from the legend bar to exit.

### Exit & Save Changes

Once you are finished making your selections, choose this option from the Exit menu to ensure the values you selected are saved to the CMOS RAM. An onboard backup battery sustains the CMOS RAM so it stays on even when the PC is turned off. When you select this option, a confirmation window appears. Select **OK** to save changes and exit.



If you attempt to exit the Setup program without saving your changes, the program prompts you with a message asking if you want to save your changes before exiting. Press <Enter> to save the changes while exiting.

## **Exit & Discard Changes**

Select this option only if you do not want to save the changes that you made to the Setup program. If you made changes to fields other than System Date, System Time, and Password, the BIOS asks for a confirmation before exiting.

## **Discard Changes**

This option allows you to discard the selections you made and restore the previously saved values. After selecting this option, a confirmation appears. Select OK to discard any changes and load the previously saved values.

## **Load Setup Defaults**

This option allows you to load the default values for each of the parameters on the Setup menus. When you select this option or if you press <F5>, a confirmation window appears. Select OK to load default values. Select Exit & Save Changes or make other changes before saving the values to the non-volatile RAM.

## Free Manuals Download Website

<http://myh66.com>

<http://usermanuals.us>

<http://www.somanuals.com>

<http://www.4manuals.cc>

<http://www.manual-lib.com>

<http://www.404manual.com>

<http://www.luxmanual.com>

<http://aubethermostatmanual.com>

Golf course search by state

<http://golfingnear.com>

Email search by domain

<http://emailbydomain.com>

Auto manuals search

<http://auto.somanuals.com>

TV manuals search

<http://tv.somanuals.com>