

# **ASUS<sup>®</sup> AP1400R**

**Dual Pentium<sup>®</sup> III 1U Rackmount Server**

User's Manual



# Disclaimer/Copyrights

No part of this manual, including the products and software described in it, may be reproduced, transmitted, transcribed, stored in a retrieval system, or translated into any language in any form or by any means, except documentation kept by the purchaser for backup purposes, without the express written permission of ASUSTeK COMPUTER INC. ("ASUS").

ASUS PROVIDES THIS MANUAL "AS IS" WITHOUT WARRANTY OF ANY KIND, EITHER EXPRESS OR IMPLIED, INCLUDING BUT NOT LIMITED TO THE IMPLIED WARRANTIES OR CONDITIONS OF MERCHANTABILITY OR FITNESS FOR A PARTICULAR PURPOSE. IN NO EVENT SHALL ASUS, ITS DIRECTORS, OFFICERS, EMPLOYEES OR AGENTS BE LIABLE FOR ANY INDIRECT, SPECIAL, INCIDENTAL, OR CONSEQUENTIAL DAMAGES (INCLUDING DAMAGES FOR LOSS OF PROFITS, LOSS OF BUSINESS, LOSS OF USE OR DATA, INTERRUPTION OF BUSINESS AND THE LIKE), EVEN IF ASUS HAS BEEN ADVISED OF THE POSSIBILITY OF SUCH DAMAGES ARISING FROM ANY DEFECT OR ERROR IN THIS MANUAL OR PRODUCT.

Product warranty or service will not be extended if: (1) the product is repaired, modified or altered, unless such repair, modification or alteration is authorized in writing by ASUS; or (2) the serial number of the product is defaced or missing.

Products and corporate names appearing in this manual may or may not be registered trademarks or copyrights of their respective companies, and are used only for identification or explanation and to the owners' benefit, without intent to infringe.

The product name and revision number are both printed on the product itself. Manual revisions are released for each product design represented by the digit before and after the period of the manual revision number. Manual updates are represented by the third digit in the manual revision number.

For previous or updated manuals, BIOS, drivers, or product release information, contact ASUS at <http://www.asus.com.tw> or through any of the means indicated on the following page.

SPECIFICATIONS AND INFORMATION CONTAINED IN THIS MANUAL ARE FURNISHED FOR INFORMATIONAL USE ONLY, AND ARE SUBJECT TO CHANGE AT ANY TIME WITHOUT NOTICE, AND SHOULD NOT BE CONSTRUED AS A COMMITMENT BY ASUS. ASUS ASSUMES NO RESPONSIBILITY OR LIABILITY FOR ANY ERRORS OR INACCURACIES THAT MAY APPEAR IN THIS MANUAL, INCLUDING THE PRODUCTS AND SOFTWARE DESCRIBED IN IT.

**Copyright © 2001 ASUSTeK COMPUTER INC. All Rights Reserved.**

Product Name:	<b>AP1400R</b>
Manual Revision:	<b>1.00 E628</b>
Release Date:	<b>March 2001</b>

# ASUS Contact Information

## ASUSTeK COMPUTER INC. (Asia-Pacific)

### *Marketing*

Address: 150 Li-Te Road, Peitou, Taipei, Taiwan 112  
Telephone: +886-2-2894-3447  
Fax: +886-2-2894-3449  
Email: info@asus.com.tw

### *Technical Support*

Tel (English): +886-2-2890-7123  
Tel (Chinese): +886-2-2890-7113  
Fax: +886-2-2893-7775  
Email: tsd@asus.com.tw  
Newsgroup: news2.asus.com.tw  
WWW: www.asus.com.tw  
FTP: ftp.asus.com.tw/pub/ASUS

## ASUS COMPUTER INTERNATIONAL (America)

### *Marketing*

Address: 6737 Mowry Avenue, Mowry Business Center, Building 2  
Newark, CA 94560, USA  
Fax: +1-510-608-4555  
Email: info-usa@asus.com.tw

### *Technical Support*

Fax: +1-510-608-4555  
BBS: +1-510-739-3774  
Email: tsd@asus.com  
WWW: www.asus.com  
FTP: ftp.asus.com.tw/pub/ASUS

## ASUS COMPUTER GmbH (Europe)

### *Marketing*

Address: Harkortstr. 25, 40880 Ratingen, BRD, Germany  
Fax: +49-2102-442066  
Email: sales@asuscom.de (for marketing requests only)

### *Technical Support*

Hotline: MB/Others: +49-2102-9599-0  
Notebook: +49-2102-9599-10  
Fax: +49-2102-9599-11  
Support (Email): www.asuscom.de/de/support (for online support)  
WWW: www.asuscom.de  
FTP: ftp.asuscom.de/pub/ASUSCOM

# FCC/CDC Statements

## Federal Communications Commission Statement

This device complies with FCC Rules Part 15. Operation is subject to the following two conditions:

- This device may not cause harmful interference, and
- This device must accept any interference received including interference that may cause undesired operation.

This equipment has been tested and found to comply with the limits for a Class B digital device, pursuant to Part 15 of the FCC Rules. These limits are designed to provide reasonable protection against harmful interference in a residential installation. This equipment generates, uses and can radiate radio frequency energy and, if not installed and used in accordance with manufacturer's instructions, may cause harmful interference to radio communications. However, there is no guarantee that interference will not occur in a particular installation. If this equipment does cause harmful interference to radio or television reception, which can be determined by turning the equipment off and on, the user is encouraged to try to correct the interference by one or more of the following measures:

- Reorient or relocate the receiving antenna.
- Increase the separation between the equipment and receiver.
- Connect the equipment to an outlet on a circuit different from that to which the receiver is connected.
- Consult the dealer or an experienced radio/TV technician for help.

**WARNING!** The use of shielded cables for connection of the monitor to the graphics card is required to assure compliance with FCC regulations. Changes or modifications to this unit not expressly approved by the party responsible for compliance could void the user's authority to operate this equipment.

## Canadian Department of Communications Statement

This digital apparatus does not exceed the Class B limits for radio noise emissions from digital apparatus set out in the Radio Interference Regulations of the Canadian Department of Communications.

**This class B digital apparatus complies with Canadian ICES-003.**

# Safety Precautions

## *Safeguards*

Observe the following safety precautions when you are connecting or disconnecting any devices.

## *Operation Safety*



### **IMPORTANT**

- Any operation on this server must be conducted by certified or experienced engineers.
- Before operating your server, carefully read all the manuals included with the server package.
- Before using the server, make sure all cables are correctly connected and the power cables are not damaged. If any damage is detected, contact your dealer as soon as possible.
- To avoid short circuits, keep paper clips, screws, and staples away from connectors, slots, sockets and circuitry.
- Before opening the chassis panels, make sure all power cables are unplugged.
- Avoid dust, humidity, and temperature extremes. Place the server on a stable surface.
- If the power supply is broken, do not try to fix it by yourself. Contact an authorized dealer.
- It is recommended that you wear gloves when assembling or disassembling the server to protect from cuts and scrapes.
- When the server is powered on, heat sinks and the surfaces of certain IC devices may be hot. Do not touch them. Check whether the fans are functioning properly.

## *Tools Required*

You need a Philips (cross) screwdriver and a flat screwdriver to install or remove the components in the server.

# Safety Precautions

## Electrical Safety



### IMPORTANT

- Before installing or removing signal cables, ensure that the power cables for the system unit and all attached devices are unplugged.
- To prevent electrical shock hazard, disconnect the power cable from the electrical outlet before relocating the system.
- When adding or removing any additional devices to or from the system, ensure that the power cables for those devices are unplugged before the signal cables are connected. If possible, disconnect all power cables from the existing system before you add a device.
- Use one hand, when possible, to connect or disconnect signal cables to prevent a possible shock from touching two surfaces with different electrical potentials.



### CAUTION

This product is equipped with a three-wire power cable and plug for the user's safety. Use the power cable with a properly grounded electrical outlet to avoid electrical shock.



### IMPORTANT

Motherboards, adapters, and disk drives are sensitive to static electricity discharge. These devices are wrapped in antistatic bags to prevent this damage. Take the following precautions:

- If you have an antistatic wrist strap available, use it while handling the device.
- Do not remove the device from the antistatic bag until you are ready to install the device in the system unit.
- With the device still in its antistatic bag, touch it to a metal frame of the system.
- Grasp cards and boards by the edges. Hold drives by the frame. Avoid touching the solder joints or pins.
- If you need to lay the device down while it is out of the antistatic bag, lay it on the antistatic bag. Before picking it up again, touch the antistatic bag and the metal frame of the system unit at the same time.
- Handle the devices carefully to prevent permanent damage.

# Contents

<b>Introduction: About This Manual .....</b>	<b>9</b>
<b>Audience .....</b>	<b>10</b>
<b>Contents Description .....</b>	<b>10</b>
<b>Conventions .....</b>	<b>11</b>
Symbols .....	11
<b>Package Contents .....</b>	<b>12</b>
Standard Components .....	12
Optional Components .....	12
<b>Chapter 1: System Overview .....</b>	<b>13</b>
<b>Features .....</b>	<b>14</b>
Chassis: ASUS AR-10 .....	14
Motherboard: ASUS CUR-DLSR .....	14
<b>Front Panel .....</b>	<b>15</b>
<b>Back Panel .....</b>	<b>15</b>
<b>Power Button and System LEDs .....</b>	<b>16</b>
LED Information .....	16
<b>Chapter 2: Basic Operation .....</b>	<b>17</b>
<b>Getting Started .....</b>	<b>18</b>
Monitor Connection .....	18
Power Connection .....	18
Power ON .....	18
Check LED .....	18
<b>Chapter 3: Hardware Setup .....</b>	<b>19</b>
<b>Opening the Chassis .....</b>	<b>20</b>
Unlocking the Cover .....	20
Removing the Cover .....	21
<b>Internal Components .....</b>	<b>22</b>
<b>Motherboard Placement .....</b>	<b>23</b>
Placement Direction .....	23
Motherboard Screws .....	23
<b>Central Processing Unit (CPU) .....</b>	<b>24</b>
CPU Orientation .....	24
CPU Socket Locations .....	24
CPU Installation .....	25
<b>CPU Heatsink .....</b>	<b>26</b>
Attaching the Heatsink Front Clip .....	26
Attaching the Heatsink Back Clip .....	26

# Contents

<b>CPU Terminator</b> .....	<b>27</b>
<b>CPU Fan Cable</b> .....	<b>27</b>
Connecting the Fan Cable .....	27
<b>CPU Blower and Tube</b> .....	<b>28</b>
CPU Blower and Tube Location .....	28
<b>Cooling Fans</b> .....	<b>29</b>
<b>System Memory</b> .....	<b>29</b>
DIMM Sockets Location .....	29
DIMM Installation .....	30
<b>Riser Card / Expansion Card</b> .....	<b>31</b>
Installing an Expansion Card .....	31
Securing the Expansion Card .....	32
Securing an Extended PCI Card .....	32
<b>SCSI Backplane</b> .....	<b>33</b>
Front Side .....	33
Back Side .....	33
<b>Connecting Cables</b> .....	<b>34</b>
SCSI Cable .....	34
IDE Cable .....	34
Floppy Cable .....	35
LED Cable .....	35
Power Cables .....	36
Cooling Fan Cables .....	36
<b>CD-ROM Drive</b> .....	<b>37</b>
CD-ROM Mounting .....	37
CD-ROM Adapter Board .....	38
CD-ROM Installation .....	38
<b>Floppy Drive</b> .....	<b>39</b>
Floppy Drive Mounting .....	39
Floppy Drive Installation .....	39
<b>SCSI Hard Disk Drives</b> .....	<b>40</b>
Hot-Swap Drive Tray .....	40
SCSI HDD Mounting .....	40
HDD Installation .....	41
<b>System Power Supply</b> .....	<b>42</b>
<b>Power Supply Specifications</b> .....	<b>43</b>
Output Voltage Regulation .....	43
Output Current Capacity .....	43
Over-Voltage Protection (OVP) .....	43



# Introduction

You are reading the AP1400R Server User's Manual. This manual provides general and specific information about the AP1400R server.

“About This Manual” contains an introduction on the contents of this document that include target audience, chapter description, and conventions used. It also lists the items included in the system package.

# About This Manual

# Audience

This manual is intended for experienced users and integrators with hardware knowledge of personal computers.

## Contents Description

This manual contains the following parts:

### **1. Introduction: About This Manual**

This part contains an introduction on the contents of this document that include target audience, chapter description, and conventions used. It also lists the items included in the system package.

### **2. Chapter 1: System Overview**

This chapter describes the external features of the AP1400R server. It includes specific sections that identify these features.

### **3. Chapter 2: Basic Operation**

This chapter tells how to get started with the AP1400R server. The basic operation includes connecting the cables and powering on the system.

### **4. Chapter 3: Hardware Setup**

This chapter describes the hardware setup procedures that you have to perform when installing system components. It also gives detailed information on the internal components and how to install them.

# Conventions

## *Symbols*

To make sure that you perform certain tasks properly, take note of the following symbols used throughout this guide.



**WARNING:** Information to prevent injury to yourself when trying to complete a task.



**CAUTION:** Information to prevent damage to the components when trying to complete a task.



**IMPORTANT:** Information that you **MUST** follow to complete a task.



**NOTE:** Tips and information to aid in completing a task.



**PHILIPS (CROSS) SCREW DRIVER:** A tool required to install or remove the components in the server.



**STANDARD (FLAT) SCREW DRIVER:** A tool required to install or remove the components in the server.



**STEP:** Actions to complete a task.

# Package Contents

This section lists the items included in the server package.

## *Standard Components*

<input checked="" type="checkbox"/>	Motherboard	CUR-DLSR
<input checked="" type="checkbox"/>	Chassis	AR-10 1U Rackmount
<input checked="" type="checkbox"/>	Power Supply	200W
<input checked="" type="checkbox"/>	Processor (CPU)	Pentium® III up to 1GHz
<input checked="" type="checkbox"/>	Memory Modules	64, 128, 256, 512MB, 1GB SDRAM
<input checked="" type="checkbox"/>	Hard Drive	80-pin SCA-2 Ultra160 SCSI interface
<input checked="" type="checkbox"/>	Floppy Drive	Slim-type 1.44MB
<input checked="" type="checkbox"/>	CD-ROM Drive	Slim-type 24X
<input checked="" type="checkbox"/>	PCI Riser Card	64-bit/33MHz PCI slot
<input checked="" type="checkbox"/>	SCSI Cable	
<input checked="" type="checkbox"/>	S370 CPU Terminator	
<input checked="" type="checkbox"/>	Rackmount Rails	AR-10 rail kit
<input checked="" type="checkbox"/>	User's Manuals	CD-ROM, motherboard

## *Optional Components*

<input type="checkbox"/>	RAID Controller	ASUS PCI-DA2200 RAID controller
--------------------------	-----------------	---------------------------------

# Chapter 1

This chapter describes the external features of the AP1400R server. It includes specific sections that identify these features.

# System Overview

# Features

The AP1400R is configured for the ASUS CUR-DLSR smart motherboard that uses the ServerSet™ chipset from ServerWorks®. The motherboard supports dual Pentium III processors to accelerate even the most complicated server tasks. The following are highlights to the server's many features. For additional information, refer to the CUR-DLSR User's Manual.

## *Chassis: ASUS AR-10*

- **Chassis:** 1U form factor that fits in a standard 19" rack
- **SCSI Backplane:** Supports three SCSI hard drives using 80-pin SCA-2 connectors
- **Power:** Pinot 200W single power supply equipped with universal AC input and ATX-compliant output cables
- **Device Bays:** Support for one 3.5-inch slim type floppy device, one 5.25-inch slim type CD-ROM drive, and three 3.5-inch wide 1-inch high hot-swappable SCA SCSI hard disk drives in removable trays

## *Motherboard: ASUS CUR-DLSR*

- **Processor:** Dual Intel® Pentium III FC-PGA processors running up to 1GHz
- **Memory:** Four 168-pin DIMM sockets that support up to 4GB PC133 registered SDRAM with ECC support
- **Onboard SCSI:** LSI® 53C1010-33 dual-channel Ultra160 SCSI controller that supports up to 30 SCSI devices using two 68-pin Wide SCSI connectors
- **Onboard LAN:** Dual Intel® 82559 Fast-Ethernet server controllers that supports 10BASE-T and 100BASE-TX, RJ-45 output
- **Onboard VGA:** ATI® Rage XL VGA controller with 4MB PC100 SDRAM
- **Integrated Super I/O:** PC97317 controller that supports one floppy drive, two serial ports, one printer port, two USB ports, one PS/2 keyboard, and one PS/2 mouse
- **Expansion Slot:** One full-length 64-bit/33MHz PCI slot on riser card

# Front Panel

The front panel of the AP1400R server allows easy access to the floppy, CD-ROM, and removable hard disk drives. The power button and the system LED indicators are also located on the front panel (see next page for descriptions).

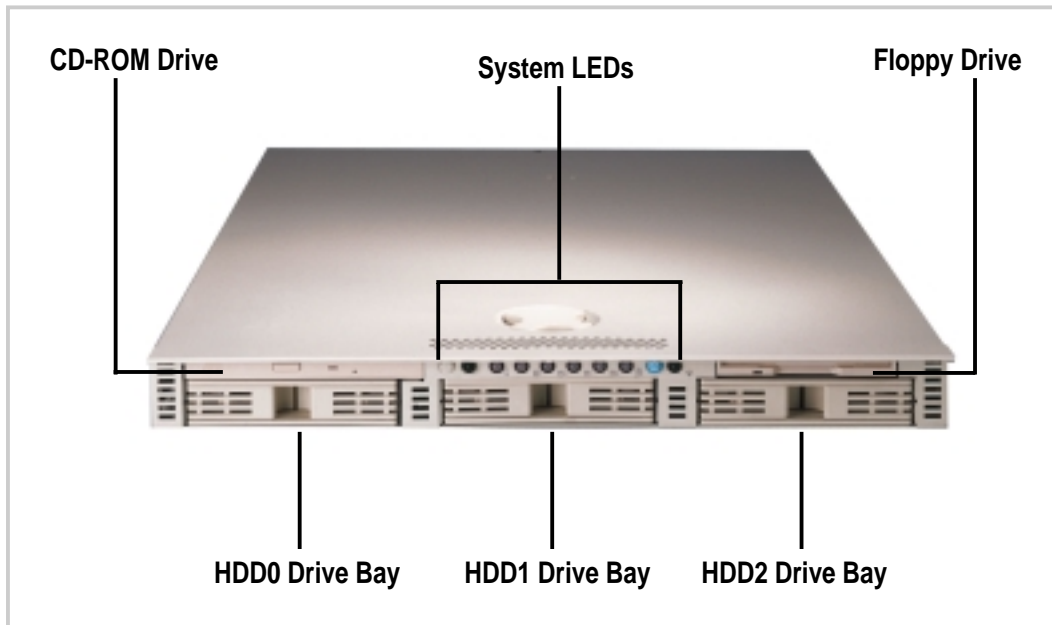

# Back Panel

The server back panel includes the connectors the system devices and a slot for an expansion card.

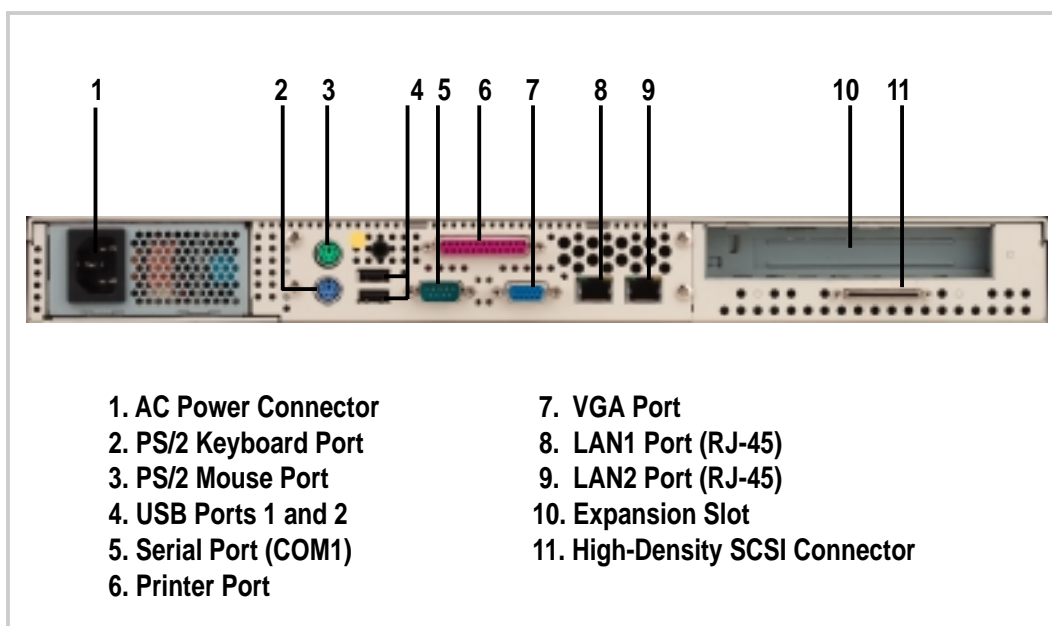

# Power Button and System LEDs

The chassis includes system LEDs to indicate fan and thermal status, hard disk status, and system power status.

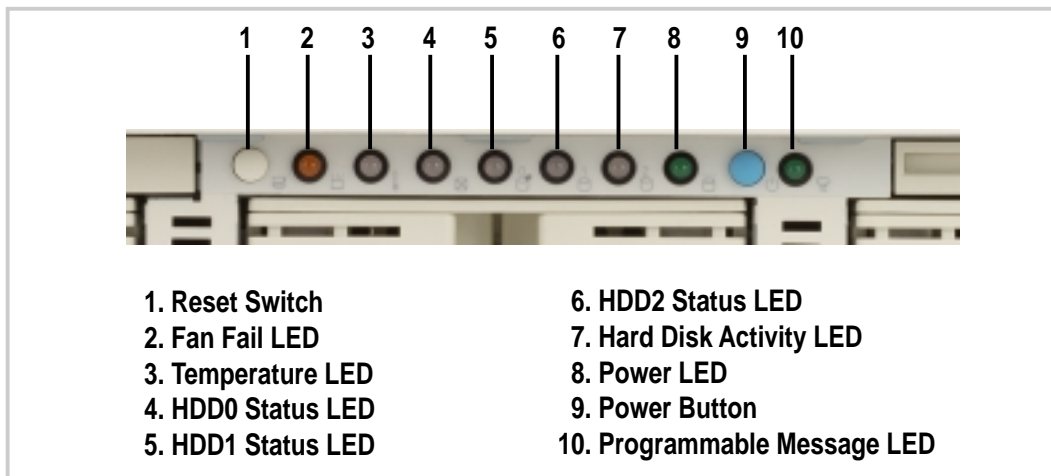

## *LED Information*

### **Fan Fail LED**

When the fan speed is normal, this LED is ON (steady green). The LED turns to steady red when the fan speed crosses a critical threshold.

### **Temperature LED**

When the system temperature is normal, this LED is ON (steady green). The LED turns to steady red when the system temperature crosses a critical threshold.

### **SCSI HDD Drive Status LEDs**

The SCSI hard disks have individual LEDs. When a hard disk is installed, the specific LED for that hard disk is ON (steady green) under normal conditions. When the disk becomes faulty, the LED turns to steady red. The HDD LED is unlit when there is no hard disk present.

### **HDD Activity LED**

This LED flickers (green) whenever there is an IDE/SCSI HDD activity. This LED is unlit when there is no disk activity.

### **Power LED**

This LED lights up (steady green) when you apply power to the system by pressing the power button. This LED goes off when you turn off the system.

### **Message LED**

This LED is software programmable to indicate conditions such a power outage.



# Chapter 2

This chapter tells how to get started with the AP1400R server. The basic operation includes connecting the cables and powering on the system.

# Basic Operation

# Getting Started

Before you turn on the server, make sure that you have completed the basic system connections. Follow these steps when starting the server.

## *Monitor Connection*

Connect a monitor by plugging a video cable to the video port (blue port) at the back of the server.

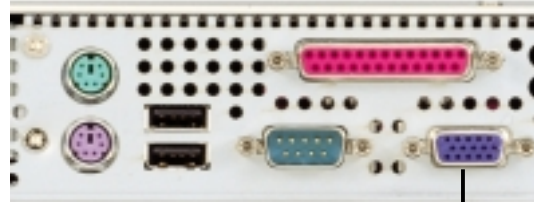

Video Port

## *Power Connection*

Connect a power cord to the AC power connector at the back of the server, then plug the power cord to a grounded wall socket.



AC Power Connector

## *Power ON*

Turn on the server by pressing the power button on the front panel.

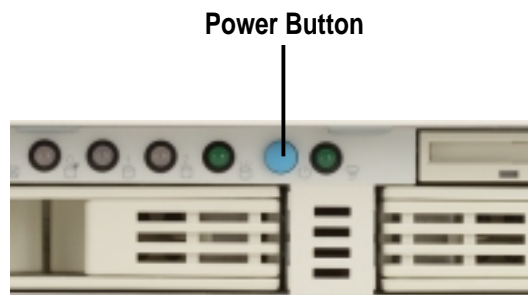

Power Button

## *Check LED*

After turning on the power, check if the power LED lights up.

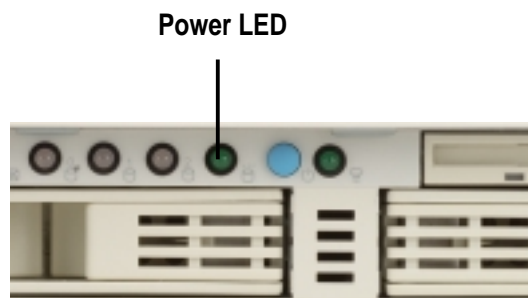

Power LED

# Chapter 3

This chapter describes the hardware setup procedures that you have to perform when installing system components. It also gives detailed information on the internal components and how to install them.

# Hardware Setup

# Opening the Chassis

The AP1400R chassis is a 1U form factor designed for easy assembly and disassembly, making the installation of internal components very convenient. At the top of the chassis is a rotating lock that secures the cover to the chassis.

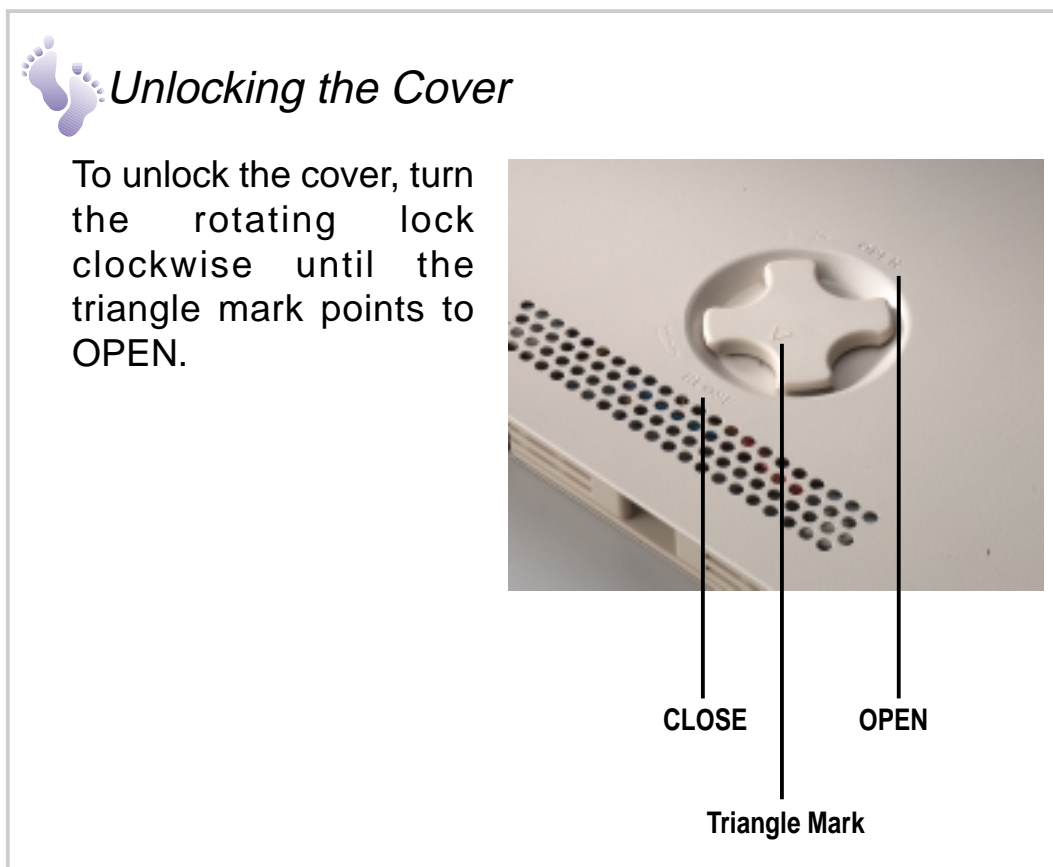
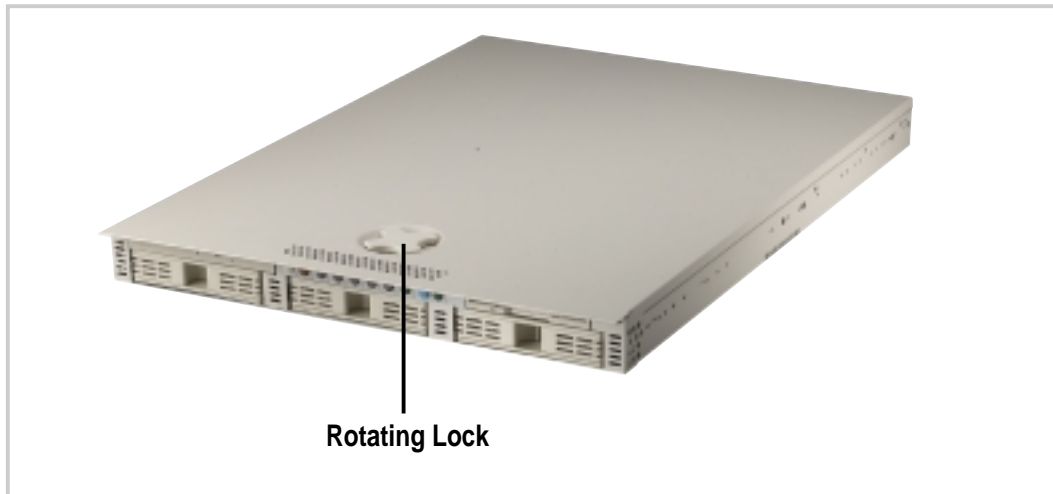

# Opening the Chassis



## *Removing the Cover*

Slide the top cover toward the front for about an inch, then lift it from the chassis.



### **CAUTION**

The top cover of the chassis has locking tabs at the rear end that connect to the inner side of the back panel. Make sure to disengage the locking tabs before lifting up the cover.

# Internal Components

The AP1400R server interior comprise the motherboard and other parts that complete the system.

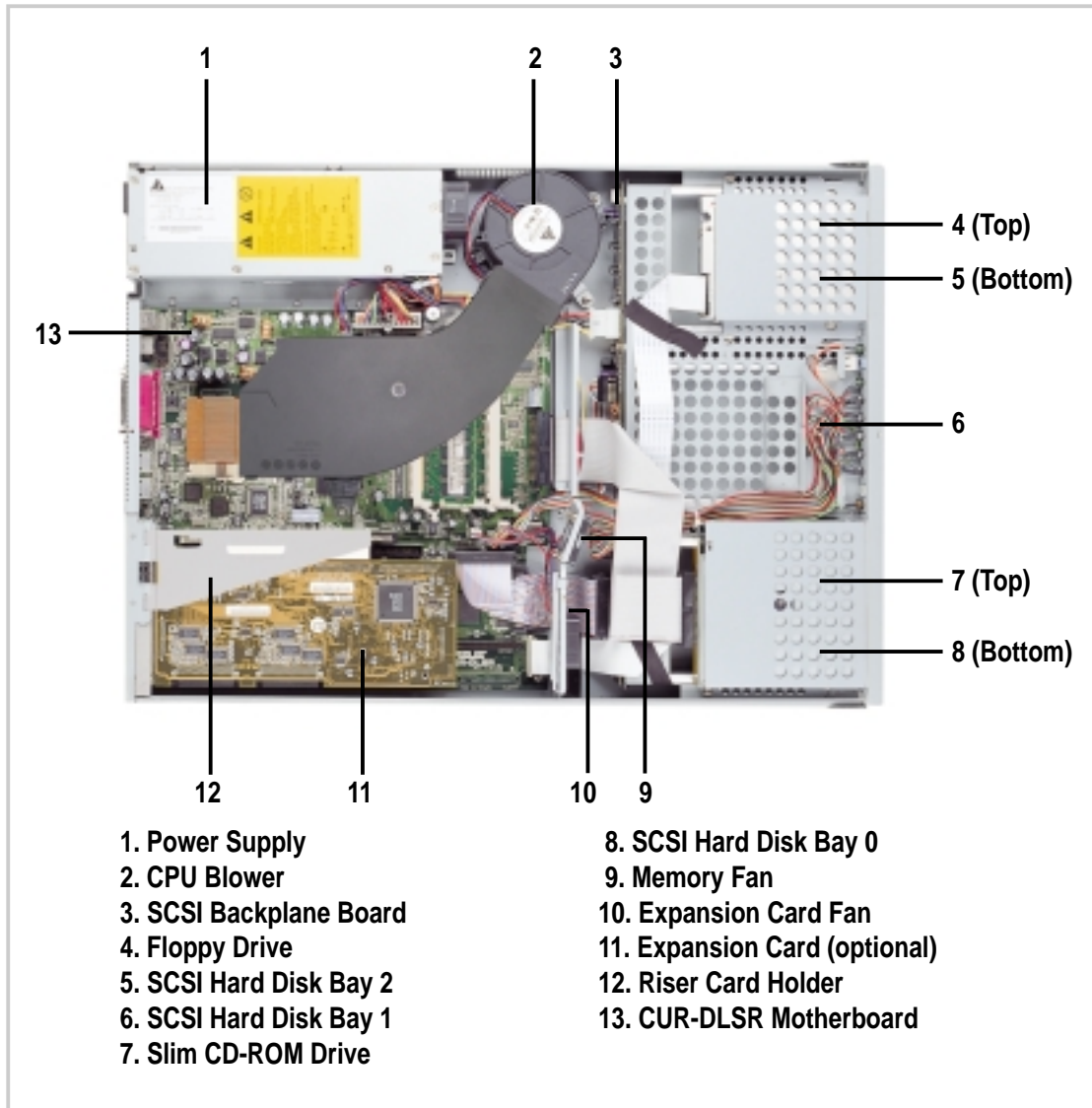

# Motherboard Placement

This section tells how the motherboard is placed into the chassis in case you need to remove and re-install it in the future.



## NOTE

The motherboard and other internal components of the AP1400R server are already installed as indicated in the section “*Internal Components*”. Refer to the motherboard user’s manual for detailed technical information about the motherboard.



## Placement Direction

When installing the motherboard, make sure that you place it into the chassis correctly. The edge with the external ports goes to the back panel of the chassis.

Back Panel ———

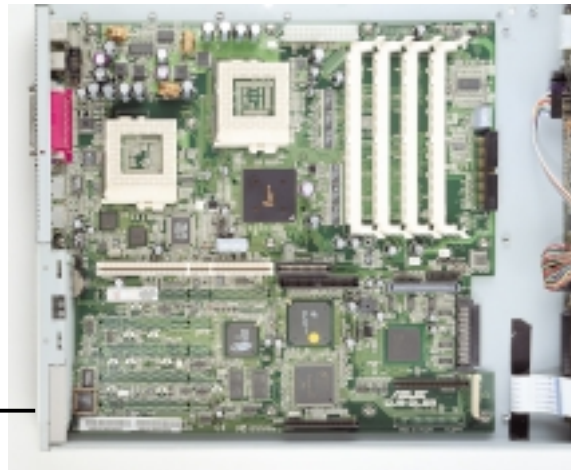

## Motherboard Screws

Place 11 screws in the holes indicated by circles to secure the motherboard to the chassis. Do not overtighten the screws. Doing so may damage the motherboard.

The two holes marked by solid white circles are for securing the CPU fan tube.

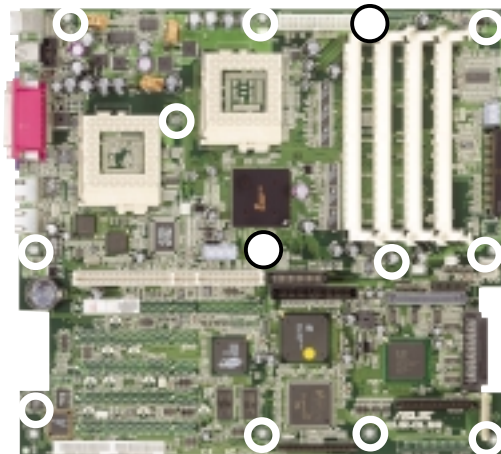

# Central Processing Unit (CPU)

The CUR-DLSR motherboard has two ZIF Socket 370. Each socket supports one Intel Pentium III processor. The figure below shows the CPU sockets on the motherboard. (NOTE: The CPU sockets are underneath the CPU blower tube. Detach the tube to locate the sockets.)

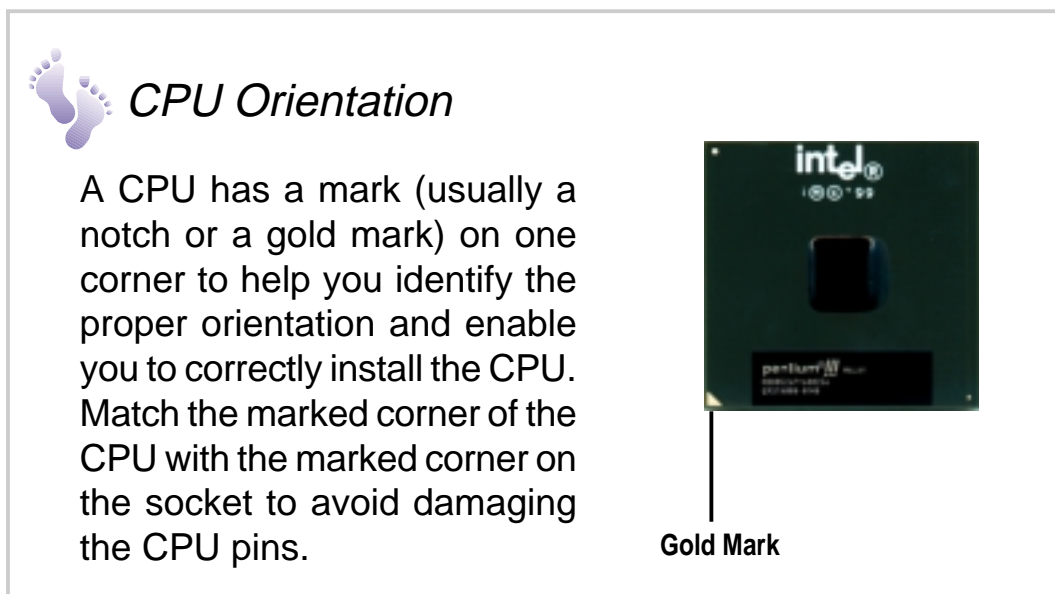
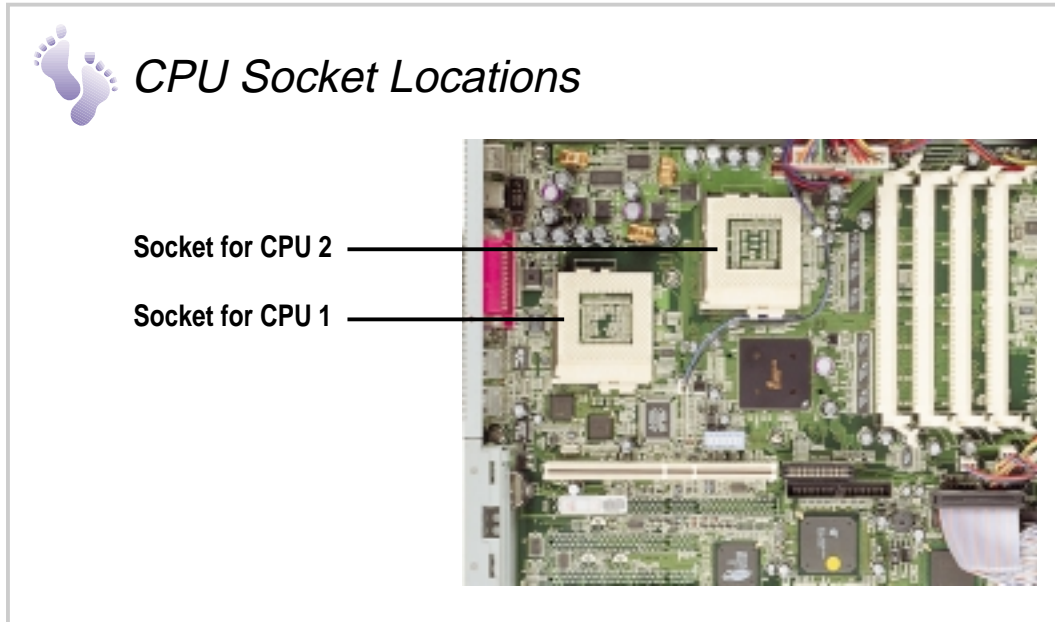



# Central Processing Unit (CPU)



## *CPU Installation*

1. Unlock the socket by pressing the lever sideways then lifting it up to a 90°-100° angle. See Figure 1.
2. Position the CPU above the socket such that its notched or marked corner matches the socket corner near the end of the lever, while making sure that the CPU is parallel to the socket. See Figure 2.
3. Carefully insert the CPU into the socket until it fits in place.
4. When the CPU is in place, press it firmly on the socket while you push down the socket lever to secure the CPU. The lever clicks on the socket indicating that it is locked.

Figure 1

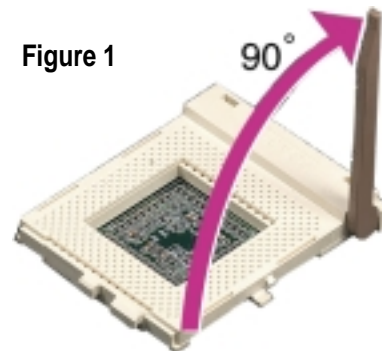
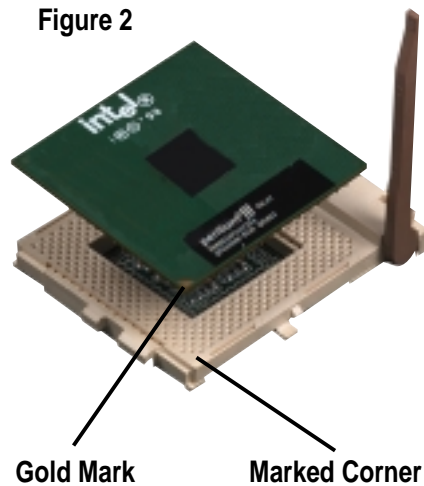

Figure 2



### **IMPORTANT**

The CPU fits only in one orientation. Do not force the CPU into the socket to prevent bending the pins and damaging the CPU. If the CPU does not fit completely, check its orientation or check for bent pins.

# CPU Heatsink



## *Attaching the Heatsink Front Clip*

Place the heatsink on top of the installed CPU. Attach the heatsink front clip to the front of the CPU socket.

(NOTE: When viewed from the front, the CPU socket has the lever on the right side.)

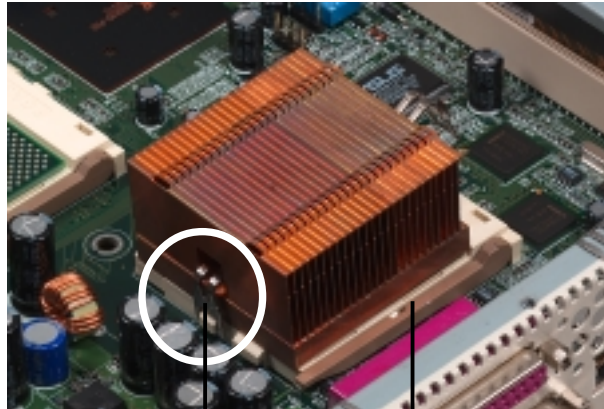

Heatsink Front Clip

Socket Lever



## *Attaching the Heatsink Back Clip*

Use a flat screwdriver to attach the back clip to the back of the CPU socket until it snaps in place.

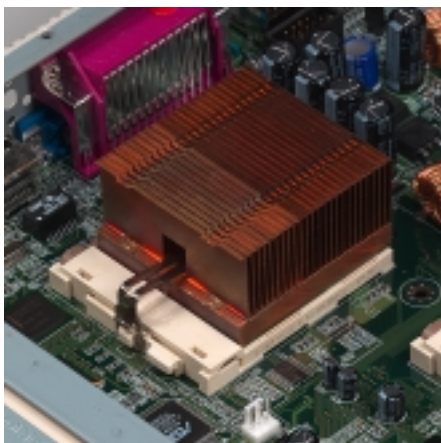

# CPU Terminator

When using only one processor socket, make sure to install an S370 processor terminator to the unused socket. Install a CPU terminator as you would install a CPU. Refer to the section “*CPU Installation*”.

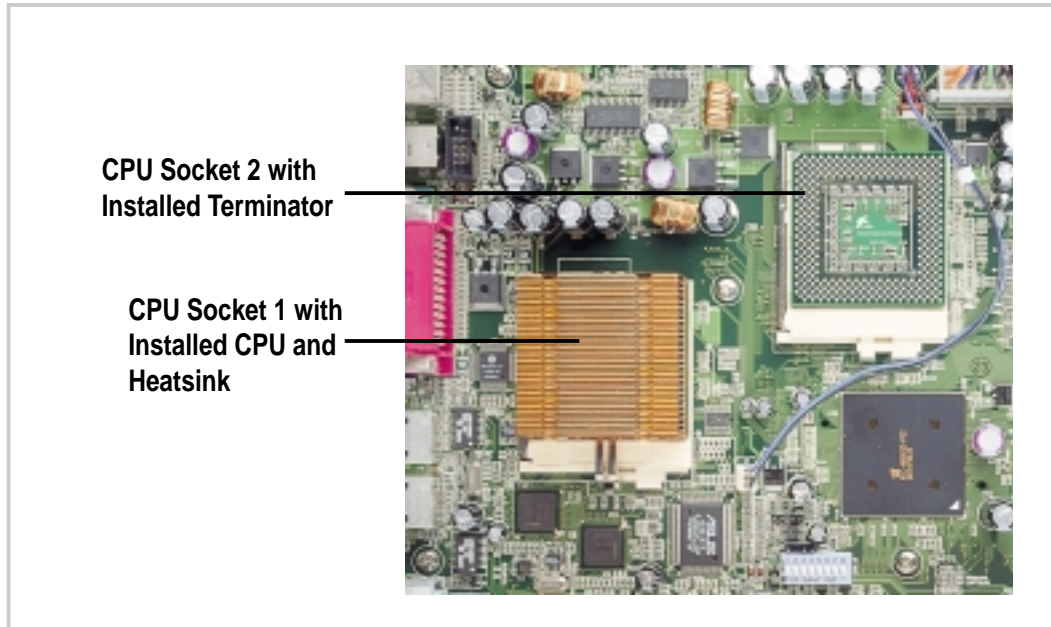

# CPU Fan Cable



## *Connecting the Fan Cable*

Connect the CPU fan (blower) cable to the connector on the motherboard.

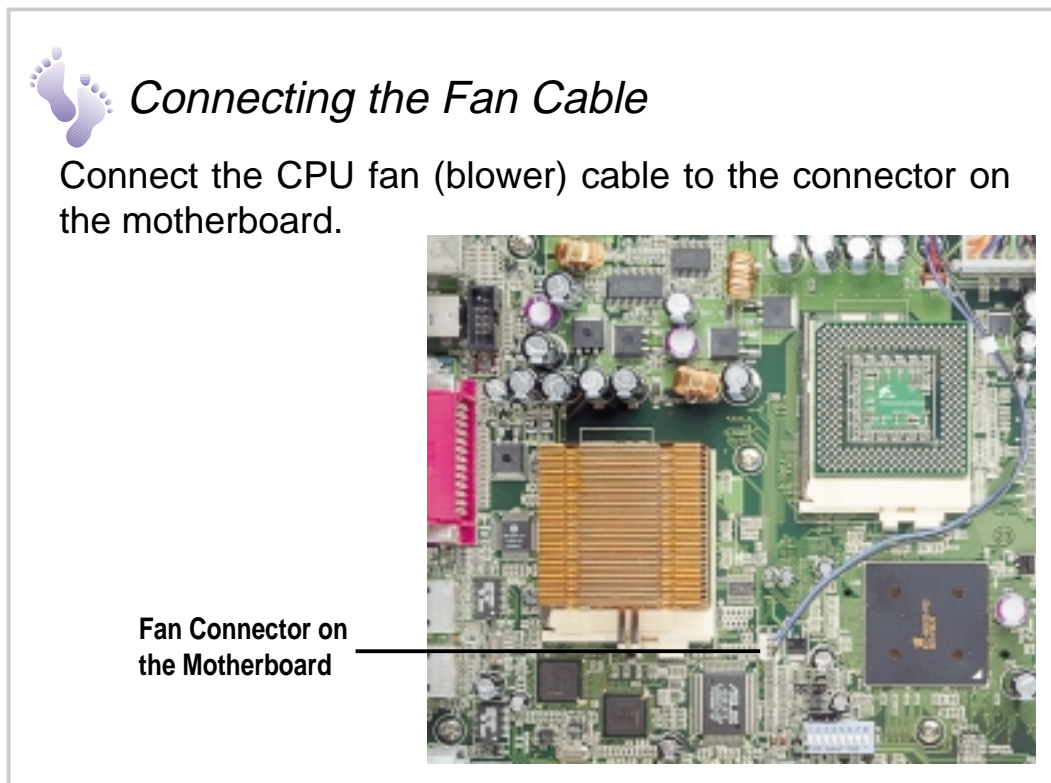

# CPU Blower and Tube

To maintain the ideal temperature for the CPUs, the chassis includes a 9-cm CPU blower. The blower has an extended tube directed to the two CPUs. The blower cable connects to the CPU\_FAN2 connector on the motherboard.



## *CPU Blower and Tube Location*

Three screws (indicated by white circles) secure the CPU blower to the base of the chassis. The blower tube extends to the CPU area on the motherboard and is secured by two screws as indicated in the picture by solid white circles. These two screws have spacers underneath to allow clearance from the motherboard components.

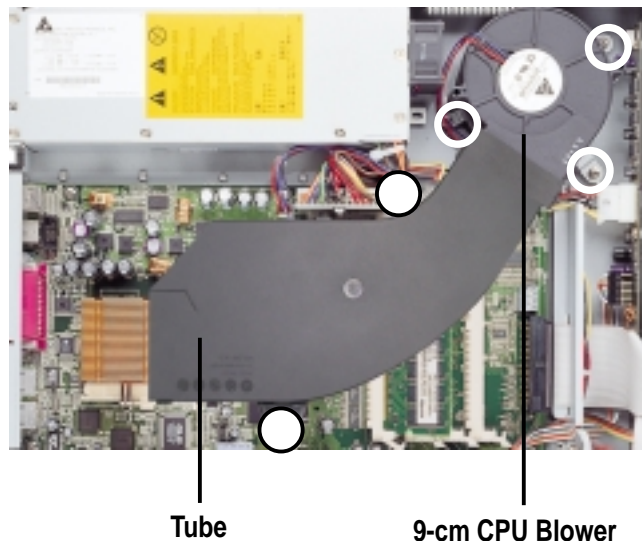

### **IMPORTANT**

Detach the blower tube by removing the two securing screws to access the CPU and DIMM sockets.

# Cooling Fans

Subdividing the motherboard area and the disk drive area is a metal bracket that holds the cooling fans. These fans maintain the ideal temperature for the system memory and the expansion card. The fan cables connect to CHA\_FAN1 and CHA\_FAN2 on the motherboard.

A fan fail LED on the front panel indicates if a fan fails while another LED indicates a thermal failure.

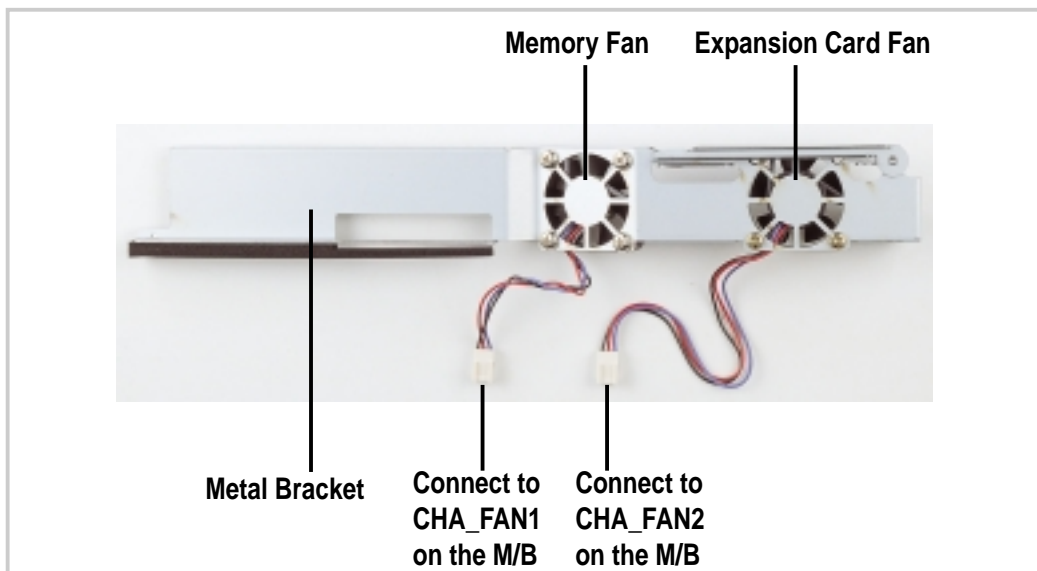

# System Memory

The motherboard has four Dual Inline Memory Module (DIMM) sockets that support 3.3V Synchronous Dynamic Random Access Memory (SDRAM) modules in 16, 32, 64, 128, 256, 512MB, or 1GB densities.

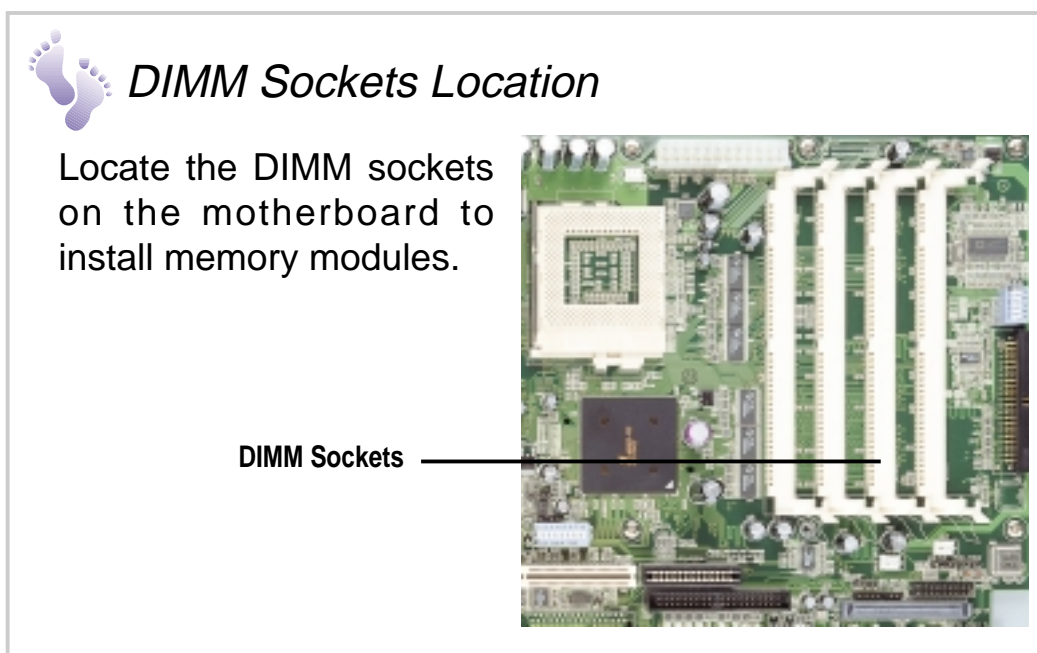

# System Memory



## *DIMM Installation*

1. Unlock a DIMM socket by pressing the retaining clips outward. Align a DIMM on the socket such that the notches on the DIMM (indicated by white circles on the figure) match the breaks on the socket.

DIMM Socket Retaining Clip

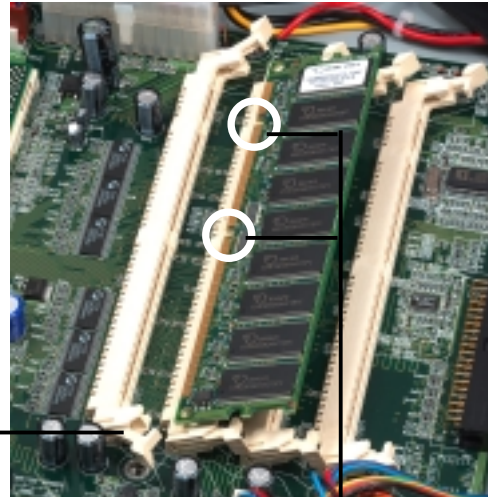

DIMM Notches

2. Carefully insert the DIMM on the socket until the retaining clips snap back in place.

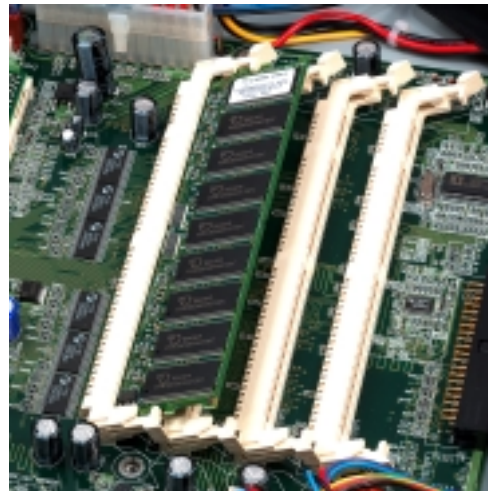

### **CAUTION**

DIMMs fit in only direction. DO NOT force a DIMM into the socket to avoid damaging the DIMM.

# Riser Card / Expansion Card

The motherboard has a 64-bit/33MHz PCI expansion slot. The slot requires a PCI riser card (P64-1U) to accommodate a PCI expansion card. The riser card comes with the system package.

The riser card golden fingers connect to the PCI slot on the motherboard. The card has a PCI card connector for connecting a PCI expansion card.

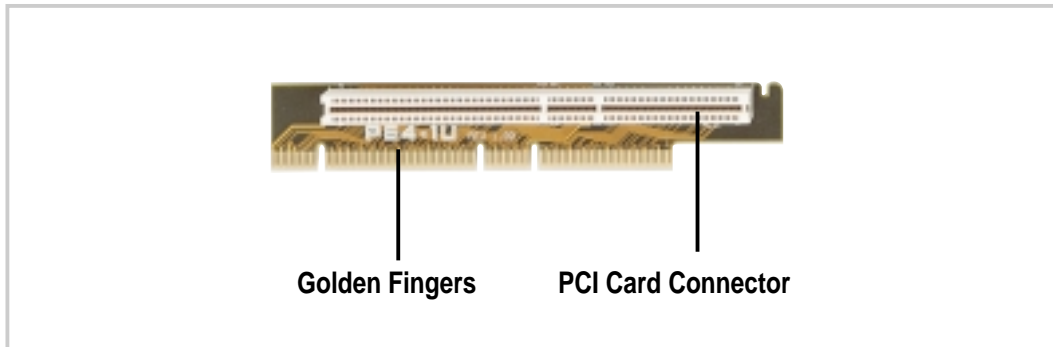

## *Installing an Expansion Card*

Carefully insert the golden fingers of the PCI expansion card to the connector on the riser card. Insert the golden fingers of the riser card to the PCI slot on the motherboard until it fits in place.

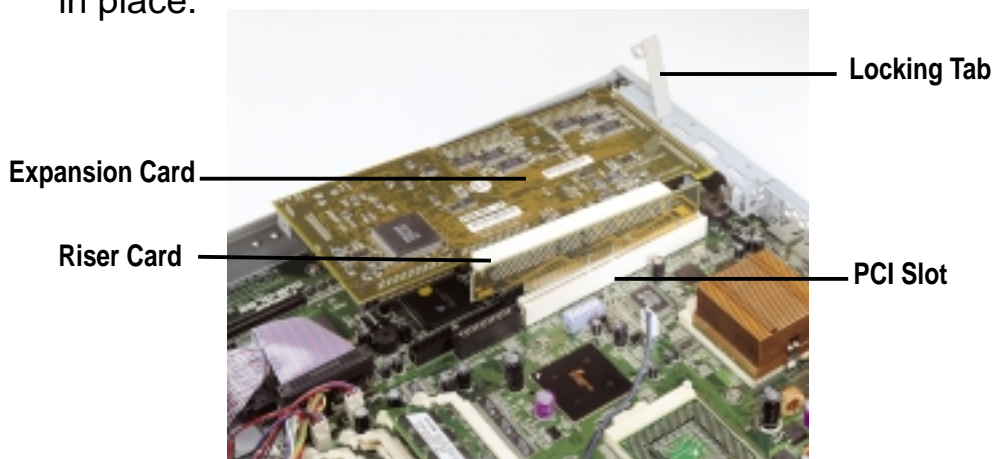

# Riser Card / Expansion Card



## *Securing the Expansion Card*

When the card is installed, push down the locking tab to firmly fix the card in place. Replace the riser card holder to secure the riser and the installed card to the chassis.

Locking Tab



Riser Card Holder

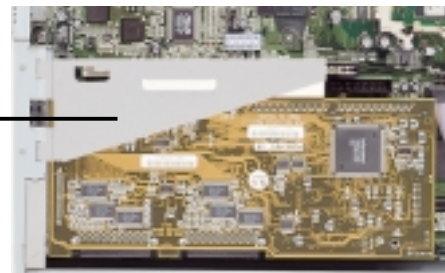

## *Securing an Extended PCI Card*

If you are installing an extended PCI card, such as a RAID card, pull up the the metal card holder before installing the card. When the card is in place, push down the card holder to secure the other end of the card.



Card Holder



# SCSI Backplane

The 1-inch high SCSI backplane included in the system supports three Ultra160 SCSI devices. The backplane design incorporates a hot-swap feature to allow easy installation of external SCSI hard disks. The LED connector on the backplane connects to the front panel LEDs to indicate HDD access, HDD failure, thermal failure, and fan failure.

## *Front Side*

The front side of the backplane has three 80-pin SCA SCSI Out connectors available for the SCA SCSI hard disks. The hard disks are externally accessible from the front panel.

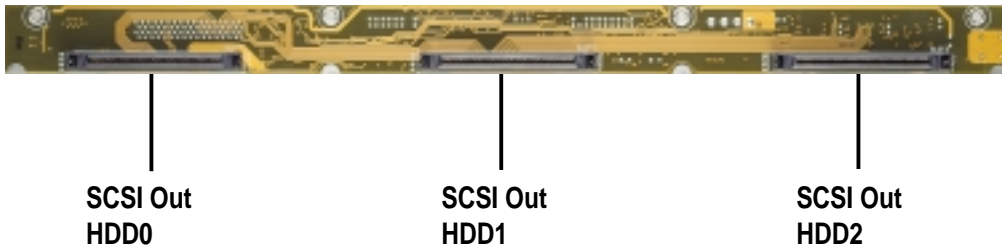

## *Back Side*

The back side of the backplane include the power, SMB, LED, and SCSI In connectors.

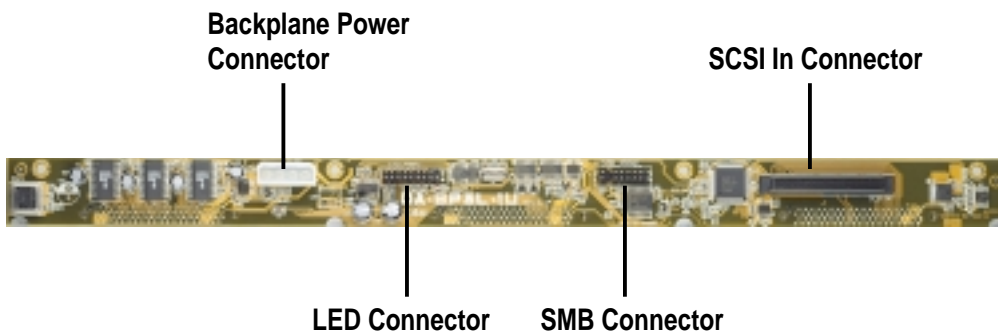

### **NOTE**

The SCSI backplane is already installed in the system chassis. You do not need to remove the backplane when installing components or connecting cables.

# Connecting Cables



## SCSI Cable

Connect the 68-pin SCSI cable to the SCSI connector on the motherboard and the other end to the SCSI In connector on the backplane board.

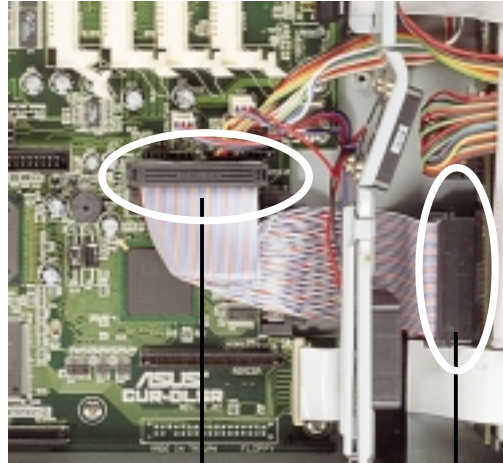

SCSI Connector on the Motherboard

SCSI Connector on the Backplane



## IDE Cable

Connect one end of the IDE cable to connector labeled IDE1 on the motherboard. Connect the other end of the cable to the IDE connector on the CD-ROM adapter board.

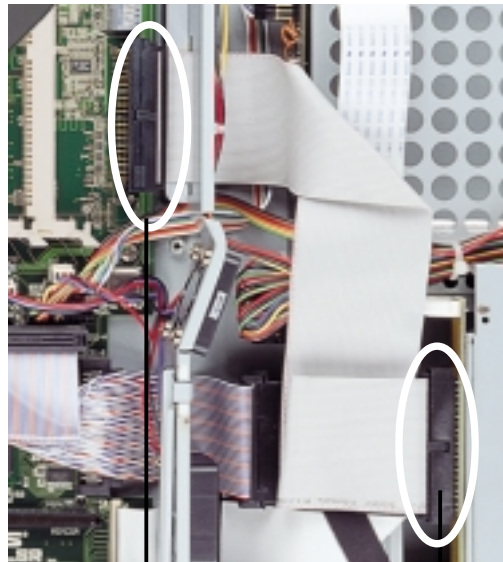

IDE1 Connector on the Motherboard

IDE Connector on the CD-ROM Adapter Board

# Connecting Cables



## Floppy Cable

Connect the floppy cable directly to the floppy drive connector.

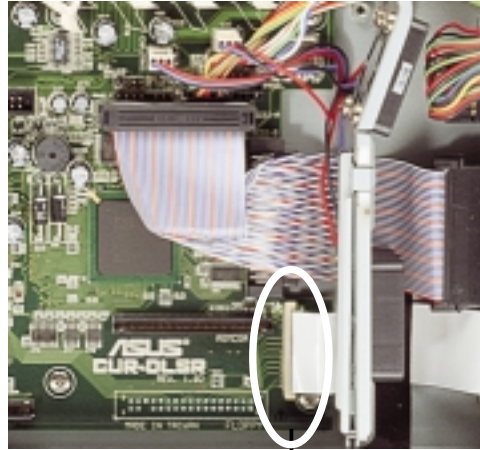

Floppy Drive Connector



## LED Cable

Connect one end of the LED cable to the PANEL2 connector on the motherboard and the other end to the LED connector on the backplane board. (Refer to the section “SCSI/ Backplane” and to the CUR-DLSR User’s Manual for details on LED connector.)

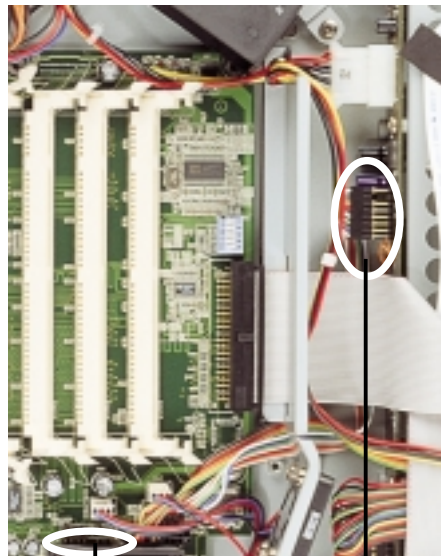

LED Connector on the Motherboard

LED Connector on the Backplane

# Connecting Cables



## Power Cables

Connect the ATX power cable to the ATX power connector on the motherboard. Connect the 4-pin power cable to the power connector on the backplane. Refer to the section “System Power Supply” for details on power cables.

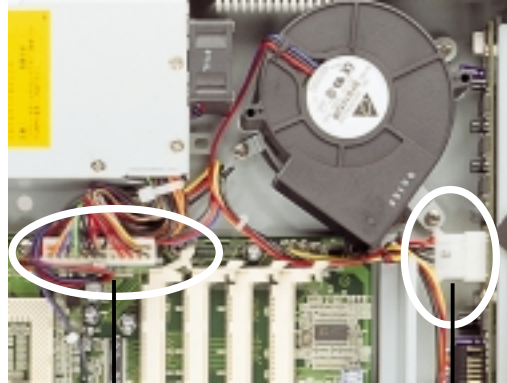

Power Connector on the Motherboard

Power Connector on the Backplane



## Cooling Fan Cables

Connect the memory fan cable and card fan cable to their respective connectors on the motherboard.



Memory Fan Connector  
CHA\_FAN1

Expansion Card Fan Connector  
CHA\_FAN2

# CD-ROM Drive

The system chassis supports a slim CD-ROM drive. The CD-ROM bay is on top of the SCSI HDD0 drive bay (leftmost bay when facing the front panel).

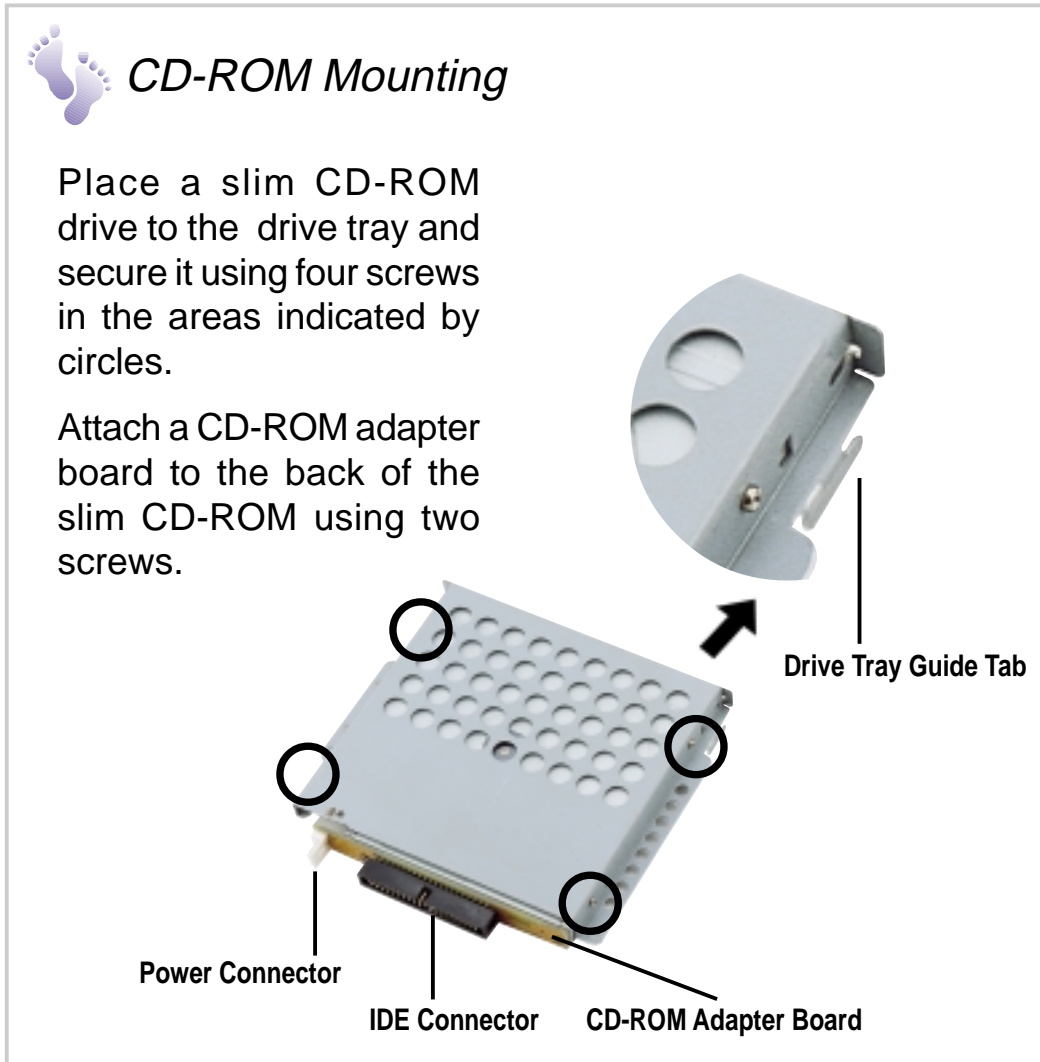

# CD-ROM Drive



## CD-ROM Adapter Board

One side of the CD-ROM adapter board has a special connector that matches the connector on the slim CD-ROM drive. Two screw holes are available for securing the board to the CD-ROM drive. DO NOT over-tighten the screws to avoid damaging the board.

On the other side of the board, a power connector and a standard IDE connector are available.

Slim CD-ROM Connector



Screw Holes



Power Connector

IDE Connector



## CD-ROM Installation

Place the CD-ROM drive on its bay and slide it inward for about an inch (as indicated by the arrow), making sure that the drive tray guide tab locks in place.

Secure the drive to the chassis with two screws on the areas indicated by circles. Connect the IDE and power cables to the connectors on the adapter board.

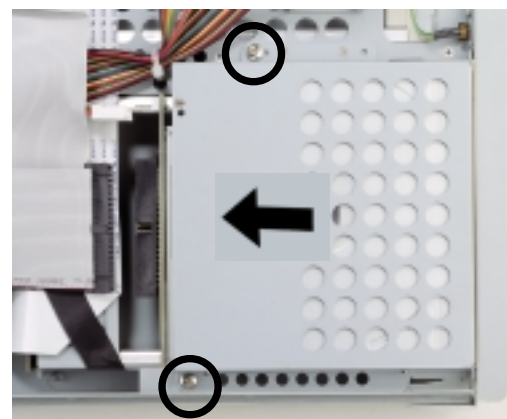

# Floppy Drive

The system comes with the floppy drive already installed. Refer to this section when you need to replace the floppy drive.



## *Floppy Drive Mounting*

Place the floppy drive to the drive tray and secure it with four screws on the areas indicated by circles.

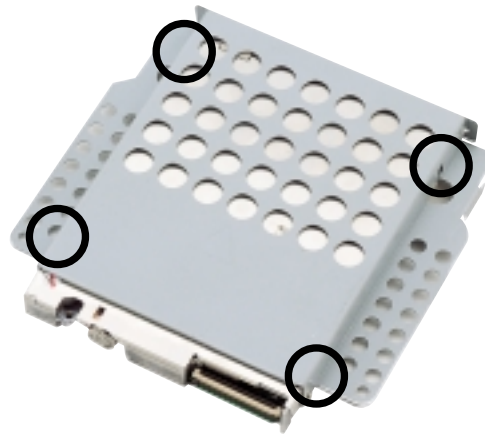

## *Floppy Drive Installation*

Place the floppy drive on its bay (top of the SCSI HDD2). Secure the drive to the chassis with two screws on the areas indicated by circles.

Connect the floppy disk cable to the back of the floppy drive and the other end to the floppy drive connector on the motherboard.

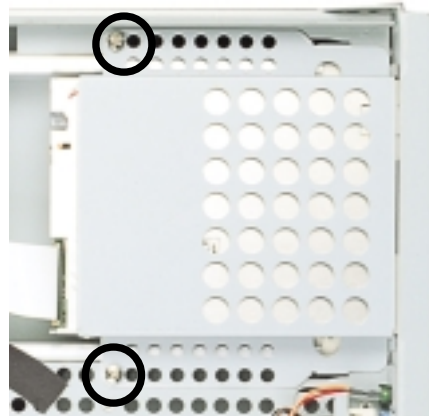

# SCSI Hard Disk Drives

The system comes with three externally accessible hard disk drive bays.



## *Hot-Swap Drive Tray*

In each of the HDD bays is a hot-swap tray for mounting a hard disk drive. Flip open the tray levers to release the tray, then slide the tray out of the chassis.

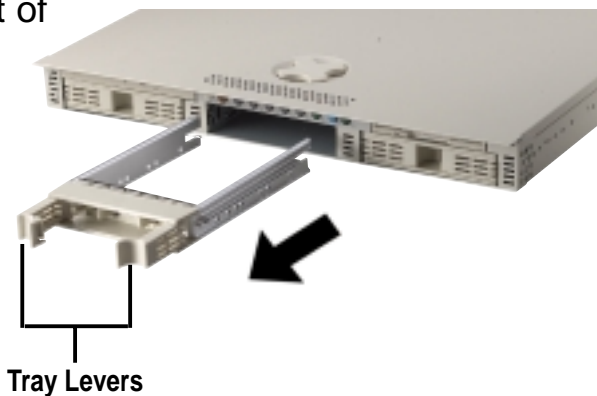

### **IMPORTANT**

Take note of the drive tray orientation before you slide it out. The tray will not fit back into the bay if you insert it the wrong way.



## *SCSI HDD Mounting*

Place the SCSI hard disk drive to the hot-swap drive tray and secure it with four screws as shown. Ensure the correct drive tray orientation before installing the HDD.





# SCSI Hard Disk Drives



## *HDD Installation*

After the drive is secured to the tray, carefully insert the drive into the bay, then push the levers back in place.



### **IMPORTANT**

Make sure that the SCSI cable is connected to the motherboard and the backplane. Refer to the section "*Connecting Cables*".

# System Power Supply

The system comes with a Pinot 200W single power supply with universal AC input that includes PFC and ATX-compliant output cables and connectors. The power supply has an internal cooling fan.

The power supply has four plugs labeled P1 for ATX connector, P2 for backplane connector, P3 for CD-ROM, and P5 for fan.

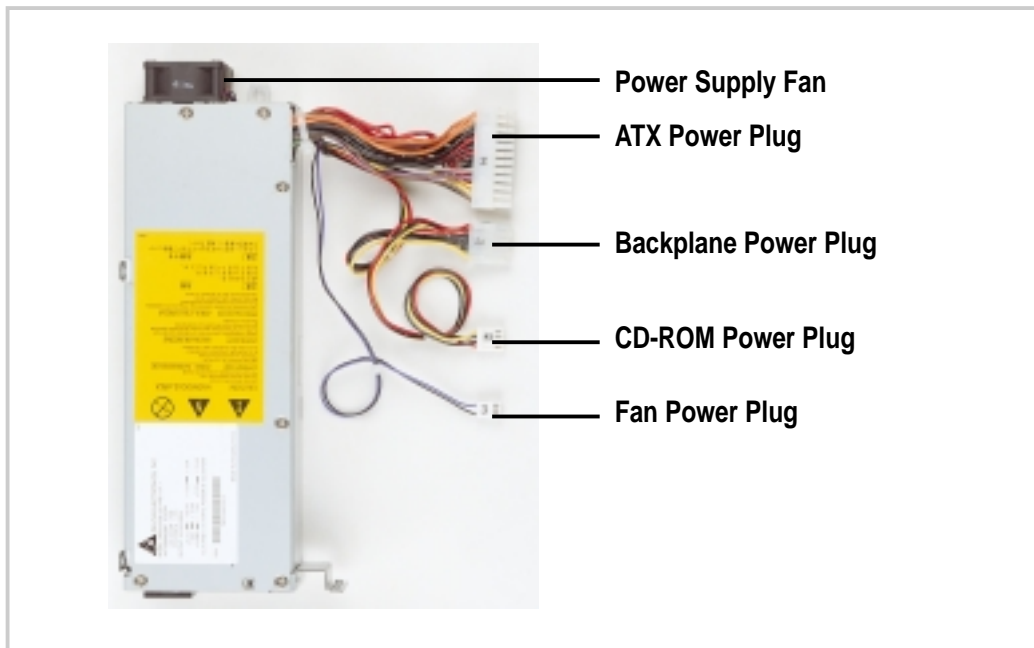

The power supply is located on the back side of the system chassis.



# Power Supply Specifications

## *Output Voltage Regulation*

<b>Output Voltage</b>	<b>Min (V)</b>	<b>Nom (V)</b>	<b>Max (V)</b>	<b>Ripple/Noise</b>
+3.3V	3.2	3.30	3.465	50mV <sub>p-p</sub>
+5V	4.8	5.00	5.25	50mV <sub>p-p</sub>
+12V	11.4	12.00	12.60	120mV <sub>p-p</sub>
-12V	-10.8	-12.00	-13.20	200mV <sub>p-p</sub>
+5Vsb	4.8	5.00	5.25	100mV <sub>p-p</sub>

## *Output Current Capacity*

<b>Output Voltage</b>	<b>Min (A)</b>	<b>Max (A)</b>	<b>Max. Load (W)</b>
+3.3V	0.5	12.5	41.25
+5V	0.5	21.5	107.5
+12V	0.8	4.1	69.2
-12V	0.0	0.25	3.0
+5Vsb	0.1	1.5	7.5

## *Over-Voltage Protection (OVP)*

<b>Voltage</b>	<b>Min (V)</b>	<b>Nom (V)</b>	<b>Max (V)</b>
+3.3V	3.8	4.1	4.3
+5V	5.7	6.25	6.5
+12V	13.5	-	15.0

This page was intentionally left blank.

## Free Manuals Download Website

<http://myh66.com>

<http://usermanuals.us>

<http://www.somanuals.com>

<http://www.4manuals.cc>

<http://www.manual-lib.com>

<http://www.404manual.com>

<http://www.luxmanual.com>

<http://aubethermostatmanual.com>

Golf course search by state

<http://golfingnear.com>

Email search by domain

<http://emailbydomain.com>

Auto manuals search

<http://auto.somanuals.com>

TV manuals search

<http://tv.somanuals.com>