

ASUS[®]

V-Series M2A690G

ASUS PC (Desktop Barebone)

Installation Manual

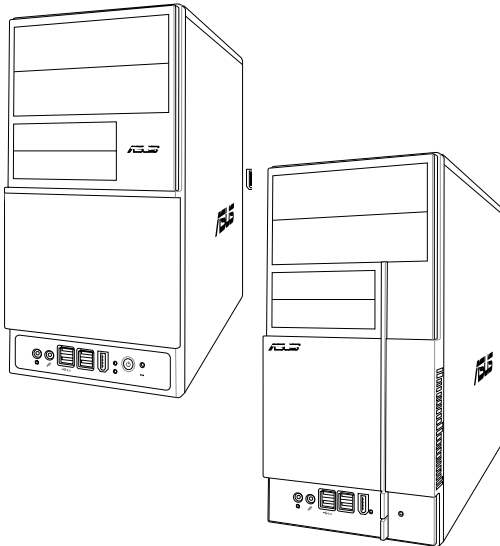

E3061

**First Edition V1
February 2007**

Copyright © 2007 ASUSTeK COMPUTER INC. All Rights Reserved.

No part of this manual, including the products and software described in it, may be reproduced, transmitted, transcribed, stored in a retrieval system, or translated into any language in any form or by any means, except documentation kept by the purchaser for backup purposes, without the express written permission of ASUSTeK COMPUTER INC. ("ASUS").

Product warranty or service will not be extended if: (1) the product is repaired, modified or altered, unless such repair, modification or alteration is authorized in writing by ASUS; or (2) the serial number of the product is defaced or missing.

ASUS PROVIDES THIS MANUAL "AS IS" WITHOUT WARRANTY OF ANY KIND, EITHER EXPRESS OR IMPLIED, INCLUDING BUT NOT LIMITED TO THE IMPLIED WARRANTIES OR CONDITIONS OF MERCHANTABILITY OR FITNESS FOR A PARTICULAR PURPOSE. IN NO EVENT SHALL ASUS, ITS DIRECTORS, OFFICERS, EMPLOYEES OR AGENTS BE LIABLE FOR ANY INDIRECT, SPECIAL, INCIDENTAL, OR CONSEQUENTIAL DAMAGES (INCLUDING DAMAGES FOR LOSS OF PROFITS, LOSS OF BUSINESS, LOSS OF USE OR DATA, INTERRUPTION OF BUSINESS AND THE LIKE), EVEN IF ASUS HAS BEEN ADVISED OF THE POSSIBILITY OF SUCH DAMAGES ARISING FROM ANY DEFECT OR ERROR IN THIS MANUAL OR PRODUCT.

SPECIFICATIONS AND INFORMATION CONTAINED IN THIS MANUAL ARE FURNISHED FOR INFORMATIONAL USE ONLY, AND ARE SUBJECT TO CHANGE AT ANY TIME WITHOUT NOTICE, AND SHOULD NOT BE CONSTRUED AS A COMMITMENT BY ASUS. ASUS ASSUMES NO RESPONSIBILITY OR LIABILITY FOR ANY ERRORS OR INACCURACIES THAT MAY APPEAR IN THIS MANUAL, INCLUDING THE PRODUCTS AND SOFTWARE DESCRIBED IN IT.

Products and corporate names appearing in this manual may or may not be registered trademarks or copyrights of their respective companies, and are used only for identification or explanation and to the owners' benefit, without intent to infringe.

Table of contents

Notices	vi
Safety information	vii
About this guide.....	viii
System package contents.....	x

Chapter 1: System Introduction

1.1 Welcome!	1-2
1.2 Front panel (external).....	1-2
1.3 Rear panel.....	1-4
1.4 Internal components.....	1-7

Chapter 2: Basic Installation

2.1 Preparation	2-2
2.2 Before you proceed	2-2
2.3 Removing the side cover and front panel assembly	2-3
2.4 Central Processing Unit (CPU)	2-4
2.4.1 Installing the CPU.....	2-4
2.4.2 Installing the CPU fan and heatsink.....	2-6
2.5 Installing a DIMM	2-8
2.5.1 Memory configurations	2-8
2.5.2 Installing a DDR2 DIMM	2-11
2.5.3 Removing a DDR2 DIMM.....	2-11
2.6 Expansion slots	2-12
2.6.1 Installing an expansion card	2-12
2.6.2 Configuring an expansion card	2-12
2.6.3 PCI Express x1 slot	2-14
2.6.4 PCI slots.....	2-14
2.6.5 PCI Express x16 slot	2-14
2.7 Installing an optical drive	2-15
2.8 Installing a hard disk drive	2-16
2.9 Installing the card reader	2-18
2.10 Installing a floppy disk drive.....	2-20
2.11 Re-connecting cables.....	2-21
2.12 Reinstalling the cover	2-22

Table of contents

Chapter 3: Starting up

3.1	Installing an operating system.....	3-2
3.2	Powering up	3-2
3.3	Support CD information	3-2
3.3.1	Running the support CD.....	3-3
3.3.2	Utilities menu	3-4
3.3.3	Make disk	3-5
3.3.4	ASUS contact information	3-5
3.4	Software information.....	3-6

Chapter 4: Motherboard Info

4.1	Introduction	4-2
4.2	Motherboard layout	4-2
4.3	Jumpers	4-3
4.4	Connectors	4-5

Chapter 5: BIOS Information

5.1	Managing and updating your BIOS	5-2
5.1.1	Creating a bootable floppy disk	5-2
5.1.2	ASUS EZ Flash 2 utility.....	5-3
5.1.3	AwardBIOS Flash utility	5-4
5.1.4	ASUS CrashFree BIOS 2 utility	5-6
5.1.5	ASUS Update utility	5-8
5.2	BIOS setup program.....	5-11
5.2.1	BIOS menu screen.....	5-11
5.2.2	Menu bar	5-11
5.2.3	Legend bar.....	5-12
5.2.4	Menu items	5-12
5.2.5	Sub-menu items.....	5-12
5.2.6	Configuration fields.....	5-12
5.2.7	Pop-up window.....	5-13
5.2.8	General help.....	5-13

Table of contents

5.3	Main menu.....	5-14
5.3.1	System Time	5-14
5.3.2	System Date	5-14
5.3.3	Legacy Diskette A	5-14
5.3.4	Primary IDE Master/Slave.....	5-15
5.3.5	SATA 1-4.....	5-16
5.3.6	HDD SMART Monitoring.....	5-17
5.3.7	Installed Memory	5-18
5.3.8	Usable Memory.....	5-18
5.4	Advanced menu	5-18
5.4.1	JumperFree Configuration.....	5-19
5.4.2	CPU Configuration	5-20
5.4.3	Chipset.....	5-21
5.4.4	PCIPnP	5-22
5.4.5	Onboard Device Configuration	5-23
5.4.6	USB Configuration	5-25
5.5	Power menu	5-26
5.5.1	ACPI Suspend Type	5-26
5.5.2	ACPI APIC Support	5-26
5.5.3	APM Configuration	5-26
5.5.4	Hardware Monitor.....	5-28
5.6	Boot menu	5-30
5.6.1	Boot Device Priority	5-30
5.6.2	Removable Drives.....	5-30
5.6.3	Hard Disk Drives.....	5-31
5.6.4	Boot Settings Configuration	5-31
5.6.5	Security.....	5-33
5.7	Tools menu	5-34
5.7.1	ASUS Music Alarm.....	5-34
5.7.2	ASUS O.C. Profile	5-36
5.7.3	ASUS EZ Flash 2.....	5-38
5.8	Exit menu.....	5-31

Notices

Federal Communications Commission Statement

This device complies with Part 15 of the FCC Rules. Operation is subject to the following two conditions:

- This device may not cause harmful interference, and
- This device must accept any interference received including interference that may cause undesired operation.

This equipment has been tested and found to comply with the limits for a Class B digital device, pursuant to Part 15 of the FCC Rules. These limits are designed to provide reasonable protection against harmful interference in a residential installation. This equipment generates, uses and can radiate radio frequency energy and, if not installed and used in accordance with manufacturer's instructions, may cause harmful interference to radio communications. However, there is no guarantee that interference will not occur in a particular installation. If this equipment does cause harmful interference to radio or television reception, which can be determined by turning the equipment off and on, the user is encouraged to try to correct the interference by one or more of the following measures:

- Reorient or relocate the receiving antenna.
- Increase the separation between the equipment and receiver.
- Connect the equipment to an outlet on a circuit different from that to which the receiver is connected.
- Consult the dealer or an experienced radio/TV technician for help.



WARNING! The use of shielded cables for connection of the monitor to the graphics card is required to assure compliance with FCC regulations. Changes or modifications to this unit not expressly approved by the party responsible for compliance could void the user's authority to operate this equipment.

Canadian Department of Communications Statement

This digital apparatus does not exceed the Class B limits for radio noise emissions from digital apparatus set out in the Radio Interference Regulations of the Canadian Department of Communications.

This class B digital apparatus complies with Canadian ICES-003.

Safety information

Electrical safety

- To prevent electrical shock hazard, disconnect the power cable from the electrical outlet before relocating the system.
- When adding or removing devices to or from the system, ensure that the power cables for the devices are unplugged before the signal cables are connected.
- If the power supply is broken, do not try to fix it by yourself. Contact a qualified service technician or your retailer.

Operation safety

- Before installing devices into the system, carefully read all the documentation that came with the package.
- Before using the product, make sure all cables are correctly connected and the power cables are not damaged. If you detect any damage, contact your dealer immediately.
- To avoid short circuits, keep paper clips, screws, and staples away from connectors, slots, sockets and circuitry.
- Avoid dust, humidity, and temperature extremes. Do not place the product in any area where it may become wet. Place the product on a stable surface.
- If you encounter technical problems with the product, contact a qualified service technician or your retailer.

Lithium-Ion Battery Warning

CAUTION: Danger of explosion if battery is incorrectly replaced. Replace only with the same or equivalent type recommended by the manufacturer. Dispose of used batteries according to the manufacturer's instructions.

VORSICHT: Explosionsgefahr bei unsachgemäßen Austausch der Batterie. Ersatz nur durch denselben oder einem vom Hersteller empfohlenem ähnlichen Typ. Entsorgung gebrauchter Batterien nach Angaben des Herstellers.

LASER PRODUCT WARNING

CLASS 1 LASER PRODUCT

About this guide

Audience

This guide provides general information and installation instructions about the ASUS Vintage V-Series M2A690G barebone system. This guide is intended for experienced users and integrators with hardware knowledge of personal computers.

How this guide is organized

This guide contains the following parts:

1. Chapter 1: System introduction

This chapter gives a general description of the ASUS V-Series M2A690G. The chapter lists the system features, including introduction on the front and rear panel, and internal components.

2. Chapter 2: Basic installation

This chapter provides step-by-step instructions on how to install components in the system.

3. Chapter 3: Starting up

This chapter helps you power up the system and install drivers and utilities from the support CD.

4. Chapter 4: Motherboard information

This chapter gives information about the motherboard that comes with the system. This chapter includes the motherboard layout, jumper settings, and connector locations.

5. Chapter 5: BIOS information

This chapter tells how to change system settings through the BIOS Setup menu and describes the BIOS parameters.

Conventions used in this guide



WARNING: Information to prevent injury to yourself when trying to complete a task.



CAUTION: Information to prevent damage to the components when trying to complete a task.



IMPORTANT: Instructions that you **MUST** follow to complete a task.



NOTE: Tips and additional information to aid in completing a task.

Where to find more information

Refer to the following sources for additional information and for product and software updates.

1. ASUS Websites

The ASUS websites worldwide provide updated information on ASUS hardware and software products. Refer to the ASUS contact information.

2. Optional Documentation

Your product package may include optional documentation, such as warranty flyers, that may have been added by your dealer. These documents are not part of the standard package.

System package contents

Check your V-Series M2A690G system package for the following items.



If any of the items is damaged or missing, contact your retailer immediately.

Item description
1. ASUS V-Series M2A690G barebone system with
• ASUS motherboard
• Power supply unit
• ASUS chassis
2. Cable
• AC power cable
3. Support CD
4. User guide



An optional card reader is available along with the system for the users to purchase.

Chapter 1

This chapter gives a general description of the ASUS V-Series M2A690G. The chapter lists the system features including introduction on the front and rear panel, and internal components.

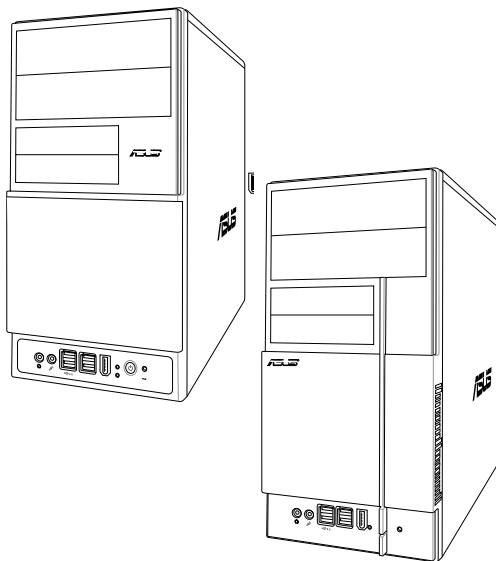

System introduction

1.1 Welcome!

Thank you for choosing the ASUS V-Series M2A690G!

The ASUS V-Series M2A690G is an all-in-one barebone system with a versatile home entertainment feature.

The system comes in a stylish casing and powered by the ASUS motherboard with the AMD Socket M2 that supports the AMD® Athlon™ 64X2 / Athlon™64 / Sempron™ processors.

The system supports up to 4 GB of system memory using DDR2-800/667/533 DIMMs. High-resolution graphics via Nvidia on board Gfx or PCI Express x16 slot, Serial ATA, USB 2.0, and 8-channel audio feature the system and take you ahead in the world of power computing.

1.2 Front panel

The front panel includes the optical drive bays, floppy disk drive slot, power button, and several I/O ports are located at the front panel.

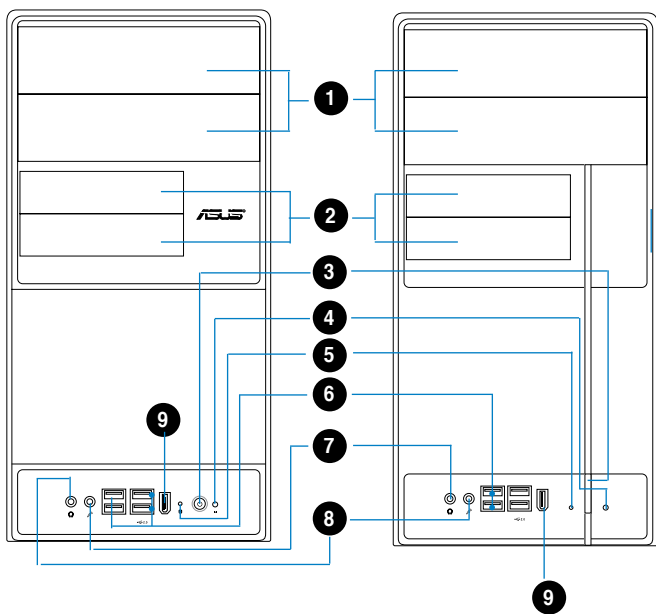

1. **Two empty 5.25-inch bays.** These bays are for IDE optical drives.
2. **3.5-inch drive bays.** These slots are for 3.5-inch floppy or hard disk drives.
3. **Power button.** Press this button to turn the system on.
4. **Reset button.** Press this button to reboot the system without turning off the power.
5. **HDD LED.** This LED lights up when data is read from or written to the hard disk drive.
6. **USB 2.0 ports.** These Universal Serial Bus 2.0 (USB 2.0) ports are available for connecting USB 2.0 devices such as a mouse, printer, scanner, camera, PDA, and others.
7. **Headphone port.** This Line In (green) port connects a headphone with a stereo mini-plug.
8. **Microphone port.** This Mic (pink) port connects a microphone.
9. **IEEE1394 port.**



This V-series provide V2/V3 two types of front panel for users to choose, please refer to your product package for the front panel type you purchased.



PCI Express Graphics Slot supports most of the ATI® and NVIDIA® graphics cards, except some ATI® graphics cards of old version, such as ATI® X300, X550, X700, and X800 series.



An optional Card Reader (see the figure bellow) available. It is to be installed in the 3.5-inch drive bay, and connected to the motherboard through a USB cable.

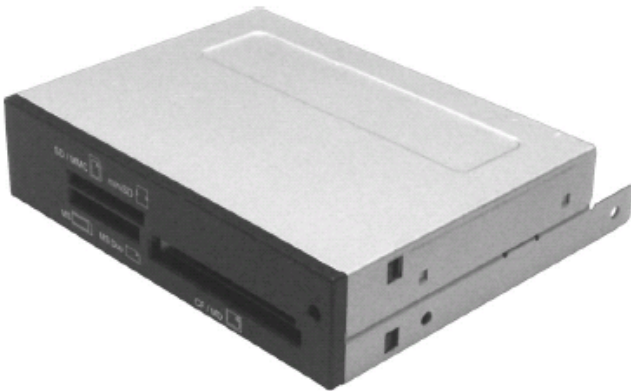

1.3 Rear panel

The system rear panel includes the power connector and several I/O ports that allow convenient connection of devices.

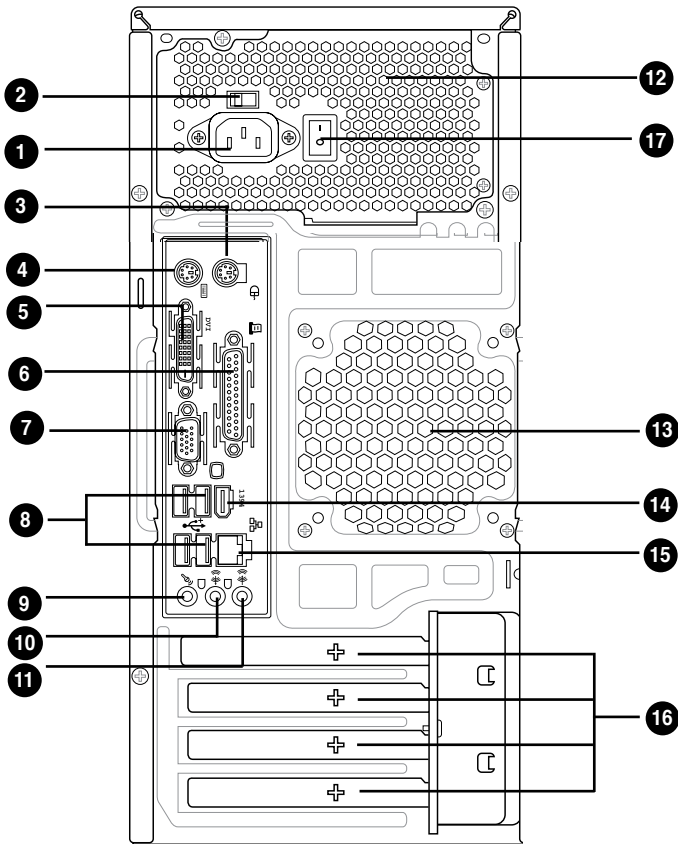

1. **Power connector.** This connector is for the power cable and plug.
2. **Voltage selector.** This switch allows you to adjust the system input voltage according to the voltage supply in your area. See the section “Voltage selector” on page 1-6 before adjusting this switch.
3. **PS/2 mouse port.** This green 6-pin connector is for a PS/2 mouse.
4. **PS/2 keyboard port.** This purple 6-pin connector is for a PS/2 keyboard.
5. **DVI-out port.** This port connects a Digital Visual Interface (DVI-D) card.
6. **Parallel port.** This 25-pin port connects a printer, scanner, or other devices.
7. **VGA port.** This port connects a VGA monitor.

8. **USB 2.0 ports 1, 2, 3 and 4.** These 4-pin Universal Serial Bus (USB) ports are available for connecting USB 2.0 devices.
9. **Microphone port (pink).** This port connects a microphone.
10. **Line Out port (lime).** This port connects a headphone or a speaker. In 4-channel and 6-channel configuration, the function of this port becomes Front Speaker Out.
11. **Line In port (light blue).** This port connects the tape, CD, DVD player, or other audio sources.
12. **Power supply unit fan vent.** This vent is for the PSU fan that provides ventilation inside the power supply unit.
13. **Chassis fan vent.** This vent is for the fan that provides ventilation inside the system chassis.
14. **IEEE 1394 port.** This 6-pin IEEE 1394 port provides high-speed connectivity for audio/video devices, storage peripherals, PCs, or portable devices.
15. **LAN (RJ-45) port.** This port allows Gigabit connection to a Local Area Network (LAN) through a network hub.
16. **Expansion slot covers.** Remove these covers when installing expansion cards.
17. **Power Switch.** This switch is for switching on/off the power supply unit.



Refer to the audio configuration table below for the function of the audio ports in 2, 4, or 6-channel configuration.

Audio 2, 4, or 6-channel configuration

Port	Headset 2-speaker	4-speaker	6-speaker
Light Blue	Line In	Surround Out	Surround Out
Lime	Line Out	Front Speaker Out	Front Speaker Out
Pink	Mic In	Mic In	Center/Bass



A HDMI card is available along with the system. It is to be installed on the PCI Express x 16 slot on the motherboard. After it is installed, the ports of the HDMI card in the expansion slot area on the rear panel as shown. Refer to the next page for the descriptions for the HDMI card ports.

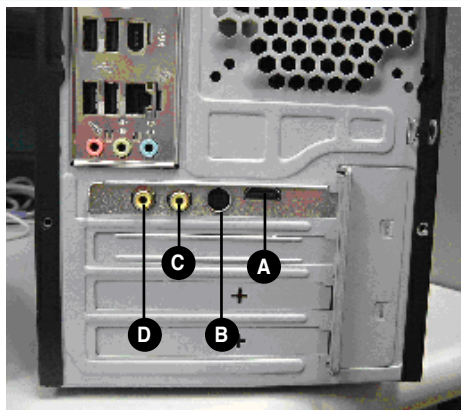

HDMI card ports

- A. **HDMI port.** This port is for a high-definition multimedia interface (HDMI) connector.
- B. **S-Video port / YPbPr port.** This 7-pin port connects any kind of video source via a YPbPr cable or an S-Video cable.
- C. **Video port.** This port connects any kind of video source via an RCA cable.
- D. **S/PDIF Out port.** This port connects an external audio output device via an coaxial S/PDIF cable.

Voltage selector

The PSU has a 115 V/230 V voltage selector switch located beside the power connector. Use this switch to select the appropriate system input voltage according to the voltage supply in your area.

If the voltage supply in your area is 100-127 V, set this switch to 115 V.

If the voltage supply in your area is 200-240 V, set this switch to 230 V.

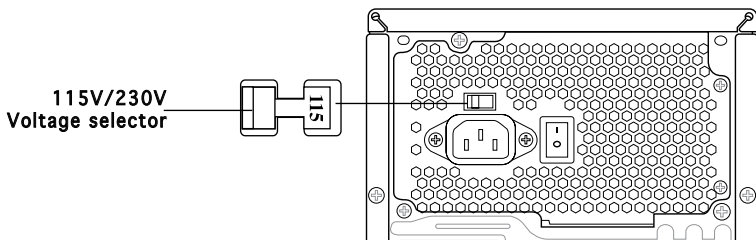

Setting the switch to 115V in a 230V environment or 230V in a 115V environment will seriously damage the system!

1.4 Internal components

The illustration below is the internal view of the system when you remove the top cover and the power supply unit. The installed components are labeled for your reference. Proceed to Chapter 2 for instructions on installing additional system components.

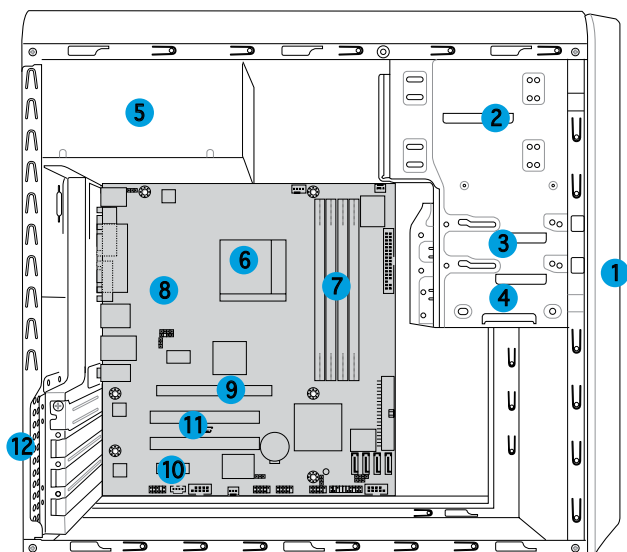

- | | |
|---------------------------------|-------------------------|
| 1. Front panel cover | 8. ASUS motherboard |
| 2. 5.25-inch optical drive bays | 9. PCI Express x16 slot |
| 3. Floppy disk drive bay | 10. PCI Express x1 slot |
| 4. Hard disk drive bay | 11. PCI slots |
| 5. Power supply unit | 12. Metal bracket lock |
| 6. CPU socket | |
| 7. DIMM sockets | |



There is a HDMI module supplying along with the system. Refer to the chapter 2 for the detailed information about the HDMI module.

Chapter 2

This chapter provides step-by-step instructions on how to install components in the system.

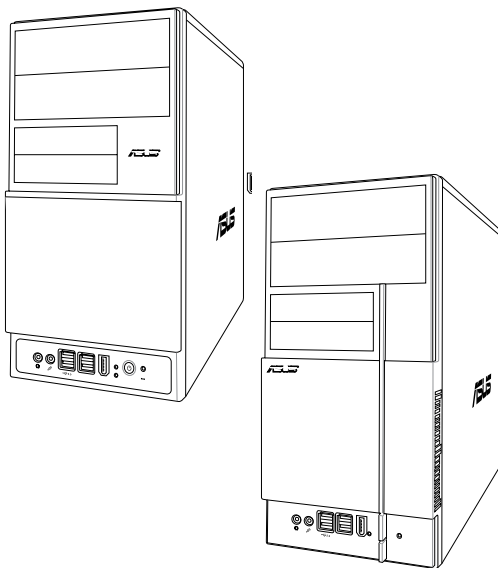

Basic installation

2.1 Preparation

Before you proceed, make sure that you have all the components you plan to install in the system.

Basic components to install

1. Central Processing Unit (CPU)
2. DDR2 Dual Inline Memory Module (DIMM)
3. Expansion card(s)
4. Hard disk drive
5. Optical drive
6. Floppy disk drive

Tool

Phillips (cross) screw driver

2.2 Before you proceed

Take note of the following precautions before you install components into the system.



- Use a grounded wrist strap or touch a safely grounded object or a metal object, such as the power supply case, before handling components to avoid damaging them due to static electricity.
- Hold components by the edges to avoid touching the ICs on them.
- Whenever you uninstall any component, place it on a grounded antistatic pad or in the bag that came with the component.

The motherboard comes with an onboard standby power LED. This LED lights up to indicate that the system is ON, in sleep mode or in soft-off mode, and not powered OFF. Unplug the power cable from the power outlet and make sure that the standby power LED is OFF before installing any system component.

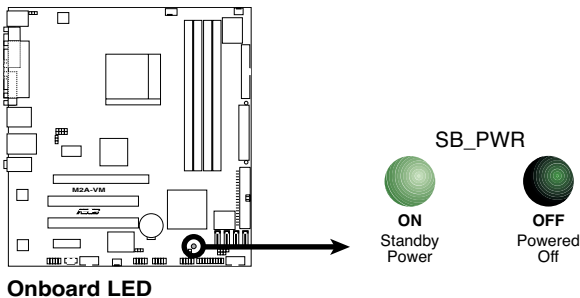

2.3 Removing the side cover and front panel assembly

1. Remove the cover screws on the rear panel.
2. Pull the side cover toward the rear panel until its hooks disengage from the chassis tab holes. Set the side cover aside.
3. Locate the front panel assembly hooks, then lift them until they disengage from the chassis.
4. Swing the front panel assembly to the right, until the hinge-like tabs on the right side of the assembly are exposed.
5. Remove the front panel assembly, then set aside.

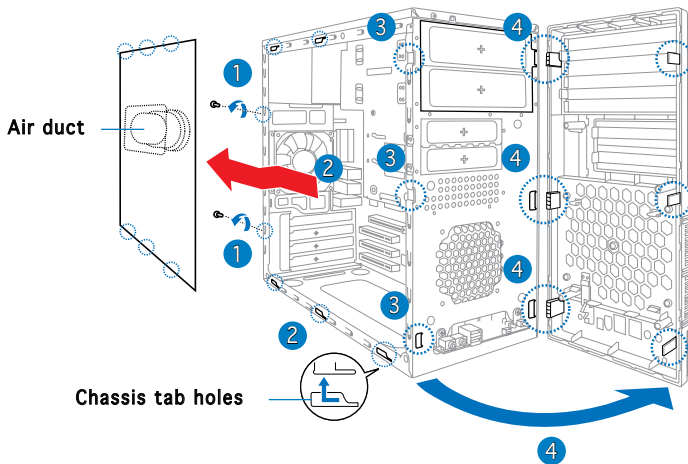

2.4 Central Processing Unit (CPU)

The motherboard comes with a 940-pin AM2 socket designed for the AMD Athlon™ 64 X2/Athlon™ 64/Sempron™ processor.



The AM2 socket has a different pinout from the 940-pin socket designed for the AMD Opteron™ processor. Make sure you use a CPU is designed for the AM2 socket. The CPU fits in only one correct orientation. DO NOT force the CPU into the socket to prevent bending the connectors on the socket and damaging the CPU!

2.4.1 Installing the CPU

To install a CPU:

1. Locate the CPU socket on the motherboard.

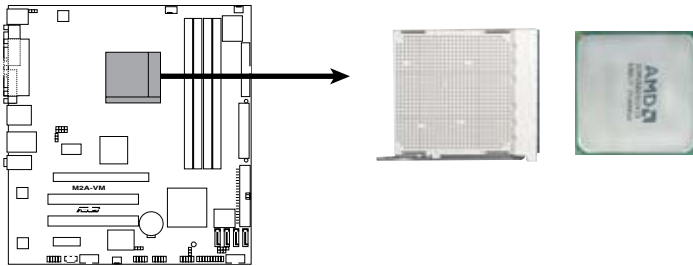

CPU Socket M2

2. Unlock the socket by pressing the lever sideways, then lift it up to a 90° angle.

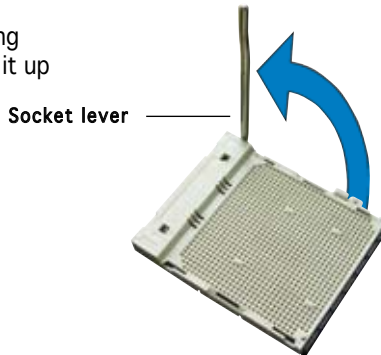

Make sure that the socket lever is lifted up to a 90° angle; otherwise, the CPU will not fit in completely.

3. Position the CPU above the socket such that the CPU corner with the gold triangle matches the socket corner with a small triangle.
4. Carefully insert the CPU into the socket until it fits in place.



Please make sure your CPU is fully plugged-in to reduce abnormal symptom.

Gold triangle

Small triangle

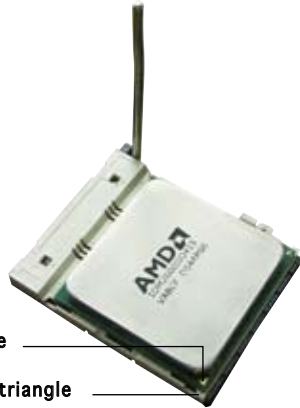

5. When the CPU is in place, push down the socket lever to secure the CPU. The lever clicks on the side tab to indicate that it is locked.
6. Install a CPU heatsink and fan following the instructions that came with the heatsink package.



2.4.2 Installing the heatsink and fan



Make sure that you use only AMD-certified heatsink and fan assembly.

Follow these steps to install the CPU heatsink and fan.

1. Place the heatsink on top of the installed CPU, making sure that the heatsink fits properly on the retention module base.



- The retention module base is already installed on the motherboard upon purchase.
 - You do not have to remove the retention module base when installing the CPU or installing other motherboard components.
 - If you purchased a separate CPU heatsink and fan assembly, make sure that a Thermal Interface Material is properly applied to the CPU heatsink or CPU before you install the heatsink and fan assembly.
-

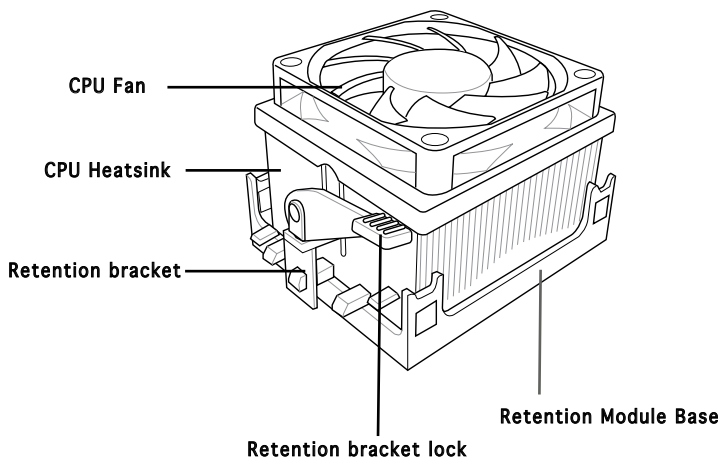

Your boxed CPU heatsink and fan assembly should come with installation instructions for the CPU, heatsink, and the retention mechanism. If the instructions in this section do not match the CPU documentation, follow the latter.

2. Attach one end of the retention bracket to the retention module base.

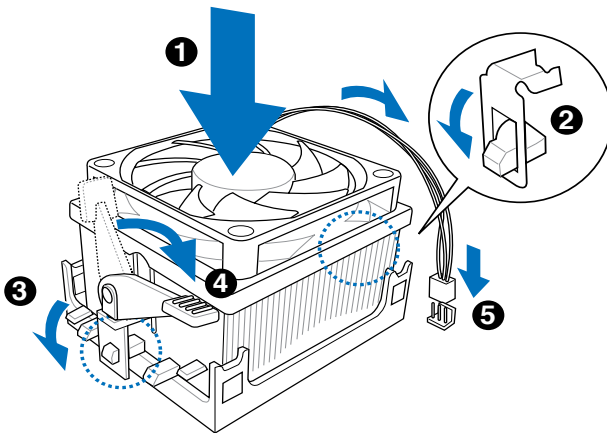

3. Align the other end of the retention bracket (near the retention bracket lock) to the retention module base. A clicking sound denotes that the retention bracket is in place.



Make sure that the fan and heatsink assembly perfectly fits the retention mechanism module base, otherwise you cannot snap the retention bracket in place.

4. Push down the retention bracket lock on the retention mechanism to secure the heatsink and fan to the module base.
5. When the fan and heatsink assembly is in place, connect the CPU fan cable to the connector on the motherboard labeled CPU_FAN.



Do not forget to connect the CPU fan connector! Hardware monitoring errors can occur if you fail to plug this connector.

2.5 Installing a DIMM

The system motherboard comes with four Double Data Rate 2 (DDR2) Dual Inline Memory Module (DIMM) sockets.

The following figure illustrates the location of the sockets:

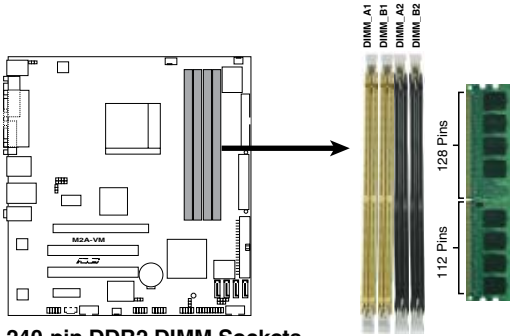

240-pin DDR2 DIMM Sockets

Channel	Sockets
Channel A	DIMM_A1 and DIMM_A2
Channel B	DIMM_B1 and DIMM_B2

2.5.1 Memory configurations

You may install up to 4 GB system memory using 256 MB, 512 MB, 1 GB, and 2 GB unbuffered ECC/non-ECC DDR2 DIMMs.



- For dual-channel configuration, the total size of memory module(s) installed per channel must be the same ($DIMM_A1 + DIMM_A2 = DIMM_B1 + DIMM_B2$).
- Always install DIMMs with the same CAS latency. For optimum compatibility, it is recommended that you obtain memory modules from the same vendor. Refer to the DDR2 Qualified Vendors List for details.
- Some odd version DDR2-667 DIMMs may not match Intel On-Die Termination (ODT) requirement and may downgrade to run at DDR2-533. If this happen, contact your retailer for the ODT value.
- This motherboard does not support memory modules made up of 128 Mb chips.

Qualified Vendors Lists (QVL) DDR2-533

Size	Vendor	Model	Side(s)	Component	A	B	C
256MB	KINGSTON	E5116AF-5C-E	SS	KVR533D2N4/256	V	V	V
512MB	KINGSTON	HYB18T512800AF37	SS	KVR533D2N4/512	V	V	V
1024MB	KINGSTON	5YDID9GCT	DS	KVR533D2N4/1G	V	V	V
512MB	Qimonda	HYB18T512800BF37	SS	HYS64T64000HU-3.7-B	V	V	V
1024MB	Qimonda	HYB18T512800BF37	DS	HYS64T128020HU-3.7-B	V	V	V
256MB	SAMSUNG	K4T51163QC-ZCD5	SS	M378T3354CZ3-CD5	V	V	V
512MB	SAMSUNG	ZCD5K4T51083QC	SS	M378T6553CZ3-CD5	V	V	V
1024MB	SAMSUNG	ZCD5K4T51083QC	DS	M378T2953CZ3-CD5	V	V	V
256MB	Hynix	HY5PS121621CFP-C4	SS	HYMP532U64CP6-C4	V	V	V
1024MB	Hynix	HY5PS12821CFP-C4	DS	HYMP512U64CP8-C4	V	V	V
256MB	CORSAIR	32M16CEDG	SS	VS256MB533D2	V	V	V
512MB	CORSAIR	MI110052432M8CEC	DS	V5512MB533D2	V	V	V
1024MB	CORSAIR	64M8CEDG	DS	V51GB533D2	V	V	V
512MB	ELPIDA	E5108AB-5C-E(ECC)	SS	EBE51ED8ABFA-5C-E	V	V	V
512MB	ELPIDA	E5108AB-5C-E	SS	EBE51UD8ABFA-5C	V	V	V
512MB	ELPIDA	E5108AB-5C-E	SS	EBE51UD8ABFA-5C-E	V	V	V

DDR2-667

Size	Vendor	Model	Side(s)	Component	DIMM Support		
					A	B	C
512MB	KINGSTON	D6408TEBGL3U	SS	KVR667D2N5/512	V	V	V
1024MB	KINGSTON	D6408TEBGL3U	DS	KVR667D2N5/1G	V	V	V
256MB	KINGSTON	HYB18T256800AF3S	SS	KVR667D2N5/256		V	V
1024MB	Qimonda	HYB18T512800BF3S(ECC)	DS	HYS72T128020HU-3S-B	V	V	V
256MB	Qimonda	HYB18T512160BF-3S	SS	HYS64T32000HU-3S-B	V	V	V
512MB	Qimonda	HYB18T512800BF3S	SS	HYS64T64000HU-3S-B	V	V	V
1024MB	Qimonda	HYB18T512800BF3S	DS	HYS64T128020HU-3S-B	V	V	V
512MB	SAMSUNG	ZCE6K4T51083QC	SS	M378T6553CZ0-CE6	V	V	V
256MB	SAMSUNG	K4T51163QC-ZCE6	SS	M378T3354CZ3-CE6	V	V	V
512MB	SAMSUNG	K4T51083QC	SS	M378T6553CZ3-CE6	V	V	V
1024MB	SAMSUNG	ZCE6K4T51083QC	DS	M378T2953CZ3-CE6	V	V	V
256MB	CORSAIR	MIII00605	SS	VS256MB667D2	V		
512MB	CORSAIR	64M8CFEG	SS	V5512MB667D2	V	V	V
1024MB	CORSAIR	64M8CFEG	DS	V51GB667D2		V	
256MB	ELPIDA	E2508AB-6E-E	SS	EBE25UC8ABFA-6E-E	V	V	V
512MB	ELPIDA	E5108AE-6E-E	SS	EBE51UD8AEFA-6E-E	V	V	V
512MB	A-DATA	AD29608A8A-3EG	SS	M20AD35G3H316611C52	V	V	V
1024MB	A-DATA	AD29608A8A-3EG	DS	M20AD5G3I417611C52	V	V	V
512MB	crucial	Heat-Sink Package	SS	BL6464AA663.8FD			
1024MB	crucial	Heat-Sink Package	DS	BL12864AA663.16FD			
1024MB	crucial	Heat-Sink Package	DS	BL12864AL664.16FD	V	V	V
1024MB	crucial	Heat-Sink Package	DS	BL12864AA663.16FD2			
512MB	Apacer	AM4B5708GQJ57E0628F	SS	AU512E667C5KBGC			V
1024MB	Apacer	AM4B5708GQJ57E	DS	AU01GE667C5KBGC	V		
256MB	Kingmax	N2TU51216AG-3C	SS	KLCB68F-36KH5	V	V	V
512MB	Kingmax	KKEA88B4LAUG-29DX	SS	KLCC28F-A8KB5	V	V	V
1024MB	Kingmax	KKEA88B4LAUG-29DX	DS	KLCD48F-A8KB5			V
512MB	Transcend	E5108AE-6E-E	SS	TS64MLQ64V6J	V	V	V
1024MB	Transcend	E5108AE-6E-E	DS	TS128MLQ64V6J			V

DDR2-667

Size	Vendor	Model	Side(s)	Component	DIMM Support		
					A	B	C
512MB	Transcend	J12Q3AB-6	SS	JM367Q643A-6	V	V	V
1024MB	Transcend	J12Q3AB-6	DS	JM388Q643A-6			
512MB	Super Talent	Heat-Sink Package	SS	T6UA512C5			V
1024MB	Super Talent	Heat-Sink Package	DS	T6UB1GC5	V	V	
512MB	SMART	G64M8XB3ITIX4TUE	SS	TB3D2667C58S	V	V	
512MB	SMART	G64M8XB3ITIX4TUE	DS	TB4D2667C58D	V	V	V

DDR2-800

Size	Vendor	Model	Side(s)	Component	DIMM Support		
					A	B	C
512MB	KINGSTON	K4T51083QC	SS	KVR800D2N5/512	V	V	V
1024MB	KINGSTON	Heat-Sink Package	DS	KHX6400D2LL/1G			
1024MB	KINGSTON	Heat-Sink Package	SS	KHX6400D2LLK2/1GN	V	V	
256MB	Qimonda	HYB18T512160BF-25F	SS	HYS64T32000HU-25F-B	V	V	V
512MB	Qimonda	HYB18T512800BF25F	SS	HYS64T64000HU-25F-B	V	V	
1024MB	Qimonda	HYB18T512800BF25F	DS	HYS64T128020HU-25F-B	V	V	V
512MB	SAMSUNG	EDD339XX	SS	M378T653C23-CE7	V	V	
256MB	SAMSUNG	K4T51163QC-ZCE7	SS	M378T3354C23-CE7	V	V	V
512MB	SAMSUNG	ZCE7K4T51083QC	SS	M378T653C23-CE7	V	V	V
1024MB	Hynix	HY5PS12821CFP-S5	DS	HYMP512U64CP8-S5	V	V	V
512MB	MICRON	5JAIIZ9DQQ	SS	MT8HTF6464AY-80EA3	V	V	V
1024MB	MICRON	5JAIIZ9DQQ	DS	MT16HTF12864AY-80EA3	V	V	V
512MB	MICRON	5ZD22D9GKX	SS	MT8HTF6464AY-80ED4	V	V	V
1024MB	MICRON	5ZD22D9GKX	DS	MT16HTF12864AY-80ED4	V	V	V
512MB	MICRON	6CD22D9GKX	SS	MT8HTF6464AY-80ED4	V	V	
1024MB	MICRON	6CD22D9GKX	DS	MT16HTF12864AY-80ED4	V	V	V
1024MB	CORSAIR	Heat-Sink Package	DS	CM2X1024-6400C4	V	V	V
1024MB	ELPIDA	E1108AB-8E-E(ECC)	SS	EBE10EE8ABFA-8E-E	V	V	V
2048MB	ELPIDA	E1108AB-8E-E(ECC)	DS	EBE21EE8ABFA-8E-E	V	V	
512MB	Crucial	Heat-Sink Package	SS	BL6464AA804.8FD			
512MB	Crucial	Heat-Sink Package	SS	BL6464AA804.8FD3	V	V	V
1024MB	Crucial	Heat-Sink Package	DS	BL12864AA804.16FD	V		
1024MB	Crucial	Heat-Sink Package	DS	BL12864AL804.16FD3	V	V	V
1024MB	Crucial	Heat-Sink Package	DS	BL12864AA804.16FD3	V	V	V
512MB	Apacer	Heat-Sink Package	DS	AHU512E800C5K1C	V		
1024MB	Apacer	Heat-Sink Package	DS	AHU01GE800C5K1C	V	V	V
512MB	Transcend	K4T51083QC	SS	TS64MLQ64V8J	V	V	V
1024MB	Transcend	K4T51083QC	DS	TS128MLQ64V8J	V	V	V
512MB	KINGMAX	KKEA88B4LZUG-2SDF	SS	KLDC28F-A8KB5			
1024MB	KINGMAX	KKEA88B4LZUG-2SDF	DS	KLDD48F-A8KB5	V	V	V

Side(s): SS - Single-sided DS - Double-sided

CL: CAS Latency

DIMM support:

- A** - Supports one module inserted into either slot, in Single-channel memory configuration.
- B** - Supports one pair of modules inserted into both slots as one pair of Dual-channel memory configuration.

2.5.2 Installing a DDR2 DIMM



Make sure to unplug the power supply before adding or removing DIMMs or other system components. Failure to do so may cause severe damage to both the motherboard and the components.

1. Unlock a DDR2 DIMM socket by pressing the retaining clips outward.
2. Align a DIMM on the socket such that the notch on the DIMM matches the break on the socket.

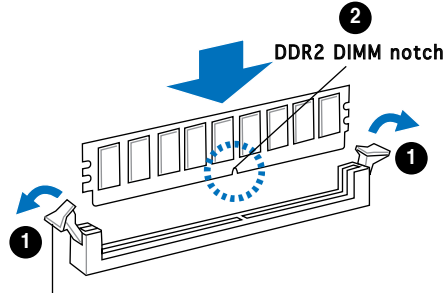

Unlocked retaining clip



A DDR2 DIMM is keyed with a notch so that it fits in only one direction. DO NOT force a DIMM into a socket to avoid damaging the DIMM.

3. Firmly insert the DIMM into the socket until the retaining clips snap back in place and the DIMM is properly seated.

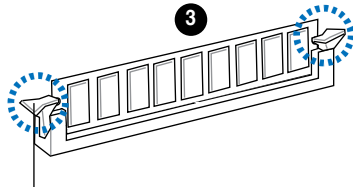

Locked Retaining Clip

2.5.3 Removing a DDR2 DIMM

Follow these steps to remove a DIMM.

1. Simultaneously press the retaining clips outward to unlock the DIMM.

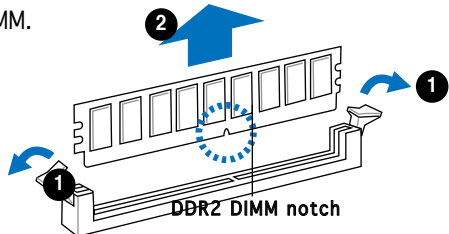

Support the DIMM lightly with your fingers when pressing the retaining clips. The DIMM might get damaged when it flips out with extra force.

2. Remove the DIMM from the socket.

2.6 Expansion slots

In the future, you may need to install expansion cards. The following sub-sections describe the slots and the expansion cards that they support.



Make sure to unplug the power cord before adding or removing expansion cards. Failure to do so may cause you physical injury and damage motherboard components.



PCI Express Graphics Slot supports most of the ATI® and NVIDIA® graphics cards, except some ATI® graphics cards of old version, such as ATI® X300, X550, X700, and X800 series.

2.6.1 Installing an expansion card

To install an expansion card:

1. Before installing the expansion card, read the documentation that came with it and make the necessary hardware settings for the card.
2. Remove the system unit cover (if your motherboard is already installed in a chassis).
3. Remove the bracket opposite the slot that you intend to use. Keep the screw for later use.
4. Align the card connector with the slot and press firmly until the card is completely seated on the slot.
5. Secure the card to the chassis with the screw you removed earlier.
6. Replace the system cover.

2.6.2 Configuring an expansion card

After installing the expansion card, configure it by adjusting the software settings.

1. Turn on the system and change the necessary BIOS settings, if any. See Chapter 5 for information on BIOS setup.
2. Assign an IRQ to the card. Refer to the tables on the next page.
3. Install the software drivers for the expansion card.

Standard interrupt assignments

IRQ	Standard Function
0	System Timer
1	Keyboard Controller
2	Re-direct to IRQ#9
4	Communications Port (COM1)*
5	IRQ holder for PCI steering*
6	Floppy Disk Controller
7	Printer Port (LPT1)*
8	System CMOS/Real Time Clock
9	IRQ holder for PCI steering*
10	IRQ holder for PCI steering*
11	IRQ holder for PCI steering*
12	PS/2 Compatible Mouse Port*
13	Numeric Data Processor
14	Primary IDE Channel
15	Secondary IDE Channel

* These IRQs are usually available for ISA or PCI devices.

IRQ assignments for this motherboard

	A	B	C	D	E	F	G	H
PCI slot 1	shared	—	—	—	—	—	—	—
PCI slot 2	—	shared	—	—	—	—	—	—
PCI Express x16 slot	shared	—	—	—	—	—	—	—
PCI Express x1 slot	—	shared	—	—	—	—	—	—
Onboard USB controller 1	—	—	—	—	—	—	—	shared
Onboard USB controller 2	—	—	—	shared	—	—	—	—
Onboard USB controller 3	—	—	shared	—	—	—	—	—
Onboard USB controller 4	—	—	—	shared	—	—	—	—
Onboard USB 2.0 controller	—	—	—	—	—	—	—	shared
Onboard IDE port	—	—	—	shared	—	—	—	—
Onboard HD audio	shared	—	—	—	—	—	—	—
Onboard LAN	—	shared	—	—	—	—	—	—



When using PCI cards on shared slots, ensure that the drivers support “Share IRQ” or that the cards do not need IRQ assignments. Otherwise, conflicts will arise between the two PCI groups, making the system unstable and the card inoperable.

2.6.3 PCI Express x1 slot

This motherboard supports PCI Express x1 network cards, SCSI cards and other cards that comply with the PCI Express specifications. The figure shows a network card installed on the PCI Express x1 slot.

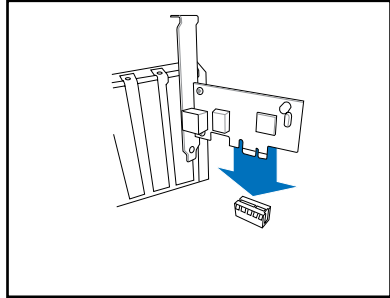

2.6.4 PCI slots

The PCI slots support cards such as a LAN card, SCSI card, USB card, and other cards that comply with PCI specifications. The figure shows a LAN card installed on a PCI slot.

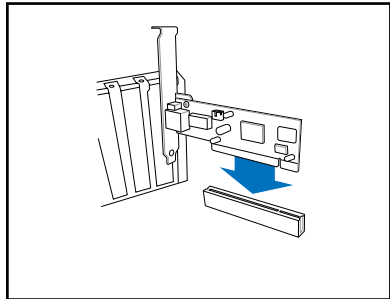

2.6.5 PCI Express x16 slot

This motherboard supports PCI Express x16 graphic cards that comply with the PCI Express specifications. The figure shows a graphics card installed on the PCI Express x16 slot.

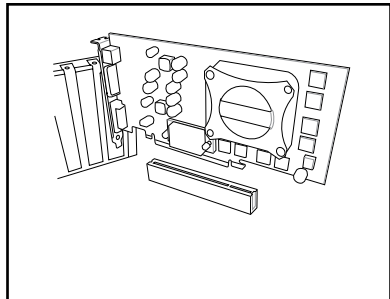

There is a HDMI card supplying along with the system. The HDMI card is to be connected to the onboard PCI Express x16 slot.

2.7 Installing an optical drive

Refer to the instructions in this section if you wish to install a new optical drive.

Follow these steps to install an optical drive:

1. Place the chassis upright.
2. Remove the drive slot metal plate cover.
3. Insert the optical drive into the upper 5.25-inch drive bay and carefully push the optical drive into the bay until its screw holes align with the holes on the bay as shown.
4. Secure the optical drive with two screws on both sides of the bay.

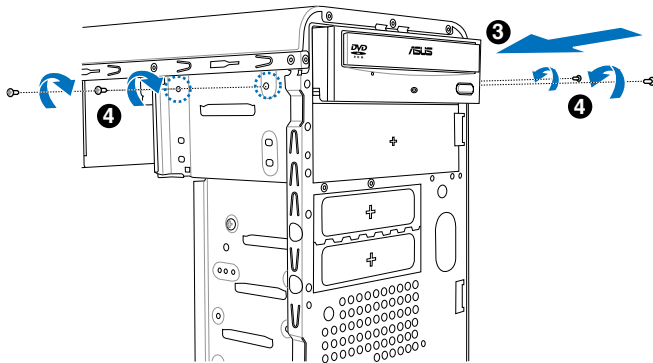

5. Connect a power cable from the power supply to the power connector at the back of the optical drive.
6. Connect one end of the IDE ribbon cable to the IDE interface at the back of the optical drive, matching the red stripe on the cable with Pin 1 on the IDE interface.

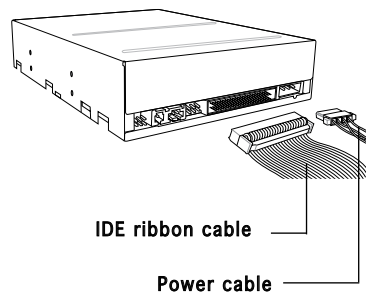

7. Connect the other end of the IDE ribbon cable to the primary IDE connector (labeled PRI_IDE) on the motherboard.
8. Remove the dummy drive slot cover from the front panel.
9. Replace the front panel.

2.8 Installing a hard disk drive

To install a Serial ATA hard disk drive:

1. Carefully place the hard disk into the the lowest 3.5-inch drive slot (without the metal plate cover).
2. Fasten the screws to secure the hard disk to the drive slot.

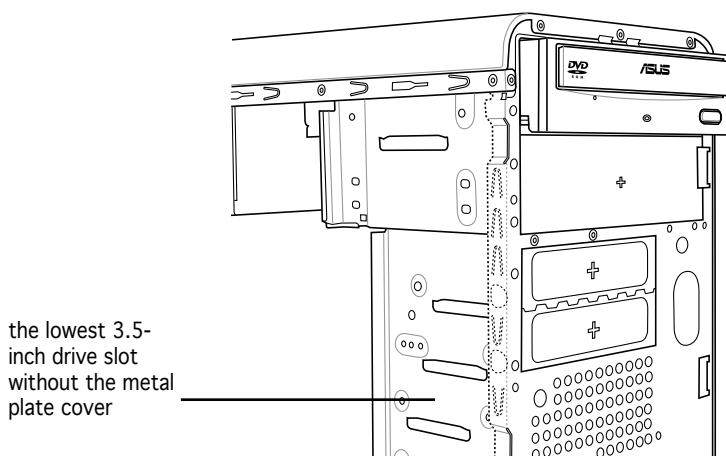

If you do not need to install the optional card reader into your system, you can install the HDD in the one of the 3.5-inch external bay (with the metal plate cover).

3. Connect one end of the Serial ATA cable to the SATA connector at the back of the drive, then connect the other end to a Serial ATA connector on the motherboard. See page 4-6 for the location of the Serial ATA connectors.

4. Connect a 15-pin Serial ATA power plug from the power supply unit to the 15-pin power connector at the back of the drive.

- OR -

Connect a 4-pin (female) power plug from the power supply unit to the 4-pin (male) power connector at the back of the drive.

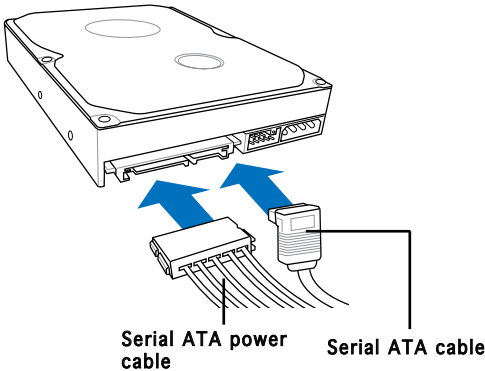

If your Serial ATA HDD has both 4-pin and 15-pin connectors at the back, use either the 15-pin SATA power adapter plug **OR** the legacy 4-pin power connector. **DO NOT** use both to prevent damage to components and to keep the system from becoming unstable.

To install an IDE hard disk drive:

1. Follow steps 1-2 of the previous section.
2. Connect the blue interface of the IDE ribbon cable to the primary IDE connector (blue connector labeled PRI_IDE) on the motherboard. See page 4-7 for the location of the connector.

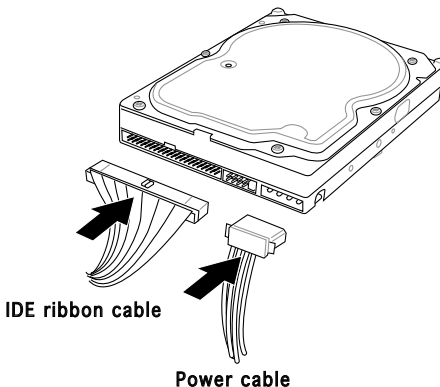



-
- If you will install only one hard disk drive, make sure to configure your hard disk drive as Master device before connecting the IDE cable and power plug. Refer to the HDD documentation on how to set the drive as a Master device.
 - If you will install two IDE hard disk drives, configure the other device as Slave.
-

3. Connect the gray interface of the IDE ribbon cable to the IDE connector on the drive.
4. If you install two IDE hard disk drives, connect the black interface of the IDE ribbon cable to the IDE connector on the second (Slave) IDE hard disk drive.
5. Connect a 4-pin power plug from the power supply unit to the power connector at the back of the drive(s).

2.9 Installing the card reader

An optional card reader module (see the figure below) is available with the system. If you want to install the card reader into your system, follow the steps on the next page.



To install the card reader module:

1. Remove the drive slot metal plate cover.
2. Carefully insert the card reader module into the 3.5-inch bay until the screw holes align with the holes on the bay.
3. Secure the card reader module with two screws on both sides.

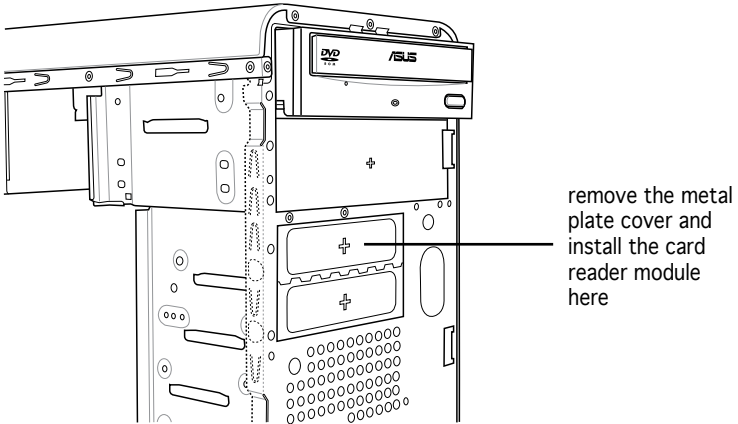

4. Connect the USB cable of the card reader to the USB connector on the motherboard.

2.10 Installing a floppy disk drive

The Vintage2-PE2 system comes with one 3.25-inch drive bay for a floppy disk drive.

To install a floppy disk drive:

1. Remove the drive slot metal plate cover.

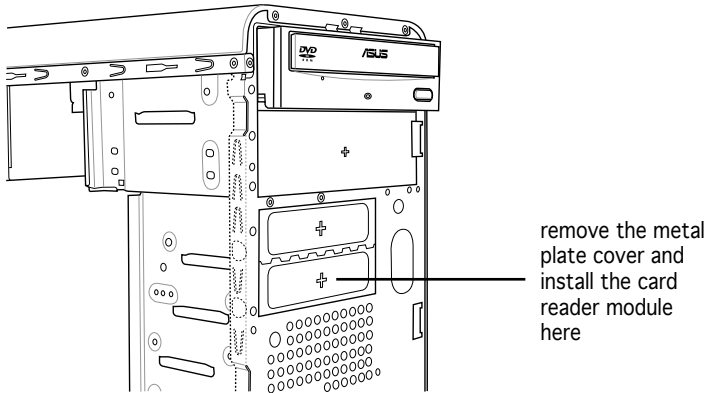

2. Carefully insert the floppy disk drive into the floppy drive bay until the screw holes align with the holes on the bay.
3. Secure the floppy disk drive with two screws on both sides.

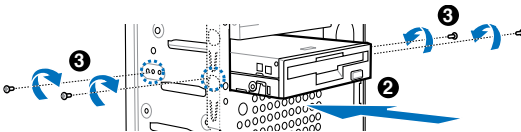

4. Connect the floppy disk drive signal cable to the signal connector at the back of the drive.

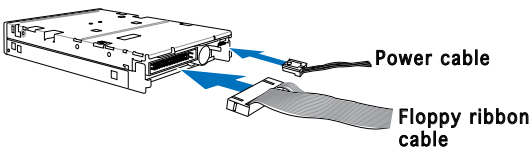

5. Connect the other end of the signal cable to the floppy disk drive connector on the motherboard. See page 4-6 for the location of the floppy disk drive connector.
6. Connect a 4-pin power cable from the power supply unit to the power connector at the back of the floppy disk drive.

2.11 Re-connecting cables

You may have disconnected some cables when you were installing components. You must re-connect these cables before you replace the chassis cover.

LED cables

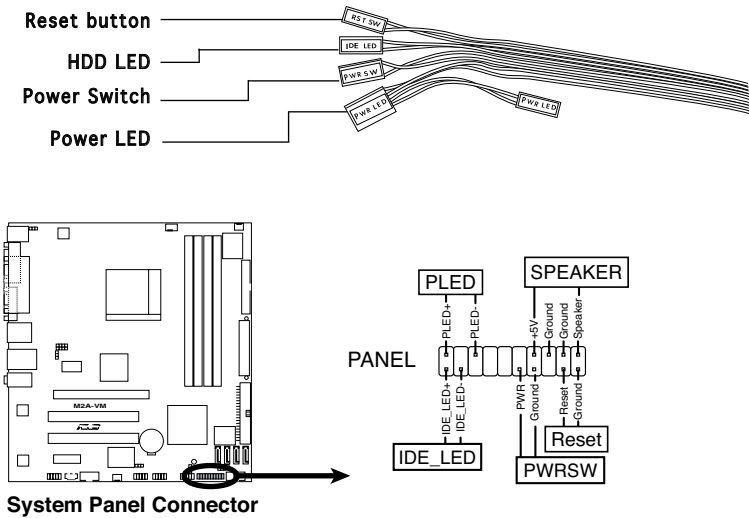

Connect the **reset button**, **power switch**, **power LED**, and **HDD LED** cables to their respective leads in the system panel connector on the motherboard.

2.12 Reinstalling the cover

If you installed an optical and/or floppy disk drive, remove the bay cover(s) on the front panel assembly before reinstalling it to the chassis. To do this:

1. Locate the bay cover locks.
2. Press the locks outward to release the bay cover.
3. Push the bay cover inward, then set it aside.
4. Follow the same instructions to remove the 3.5" drive bay cover.

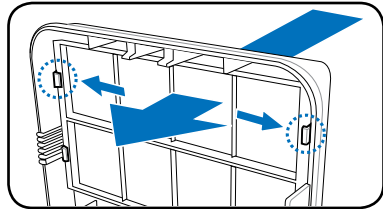

To reinstall the front panel assembly and side cover:

1. Insert the front panel assembly hinge-like tabs to the holes on the right side of the chassis.
2. Swing the front panel assembly to the left, then insert the hooks to the chassis until the front panel assembly fits in place.
3. Insert the six side cover hooks into the chassis tab holes .
4. Push the side cover to the direction of the front panel until it fits in place.
5. Secure the cover with two screws you removed earlier.



If the air duct interferes with the CPU fan, adjust the air duct accordingly.

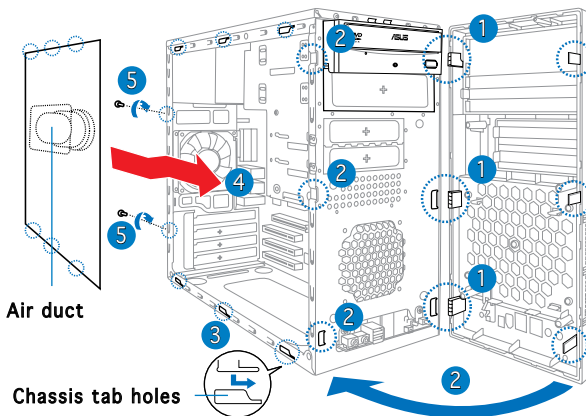

Chapter 3

This chapter helps you power up the system and install drivers and utilities from the support CD.

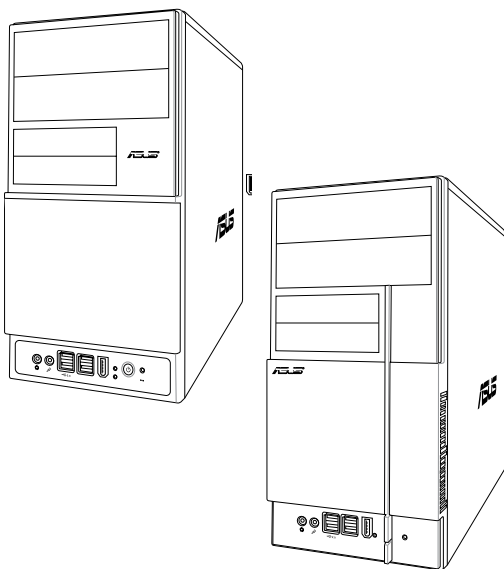

Starting up

3.1 Installing an operating system

The barebone system supports Windows® 2000/XP operating systems (OS). Always install the latest OS version and corresponding updates so you can maximize the features of your hardware.



Because motherboard settings and hardware options vary, use the setup procedures presented in this chapter for general reference only. Refer to your OS documentation for more information.



- Windows XP OS setup cannot recognize Serial ATA hard drives without the necessary drivers. Use the bundled floppy disk when installing Windows XP OS to a Serial ATA hard drive.
- From the Windows XP setup screen, press F6 when prompted then follow succeeding screen instructions to install the SATA drivers.

3.2 Powering up

Press the system power button (⏻) to enter the OS.

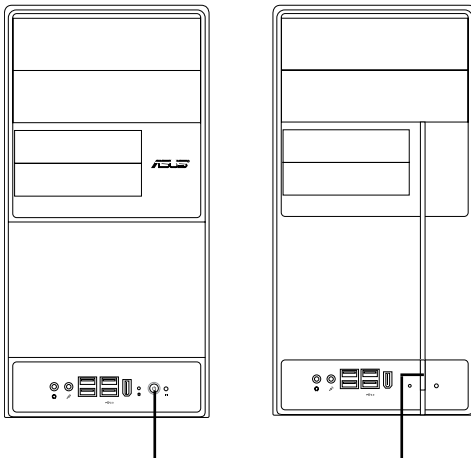

Press to turn ON the system

3.3 Support CD information

The support CD that came with the system contains useful software and several utility drivers that enhance the system features.



- Screen display and driver options may not be the same for different operating system versions.
- The contents of the support CD are subject to change at any time without notice. Visit the ASUS website for updates.

3.3.1 Running the support CD

To begin using the support CD, place the CD in your optical drive. The CD automatically displays the **Drivers** menu if Autorun is enabled in your computer.



Click an icon to display support CD/DVD/motherboard information

Click an item to install



If Autorun is NOT enabled in your computer, browse the contents of the support CD/DVD to locate the file ASSETUP.EXE from the BIN folder. Double-click the ASSETUP.EXE to run the CD/DVD.

3.3.2 Drivers menu

The drivers menu shows the available device drivers if the system detects installed devices. Install the necessary drivers to activate the devices.



ASUS InstAll - Drivers Installation Wizard

Launches the ASUS InstallAll driver installation wizard.

AMD Cool 'n' Quiet Driver

Installs the AMD Cool 'n' Quiet driver.

AMD Chipset Program Driver

Installs the AMD chipset program driver.

Realtek Audio Audio Driver

Installs the Realtek® ALC883 audio driver and application.

Realtek RTL8111b 10/100/1000M LAN Driver

Installs the Realtek® RTL8111b 10/100/1000M LAN Driver

USB 2.0 Driver

Installs the USB 2.0 driver.



The screen display and drivers option may not be the same for different operating system versions.

3.3.3 Utilities menu

The Utilities menu shows the applications and other software that the motherboard supports.



ASUS InstAll - Installation Wizard for Utilities

Launches the ASUS InstallAll utilities installation wizard.

ASUS Cool 'n' Quiet Utility

This item installs the ASUS Cool 'n' Quiet utility.

ASUS Update

The ASUS Update utility allows you to update the motherboard BIOS in a Windows® environment. This utility requires an Internet connection either through a network or an Internet Service Provider (ISP).

ASUS PC Probe II

This smart utility monitors the fan speed, CPU temperature, and system voltages, and alerts you of any detected problems. This utility helps you keep your computer in healthy operating condition.

ASUS Music Alarm

The ASUS Music Alarm is an audio alarm clock that uses your favorite CD music to give you a personal wake-up call.



The screen display and utilities option may not be the same for different operating system versions.

ATI WebPAM Utility

This utility allows you to configure Serial ATA (SATA) RAID/AHCI drive disk. For more detailed instructions, refer to the RAID manual in the support



This item appears only when you set the Onboard SATA Type item in the BIOS to [RAID Controller]. See page 2-25 for details.

3.3.4 Make Disk menu

The Make Disk menu allows you to make a RAID driver disk.



Make ATI RAID/AHCI Driver

Allows you to create an ATI® Serial ATA (SATA) RAID/AHCI driver disk.

Make ATI RAID/AHCI Vista Driver

Allows you to create an ATI® Serial ATA (SATA) RAID/AHCI driver disk for Windows® Vista Operating System (OS)..

3.3.5 Manual menu

The Manual menu contains a list of supplementary user manuals. Click an item to open the folder of the user manual.



Most user manual files are in Portable Document Format (PDF). Install the Adobe® Acrobat® Reader from the Utilities menu before opening a user manual file.



3.3.6 ASUS Contact information

Click the Contact tab to display the ASUS contact information. You can also find this information on the inside front cover of this user guide.

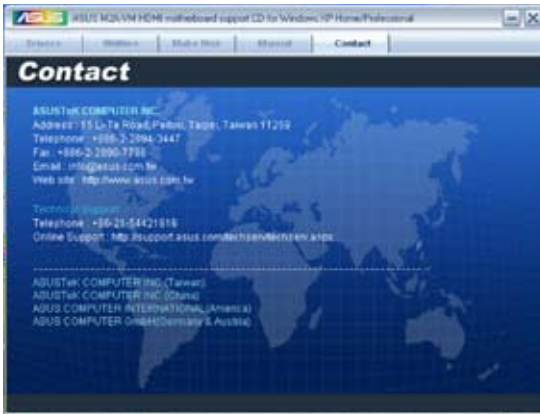

3.4 Software information

Most of the applications in the support CD have wizards that will conveniently guide you through the installation. View the online help or readme file that came with the software for more information.

ASUS PC Probe II

PC Probe II is a utility that monitors the computer's vital components and alerts you of any problem with these components. PC Probe II senses fan rotations, CPU temperature, and system voltages, among others. PC Probe II is software-based, allowing you to start monitoring your computer the moment you turn it on. With this utility, you are assured that your computer is always at a healthy operating condition.

Installing PC Probe II

To install PC Probe II on your computer:

1. Place the support CD to the optical drive. The **Drivers** installation tab appears if your computer has an enabled Autorun feature.



If Autorun is not enabled in your computer, browse the contents of the support CD to locate the setup.exe file from the ASUS PC Probe II folder. Double-click the setup.exe file to start installation.

2. Click the **Utilities** tab, then click **ASUS PC Probe II**.
3. Follow the screen instructions to complete installation.

Launching PC Probe II

You can launch the PC Probe II right after installation or anytime from the Windows® desktop.

To launch the PC Probe II from the Windows® desktop, click **Start > All Programs > ASUS > PC Probe II**. The PC Probe II main window appears.

After launching the application, the PC Probe II icon appears in the Windows® taskbar. Click this icon to close or restore the application.











Click to close the Preference panel

Using PC Probe II

Main window

The PC Probe II main window allows you to view the current status of your system and change the utility configuration. By default, the main window displays the **Preference** section. You can close or restore the **Preference** section by clicking on the triangle on the main window right handle.

Button	Function
	Opens the Configuration window
	Opens the Report window
	Opens the Desktop Management Interface window
	Opens the Peripheral Component Interconnect window
	Opens the Windows Management Instrumentation window
	Opens the hard disk drive, memory, CPU usage window
	Shows/Hides the Preference section
	Minimizes the application
	Closes the application

Sensor alert

When a system sensor detects a problem, the main window right handle turns red, as the illustrations below show.



When displayed, the monitor panel for that sensor also turns red. Refer to the **Monitor panels** section for details.

Preferences

You can customize the application using the Preference section in the main window. Click the box before each preference to activate or deactivate.

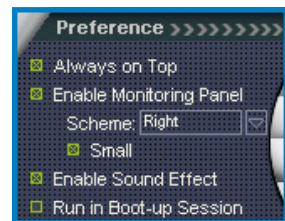

Hardware monitor panels

The hardware monitor panels display the current value of a system sensor such as fan rotation, CPU temperature, and voltages.

The hardware monitor panels come in two display modes: hexagonal (large) and rectangular (small). When you check the **Enable Monitoring Panel** option from the **Preference** section, the monitor panels appear on your computer's desktop.



Large display



Small display

Changing the monitor panels position

To change the position of the monitor panels on the desktop, click the arrow down button of the **Scheme** options, then select another position from the list box. Click **OK** when finished.



Moving the monitor panels

All monitor panels move together using a magnetic effect. If you want to detach a monitor panel from the group, click the horseshoe magnet icon. You can now move or reposition the panel independently.

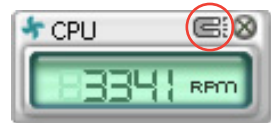

Adjusting the sensor threshold value

You can adjust the sensor threshold value in the monitor panel by clicking the arrow buttons. You can also adjust the threshold values using the **Config** window.

You cannot adjust the sensor threshold values in a small monitoring panel.

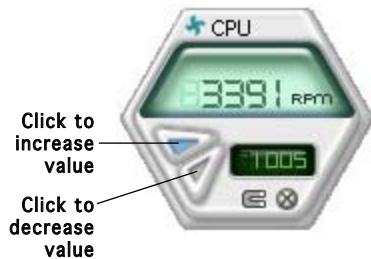

Monitoring sensor alert

The monitor panel turns red when a component value exceeds or is lower than the threshold value. Refer to the illustrations below.



Large display



Small display

WMI browser

Click **WMI** to display the WMI (Windows Management Instrumentation) browser. This browser displays various Windows® management information. Click an item from the left panel to display on the right panel. Click the plus sign (+) before **WMI Information** to display the available information.



You can enlarge or reduce the browser size by dragging the bottom right corner of the browser.

DMI browser

Click **DMI** to display the DMI (Desktop Management Interface) browser. This browser displays various desktop and system information. Click the plus sign (+) before **DMI Information** to display the available information.



PCI browser

Click **PCI** to display the PCI (Peripheral Component Interconnect) browser. This browser provides information on the PCI devices installed on your system. Click the plus sign (+) before the **PCI Information** item to display available information.



Usage

The **Usage** browser displays real-time information on the CPU, hard disk drive space, and memory usage. Click **USAGE** to display the Usage browser.

CPU usage

The **CPU** tab displays real-time CPU usage in line graph representation. If the CPU has an enabled Hyper-Threading, two separate line graphs display the operation of the two logical processors.



Hard disk drive space usage

The **Hard Disk** tab displays the used and available hard disk drive space. The left panel of the tab lists all logical drives. Click a hard disk drive to display the information on the right panel. The pie chart at the bottom of the window represents the used (blue) and the available HDD space.

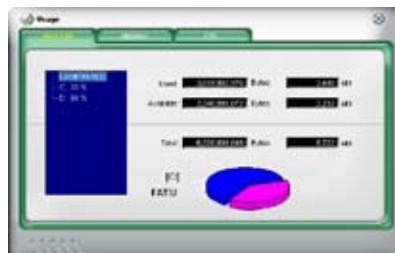

Memory usage

The **Memory** tab shows both used and available physical memory. The pie chart at the bottom of the window represents the used (blue) and the available physical memory.



Configuring PC Probe II

Click **CONFIG** to view and adjust the sensor threshold values.

The **Config** window has two tabs: **Sensor/Threshold** and **Preference**. The **Sensor/Threshold** tab enables you to activate the sensors or to adjust the sensor threshold values. The **Preference** tab allows you to customize sensor alerts, change temperature scale, or enable the Q-Fan feature.



Loads the default threshold values for each sensor

Applies your changes

Cancels or ignores your changes

Loads your saved configuration
 Saves your configuration

Chapter 4

This chapter gives information about the motherboard that comes with the system. This chapter includes the motherboard layout, jumper settings, and connector locations.

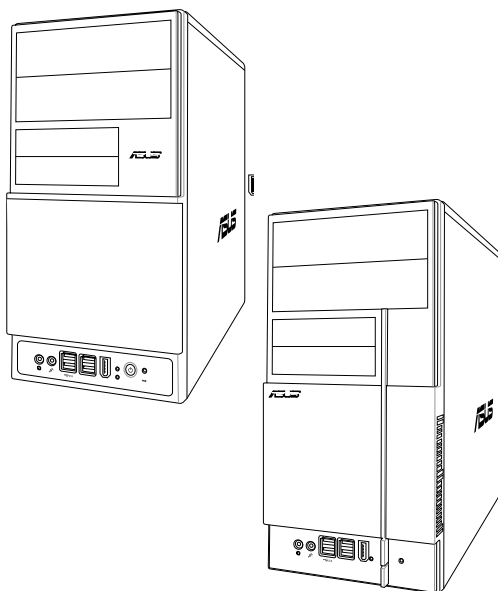

Motherboard introduction

4.1 Introduction

The Vintage V-Series M2A690G barebone system comes with an ASUS motherboard. This chapter provides technical information about the motherboard for future upgrades or system reconfiguration.

4.2 Motherboard layout

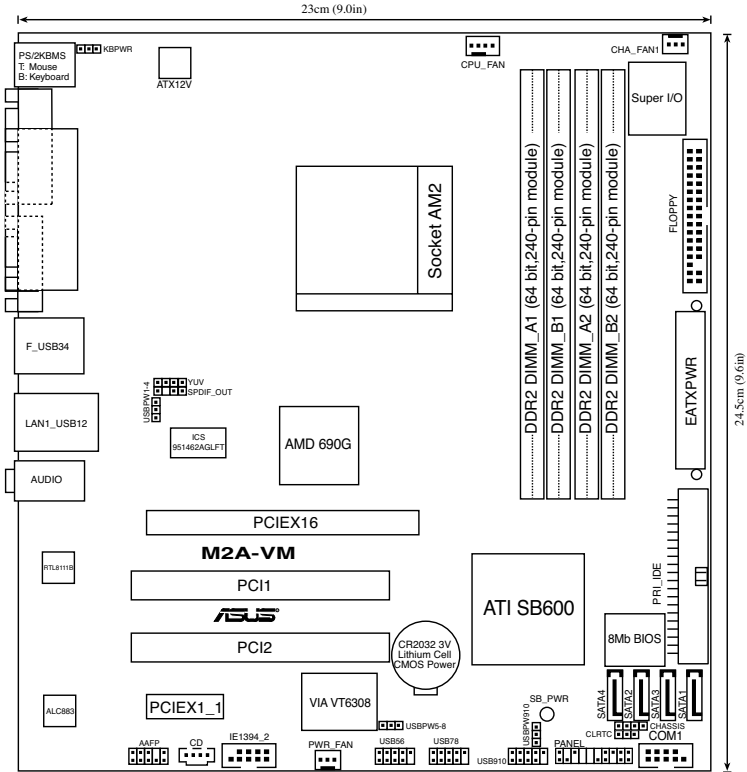

4.3 Jumpers

1. Clear RTC RAM (CLRRTC)

This jumper allows you to clear the Real Time Clock (RTC) RAM in CMOS. You can clear the CMOS memory of date, time, and system setup parameters by erasing the CMOS RTC RAM data. The onboard button cell battery powers the RAM data in CMOS, which include system setup information such as system passwords.

To erase the RTC RAM:

1. Turn OFF the computer and unplug the power cord.
2. Remove the onboard battery.
3. Move the jumper cap from pins 1-2 (default) to pins 2-3. Keep the cap on pins 2-3 for about 5~10 seconds, then move the cap back to pins 1-2.
4. Re-install the battery.
5. Plug the power cord and turn ON the computer.
6. Hold down the key during the boot process and enter BIOS setup to re-enter data.



Except when clearing the RTC RAM, never remove the cap on CLRRTC jumper default position. Removing the cap will cause system boot failure!

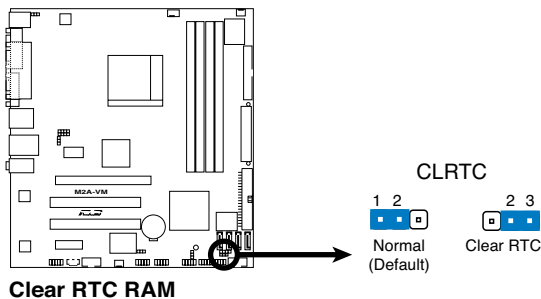

You do not need to clear the RTC when the system hangs due to overclocking. For system failure due to overclocking, use the C.P.R. (CPU Parameter Recall) feature. Shut down and reboot the system so the BIOS can automatically reset parameter settings to default values.

2. USB device wake-up (3-pin USBPW1-4, USBPW5-8, USBPW910)

Set these jumpers to +5V to wake up the computer from S1 sleep mode (CPU stopped, DRAM refreshed, system running in low power mode) using the connected USB devices. Set to +5VSB to wake up from S3 and S4 sleep modes (no power to CPU, DRAM in slow refresh, power supply in reduced power mode).

The USBPW1234 jumper is for the rear USB ports. The USBPW5678 jumper is for the internal USB connectors that you can connect to additional USB ports.

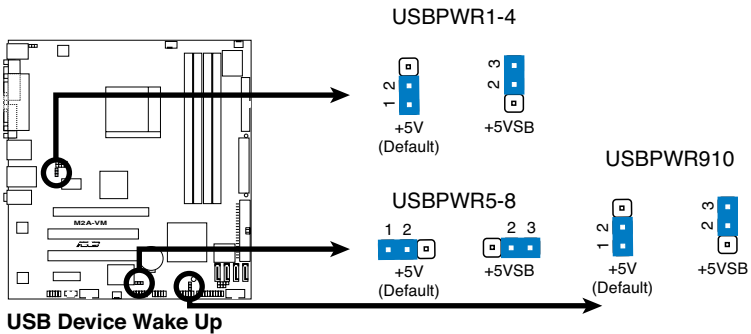

- The USB device wake-up feature requires a power supply that can provide 500 mA on the +5VSB lead for each USB port; otherwise, the system would not power up.
- The total current consumed must NOT exceed the power supply capability (+5VSB) whether under normal condition or in sleep mode.

2. Keyboard power (3-pin KBPWR)

This jumper allows you to enable or disable the keyboard wake-up feature. Set this jumper to pins 2-3 (+5VSB) to wake up the computer when you press a key on the keyboard (the default is the Space Bar). This feature requires an ATX power supply that can supply at least 500 mA on the +5VSB lead, and a corresponding setting in the BIOS.

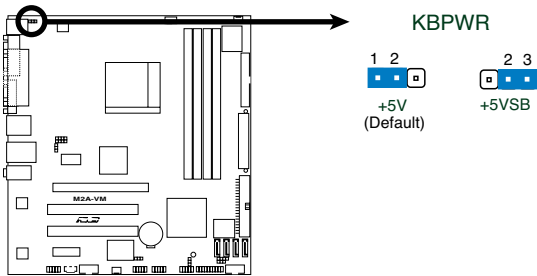

Keyboard Power Setting

4.4 Connectors

1. Floppy disk drive connector (34-1 pin FLOPPY)

This connector is for the provided floppy disk drive (FDD) signal cable. Insert one end of the cable to this connector, then connect the other end to the signal connector at the back of the floppy disk drive.



Pin 5 on the connector is removed to prevent incorrect cable connection when using an FDD cable with a covered Pin 5.

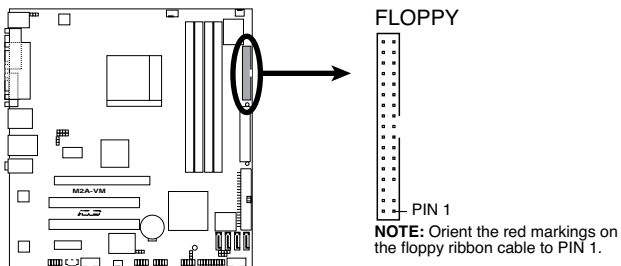

Floppy Disk Drive Connector

2. IDE connectors (40-1 pin PRI_IDE)

The onboard IDE connectors are for Ultra DMA 100/66/33 signal cables. There are three connectors on each Ultra DMA 100/66/33 signal cable: blue, black, and gray. Connect the blue connector to the motherboard's IDE connector, then select one of the following modes to configure your device(s).

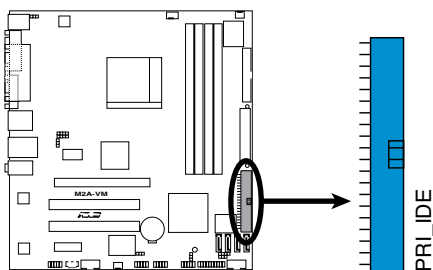

IDE Connector

	Drive jumper setting	Mode of device(s)	Cable connector
Single device	Cable-Select or Master	-	Black
Two devices	Cable-Select	Master Slave	Black Gray
	Master Slave	Master Slave	Black or gray



- Pin 20 on the IDE connector is removed to match the covered hole on the Ultra DMA cable connector. This prevents incorrect insertion when you connect the IDE cable.
- Use the 80-conductor IDE cable for Ultra DMA 100/66/33 IDE devices.



If any device jumper is set as “Cable-Select,” make sure all other device jumpers have the same setting.

3. Serial ATA connectors (7-pin SATA1, SATA2, SATA3, SATA4)

These connectors are for the Serial ATA signal cables for Serial ATA hard disk drives.

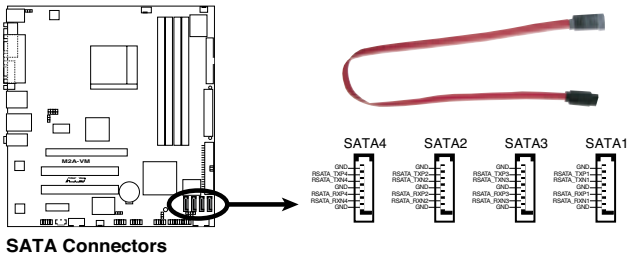

Connect the right-angle side of SATA signal cable to SATA device. Or you may connect the right-angle side of SATA cable to the onboard SATA port to avoid mechanical conflict with a long card in PCI2 slot.

right angle side

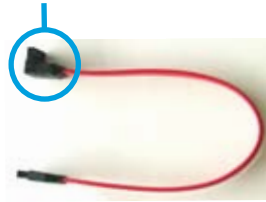

4. Serial port connector (10-1 pin COM2)

This connector is for a serial (COM) port. Connect the serial port module cable to this connector, then install the module to a slot opening at the back of the system chassis.

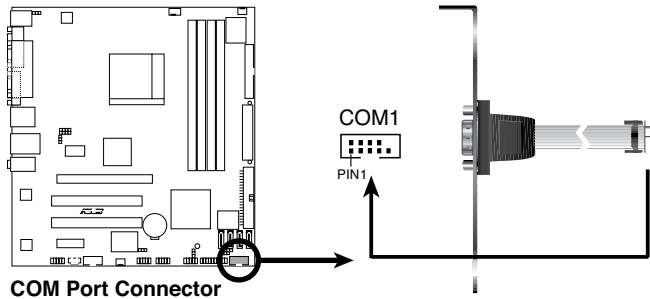

The COM module is purchased separately.

5. CPU, Power and Chassis fan connectors (4-pin CPU_FAN, 3-pin CHA_FAN, 3-pin PWR_FAN)

The fan connectors support cooling fans of a total of 1A~2.2A (26.4W max.) at +12V. Connect the fan cables to the fan connectors on the motherboard, making sure that the black wire of each cable matches the ground pin of the connector.

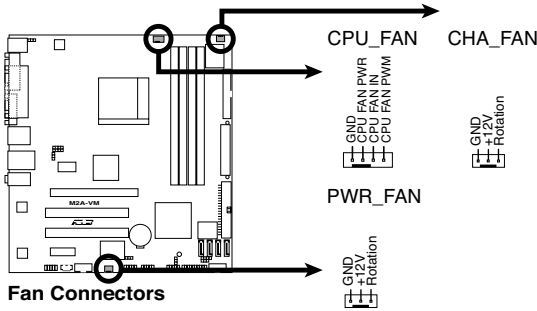

Do not forget to connect the fan cables to the fan connectors. Insufficient air flow inside the system may damage the motherboard components. These are not jumpers! DO NOT place jumper caps on the fan connectors.

6. IEEE 1394a port connector (10-1 pin IE1394_2)

This connector is for a IEEE 1394a port. Connect the IEEE 1394a module cable to this connector, then install the module to a slot opening at the back of the system chassis.

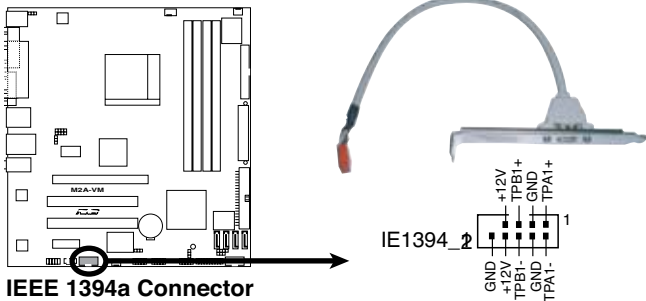

Never connect a USB cable to the IEEE1394a connector. Doing so will damage the motherboard!



The IEEE 1394 module is purchased separately.

7. ATX power connectors (24-pin EATXPWR and 4-pin ATX12V)

These connectors are for ATX power supply plugs. The power supply plugs are designed to fit these connectors in only one orientation. Find the proper orientation and push down firmly until the connectors completely fit.



- Do not forget to connect the 4-pin ATX +12 V power plug; otherwise, the system will not boot.
- Use of a PSU with a higher power output is recommended when configuring a system with more power-consuming devices. The system may become unstable or may not boot up if the power is inadequate.
- Make sure that your power supply unit (PSU) can provide at least the minimum power required by your system.
- If you intend to use a PSU with 20-pin and 4-pin power plugs, make sure that the 20-pin power plug can provide at least 15A on +12V and that the PSU has a minimum power rating of 350 W. The system may become unstable or may not boot up if the power is inadequate.
- The ATX 12 V Specification 2.0-compliant PSU passed the motherboard power requirement test with the following configuration:

CPU : Intel® Pentium® 4 3.6 GHz
 Memory : 512 MB DDR (x 4)
 Graphics card : PCI Express x16 Nvidia EN5900
 Parallel ATA devices: IDE hard disk drive (x 2)
 Serial ATA device : SATA hard disk drive
 Optical drive : CD-ROM (x2)
 SCSI devices : SCSI card and SCSI hard disk drive

- You must install a PSU with a higher power rating if you intend to install additional devices.

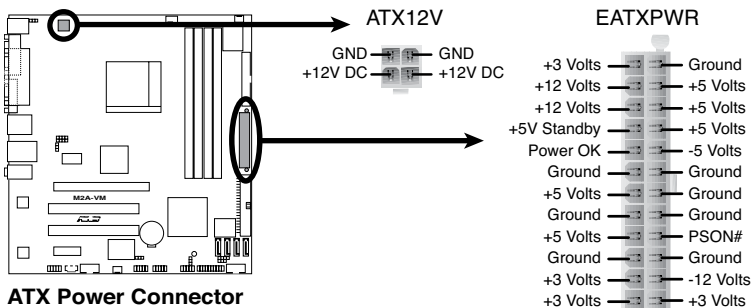

8. Optical drive audio connector (4-pin CD1)

This connector is for the 4-pin audio cable that connects to the audio connector at the back of the optical drive.

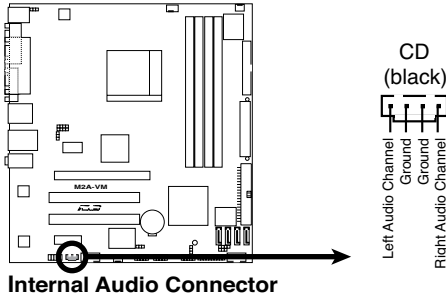

Enable the CD-IN function in the audio utility when using this connector.

9. USB connectors (10-1 pin USB56, USB78, USB910)

These connectors are for USB 2.0 ports. Connect the USB module cable to any of these connectors, then install the module to a slot opening at the back of the system chassis. These USB connectors comply with USB 2.0 specification that supports up to 480 Mbps connection speed.

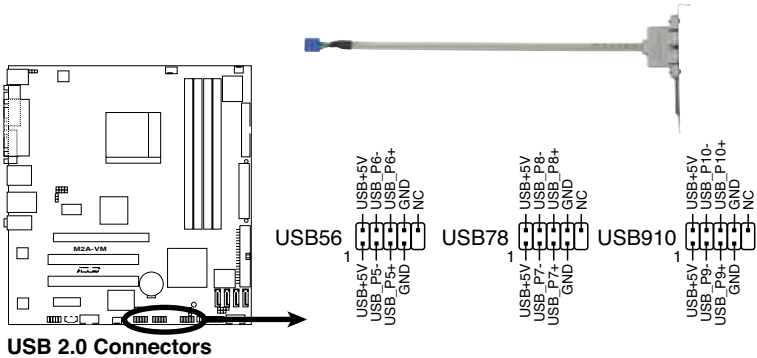

Never connect a 1394 cable to the USB connectors. Doing so will damage the motherboard!



The USB module is purchased separately.

11. Front panel audio connector (10-1 pin AAFP1)

This connector is for a chassis-mounted front panel audio I/O module that supports HD Audio standard.

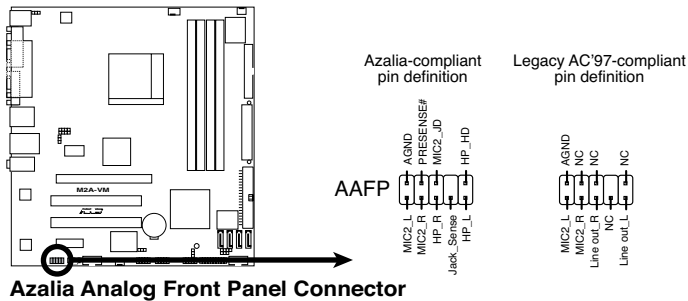

- We recommend that you connect a high-definition front panel audio module to this connector to avail of the motherboard's high-definition audio capability

13. System panel connector (12-pin PANEL)

This connector supports several chassis-mounted functions.

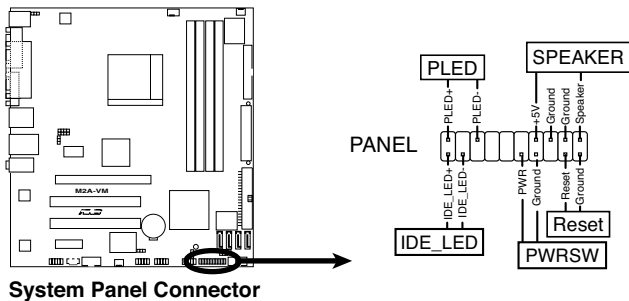

- **System power LED (2-pin PLED)**
This 2-pin connector is for the system power LED. Connect the chassis power LED cable to this connector. The system power LED lights up when you turn on the system power, and blinks when the system is in sleep mode.
- **Hard disk drive activity (2-pin HDLED)**
This 2-pin connector is for the HDD Activity LED. Connect the HDD Activity LED cable to this connector. The IDE LED lights up or flashes when data is read from or written to the HDD.
- **System warning speaker (4-pin SPEAKER)**
This 4-pin connector is for the chassis-mounted system warning speaker. The speaker allows you to hear system beeps and warnings.
- **Power/Soft-off button (2-pin PWRSW)**
This connector is for the system power button. Pressing the power button turns the system ON or puts the system in SLEEP or SOFT-OFF mode depending on the BIOS settings. Pressing the power switch for more than four seconds while the system is ON turns the system OFF.
- **Reset button (2-pin RESET)**
This 2-pin connector is for the chassis-mounted reset button for system reboot without turning off the panel system power.

14. Ports on the HDMI module

This module contains four ports, allowing you to connect any kind of video/audio source to your system. Connect the HDMI module to the onboard PCI Express x16 slot and the HDMI module cable to the onboard YUV/SPDIF_OUT connector.



- Refer to page 1-29 for the position of the onboard YUV/SPDIF_OUT connector.
- After installing the HDMI module, make sure the audio device of Sound playback is HDMI Audio rear output (the name may be different based on the OS). Go to Start > Control Panel > Sounds and Audio Devices > Sound Playback to configure the setting.

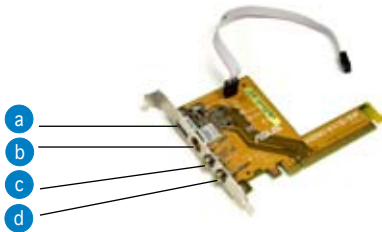

- a. HDMI port. This port is for a high-definition multimedia interface (HDMI) connector.
- b. S-Video port / YPbPr port. This 7-pin port connects any kind of video source via a YPbPr cable or an S-Video cable.



- c. Video port. This port connects any kind of video source via an RCA cable.
- d. S/PDIF Out port. This port connects an external audio output device via an coaxial S/PDIF cable.



- The YPbPr cable, RCA cable and the S-Video cable are purchased separately.
- Simultaneous output for YPbPr, AV, S, and RGB is not supported.

Dual display table

This table indicates two corresponding displays when you connect two monitors on any two of the following ports.

Onboard VGA ports		HDMI module ports	
DVI	RGB	HDMI	TV (S-Video/Video/YPbPr)
•	•		
•		•	
•			•
	•	•	
		•	•

Playback of HD DVD and Blu-Ray Discs

The speed and bandwidth of the CPU/Memory, DVD player, and drivers will affect the playback quality. Following is a configuration example for your reference. Using the CPU/Memory of higher speed and bandwidth with the higher-version DVD player and drivers will upgrade the playback quality.

CPU - AMD 3800+ X2 Dual Core

Memory - 2 x 1GB of DDR2-800 (Dual channel mode)

Playback software - CyberLink PowerDVD V.7.3

File Format	Suitable resolution	
	XP	Vista
Non protected clips	1920 x 1080p	1920 x 1080p
HD-DVD VC1	1920 x 1080i	1280 x 720p
Blu-Ray MPEG2	1280 x 720p	1280 x 720p

Chapter 5

This chapter tells how to change system settings through the BIOS Setup menus and describes the BIOS parameters.

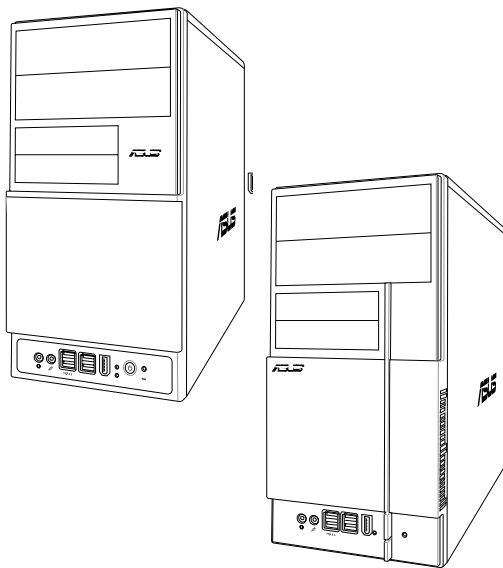

BIOS setup

5.1 Managing and updating your BIOS

The following utilities allow you to manage and update the motherboard Basic Input/Output System (BIOS) setup.

1. **ASUS EZ Flash 2** (Updates the BIOS using a floppy disk, USB Flash, or the motherboard support CD during POST.)
2. **Award BIOS Flash Utility** (Updates the BIOS in DOS mode using a bootable floppy disk.)
3. **ASUS CrashFree BIOS 3** (Updates the BIOS using a bootable floppy, USB Flash disk, or the motherboard support CD when the BIOS file fails or gets corrupted.)
4. **ASUS Update** (Updates the BIOS in Windows® environment.)

Refer to the corresponding sections for details on these utilities.



Save a copy of the original motherboard BIOS file to a bootable floppy disk in case you need to restore the BIOS in the future. Copy the original motherboard BIOS using the ASUS Update or AFUDOS utilities.

5.1.1 Creating a bootable floppy disk

1. Do either one of the following to create a bootable floppy disk.
 - DOS environment*
 - a. Insert a 1.44MB floppy disk into the drive.
 - b. At the DOS prompt, type `format a: /s` then press <Enter>.
 - Windows® XP environment*
 - a. Insert a 1.44 MB floppy disk to the floppy disk drive.
 - b. Click **Start** from the Windows® desktop, then select **My Computer**.
 - c. Select the 3 1/2 Floppy Drive icon.
 - d. Click **File** from the menu, then select **Format. A Format 3 1/2 Floppy Disk** window appears.
 - e. Select **Create an MS-DOS startup disk** from the format options field, then click **Start**.

Windows® 2000 environment

To create a set of boot disks for Windows® 2000:

- a. Insert a formatted, high density 1.44 MB floppy disk into the drive.
- b. Insert the Windows® 2000 CD to the optical drive.
- c. Click **Start**, then select **Run**.
- d. From the Open field, type
`D:\bootdisk\makeboot a:`
assuming that D: is your optical drive.
- e. Press <Enter>, then follow screen instructions to continue.

2. Copy the original or the latest motherboard BIOS file to the bootable floppy disk.

5.1.2 ASUS EZ Flash 2 utility

The ASUS EZ Flash 2 feature allows you to update the BIOS without having to go through the long process of booting from a floppy disk and using a DOS-based utility. The EZ Flash 2 utility is built-in the BIOS chip so it is accessible by pressing <Alt> + <F2> during the Power-On Self-Test (POST).

To update the BIOS using EZ Flash 2:

1. Visit the ASUS website (www.asus.com) to download the latest BIOS file for the motherboard.
2. Save the BIOS file to a floppy disk or a USB flash disk, then restart the system.
3. You can launch the EZ Flash 2 by two methods.
 - (1) Insert the floppy disk / USB flash disk that contains the BIOS file to the floppy disk drive or the USB port.

Press <Alt> + <F2> during POST to display the following.

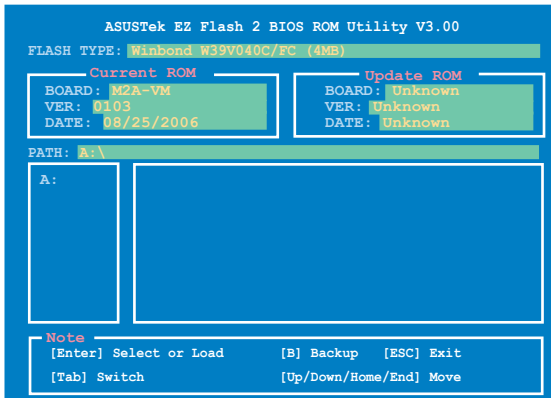

- (2) Enter BIOS setup program. Go to the **Tools** menu to select **EZ Flash 2** and press <Enter> to enable it.

You can switch between drives by pressing <Tab> before the correct file is found. Then press <Enter>.
4. When the correct BIOS file is found, EZ Flash 2 performs the BIOS update process and automatically reboots the system when done.



- This function can support devices such as USB flash disk, or floppy disk with **FAT 32/16/12** format only.
- Do not shut down or reset the system while updating the BIOS to prevent system boot failure!

5.1.3 Award BIOS Flash Utility

The Basic Input/Output System (BIOS) can be updated using the AwardBIOS Flash Utility. Follow these instructions to update the BIOS using this utility.

1. Obtain the latest BIOS file from the ASUS web site or the support CD. Normally the file name is *.BIN. Save it to a floppy disk.



Save only the updated BIOS file in the floppy disk to avoid loading the wrong BIOS file.

2. Copy the AwardBIOS Flash Utility (awdfash.exe) to the floppy disk with the latest BIOS file.
3. Boot the system in DOS mode using the bootable floppy disk you created earlier.
4. When the A:> appears, replace the bootable floppy disk with the floppy disk containing the new BIOS file and the Award BIOS Flash Utility.
5. At the prompt, type awdfash then press <Enter>. The Award BIOS Flash Utility screen appears.



The information on the screen here may not be exactly as yours and it's only for reference use.

```
AwardBIOS Flash Utility for ASUS V8.64
(C) Phoenix Technologies Ltd. All Rights Reserved

For -MCP61S-M2A-VM-00      DATE:08/25/2006
Flash Type - Winbond W39V040FC/C(4Mb)

File Name to Program: 

Message: Please input File Name!
```

6. Type the BIOS file name in the **File Name to Program** field, then press <Enter>.

```
AwardBIOS Flash Utility for ASUS V8.64
(C) Phoenix Technologies Ltd. All Rights Reserved

For -MCP61S-M2A-VM-00      DATE:08/25/2006
Flash Type - Winbond W39V040FC/C(4Mb)

File Name to Program: M2A-VM.bin
```

7. Press <N> when the utility prompts you to save the current BIOS file. The following screen appears.
8. The utility verifies the BIOS file in the floppy disk and starts flashing the BIOS file.

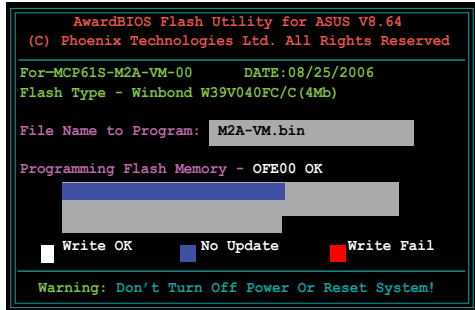

```
AwardBIOS Flash Utility for ASUS V8.64
(C) Phoenix Technologies Ltd. All Rights Reserved

For-MCP61S-M2A-VM-00    DATE:08/25/2006
Flash Type - Winbond W39V040FC/C(4Mb)

File Name to Program:  M2A-VM.bin

Programming Flash Memory - OFE00 OK

[Progress Bar]

Write OK      No Update      Write Fail

Warning: Don't Turn Off Power Or Reset System!
```



Do not turn off or reset the system during the flashing process!

9. The utility displays a Flashing Complete message indicating that you have successfully flashed the BIOS file. Remove the floppy disk then press <F1> to restart the system.

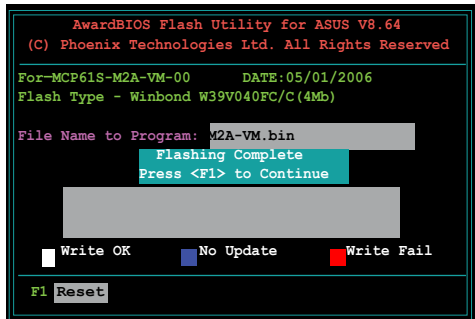

```
AwardBIOS Flash Utility for ASUS V8.64
(C) Phoenix Technologies Ltd. All Rights Reserved

For-MCP61S-M2A-VM-00    DATE:05/01/2006
Flash Type - Winbond W39V040FC/C(4Mb)

File Name to Program:  M2A-VM.bin

Flashing Complete
Press <F1> to Continue

[Progress Bar]

Write OK      No Update      Write Fail

F1 Reset
```

5.1.4 ASUS CrashFree BIOS 3 utility

The ASUS CrashFree BIOS 3 is an auto recovery tool that allows you to restore the BIOS file when it fails or gets corrupted during the updating process. You can update a corrupted BIOS file using the motherboard support CD, the floppy disk, or the USB flash disk that contains the updated BIOS file.



Prepare the motherboard support CD or the floppy disk containing the updated motherboard BIOS before using this utility.

Recovering the BIOS from the support CD

To recover the BIOS from the support CD:

1. Turn on the system.
2. Insert the support CD to the optical drive.
3. The utility displays the following message and automatically checks the CD for the BIOS file.

```
Bad BIOS checksum. Starting BIOS recovery...  
Checking for floppy...
```

When found, the utility reads the BIOS file and starts flashing the corrupted BIOS file.

```
Bad BIOS checksum. Starting BIOS recovery...  
Checking for floppy...  
Floppy not found!  
Reading file "M2A-VM.bin". Completed.  
Start flashing...
```

4. Restart the system after the utility completes the updating process.

Recovering the BIOS from a floppy/USB flash disk

To recover the BIOS from a floppy/USB flash disk:

1. Download the latest BIOS from the ASUS website (www.asus.com). Rename the BIOS file to WDG2WSP.ROM.
2. Insert the floppy/USB flash disk that contains the BIOS file to the FDD/USB port.
3. Turn on the system.

4. The utility automatically checks the devices for the BIOS file. When found, the utility reads the BIOS file and starts flashing the corrupted BIOS file.
5. Restart the system after the utility completes the updating process.



- Only the USB flash disk with FAT 32/16 format and single partition can support ASUS CrashFree BIOS 3. The device size should be smaller than 8 GB.
 - Flash time takes around one minute.
 - DO NOT shut down or reset the system while updating the BIOS! Doing so can cause system boot failure!
-

5.1.5 ASUS Update utility

The ASUS Update is a utility that allows you to manage, save, and update the motherboard BIOS in Windows® environment. The ASUS Update utility allows you to:

- Save the current BIOS file
- Download the latest BIOS file from the Internet
- Update the BIOS from an updated BIOS file
- Update the BIOS directly from the Internet, and
- View the BIOS version information.

This utility is available in the support CD that comes with the motherboard package.



ASUS Update requires an Internet connection either through a network or an Internet Service Provider (ISP).

Installing ASUS Update

To install ASUS Update:

1. Place the support CD in the optical drive. The **Drivers** menu appears.
2. Click the Utilities tab, then click Install ASUS Update.
3. The ASUS Update utility is copied to your system.



Quit all Windows® applications before you update the BIOS using this utility.

Updating the BIOS through the Internet

To update the BIOS through the Internet:

1. Launch the ASUS Update utility from the Windows® desktop by clicking **Start > Programs > ASUS > ASUSUpdate > ASUSUpdate**. The ASUS Update main window appears.

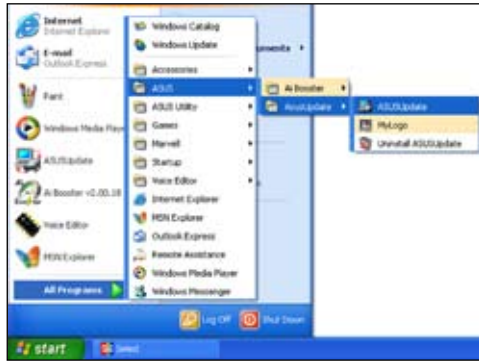

2. Select Update BIOS from the Internet option from the drop-down menu, then click **Next**.
3. Select the ASUS FTP site nearest you to avoid network traffic, or click **Auto Select**. Click **Next**.

- From the FTP site, select the BIOS version that you wish to download. Click **Next**.
- Follow the screen instructions to complete the update process.



The ASUS Update utility is capable of updating itself through the Internet. Always update the utility to avail all its features.



Updating the BIOS through a BIOS file

To update the BIOS through a BIOS file:

- Launch the ASUS Update utility from the Windows® desktop by clicking **Start > Programs > ASUS > ASUSUpdate > ASUSUpdate**. The ASUS Update main window appears.
- Select **Update BIOS from a file** option from the drop-down menu, then click **Next**.



- Locate the BIOS file from the **Open** window, then click **Open**.
- Follow the screen instructions to complete the update process.



5.2 BIOS setup program

5.2.1 BIOS menu screen

The screenshot shows the Phoenix-AwardBIOS CMOS Setup Utility menu screen. The menu bar at the top includes Main, Advanced, Power, Boot, Tools, and Exit. The main area is divided into three sections: Menu items (System Time, System Date, Legacy Diskette A, Primary IDE Master, Primary IDE Slave, SATA1, SATA2, SATA3, SATA4, HDD SMART Monitoring, Installed Memory, Usable Memory), Configuration fields (Time: 15:30:36, Date: Mon, Mar 2 2006, Legacy Diskette A: [1.44M, 3.5 in.], Primary IDE Master: [ST321122A], Primary IDE Slave: [ASUS CDS520/A], SATA1-4: [None], HDD SMART Monitoring: [Disabled], Installed Memory: 512MB, Usable Memory: 512MB), and General help (Select Menu, Item Specific Help, Change the day, month, year and century.). The legend bar at the bottom lists keyboard shortcuts: F1: Help, ESC: Exit, ↑: Select Item, →: Select Menu, -/+ : Change Value, Enter: Select SubMenu, F5: Setup Defaults, and F10: Save and Exit.

5.2.2 Menu bar

The menu bar on top of the screen has the following main items:

- Main For changing the basic system configuration
- Advanced For changing the advanced system settings
- Power For changing the advanced power management (APM) configuration
- Boot For changing the system boot configuration
- Tools For changing the system tools configuration
- Exit For selecting the exit options and loading default settings

To select an item on the menu bar, press the right or left arrow key on the keyboard until the desired item is highlighted.



- The BIOS setup screens shown in this chapter are for reference purposes only, and may not exactly match what you see on your screen.
- Visit the ASUS website (www.asus.com) to download the latest BIOS information.

5.2.3 Legend bar

At the bottom of the Setup screen is a legend bar. The keys in the legend bar allow you to navigate through the various setup menus. The following table lists the keys found in the legend bar with their corresponding functions.

Navigation Key	Function
<F1>	Displays the General Help screen
<F5>	Loads setup default values
<Esc>	Exits the BIOS setup or returns to the main menu from a sub-menu
Left or Right arrow	Selects the menu item to the left or right
Up or Down arrow	Moves the highlight up or down between fields
Page Down or - (minus)	Scrolls backward through the values for the highlighted field
Page Up or + (plus)	Scrolls forward through the values for the highlighted field
<Enter>	Brings up a selection menu for the highlighted field
<F10>	Saves changes and exit

5.2.4 Menu items

The highlighted item on the menu bar displays the specific items for that menu. For example, selecting **Main** shows the Main menu items.

The other items (Advanced, Power, Boot, and Exit) on the menu bar have their respective menu items.

5.2.5 Sub-menu items

A solid triangle before each item on any menu screen means that the item has a sub-menu. To display the sub-menu, select the item and press <Enter>.

5.2.6 Configuration fields

These fields show the values for the menu items. If an item is user-configurable, you can change the value of the field opposite the item. You cannot select an item that is not user-configurable.

A configurable field is enclosed in brackets, and is highlighted when selected. To change the value of a field, select it then press <Enter> to display a list of options. Refer to “2.2.7 Pop-up window.”

5.2.7 Pop-up window

Select a menu item then press <Enter> to display a pop-up window with the configuration options for that item.

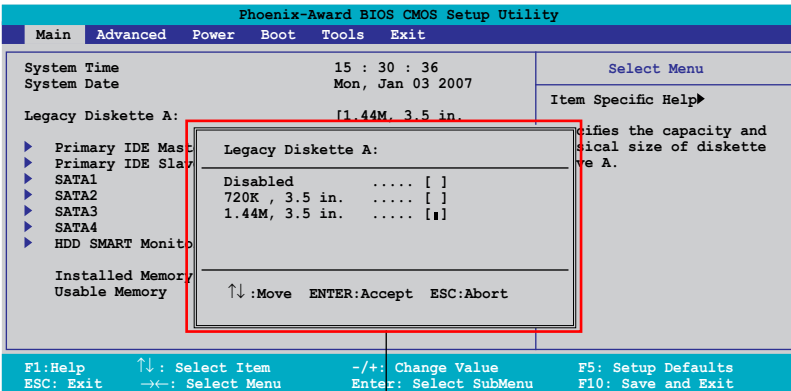

Pop-up menu

5.2.8 General help

At the top right corner of the menu screen is a brief description of the selected item.

5.3 Main menu

When you enter the BIOS Setup program, the Main menu screen appears, giving you an overview of the basic system information.



Refer to section “5.2.1 BIOS menu screen” for information on the menu screen items and how to navigate through them.

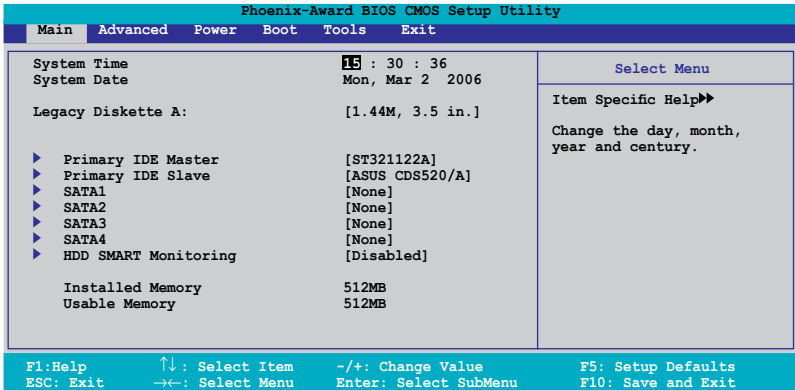

5.3.1 System Time [xx:xx:xx]

Allows you to set the system time.

5.3.2 System Date [Day xx/xx/xxxx]

Allows you to set the system date.

5.3.3 Legacy Diskette A [1.44M, 3.5 in.]

Sets the type of floppy drive installed. Configuration options: [Disabled]
[720K , 3.5 in.] [1.44M, 3.5 in.]

5.3.4 Primary IDE Master/Slave

While entering Setup, the BIOS automatically detects the presence of IDE devices. There is a separate sub-menu for each IDE device. Select a device item then press <Enter> to display the IDE device information.

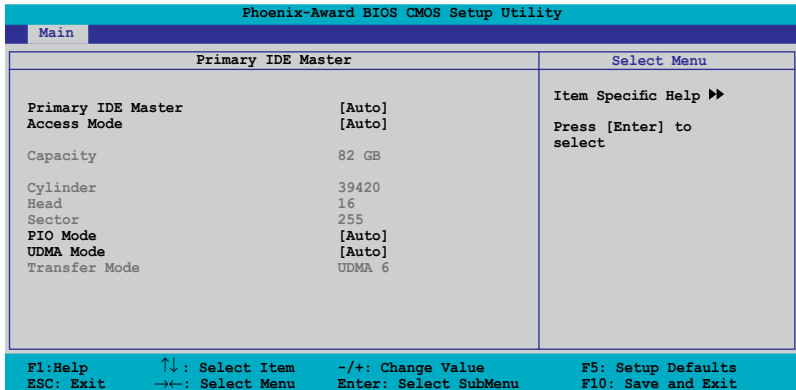

The BIOS automatically detects the values opposite the dimmed items (Capacity, Cylinder, Head, Sector and Transfer Mode). These values are not user-configurable. These items show N/A if no IDE device is installed in the system.

Primary IDE Master/Slave [Auto]

Select [Auto] to automatically detect an IDE hard disk drive. If automatic detection is successful, the BIOS automatically fills in the correct values for the remaining fields on this sub-menu. If the hard disk was already formatted on a previous system, the setup BIOS may detect incorrect parameters. Select [Manual] to manually enter the IDE hard disk drive parameters. If no drive is installed select [None]. Configuration options: [None] [Auto] [Manual]

Access Mode [Auto]

The default [Auto] allows automatic detection of an IDE hard disk drive. Select [CHS] for this item if you set the Primary IDE Master/Slave to [Manual]. Configuration options: [CHS] [LBA] [Large] [Auto]



Before attempting to configure a hard disk drive, make sure you have the correct configuration information supplied by the drive manufacturer. Incorrect settings may cause the system to fail to recognize the installed hard disk.

Capacity

Displays the auto-detected hard disk capacity. This item is not configurable.

Cylinder

Shows the number of the hard disk cylinders. This item is not configurable.

Head

Shows the number of the hard disk read/write heads. This item is not configurable.

Sector

Shows the number of sectors per track. This item is not configurable.

PIO Mode [Auto]

Sets the PIO mode for the IDE device.

Configuration options: [Auto] [Mode 0] [Mode 1] [Mode 2] [Mode 3] [Mode 4]

UDMA Mode [Auto]

Disables or sets the UDMA mode. Configuration options: [Disabled] [Auto]

Transfer Mode

Shows the Transfer mode. This item is not configurable.



After entering the IDE hard disk drive information into BIOS, use a disk utility, such as FDISK, to partition and format new IDE hard disk drives. This is necessary so that you can write or read data from the hard disk. Make sure to set the partition of the Primary IDE hard disk drives to active.

5.3.5 SATA 1-4

While entering Setup, the BIOS automatically detects the presence of Serial ATA devices. There is a separate sub-menu for each SATA device. Select a device item then press <Enter> to display the SATA device information.

Phoenix-Award BIOS CMOS Setup Utility	
Main	
SATA 1	Select Menu
Extended IDE Drive [Auto]	Item Specific Help ►► Selects the type of fixed disk connected to the system.
Access Mode [Auto]	
Capacity 0 MB	
Cylinder 0	
Head 0	
Landing Zone 0	
Sector 0	
F1: Help ↑↓: Select Item -/+ : Change Value F5: Setup Defaults	F10: Save and Exit
ESC: Exit →←: Select Menu Enter: Select SubMenu	

The BIOS automatically detects the values opposite the dimmed items (Capacity, Cylinder, Head, Precomp, Landing Zone and Sector). These values are not user-configurable. These items show 0 if no SATA device is installed in the system.

Extended Drive [Auto]

Selects the type of fixed disk connected to the system.
Configuration options: [None] [Auto]

Access Mode [Auto]

Sets the sector addressing mode. Configuration options: [Large] [Auto]



Before attempting to configure a hard disk drive, make sure you have the correct configuration information supplied by the drive manufacturer. Incorrect settings may cause the system to fail to recognize the installed hard disk.

Capacity

Displays the auto-detected hard disk capacity. This item is not configurable.

Cylinder

Shows the number of the hard disk cylinders. This item is not configurable.

Head

Shows the number of the hard disk read/write heads. This item is not configurable.

Landing Zone

Shows the number of landing zone per track. This item is not configurable.

Sector

Shows the number of sectors per track. This item is not configurable.



After entering the IDE hard disk drive information into BIOS, use a disk utility, such as FDISK, to partition and format new IDE hard disk drives. This is necessary so that you can write or read data from the hard disk. Make sure to set the partition of the Primary IDE hard disk drives to active.

5.3.6 HDD SMART Monitoring [Disabled]

Allows you to enable or disable the HDD Self-Monitoring Analysis and Reporting Technology (SMART) feature.

Configuration options: [Disabled] [Enabled]

5.3.7 Installed Memory [xxx MB]

Shows the size of installed memory.

5.3.8 Usable Memory [XXX MB]

Shows the size of usable memory.

5.4 Advanced menu

The Advanced menu items allow you to change the settings for the CPU and other system devices.



Take caution when changing the settings of the Advanced menu items. Incorrect field values can cause the system to malfunction.

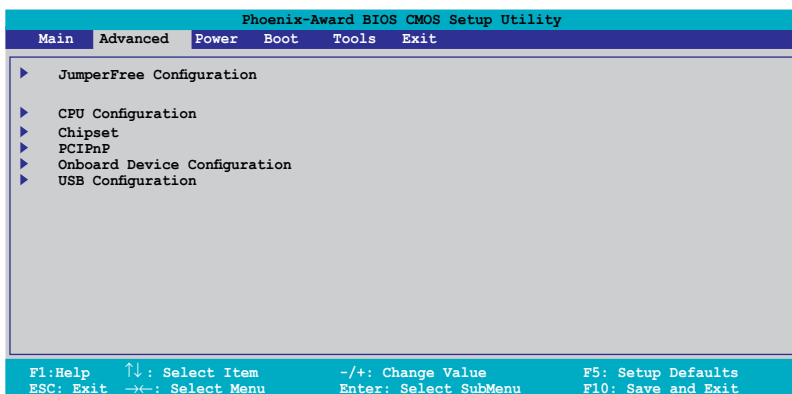

5.4.1 JumperFree Configuration

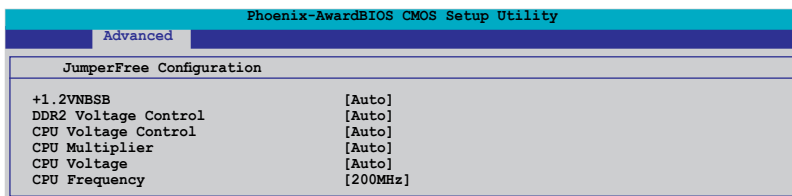

+1.2VNBSB [Auto]

Allows you to set the +1.2VNBSB voltage.

Configuration options: [Auto] [+1.20V] [+1.30V] [+1.40V] [+1.50V]

DDR2 Voltage Control [Auto]

Allows you to set the operating DDR2 voltage.

Configuration options: [Auto] [+1.80V] [+1.90V] [+2.00V] [+2.10V]

CPU Voltage Control [Auto]

Allows you to set the operating CPU voltage.

Configuration options: [Auto] [100mV]

CPU Multiplier [Auto]

Allows you to set the operating CPU multiplier.

Configuration options: [Auto] [5x] [6x] [7x] [8x] [9x]

CPU Voltage [Auto]

Allows you to set the operating voltage.

Configuration options: [Auto] [1.400v] [1.375v] [1.350v] [1.325v] [1.300v]...[0.800v]

CPU Frequency [200MHz]

Allows you to adjust the CPU frequency. Use the numeric keys to type in the desired CPU frequency. The values range from 200 to 400.

5.4.2 CPU Configuration

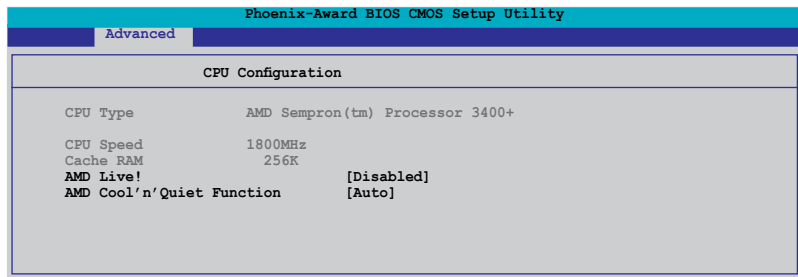

AMD Live! [Disabled]

Enables or disables the AMD Live! technology.

Configuration options: [Disabled] [Enabled]

AMD Cool 'n' Quiet Function [Disabled]

Enables or disables the AMD Cool 'n' Quiet technology.

Configuration options: [Auto] [Disabled]

5.4.3 Chipset

Phoenix-Award BIOS CMOS Setup Utility	
Advanced	
Chipset	Select Menu
▶ DRAM Configuration	Item Specific Help ▶▶
▶ LDT & PCI Bus Control	
UMA Frame Buffer Size [64MB]	
Current UMA Size 64 MB	DRAM timing and control
X Surroundview Disabled	
Spread Spectrum [Autoz]	

DRAM Configuration

Phoenix-Award BIOS CMOS Setup Utility	
Advanced	
DRAM Configuration	Select Menu
Timing Mode [Auto]	Item Specific Help ▶▶▶
x Memory Clock Frequency Auto	Control DDR2 Voltage by software

Timing Mode [Auto]

Configuration options: [Auto] [Manual]



The following item becomes user-configurable when the Timing Mode item is set to [Manual].

Memory Clock Frequency [Auto]

Allows you adjust the memory clock frequency.

Configuration options: [Auto] [DDR2 533] [DDR2 667] [DDR2 800]

LDT & PCI Bus Control

Phoenix-Award BIOS CMOS Setup Utility	
Advanced	
LDT & PCI Bus Control	Select Menu
LDT Bus Frequency [Auto]	Item Specific Help ▶▶▶

LDT Bus Frequency [Auto]

Allows you adjust the LDT Bus frequency.

Configuration options: [Auto] [1GHz] [800MHz] [600MHz] [400MHz] [200MHz]

UMA Frame Buffer Size [64MB]

Configuration options: [32MB] [64MB] [128MB] [256MB]

Surroundview [Disabled]

Allows you to disable or enable the surroundview function.

Configuration options: [Disabled] [Enabled]



This item becomes user-configurable when you install an ATI graphics card into the PCI Express x16 slot.

Spread Spectrum [Auto]

Allows you to disable or set to Auto the clock generator spread spectrum.

Configuration options: [Disabled] [Auto]

5.4.4 PCIPnP

Phoenix-Award BIOS CMOS Setup Utility		
Advanced		
PCIPnP		Select Menu
Plug & Play O/S	[No]	Item Specific Help ►►
Resources Controlled By	[Auto]	Select Yes if you are using a Plug and Play capable operating system. Select No if you need the BIOS to configure non-boot devices.
x IRQ Resources		
PCI Latency Timer(CLK)	[64]	
** PCI Express relative items **		
Maximum Payload Size	[4096]	

Plug & Play O/S [No]

When set to [No], the BIOS configures all the devices in the system.

When set to [Yes] and if you install a Plug and Play operating system, the operating system configures the Plug and Play devices not required for boot. Configuration options: [No] [Yes]

Resources Controlled By [Auto]

When set to [Auto], the BIOS automatically configures all the boot and Plug and Play compatible devices. Set to [Manual] if you want to assign the IRQ, DMA and memory base address fields.

Configuration options: [Auto] [Manual]



When the item Resources Controlled By is set to [Auto], the item IRQ Resources is grayed out and not user-configurable. Refer to the section "IRQ Resources" for information on how to enable this item.

IRQ Resources

This sub-menu is activated only when the Resources Controlled By item is set to [Manual].

Phoenix-Award BIOS CMOS Setup Utility		
Advanced		Select Menu
IRQ Resources		
IRQ-3 assigned to	[PCI Device]	Item Specific Help ▶▶
IRQ-4 assigned to	[PCI Device]	Legacy ISA for devices
IRQ-5 assigned to	[PCI Device]	compliant with the
IRQ-7 assigned to	[PCI Device]	original PC AT bus
IRQ-10 assigned to	[PCI Device]	specification, PCI/ISA PnP
IRQ-11 assigned to	[PCI Device]	for devices compliant with
IRQ-14 assigned to	[PCI Device]	
IRQ-15 assigned to	[PCI Device]	

IRQ Resources

When set to [PCI Device], the specific IRQ is free for use of PCI/PnP devices. When set to [Reserved], the IRQ is reserved for legacy ISA devices. Configuration options: [PCI Device] [Reserved]

PCI Latent Timer (CLK) [64]

Use <+> and <-> to adjust the value. The value ranges from 0 to 255.

Maximum Payload Size [4096]

Sets maximum TLP payload size for the PCI Express devices. The unit is byte. Configuration options: [128] [256] [512] [1024] [2048] [4096]

5.4.5 Onboard Device Configuration

Phoenix-Award BIOS CMOS Setup Utility		
Advanced		Select Menu
Onboard Device Configuration		
▶ South OnChip IDE Device		Item Specific Help ▶▶
▶ South OnChip PCI Device		
Front Panel Type	[HD Audio]	
Primary Display Adapter	[PCIEx]	
Onboard LAN	[Enabled]	
Onboard LAN Boot ROM	[Disabled]	
Serial Port1 Address	[3F8/IRQ4]	
Parallel Port Address	[378/IRQ7]	
Parallel Port Mode	[EPP]	
x ECP Mode Use DMA	3	

F1: Help	↑↓: Select Item	-/+ : Change Value	F5: Setup Defaults
ESC: Exit	→←: Select Menu	Enter: Select SubMenu	F10: Save and Exit

South OnChip IDE Device

Phoenix-Award BIOS CMOS Setup Utility		
Advanced		
South OnChip IDE Device		Select Menu
IDE DMA transfer access	[Enabled]	Item Specific Help ►►
OnChip IDE Channel0	[Enabled]	
IDE Prefetch Mode	[Disabled]	

IDE DMA transfer access [Enabled]

Allows you to enable or disable the IDE DMA transfer access.

Configuration options: [Disabled] [Enabled]

OnChip IDE Channel 0 [Enabled]

Allows you to enable or disable the onchip IDE channel 0 controller .

Configuration options: [Disabled] [Enabled]

IDE Prefetch Mode [Disabled]

Allows you to enable or disable the IDE PIO read prefetch mode.

Configuration options: [Disabled] [Enabled]

South OnChip PCI Device

Phoenix-Award BIOS CMOS Setup Utility		
Advanced		
South OnChip PCI Device		Select Menu
Onboard SATA Controller	[Enabled]	Item Specific Help ►►
Onboard SATA Type	[RAID Controller]	

Onboard SATA Controller [Enabled]

Allows you to enable or disable the onboard Serial ATA controller.

Configuration options: [Disabled] [Enabled]

Onboard SATA Type [IDE Controller]

Allows you to select the onboard Serial ATA type.

Configuration options: [IDE Controller] [RAID Controller] [AHCI Controller]

Front Panel Type [HD Audio]

Allows you to set the front panel audio connector (AAFP) mode to legacy AC`97 or high-definition audio depending on the audio standard that the front panel audio module supports. Configuration options: [AC97] [HD Audio]

Primary Display Adapter [PCIEx]

Sets which graphics controller to use as primary boot device.

Configuration options: [PCI Slot] [OnChipVGA] [PCIEx]

Onboard LAN [Enabled]

Allows you to enable or disable the onboard LAN device support.

Configuration options: [Disabled] [Enabled]

OnBoard LAN Boot ROM [Disabled]

Allows you to enable or disable the onboard LAN boot ROM.

Configuration options: [Disabled] [Enabled]

Serial Port1 Address [3F8/IRQ4]

Allows you to select the Serial Port1 base address.

Configuration options: [Disabled] [3F8/IRQ4] [2F8/IRQ3] [3E8/IRQ4] [2E8/IRQ3] [Auto]

Parallel Port Address [378/IRQ7]

Allows you to select the Parallel Port address.

Configuration options: [Disabled] [378/IRQ7] [278/IRQ5] [3BC/IRQ7]

Parallel Port Mode [EPP]

Allows you to select the Parallel Port mode.

Configuration options: [Normal] [EPP] [ECP] [Bi-Directional]



The "ECP Mode Use DMA" item becomes user-configurable when the Parallel Port Mode item is set to [ECP] or [Bi-Directional]

ECP Mode Use DMA [3]

Allows selection of ECP Mode. Configuration options: [1] [3]

5.4.6 USB Configuration

The items in this menu allows you to change the USB-related features.

Select an item then press <Enter> to display the configuration options.

Phoenix-Award BIOS CMOS Setup Utility	
Advanced	
USB Configuration	Select Menu
USB Controller [Enabled]	Item Specific Help ►►
USB EHCI Controller [Enabled]	
USB Legacy support [Enabled]	

USB Controller [Enabled]

Allows you to enable or disable the USB controller.

Configuration options: [Disabled] [Enabled]

USB EHCI Controller [Enabled]

Allows you to enable or disable the onchip USB controller.

Configuration options: [Disabled] [Enabled]

USB Legacy Support [Enabled]

Allows you to enable or disable support for USB devices on legacy

operating systems (OS). Configuration options: [Disabled] [Enabled]

5.5 Power menu

The Power menu items allow you to change the settings for the Advanced Configuration and Power Interface (ACPI) and the Advanced Power Management (APM). Select an item then press <Enter> to display the configuration options.

Phoenix-Award BIOS CMOS Setup Utility			
Main	Advanced	Power	Boot Tools Exit
ACPI Suspend Type [S1&S3] ACPI APIC support [Enabled]		Select Menu Item Specific Help Select the ACPI state used for System Suspend.	
▶ APM Configuration ▶ HardWare Monitor			
F1:Help ↑↓ : Select Item -/+ : Change Value F5: Setup Defaults ESC: Exit →← : Select Menu Enter: Select SubMenu F10: Save and Exit			

5.5.1 ACPI Suspend Type [S1&S3]

Allows you to select the Advanced Configuration and Power Interface (ACPI) state to be used for system suspend.

Configuration options: [S1 (POS)] [S3(STR)] [S1&S3]

5.5.2 ACPI APIC Support [Enabled]

Allows you to enable or disable the Advanced Configuration and Power Interface (ACPI) support in the Application-Specific Integrated Circuit (ASIC). When set to Enabled, the ACPI APIC table pointer is included in the RSDT pointer list. Configuration options: [Disabled] [Enabled]

5.5.3 APM Configuration

Phoenix-Award BIOS CMOS Setup Utility			
Power			
APM Configuration		Select Menu	
Power On By External Modems [Disabled] Restore on AC Power Loss [Power-Off] PWR Button < 4 secs [Instant-Off] Power Up On PCI/PCIE Devices [Disabled] HPET support [Enabled] Power Up By PS/2 Mouse [Disabled] Power Up By PS/2 Keyboard [Disabled] Power On by RTC Alarm [Disabled]		Item Specific Help	
x	Date (of Month) Alarm	0	
x	Alarm Time (hh:mm)	0 : 0 : 0	
F1:Help ↑↓ : Select Item -/+ : Change Value F5: Setup Defaults ESC: Exit →← : Select Menu Enter: Select SubMenu F10: Save and Exit			

Power On By External Modem [Disabled]

This allows either settings of [Enabled] or [Disabled] for powering up the computer when the external modem receives a call while the computer is in Soft-off mode. Configuration options: [Disabled] [Enabled]



The computer cannot receive or transmit data until the computer and applications are fully running. Thus, connection cannot be made on the first try. Turning an external modem off and then back on while the computer is off causes an initialization string that turns the system power on.

Restore on AC Power Loss [Power Off]

When set to Power Off, the system goes into off state after an AC power loss. When set to Power On, the system goes on after an AC power loss. When set to

Configuration options: [Power Off] [Power On]

PWR Button < 4 secs [Instant-Off]

Allows you to set the event after the power button is pressed for more than 4 seconds. Configuration options: [Suspend] [Instant-Off]

Power Up On PCI/PCIE Devices [Disabled]

Allows you to enable or disable the PME to wake up from S5 by PCI/PCIE devices & NV Onboard LAN. Configuration options: [Disabled] [Enabled]

HPET Support [Enabled]

Configuration options: [Enabled] [Disabled]

Power On By PS/2 Mouse [Disabled]

When set to [Enabled], this parameter allows you to use the PS/2 mouse to turn on the system. This feature requires an ATX power supply that provides at least 1A on the +5VSB lead.

Configuration options: [Disabled] [Enabled]

Power On By PS/2 Keyboard [Disabled]

Allows you to disable the Power On by PS/2 keyboard function or set specific keys on the PS/2 keyboard to turn on the system. This feature requires an ATX power supply that provides at least 1A on the +5VSB lead. Configuration options: [Disabled] [Space Bar] [Ctrl-ESC] [Power Key]

Power On By RTC Alarm [Disabled]

Allows you to enable or disable RTC to generate a wake event. When this item is set to Enabled, the items Date of Month Alarm and Time (hh:mm:ss) Alarm items become user-configurable with set values.

Configuration options: [Disabled] [Enabled]

Date of Month Alarm [xx]

To set the date of alarm, highlight this item and press <Enter> to display the Date of Month Alarm pop-up menu. Key-in a value within the specified range then press <Enter>. Configuration options: [Min=0] [Max=31]

Alarm Time (hh:mm) [xx:xx:xx]

To set the time of alarm:

1. Highlight this item and press <Enter> to display a pop-up menu for the hour field.
2. Key-in a value (Min=0, Max=23), then press <Enter>.
3. Press <TAB> to move to the minutes field then press <Enter>.
4. Key-in a minute value (Min=0, Max=59), then press <Enter>.
5. Press <TAB> to move to the seconds field then press <Enter>.
6. Key-in a value (Min=0, Max=59), then press <Enter>.

5.5.4 Hardware Monitor

The items in this sub-menu displays the hardware monitor values automatically detected by the BIOS. It also allows you to change CPU Q-Fan feature-related parameters. Select an item then press <Enter> to display the configuration options.

Phoenix-Award BIOS CMOS Setup Utility		
Power		
Hardware Monitor		Select Menu
Q-Fan Controller	[Enabled]	Item Specific Help ► Press [Enter] to enable or disable
CPU Fan Type	[DC]	
Vcore Voltage	[1.56V]	
3.3V Voltage	[3.18V]	
5V Voltage	[5.05V]	
12V Voltage	[11.58V]	
CPU Temperature	48°C	
MB Temperature	41°C	
CPU FAN Speed	3068 RPM	
CHA FAN Speed	0 RPM	
PWR FAN Speed	0 RPM	
CPU Fan Speed warning	[800 RPM]	
HPET Support	[Enabled]	

Q-Fan Controller [Disabled]

Allows you to enable or disable the Q-Fan controller.
Configuration options: [Disabled] [Enabled]

CPU Fan Type [DC]

Allows you to select the CPU fan type.
Configuration options: [DC] [PWM]

Vcore Voltage, 3.3V Voltage, 5V Voltage, 12V Voltage

The onboard hardware monitor automatically detects the voltage output through the onboard voltage regulators.
Configuration options: [xxx] [Ignored]

CPU Temperature, MB Temperature

The onboard hardware monitor automatically detects and displays the motherboard and CPU temperatures. These items are not user-configurable.

CPU Fan Speed [xxxxRPM]

CHA_FAN Speed [xxxxRPM]

PWR_FAN Speed [xxxxRPM]

The onboard hardware monitor automatically detects and displays the CPU, Chassis, and chip fan speeds in rotations per minute (RPM). If any of the fans is not connected to the motherboard, the field shows 0. These items are not user-configurable.

CPU Fan Speed warning [800 RPM]

Sets the CPU fan speed warning feature.
Configuration options: [Disabled] [800RPM] [1200RPM] [1600RPM]

5.6 Boot menu

The Boot menu items allow you to change the system boot options. Select an item then press <Enter> to display the sub-menu.

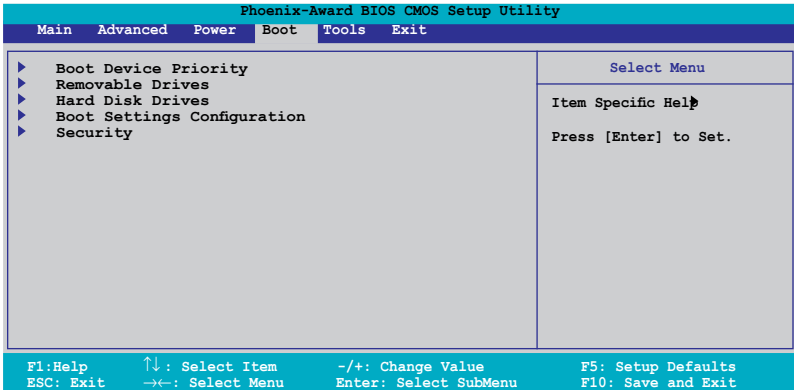

5.6.1 Boot Device Priority

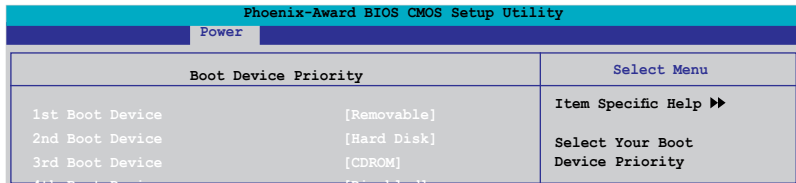

1st ~ 4th Boot Device [Removable]

These items specify the boot device priority sequence from the available devices. The number of device items that appears on the screen depends on the number of devices installed in the system.

Configuration options: [Removable] [Hard Disk] [CDROM] [Disabled]

5.6.2 Removable Drives

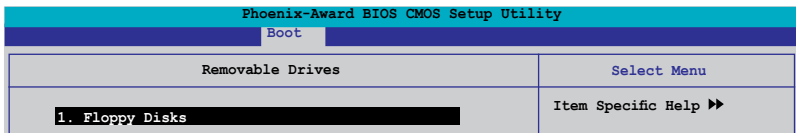

1. Floppy Disks

Allows you to assign a removable drive attached to the system.

5.6.3 Hard Disk Drives

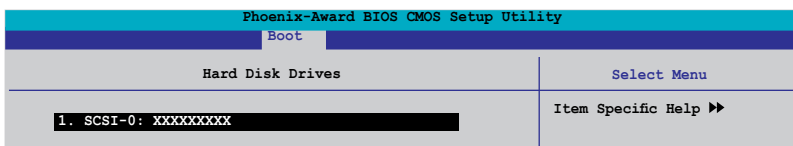

1. SATA

Allows you to assign a hard disk drive attached to the system.

5.6.4 Boot Settings Configuration

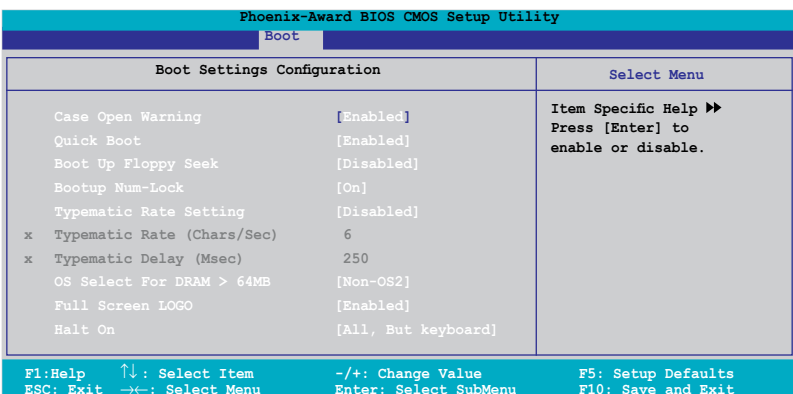

Case Open Warning [Enabled]

Enables or disables the chassis open status feature. Setting to Enabled, clears the chassis open status. Refer to section "1.10.2 Internal connectors" for setting details. Configuration options: [Disabled] [Enabled]

Quick Boot [Enabled]

Allows you to enable or disable the system quick boot feature. When Enabled, the system skips certain tests while booting. Configuration options: [Disabled] [Enabled]

Boot Up Floppy Seek [Disabled]

Enables or disables the chassis open status feature. Setting to Enabled, clears the chassis open status. Configuration options: [Disabled] [Enabled]

Bootup Num-Lock [On]

Allows you to select the power-on state for the NumLock.

Configuration options: [Off] [On]

Typematic Rate Setting [Disabled]

Allows you to set the keystroke rate. Enable this item to configure the Typematic Rate (Chars/Sec) and the Typematic Delay (Msec).

Configuration options: [Disabled] [Enabled]



The items Typematic Rate (Chars/Sec) and Typematic Delay (Msec) become user-configurable only when the item Typematic Rate Setting is enabled.

Typematic Rate (Chars/Sec) [6]

Allows you to select the rate at which a character repeats when you hold a key. Configuration options: [6] [8] [10] [12] [15] [20] [24] [30]

Typematic Delay (Msec) [250]

Allows you to set the delay before keystrokes begin to repeat. Configuration options: [250] [500] [750] [1000]

OS Select for DRAM > 64MB [Non-OS2]

Set this item to OS2 only when you are running on an OS/2 operating system with an installed RAM of greater than 64 KB.

Configuration options: [Non-OS2] [OS2]

Full Screen LOGO [Enabled]

Allows you to enable or disable the full screen logo display feature.

Configuration options: [Disabled] [Enabled]



Make sure that the above item is set to [Enabled] if you want to use the ASUS MyLogo2™ feature.

Halt On [All, But Keyboard]

Allows you to error report type.

Configuration options: [All Errors] [No Errors] [All, But Keyboard] [All, But Diskette] [All, But Disk/Key]

5.6.5 Security

Phoenix-Award BIOS CMOS Setup Utility		
Boot		
Security		Select Menu
Supervisor Password	Clear	Item Specific Help ►►
User Password	Clear	
Password Check	[Setup]	

Supervisor Password User Password

These fields allow you to set passwords:

To set a password:

1. Select an item then press <Enter>.
2. Type in a password using a combination of a maximum of eight (8) alpha-numeric characters, then press <Enter>.
3. When prompted, confirm the password by typing the exact characters again, then press <Enter>. The password field setting is changed to Set.

To clear the password:

1. Select the password field and press <Enter> twice. The following message appears:



```
PASSWORD DISABLED !!!  
Press any key to continue...
```

2. Press any key to continue. The password field setting is changed to Clear.

A note about passwords

The Supervisor password is required to enter the BIOS Setup program preventing unauthorized access. The User password is required to boot the system preventing unauthorized use.

Forgot your password?

If you forget your password, you can clear it by erasing the CMOS Real Time Clock (RTC) RAM. The RAM data containing the password information is powered by the onboard button cell battery. If you need to erase the CMOS RAM, refer to section “1.9 Jumpers” for instructions.

Password Check

This field requires you to enter the password before entering the BIOS setup or the system. Select [Setup] to require the password before entering the BIOS Setup. Select [System] to require the password before entering the system. Configuration options: [Setup] [System]

5.7 Tools menu

The Tools menu items allow you to configure options for special functions. Select an item then press <Enter> to display the sub-menu.

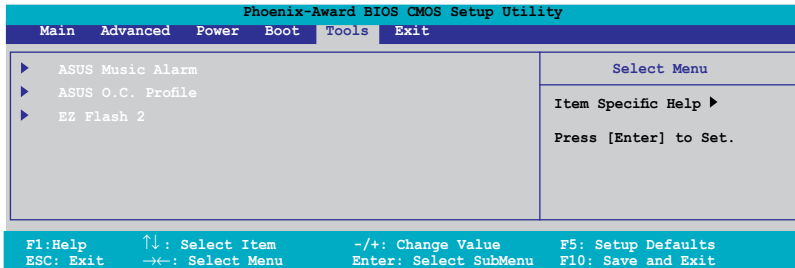

5.7.1 ASUS Music Alarm

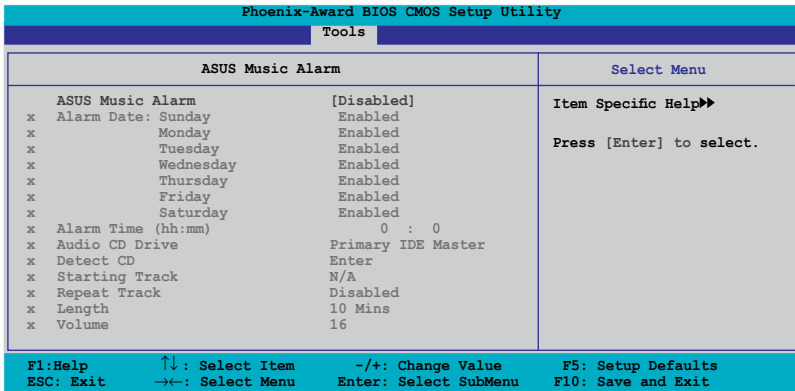

ASUS Music Alarm [Disabled]

Allows you to enable or disable the ASUS Music Alarm function.
Configuration options: [Disabled] [Enabled]



The succeeding items become user-configurable when you enable the ASUS Music Alarm.

Alarm Date: Sunday/Monday/Tuesday/Wednesday/ Thursday/Friday/Saturday [Enabled]

Allows you to enable or disable the alarm for a particular day.
Configuration options: [Disabled] [Enabled]

Alarm Time (hh:mm) 0 : 0

Allows you to set the alarm time. Press <Tab> to select the field, then use <+> or <-> to change the value. The value for hour: 0~23; the value for minute: 0~59.

Audio CD Drive [Primary IDE Master]

Allows you to select the connection configuration of the optical storage device from which the alarm music will play from.

Configuration options: [Primary IDE Master] [Primary IDE Slave]

Detect CD [Enter]

Press <Enter> to search the CD track number.

Starting Track

Allows you to choose the starting track from the CD from which you would like the alarm music to play.

Repeat Track [Disabled]

Allows you to enable or disable the repeat track function.

Configuration options: [Disabled] [Single] [All]

Length [10 Mins]

Allows you to set the length of the music alarm.

Configuration options: [10 Mins] [20 Mins] [30 Mins] [1 Hour]

Volume [16]

Allows you to set the volume level of the music alarm.

Configuration options: [01] ~ [32]



-
- Only the IDE ATAPI devices from Southbridge can support this function.
 - The system needs standby power, so ensure that the power cord is plugged.
 - ASUS Music Alarm only supports audio CDs.
-

5.7.2 ASUS O.C. Profile

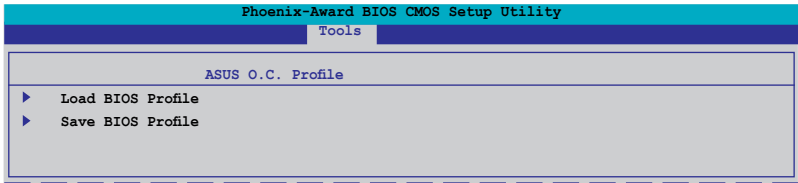

Load BIOS Profile

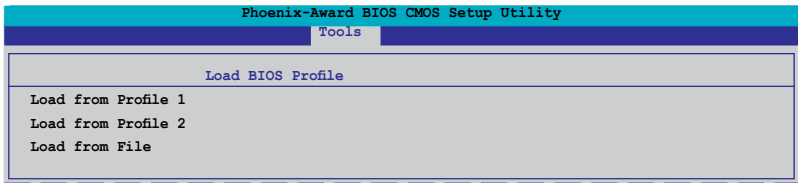

Load from Profile 1/2

Allows you to load the previous BIOS settings saved in the BIOS Flash. Press <Enter> to load the file.

Load from File

Allows you to load the previous BIOS files saved in the hard disk/floppy disk/USB flash disk with the FAT32/16/12 format. Follow the instructions below to load the BIOS file.

1. Insert the storage devices that contain the "xxx.CMO" file.
2. Turn on the system.
3. Enter BIOS setup program. Go to the "Tools" menu to select "Load from File". Press <Enter> then the setup screen will appear.
4. Press <Tab> to switch between drives before the correct "xxx.CMO" file is found. Then press <Enter> to load the file.
5. A pop-up message will inform you when the loading process finishes.



- Suggest only to update the BIOS file coming from the same memory/CPU configuration and BIOS version.
- Only the "xxx.CMO" file can be loaded.

Save BIOS Profile

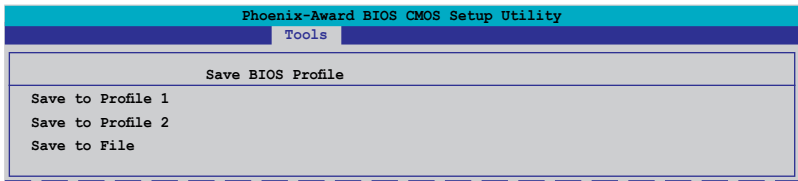

Save to Profile 1/2

Allows you to save the current BIOS file to the BIOS Flash. Press <Enter> to save the file.

Save to File

Allows you to save the current BIOS file to the hard disk/floppy disk/USB flash disk with the FAT32/16/12 format. Follow the instructions below to save the BIOS file.

1. Insert the storage devices with enough space.
2. Turn on the system.
3. Enter BIOS setup program. Go to the "Tools" menu to select "Save to File". Press <Enter> then the setup screen will appear.
4. Press <Tab> to switch between drives. Press hot-key <S> to save the file.
5. Key in the file name. Then press <Enter>.
6. A pop-up message will inform you when the loading process finishes.

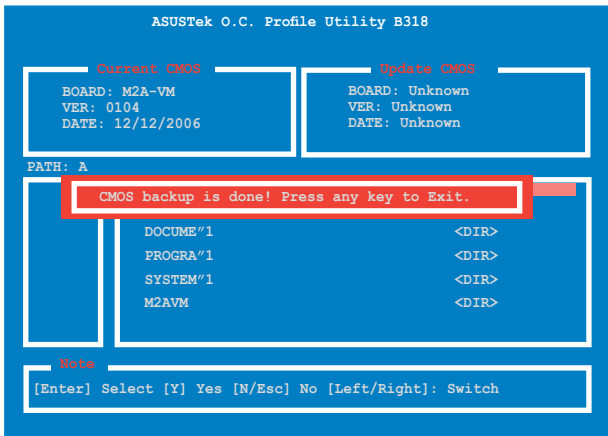

The BIOS file will be saved as "xxx.CMO".

5.7.3 ASUS EZ Flash 2

Allows you to run ASUS EZ Flash 2. When you press <Enter>, a confirmation message appears. Use the left/right arrow key to select between [Yes] or [No], then press <Enter> to confirm your choice. Please see page 2-6, section 2.1.3 for details.

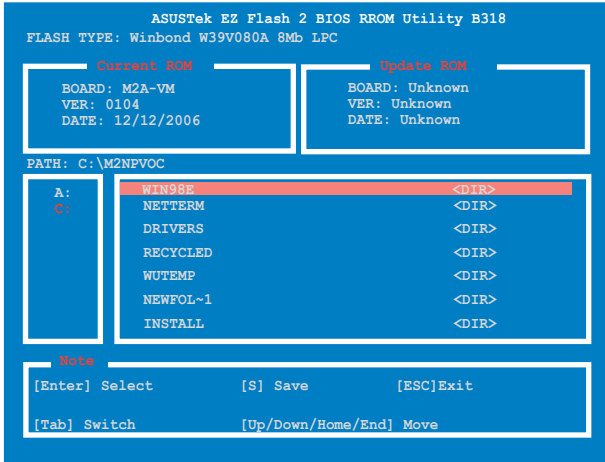

5.8 Exit menu

The Exit menu items allow you to load the optimal or failsafe default values for the BIOS items, and save or discard your changes to the BIOS items.

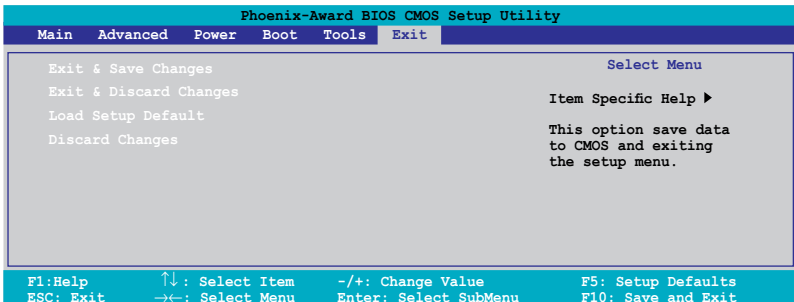



Pressing <Esc> does not immediately exit this menu. Select one of the options from this menu or <F10> from the legend bar to exit.

Exit & Save Changes

Once you are finished making your selections, choose this option from the Exit menu to ensure the values you selected are saved to the CMOS RAM. An onboard backup battery sustains the CMOS RAM so it stays on even when the PC is turned off. When you select this option, a confirmation window appears. Select YES to save changes and exit.



If you attempt to exit the Setup program without saving your changes, the program prompts you with a message asking if you want to save your changes before exiting. Press <Enter> to save the changes while exiting.

Exit & Discard Changes

Select this option only if you do not want to save the changes that you made to the Setup program. If you made changes to fields other than System Date, System Time, and Password, the BIOS asks for a confirmation before exiting.

Load Setup Defaults

This option allows you to load the default values for each of the parameters on the Setup menus. When you select this option or if you press <F5>, a confirmation window appears. Select YES to load default values. Select Exit & Save Changes or make other changes before saving the values to the non-volatile RAM.

Discard Changes

This option allows you to discard the selections you made and restore the previously saved values. After selecting this option, a confirmation appears. Select YES to discard any changes and load the previously saved values.

Free Manuals Download Website

<http://myh66.com>

<http://usermanuals.us>

<http://www.somanuals.com>

<http://www.4manuals.cc>

<http://www.manual-lib.com>

<http://www.404manual.com>

<http://www.luxmanual.com>

<http://aubethermostatmanual.com>

Golf course search by state

<http://golfingnear.com>

Email search by domain

<http://emailbydomain.com>

Auto manuals search

<http://auto.somanuals.com>

TV manuals search

<http://tv.somanuals.com>