

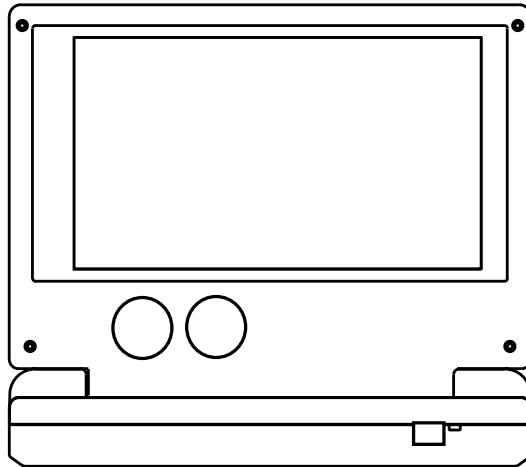

AUDIOVOX®
ELECTRONICS CORP.



D1710

Portable DVD Player

User Manual

Table of Contents

FCC and Safety Information	3
Important Safety Instructions	4
Cautions	5
DVD Disc Format and TV Format	6
Remote Control Functions	7
Front View	8
Chapter 1. DVD	
1-1 DVD Playback	9
Basic Playback	9
Stopping Playback and Returning to The Menu Screen	9
Stopping Playback	9
Fast Forward (Fast Reverse)	10
Skipping Ahead or Back to Chapters	10
Still Picture(PAUSE)	10
Repeat Viewing	10
Repeating Sections Between Two Specific Points (A-B Repeat)	10
1-2 DVD functions	11
Displaying the Time Information	11
Selecting Audio Soundtrack (Language)	11
Changing Subtitles Language	11
Viewing From Another Angle	12
To Mute the DVD Player	12
Using a DVD Menu	12
Using the Menu Function	12
Playing Kodak Picture CDs and JPEG picture CDs	13
Playing a JPEG picture with MP3 music	14
Chapter 2. Audio CD	
2-1 Audio CD Playback	15
Basic Playback	15
Playing MP3 Music Discs	15
Stopping Playback	15
Rapid Advance (Rapid Reverse)	16
Skipping Ahead or Back to Tracks	16
Pause Playback	16
2-2 Information [Audio CDs]	16
Displaying the Information of the Playing Track	16
Chapter 3. Setup	
3-1 Language Setup	17
On Screen Display (OSD) Language Setting	17
MENU Language Setting	17
AUDIO Soundtrack Language Selection [DVD]	18
SUBTITLE Language Selection [DVD]	18
3-2 Screen Setup	19
SCREEN SAVER Setting	19
TV SYSTEM Setting	20
BRIGHTNESS Setting	21
COLOR Setting	21
3-3 Custom Setup	22
PARENTAL CONTROL Setting [DVD]	22
CHANGE PASSWORD Setting [DVD]	22
ANGLE MARK Setting [DVD]	23
DEFAULT Setting	23
3-4 AUDIO Setup	24
OUTPUT Setting [DVD]	24
Chapter 4. Troubleshooting	
4-1 Troubleshooting	25
4-2 Disc Handling and Maintenance	26
4-3 Definition of Terms	27

FCC and Safety Information

CAUTION:

This unit employs a laser. Due to possible eye injury, only qualified service personnel should remove the cover or attempt to service this device. Use of controls or adjustments or performance of procedures other than those specified herein may result in hazardous radiation exposure.

NOTE:

This equipment has been tested and found to comply with the limits for a Class B digital device pursuant to part 15 of the FCC Rules. These limits are designed to provide reasonable protection against harmful interference in a residential installation. This equipment generates, uses and can radiate radio frequency energy and, if not installed and used in accordance with the instructions, may cause harmful interference to radio communications. However, there is no guarantee that interference will not occur in a particular installation. If this equipment does cause harmful interference to radio or television reception, which can be determined by turning the equipment off and on, the user is encouraged to try to correct the interference by one or more of the following measures:

- Reorient or relocate the receiving antenna.
- Increase the separation between the equipment and receiver.
- Connect the equipment into an outlet on a circuit different from that to which the receiver is connected.
- Consult the dealer or an experienced radio/TV technician for help.

This product incorporates copyright protection technology that is protected by method claims of certain U.S. patents and other intellectual property rights owned by Macrovision Corporation and other rights owners. Use of this copyright protection technology must be authorized by Macrovision Corporation, and is intended for home and other limited viewing uses only unless otherwise authorized by Macrovision Corporation. Reverse engineering or disassembly is prohibited.

Since it is usual for DVD movies to be released at different times in different regions of the world, all players have region codes and disc can have an optional region code. If you load a disc of a different region code to your player, you will see the region code notice on the screen. The disc will not play, and should be unloaded.

(Possible region codes:)



There are 6 regions (also called "locals"). Each DVD player and disc will be played in one region ONLY.

- 1: Canada, U.S., U.S. Territories
- 2: Japan, Europe, South Africa, Middle East (including Egypt)
- 3: Southeast Asia, East Asia (including Hong Kong)
- 4: Australia, New Zealand, Pacific Islands, Central America, Mexico, South America, Caribbean
- 5: Former Soviet Union, Indian Subcontinent, Africa (also North Korea, Mongolia)
- 6: China

Never make or change connections with the power switched on.

CAUTION VISIBLE AND INVISIBLE LASER RADIATION WHEN OPEN AVOID EXPOSURE TO BEAM
(WARNING LOCATION: INSIDE ON LASER COVER SHIELD)

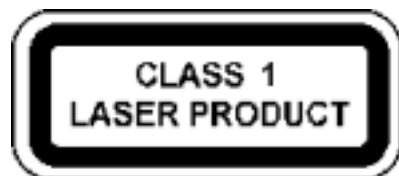

Important Safety Instructions

1. Read these instructions.
2. Keep these instructions.
3. Heed all warnings.
4. Follow all instructions.
5. Do not use this unit near water.
6. Clean only with a damp cloth.
7. Do not block any of the ventilation openings. Install in accordance with the manufacturer's instructions.
8. Do not install near any heat sources such as radiators, heat registers, stoves, or other apparatus (including amplifiers) that produce heat.
9. Do not defeat the safety purpose of the polarized-type plug. A polarized plug has two blades with one wider than the other. The wide blade is provided for your safety. When the provided plug does not fit into your outlet, consult an electrician for replacement of the obsolete outlet.
10. Protect the power cord from being walked on or pinched particularly at plug, convenience receptacles, and the point where it exits the unit.
11. Only use attachments/accessories specified by the manufacturer.
12. Unplug the unit during lightning storms or when unused for long periods of time.
13. Refer all servicing to qualified service personnel. Servicing is required when the unit has been damaged in any way; such as when the power-supply cord or plug is damaged, liquid has been spilled or objects have fallen into the unit, the unit has been exposed to rain or moisture, does not operate normally, or has been dropped.

Outdoor use or wet location applications:

An apparatus that does not comply with the requirements in Appendix A# (Outdoor Use and Wet Location Apparatus) shall be marked or the instruction manual packed with the word "WARNING" and the following or equivalent: "To reduce the risk of fire or electric shock, do not expose this apparatus to rain or moisture."

A Class II APPARATUS shall be permanently marked with the words "DOUBLE INSULATION" or "Double insulated" and "When servicing use only identical replacement parts."

WARNING: To reduce the risk of fire or electric shock, do not expose this unit to rain or moisture. The unit shall not be exposed to dripping or splashing. No objects filled with liquids, such as vases, shall be placed on the unit.

Cautions

Please read these precautions before operating this unit.

■ Power cord protection

To avoid unit malfunctions and to protect against electric shock, fire or personal injury, please observe the following.

- Hold the plug firmly when connecting or disconnecting the AC power cord.
- Keep the AC power cord away from heating appliances.
- Never put a heavy object on the AC power cord.
- Do not attempt to repair the AC power cord in any way.

■ Placement

Avoid placing the unit in areas of:

- direct sunlight, heating radiators, or closed automobiles
- high temperature over 95°F (over 35°C) or high humidity (over 90%)
- dusty areas as the internal parts may be seriously damaged.

■ Storage

When the unit is not being used, turn it off. When left unused for a long period of time, the unit should be unplugged from the power source.

■ Do not place foreign objects inside unit

- Touching internal parts of this unit is dangerous and may cause serious damage to the unit. Do not attempt to disassemble the unit.
- Do not put any foreign object on the disc tray.

■ Keep away from water and magnets

- Keep the unit away from flower vases, tubs, sinks, etc. If liquids are spilled into the unit, serious damage could occur.
- Never bring a magnet or magnetized object near the unit.

■ Condensation

Moisture may form on the lens in the following conditions:

- immediately after a heater has been turned on
- in a steamy or very humid room
- when the unit is suddenly moved from a cold environment to a warm one

If moisture forms inside this unit, it may not operate properly. In this case, turn on the power and wait about one hour for the moisture to evaporate.





■ If there is noise interference on the TV while a broadcast is being received

Depending on the reception condition of the TV, interference may appear on the TV monitor while you watch a TV broadcast and the unit is left on. This is not a malfunction of the unit or the TV. To watch a TV broadcast, turn off the unit.





DVD Disc Format and TV Format

DVD discs have the material recorded in the PAL and NTSC systems. Refer to the table below to select the correct disc type for the type of connected TV.





■ Connecting to the multi-system TV

DISC	TV MONITOR
 PAL	 Played in the PAL system.
 NTSC	 Played in the NTSC system.

■ Connecting to the NTSC TV

DISC	TV MONITOR
 PAL	 No clear images are shown on the screen.
 NTSC	 Played in the NTSC system.

■ Connecting to the PAL TV

DISC	TV MONITOR
 PAL	 Played in the PAL system.
 NTSC	 No clear images are shown on the screen.

Remote Control Functions

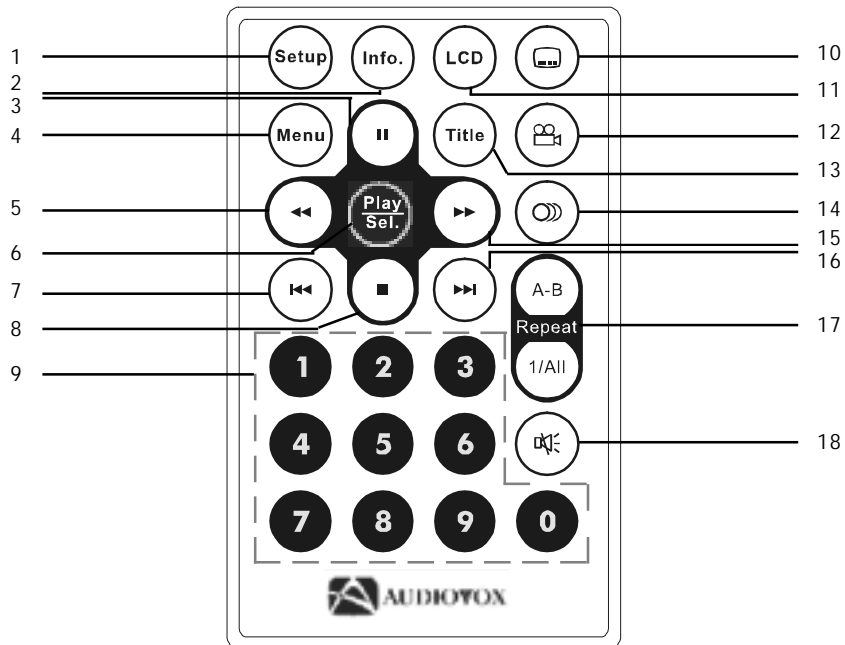

1. SETUP button
2. INFO. button
3. PAUSE button
4. MENU button
5. F. REVERSE button
6. PLAY/SEL. button
7. PREVIOUS button
8. STOP button
9. Number buttons
10. SUBTITLE button
11. LCD button
12. ANGLE button
13. TITLE button
14. AUDIO button
15. F. FORWARD button
16. NEXT button
17. A-B REPEAT button; REPEAT(1-ALL) button
18. MUTE button

Front View

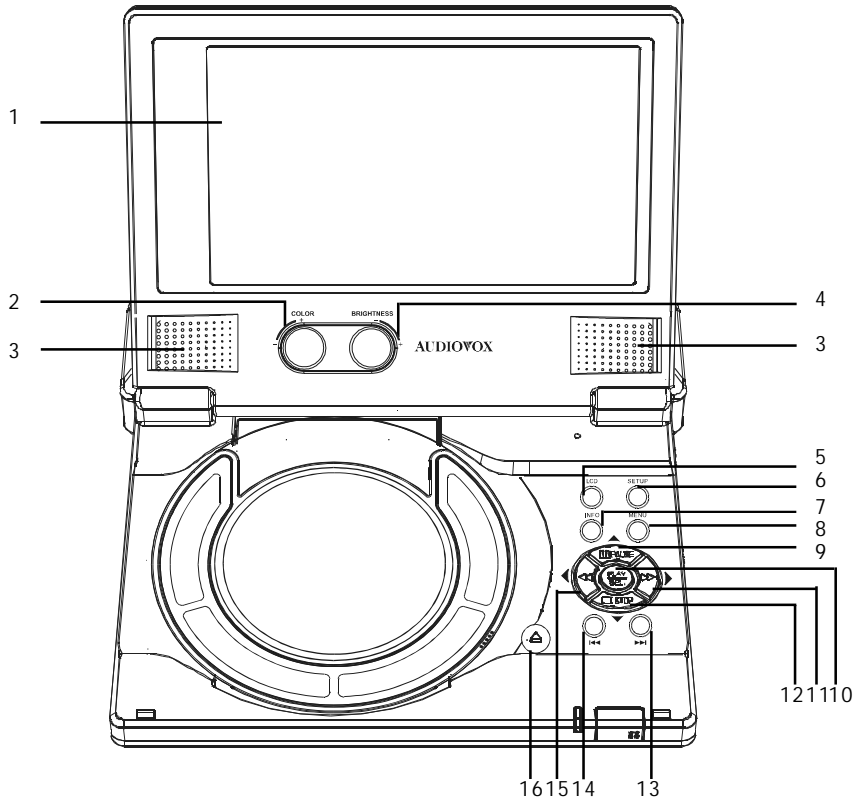

1. LCD screen
2. COLOR Adjustment
3. SPEAKERS
4. BRIGHTNESS Adjustment
5. LCD button
6. SETUP button
7. INFO. button
8. MENU button
9. PAUSE/UP button
10. PLAY/SEL. button
11. F.FWD/RIGHT button
12. STOP/DOWN button
13. NEXT button
14. PREVIOUS button
15. F.BWD/LEFT button
16. OPEN button

Note: The screen aspect ratio to 16:9, 4:3, or NORMAL by pressing LCD button several times.

1-1 DVD Playback

Basic Playback

1 Press POWER on.

2 Press OPEN to open the disc cover.

3 Hold the edge of the disc to put it in the center with the printed side up.

Hold the disc without touching its surfaces, position it with the printed title side facing up, align it with the guides, and place it in its proper position.

4 Close the disc cover.

- DVD player starts playback automatically if the disc does not have any menus recorded on it.
- If the disc has one or more titles recorded on it, a menu screen will appear on the screen.

NOTE: Proceed with steps 5 and 6 when a menu is available on the disc.

5 Press ◀ / ▶ / ▲ / ▼ or the number button(s) to select the preferred title.

NOTE: To select a title, input the number, i.e. 1 for chapter 1, 10 for chapter 10, and etc.

6 Press PLAY/SEL.

The player now starts playback of the selected title.

Stopping Playback and Returning to The Menu Screen

Press MENU. This portable DVD player stops playback, and then displays the menu screen.

After operation

When this portable DVD player is not in use, remove the disc and press POWER to turn off the player and close the display panel.

NOTE:

- The disc will continue to spin while the menu is displayed even after the player has finished playing a particular disc. When no further selections are to be played, be sure to press the STOP button to clear the menu screen.
- If the disc is placed in upside down (and it is a single sided disc), the player's display will appear "NO DISC".
- When "👉" appears when pressing a function button, it means that the corresponding operation is currently not available.

Stopping Playback

Press STOP.

1-1 DVD Playback-continued

Fast Forward and Fast Reverse)

By the remote control:

Press ◀◀ F.BWD or F.FWD ▶▶ during playback.

- Normal playback can be resumed by pressing PLAY/SEL.
- The speed of fast forwarding (▶▶ x2, ▶▶ x4, and etc) or fast reverse (◀◀ x2, ◀◀ x4, and etc.) changes for each press of the F.FWD or F.BWD button.

Skipping Ahead or Back to Chapters

Skipping Ahead

Press NEXT ▶▶▶ during playback.

Skips to the next chapter each time you press the button.

Skipping Back

Press ◀◀ PREVIOUS during playback.

Pressing the button once will return to the beginning of the currently playing chapter. Pressing the button twice or more will skip to previous chapters.

Still Picture (PAUSE)

Press PAUSE once during playback.

The picture motion is stopped (paused).

To return to normal playback press PLAY/SEL.

Repeat Viewing

1 Press 1/ALL REPEAT during playback.

Each time you press the button, the repeat function will change in the following order:

Press once: REP CHAPTER (Repeat chapter)

Press twice: REP TITLE (Repeat title)

Press three times: REP DISC (Repeat disc)

Press four times: REP off (Repeat cancelled)

To return to normal playback

Press 1/ALL REPEAT several times until "REPEAT Off" appears.

NOTE:

- Repeat playback works only with discs for which the elapsed playing time appears on the player's display during playback.
- Repeat playback may not work correctly with some DVDs.

Repeating Sections Between Two Specific Points (A-B Repeat)

1 Press A-B to select starting point (A).

"REP A" appears on the screen.

2 Press A-B again to select end point (B).

"REP B" appears on the screen. The player will playback the the material between Point and Point B.

Press A-B again. To return to normal playback

("REPEAT Off" appears on the screen.)

NOTE: A-B repeat playback works only when starting Point A and ending Point B are within the same chapter.

1-2 DVD functions

Displaying the time information

Displaying the time information

1 Press INFO. during playback.

Press INFO. multiple times to display the title number, chapter number, and other information on the screen.

Cancelling the time information

Press INFO. a multiple times until the information disappears.

Selecting Audio Soundtrack (Language)

You can change the audio language from the one selected at the initial settings to a different language. (This feature is operational only with discs that were recorded with multiple audio soundtrack languages).

1 Press AUDIO during playback.

2 Press AUDIO multiple times until the preferred language is selected.

NOTE:

- When the desired language is not selected after pressing the button several times, this may indicate that the this language is not available on the disc.
- When you turn on or remove the disc, this portable DVD player will use the language which is selected at the initial setting. If you select a language which is not recorded on the disc this portable DVD player will playback a prior language programmed on the disc.

Changing Subtitle Language

1 Press SUBTITLE during playback.

When no subtitles are available "  " will appear on the display.

2 Press SUBTITLE multiple times until the preferred language is selected.

NOTE:

- When the preferred subtitle language is not selected even after pressing the button several times, it may indicate that the language is not available on the disc.
 - After removing the disc, the selected subtitle setting will be cancelled and the player's default subtitle will be reinstated. If you select a subtitle language which is not recorded on the disc this portable DVD player will playback a prior subtitle language programmed on the disc.
-

1-2 DVD functions-continued

Viewing From Another Angle

Some DVD discs may contain scenes which have been shot simultaneously from a few number of different angles. For these discs, the same scenes can be viewed from each of these different angles using the ANGLE  button. (The recorded angles vary depending on the disc programmed.)

1 Press ANGLE during playback.

2 Press ANGLE a number of times until the preferred viewing angle is selected.

Press the ANGLE  button multiple times to change the viewing angle.

NOTE:

- ANGLE will only function on discs where different angles are available.
- The viewing angles are shown on the player's display and you can select one from them for viewing.

To Mute the DVD Player

This portable DVD player provides a MUTE function for your selections.

1 Press MUTE button during playback.

- When "MUTE" appears on the screen, this portable DVD player is muted. To restore the audio, press the button again. "MUTE OFF" will appear on the screen.

Using a DVD Menu

Some DVD discs have unique menu structures called DVD menus. For example, DVDs programmed with complex contents provide guide menus, and those recorded with various languages provide menus for audio and subtitle language. Although the DVD menu's contents and operation vary from disc to disc, the following explains basic operation when this feature is used.

1 Press TITLE in stop mode

The DVD menu available on the disc now appears.

2 Use ◀ / ▶ / ▲ / ▼ buttons to select the desired menu item.

3 Press PLAY/SEL.

To enter other menu screens, repeat steps 2 and 3.

To return to the previous menu screen, press TITLE.

Using the MENU Function

1 Press PLAY/SEL.

2 Press MENU.

A DVD chapter menu with brief description of each item will appear. You may now see the introduction of each chapter and decide which chapter to select for playback.

3 Press ◀ / ▶ / ▲ / ▼ buttons or number button(s) to select the desired preferred item.

NOTE: The menu contents details will vary depending on the manner in which the discs were recorded.

1-2 DVD functions-continued

Playing Kodak Picture CDs and JPEG picture CDs

With this DVD player you can view Kodak picture CDs and JPEG pictures for viewing on the screen.

Basic Playback

- 1 Load a Kodak picture CD or a JPEG picture CD. After few seconds, the player starts to display the pictures in slide show automatically.
- 2 You can select a picture to view by pressing it's corresponding number press the number corresponding to the order of the picture. This player will begin to display the slide show from the selected picture.

To stop slide show, press the STOP button.

PAUSE, NEXT and PREV.

- 1 Press PAUSE to pause the slide show.
- 2 Press NEXT ►► and PREVIOUS ◀◀ to view the next or previous picture.

To resume slide show, press PLAY/SEL. again.

Rotating

- 1 When the picture is paused, press ◀ / ▶ to rotate the picture by 90 degree.

INFO.

- 1 Press INFO. The TV screen will appear, for example, TRK: 3/150 (The sequential order of the current picture/ Total pictures.)

NOTE:

- Features **Rotating** can only work on Kodak Picture CDs.

1-2 DVD functions-continued

Playing a JPEG picture with MP3 music

You can select your favorite JPEG picture to display on the TV screen while playing MP3 music.

- 1 Load a disc containing MP3 music and JPEG pictures. This portable DVD player starts playing the JPEG pictures in slide show automatically.
- 2 Press STOP at the picture you like during slide show. At the mean time, you can see the following screen appear.

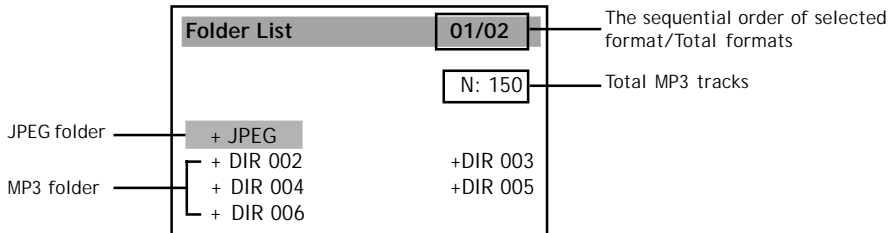

- 3 Press ◀/▶ to select a MP3 folder then press PLAY/SEL. The following next screen appears:

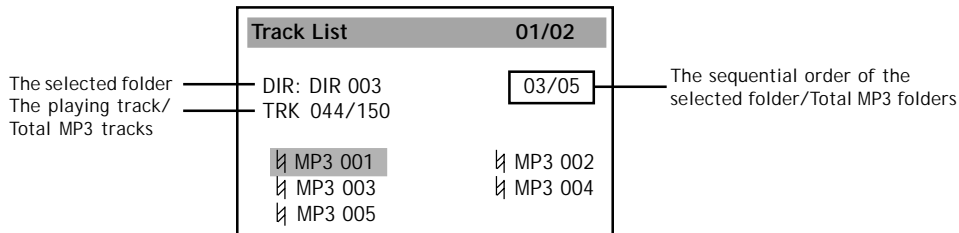

- 4 To select a different track
 - a. press NEXT ▶▶▶ or PREVIOUS ◀◀◀ to play the next or previous track,
 - b. press ◀/▶ to select the MP3 track, and then press PLAY/SEL. to play.
 - c. press the track number (i.e. 1), and then press PLAY/SEL. to play.

NOTE:

- This feature allows displaying only one JPEG picture at a time with MP3 music playback.
- Depending on the CD contents and the way it was recorded, sometimes MP3 music cannot be played while viewing JPEG pictures.

2-1 Audio CD Playback

Preparations

Apply power to the unit and connect the headphones.

To connect the player to external equipment:

- Apply power to the TV set and select "Video" as the TV input.
- Apply power to the stereo system if the player has been connected to a stereo system.
- Slide the AV OUT/IN SWITCH button to AV OUT position.

Basic Playback

1 Press POWER on.

2 Press OPEN to open the disc cover.

3 Hold the edge of the disc to put it in the center with the printed side up.

Hold the disc without touching its surfaces, position it with the printed title side facing up, align it with the guides, and place it in its proper position.

4 Press PLAY/SEL.

For audio CDs without playback control:

The player starts playback.

Playing MP3 Music Discs

1 Press POWER on.

2 Press OPEN to open the disc cover.

3 Hold the edge of a MP3 disc to put it in the center with the printed side up.

4 Press PLAY/SEL.

Close the disc cover, wait about 5 seconds, playback will start automatically.

Normally, MP3 discs are divided into folders (main menu) which contain MP3 music files. You may select a specific MP3 music files within the folder to playback.

With Root Directories

- Press STOP to enter to the folders.
- Select a specified track to playback by pressing ◀/▶ buttons or the numbers.
- Press PLAY/SEL.

Without Root Directories

- During playback, select a specified track to playback by pressing ◀/▶ buttons or the numbers.
- Press PLAY/SEL.

Stopping Playback

Press STOP.

2-1 Audio CD Playback-continued

Rapid Advance (Rapid Reverse)

Using the remote control:

Press ◀◀ F.BWD or F.FWD ▶▶ during playback.

- Normal play is resumed by pressing ▶ button.
- The speed of forward (▶▶ x2, ▶▶ x4, and etc.) or reverse (◀◀ x2, ◀◀ x4, ◀◀ x8, and etc.) changes for every press of the F.FWD or F.BWD button.

Skipping Ahead or Back to Tracks

Press NEXT ▶▶ during playback to advance to the next audio track.

Press ◀◀ PREVIOUS during playback to return to the beginning of the currently playing track or press multiple times to go back to previous tracks.

Pause Playback

Press PAUSE during playback.

The player will pause playback.

To return to normal playback

Press PLAY/SEL.

2-2 Information [Audio CDs]

Displaying the Information of the Playing Track

Displaying the Information of the Playing Track

1 Press INFO. during playback.

Press INFO. multiple times, the elapsed time and track number will toggle and the information will be displayed on the screen.

Cancelling the Information of the Playing Track

Press INFO. multiple times until the information disappears.

3-1 Language Setup

On Screen Display (OSD) Language Setting

Allows you to set various languages for the on screen display (OSD).

- 1 Press **SETUP**.
- 2 Press **▲ / ▼** to select **"LANGUAGE SETUP"** then press **PLAY/SEL**.
- 3 Press **▲ / ▼** to select **"OSD"** then press **PLAY/SEL**.
- 4 Press **▲ / ▼** to select the desired language.
- 5 Press **PLAY/SEL**.

To return to the SETUP MENU screen

Select **"RETURN"** and press **PLAY/SEL**.

To finish the setup operation

Press **SETUP** to exit or select **EXIT** from **SETUP MENU** screen.

MENU Language Setting

You can select a preferred language among the various languages that has been recorded on discs for the disc menu messages display.

- 1 Press **SETUP** in the stop mode.
- 2 Press **▲ / ▼** to select **"LANGUAGE SETUP"** and press **PLAY/SEL**.
- 3 Press **▲ / ▼** to select **"MENU"** then press **PLAY/SEL**.
- 4 Press **▲ / ▼** to select the preferred language.
- 5 Press **PLAY/SEL**.

To return to the SETUP MENU screen

Select **"RETURN"** and press **PLAY/SEL**.

To finish the setup operation

Press **SETUP** to exit or select **EXIT** from **SETUP MENU** screen.

3-1 Language Setup-continued

AUDIO Soundtrack Language Selection [DVD]

You can select a preferred soundtrack language among various languages that have been recorded on DVD discs.

- 1 Press **SETUP** in the stop mode.
- 2 Press **▲ / ▼** to select "LANGUAGE SETUP" then press **PLAY/SEL**.
- 3 Press **▲ / ▼** to select "AUDIO" then press **PLAY/SEL**.
- 4 Press **▲ / ▼** to select a preferred language.
- 5 Press **PLAY/SEL**.

ORIGINAL:

The default language of the disc will always be used first.

To return to the SETUP MENU screen

Select "RETURN" and press **PLAY/SEL**.

To finish the setup operation

Press **SETUP** to exit or select **EXIT** from **SETUP MENU** screen.

For your reference:

- If the language you have selected is not available on the disc, the DVD player will use the default language of the disc.

SUBTITLE Language Selection [DVD]

You can select a preferred subtitle language among various languages that have been recorded on DVD discs.

- 1 Press **SETUP** in the stop mode.
- 2 Press **▲ / ▼** to select "LANGUAGE SETUP" and press **PLAY/SEL**.
- 3 Press **▲ / ▼** to select "SUBTITLE", then press **PLAY/SEL**.
- 4 Press **▲ / ▼** to select a preferred language.
- 5 Press **PLAY/SEL**.

To return to the SETUP MENU screen

Select "RETURN" and press **PLAY/SEL**.

To finish the setup operation

Press **SETUP** to exit or select **EXIT** from **SETUP MENU** screen.

For your reference:

- If the language you have selected is not available on the disc, the player will use the default language of the disc.

3-2 Screen Setup

SCREEN SAVER Setting

To enable the screen saver feature perform the steps below:

- 1 Press **SETUP** in **STOP** mode .
- 2 Use **▲ / ▼** button to select "SCREEN SETUP" and press **PLAY/SEL**.
- 3 Use **▲ / ▼** button to select "SCREEN SAVER".
- 4 Use **▲ / ▼** button to select "ON" or "OFF" and press **PLAY/SEL**.

The delay time of the screen saver function is set to 10 minutes. When the player is in **STOP** mode for 10 minutes the screen saver will activate.

To return to the **SETUP MENU** screen Select "RETURN" and press **PLAY/SEL**.

To finish the setup operation press **SETUP** to exit or select **EXIT** from **SETUP MENU** screen.

3-2 Screen Setup-continued

TV SYSTEM Setting

The player provides "PAL", "NTSC" and "AUTO" settings for your selection. Video output changes according to the playback disc's recorded format. When connecting this portable DVD player to your TV, set the "TV SYSTEM" from the on-screen display to the format that is compatible with your TV's system. Set "NTSC" from on-screen display if connecting to NTSC TV system, set "PAL" if it is PAL TV, or set "AUTO" if it is a multi-TV system that supports both PAL and NTSC.

- 1 Press SETUP.
- 2 Press ▲ / ▼ to select "SCREEN SETUP" and press PLAY/SEL.
- 3 Press ▲ / ▼ to select "TV SYSTEM" then press PLAY/SEL.
- 4 Press ▲ / ▼ to select the appropriate TV system that matches your TV.
- 5 Press PLAY/SEL.

To return to the SETUP MENU screen

Select "RETURN" and then press PLAY/SEL.

To finish the setup operation

Press SETUP to exit or select EXIT from SETUP MENU screen.

3-2 Screen Setup-continued

BRIGHTNESS Setting

You can adjust the brightness of the video with this setting to provide a comfortable view.

Using the BRIGHTNESS Adjustment button:

1. Gently press the BRIGHTNESS Adjustment button, rotate the button in a clockwise or a counter clockwise direction for the desired brightness setting.
2. Rotate the button in a clockwise direction to increase the brightness of the screen.
3. Rotate the button in a counterclockwise direction to decrease the brightness of the screen.

COLOR Setting

You can adjust the color of video with this setting to provide a comfortable view.

Using the COLOR Adjustment button:

1. Gently press the COLOR Adjustment button, rotate the button in a clockwise or a counter clockwise direction for the desired color setting.
2. Rotate the button in a clockwise direction to increase the color of the screen.
3. Rotate the button in a counterclockwise direction to decrease the color of the screen.

3-3 Custom Setup

Note: "Custom Setup" only works without disc inside this portable DVD player.

PARENTAL CONTROL Setting [DVD]

A built-in viewer rating setting enables you to lock the videos that you do not want children to view. For example, if you set the player to PG-13, the player will not play the videos rated R, NC-17 or X unless the correct password is entered.

- 1 Press **SETUP** in the stop mode.
- 2 Press **▲ / ▼** to select "CUSTOM SETUP" and press **PLAY/SEL**.
- 3 Press **▲ / ▼** to select "PARENTAL CONTROL" and press **PLAY/SEL**.
- 4 Enter a 4-digit password and press **PLAY/SEL**.

Factory pre-set password : 0000

You need to enter "0000" to set the rating for the first time when purchasing your DVD from the store.

- 5 Press **▲ / ▼** to select ratings and press **PLAY/SEL**.

To return to the SETUP MENU

Select "RETURN" and then press **PLAY/SEL**.

To finish the setup operation

Press **SETUP** to exit or select **EXIT** from **SETUP MENU** screen.

For Your Reference:

- You can use the parental control lock ONLY with DVD video discs featured with the parental lock function.

CHANGE PASSWORD Setting [DVD]

You can change the password of your DVD player parental control.

- 1 Press **SETUP** in the stop mode.
- 2 Press **▲ / ▼** to select "CUSTOM SETUP" and press **PLAY/SEL**.
- 3 Press **▲ / ▼** to select "CHANGE PASSWORD" and press **PLAY/SEL**.
- 4 Enter your old password, and then press **PLAY/SEL**.
- 5 Enter your new password, and then press **PLAY/SEL**.

To return the screen to the **SETUP MENU** Select "RETURN" and then press **PLAY/SEL**.

To finish the setup operation Press **SETUP** to exit or select **EXIT** from **SETUP MENU** screen.

3-3 Custom Setup-continued

ANGLE MARK Setting[DVD]

This player has the capability of displaying the angle mark "  " on screen when a DVD movie or a certain part of it has multi-angle scenes when the DVD was recorded.

- 1 Press **SETUP** in the stop mode.
- 2 Press **▲ / ▼** to select "CUSTOM SETUP" and press **PLAY/SEL**.
- 3 Press **▲ / ▼** to select "ANGLE MARK", and then press **PLAY/SEL**.
- 4 Press **▲ / ▼** to select "ON" or "OFF" and press **PLAY/SEL**.

NOTE:

Whether the ANGLE MARK is set to ON or OFF with this setting, when you press the ANGLE button, this portable DVD player will still playback multi-angles that are available on the video discs.

DEFAULT Setting

You may restore all settings to factory default settings in CUSTOM SETUP.

- 1 Press **SETUP** in the stop mode.
- 2 Press **▲ / ▼** to select "CUSTOM SETUP" and press **PLAY/SEL**.
- 3 Press **▲ / ▼** to select "DEFAULT" and select **RESET**.
- 4 Press **PLAY/SEL**.

NOTE:Exceptions:

The password will NOT be changed even though you have chosen to return to the factory DEFAULT setting.

To return the screen to the SETUP MENU

Select "RETURN" and then press **PLAY/SEL**.

To finish the setup operation

Press **SETUP** to exit or select **EXIT** from SETUP MENU screen.

3-4 Audio Setup

OUTPUT Setting [DVD]

This portable DVD player provides two types of audio outputs; 2-channel stereo sound and digital sound output.

- 1 Press **SETUP** in the stop mode.
- 2 Press **▲ / ▼** to select "AUDIO SETUP" and press **PLAY/SEL**.
- 3 Press **▲ / ▼** to select "OUTPUT" and press **PLAY/SEL**.
- 4 Press **▲ / ▼** to select a preferred output setting.
- 5 Press **PLAY/SEL**.

NOTE:

- The digital output connectors are used to output the digital audio track recorded on discs. You can output the digital signal via coaxial output jack to digital audio decoder. If you set Audio Output to <Digital> from on-screen display, the audio output will be the original sound recording format on discs (for example; Dolby Digital).

WARNING:

- Do not set "AUDIO SETUP" to "Digital" via the on-screen display unless you are connecting (via the DOLBY DIGITAL AUDIO OUT jack) an A/V decoder that has the Dolby Digital (AC-3) decoding function. High volume audio may damage your hearing as well as the speakers.

To return the screen to the SETUP MENU

Select "RETURN" and then press **PLAY/SEL**.

To finish the setup operation

Press **SETUP** to exit or select **EXIT** from **SETUP MENU** screen.

4-1 Troubleshooting

Before requesting service for the player, check the chart below for a possible cause of the problem you are experiencing. Some simple checks or a minor adjustment on your part may eliminate the problem and restore proper operation.

SYMPTOM (COMMON)	REMEDY
No power.	<ul style="list-style-type: none"> Insert the power plug securely into the power outlet. Check if the ON/OFF button on the right of the player is set to ON position. Check for power at the AC outlet by plugging in another appliance for a test.
The player does not start playback when PLAY is pressed.	<ul style="list-style-type: none"> Condensation due high humidity has formed: wait about 1 to 2 hours to allow the player to dry out. This player cannot play discs other than DVDs, audio CDs and CDR with recorded JPEG files. Check if the disc is defective by trying another disc. Check the region (local) code.
The player starts playback but stops immediately. No picture.	<ul style="list-style-type: none"> The disc may be dirty and may require cleaning. Ensure that the disc is loaded with the label side up. Ensure that the equipment is connected properly. Ensure that the input setting for the TV is "Video". Check if external equipment is on. Select the same channel and source on the TV as on the player. Check if the LCD is on.
No sound.	<ul style="list-style-type: none"> Ensure that the equipment is connected properly. If using a HiFi amplifier, try another sound source. Check the Audio Output Setting menu to make sure that Analog Output is selected. Check the Volume Adjustment.
Distorted sound.	<ul style="list-style-type: none"> Ensure that the input settings for the TV and stereo system are proper. No sound is heard during still picture (pause).
No audio at Digital Output.	<ul style="list-style-type: none"> Check the digital connections. Check the settings menu to make sure that the digital output is set to on. Check if the audio format of the selected audio language matches your receiver capabilities.
Distorted picture.	<ul style="list-style-type: none"> Check the disc for fingerprints and clean it with a soft cloth, wiping it from center to edge. Sometimes a small amount of picture distortion may appear on multi-layer discs. This is not a malfunction.
Completely distorted picture or no color in picture.	<ul style="list-style-type: none"> The disc format is not matching the TV-set used (PAL/NTSC).
Picture is distorted during rapid advance or rapid reverse.	<ul style="list-style-type: none"> The picture will be somewhat distorted at times: this is normal.
No rapid advance (or rapid reverse) playback.	<ul style="list-style-type: none"> Some discs may have sections which prohibit rapid advance (or rapid reverse).
No 4:3 (16:9) picture.	<ul style="list-style-type: none"> Choose the correct setup "TV DISPLAY" item which matches the TV set used.
Picture is distorted during rapid advance or rapid reverse.	<ul style="list-style-type: none"> The picture will be somewhat distorted at times: this is normal.
Remote control does not function	<ul style="list-style-type: none"> Check the batteries are installed with the correct polarities (+ and -). The batteries are discharged: replace them with new ones. Point the remote control unit at the remote control signal sensor and try again. Operate the remote control unit at a distance but no more than 7 meters from the remote control signal sensor. Remove the obstacles between the remote control unit and remote control signal sensor.
No key operation (by the DVD player AC power and/or the remote control) is effective.	<ul style="list-style-type: none"> Turn the unit off and then back to on. Alternatively, turn off the unit, disconnect the cord and then re-connect it. (The player may not be operating properly due to lightning, static electricity or some other external factor.)
PLAY does not start playback even when title is selected.	<ul style="list-style-type: none"> This may be a result of the parental lock function that has been set. Confirm the "PARENTAL" setup.
Audio soundtrack and/or subtitle language is not the one selected at the initial settings.	<ul style="list-style-type: none"> If the audio soundtrack and/or subtitle language does not exist on the disc, the language selected at the initial settings will not be seen/heard.
No subtitles.	<ul style="list-style-type: none"> Subtitles appear only with discs that contain them. Subtitles are not enabled. Press SUBTITLE to display the subtitles.
Alternative audio soundtrack (or subtitle) languages cannot be selected. Angle cannot change.	<ul style="list-style-type: none"> An alternative language can not be selected may result of no more than one language available. This function depends on software availability. Even if a disc has a number of angles recorded, these angles may be recorded for specific scenes only.

4-2 Disc Handling and Maintenance

Handling Precautions

- Hold the disc by the edges so the surface will not be soiled with fingerprints. (A)
Fingerprints, dirt and scratches can cause skipping and distortion.
- Do not write on the label side with a ball-point pen or other writing utensils.
- Do not use record cleaning sprays, benzene, thinner, static electricity prevention liquids or any other solvent.
- Be careful not to drop or bend the disc.
- Do not install more than 1 disc on the disc tray.
- Do not try to close the disc cover when the disc is not installed properly.
- Be sure to store the disc in its case when not in use.

If the surface is soiled (B)

Wipe gently with a soft, damp (water only) cloth.

When wiping discs, always move the cloth from the center hole toward the outer edge.

(If you wipe the discs using a circular motion, circular scratches are likely to occur, which will cause picture distortion)

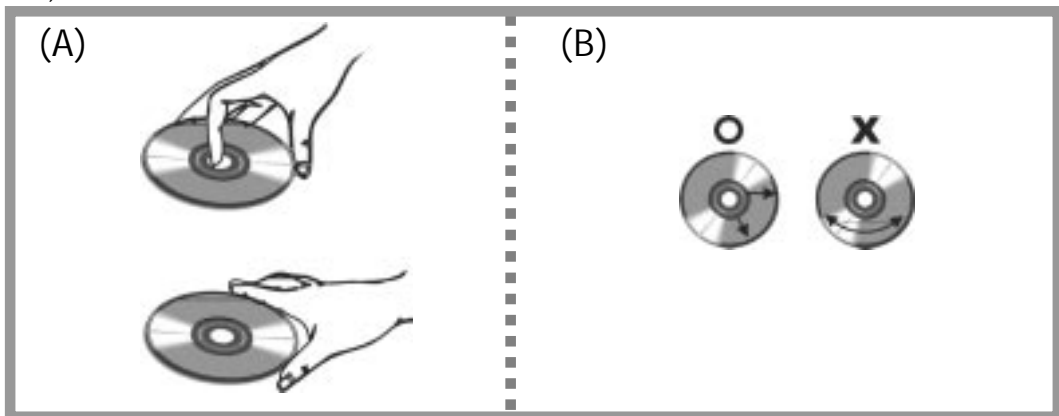

If the disc is brought from a cold to a warm environment, moisture may form on the disc

Wipe moisture off with a soft, dry, lint-free cloth before using the disc.

Improper disc storage

You can damage discs if you store them in the following places:

- Areas exposed to direct sunlight
- Humid or dusty areas
- Areas directly exposed to a heat outlet or heating appliance

Disc which cannot be played with this player

- CD-ROM (Application Program)
- CVD
- CD-G
- DVD with a Region Number other than that shown on the DVD unit's Region Code Label on the rear panel

Maintenance

- Be sure to turn the unit off and disconnect the AC power cord before maintaining the unit.
- Wipe this unit with a dry soft cloth. If the surfaces are extremely dirty, wipe clean with a cloth which has been dipped in a weak soap-and-water solution and wrung out thoroughly, and then wipe again with a dry cloth.
- Never use alcohol, benzene, thinner, cleaning fluid or other chemicals. And do not use compressed air to remove dust.

4-3 Definition of Terms

Angle

Recorded onto some DVD discs are scenes which have been simultaneously shot from a number of different angles (the same scene is shot from the front, from the left side, from the right side, etc.). With such discs, the ANGLE button can be used to view the scene from different angles.

Chapter Number

These numbers are recorded on DVD discs. A title is subdivided into many sections, each of which is numbered, and specific parts of video presentations can be searched quickly using these numbers.

DVD

These refer to a high-density optical disc on which high-quality pictures and sound have been recorded by means of digital signals. Incorporating a new video compression technology (MPEG II) and high-density recording technology, DVD enables aesthetically pleasing full-motion video to be recorded (for instance, a whole movie can be recorded).

DVD has a structure consisting of two 0.6 mm thin discs which are adhered to each other. Since the thinner the disc, the higher the density at which the information can be recorded, a DVD disc has a greater capacity than a single 1.2 mm thick disc. Since the two thin discs are adhered to each other, there is the potential to achieve double-sided play for even longer play durations.

Subtitles

These are the printed lines appearing at the bottom of the screen which translate or transcribe the dialogue. They are recorded on DVD discs.

Time Digit

This indicates the play time which has elapsed from the start of a disc or a title. It can be used to find a specific scene quickly. (It may not work with some discs.)

Title Number

These numbers are recorded on DVD discs. When a disc contains two or more movies, these movies are numbered as title 1, title 2, etc.

Track Number

These numbers are assigned to the tracks which are recorded on audio CDs. They enable specific tracks to be located quickly.



90 DAY LIMITED WARRANTY

Applies to Audiovox Video Products

AUDIOVOX ELECTRONICS CORP. (the Company) warrants to the original retail purchaser of this product that should this product or any part thereof, under normal use and conditions, be proven defective in material or workmanship within 90 days from the date of original purchase, such defect(s) will be repaired or replaced with reconditioned product (at the Company's option) without charge for parts and repair labor.

To obtain repair or replacement within the terms of this Warranty, the product is to be delivered with proof of warranty coverage (e.g. dated bill of sale), specification of defect(s), transportation prepaid, to the Company at the address shown below.

This Warranty does not extend to the elimination of externally generated static or noise, to correction of antenna problems, to costs incurred for installation, removal or reinstallation of the product, or to damage to tapes, discs, speakers, accessories, or electrical systems.

This Warranty does not apply to any product or part thereof which, in the opinion of the Company, has suffered or been damaged through alteration, improper installation, mishandling, misuse, neglect, accident, or by removal or defacement of the factory serial number/bar code label(s). THE EXTENT OF THE COMPANY'S LIABILITY UNDER THIS WARRANTY IS LIMITED TO THE REPAIR OR REPLACEMENT PROVIDED ABOVE AND, IN NO EVENT, SHALL THE COMPANY'S LIABILITY EXCEED THE PURCHASE PRICE PAID BY PURCHASER FOR THE PRODUCT.

This Warranty is in lieu of all other express warranties or liabilities. ANY IMPLIED WARRANTIES, INCLUDING ANY IMPLIED WARRANTY OF MERCHANTABILITY, SHALL BE LIMITED TO THE DURATION OF THIS WRITTEN WARRANTY. ANY ACTION FOR BREACH OF ANY WARRANTY HEREUNDER INCLUDING ANY IMPLIED WARRANTY OF MERCHANTABILITY MUST BE BROUGHT WITHIN A PERIOD OF 30 MONTHS FROM DATE OF ORIGINAL PURCHASE. IN NO CASE SHALL THE COMPANY BE LIABLE FOR ANY CONSEQUENTIAL OR INCIDENTAL DAMAGES FOR BREACH OF THIS OR ANY OTHER WARRANTY, EXPRESS OR IMPLIED, WHATSOEVER. No person or representative is authorized to assume for the Company any liability other than expressed herein in connection with the sale of this product.

Some states do not allow limitations on how long an implied warranty lasts or the exclusion or limitation of incidental or consequential damage so the above limitations or exclusions may not apply to you. This Warranty gives you specific legal rights and you may also have other rights which vary from state to state.

U.S.A. : AUDIOVOX ELECTRONICS CORPORATION, 150 MARCUS BLVD., HAUPPAUGE, NEW YORK 11788
● 1-800-645-4994

CANADA : CALL 1-800-645-4994 FOR LOCATION OF WARRANTY STATION SERVING YOUR AREA 128-5556C

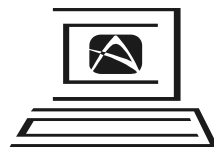

For Customer Service
Visit Our Website At
www.audiovox.com
Product Information, Photos,
FAQ's Owner's Manuals

Free Manuals Download Website

<http://myh66.com>

<http://usermanuals.us>

<http://www.somanuals.com>

<http://www.4manuals.cc>

<http://www.manual-lib.com>

<http://www.404manual.com>

<http://www.luxmanual.com>

<http://aubethermostatmanual.com>

Golf course search by state

<http://golfingnear.com>

Email search by domain

<http://emailbydomain.com>

Auto manuals search

<http://auto.somanuals.com>

TV manuals search

<http://tv.somanuals.com>