

AVERATEC™

mobility without boundaries

Voya 320 GPS User's Manual



Table of Contents

Preface	i
Important Safety Information	iii
Components of the Voya 320	1
Standard Components.....	1
Optional Components.....	1
Names and Functions of Elements on the Voya 320	2
Front.....	2
Back.....	2
Name and Function of Elements on the Voya 320.....	3
Installation	4
Inserting SDMMC Memory Card	5
Power Mode and Battery Recharging	5
About Reset Mode	6
Preferences	7
Starting the Software	8
Map Page.....	9
Zoom In/Out.....	9
Track Up (Heading) or North Up.....	9
Navigation and Panning Modes.....	10
POIs Displayed on the Map Page.....	11
Current Route.....	12
Trip Information Page.....	12
GPS Info.....	13
Almanac.....	13
Current Location.....	13
Map View Style.....	14
Creating and Using an Auto Route.....	15
Destination by Address.....	16
Destination by Intersection.....	17
Destination by Points of Interest (POI).....	18
Destination from Favorites.....	19
Destination from Recent.....	19
Destination from City Center.....	19
To Set the Route Options.....	20
To Set the Display Options.....	20
To Create or Add to the Favorites List.....	21
To Add a label to your Favorites.....	21

Panning and Zooming.....	22
To Zoom In and Out.....	22
Adjusting the Volume.....	22
Localization.....	23
Localization.....	23
Speed alert.....	23
Exit Map Program - About Screen.....	24
Connecting System to Your PC.....	25
Installing the USB Driver.....	26
Distinguishing Between Remov able Disks.....	26
Copying Files.....	27
Safely Removing Hardware.....	27
Windows XP.....	27
Windows XP.....	28
Using Supplemental Programs.....	29
Getting Ready.....	29
Menu Program.....	29
Music Play er.....	30
Mov ie Player.....	32
Picture Player.....	34
In-Depth Description of Functions.....	35
Functions and Control Buttons.....	35
Setting Environments.....	36
Names and Functions.....	36
Troubleshooting.....	40
System Specifications.....	40

Preface

Precautions

Please read this section carefully before using this product.

This product is intended to provide turn-by-turn instructions to safely guide you to your desired destination. Please make sure that all persons using this navigation software carefully read these precautions and the operating instructions in the Voya 320 User's Guide.

Averatec, Inc. cannot accept any responsibility whatsoever for accidents resulting from failure to observe these precautions.

Your personal judgment, traffic regulations, and common sense must always take precedence over instructions produced by the software.

- This product is not a substitute for your driving technique, driving knowledge or especially your personal judgment. Route suggestions made by this navigation system should never supersede any traffic regulations, your personal judgment, or your knowledge of safe driving practices. If you feel that a route suggestion made by the software instructs you to perform an unsafe or illegal maneuver, places you in an unsafe situation, or routes you into an area that you consider unsafe, do not follow the instructions. *Your personal judgment, traffic regulations, and common sense must always take precedence over instructions produced by the software.*
- When your vehicle is moving, keep your eyes on the road instead of looking at the screen. If you need to look at the screen for a prolonged time, always park the car in a safe manner and in accordance with all traffic regulations.
- Do not select or input destinations, change settings or otherwise manually operate this software unless you have parked your car in a safe manner, observing all traffic regulations.
- If you are responding to an emergency, it may not be prudent to rely on this system unless you have no other means to obtain accurate directions. The database does not include all of the facilities and streets necessary for emergency response, and the system's maps may not reflect recent changes in roads, traffic controls and driving conditions. Use your own judgment in these situations.
- The database utilized by this software is the most accurate and up-to-date database available. Because of road closures, construction, weather, new roads and other conditions, the database might not contain accurate information regarding all streets and locations. If so, the system might not be able to correctly guide you on your route or may inaccurately estimate the time needed to reach your destination. Please use your judgment in these cases. Renewing your subscription to the database will aid in keeping it up-to-date.
- There are situations when the navigation system will incorrectly display the vehicle's position on the map. Usually this situation will correct itself automatically. Use your own judgment at all times. If you need to reset the position, pull over in a safe manner observing all traffic regulations.

Safety Information

- X Do not secure in front of airbag
- X Do not loosely place on dashboard
- X Do not block driver's view

The detailed mapping software is provided by NAVTEQ and Netropa. The detailed mapping software is as accurate and detailed as possible. Whenever maps are digitized, there is still a possibility that some inaccurate or incomplete data can be found. It is because of these inaccuracies that the Voya 320 is a travel aid and is not intended for precise measurement in navigation or aircraft use. Differences between manufactured and shipped versions of the software may be present; this software may be updated frequently. If the descriptions in this manual are different from your software version, please follow the software version currently on hand.

FCC Compliance

This device complies with Part 15 of the FCC Rules. Operation is subject to the following two conditions:

(1) This device may not cause harmful interference, and
(2) this device must accept any interference received, including interference that may cause undesired operation. This equipment has been tested and found to comply with the limits for a Class B digital device, pursuant to part 15 of the FCC Rules. These limits are designed to provide reasonable protection against harmful interference in a residential installation. This equipment generates, uses and can radiate radio frequency energy and, if not installed and used in accordance with the instructions, may cause harmful interference to radio communications. However, there is no guarantee that interference will not occur in a particular installation. If this equipment does cause harmful interference to radio or television reception, which can be determined by turning the equipment off and on, the user is encouraged to try to correct the interference by one or more of the following measures:

- Reorient or relocate the receiving antenna.
- Increase the separation between the equipment and receiver.

Introduction

Congratulations on your purchase of an Averatec Voya 320 GPS receiver! This system can provide an auto route to the destination of your choice using signals from Global Positioning Satellites (GPS) orbiting the earth.

There are 24 GPS satellites orbiting the earth. A GPS device can calculate your position on the earth if it can receive signals from at least three of these satellites. When it receives at least four signals, a GPS device can also calculate your altitude (height above sea level).

To use the GPS receiver for the first time you need to charge the battery for at least four hours. The Voya 320 comes with maps preloaded on the SD card so map loading is not necessary. Maps of other countries are sold separately.

Important Safety Information

- Check the conditions of the Voya 320 before driving. Operating the Voya 320 while you drive is very dangerous. If you need to operate the Voya 320, park your car in a safe location before operating the Voya 320.
- Search the path to your destination before you drive. If you do not fully understand the instructions from the Voya 320, or the instructions are questionable, refer to the map on the screen only when you are absolutely sure that you are in safe conditions.
- Information from the Voya 320 such as voice instruction or the maps may be different from the actual road conditions. The traffic signals and regulations on the actual roads must be observed, and special attention shall be paid to traffic situations and pedestrians around you.
- Do not use the system for measuring driving speed or distance. The system is only for navigation.
- GPS signals may vary in sensitivity dependent upon location of your car. You may suffer from weak signals inside a tunnel or under an overpass or by a tall building, and sensitivity of signals may be affected by overcast skies or thick fog.
- GPS signals may not be correctly received if you are inside a building, if there is an object interrupting signal reception in the vicinity of the antenna, or if a system radiating radio interrupting signal is inside your car.
- If you use the Voya 320 after a prolonged period of storage, it may take extensive time for you to begin to receive signals, even though the Voya 320 is operating normally.
- Install the system on an appropriate location inside your car. Do not install the system on a location that may cause trouble in operation of the airbags, or obstruct your vision while you are driving.
- When you install the system, remove any foreign materials from the suction mount and surface of the window, and affix the system while paying special attention to prevent air from being introduced between the suction mount and the window surface. Any damage of the product or other objects inside your car caused by detachment of the system from the window because of poor suction is the user's responsibility.
- Do not leave the system under direct light or in a location subject to heat from the engine of your car for an extensive period. Heating the battery may cause an explosion. Do not leave the system unattended for a prolonged period when the temperature is very hot, as in summer.
- Do not expose the system to moisture, heat, or rapidly changing temperatures. Condensation may take place inside the system, and cause damage to the system. If the system is exposed to high humidity, dry the system immediately, and use the system only after you are sure that the system is free from moisture.
- If you disassemble, reassemble or modify the system without Averatec's consent, it may cause abnormal operation of the system. In such a case, you are solely responsible for the trouble.
- The system contains lithium-ion batteries that may cause explosion or leakage of hazardous liquid. Never give an impact to or destroy the system, and do not keep the system together with objects probable of explosion of gas or liquid, or fire.
- Do not use the A/C or D/C adaptor in a high humidity environment, and never touch the adapter with wet hands. You may receive an electric shock. Do not wrap the adapter with sheets of paper, vinyl or cloth while you use the system, and make sure of proper ventilation for cooling the adapter. Please make sure that you are using the correct power source as indicated on the housing or the package.
- Do not exercise excessive force with the system and do not clean the system when the power is on. Do not use paper tissues - generating dust, or rigid materials - probable of scratching when trying to clean the LCD. Use a soft cloth only.
- When you are not using the SD/MMC card, protect the system from dust or moisture, and pay special attention to keep the slots free from foreign materials. Always make sure that the slot is free from foreign material before inserting the memory card into the system.

Components of the Voya 320

Standard Components



Voya 320 GPS



Suction Mount



USB Cable



Dash Disk



Cigarette Lighter Adapter

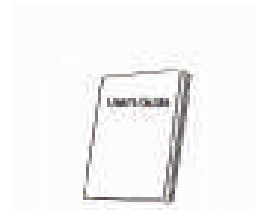

Quick Reference Guide



SD/MMC Memory Card

Optional Components



AD/DC Adapter

Names and Functions of Elements on the Voya 320

Front

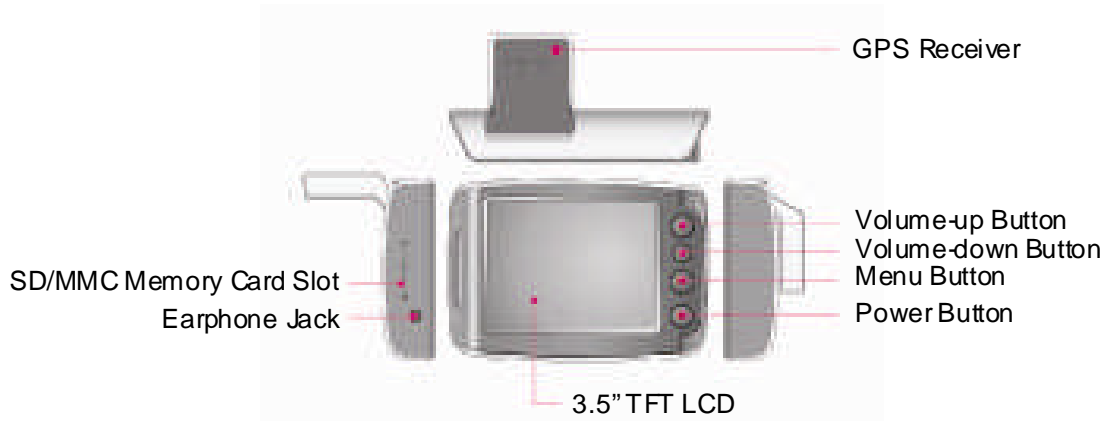

Back

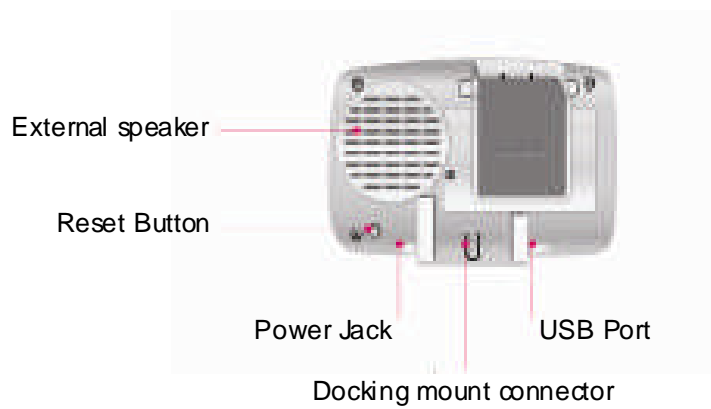

Name and Function of Elements on the Voya 320

GPS Receiver



The receiver receives data from satellite. Always extend the GPS receiver horizontally facing the sky when you operate the system.

Earphone Jack



The jack accommodates an earphone or external speakers.

External Speaker



The speaker plays voice instructions or other sounds.

Power Receptacle



The receptacle is connected to AC/DC power, or the cigarette lighter adapter in an automobile.

Volume-up Button



Pressing the button once increases the volume by one level. (Refer to "Adjusting Volume.")

Menu Button



Pressing the button runs the menu program.

Power Indicator



The color of light in the power button indicates the current power mode and the status of the battery. (Refer to "Power Mode and Battery Recharging.")

SD/MMC Memory Card Slot



The spring-loaded slot accommodates the SD/MMC memory card. Insert the memory card into the slot and lightly press the card. The card will be seated in place inside the slot. Pay attention to the orientation of the card as it is being inserted; the card slot is keyed and can only be inserted in one direction. Never insert an object other than the SD/MMC memory card.

Mount Connector



The mount connector is used for connecting the suction mount in the automobile. (Refer to "Installing On Your Car.")

USB Port



The port accommodates the USB cable when the system is connected to a PC.

Volume-down Button



Pressing the button once decreases the volume by one level. (Refer to "Adjusting Volume.")

Power Button



Pressing the button switches the system to the power-saving mode. Pressing it again returns the system to the operation mode (Refer to "Power Mode and Battery Recharging.")

Reset Button



Pressing the button initializes the system (Refer to "About Reset Mode.")

Installation

1. Extend the GPS receiver folder in horizontal direction as shown in figure below.



2. Insert the mount into the mount connector as shown in figure below.

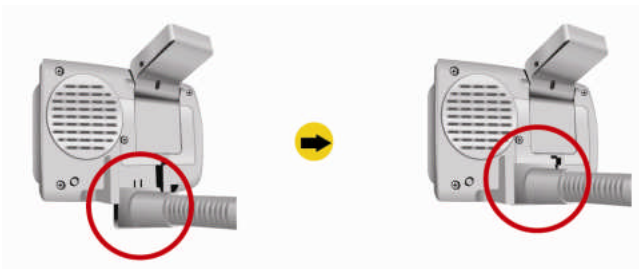

3. Tightly press the suction mount on the window of your car, and turn the locking lever down.



4. Connect the DC Cigarette Lighter adapter to the power receptacle.

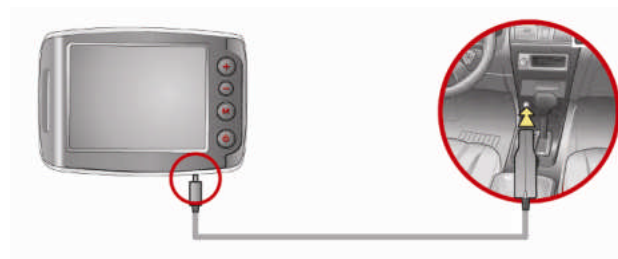

Lightly press the Reset button to initialize the system. (Refer to "About Reset Mode.")



Do not install the system in a location that may obstruct your view or interfere with safe driving.

Inserting SD/MMC Memory Card





Insert the SD/MMC memory card into the slot while paying attention to the orientation of the card as shown below:



Note

Exerting excessive force to insert into the slot in the wrong direction may damage the SD/MMC card or slot

Power Mode and Battery Recharging

Power Mode	Conditions of Charged Battery
External Power Mode	Power is supplied to the system for operation from the AC/DC adapter or the cigarette adapter/charger in your car. [Power button ] lights red: The battery is being charged. [Power button ] lights green: The battery is fully charged.
Battery-Powered Mode	Power is supplied to the system for operation from the battery. [Power button ] lights red: The battery is being charged. [Power button ] lights green: The battery is fully charged.
Power-Saving Mode	Pressing the Power button  switches the system to the power-saving mode. Pressing the power button again returns the system to the operation mode.
Forced Power-Saving Mode	When the remainder power in the battery is 20-30% of its full capacity, the warning window is displayed. In such a case, immediately recharge the battery. If the battery is almost discharged, it enters forced power-saving mode automatically. Once it enters the forced saving mode, it cannot be turned on again until the power is supplied by connecting the cigarette adapter/charger or AD/DC adapter.



Note

- It takes three hours or longer to fully charge the battery from the forced power-saving mode, when using the navigation function only in the preference conditions.
- It is possible to operate the system with the fully charged battery for about two hours, when using the navigation function only in the preference conditions.
- Battery life will vary depending on usage.

About Reset Mode

Two reset modes are provided on the system. You can select the desired reset mode by pressing the reset button on the rear of the body shown right.



as

Soft Reset



Execute the soft reset by the pressing the Reset button as shown left: **Lightly press the button once.**

Function

Lightly pressing the Reset button exits all of the current programs, and restarts the system. This mode is used when the system is shut down due to fault in programs.

Hard Reset

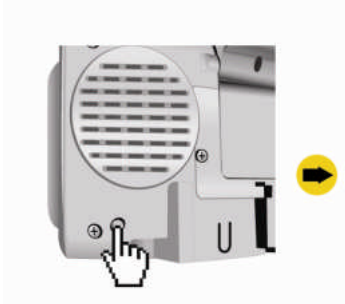

Execute the hard reset by pressing the Reset button as shown left.

Function

Press the Reset button until the unit turns off. After three seconds, lightly press the reset button again to restart the system. This mode is used when the soft reset does not solve the problem.



Note

- The soft reset mode is not allowed when the system is connected to a PC via the USB cable.
- You MUST reset the system when supplying power to the fully discharged system.

After Reset

After reset, the system starts up.

Preferences

Brightness of the backlight and the sound volume upon initial power supply are set as described in the table below.

Setting	Defaults
Backlight	Level 4 (Lowest: Level 1; Highest: Level 4)
Volume	Level 9 (Lowest: Level 0; Highest: Level 10)

Starting the Software

Once the GPS receiver is turned on and navigation software is started, the unit will automatically go to the GPS receiver's main menu or display the map page.

Once you select **Navigation**, a warning screen will appear first. Simply read and tap the **I Agree** icon.



It is best to be outside and have a clear sky above to allow the GPS to obtain better reception of the satellites. Clear sky means: no trees, bridges, overhangs, carports etc. Cloudy skies are ok. The unit is ready to travel and navigate once the map page is displayed and the position icon changes from red to green or yellow.

Map Page

The Map Page displays your current position, zoom in/out icons and zoom level in miles, the street you're traveling on, your current speed, and Menu icon. The pointer represents your location and direction on the map.

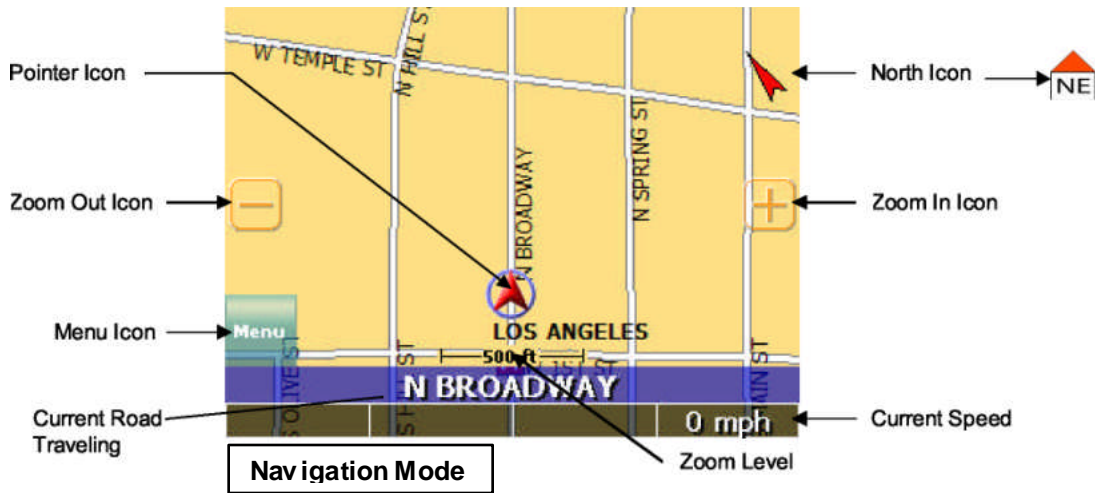

The pointer icon also indicates the signal strength of the satellite signals: Silver = no signal; Red = poor signal; Yellow = weak signal and Green = good signal.

Zoom In/Out

The zoom level is displayed in the lower center of the map page. To change the zoom level, tap the zoom icons on the screen or the (+) or (-) buttons on the GPS unit. **Note:** Street details are not shown higher than zoom level of 2000 ft.

Track Up (Heading) or North Up

In the upper right hand corner is the North indicator icon. This indicator will always point to the north. While traveling, the direction of travel (Pointer Icon) is always pointing up and the map rotates around the Pointer Icon.

When the map is switched to North Up from the defaulted Track Up, North is always at the top of the screen while the direction of travel (N,S,E,W etc.) is displayed under the red arrow. See Figure above for an example for a NE direction of travel.

There are three ways to change the display:

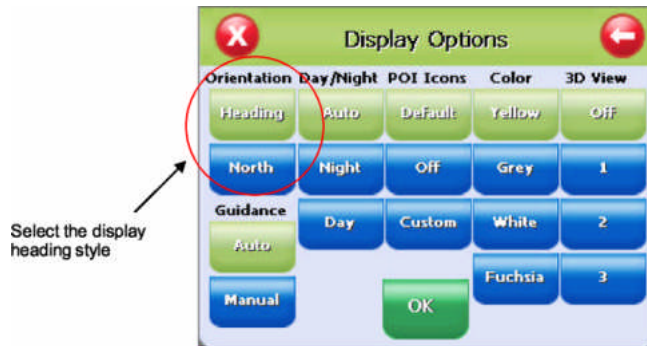

1. Access Display Options through Settings.
2. Simply tap the North indicator and the icon will change from one setting to the other.
3. Go to: Main Menu/Display Options/Orientation and change the option.
4. Simply press the direction button in the up position.

Navigation and Panning Modes

The map page can be displayed in two views; Navigation Mode and Panning Mode. Navigation Mode displays movements along the map.

Panning Mode allows Points of Interest (POI) and street name information to be displayed and also allows movement of the map to different areas for viewing.

To enter Panning Mode: Simply tap and drag along the screen to allow movement of the map to view different areas.

To exit Panning Mode, tap the red "X" button in the lower right corner of the display.

To find out more info on a POI, simply tap on the POI's icon and the POI Info screen will be displayed.

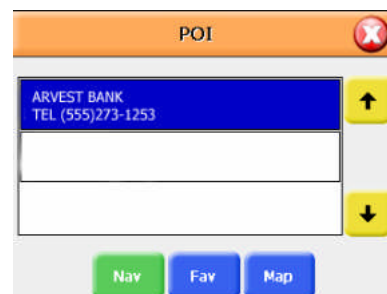
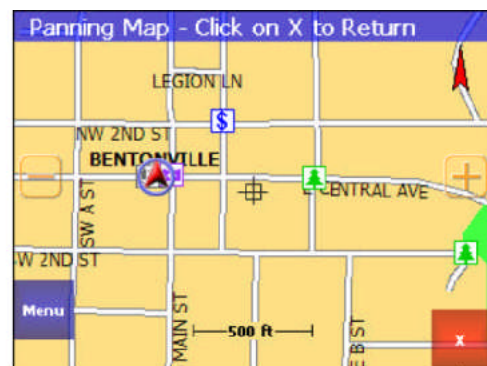

The POI Info screen provides the POI's name and phone number.
At the bottom of the POI Info page there are three choices for the POI info displayed:



Nav = Set an auto route to the POI
Fav = Saves this POI into the Favorites folder
Map = Return to the map page

POIs Displayed on the Map Page

Selecting only certain POIs is helpful in large city areas where the POI icons could overwhelm the map page.

To change the default settings.

1. Tap **Menu, Settings, Display Options.**
2. Under the POI icons column, select what POIs are shown on the map page. Default setting is all POIs are selected.



POI on
POI off

Current Route

This page is normally blank unless a navigation route is entered. All turns within the route are displayed. This page is useful when looking for the next turn or turns that are approaching.

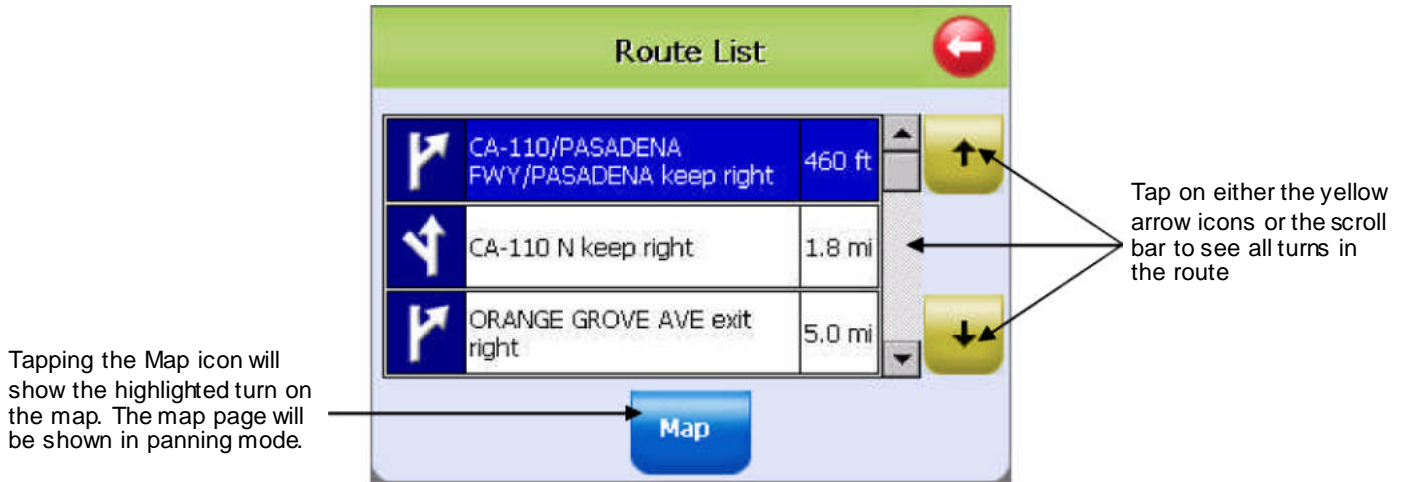

Trip Information Page

The Trip Information Page can store three different trips. The information displayed includes: trip time, top speed, average speed, total distance, date and time information.



GPS Info

This page displays the GPS receiver's satellite reception, local and UTC time (24hr format - independent of the GPS receiver's own clock), current longitude and latitude, altitude and traveling speed accessed under

Settings

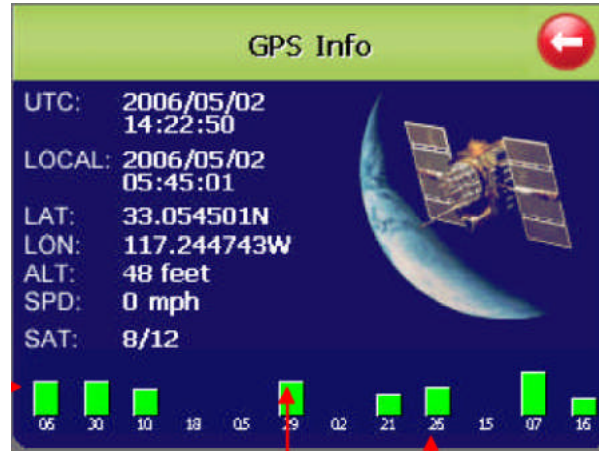

Bars indicate device is receiving satellite signal

Satellite signal strength

Numbers below the bars indicate satellite number

The vertical bars on the Satellite page indicate the signal strength of the received satellite(s). The higher the bar, also higher the number, the stronger the signal. The number below each bar indicates the satellite numbers.

Almanac

The Almanac is a simple page that provides sunrise and sunset times, current phase of the moon, age of the moon, full moon and the next new moon expected.

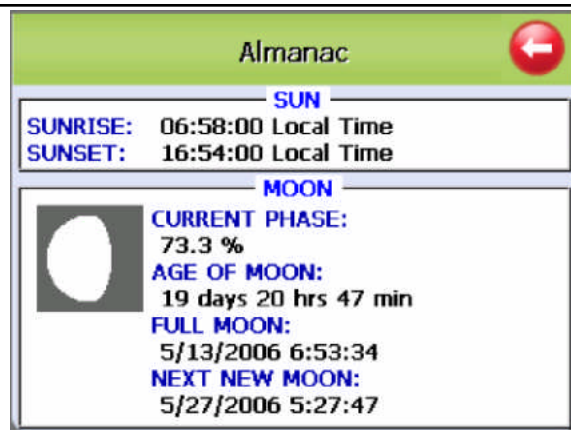

Current Location

Use this page to get information about the current position and from this page the location can be saved to the Favorites folder.

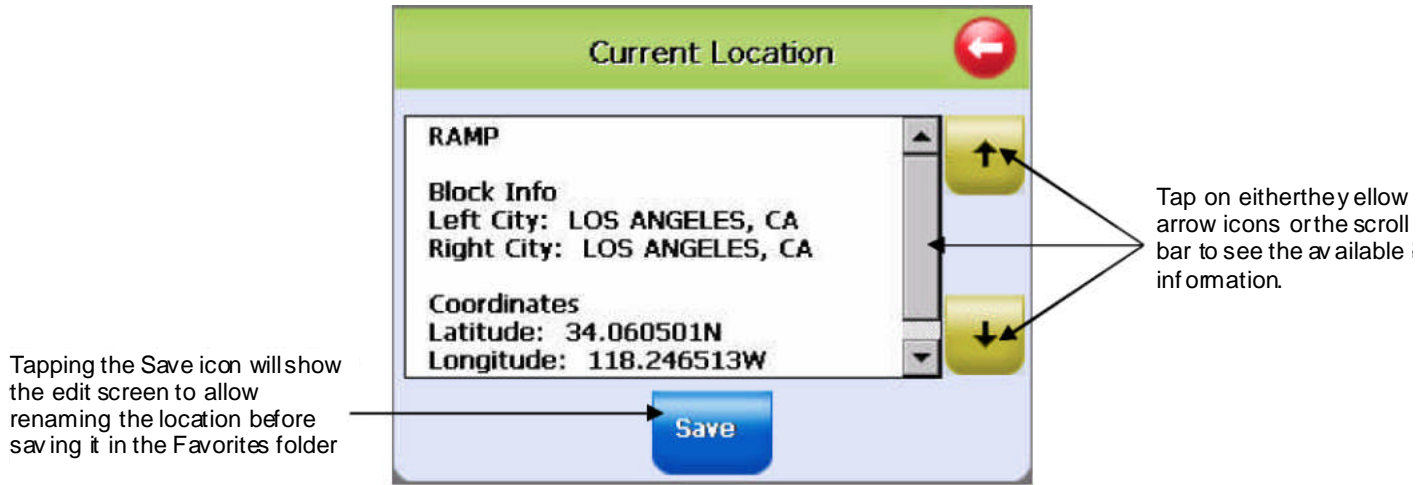

Map View Style

The map page can be viewed in different dimensions; normal 2D and three options of 3D. There are two ways to change the display view:

1. Simply tap on the desired viewing option.
2. Go to: **Menu/Settings/Display Options/3D View** and change the option.
3. Tap either the OK Icon to accept or the X to cancel.

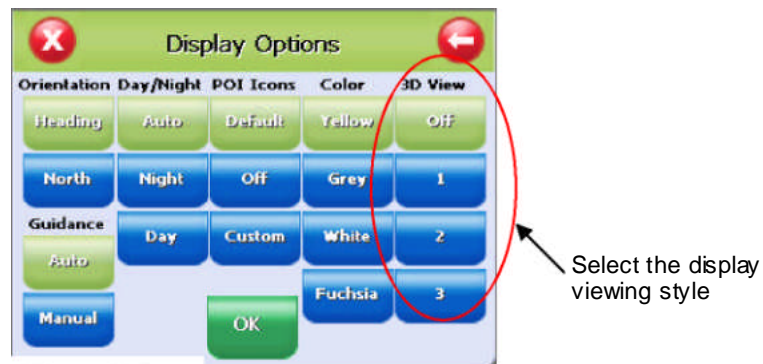

2D View

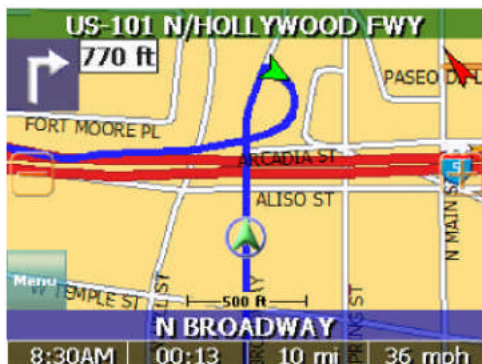

One of three 3D Views



Creating and Using an Auto Route

When an auto route is selected the map page will show the route on the map by changing the road color to blue.



To start an auto route, begin from the map page. Tap the **Menu** icon and from the Main Menu page tap on the **Destination** icon.

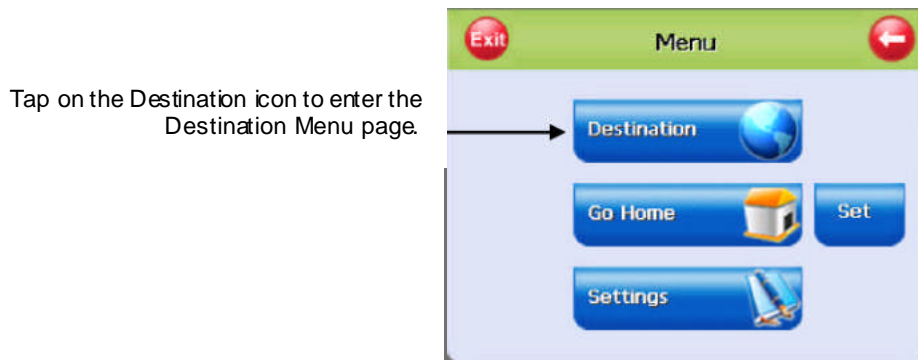

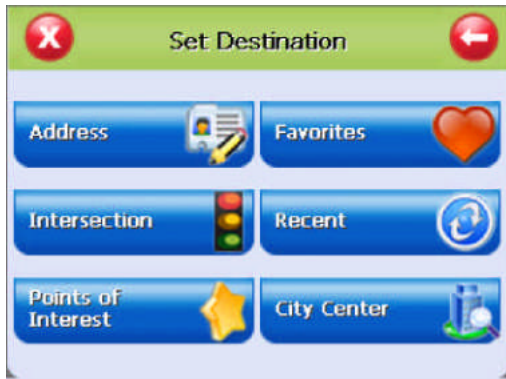

When the Destination Menu is shown, select the category to create an auto route.

The following pages cover how to create an auto route from these categories.

Destination by Address

1. Tap **Menu, Destination, Address.**
2. Tap **Change** to select the state in which to search.
3. Tap **Street First** to enter the street name first or **City First** to enter the city name first.



Note: Any time the keyboard is displayed, the program will display choices that closely match the category name being typed. Tap the **OK** icon once a choice is correctly shown.

If **Street First** is selected

1. Enter street name and tap **OK.**

(!) Advisory - DO NOT ENTER STREET TYPE. For Main Street just enter Main. Note: The program will display choices that closely match the street name being typed. Tap the **OK** icon once a choice is correctly shown.

2. Enter house number and tap **OK.**
3. From the match list, select the desired address.
4. Tap **Nav** to navigate to this location; or
5. Tap **Fav** to add this location to the Favorites folder; or
6. Tap **Map** to set this location as your starting point and see location on the map.

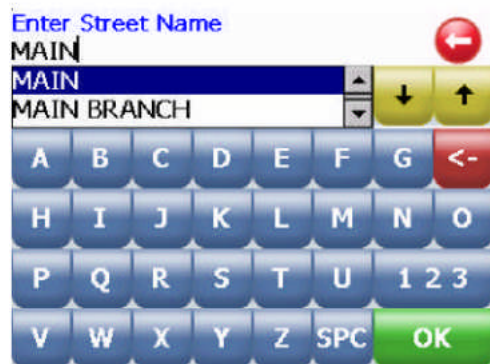

If **City First** is selected

1. Enter city name and tap **OK**.
2. Enter street name and tap **OK**.
(!) Advisory - DO NOT ENTER STREET TYPE. For Main Street just enter Main.
3. Enter house number and tap **OK**.
4. From the match list, select the desired address.
5. Tap **Nav** to navigate to this location; or
6. Tap **Fav** to add this location to the Favorites folder; or
7. Tap **Map** to set this location as the starting point and see the location on the map.
(i) Information - If a large number of records are found by the Street First method, the program will automatically revert to **City First** method.

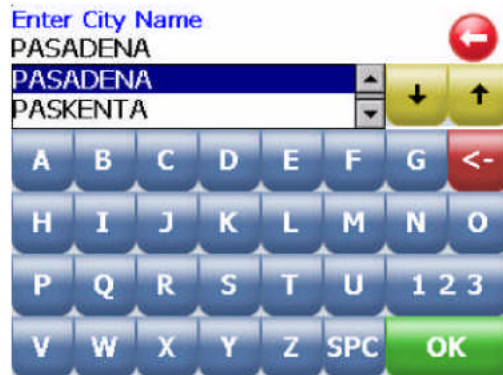

Destination by Intersection

1. Tap **Menu, Destination, Intersection**.
2. Tap **Change** to select the state in which to search.
3. Tap either **Street First** to enter the street name first or **City First** to enter the city name first.



If **Street First** is selected:

1. Enter street name and tap **OK**.
(!) Advisory - DO NOT ENTER STREET TYPE. For Main Street just enter Main. Note: The program will display choices that closely match the street name being typed. Tap the **OK** icon once a choice is correctly shown.
2. Enter the name of the cross street and tap **OK**.
(!) Advisory - DO NOT ENTER STREET TYPE. For Main Street just enter Main.
3. From the match list, select the desired intersection.
4. Tap **Nav** to navigate to this location; or
5. Tap **Fav** to add this location to the Favorites folder; or
6. Tap **Map** to set this location as the starting point and see the location on the map.



If **City First** is selected:

1. Enter city name and tap **OK**.
2. Enter street name and tap **OK**.
 (!) Advisory - DO NOT ENTER STREET TYPE. For Main Street just enter Main.
3. Enter the name of the cross-street and tap **OK**.
 (!) Advisory - DO NOT ENTER STREET TYPE.
4. From the match list, select the desired intersection.
5. Tap **Nav** to navigate to this location; or
6. Tap **Fav** to add this location to the Favorites folder; or
7. Tap **Map** to set this location as the starting point and see

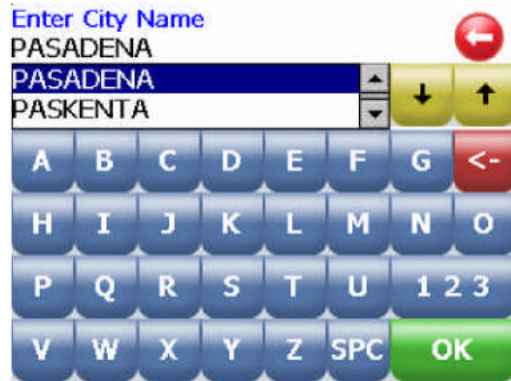

(i) Information - If a large number of records are found by the **Street First** method, the program will automatically revert to City First method.

Destination by Points of Interest (POI)

1. Tap **Menu, Destination, Points of Interest**.
2. Tap one of the categories for Points of Interest.
3. Tap a sub category (See figure 20A or selection (if shown))
4. Select **Alphabetical** or **By Distance** within 25 miles or Alphabetical under List All or By City.



If **Alphabetical** is selected:

1. Enter the name of the destination.
2. Select a matching POI location from the list.
3. Tap **OK** to accept the location. The location details will be shown.
4. Tap **Nav** to navigate to this location; or
5. Tap **Fav** to add this location to the Favorites folder; or
6. Tap **Map** to set this location as the starting point and see the location on the map.

If **By Distance** is selected:

1. Select a POI from the list
2. Tap **Nav** to navigate to this location; or
3. Tap **Fav** to add this location to the Favorites folder; or
4. Tap **Map** to set this location as the starting point and see the location on the map.

Destination from Favorites

1. Tap **Menu, Destination, Favorites**.
2. Select a destination from the list if you have already created one.
3. Tap **Nav** to navigate to this location; or
4. Tap **Map** to set this location as your starting point and see the location on the map; or
5. Tap **Edit** to create a label (i.e. HOME) for this destination or change the label if one already exists; or
6. Tap **Del** to delete this location from the Favorites folder.

Destination from Recent

1. Tap **Menu, Destination, Recent**.
2. Select the destination.
3. Tap **Nav** to navigate to this location; or
4. Tap **Map** to set this location as your starting point and see the location on the map; or
5. Tap **Fav** to add this location to the Favorites folder; or
6. Tap **Del** to delete this location from the Recent list.

Destination from City Center

This option auto routes to a city instead of a street or POI. City choices can be made statewide or within 25 miles from the current location.

To Set the Route Options

1. Tap **Menu, Settings, Route Options** to open the Route Options screen.
2. Select the desired option(s).
3. Tap **OK** to accept or **Cancel** to reject changes.

Method: Selects the method of routing. The quickest route, shortest route, route that favors major roads, or route that favors local roads.

Ferries: Selects whether ferries should be included or excluded in the route calculation. Note: selecting ferries does not include ferry schedules or time spent on the ferry.

Toll Roads: Selects whether toll roads should be included or excluded in the route calculation.

Carpools: Selects whether carpool lanes (High Occupancy Vehicle lanes) should be included or excluded in the route calculation.

Turns: Selects more or less turns in the auto route.

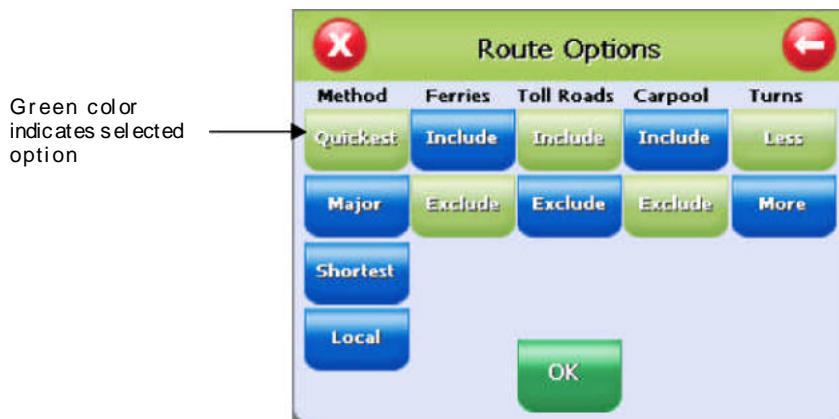

To Set the Display Options

1. Tap **Menu, Settings, Display Options** to open the Display Options screen.
2. Select the desired option(s).
3. Tap **OK** to accept or **Cancel** to reject change(s)



Orientation: Orients the Map screen so that the driving direction is heading up or North is always up

Day/Night: The Auto setting changes from Day to Night Mode automatically at approximately sunrise and sunset. Select "Day" to have the display be bright or select "Night" to have the display change to be better suited for night driving.

POI icons: The "default" setting will display only commonly displayed icons that appear on the map at 1000 ft zoom level or closer. The "Off" option turns off all POI icons so that none are displayed. The "Custom" option allows which type or category of POI to be displayed.

Color: Sets the background color of the map page to several color choices.

3D View: Sets the viewing angle from the default setting of 2D to 3 different 3D views. Note: when map page is set to 3D, tapping on the map will not provide POI information. Different views can be toggled from 2D to 3D by pressing down on the directional button.

To Create or Add to the Favorites List

1. Enter a destination.
2. From the match list, tap **Fav.**
3. Tap **OK.**

- or -

1. Tap **Menu, Recent.**
2. Select a recent destination.
3. Tap **Fav.**
4. Tap **OK.**

To Add a label to your Favorites

1. Tap **Menu, Destination, Favorites.**
2. Select a destination.
3. Tap **Edit.**
4. Enter a label using the keypad.
5. Tap **OK**

Panning and Zooming

To Pan the Map

From the Map screen tap and drag the map area.

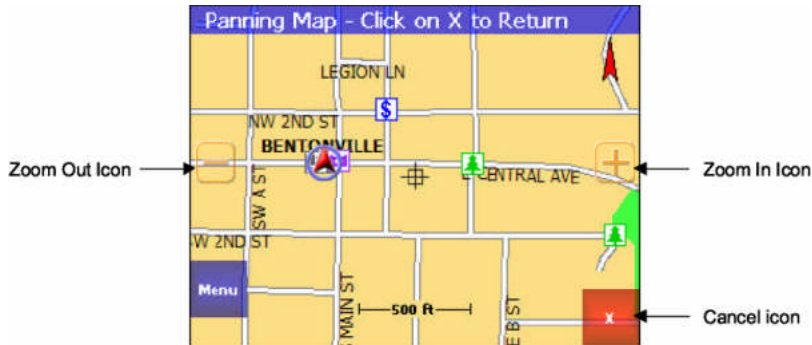

(i) Information - While in Panning Mode, tap the X icon to return to the Map screen. Tap on the North icon displayed to rotate the map so that North or Heading is pointing up.

To Zoom In and Out

Use the hardware up(+) and down(-) buttons to zoom in and zoom out. You can also use the zoom icons (+/-) on the Map screen. See figure 10A.

Adjusting the Volume



1. Press the Volume-up button or the Volume-down

Volume UP button
Volume DOWN button

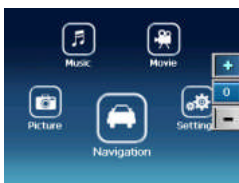

2. A box indicating the current volume is displayed as shown left. Pressing the Volume-up button or the Volume-down button increases or decreases the system volume by one level.

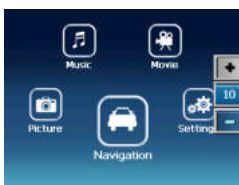

3. You can adjust the volume from Volume 0 to Volume 10. When there is no further input, the volume entered last is stored. The volume indication box automatically disappears after two seconds.



Note

Volume adjusted with the volume buttons is applied to the whole system. However, the volume of the music player or the movie player affects only the concerned program.

Localization

The localization options, under **Settings**, give you control over settings affected by your location, including:

- Language
- Time zone
- Daylight savings time
- Units



Speed alert

You can use the speed alert feature to warn you if your vehicle is exceeding the speed limit. There are two speed alert options: Auto speed alert and fixed speed alert. Auto speed alert uses the type of road to determine the probably speed limit. Fixed speed alert lets you enter a speed and will warn you if that speed is exceeded.

To set the speed alert:

1. Tap **MENU**. The main menu appears.
2. Tap **Settings, Speed Alert**. The Speed Alert screen appears.
3. To set auto speed alert:
 - Tap the Auto Speed Alert check box. A check mark indicates that Auto Speed Alert is on.
 - Tap OK. A warning appears.
 - Tap OK to close the warning.
 - Tap OK. You return to the map.
4. To set a fixed speed alert:
 - Tap the Fixed Speed Alert checkbox. A check mark indicates that Fixed Speed Alert is on.
 - Tap the speed you want to use as a maximum speed.
 - Tap OK. You return to the map.

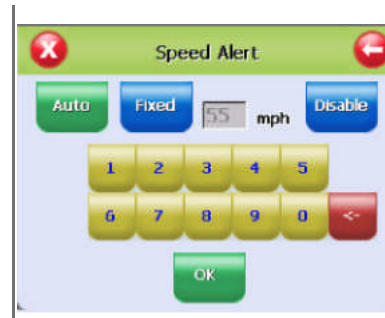
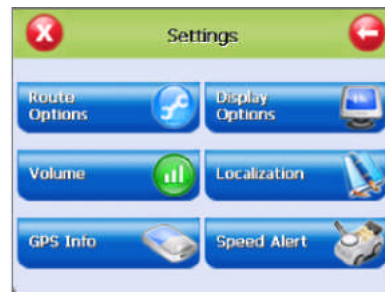

Exit Map Program - About Screen

For software version information and also to exit the mapping program, follow these steps.

1. Tap **Menu**.
2. Tap **System Information**, the About screen will be shown.
3. Tap the **left arrow** ← icon to return to the map page.
4. Tap **Exit** to turn off the GPS program.



Connecting System to Your PC

1. It is possible to copy map data, music or moving picture files into the built-in flash memory inside the body or the SD/MMC memory card by connecting the system to a PC via the USB cable.



- It is not allowed to execute functions other than file copying and moving when the system is connected to a PC via the USB cable; the button, the touch screen, the soft reset mode and the GPS receiver become inoperable.
- The system operates with the power from the USB port of the PC when the system is connected to the PC. Therefore, the system shall be connected with the USB port where the power is normally supplied. The system may not be capable of normal operation when connecting with the USB hub.
- The battery is not recharged via the USB port

2. After booting the PC, connect the system to the PC using the USB cable as shown below.

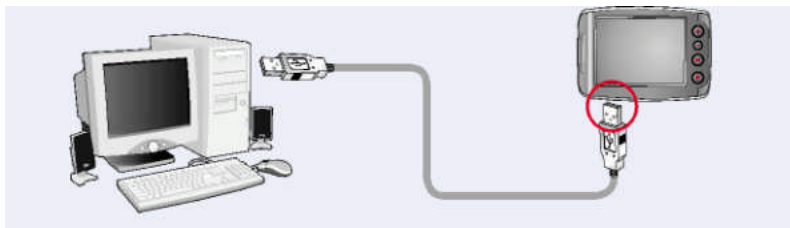

3. When the system is successfully connected to the PC, the screen displays as follows:

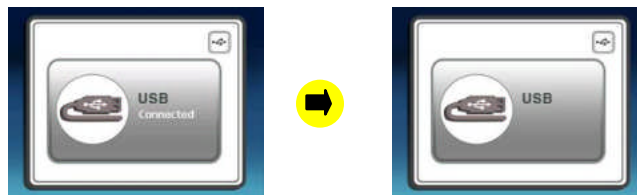

4. When the system is normally connected to the PC, you can see two 'removable disk' drives in the Windows Explorer window.

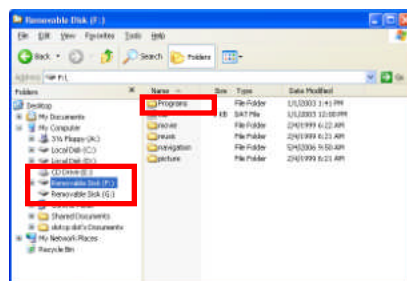

Installing the USB Driver

No driver is needed when using Windows XP. No other operating system is supported.

Distinguishing Between Removable Disks

- The two 'removable disks' represents 'Built-in flash memory' and 'SD/MMC memory' of the system, respectively.
- 'Built-in flash memory' and 'SD/MMC memory' are indicated in Windows Explorer as 'Removable disk (*)' and 'Removable disk (*)', respectively. Drive letters will be assigned according to the system resources available. Of the two drives, the first drive (*) corresponds to 'Built-in flash memory'.

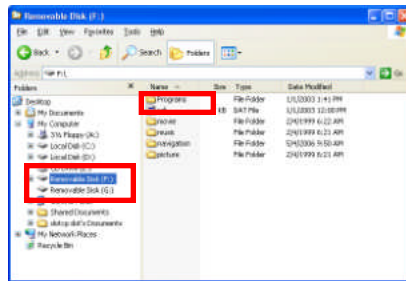

- Disconnected the USB cable once map data updating or file copying work is complete. When disconnecting the USB cable, the system restarts.

Copying Files

To play the media data used in each media player program, e.g. music player, movie player, and picture viewer, the data files must be located in the 'SD/MMC Memory' folder only. The data files specific to each media player must be stored in the specified folder in 'SD/MMC Memory' when you wish to use the programs.

The folder names of the respective media player programs are as shown in the table below.

Supplementary Program	Folder Name
Music player	'Music'
Movie player	'Movie'
Picture viewer	'Picture'

Connect the system to the PC via the USB cable, and copy necessary files from Windows Explorer on the PC to 'SD/MMC Memory' folder. (Refer to "Connecting System with PC-Distinguishing Between Removable Disks.")

Opening the 'SD/MMC memory' folder on PC Window Explorer displays the screen as shown.

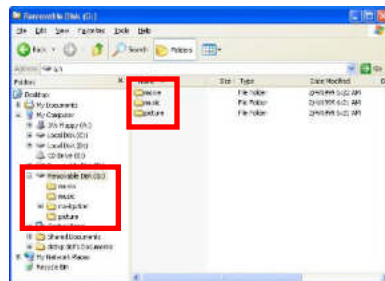

Note

- Do not copy files of music, movie, or pictures to the Built-in flash memory folder.
- Do not forget to execute 'Safely Remove Hardware' on the PC after you complete copying files.
- Do not disconnect the USB cable or remove the 'SD/MMC memory' card while you are copying files.

Safely Removing Hardware

Windows XP

File copying is normally complete only when executing 'Safely Remove Hardware' on the PC after copying the files by connecting the system to the PC via the USB cable.

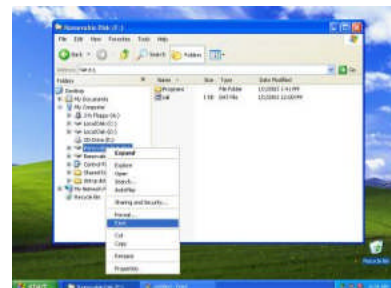

Windows XP

Double click the Window tray icon to execute 'Safely Remove Hardware' as shown below.

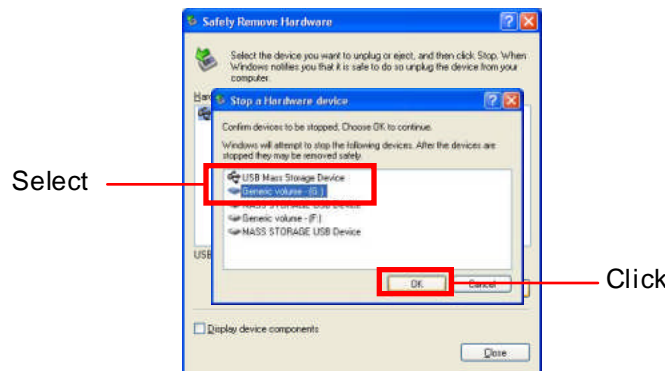
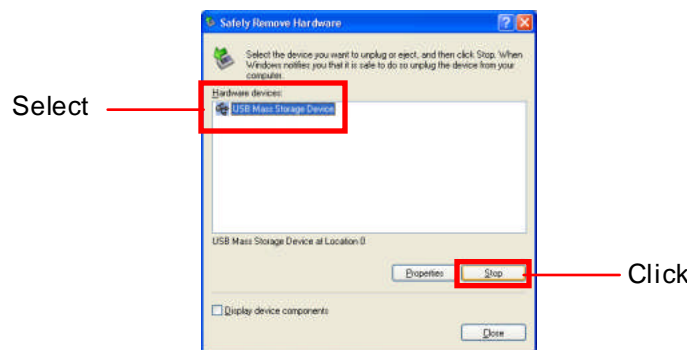

Using Supplemental Programs

Getting Ready

Storing Files

Files of music, movies and pictures can only be stored in 'SD/MMC memory'. It is not allowed to play the files of music, movies and pictures stored in 'Built-in flash memory' with the supplemental programs.

Copy the desired files under their respective Music, Movie or Picture folder in 'SD/MMC memory' before playing the file.

Playing Music Files

Normal MP3 or WMA files can be played with the Music player. However, certain MP3 files or OGG files encoded in the variable bit rate mode can only be played with the Movie player (Refer to 'Movie Player').

Menu Program

1. When the system starts, the menu selection screen is displayed as shown right. If you make no selection for five seconds from the menu selection screen, the system is switched automatically to the navigation mode.

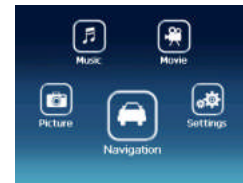

2. When you press the desired icon once, the system is switched to the selected program (The screens shown are for the music player.)

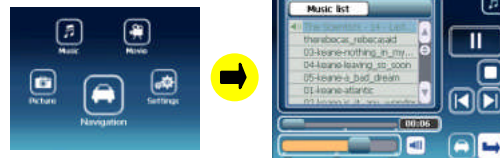

3. Pressing the menu button on the front of the body returns the system to the menu program from the current program.



The figures are an example of returning to the menu program from the music player.

Music Player

Names and Functions

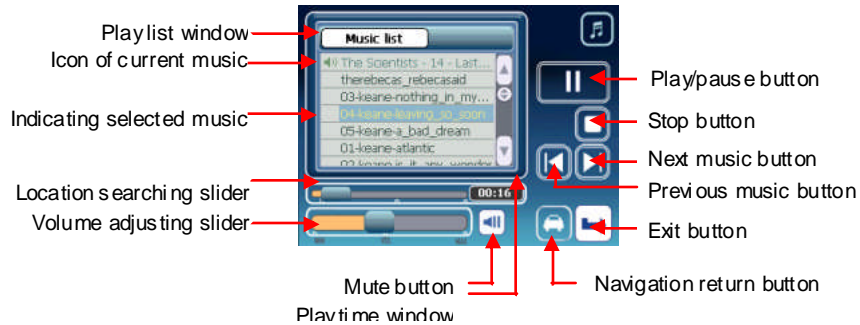

In-Depth Description of Functions

Search of Playing Position

The Location Searching Slider indicates the play position of a music file. You can adjust the play position to a desired point. When moving the slider bar, the Play time window displays the moved position in duration.



Functions of the Control Buttons

Icon	Button	Function
	Play button	Plays a music file selected from the play list.
	Stop Button	Stops playing the file.
	Pause Button	Pauses playing the file. Pressing the icon again resumes playing the file.
	Next Music Button	The next music file of the current file in the play list is played
	Previous Music Button	The previous music file of the current file in the play list is played.
	Exit Button	Exits the music player.
	Navigation Return Button	Switches the system from the music player to the navigation program.

Volume Adjusting and Muting

The volume adjusting slider indicates the current volume. You can adjust the volume to the desired level by moving the slider bar left or right.

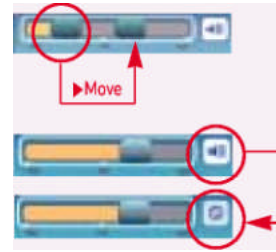

You can turn off the sound by pressing the Mute button.

Displaying the Play List

Connect the Voya 320 to the PC (Refer to 'Connecting System to Your PC'), and copy the music file to the 'Music' folder in the SD/MMC memory.



Note

You cannot create sub-folders under the 'Music' folder. The music player is capable of playing the files stored in the 'Music' folder only.

The music indicated with the speaker icon is the current music file selected.



Double-clicking the desired music file from the Play list window, plays the new music file.

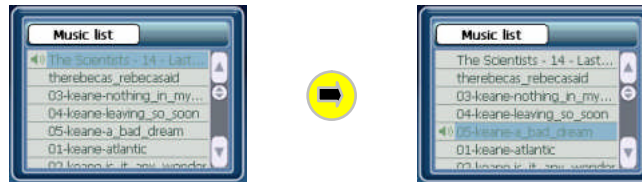

Pressing the Stop button stops playing the current music file. Click the desired music file once from the Play list window, and press the Play button to play the selected music.

Supported File Formats

MP3 and WMA files are supported.



Note

Certain files with extension of MP3 may not be supported, it is dependent upon encoding method of that file.

Movie Player

Names and Functions

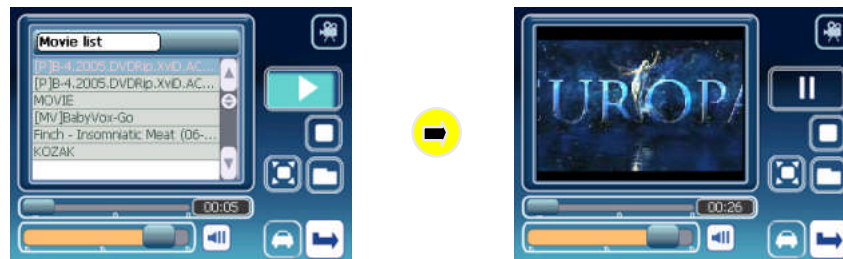
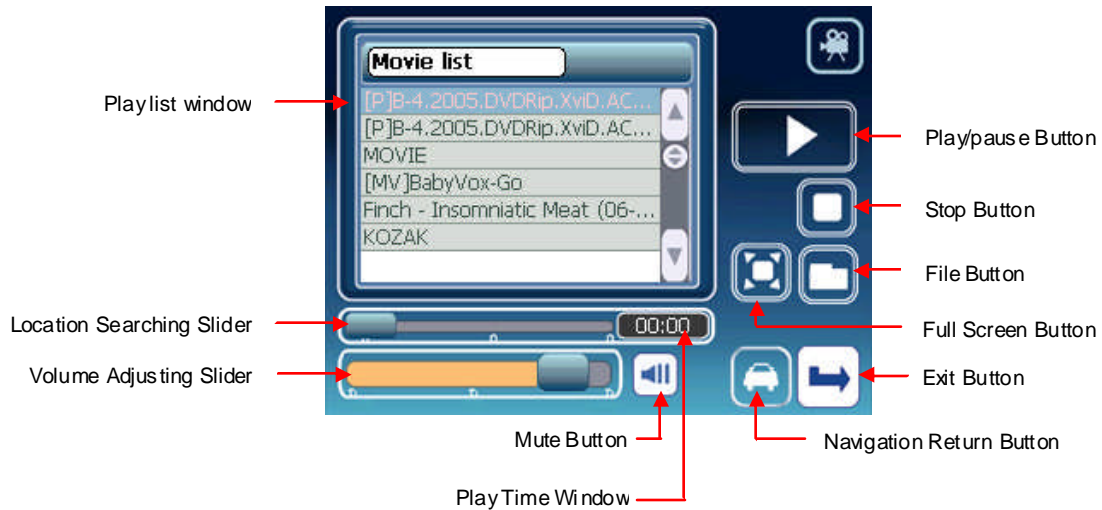







In-Depth Description of Functions

Search of Playing Position

The Location Searching Slider indicates the play position of a movie file. You can adjust the play position to a desired point. When moving the slider bar, the Play Time Window displays the moved position.

Functions of Control Buttons

Icon	Button	Function
	Play button	Plays a file selected from the play list.
	Stop Button	Stops playing the file.
	Pause Button	Pauses playing the file. Pressing the icon again resumes playing the file.
	File Button	Moves the play list window and the play screen window.
	Full Screen Button	Switches the screen to the full screen mode when playing a movie.
	Exit Button	Exits the movie player.
	Navigation Return Button	Switches the system from the movie player to the navigation program.

Volume Adjusting and Muting

The Volume Adjusting Slider indicates the current volume. You can adjust the volume to the desired level by moving the slider bar left or right.

You can turn off the sound when pressing the Mute button.

Storing Movie Files and Viewing Movies

Connect the Voya 320 to the PC (Refer to 'Connecting System to Your PC'), and copy the movie file to the 'Movie' folder in the SD/MMC memory.



Note You cannot create sub-folders under the 'Movie' folder. The movie player is capable of playing the files stored in the 'Movie' folder only.

Pressing the File button displays the movie file list in the 'Movie' folder.



Select the desired movie file from the figure above, and press the Play button, or double click the desired movie file from the Play list window to play the selected movie file.



Note

Pressing the File button while playing a movie causes the current movie to pause playing, and the play list is displayed. Pressing the File button again returns to the movie play screen. Pressing the Play button will resume playing the current movie.

Pressing the Full Screen button, or clicking the Play Screen window once, switches the screen to the full screen. Clicking the full screen once returns the screen to the original size.

Supported File Formats

File formats of MP4, WMA, AVI and DIVX are supported.



Note

- Close the navigation program when you use the movie player. When you run multiple programs, the playing of the movie may be interrupted, or an error message may be displayed indicating insufficient memory.
- If another program gets activated while using the movie program, the movie player is switched to Pause.

Listening to Music with the Movie Player

The Movie player can even play some MP3 files or OGG files that are not compatible with the Music Player. Copy the MP3 or OGG file to 'Movie' folder, and play the file with the movie player.



Note

Music files or movie files stored in the Movie folder are played in sequential manner.





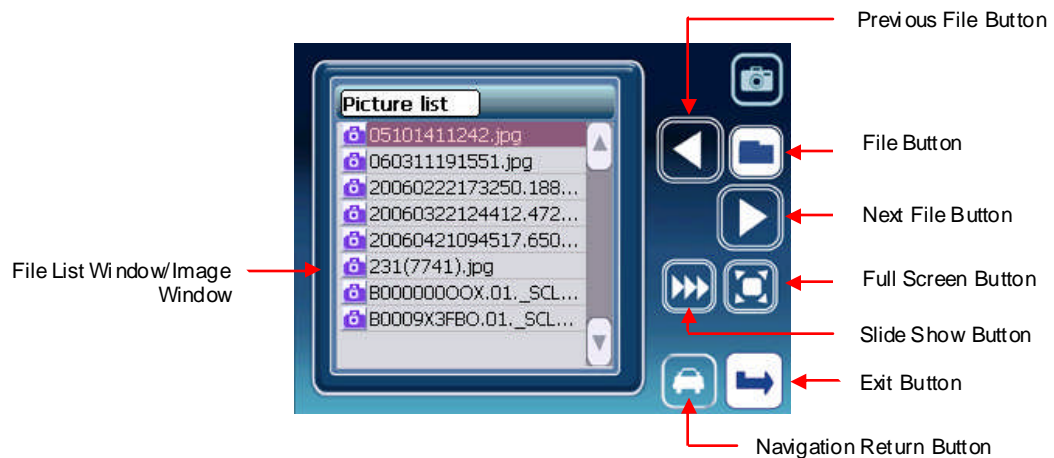

Picture Player

Names and Functions



In-Depth Description of Functions

Functions and Control Buttons

Icon	Button	Function
	File Button	Switches the picture view window to the file list window.
	Full Screen Button	Displays the selected picture in the full screen .
	Previous File Button	Pauses playing the file. Pressing the icon again resumes playing the file. Moves to the previous picture file when viewing the current picture.
	Next File Button	Moves to the previous file in the list window. Moves to the next picture file when viewing the current picture
	Slide Show Button	Switches the screen to the full screen slide show mode.
	Exit Button	Exits the movie player.
	Navigation Return Button	Switches the system from the picture viewer to the navigation program.

Storing Image Files and Viewing Images

Connect the Voya 320 to the PC (Refer to 'Connecting System to Your PC'), and copy the image file to the 'Picture' folder in the SD/MMC memory.

Double clicking the desired file from the File list window displays the image as shown below:

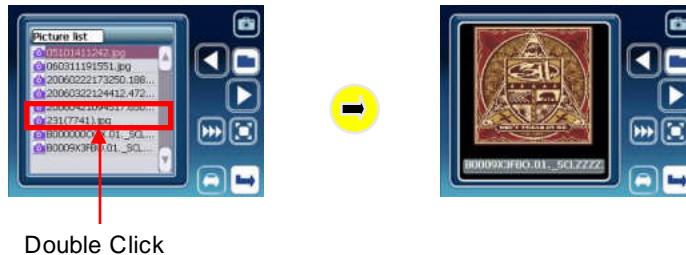

Select the desired file from the File List window and press the Full Screen button to display the selected image in the full screen.

Select the desired file from the File List window and press the Slide Show button to display the images in the full screen from the selected file in sequential manner.

Press the Full Screen button with the selected image on the Image window to display the image in the full screen.





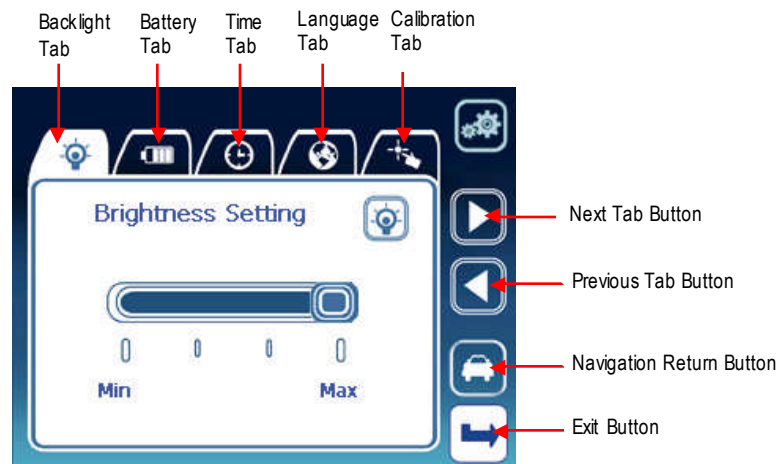

Only JPG file format is supported.
Note: High resolution and large size pictures taken by a digital camera may not be displayed on the Voya 320. Lower the resolution of your images for faster processing. The system is optimized at 16-bit color with resolution of 320 x 240 (width x height).

Setting Environments

Names and Functions



Functions of Control Buttons

Icon	Button	Function
	Previous Tab Button	Moves to the previous tab from the current tab.
	Next Tab Button	Moves to the next tab from the current tab.
	Navigation Return Button	Switches the system from the setting menu to the navigation program
	Exit button	Exits environments setting.

Adjusting the Brightness Backlight

Brightness of the backlight can be adjusted to four levels ranging from level 1 to 4. You can adjust the brightness by moving the Brightness Adjustment slider. The default setting of the backlight is set to level 4.

Brightness Adjustment Slider

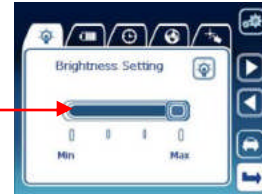

Press the Power button for about two seconds to set the backlight to level 1. Press and hold the power button for two seconds again to return the backlight to the original brightness.



Keep pressing the button for about two seconds.

Checking Battery Conditions

When the AC/DC adapter or the cigarette lighter adapter is connected, the Power Status icon is displayed as 'Adapter.'

Power Status Icon
Battery Remainder Power Meter

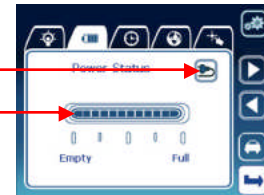

When the battery is being recharged, the Battery Remainder Power meter alternately moves between the four levels. During this process, the Power button flashes red.



When the battery is fully charged, the Battery Remainder Power meter does not move, but is kept at the 'Full' condition. The Power button on the body lights green.



In the battery-powered mode, the Power Status icon is displayed as 'Battery', and the Battery Remainder Power meter indicates the current remaining Power Status icon power in the battery.

Power Status Icon



Note

The value indicated by the battery power meter may be different from the actual remaining power in the battery dependent upon environmental conditions.

When the remaining power in the battery is 20-30% of its full capacity, the warning window is displayed as shown right. In such a case, immediately recharge the battery.



When you fail to recharge the battery after the warning window is displayed, the system is forcibly switched to the power-saving mode. Refer to 'Power Mode and Battery Recharging.'

Time Setting

Change the current time setting by clicking the item you want to change and increase or decrease the value with the new one using the 'Add button' or the 'Subtract button'.

Add Button

Subtract button

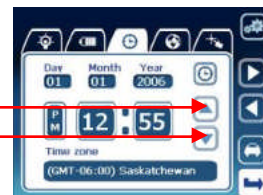

Note

In case the battery completely discharged or if you make hard reset, the time setting is initialized with the system default value.

Language Setting

You can change the current language used in the menu program by clicking the 'Previous button' or the 'Next button'. All text will be changed to selected one.

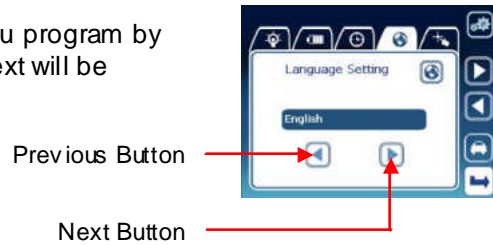

This setting will be applied on the menu program only. It has no effect on the system language.

Touch Screen Calibration

If there is deviation between the point touched by you and the point actually indicated on the screen during operation of the system, you can recalibrate the touch screen.

Press the Touch Calibration button as shown.



Keeping the cross mark pressed moves the cross mark in the arrow direction, as shown. Press the cross mark again to the moved position. Repeat this until the Exit screen is displayed.

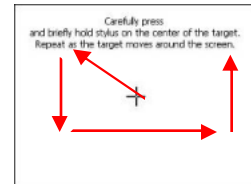

When the touch calibration is successfully executed, the Exit screen is displayed. When touching the screen once, the screen is returned to the touch calibration screen.

New calibration is now complete. Click on the screen.



Troubleshooting

Problem	Troubleshooting
When the machine will not work or you cannot see anything on the screen.	Soft or hard reset the machine. Check the battery life and recharge the battery, if necessary
If you cannot hear any sound when you start playing the music or movie files	Make sure the data files reside in the SD/MMC memory. Make sure the volume is properly set.
When you cannot copy files to the machine	Make sure the machine is properly connected to the computer. Make sure you have enough empty space in the memory.
When the system suddenly stops during operation and will not work	Press the RESET button
When the current location in the navigation is inaccurately displayed	Check if you are in an underground parking lot, under a road, or between tall buildings; if so, change your location. Check if there is any object interfering with the signal reception in the car or in the vicinity of the antenna, if possible, remove it.
When the navigation shows you the wrong way, even though the GPS signal reception status is good.	Map data may not be identical to the actual road condition. Check your data and update the map data if updates are available.

System Specifications

General	Model	Voya 320	
	Colors	Black (front), silver (rear)	
	Dimensions	4.33" (w) x 3.07" (H) x 0.83" (D)	
	Weight	5.93 ounces	
Hardware	CPU	Samsung S3C2440, 300 MHz	
	Memory	RAM 64 MB, Flash ROM 32/64/128/256/512/1 GB	
	Power	DC 12-24 V	
	Battery	Lithium-ion, 1,000 mA Recharging time: Approx. 3 hours Discharging time: Average approx. 2 hours (Default settings + navigation program)	
	Input mode	Touch screen	
	LCD	320 x 240, 3.5", 65K colors, TFT LCD	
	Memory card	SD/MMC memory card slot	
	Speaker	Built-in speaker, 1W	
	Headphone output	40 mW (left) + 40 mW (right): (16%, max. volume)	
	GPS	SIRF III 20-channel	
	USB	USB spec. 1.1 full speed (12 Mb/s)	
	USB Storage	USB Mass Storage Class Bulk-Only Transport (Flash ROM, SD/MMC) PC OS: Windows 98, ME, 2000 and XP supported	
	Software	OS	Version Windows CE 4.2 Core
Music Player		File formats Mp3, wma	
Movie Player		File formats	Mp4, wmv, avi, divx
		Audio play	Mp3, ogg supported
Picture Viewer		File format	Jpg
		Picture resolution	320 x 240, 65K colors

Free Manuals Download Website

<http://myh66.com>

<http://usermanuals.us>

<http://www.somanuals.com>

<http://www.4manuals.cc>

<http://www.manual-lib.com>

<http://www.404manual.com>

<http://www.luxmanual.com>

<http://aubethermostatmanual.com>

Golf course search by state

<http://golfingnear.com>

Email search by domain

<http://emailbydomain.com>

Auto manuals search

<http://auto.somanuals.com>

TV manuals search

<http://tv.somanuals.com>