

AVerMedia® AVerDiGi EB1304 NET

Operation Manual



www.avermedia.com
www.averdigi.com

FCC NOTICE (Class B)



This device complies with Part 15 of the FCC Rules. Operation is subject to the following two conditions: (1) this device may not cause harmful interference, and (2) this device must accept any interference received, including interference that may cause undesired operation.

Federal Communications Commission Statement

NOTE- This equipment has been tested and found to comply with the limits for a Class B digital device, pursuant to Part 15 of the FCC Rules. These limits are designed to provide reasonable protection against harmful interference when the equipment is operated in a commercial environment. This equipment generates, uses and can radiate radio frequency energy and, if not installed and used in accordance with the instructions, may cause harmful interference to radio communications. Operation of this equipment in a residential area is likely to cause harmful interference in which case the user will be required to correct the interference at his own expense.

CAUTION ON MODIFICATIONS

To comply with the limits for the Class B digital device, pursuant to Part 15 of the FCC Rules, this device must be installed in computer equipment certified to comply with the Class B limits. All cables used to connect the computer and peripherals must be shielded and grounded. Operation with non-certified computers or non-shielded cables may result in interference to radio or television reception.

Changes and modifications not expressly approved by the manufacturer could void the user's authority to operate this equipment.

European Community Compliance Statement (Class B)



This product is conformity with the protection requirements of EU Council Directives 89/336/EEC amended by 92/31/EEC on the laws of the Member States relating to electromagnetic compatibility.

Warning - This is a Class B product. In a domestic environment this product may cause radio interference in which case the user may be required to take adequate measures to correct this interference.

DISCLAIMER

No warranty or representation, either expressed or implied, is made with respect to the contents of this documentation, its quality, performance, merchantability, or fitness for a particular purpose. Information presented in this documentation has been carefully checked for reliability; however, no responsibility is assumed for inaccuracies. The information contained in this documentation is subject to change without notice.

In no event will AVerMedia be liable for direct, indirect, special, incidental, or consequential damages arising out of the use or inability to use this product or documentation, even if advised of the possibility of such damages.

TRADEMARKS

AVerMedia is registered trademarks of AVerMedia TECHNOLOGIES, Inc. IBM PC is a registered trademark of International Business Machines Corporation. Macintosh is a registered trademark of Apple Computer, Inc. Microsoft is a registered trademark and Windows is a trademark of Microsoft Corporation. All other products or corporate names mentioned in this documentation are for identification and explanation purposes only, and may be trademarks or registered trademarks of their respective owners.

COPYRIGHT

© 2006 by AVerMedia TECHNOLOGIES, Inc. All rights reserved. No part of this publication may be reproduced, transmitted, transcribed, stored in a retrieval system, or translated into any language in any form by any means without the written permission of AVerMedia TECHNOLOGIES, Inc.



The mark of Crossed-out wheeled bin indicates that this product must not be disposed of with your other household waste. Instead, you need to dispose of the waste equipment by handing it over to a designated collection point for the recycling of waste electrical and electronic equipment. For more information about where to drop off your waste equipment for recycling, please contact your household waste disposal service or the shop where you purchased the product.

Battery Safety Information

- Store the batteries in a cool dry place.
- Do not dispose of used batteries in domestic waste. Dispose of batteries at special collection points or return to point of sale if applies.
- Remove the batteries during long periods of non-use. Always remove exhausted batteries from the remote control. Battery leakage and corrosion can damage this remote control, dispose of batteries safely.
- Do not mix old and new batteries.
- Do not mix different types of batteries: alkaline, standard (carbon-zinc) or rechargeable (nickel-cadmium).
- Do not dispose of batteries in a fire. The batteries may explode or leak.
- Never short circuit the battery terminals.



WARNING

TO REDUCE RISK OF FIRE OR ELECTRIC SHOCK, DO NOT EXPOSE THIS APPLIANCE TO RAIN OR MOISTURE



CAUTION

IF THERE IS ANY DAMAGE, SHORTAGE OR INAPPROPRIATE ITEM IN THE PACKAGE, PLEASE CONTACT WITH YOUR LOCAL DEALER. WARRANTY VOID FOR ANY UNAUTHORIZED PRODUCT MODIFICATION

Table of Contents

Chapter 1 Introduction	1
1.1 Package Content.....	1
1.2 Features and Specifications	1
1.3 Front Panel	2
1.4 Back Panel.....	2
1.5 Setting Up the DVR Unit	3
1.5.1 Installing the Hard Disk.....	3
1.5.2 Connecting Devices.....	5
1.5.3 Connecting the Sensor/Relay device.....	5
Chapter 2 Operating the EB1304 NET.....	7
2.1 Familiarizing the Remote Control Buttons.....	7
2.1.1 Using AB Repeat Function.....	8
2.1.2 Using USB Backup Button.....	9
2.2 Using the EB1304 NET for the First Time	9
2.2.1 Set up the System Date and Time	9
2.3 Surveillance Screen	10
2.4 Playback the Video	10
Chapter 3 OSD Navigation Tree.....	12
3.1 Menu Function	13
Chapter 4 Using the USB Playback Console	23
4.1 Recommended system requirements.....	23
4.2 Installing the USB Playback Console	23
4.3 Running the USB Playback Console.....	24
4.3.1 To Cut and Save the Portion of the Recorded Video	26
4.3.2 Playback DVR Recorded File from Hard Disk	26
4.3.3 Playback Backup File(*.dvr).....	27
Chapter 5 Backup Recorded Video File.....	28
5.1 Recommended system requirements.....	28
5.2 Familiarizing with HDD Backup Application.....	28
5.3 To Backup Recorded Video File	29
Chapter 6 ImageVerification	31
6.1 To Run the ImageVerification	31
Chapter 7 Video Enhancer	32
Chapter 8 Using the Remote Programs.....	34
8.1 Familiarizing the Web Viewer Buttons.....	35
8.1.1 To Setup Remote System Setting.....	36
8.2 Familiarizing the Remote Console Buttons	43

8.2.1	To Setup Remote Console Setting.....	44
8.3	Using the Remote Playback.....	45
8.3.1	Familiarizing the Local Playback Buttons	46
8.3.2	Familiarizing the Download and Playback Buttons	48
Appendix A	Registering Domain Names	49

Chapter 1 Introduction

1.1 Package Content



- (1) AVerDiGi EB1304 NET unit
- (2) Remote Control (batteries included)
- (3) Quick Installation Guide
- (4) Power Cord
 - * The power cord varies depending on the standard power outlet of the country where it is sold.
- (5) Power Adapter
- (6) DVR accessories (including 4 screws)
- (7) Software CD (User Manual included)

1.2 Features and Specifications

- Non-PC stand-alone network digital video recorder
- 4 composite video inputs and 1 composite output
- VGA output for LCD or CRT monitor display
- On Screen Display(OSD) control menu
- MPEG4 video compression
- Auto-detect NTSC or PAL video system
- Support Web viewer on Internet Explorer
- Support Central Management System(CMS)
- Support remote console
- Support USB backup to pen drive and external hard disk
- Support network, playback, and recording simultaneously
- Supports 1 hard disk drive (not included)
- Full-screen resolution:
 - Display: 720 x 480 (NTSC) / 720 x 576 (PAL)
 - Recording: 720 x 480 (NTSC) / 720 x 576 (PAL)
- Recording frame rate:
 - D1 mode: 60fps(NTSC) / 50fps (PAL)**
 - CIF mode: 120 fps (NTSC) / 100fps (PAL)**
- Scheduled recording (00:00~23:00 set by hour)
- Search for recorded video files by date/time/event
- Input/Output: 4 sensor inputs and 1 relay output control
- Multiple language operation screens

1.3 Front Panel



Name	Function
(1) DVR Power LED 	: Light when the unit is power on
(2) HDD LED 	: Indicate the hard disk running state. Light when the HDD is running (Read/Write)
(3) IR Sensor	: Receive signal from the remote control to operate the unit
(4) USB 2.0 Port	: Connect to pen drive / external hard disk for backup

1.4 Back Panel

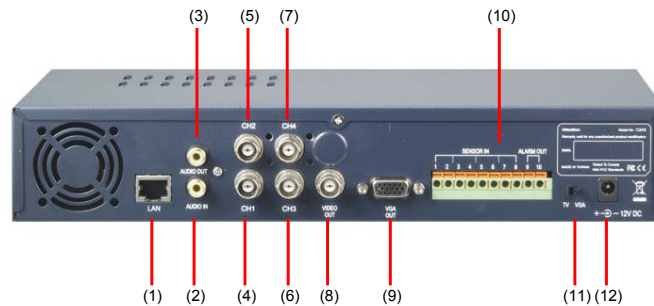

Name	Function
(1) RJ-45 port	: Ethernet connection port
(2) Audio In	: Input the audio signal from audio output device which it has a power supply by itself. The audio is embedded with channel 1
(3) Audio Out	: Output the audio signal to a audio out device which it has a power supply by itself
(4) CH1	: Input the video camera signal and display it on channel 1
(5) CH2	: Input the video camera signal and display it on channel 2
(6) CH3	: Input the video camera signal and display it on channel 3
(7) CH4	: Input the video camera signal and display it on channel 4
(8) Video Out	: Output the video signal to other vedio output device through BNC port
 The DVR unit support 2 video output ports and you can only select to output the video either from the VGA OUT or VIDEO OUT	
(9) VGA OUT	: Output the video signal to a CRT or LCD monitor
(10) Sensor In & Alarm Out	: Support up to 4 sensor device and 1 relay device (Relay: 1A @ 125V AC/30V DC)
(11) TV-VGA Switch	: Switch to select the video output. Make sure to set the video output before turning on the unit
(12) 12V DC	: Connect the power adapter into this port

1.5 Setting Up the DVR Unit

1.5.1 Installing the Hard Disk

The DVR unit allows user to install one hard disk. Before installing the hard disk, make sure to set the hard disk master jumper setting. Adjust the jumper setting according to the instructions on the hard disk label.



Use 40GB/ 7200RPM IDE interface hard disk or larger is recommended

Follow the illustrated instructions below to install the hard disk:

1. Loosen all screws

2. Push the cover backward and lift

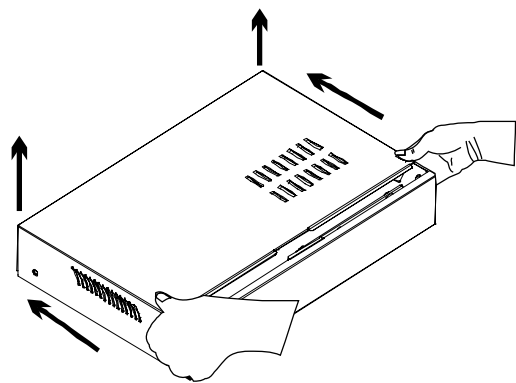
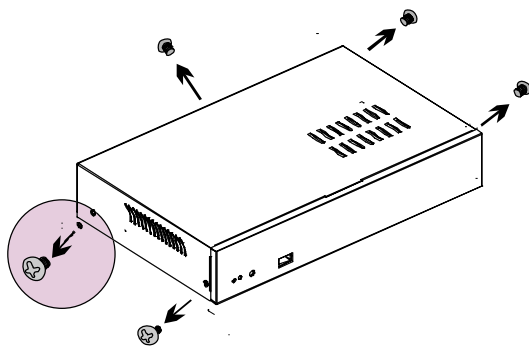

3. Loosen the hard disk rack 4 screws

4. Secure the brackets on the hard disk

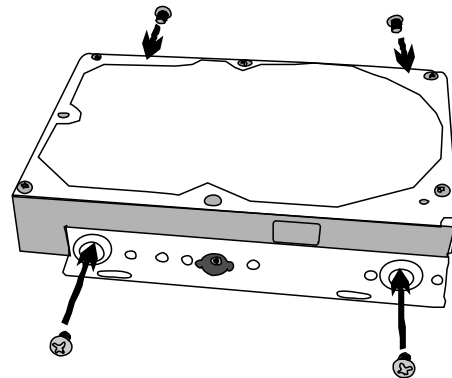
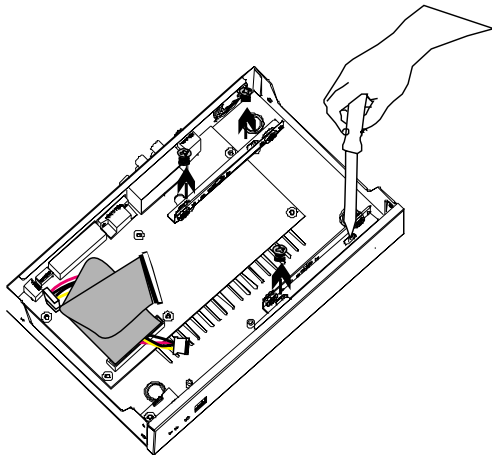

5. Connect the end of the IDE cable and the power connector to the hard disk

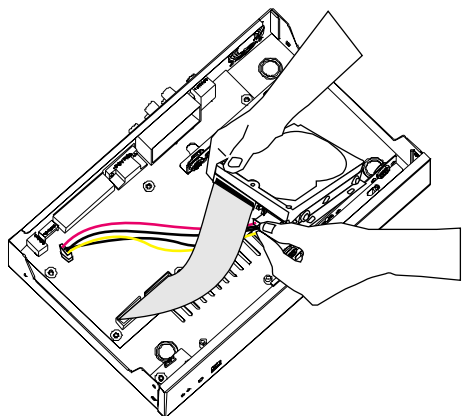

6. Secure the hard disk inside the unit then replace unit cover

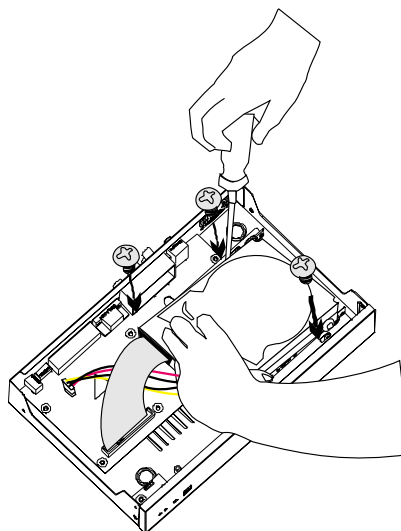

7. Push the cover forward

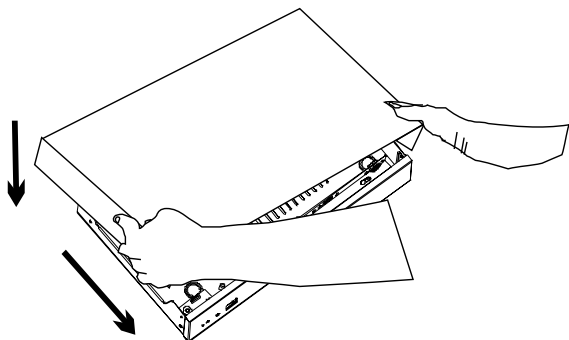

8. Secure the cover

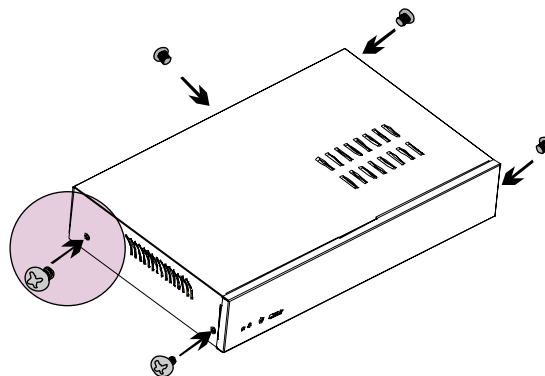

9. You may now connect all the cables. When the power is connected, the Power LED light  turns on

1.5.2 Connecting Devices

The back panel of the DVR unit, user can connect up to 4 video cameras, 4 sensor devices, 1 alarm device and output video to a TV or CRT/LCD monitor. Connecting the unit to a pen drive or external hard disk through USB connection for backup, then use the bundled software enables user to transfer, playback and segment the video. Follow the illustration below to make the connection:

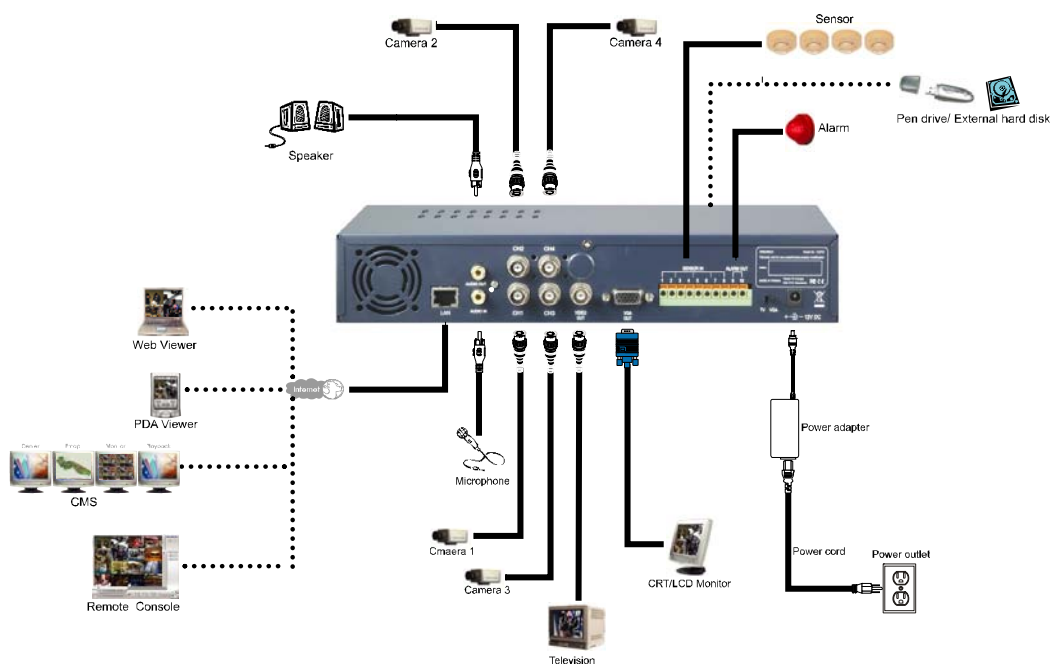

Each time user changes the video display output, the power must be **UNPLUGGED** and **PLUGGED** to reset

1.5.3 Connecting the Sensor/Relay device

The Sensor and Alarm ports enable you to connect (4) sensor inputs and (1) relay outputs. Just connect the external sensor and relay pin directly to the pinhole. Check the table below and locate which pinhole is assigned to sensor input and relay output.

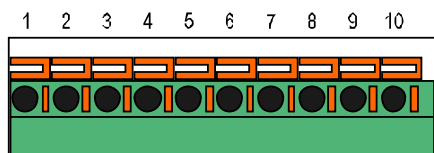

1.5.3.1 I/O Card Sensor and Relay pinhole allocation:

The signal from the sensor (i.e., infrared sensors, smoke detectors, proximity sensors, door sensors, etc.) is being transmitted to the unit and this triggers the system to respond and send signal to relay device (i.e., alarm, telephone etc).









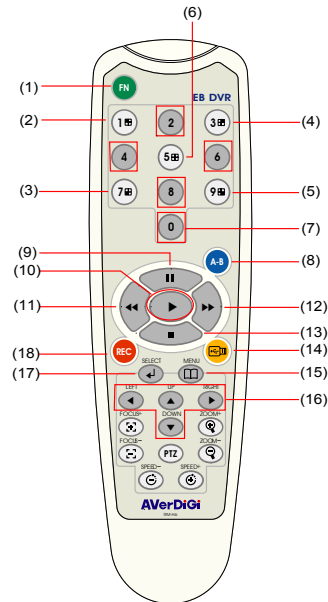





Pin #	Definition
1	Sensor 1 positive pole signal
2	Sensor 1 negative pole signal
3	Sensor 2 positive pole signal
4	Sensor 2 negative pole signal
5	Sensor 3 positive pole signal
6	Sensor 3 negative pole signal
7	Sensor 4 positive pole signal
8	Sensor 4 negative pole signal
9	Relay negative pole signal
10	Relay positive pole signal













Chapter 2 Operating the EB1304 NET

2.1 Familiarizing the Remote Control Buttons

Use the Remote control to operate the OSD menu on surveillance screen.







Button	Function
(1) 	A functional key for multiple DVR system remote control
(2) 	Switch to Channel 1 As a number key for entering password
(3) 	Switch to Channel 2 As a number key for entering password
(4) 	Switch to Channel 3 As a number key for entering password
(5) 	Switch to Channel 4 As a number key for entering password
(6) 	Switch to CIF mode As a number key for entering password
	As a number key for entering password
	
(7) 	
	
	
(8) 	Set a playing recorded video from A point to B point segment and repeat playing on surveillance screen(See 2.1.1)
(9) 	Pause the playing
(10) 	To play the video

Button	Function
(11) 	Decrease the video playback at the speed of 2x, 4x 8x or 16x
(12) 	Fast play the video playback at the speed of 2x, 4x 8x or 16x
(13) 	Stop playing / Stop recording
(14) 	USB backup(see 2.1.2)
(15)    	To move the selection to the left and right To go up and down and select the items in the menu list or change the settings
(16) 	To enter the OSD Main menu / Exit from the main menu or sub-menu display
(17) 	Make a selection Enter sub-menu
(18) 	Start video recording
	The lower parts of buttons are not functional for the DVR system.

2.1.1 Using AB Repeat Function



AB Repeat function allow user to set a video segment from A to B point and play on the surveillance screen until user stop. User also can backup AB Repeat file to pen drive or external hard disk (See [2.1.2](#)).

- Press  (play button) to call out the **SEARCH MODE** menu to find the recorded video that user wants to playback.
- Select **TIME SEARCH** or **EVENT LIST**.
 - TIME SEARCH** (search by date and time): select the date and time from where you want to begin the video playback.
 - EVENT LIST** (search by condition): select from the list.
- During the playback, press  to set the A point of video segment. And then, press  again to set the B point of video segment. On the surveillance screen will display “**A-B**” and repeat playing the AB point video segment which user has set. To cancel AB repeat, press  again.



2.1.2 Using USB Backup Button

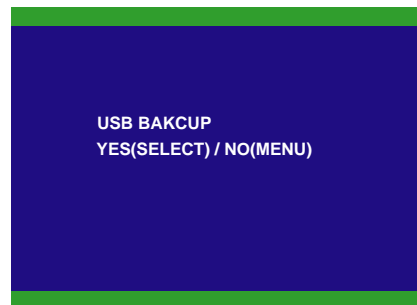

User can press  button to backup the AB Repeat video file.

1. Set the AB Repeat file (see [2.1.1](#)).
2. Plug in pen drive or external hard disk to DVR system.
3. During the AB Repeat playback, press  button.
4. And then, press  (YES) to start backup file or press  (NO) to exit backup mode.



The DVR system doesn't support the power for external hard disk. Therefore, the external hard disk need has power supply by itself.





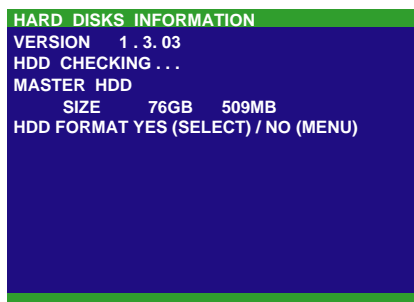





2.2 Using the EB1304 NET for the First Time

Upon connecting the power, the unit automatically detects the status of the hard disk. The hard disk must be formatted before user can use it with EB1304 NET. If you are prompt to format the hard disk, press  (select) for **YES** to format the hard disk and  (menu) for **NO** to remain unchanged.





2.2.1 Set up the System Date and Time

Before starting record video, adjust the date and time first.

1. Press  to call up the OSD menu and then use  and  to go up and down and select Submenu. And then, press  to confirm the selection.
2. In Submenu, select the Date and press  again to make a selection. And then, use  and  to adjust the date and use  and  buttons to move the selection to the left and right.
3. To adjust Time, follow the above step 2 and 3.
4. Press  to go back to main menu after adjustment.

2.3 Surveillance Screen

To know if the channel is being recorded, the “●” record symbol would appear beside the channel number. The  (microphone) and  (speaker) indicate that the audio is available. The information below the screen shows the current date and time, recording mode (record schedule setting), and the percentage of the used hard disk space.

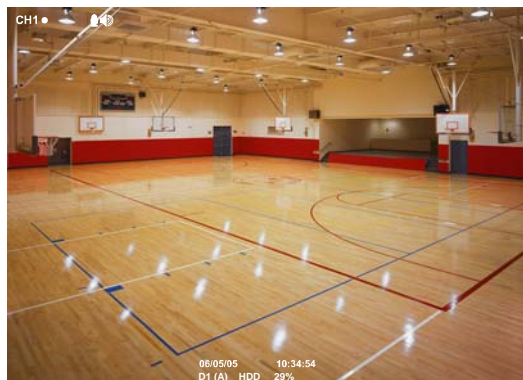

D1 mode Screen Preview

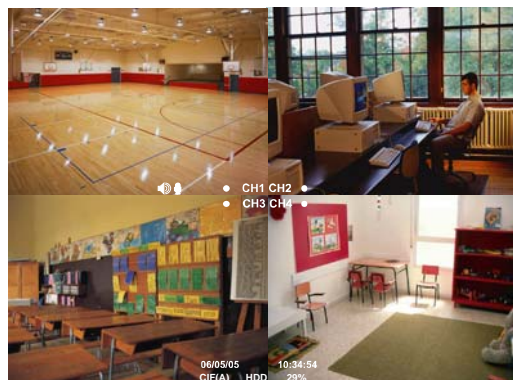

CIF model Preview

When you are in full screen preview, press the following buttons on the remote control to switch to different channel, or preview all 4 channels:



CH1: Camera1



CH2: Camera 2



CH3: Camera 3







CH4: Camera 4



QUAD: 4-Channel





2.4 Playback the Video

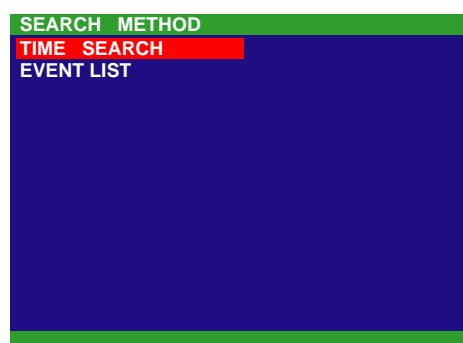





The DVR system can record and playback video simultaneously. Therefore, user don't need to stop recording while playback the video.





1. Press 
2. Use the  and  buttons to go up and down and select TIME SEARCH or EVENT LIST. Then, press  or  to make a selection.



TIME SEARCH (search by date and time):







1. Use the  and  buttons and select **SEARCH TIME**. Then press  or  again to make the selection.
2. In the **SEARCH TIME**, user may now select the date and time from where you want to begin the video playback.

Use the  and  buttons to move the selection to the left and right. Use the  and  buttons to select the date and time. Then press  or  again to make the selection.

3. To start video playback, the time in second must be set. Use the  buttons to move the selection to the right most. Use the  and  buttons and select the time in second. Then press  or .



EVENT LIST (search by event):

1. Use the  and  buttons to select from the list. Press  or  again to make the selection. User  and  to go next page or back to previous page.

Listed below are the following recording conditions:

A – Always Recording

It records non-stop and automatically continue recording when interrupted

S – Sensor Recording

It records when the sensor has triggered

M – Motion Recording

It records when any movement has detected

B – Button Recording

It records when the  record button is pressed

2. The “▶” play symbol would appear beside the channel number when you are previewing in playback mode.



	Event Type	Date	Start Time	End Time
S	2006 / 05 / 03	13 : 26 : 34	13 : 26 : 50	
A	2006 / 05 / 03	13 : 00 : 01	13 : 16 : 46	
A	2006 / 05 / 03	12 : 00 : 01	13 : 00 : 01	
B	2006 / 05 / 03	11 : 48 : 37	12 : 00 : 00	
A	2006 / 05 / 03	11 : 30 : 23	11 : 31 : 18	
A	2006 / 05 / 03	11 : 29 : 47	11 : 30 : 13	
B	2006 / 05 / 03	11 : 28 : 55	11 : 28 : 58	
S	2006 / 05 / 03	11 : 28 : 33	11 : 28 : 55	
A	2006 / 05 / 03	11 : 25 : 41	11 : 28 : 32	
A	2006 / 05 / 03	11 : 23 : 26	11 : 23 : 30	

Chapter 3 OSD Navigation Tree

The follow figure is an OSD menu tree map. To call out the OSD menu, press  on the remote control.

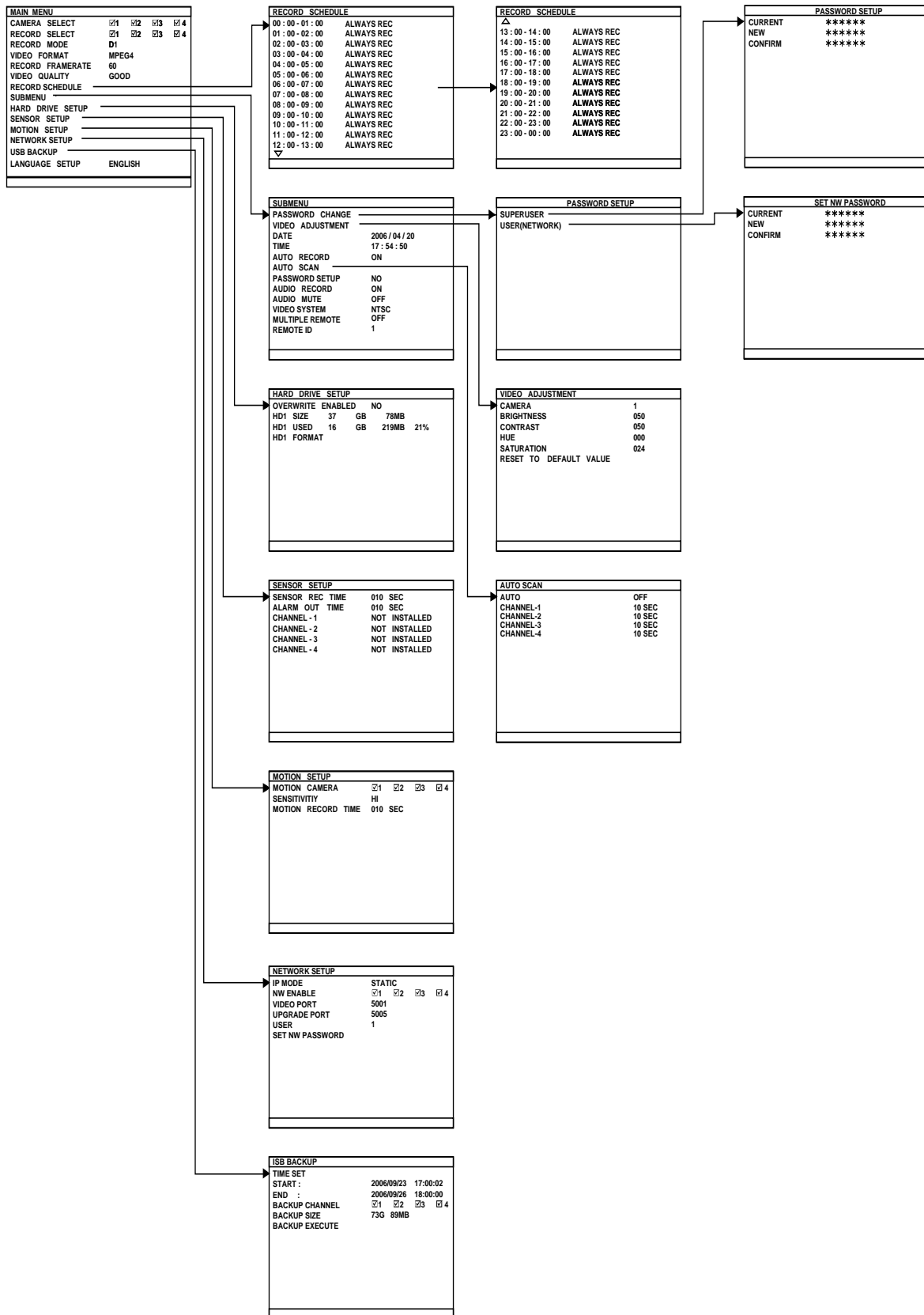

3.1 Menu Function

If the unit is currently recording the video, user may have to stop video recording to change the settings. Use remote control to navigate in the OSD menu. The red frame turns yellow when you are making a selection.

OSD MENU	Description
MAIN MENU	
CAMERA SELECT	CAMERA SELECT :
RECORD SELECT	Enable/disable the channel number to display the video on the surveillance screen
RECORD MODE	RECORD SELECT :
VIDEO FORMAT	Enable/disable the channel number to record video
RECORD FRAMERATE	
VIDEO QUALITY	
RECORD SCHEDULE	
SUBMENU	
HARD DRIVE SETUP	
SENSOR SETUP	
MOTION SETUP	
NETWORK SETUP	
USB BACKUP	
LANGUAGE SETUP	

i The channels which could be recorded should be enabled in the **CAMERA SELECT** first.

RECORD MODE :

Select D1/CIF recording mode

Under D1 mode, the video recording is in full screen resolution and takes turns from one channel to the next one when Auto Scan enables. Each channel is recorded only at a maximum frame rate of 15fps. User can switch to view the video in single full screen or QUAD screen

Whereas in CIF mode, video recording is at a lower resolution, but each video is recorded in 30fps/25fps (NTSC/PAL). User can switch to view the video in single full screen or QUAD screen

VIDEO FORMAT :

The recorded video is in MPEG4 format

RECORD FRAME RATE :

Set the number of frames per second to be recorded. Refer to the table below for the available record frame rate settings. The higher the frame rate is, it uses more hard disk space

Video Standard	NTSC	PAL
Record Mode		
D1	60, 20, 4	48, 20, 4
CIF	120, 60, 40, 20, 4	100, 48, 20, 4

VIDEO QUALITY :

Select the video quality setting from BEST, HIGH, MEDIUM, GOOD, NORMAL or LOW.

BEST – best record quality but less record hours

LOW – longest record hour but quality is ordinary



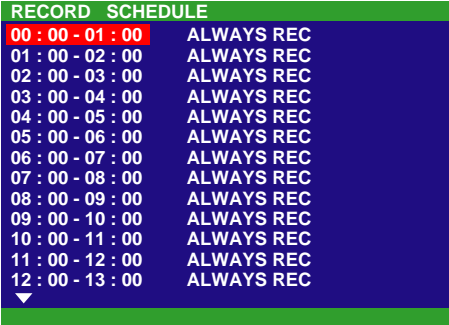

NORMAL – allows you to record more hours but the quality of the recorded video is moderate.

LANGUAGE SETUP :

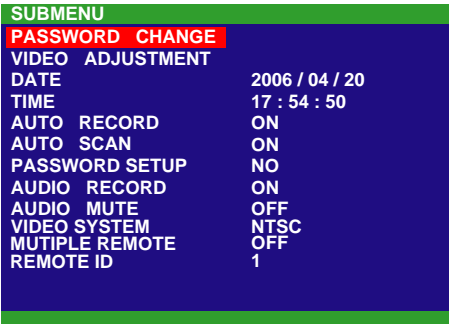
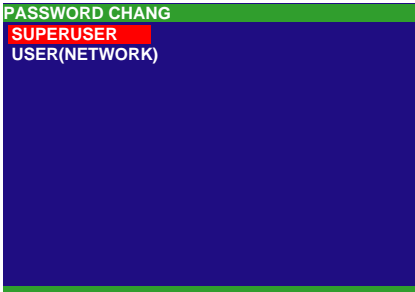
Select from the available languages

OSD MENU	Description												
	<p>RECORD SCHEDULE:</p> <p>By default, in 24 hours, the recording schedule is set to always record every hour. Refer to the table below to customize the recoding condition</p> <table border="1"> <thead> <tr> <th>Condition</th> <th>Description</th> </tr> </thead> <tbody> <tr> <td>NO REC</td> <td>Disable video recording</td> </tr> <tr> <td>ALWAYS REC</td> <td>Record non-stop</td> </tr> <tr> <td>MOTION REC</td> <td>Start recording when any movement is detected</td> </tr> <tr> <td>SENSOR REC</td> <td>Start recording when the sensor has triggered</td> </tr> <tr> <td>BUTTON REC</td> <td>Start recording when the record button is pressed</td> </tr> </tbody> </table>	Condition	Description	NO REC	Disable video recording	ALWAYS REC	Record non-stop	MOTION REC	Start recording when any movement is detected	SENSOR REC	Start recording when the sensor has triggered	BUTTON REC	Start recording when the record button is pressed
Condition	Description												
NO REC	Disable video recording												
ALWAYS REC	Record non-stop												
MOTION REC	Start recording when any movement is detected												
SENSOR REC	Start recording when the sensor has triggered												
BUTTON REC	Start recording when the record button is pressed												

	<p>PASSWORD CHANGE :</p> <p>Set a security combination number. There are two type of user password – SUPERUSER and USER.</p> 
--	---

Use the number button on the remote control to enter the password. Or use  and  button to select the security combination number. Press  or  button to confirm.

SUPERUSER:

Superuser has the authority of formatting hard disk, changing system settings, remote monitor the DVR system and changes the system settings. The factory default password is 111111.

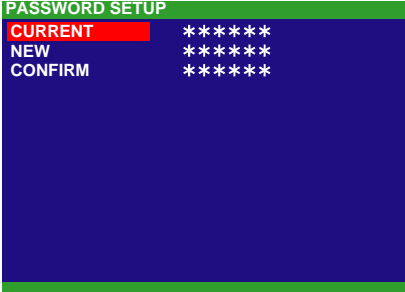

USER(NETWORK):

The login account for remote connection through the internet. User account only can view and playback recorded video by Web viewer (ex: Internet Explorer), but no authority to change the DVR system's setting. The factory default password is 111111.

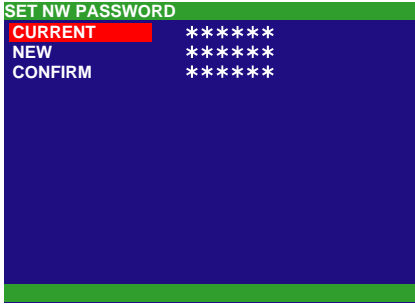
OSD MENU	Description
	 <p>SET NW PASSWORD CURRENT ***** NEW ***** CONFIRM *****</p>

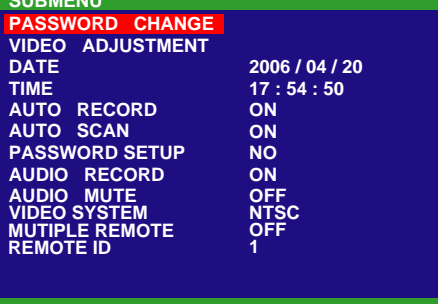
SUBMENU
 <p>PASSWORD CHANGE VIDEO ADJUSTMENT DATE 2006 / 04 / 20 TIME 17 : 54 : 50 AUTO RECORD ON AUTO SCAN ON PASSWORD SETUP NO AUDIO RECORD ON AUDIO MUTE OFF VIDEO SYSTEM NTSC MUTIPLE REMOTE OFF REMOTE ID 1</p>

VIDEO ADJUSTMENT :
Select the camera number and set to adjust the video brightness, contrast, hue, and saturation value

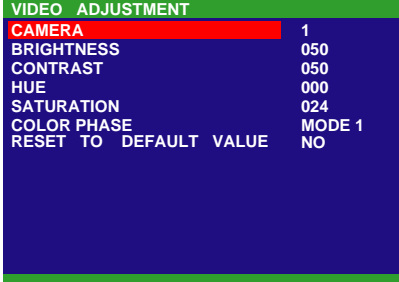
VIDEO ADJUSTMENT
 <p>CAMERA 1 BRIGHTNESS 050 CONTRAST 050 HUE 000 SATURATION 024 COLOR PHASE MODE 1 RESET TO DEFAULT VALUE NO</p>

DATE :
Set the current date

TIME :
Set the current time

AUTO RECORD :
Enable/disable auto continue recording when interrupted (i.e., power breakdown, video playback or configuration setup). It continue recording after 10 second of idleness. This is applicable in Always Record mode

AUTO SCAN :
Enable/disable auto cycle switch to display the next channel when in full screen preview. User can set different switch time for each channel. The time range is from 5 ~30 seconds.

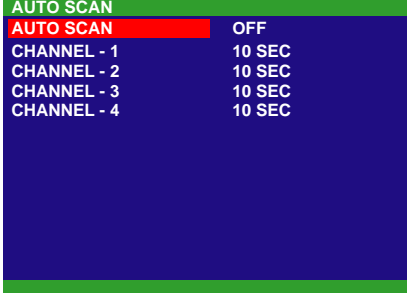
AUTO SCAN
 <p>AUTO SCAN OFF CHANNEL - 1 10 SEC CHANNEL - 2 10 SEC CHANNEL - 3 10 SEC CHANNEL - 4 10 SEC</p>

PASSWORD SETUP :
Enable/disable full system password protection. This would prevent unauthorized user to stop video recording, change system settings and formatting the hard disk

OSD MENU	Description
----------	-------------

AUDIO RECORD :

Enable/disable audio recording. To record sound, make sure the audio input device(ex: microphone) is connected to the unit

AUDIO MUTE :

Enable/disable to hear audio sound. To hear sound, make sure the unit is connected to an audio output device (ex: speaker). If user recorded video in audio mute status, there is no sound when playback



The audio input and output device must be powered by external power. The DVR system doesn't supply the power to those devices.

VIDEO SYSTEM:

DVR system will auto detect the video system and display

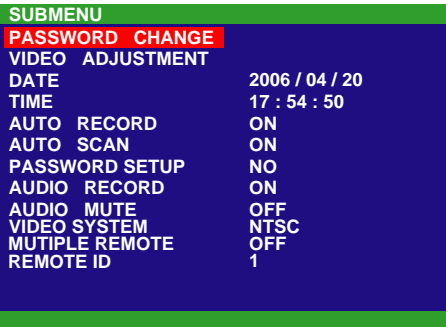

MULTIPLE REMOTE:

Enable/disable multiple DVR system remote control. When user has more than one DVR system, user can use **MULTIPLE REMOTE** function to control all DVR system by single remote control.

REMOTE ID:

Assign the ID number for multiple DVR system remote controls. When there are more than one DVR systems, user can enable **MULTIPLE REMOTE** function, and then assign **REMOTE ID** to each DVR system. Then, user can just use one remote control to control all DVR system by pressing **REMOTE ID**. To remote control multiple DVR systems, press  and number key (remote ID number) on the remote control.

OSD MENU	Description
----------	-------------

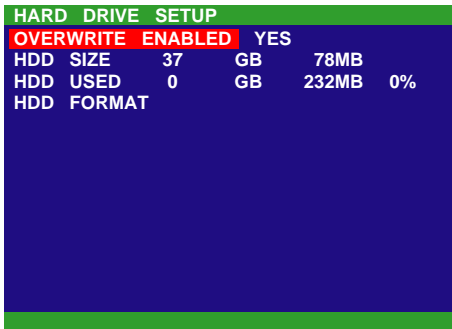

- * HDD SIZE shows the total capacity of the hard disk.
- * HDD USED shows the amount of space that has been used.

OVERWRITE ENABLED :

Enable/disable overwriting the earliest record when the hard disk space runs out. By default, the HDD overwrite setting is enabled

HDD FORMAT :

For security purpose, you may have to enter the password to format hard disk

To format hard disk:



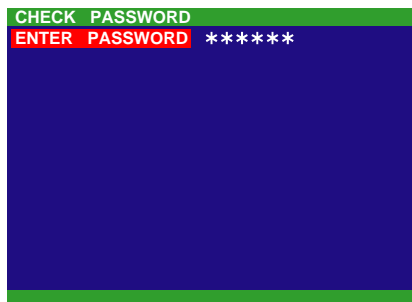



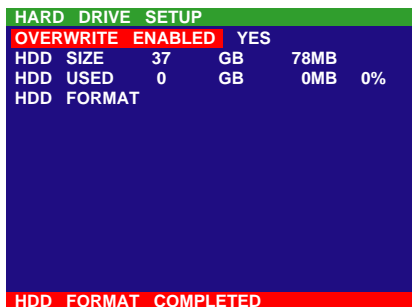





1. Use the and buttons to go up and down and select **HDD FORMAT**. Then press or .
2. In the **CHECK PASSWORD** screen, press or . Then use the and buttons to select the security combination number. Repeat till you key in the last number. Also, user can use the number button on the remote control to enter the password. Press or button again to make the selection. To move the selection to the left and right, use and buttons



3. After entering the last number, the system will format the hard disk
4. It is done when the “**HDD FORMAT COMPLETED**” appears





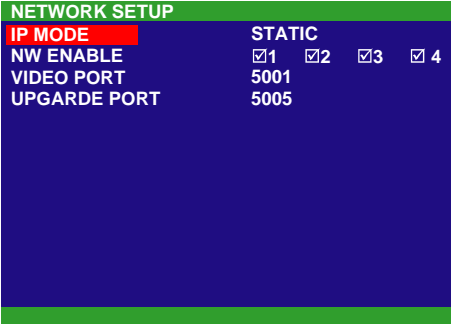

	Formatting the hard disk will permanently delete all the records and can no longer be retrieved
--	---

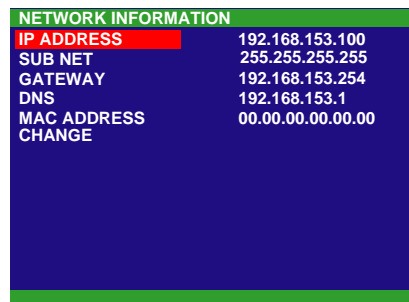
OSD MENU	Description								
<pre> SENSOR SETUP SENSOR REC TIME 010 SEC ALARM OUT TIME 010 SEC CHANNEL - 1 NOT INSTALLED CHANNEL - 2 NOT INSTALLED CHANNEL - 3 NOT INSTALLED CHANNEL - 4 NOT INSTALLED </pre>	<p>SENSOR REC TIME : Set the amount of time (in second) to start record when the sensor has triggered</p> <p>ALARM OUT TIME : Set the amount of time (in second) to continue sending the alarm once triggered</p> <p>CHANNEL 1~4 : Customize the initial state of the attached sensor. Refer to the table below to customize the sensor state</p> <table border="1" data-bbox="711 571 1362 835"> <thead> <tr> <th>Condition</th> <th>Description</th> </tr> </thead> <tbody> <tr> <td>NOT INSTALLED</td> <td>Indicates that there is no sensor connected</td> </tr> <tr> <td>NORMAL OPEN</td> <td>Indicates that the initial state of the sensor is normal open. Video recording initiates when there is a changes in the sensor state</td> </tr> <tr> <td>NORMAL CLOSE</td> <td>Indicates that the initial state of the sensor is normal close. Video recording initiates when there is a changes in the sensor state</td> </tr> </tbody> </table>	Condition	Description	NOT INSTALLED	Indicates that there is no sensor connected	NORMAL OPEN	Indicates that the initial state of the sensor is normal open. Video recording initiates when there is a changes in the sensor state	NORMAL CLOSE	Indicates that the initial state of the sensor is normal close. Video recording initiates when there is a changes in the sensor state
Condition	Description								
NOT INSTALLED	Indicates that there is no sensor connected								
NORMAL OPEN	Indicates that the initial state of the sensor is normal open. Video recording initiates when there is a changes in the sensor state								
NORMAL CLOSE	Indicates that the initial state of the sensor is normal close. Video recording initiates when there is a changes in the sensor state								
<pre> MOTION SETUP MOTION CAMERA <input checked="" type="checkbox"/>1 <input checked="" type="checkbox"/>2 <input checked="" type="checkbox"/>3 <input checked="" type="checkbox"/>4 SENSITIVITY L MOTION RECORD TIME 010 SEC </pre>	<p>MOTION CAMERA : Enable/disable the channel number to detect motion.</p> <p>SENSITIVITY : Set the sensitivity level. The sensitivity is from H (High), 9~ 2 and L (Low).</p> <p>MOTION RECORD TIME : Set the amount of time (in second) to record when motion is detected.</p>								
<pre> NETWORK SETUP IP MODE STATIC NW ENABLE <input checked="" type="checkbox"/>1 <input checked="" type="checkbox"/>2 <input checked="" type="checkbox"/>3 <input checked="" type="checkbox"/>4 VIDEO PORT 5001 UPGARDE PORT 5005 </pre>	<p>NETWORK SETUP: Setup the network parameters for the internet or intranet remote monitor or playback.</p> <p>IP MODE: The system provides 3 types of IP setup mode – Static, DHCP, and PPPOE. Use  and  buttons to go up and down and select IP MODE, and then press . Use  and  buttons to change the selections and press  or  to make a selection.</p> <ul style="list-style-type: none"> ■ STATIC: Assigns a constant IP address for the DVR system. Use  and  buttons to go up and down and select items, and then press  or  to make selection. Use  and  to move left and right to select or enter the configuration value. <ul style="list-style-type: none"> - IP ADDRESS: Assign a constant IP address which a real IP addresses give from ISP to DVR system. - SUBNET: It is a bitmask used to identify the sub network and how many bits provide room for 								

OSD MENU	Description
 <p>NETWORK SETUP</p> <p>IP MODE STATIC</p> <p>NW ENABLE <input checked="" type="checkbox"/>1 <input checked="" type="checkbox"/>2 <input checked="" type="checkbox"/>3 <input checked="" type="checkbox"/>4</p> <p>VIDEO PORT 5001</p> <p>UPGARDE PORT 5005</p>	<p>host addresses. Enter the subnet mask of the IP address which user has assigned to DVR system.</p> <ul style="list-style-type: none"> - GATEWAY: A network device act as a passageway to internet. Enter the network gateway IP address - DNS: Domain Name Server translates domain names (such as www.abb.com.tw) to IP addresses. Enter the IP address of DNS if it is available. - MAC ADDRESS: Only for user information. Don't need to enter the MAC address. - When all parameters are set, select the CHANGE to confirm the configuration.



- **DHCP:** Assign the IP address by local DHCP server to DVR system. Use  and  buttons to go up and down and select **DHCP**, and then press  or  to make selection.



The DHCP (Dynamic Host Configuration Protocol) is a set of rules used by a communications device (such as a computer, router or networking adaptor) to allow the device to request and get an Internet address from a server which has a list of addresses available for assignment

The DVR system will try to get an IP address from the DHCP server. A message window will show up as below:

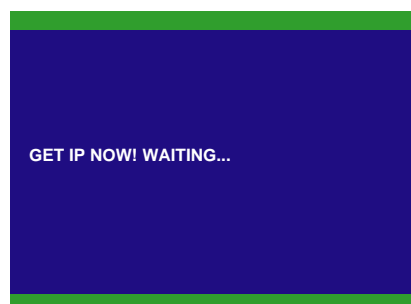

OSD MENU	Description
	<p>When DVR system gets an IP address from DHCP server, the information will display as below:</p>

- PPPOE:** Point-to-Point Protocol over Ethernet is a network protocol for encapsulating PPP frames in Ethernet frames. It is used mainly with ADSL services. If your network is using ADSL service connecting to internet, and then, select PPPOE mode. Use and buttons to go up and down and select **PPPOE**, and then press or to make selection. A message window will show up as below:

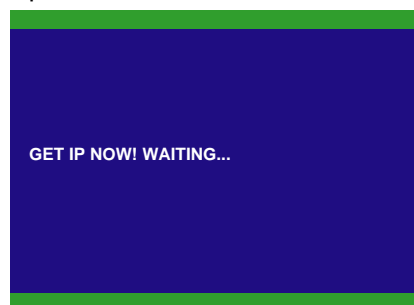

When DVR system get an IP address, the information will display as below:

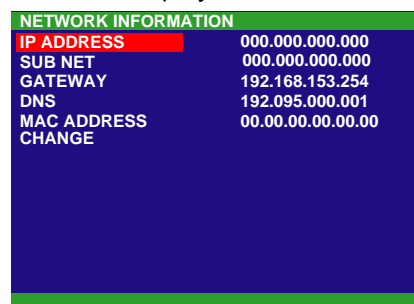

NW ENABLE:

Allow internet remote user to playback or monitor the channels. Without enabling the network function, the channels cannot be playback or monitor from remote site.

	<input type="checkbox"/> 1 is Channel 1	<input type="checkbox"/> 2 is Channel 2
	<input type="checkbox"/> 3 is Channel 3	<input type="checkbox"/> 4 is Channel 4

Use and buttons to go up and down and select **NW ENABLE** (network enable), and then press or and to move to the selection. Use and buttons to change the selections

OSD MENU	Description
----------	-------------

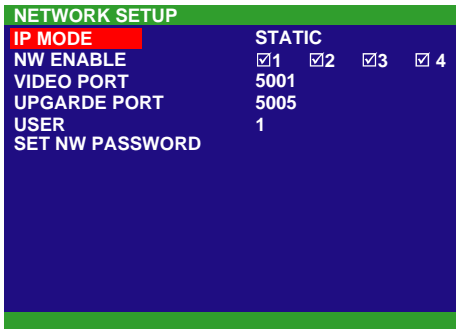

values and press or to confirm.

VIDEO PORT:

A port for the remote connection. Any port can be assigned as a video port, except the ports already used by the network services. The default video port is 5001.

Use and buttons to go up and down and select **VIDEO PORT**, and then press or and to move to the selection. Use and buttons to change the selections values and press or to confirm.

UPGRADE PORT:

A port for the remote update DVR system firmware. Any port can be assigned as an upgrade port, except the ports are already used by the network services. The default upgrade port is 5005. For Upgrading DVR firmware, please contact your local dealer.

	Please DO NOT cut off the power of the DVR system while the firmware is upgrading. Power failure will cause the permanent damage of the DVR system.
--	---

Use and buttons to go up and down and select **UPGRADE PORT**, and then press or and to move to the selection. Use and buttons to change the selections values and press or to confirm.

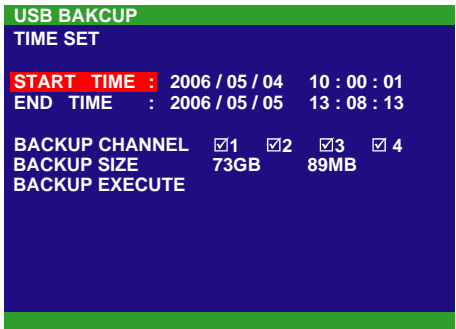



USB BACKUP:

Using USB device (ex. Pen drive or External Hard disk) to backup partial recorded video and playback on PC.

Use and buttons to go up and down and select **USB BACKUP**, and then press or . Use and to move left and right. And, use and buttons to change the value and press or to confirm.

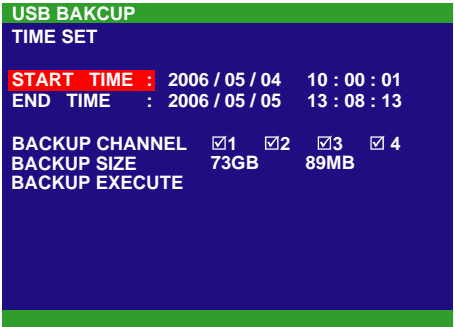
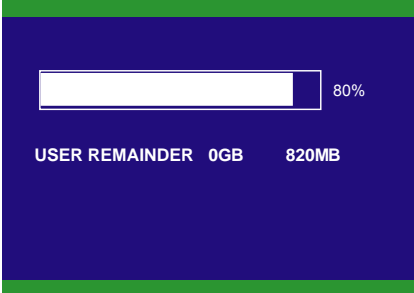
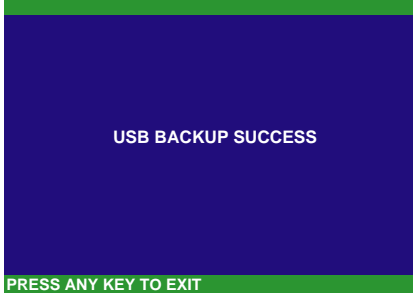
1. Select the **START TIME** and **END TIME**.
2. Select the channels which user wants to backup.
3. The DVR system will display the system hard disk space and backup file size.

OSD MENU	Description
 <pre> USB BAKCUP TIME SET START TIME : 2006 / 05 / 04 10 : 00 : 01 END TIME : 2006 / 05 / 05 13 : 08 : 13 BACKUP CHANNEL <input checked="" type="checkbox"/>1 <input checked="" type="checkbox"/>2 <input checked="" type="checkbox"/>3 <input checked="" type="checkbox"/>4 BACKUP SIZE 73GB 89MB BACKUP EXECUTE </pre>	<p>4. And then, select BACKUP EXECUTE to start backup video to the USB device.</p>
 <pre> [Progress Bar] 80% USER REMAINDER 0GB 820MB </pre>	<p>5. When backup is done, press any key to back to main menu.</p>
 <pre> USB BACKUP SUCCESS PRESS ANY KEY TO EXIT </pre>	<p>6. To view the backup file, using USB Playback Application(see 4.3)</p>
	<ul style="list-style-type: none"> - Remember to plug in the USB device before starting to backup. - The DVR system doesn't supply the power to external hard disk. Therefore, the external hard disk must be power supplied by self.

Chapter 4 Using the USB Playback Console

4.1 Recommended system requirements

- Pentium®4 2.4GHZ or above
- Windows®2000/ XP
- DDR 256 MB
- Graphic function must support DirectDraw
- Audio card or built-in
- Speaker
- 1 available USB2.0 port

4.2 Installing the USB Playback Console

To install the USB Playback Console:

1. Place Installation CD into the CD-ROM drive. When the installation main screen appears, click **Install USB Playback Console** and then follow the on screen instructions



2. Select the language you prefer



3. Click **OK** to install the application
4. Click **Exit** to close the installation main screen. You may plug in the pen drive or external hard disk now.

4.3 Running the USB Playback Console

To run the application, click the  icon on the PC desktop



Name	Function
------	----------

(1) Video playback screen

To select the video file for playing. The playback application supports *.dvr and *.avf file type.

(2) Open File



- **DVR Recorded File (HD):** To playback the recorded video from the hard disk which was recording video on the DVR system. (Also see [4.3.2](#))
- **Backup File(.dvr):** The file is backup and save in *.dvr file format. (Also see [4.3.3](#))
- **Backup File(.avf):** The file is backup and save in *.avf file format. The recorded video backup to pen drive is in *.avf.

Name**Function**

Select the event you want to playback. The event list only available when user select to playback in **DVR Recorded File(HD)**.

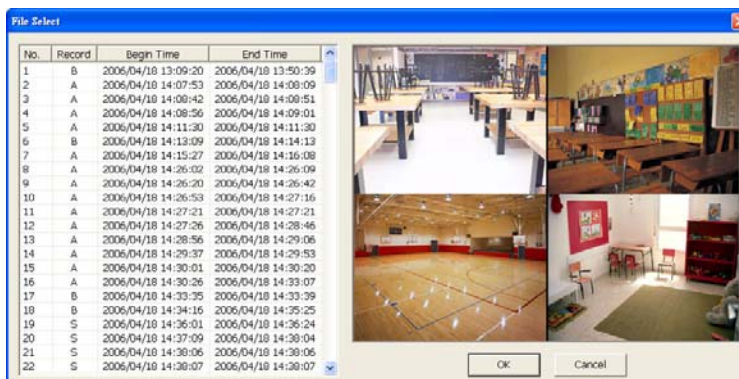
(3) Event List**(4) Full screen**

Use the entire area of the screen to only display the video. To return, press the right button of the mouse or **ESC** on the keyboard. When you switch to full screen in multiple-screen mode, Left click to toggle to only display one of the video in the multiple-screen mode or all.

(5) Segment

Keep a portion of the recorded video (see also [4.3.1](#))

(6) Output

Save the segmented file in *.mpg or *.avi format (see also [4.3.1](#)).

(7) Snapshot

Capture and save the image either in *.jpg or *.bmp format

(8) Print

Print the image

(9) HDD Backup

To call out HDD Backup application. (See Chapter 5)

(10) Video Enhancer

To call out Video Enhancer application. (See Chapter 6)

(11) Watermark

To call out ImageVerification application. (See Chapter 7)

(12) Status bar

Display the recorded date, time and play speed.

(13) Progress bar

Show the progress of the file being played. You may move the bar to seek at any location of the track.

(14) Playback Controller

Begin: Move at the beginning of the recorded video file.

Previous: Go back to the previous frame by frame.

Slower: Play the recorded video file at the speed of 1/2X, 1/4X, or 1/8X.

Rewind: Wind back the recorded video file.

Pause: Briefly stop playing the recorded video file.

Play: Play the recorded video file.

Faster: Play the recorded video file at the speed of 2x, 4x, or 8x.

Next: Go to the next frame by frame.

End: Go to the end of the recorded video file.

(15) Split Screen Mode

Select from different screen view to playback the recorded video file of the entire camera or one camera on screen.

Exit/ Minimize the application or chose Cancel to go back to the application

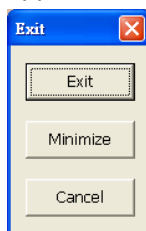
(16) Exit

Name	Function
(17) Sound /Sound bar	Turn on and off the sound Increase and decrease the volume

4.3.1 To Cut and Save the Portion of the Recorded Video

1. Use the Playback Control buttons or drag the bar on the playback progress bar and pause on where you want to start the cut. Then, click **Segment** to set the begin mark.



2. Use the Playback Control buttons or drag the bar on the playback progress bar and pause on where you want to end the cut. Then, click **Segment** to set the end mark. To cancel segmentation, click **Segment** button again.



3. Click **Output** button to save the wanted portion.
4. In the **Save As** dialog box, locate on where user wants to save the file, type the filename, and select the video format.

4.3.2 Playback DVR Recorded File from Hard Disk

1. Please have the hard disk which containing of recorded video data install on your PC or using external USB enclosure to connect to your PC.
2. Click **Open File** button
3. Select **DVR Recorded File(HD)** and click **OK**.
4. Select the hard disk drive from **Select Disk** window and click **OK**.

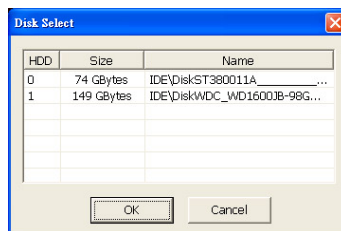

5. And then, the **Event List** window appears. Select the event that user wants to play and click **OK**.

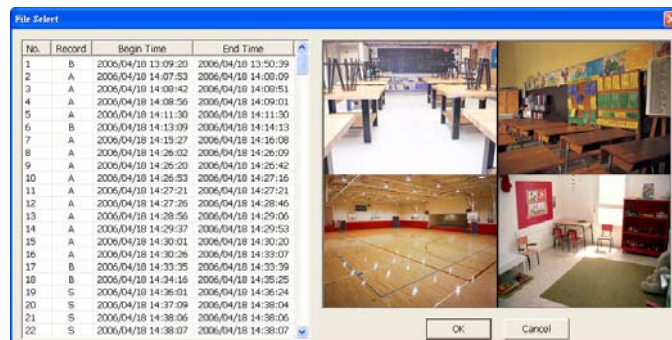

4.3.3 Playback Backup File(*.dvr)

1. Click Open File button.
2. Select **Backup File(*.dvr)** and click **OK**.
3. Locate the backup file folder and click **OK**.



When open the backup video file, just locate the where backup file folder is.

4. And then, Playback Date/Time Selection window appears. Select the date and time and click **OK**.

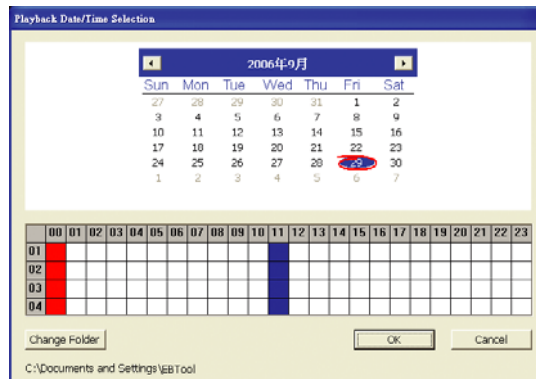

Chapter 5 Backup Recorded Video File

5.1 Recommended system requirements

- Pentium®4 2.4GHZ or above
- Windows®2000/ XP
- DDR 256 MB
- Graphic function must support DirectDraw
- Audio card or built-in
- Speaker
- 1 available USB2.0 port

5.2 Familiarizing with HDD Backup Application

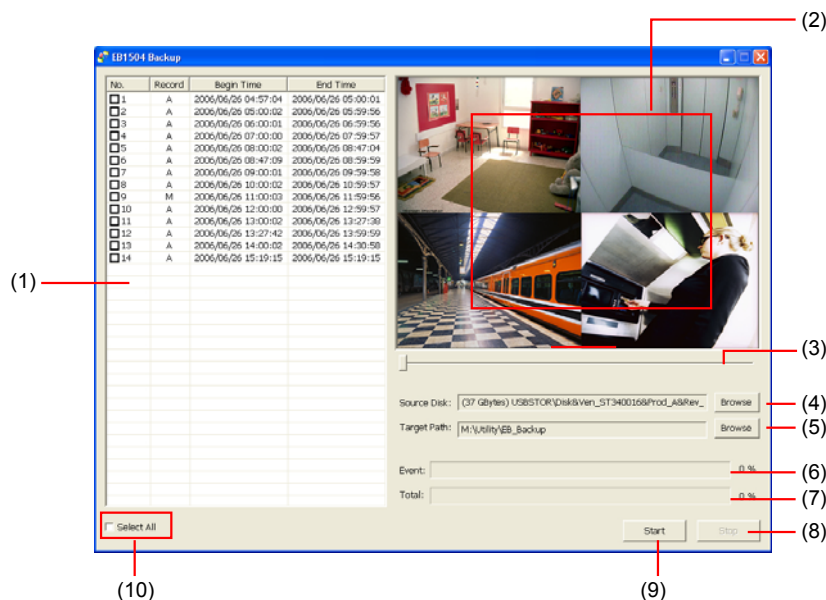

Name	Function
(1)	All recorded video events list No.: the list order number Record: the record type(see also Chapter 2.3.1) Begin Time: the beginning of record time End Time: the end of record time
(2)	Display first frame of each recorded channel video which user had selected.
(3) Progress bar	Show the progress of the event being played. User may move the bar to seek at any location of the track

Name	Function
------	----------

To select the hard disk drive

(4) Source Disk

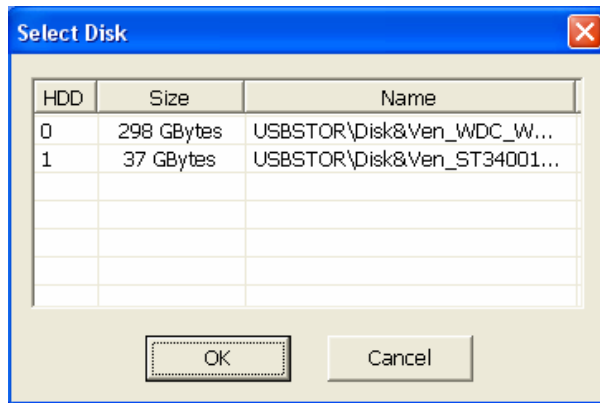

(5) Target Path	To locate on where user want to save the file
(6) Event (%)	Display the backup progress rate of event in percentage
(7) Total (%)	Display the total backup progress rate in percentage
(8) Stop	Stop backup progress
(9) Start	Start backup progress
(10) Select All	Select all listed recorded video events. Click the check box again to cancel for selecting all events.

5.3 To Backup Recorded Video File

1. Please have the hard disk which was recording video on the DVR system install on your PC or using external USB enclosure to connect to your PC.
2. To run the HDD Backup application, click the **HDD Backup** button on USB Playback Application main interface.
3. Click **Browse** in **Source Disk** to locate the recorded video file.
4. And then, the **Select Disk** windows will appear as below:

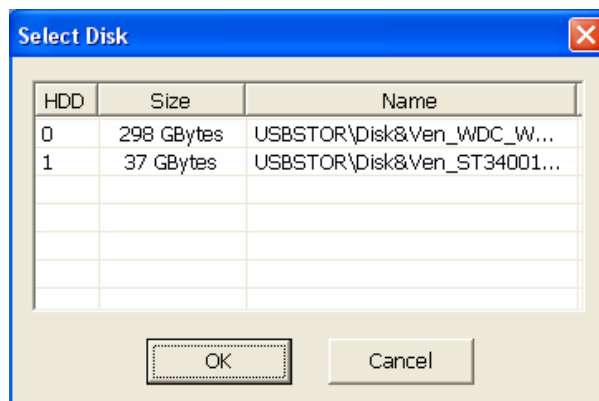

5. Select the hard disk drive from **Select Disk** windows. All available hard disk will list on the **Select Disk** windows with size and name

6. Select the hard disk drive and click **OK**
7. And then, all the recorded video files will list out.
8. Select the event which user wants to backup. Or mark the **Select All** to select all listed recorded video event
9. Locate on where user wants to save the backup file
10. Click **Start** to process backup
11. To stop the backup progress, click **Stop**
12. To play the backup file, see [4.3.3](#).

Chapter 6 ImageVerification

Image Verification is a watermark-checking program to identify the authenticity of a saved image (e.g. by snapshot). This program can only verify uncompressed bmp image files.

6.1 To Run the ImageVerification

1. To run the ImageVerification application, click the **Watermark** button on USB Playback Application main interface.
2. In the ImageVerification screen, click **Load Source Image** and locate the image source.
3. Click **Verify Image** to begin the process.
4. Check the result in the **Processed Image** screen. If the picture is unmodified, the image in the **Source Image** and **Processed Image** screen would be exactly the same. If the picture is being modified, a warning dialog box would prompt and the modified area is highlighted.

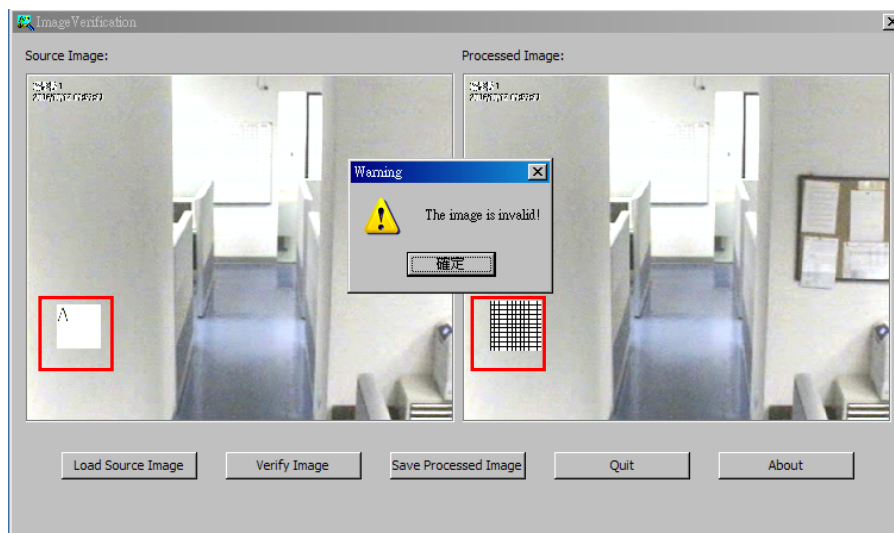

Chapter 7 Video Enhancer

The bundled Video Enhancer is a video editing tool and can only be used with *.dvr video file. It allows you to adjust the video picture quality, segment and save the wanted portion of the video, zoom in and out the image, and print or save the screen shot. You can also save the setting and apply it on other files.

To run the Video Enhancer application, click the **Video Enhancer** button on USB Playback Application main interface.

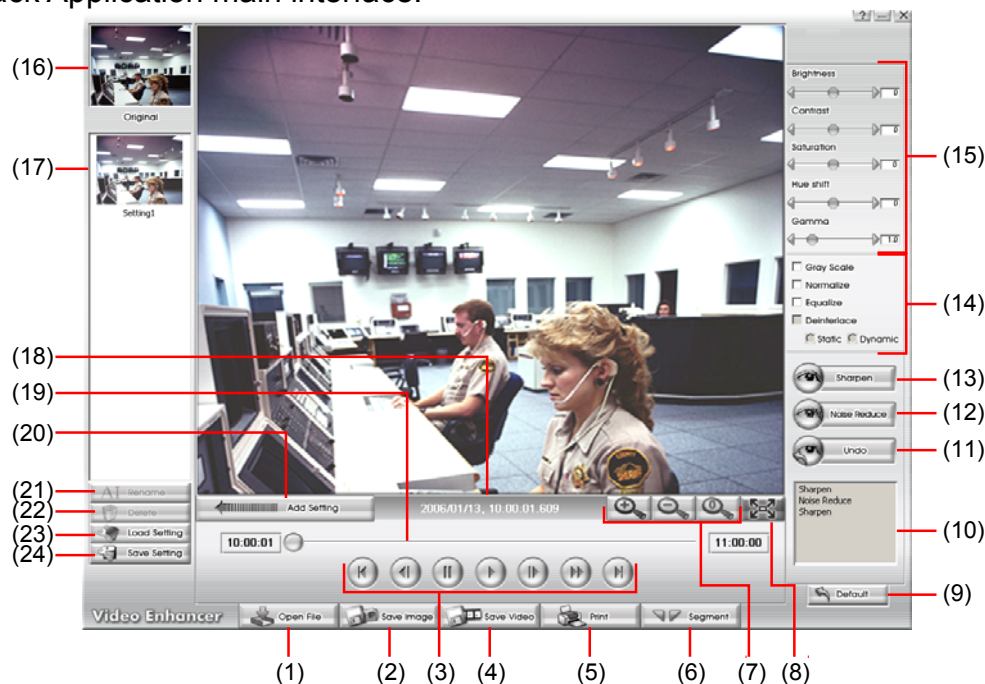

Name	Function
(1) Open File	Open *.dvr video file.
(2) Save Image	Capture and save the screen shot in *.bmp format.
(3) Playback Control Buttons	Begin: Move at the beginning of the video file. Previous: Go back to the previous frame Rewind: Wind back the video file. Pause: Briefly stop playing the video file. Play: Play the video file. Faster: Play the video file at the speed of 2x, 4x, or 8x. Next: Go to the next frame. End: Go to the end of the video file.
(4) Save Video	Save the edited or segmented video in *.avi format.
(5) Print	Print the screen shot.
(6) Segment	Mark the beginning and the end of the wanted portion of the video. Two triangle marks will appear on the slider. To cancel video segmentation, click this button again.
(7) Zoom Buttons	Enlarge, reduce, and set the image back to normal size.
(8) Full Screen	Use the entire screen to only display the video.

Name	Function
(9) Default	Set the video back to original state and delete all the changes in the history box.
(10) History Box	List all the actions.
(11) Undo	Delete the last action.
(12) Noise Reduce	Adjust the softness and repair the damaged colours.
(13) Sharpness	Improve the overall image by enhancing edges. This gives the image more depth.
(14) Effects	Gray Scale: convert the image into black and white (monochrome). Normalize: adjust the brightness intensity. Equalize: automatically adjust the images that are too dark. De-interlace: smooth out the overlying frames. Static: de-interlace for motionless scene. Dynamic: de-interlace for moving scene.
(15) Picture Adjustment	Adjust the Brightness, Contrast, Saturation, Hue and Gamma.
(16) Original Screen	Display the original state of the image.
(17) Temporary Setting Block	Display the sample settings. Click the sample to apply the setting on the current video.
(18) Status Bar	Display the date, and time of the video.
(19) Progress Bar	Show the progress of the file being played. You may move the bar to seek at any location of the track.
(20) Add Setting	Include the new setting to the temporary setting block.
(21) Rename	Change the name of the selected setting in the temporary setting block.
(22) Delete	Permanently remove the selected setting in the temporary setting block.
(23) Load Setting	Call the saved settings.
(24) Save Setting	Store the settings in the temporary setting block.

Chapter 8 Using the Remote Programs

User can use Microsoft Internet Explorer to access DVR system by entering the IP address. To use this feature, make sure that you PC and EB 1304 NET both are connected to the internet and the Network feature is enabled.

Accessing this feature for the first time you will be prompted by your browser to install WebCamX.cab, allow the installation and you should be able to connect and login afterwards.

For Windows 2000, click **Yes** when the Security Warning dialog box appears.

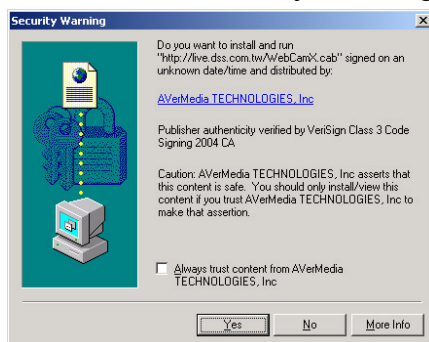

For Windows XP, click Install when the Internet Explorer - Security Warning dialog box appears.

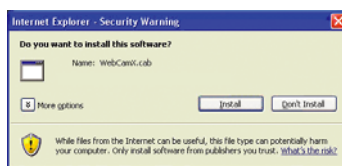

After installing the WebCamX.cab and when connecting to the DVR system, you are required to enter User ID (Superuser or User) and password (default password is 111111)and select the type of network. Superuser has the authority to remote setup the DVR system configuration on Web Viewer.



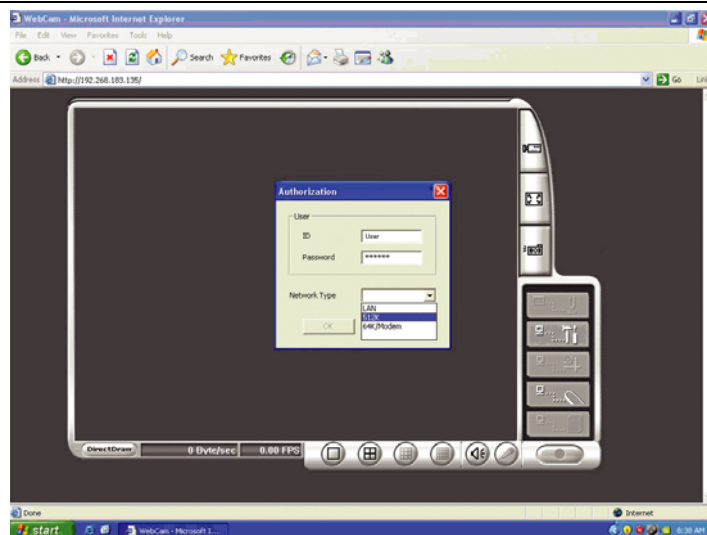

Changing the Superuser and User default password is strongly recommended.

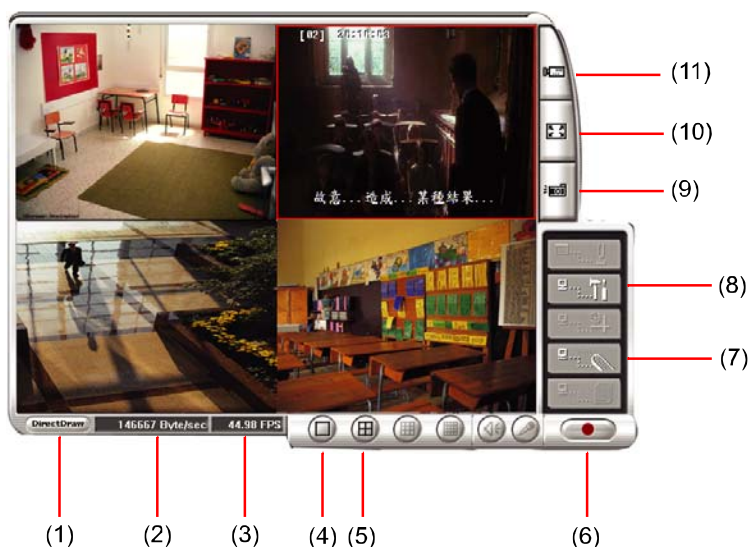

8.1 Familiarizing the Web Viewer Buttons

Right-clicking on the Web Viewer video screen, enables you to start video recording, change video quality, switch camera and enable/disable DirectDraw.



Name	Function
(1) DirectDraw	Enhance the video quality.
 Not all graphic cards can support this function. If you can not see the screen display correctly or screen is messed, please check with VGA card vendor.	
(2) Received file size	Indicate the size of the data being sent per second.
(3) Camera frames	Indicate the number of frames per second.
(4) One screen view	To view single camera view on screen. User can right click on the screen to switch to different camera view.
(5) Split screen view	To view 4 camera on screen simultaneously.
(6) Record	Start to record the video of the selected camera in AVI format. Directly click screen to select the channel that user wants to record and press Record button.
(7) Remote Console	Initiate Remote Console. It allows you to control DVR server (see also Chapter 8.2).
(8) Remote setup	Change the DVR server settings (see also Chapter 8.1.1).
 Only Superuser has the authority to remote setup DVR system.	
(9) Snapshot	Capture and save the screen shot in *.bmp format.
(10) Full screen	Use the entire area of the screen to only display the video. To return, Right click the mouse or press ESC on the keyboard.



Name	Function
(11) Select cameras to view	<p>Select to the view camera from different server. In Select Camera dialog box, Display column, click to enable/disable viewing the camera.</p> <p>Click Add Server and select the server type between DVR and IP Cam to add.</p> <p>Click Delete Server to delete the selected item.</p> <p>Click Import to load the previous saved list.</p> <p>Click Export to save the list.</p> <p>Click Apply All to change all the camera video quality based on the selected setting.</p> <p>Click OK to exit.</p>

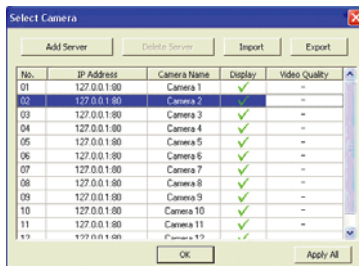

8.1.1 To Setup Remote System Setting

Click **OK** to exit and save the setting and **Cancel** to exit without saving the setting. The setting here applies to Remote DVR only.



After changed the DVR system setting, refresh your web browser in order to apply the new setting to the DVR system.

8.1.1.1 Camera Setup

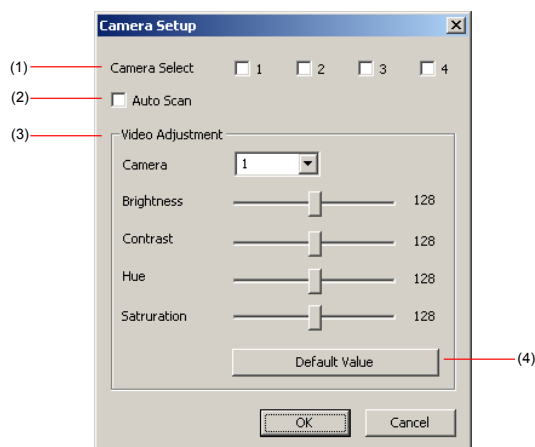

(1) Camera Select:

Enable/disable the channel number to display the video on the surveillance screen

(2) Auto Scan

Enable/disable auto cycle switch to display the next channel when in full screen preview.

(3) Video Adjustment

Select the camera and adjust the Brightness, Contrast, Hue and Saturation of the selected camera.

(4) Default Value

Set the video value back to default

8.1.1.2 Record Setup

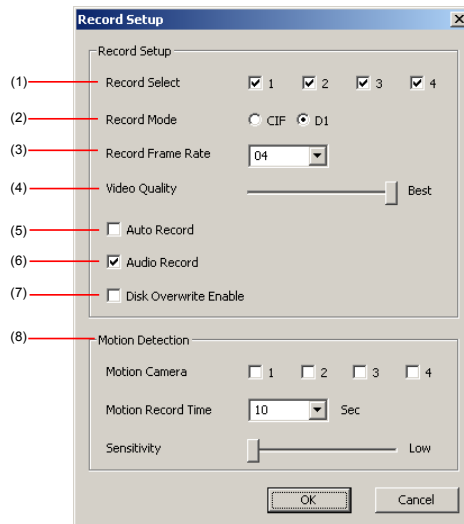

(1) Record Select

Enable/disable the channel number to record video



The channels which could be recorded should be enabled in the CAMERA SELECT first.

(2) Record Mode

Select D1/CIF recording mode. Under D1 mode, the video recording is in full screen resolution. Each channel is recorded at a maximum frame rate of 15fps. You can switch to view the video in single full screen or 4 split screen. Whereas in CIF mode, video recording is at a lower resolution, but each video is recorded in 30fps/25fps (NTSC/PAL).

(3) Record Frame Rate

Set the number of frames per second to be recorded. Refer to the table below for the available record frame rate settings. The higher the frame rate is, it uses more hard disk space

Video Standard \ Record Mode	NTSC	PAL
D1	60, 20, 4	48, 20, 4
CIF	120, 60, 40, 20, 4	100, 48, 20, 4

(4) Video Quality

Select the video quality setting from BEST, HIGH, MEDIUM, GOOD, NORMAL

or LOW.

(5) Auto Record

Enable/disable auto continue recording when interrupted (i.e., power breakdown, video playback or configuration setup). It continue recording after 10 second of idleness. This is applicable in Always Record mode under schedule setting.

(6) Audio Record

Enable/disable audio recording. To record sound, make sure the microphone is connected to the unit

(7) Disk Overwrite Enable

Enable/disable replacing the earliest record when the hard disk space runs out. By default, the HDD overwrite setting is enabled

(8) Motion Detection

- Motion Camera

Enable/disable the channel number to detect motion.

- Motion Record Time

Set the amount of time (in second) to record when a motion has detected.

- Sensitivity

Set the sensitivity level. The sensitivity is from high, 9~ 2 and low.

8.1.1.3 Alarm/Sensor Setup

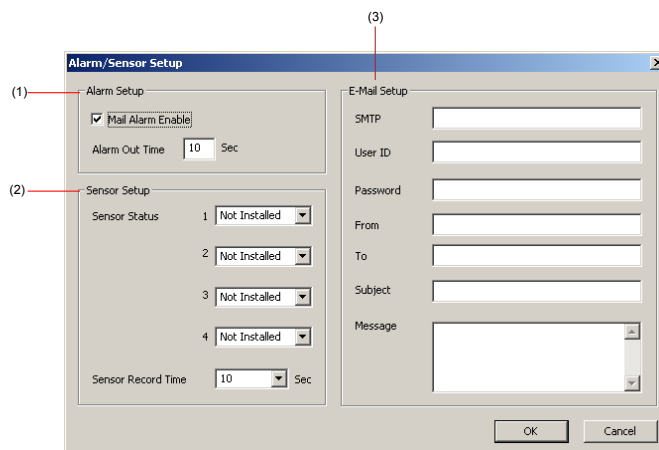

(1) Alarm Setup

- Mail Alarm Enable

Enable/disable alarm sending mail when alarm has triggered or motion has detected.



The Motion Detection must be enabled first, the alarm sending mail will send out the mail when detect motion.

- **Alarm Out Time**

Set the amount of time (in second) to continue sending the alarm once activated

(2) Sensor Setup

- **Sensor Status**

Customize the initial state of the attached sensor for every camera. Refer to the table below to customize the sensor state.

Not installed: Indicates that there is no sensor connected

Normal open: Indicates that the initial state of the sensor is normal open.

Video recording initiate when there is a changes in the sensor state

Normal close: Indicates that the initial state of the sensor is normal close.

Video recording initiate when there is a changes in the sensor state

- **Sensor Record Time**

Set the amount of time (in second) to record after the sensor has been triggered

(3) E-Mail Setup

- **SMTP**

Enter the SMTP server

- **User ID & Password**

Enter User ID and Password for e-mail server user identification

- **From**

Enter the sender e-mail address

- **To**

The recipient e-mail address and separate it with a semicolon

- **Subject**

Enter the message title

- **Message**

Type the message

8.1.1.4 Network Setup

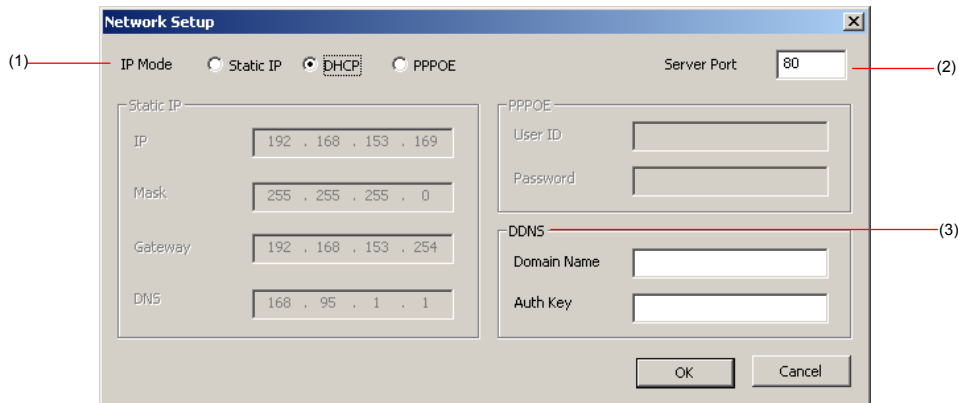

(1) IP Mode

- Static IP

Assign a fixed and global IP address for the DVR system

IP: Assign a constant IP address which real IP addresses give from ISP.

Mask: Enter the subnet mask of the IP address which user has assigned to DVR system.



It is a bitmask used to tell how many bits in an octet(s) identify the subnetwork, and how many bits provide room for host addresses.

Gateway: Enter the network gateway IP address

DNS: Domain Name Server translates domain names (such as www.abb.com.tw) to IP addresses. It will translate the domain name into IP address when DVR system request.

- DHCP

Assign the IP address by local DHCP server to DVR system.



The Dynamic Host Configuration Protocol (DHCP) is a set of rules used by a communications device (such as a computer, router or networking adaptor) to allow the device to request and get an Internet address from a server which has a list of addresses available for assignment.

- PPPOE

Point-to-Point Protocol over Ethernet is a network protocol for encapsulating PPP frames in Ethernet frames. It is used mainly with ADSL services.

(2) Server Port

A port is using for the remote connection. Any port can be assigned as a server port, except the ports already used by the network services.

(3) DDNS

DDNS (Dynamic Domain Name Service) is a data query service mainly used on the Internet for translating domain names into Internet addresses. Users can register their own domain name on <http://www.ddns.avers.com.tw>. (See

[Appendix A\)](#)

- **Domain Name**

Enter the domain name that user wanted.

- **Auth Key**

A password use to access DDNS to register the domain name. MAC address of the DVR system is the key for user to register the domain name on AVerMedia DDNS web site. To find MAC address of your DVR system, follow the steps below:

1. In OSD menu, select **NETWORK SETUP**
2. Select any one of IP mode
3. A **NETWORK INFORMATION** windows will show up
4. MAC address of DVR system is display as shown

8.1.1.5 Password Change

Click **Remote setup** button on Web Viewer main interface, and then, click **User** button to call out the **Password Change** interface.

The screenshot shows a 'Password Change' dialog box with two sections. The first section, labeled '(1) SuperUser', contains a 'Password' field and a 'Password Confirm' field. The second section, labeled '(2) User', also contains a 'Password' field and a 'Password Confirm' field. At the bottom of the dialog are 'OK' and 'Cancel' buttons.

(1) Superuser

Change the remote accessing password of super user. Superuser has the authority to remote setup the DVR system configuration on Web Viewer.

- **Password**

Enter the new password

- **Password Confirm**

Re-enter password to confirm

(2) User

Change the remote accessing password of user

- **Password**

Enter the new password

- **Password Confirm**

Re-enter password to confirm

8.2 Familiarizing the Remote Console Buttons



Name	Function
(1) Exit	Close the Remote Console.
(2) Audio button	Enable/disable the sound.
(3) Split Screen Mode	Select from six (6) different split screen type to playback the recorded video file of all the camera, or one camera over the other or alongside on a single screen.
i	<ul style="list-style-type: none"> - If there are only 4 cameras, you won't be able to switch to 9, 16, and 13 split screen mode. - To change the video quality, right-click on the screen and select between High, Normal or Low.
(4) Record	Start/stop video recording.
(5) Network	Enable/disable remote system access. This feature allows you to access EB DVR server from a remote location via internet connection.
(6) Setup	Configure the Remote Console setting. (see also Chapter 8.2.1)
(7) Preview	Switch to Preview/Playback mode. This allows you to view live camera display.
(8) Playback	Switch to Playback mode. This allows you to view the recorded video file. (see Chapter 8.3)
(9) Status Bar	Display the current date, time and hard disk free space.
(10) Camera ID	Show the number of cameras that are being viewed. When you are in single screen mode, click the camera ID number to switch and view other camera.
(11) Snapshot	Capture and save the screen shot either in *.jpg or *.bmp format.
(12) Full screen	Use the entire area of the screen to only display the video. To return, Right click the mouse or press ESC on the keyboard.
(13) DirectDraw	Enable/disable DirectDraw function
i	Direct Draw function supports for certain VGA card. For more information, please contact your VGA card vendor.

8.2.1 To Setup Remote Console Setting

Click **Setup** button to call out the **System Setting** windows. Click **OK** to exit and save the setting and **Cancel** to exit without saving the setting.

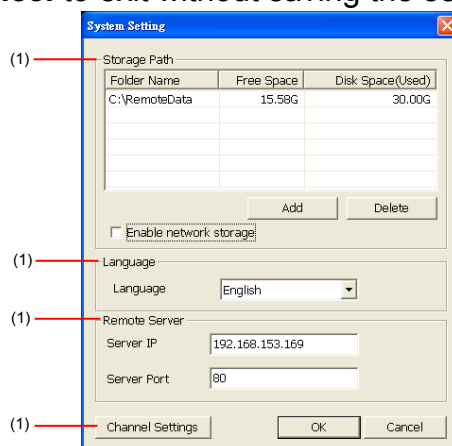

(1) Storage Path

Set the directory on where to save the data. When there is not enough free space to record one hour data, the system automatically replaces the oldest data. In case you have more than one storage path, the system automatically saves the data to the next storage path. By default the data is stored in C:\RemoteData, to insert another storage path, click **Add**. To remove the selected path, click **Delete**.

- **Enable** network storage

Select the Enable network storage check box to send the recorded video in network-attached storage.



To add network storage, the Internet storage drive/folder must be mapped as Network Driver in DVR server. To know how to assign or connect to a network drive, please refer to your Windows help file and search "Map Network drive".

(2) Language

Customize the system to display the tool tips and dialogs based on the selected language. By default the language is in English.

(3) Remote Server

Enter the DVR Server IP and Server Port number.

(4) Channel Settings

The numbers from 1 to 4 represent the camera ID. In Transmitting Channels section, enable the camera number to receive the camera signal from the server. In Visible Channels section, enable the camera number to view the camera signal on Remote Console screen. To select all the cameras, enable the **ALL** check box.

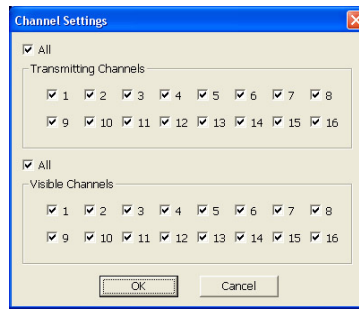

8.3 Using the Remote Playback

To use this feature, first you need to select the source of the file. Click the **Playback** button. And then, in the Select Playback Mode dialog box, choose **Local Playback** to open the file that is recorded in the Remote Console, and **Remote Playback** to open the file that is recorded in the DVR server. When you choose Remote Playback, select **Download and Playback**.



Click **OK** to proceed and **Cancel** to void this operation.

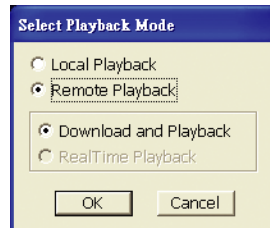

In the Video Playback Date/Time Selection, the number from 00 to 23 represent the time in 24-hour clock. The numbers from 01 to 16 represent the camera number.

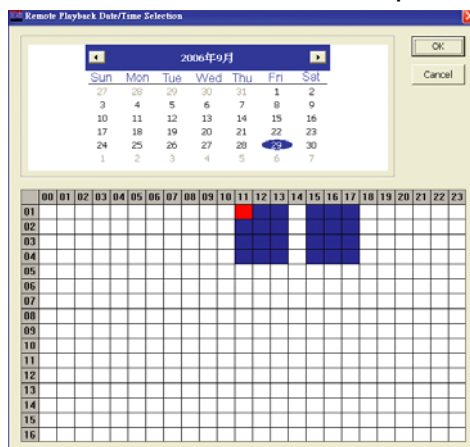

To Make a Selection:

1. Select the date in the calendar. Use ◀ and ▶ buttons to shift the calendar to the left or right.
2. In the table below, click on the blue block to select and open the recorded file. The blue block turns red when it is selected. The block that appears in white doesn't have data. You can only select one block when you choose Download and Playback.
3. Click **OK** to proceed and **Cancel** to void this operation.
4. If you select Download Playback and after making the selection, the system divides the selected hour into 16 video thumbnails. In the Time Selection screen, click on the video thumbnail you want to download (see also [Chapter 8.3.2](#)).



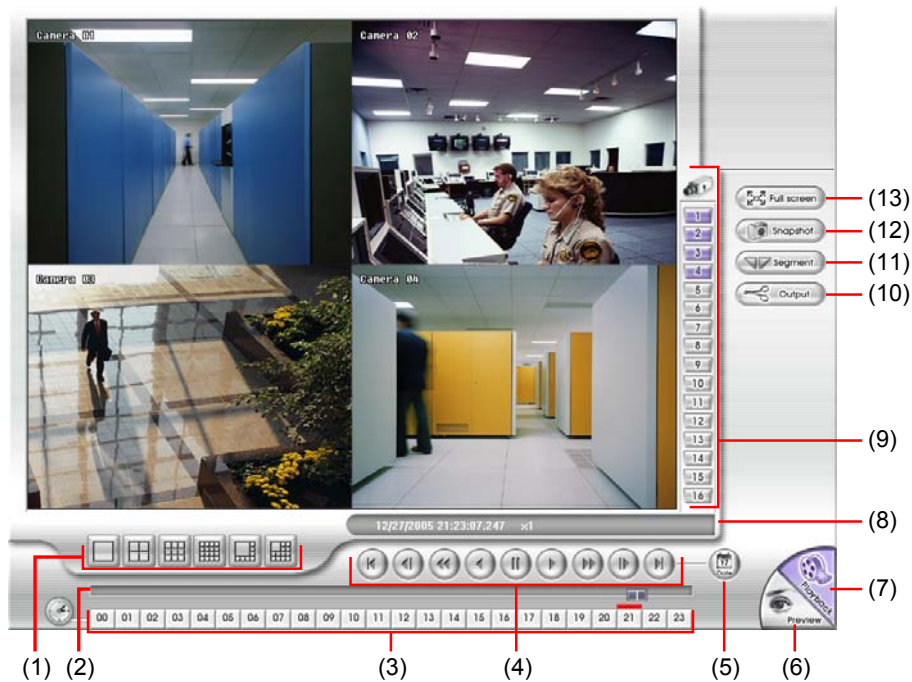

8.3.1 Familiarizing the Local Playback Buttons



Name	Function
(1) Split Screen Mode	Select from six (6) different split screen type to playback the recorded video file of all the camera, or one camera over the other or alongside on a single screen.
(2) Progress bar	Show the progress of the file being played. You may move the bar to seek at any location of the track.



- If there are only 4 cameras, you won't be able to switch to 9, 16, and 13 split screen mode.
- To zoom in an area on the screen, Right click and Drag a square on the area you want to enlarge. To back to normal view, right click the channel screen again.

Name	Function
(3) Hour Buttons	Select and click to playback the recorded video file on the specific time frame.
 <p data-bbox="370 295 1364 443">The Hour buttons represent the time in 24-hour clock. The blue bar on top of the hour button indicates that there is a recorded video file on that period of time. If there is no recorded data within the hour, there will be no color bar on top of the hour button. While the red bar indicates that you are currently viewing the recorded video file.</p>	
(4) Playback Control Buttons	<p data-bbox="545 497 1364 533">Begin: Move at the beginning of the recorded video file.</p> <p data-bbox="545 542 1364 577">Previous: Go back to the previous frame.</p> <p data-bbox="545 586 1364 622">Slower: Play the recorded video file at the speed of ½x, ¼x, or ⅓x.</p> <p data-bbox="545 631 1364 667">Rewind: Wind back the video file.</p> <p data-bbox="545 676 1364 712">Pause: Briefly stop playing the recorded video file.</p> <p data-bbox="545 721 1364 757">Play: Play the recorded video file.</p> <p data-bbox="545 766 1364 801">Faster: Play the recorded video file at the speed of 2x, 4x, or 8x.</p> <p data-bbox="545 810 1364 846">Next: Go to the next frame.</p> <p data-bbox="545 855 1364 891">End: Go to the end of the video file.</p>
(5) Date	Select the date on the calendar and the time from 00 to 23 to where to start playing the recorded video file.
 <p data-bbox="370 967 1364 1102">The numbers from 00 to 23 represent the time in 24-hour clock. The numbers from 01 to 16 represent the camera ID. While the red colored column indicates on where to start playing the recorded video file. If there is no any video data, it will be no color bar on top of the date button.</p>	
(6) Preview	Switch to Preview/Playback mode.
(7) Playback	Switch to Playback mode. This allows you to view the recorded video file.
(8) Status bar	Display the record date, time, HDD capacity in preview mode and play speed in playback mode.
(9) Camera ID	Show the number of cameras that are being viewed. When you are in single screen mode, click the camera ID number to switch and view other camera.
(10) Output	Save the segmented file in *.mpg, *.avi, or *.dvr format (see also Chapter 4.8).
(11) Segment	Keep a portion of the recorded video you want (see also Chapter 4.8).
(12) Snapshot	Capture and save the screen shot either in *.jpg or *.bmp format.
(13) Full screen	View in Playback-compact mode. To return, press the right button of the mouse or ESC on the keyboard.

8.3.2 Familiarizing the Download and Playback Buttons

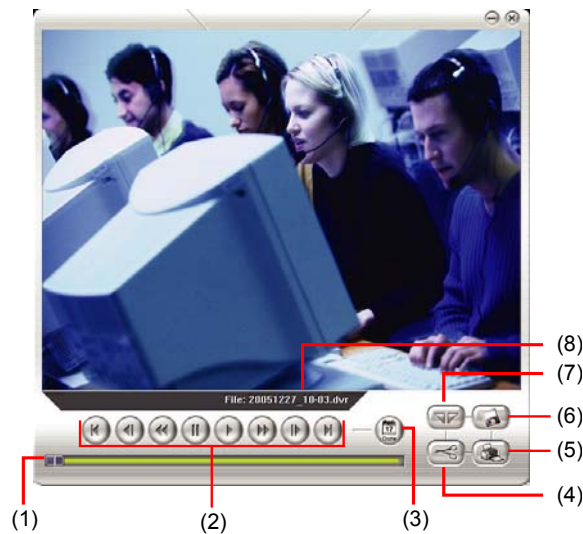

Name	Function
(1) Progress bar	Show the progress of the file being played. You may move the bar to seek at any location of the track.
(2) Playback Control Buttons	<p>Begin: Move at the beginning of the video file.</p> <p>Previous: Go back to the previous frame.</p> <p>Slower: Play the recorded video file at the speed of 1/2x, 1/4x, or 1/8x.</p> <p>Rewind: Wind back the video file.</p> <p>Pause: Briefly stop playing the recorded video file.</p> <p>Play: Play the recorded video file.</p> <p>Faster: Play the recorded video file at the speed of 2x, 4x, or 8x.</p> <p>Next: Go to the next frame.</p> <p>End: Go to the end of the video file.</p>
(3) Date	Open other file.
(4) Output	Save the segmented file in *.mpg, or *.avi, format.
(5) Print	Print the screen shot.
(6) Save	Save the screen shot either in *.jpg or *.bmp format and video in *.dvr format.
(7) Segment	Keep a portion of the recorded video you want. You may follow the instruction in Chapter 4.8.

Appendix A Registering Domain Names

DDNS (Dynamic Domain Name Service) is a data query service mainly used on the Internet for translating domain names into Internet addresses. It allows remote clients to intelligently search dynamic servers without any previous enquiring for servers' Internet addresses.

In order to take advantage of this intelligent service, first register your domain name on the following Web site <http://ddns.avers.com.tw>

1. User Login

Browse the website ddns.avers.com.tw with Microsoft IE or Netscape Navigator to access the following dialog.

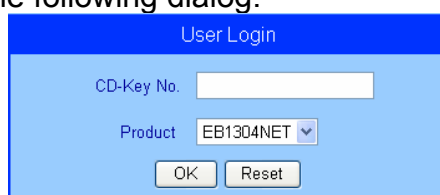

The 'User Login' dialog box has a blue header. It contains a text input field for 'CD-Key No.', a dropdown menu for 'Product' with 'EB1304NET' selected, and two buttons: 'OK' and 'Reset'.

First input the MAC address of your DVR system and select the product name. Then click **OK** to login or **Reset** to clear the previous input.

2. Password

Set a password to secure your identification.



The 'Input your password' dialog box has a blue header. It contains a password input field with a masked character and two buttons: 'OK' and 'Reset'.

3. User Information

Please provide the following user information, **Host Name**(user can choose any name he/she likes except the one violence with other users), **Password**, **E-mail**, **Company**, and **Country** to complete the registration process.

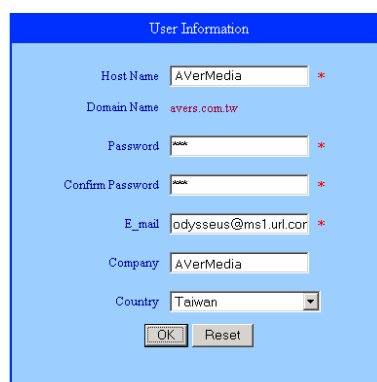

The 'User Information' dialog box has a blue header. It contains several fields: 'Host Name' (AVerMedia), 'Domain Name' (avers.com.tw), 'Password' (masked), 'Confirm Password' (masked), 'E_mail' (odysseus@ms1.url.cor), 'Company' (AVerMedia), and 'Country' (Taiwan). There are 'OK' and 'Reset' buttons at the bottom.

Warranty Notice

LIMITED WARRANTY

AVerMedia TECHNOLOGIES, Inc. warrants this product to be free of defects resulting from faulty manufacture or components under the following terms:

WARRANTY LENGTH

Labor is warranted for (1) one year from the date of purchase

Parts are warranted for (1) one year from the date of purchase

Replacement products will be warranted for the remainder of the one year warranty period or (30) thirty days, whichever is longer

WHO IS PROTECTED

This warranty is enforceable only by the first consumer purchaser

WHAT IS AND IS NOT COVERED

Except as specified below, this warranty covers all defects resulting from faulty manufacturing of this product. The following are not covered by the warranty.

1. Any product on which the serial number has been defaced, modified, or removed
2. Damage, deterioration, or malfunction resulting from:
 - Accident, abuse, misuse, neglect, fire, water, lightning, or other acts of nature, commercial or industrial use, unauthorized product modification, or failure to follow instructions included with the product.
 - Misapplication of service by someone other than the manufacturer's representative
 - Any shipment damages (Claims must be made with carrier)
 - Any other cause which does not relate to a product defect
3. Cartons, cases, batteries, cabinets, tapes, or accessories used with product
4. AVerMedia does not warrant that this product will meet your requirements; it is your responsibility to determine the suitability of this product for your purpose

WHAT WE WILL AND WILL NOT PAY FOR

We will pay labor and material expenses for covered items. However, we will not pay for the following:

1. Removal or installation charges
2. Shipping charges
3. Any incidental charges

EXCLUSION OF DAMAGES

THE MANUFACTURER'S SOLE OBLIGATION AND LIABILITY UNDER THIS WARRANTY IS LIMITED TO THE REPAIR OR REPLACEMENT OF A DEFECTIVE PRODUCT AT OUR OPTION. THE MANUFACTURER SHALL NOT, IN ANY EVENT, BE LIABLE TO THE PURCHASER OR ANY THIRD PARTY FOR ANY INCIDENTAL OR CONSEQUENTIAL DAMAGE (INCLUDING, BUT NOT LIMITED TO, DAMAGES RESULTING FROM INTERRUPTION OF SERVICE AND LOSS OF BUSINESS) OR LIABILITY IN TORT RELATING TO THIS PRODUCT OR RESULTING FROM ITS USE OR POSSESSION.

LIMITATIONS OF IMPLIED WARRANTIES

There are no other oral or written warranties, expressed or implied, including but not limited to those of merchantability or fitness for a particular purpose. Any implied warranties are limited in duration to one year from the date of purchase

STATE LAW AND YOUR WARRANTY

This warranty gives you specific legal rights, and you may also have other rights granted under state law. These rights vary from state to state

CONTACT INFORMATION

Taiwan & International
No. 135, Jian Yi Rd., Chung Ho City, Taipei, Taiwan
TEL: 886-2-2226-3630
FAX: 886-2-3234-4842
Web Site: www.avermedia.com / <http://www.averdigi.com>

Free Manuals Download Website

<http://myh66.com>

<http://usermanuals.us>

<http://www.somanuals.com>

<http://www.4manuals.cc>

<http://www.manual-lib.com>

<http://www.404manual.com>

<http://www.luxmanual.com>

<http://aubethermostatmanual.com>

Golf course search by state

<http://golfingnear.com>

Email search by domain

<http://emailbydomain.com>

Auto manuals search

<http://auto.somanuals.com>

TV manuals search

<http://tv.somanuals.com>