

Installation Instructions / Warranty

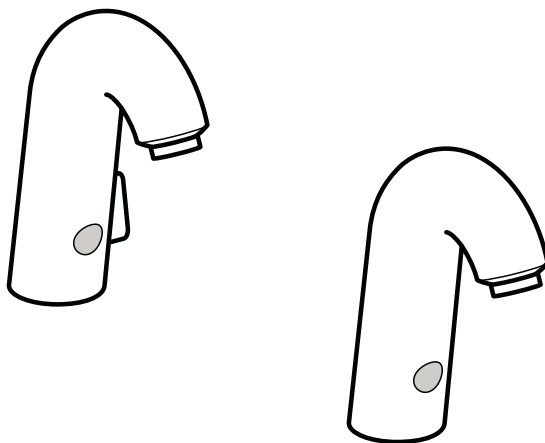

Electronic
15100XX1
15101XX1

AXOR[®]
hansgrohe

90576601 07/2005

Electronic Lavatory Faucet with Adjustable Temperature 15100XX1

Electronic Lavatory Faucet 15101XX1

Technical Data

Recommended water pressure	14.5 – 116 psi
Max. incoming hot water temp	120°F – 140°F*
Max. flow rate	2.2 gpm
Automatic turnoff	after 35 sec.
Battery	Lithium CR-P2/6V
Hole size	1 3/16"
Max. countertop depth	1 3/4"

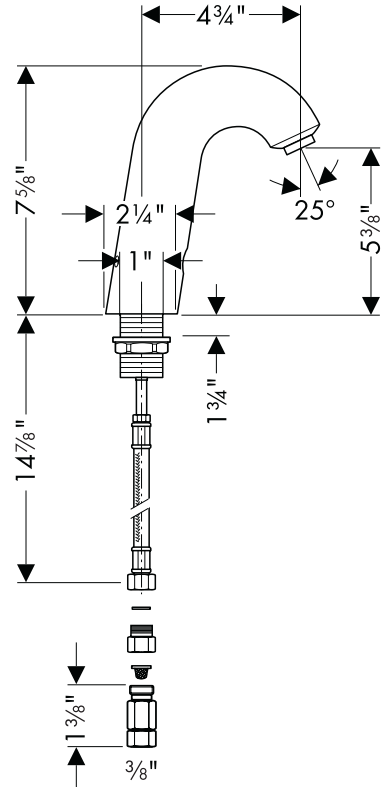

Installation Considerations

- This unit cannot be used with a continuous flow water heater.
- Large differences in pressure between the hot and cold water supplies should be balanced.
- Do not twist or kink the supply hoses
- Flush the supply lines thoroughly before installing this faucet. Debris can clog the filter screens and aerator, causing unsatisfactory flow from the faucet. Debris problems are not covered under the Hansgrohe warranty.
- The check valves and the filter screens should be checked periodically.
- This faucet does not include a drain.

Installation Instructions

- Remove the mounting nut, metal washer, and fiber washer from the faucet.
- Place the faucet with sealing gasket on top of the sink.(1)
- From beneath the sink, install the fiber washer, metal washer, and mounting nut (2).
- Install the adapters to the hot and cold stops (3). Attach the check valves and filter screens to the adapters (4). Attach the hoses to the check valves (5) using two wrenches, as shown. Take care not to twist or kink the supply hoses.

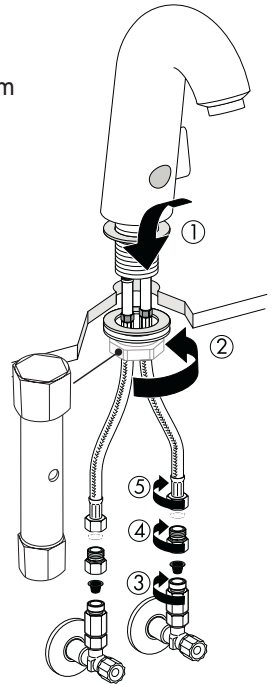
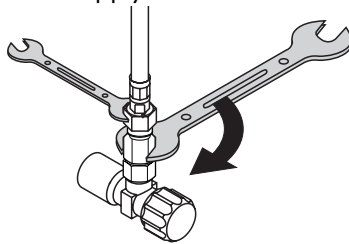

Model 15100XX1

- Turn on the water supplies (1). Remove the protective cover from the sensor (2). Wait 15 seconds (3).
- Place your hand in front of the sensor to turn the water on (4).
- Adjust the temperature of the water with the lever on the side of the faucet. Pivot it forward to obtain cooler water, backward to obtain warmer water.

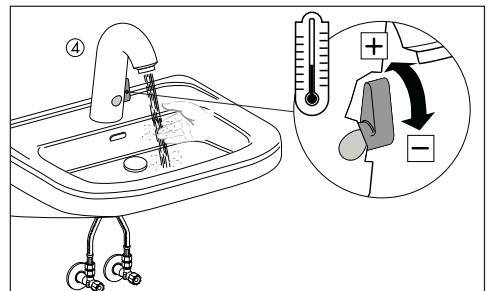
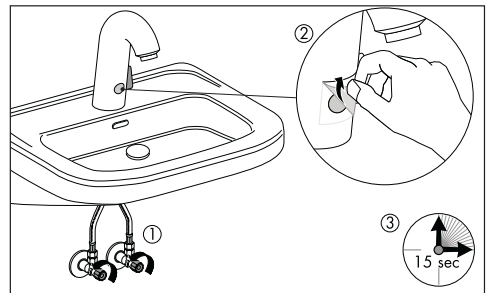

Model 15101XX1

- Turn on the water supplies (1). Remove the protective cover from the sensor (2). Wait 15 seconds (3).
- Place your hand in front of the sensor to turn the water on (4). Check the temperature of the water.
- If adjustment of the temperature is necessary, turn the water off at the supplies (1). Remove the set screw from the rear of the faucet using a 2.5 mm allen wrench (2).
- Pull the faucet housing off (1).
- Use a slot-head screwdriver to adjust the temperature control screw (2). Turn it clockwise to make the water warmer, counter-clockwise to make the water cooler.
- Re-assemble the faucet and turn the water on. Test again. Repeat the process if necessary until the desired temperature is reached.

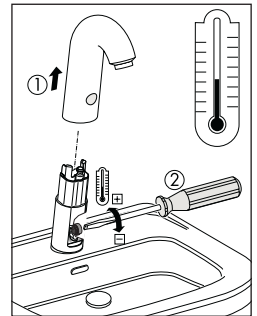
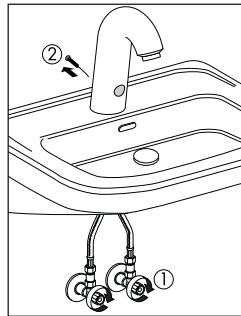
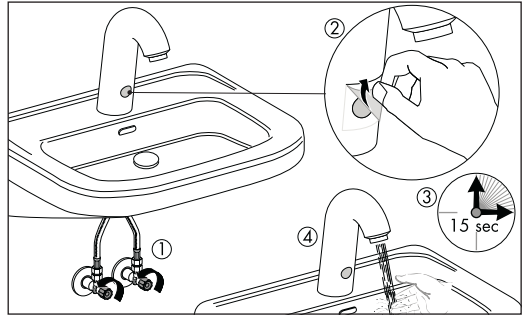

Clean the Sink

- Cover the sensor for 5 seconds (1). The faucet will be shut off for approximately 75 seconds to permit cleaning (2).

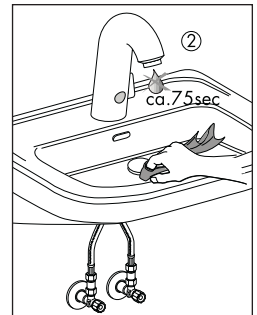

Change the Battery

- Turn the water off at the supplies.
- **Both models:** Remove the set screw from the rear of the faucet with a 2.5 mm allen wrench (1).
- **Model 15100** only: Remove the temperature control handle (2).
- Pull the faucet housing off
- Pull the out battery out and put the new one in (3, 4).
- Reassemble the faucet and test.

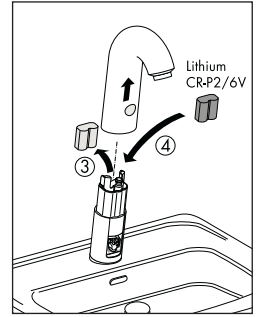
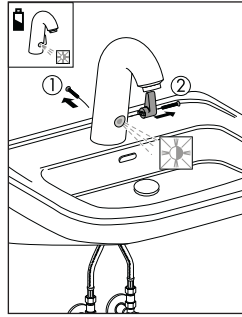

If the flow is unsatisfactory:

Clean the aerator

- Cover the sensor for 5 seconds (1).
- Remove the aerator (2).
- Flush the aerator thoroughly and reinstall.

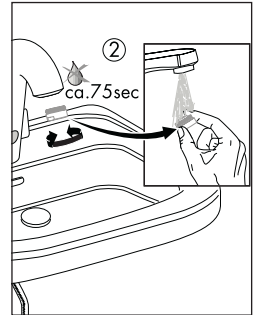
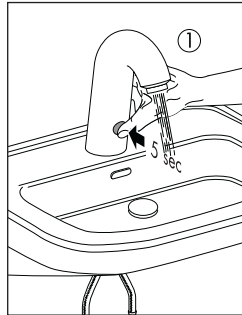

Clean the filter screens

- -Turn the water supplies off. Disconnect the supply hoses.
- Remove and clean the filter screens (2).
- Reinstall the filter screens. Reconnect the hoses.
- Turn the supplies on.

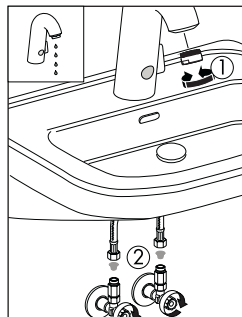

Replacement Parts

1	aerator	96788XXX
2	solenoid valve	96904000
3	fixation set	97812000
4	connection hose	96405001
5	adapter	
6	electronics	96905000
7	battery	Lithium CR-P2/6V or equivalent
8	check valve	

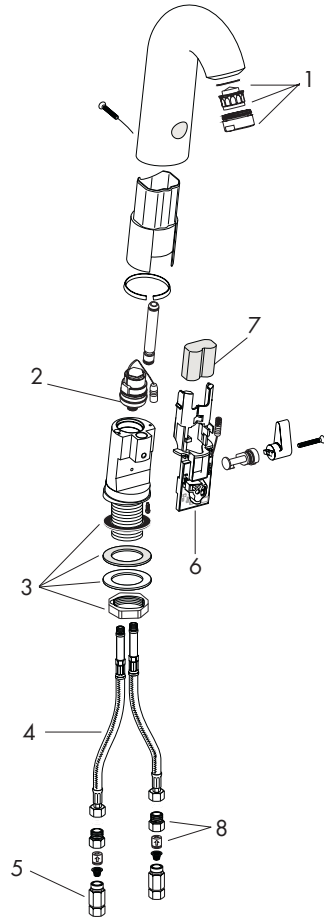

Cleaning Recommendation for Hansgrohe Products

Modern faucetry and shower products utilize a combination of materials to comply with the needs of the market with regard to design and functionality.

To avoid damage, it is necessary to use some caution when cleaning. Damage caused by improper treatment is not covered under the Hansgrohe warranty.

Cleaning Materials for Faucets and Showers

- To remove lime scale, use only products made specifically for that purpose. Always follow the manufacturer's instructions when using.
- Do not use cleaners that contain hydrochloric, formic, acetic, or phosphoric acids, as these will cause considerable damage to finishes and to plastic components.
- Never mix cleaning materials.
- Never use cleaners containing abrasives. Do not use abrasive cleaning cloths, pads, or sponges.

Cleaning Procedures

- Clean your faucets and shower products as and when required. Regular cleaning will prevent scale buildup and water spotting.
- Follow the label instructions. Do not allow any cleaner to remain on the product for longer than necessary.
- When using spray cleaners, spray first onto a sponge or cloth – do not spray directly onto the product.
- After cleaning, rinse thoroughly with clear water to remove any cleaner residue.

Important

- Soap and shampoo residue can also cause damage to the product. Rinse well with clean water after use.
- If the surface is already damaged, harsh cleaning materials will cause further damage.

Limited Lifetime Consumer Warranty

This product has been manufactured and tested to the highest quality standards by Hansgrohe, Inc. ("Hansgrohe"). This warranty is limited to Hansgrohe products which are purchased by a consumer in the United States after March 1, 1996, and installed in either the United States or Canada.

WHO IS COVERED BY THE WARRANTY

This warranty extends to the original consumer purchaser only.

WHAT IS COVERED BY THE WARRANTY

This warranty covers only your Hansgrohe manufactured product. Hansgrohe warrants this product against defects in material or workmanship as follows: Hansgrohe will repair at no charge for parts only or, at its option, replace any product or part of the product which proves defective because of improper workmanship and/or material, under normal installation, use, service and maintenance. If Hansgrohe is unable to provide a replacement and repair is not practical or cannot be timely made, Hansgrohe may elect to refund the purchase price in exchange for the return of the product.

LENGTH OF WARRANTY

Replacement or repaired parts of products will be covered for the term of this warranty as stated in the following two sentences. If you are a consumer who purchased the product for use primarily for personal, family, or household purposes, this warranty extends for as long as you own the product and the home in which the product is installed. If you purchased the product for use primarily for any other purpose, including, without limitation, a commercial purpose, this warranty extends only (i) for 1 year, with respect to Interaktiv and Retroaktiv products, and (ii) for 5 years, with respect to AXOR, ShowerPower and Pharo products.

THIS WARRANTY DOES NOT COVER, AND HANSGROHE WILL NOT PAY FOR:

- Conditions, malfunctions or damage not resulting from defects in material or workmanship.
- Conditions, malfunctions or damage resulting from (1) improper installation, improper maintenance, misuse, abuse, negligence, accident or alteration, or (2) the use of abrasive or caustic cleaning agents or "no rinse" cleaning products, or the use of the product in any manner contrary to the product instructions.
- Labor or other expenses for the disconnection or return of the product for warranty service, or for installation or reinstallation of the product.
- Accessories or related products not manufactured by Hansgrohe.

TO OBTAIN WARRANTY SERVICE

Contact your Hansgrohe retailer, or write to Technical Service at:

Hansgrohe Inc.
1492 Bluegrass Lakes Parkway
Alpharetta GA 30004

Or, call Hansgrohe toll-free at (800) 334-0455.

In requesting warranty service, you will need to provide

1. The sales receipt or other evidence of the date and place of purchase.
2. A description of the problem.
3. Delivery of the product or the defective part, postage prepaid and carefully packed and insured, to Hansgrohe Inc. 1492 Bluegrass Lakes Parkway, Alpharetta, Georgia 30004, Attention: Technical Service, if required by Hansgrohe.

When warranty service is completed, any repaired or replacement product or part will be returned to you postage prepaid.

EXCLUSIONS AND LIMITATIONS

REPAIR OR REPLACEMENT (OR, IN LIMITED CIRCUMSTANCES, REFUND OF THE PURCHASE PRICE) AS PROVIDED UNDER THIS WARRANTY IS THE EXCLUSIVE REMEDY OF THE PURCHASER. HANSGROHE NEITHER ASSUMES NOR AUTHORIZES ANY PERSON TO CREATE FOR IT ANY OBLIGATION OR LIABILITY IN CONNECTION WITH THIS PRODUCT.

HANSGROHE SHALL NOT BE LIABLE TO PURCHASER OR ANY PERSON FOR ANY INCIDENTAL, SPECIAL, OR CONSEQUENTIAL DAMAGES, ARISING OUT OF BREACH OF THIS WARRANTY OR ANY IMPLIED WARRANTY (INCLUDING MERCHANTABILITY).

Some States do not allow the exclusion or limitation of incidental or consequential damages, so the above limitation or exclusion may not apply to you.

This warranty gives you specific legal rights, and you may have other rights which vary from State to State.

You may be required by law to give us a reasonable opportunity to correct or cure any failure to comply before you can bring any action in court against us under the Magnuson-Moss Warranty Act.

PRODUCT INSTRUCTIONS AND QUESTIONS

Upon purchase or prior to installation, please carefully inspect your Hansgrohe product for any damage or visible defect. Prior to installing, always carefully study the enclosed instructions on the proper installation and the care and maintenance of the product. If you have questions at any time about the use, installation, or performance of your Hansgrohe product, or this warranty, please call or write to us at the toll-free number and address printed above.

hansgrohe

Hansgrohe, Inc. • 1490 Bluegrass Lakes Parkway • Alpharetta, GA 30004
Tel. 770 360-9880 • Fax 770 360 9887
www.hansgrohe-USA.com

Free Manuals Download Website

<http://myh66.com>

<http://usermanuals.us>

<http://www.somanuals.com>

<http://www.4manuals.cc>

<http://www.manual-lib.com>

<http://www.404manual.com>

<http://www.luxmanual.com>

<http://aubethermostatmanual.com>

Golf course search by state

<http://golfingnear.com>

Email search by domain

<http://emailbydomain.com>

Auto manuals search

<http://auto.somanuals.com>

TV manuals search

<http://tv.somanuals.com>