



# SUPER DECK 5736 SERIES ELECTRIC DECK OVENS



**Model EB-1-8-5736**  
with optional casters

## SPECIFICATIONS

BAKERS PRIDE EP-EB-ER Series Electric Deck Ovens are designed for high volume pizza, baking, roasting and all-purpose operations. Interior decks are 36" (915mm) deep and 57" (1448mm) wide. Overall dimensions are 43" (1092mm) deep by 74" (1880mm) wide.

Ovens may be stacked three high. Similar footprints may be mixed with different deck heights. Oven exteriors are all heavy-gauge, type 403 stainless steel and are fully insulated up to 5" (127mm) thick for cooler outer temperatures and consistent interior temperatures.

Oven interiors are manufactured of high-heat resistant 18-gauge aluminized steel. Doors are fully insulated, spring balanced with tubular steel handles.

All models feature independent, operator controlled infinite top & bottom heat for perfectly balanced results. Temperature ready indicator lights, moisture control damper and oven interior lights are standard.

EP (pizza) series feature a 300°-800° F (149°-427°C) thermostat, 7" (178mm) interior deck height with hearth stone decks (steel decks optional).

EB (bake) and ER (roast) Series feature 150°-550° F (65° - 288°C) thermostats, a 60-minute electric timer with continuous-ring, audible alarm and manual shut-off. Interior deck heights are available in 8" (203mm) or 12" (305mm). Steel decks standard (optional hearth stone decks reduce deck height by 1" (25mm)).

5736 models are 12KW and feature 12 electric elements (6 top and 6 bottom). Voltages are available in 208v, 220-240v or 440-480v 1Ø or 3Ø as well as 230-400v in 3Ø with neutral.

2 Year limited part and labor warranty standard.

Job \_\_\_\_\_ Item # \_\_\_\_\_

## ELECTRIC DECK OVENS



### PIZZA

- EP-1-8-5736
- EP-2-8-5736
- EP-3-8-5736

### BAKE

- EB-1-8-5736
- EB-2-8-5736
- EB-3-8-5736

### BAKE or ROAST

- ER-1-12-5736
- ER-2-12-5736
- ER-3-12-5736

## STANDARD FEATURES

- 5736 Models @ 12,000 watts in 208v, 220-240v, 440-480v, 230v or 230-400v
- 300°-800° F (149°-427°C) "Pizza" thermostat
- 150°-550° F (65°-288°C) "Bake & Roast" thermostat
- Infinite Top & Bottom heat controls
- Electric 60-minute timer with continuous ring alarm and manual shut-off on bake & roast models
- Interior oven lights
- Moisture control dampers
- 8" (203mm) or 12" (305mm) Interior deck heights with steel decks and 7" (178mm) or 11" (279mm) interior deck heights in hearth stone
- All stainless steel exteriors
- Aluminized steel interiors
- Spring balanced, fully insulated doors
- Cordierite hearth decks in EP Series
- Steel decks in EB and ER Series
- Fully insulated
- 2 Year limited part and labor warranty

## OPTIONS & ACCESSORIES

- Hearth stone decks in EB and ER Series — steel decks are recommended for roasting applications
- Steel decks are optional in EP Series
- Choice of thermostat
- Set of 4 casters — two with locks
- Internal steam manifold with individual, adjustable, solenoid controlled steam injectors in each deck — steam source by others
- 5 Hour timer in lieu of 60 minute timer for roasting applications (ER models only)
- Stainless steel leg covers — pair

## CERTIFICATIONS



BAKERS PRIDE OVEN COMPANY, INC.  
30 Pine Street, New Rochelle, NY 10801  
914/576-0200 • 1-800-431-2745 • fax 914/576-0605  
www.bakerspride.com

*Continuous product improvement is a policy of Bakers Pride Oven Company. Therefore, specifications and design are subject to change without notification*

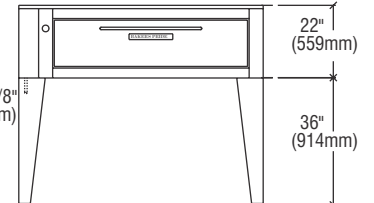
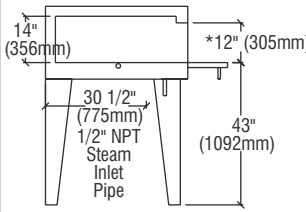
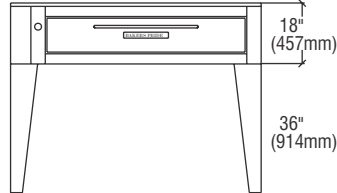
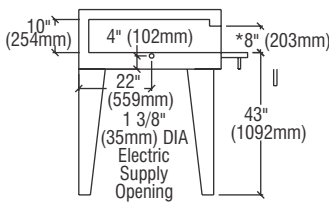
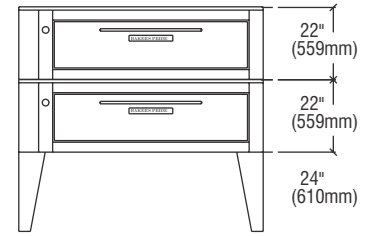
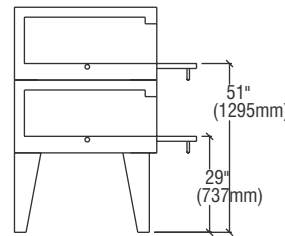
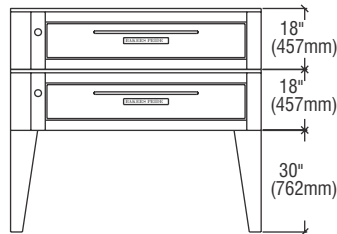
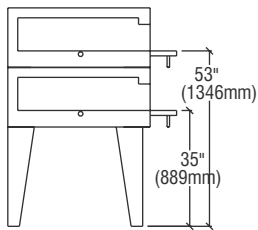
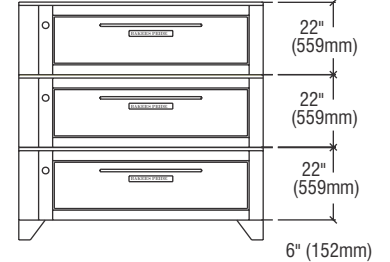
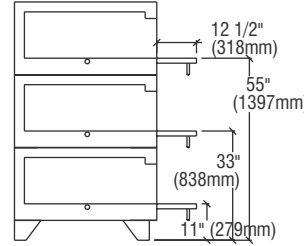
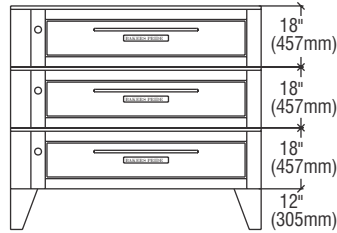
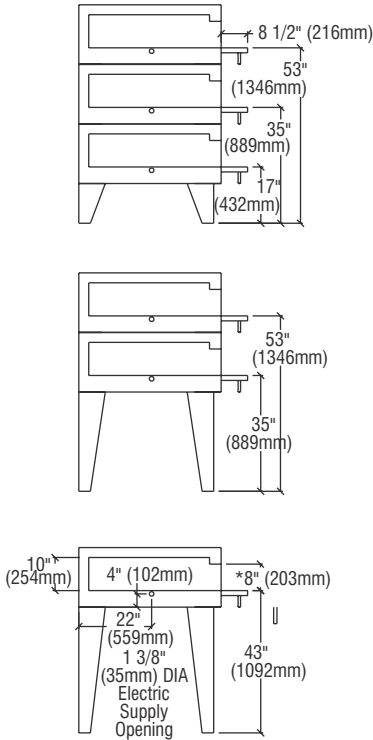
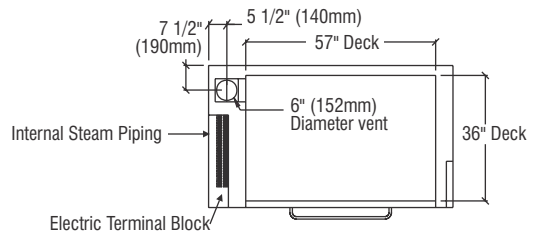
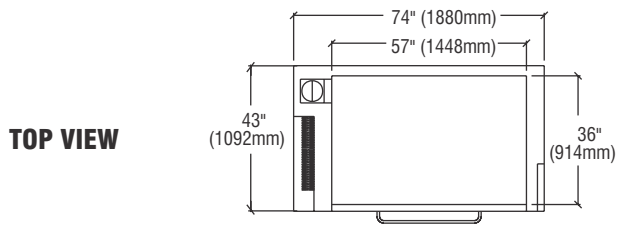

**EP-EB-8-5736  
SIDE VIEW**

**EP-EB-8-5736  
FRONT VIEW**

**ER-12-5736  
SIDE VIEW**

**ER-12-5736  
FRONT VIEW**

ALL DIMENSIONS NOMINAL

\*Steel decks @ 8" & 12" heights — Cordierite decks @ 7" & 11" heights

Model	Shipping Weight		Carton Dimensions				Crate Size			
	Lbs.	Kilos	Width Inches	mm	Depth Inches	mm	Height Inches	mm	Cubic Feet	Cubic Meter
EP-5736	700	318	79	2007	24	610	48	1219	40	1.1

Under 500 lbs = Shipping Class # 70  
Each deck ships separately

POWER SUPPLY							
Model	WATTS	VOLTAGE	PHASE	AMPS			
				L1	L2	L3	N
All Models	12,000	208	3	39	39	39	-
	12,000	220-240	3	35	35	35	-
	12,000	208	1	58	58	-	-
	12,000	220-240	1	52	52	-	-
	12,000	230-400	3N	18	17	17	1
	12,000	230	1	52	-	-	52
	12,000	440-480	3	18	20	18	-
	12,000	440-480	1	26	26	-	-

Each deck requires separate electrical connection

Model	Deck Size				# Decks	Overall Dimensions					
	Inches	mm	Height Inches	mm		Inches	mm	Depth Inches	mm	Height Inches	mm
EP-1-8-5736	57x36	1448x914	8	203	1	74	1880	43	1092	56	1422
EP-2-8-5736	57x36	1448x914	8	203	2	74	1880	43	1092	66	1676
EP-3-8-5736	57x36	1448x914	8	203	3	74	1880	43	1092	66	1676
EB-1-8-5736	57x36	1448x914	8	203	1	74	1880	43	1092	56	1422
EB-2-8-5736	57x36	1448x914	8	203	2	74	1880	43	1092	66	1676
EB-3-8-5736	57x36	1448x914	8	203	3	74	1880	43	1092	66	1676
ER-1-12-5736	57x36	1448x914	12	305	1	74	1880	43	1092	60	1524
ER-2-12-5736	57x36	1448x914	12	305	2	74	1880	43	1092	68	1727
ER-3-12-5736	57x36	1448x914	12	305	3	74	1880	43	1092	72	1829

\* Height includes 36" (914 mm) standard legs on single decks  
 \* Height includes 30" (762 mm) standard legs on double decks with 8" deck heights  
 \* Height includes 24" (610 mm) standard legs on double decks with 12" deck heights  
 \* Height includes 12" (305 mm) standard legs on triple decks with 8" heights  
 \* Height includes 6" (152 mm) standard legs on triple decks with 12" heights

	Non-Combustible Construction*		Combustible Construction**	
	Inches	mm	Inches	mm
Left Side	0	0	0	0
Right Side	0	0	0	0
Rear	0	0	0	0

\* In European Community Countries and North America. In NON-COMBUSTIBLE locations only.  
 \*\* In European Community Countries only in COMBUSTIBLE locations. NOT for North America.



BAKERS PRIDE OVEN COMPANY, INC.  
 30 Pine Street, New Rochelle, NY 10801  
 914/576-0200 • 1-800-431-2745 • fax 914/576-0605  
 www.bakerspride.com

Continuous product improvement is a policy of Bakers Pride Oven Company. Therefore, specifications and design are subject to change without notification

TSW: 01/07

## Free Manuals Download Website

<http://myh66.com>

<http://usermanuals.us>

<http://www.somanuals.com>

<http://www.4manuals.cc>

<http://www.manual-lib.com>

<http://www.404manual.com>

<http://www.luxmanual.com>

<http://aubethermostatmanual.com>

Golf course search by state

<http://golfingnear.com>

Email search by domain

<http://emailbydomain.com>

Auto manuals search

<http://auto.somanuals.com>

TV manuals search

<http://tv.somanuals.com>