

BenQ
DV2050
20.1" LCD TV
User's Manual

Welcome

i Copyright

Copyright BenQ Corporation. All rights reserved. No part of this User's Manual may be reproduced, transmitted, transcribed, stored in a retrieval system or translated into any language or computer language, in any form or by any means, electronic, mechanical, magnetic, optical, chemical, manual or otherwise, without the prior written permission of BenQ Corporation.

ii Disclaimer

BenQ Corporation makes no representations or warranties, either expressed or implied, with respect to the contents of this User's Manual. BenQ Corporation reserves the right to revise this publication and to make changes from time to time in the contents thereof without obligation to notify any person of such revision or changes.

iii FCC Statement

FCC Notice

LCD TV DV2050: A CLASS B digital device

This equipment has been tested and found to comply with the limits for a Class B digital device, pursuant to part 15 of the FCC Rules. These limits are designed to provide reasonable protection against harmful interference when the equipment is operated in a commercial environment.

This equipment generates, uses, and can radiate radio frequency energy and, if not installed and used in accordance with the instruction manual, may cause harmful interference to radio communications. Operation of this equipment in a residential area is likely to cause harmful interference in which case the user will be required to correct the interference at his own expense.

FCC CAUTION

Pursuant to 47CFR, Part 15.21 of the FCC rules, any changes or modifications to this monitor not expressly approved by BENQ Corporation could cause harmful interference and would void the user's authority to operate this device.

WARNING: This is a CLASS B product. In a domestic environment this product may cause radio interference in which case the user may be required to take adequate measures to counter interference.

WARNING: To reduce the risk of fire and electric shock, do not expose this product to rain or moisture.

iv Important Safety Instructions

Electrical energy can perform many useful functions, but it can also cause personal injury and property damage if improperly handled. This product has been engineered and manufactured with the highest priority on safety. But **IMPROPER USE CAN RESULT IN POTENTIAL ELECTRICAL SHOCK OR FIRE HAZARD**. In order to prevent potential danger, please observe the following instructions when installing, operating and cleaning the product. Proper care will also prolong the service life of your BenQ LCD TV. Just follow these simple instructions before using your TV.

- 1. Read instructions**—All operating instructions must be read and understood before the product is operated.
- 2. Retain instructions**—These safety and operating instructions must be kept in a safe place for future reference.
- 3. Observe warnings**—All warnings on the product and in the instructions must be observed closely.

4. Follow instructions—All operating instructions must be followed.

5. Water and moisture—Do not use this product near water - for example, near a bathtub, washbowl, kitchen sink, or laundry tub, in a wet basement, or near a swimming pool, and the like space. Do not use immediately after moving from a low temperature to a high temperature environment, as this causes condensation, which may result in fire, electric shock, or other hazards.



6. Cleaning—Unplug this product from the wall outlet before cleaning. Do not use liquid cleaners or aerosol cleaners. Use a damp cloth for cleaning.

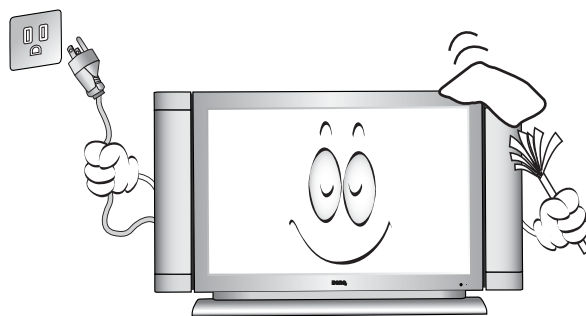

7. Ventilation—The vents and other openings in the cabinet are designed to let hot air escape from the TV. Do not cover or block these vents and openings since insufficient ventilation can cause overheating and/or shorten the life of the product. Do not place the TV on a bed, sofa, rug or other similar surface, since they can block ventilation openings. This TV is not designed for built-in installation; do not place the product in an enclosed place such as a bookcase or rack, unless proper ventilation is provided or the manufacturer's instructions are followed.

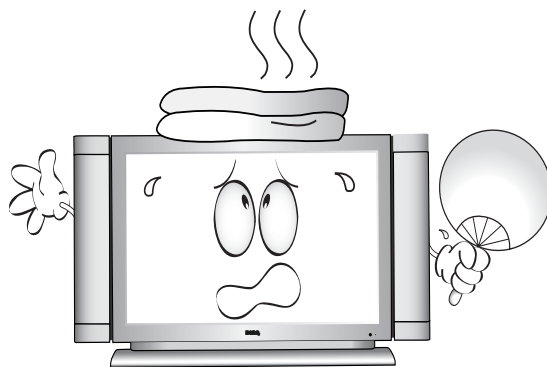

8. Heat sources—Keep the product away from heat sources such as radiators, heaters, stoves and other heat-generating products (including amplifiers).

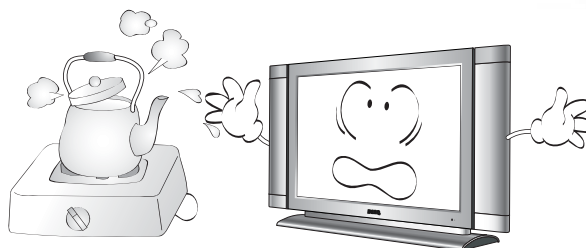

9. Grounding or Polarization—This product may be equipped with either a polarized 2-wire AC line plug (a plug having one blade wider than the other) or a 3-wire grounding-type plug, a plug having a third (grounding) pin. The 2-wire polarized plug will fit into the power outlet only one way. This is a safety feature. If you are unable to insert the plug fully into the outlet, try reversing the plug. If the plug still fails to fit, contact your electrician to replace your incompatible outlet. DO NOT ATTEMPT TO BYPASS THE SAFETY PURPOSE OF THE POLARIZED AND GROUNDED PLUG. The 3-wire grounding-type plug will fit into a grounding type power outlet. This is a safety feature. If you are unable to insert the plug into the outlet, contact your electrician to replace your incompatible outlet.

10. **Power cord protection**— Power-supply cords should be routed so that they are not likely to be walked on or snagged by items placed upon or against them. Pay particular attention to cords at doors, plugs, receptacles, and the point where they exit from the product.
11. **Attachments**—Do not use attachments not recommended by the manufacturer. Use of improper attachments can result in accidents.
12. **Accessories**—When the product is used on a trolley, care should be taken to avoid quick stops, excessive force, and uneven surfaces that may cause the product and trolley to overturn, damaging equipment or causing possible injury to the operator. Do not place this product on an unstable trolley, stand, pedestal, bracket, or table. The product may fall, causing serious injury to a child or adult and serious damage to the product. The product should be mounted according to the manufacturer's instructions, and use only with a trolley, stand, pedestal, bracket, or table recommended by the manufacturer.
13. **Servicing**—Do not attempt to service the product yourself. Removing covers can expose you to high voltage and other dangerous conditions. Request a qualified service person to perform servicing.
14. **Replacement parts**—In case the product needs replacement parts, make sure that the service person uses replacement parts specified by the manufacturer, or those with the same characteristics and performance as the original parts. Use of unauthorized parts can result in fire, electric shock and/or other danger.
15. **Overloading**—Do not overload wall outlets, extension cords, or convenience receptacles on other equipment as this can result in a risk of fire or electric shock.
16. **Entering of objects and liquids**—Never poke an object into the product through vents or openings. High voltage flows in the product, and inserting an object can cause electric shock and/or short circuit internal parts. For the same reason, do not spill water or liquid on the product.
17. **Damage requiring service**—If any of the following conditions occurs, unplug the power cord from the AC outlet, and request a qualified service person to perform repairs.
 - When the power cord or plug is damaged.
 - When a liquid is spilled on the product or when objects have fallen into the product.
 - When the product has been exposed to rain or water.
 - When the product does not operate properly as described in the operating instructions.
 - Do not touch the controls other than those described in the operating instructions. Improper adjustment of controls not described in the instructions can cause damage, which often requires extensive adjustment work by a qualified technician.
 - If the product has been dropped or the cabinet has been damaged in any way.
 - When the product displays an abnormal condition or exhibits a distinct change in performance. Any noticeable abnormality in the product indicates that the product needs servicing.
18. **Safety checks**—Upon completion of service or repair work, request the service technician to perform safety checks to ensure that the product is in proper operating condition.

19. Wall mounting—When mounting the product on a wall, be sure to install the product according to the method recommended by the manufacturer using only the manufacturers mounting hardware. This is a safety requirement..

20. Stand—Do not place the product on an unstable trolley, stand, tripod or table. Placing the product on an unstable base can cause the product to fall, resulting in serious personal injuries as well as damage to the product. Use only a trolley, stand, tripod, and bracket or table recommended by the manufacturer or sold with the product.

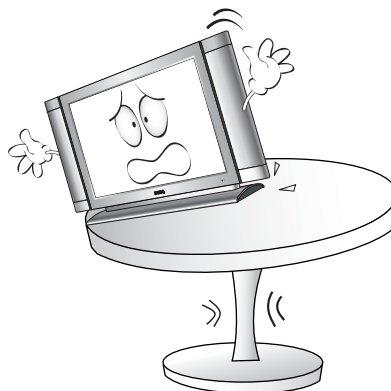

21. Careful move—When relocating the product placed on a trolley, it must be moved with the utmost care. Sudden stops, excessive force and uneven floor surfaces can cause the product to fall from the trolley.

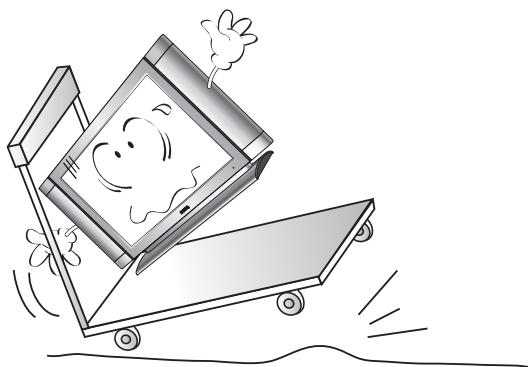

22. Panel protection—The LCD panel used in this product is made of glass. Therefore, it can break when the TV is dropped or hit by other objects. Beware of injuries in the event of the LCD glass screen breaking.

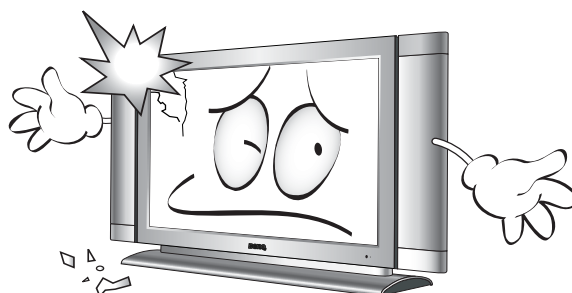

23. Panel cleaning—Cleaning the LCD panel of your TV regularly helps to extend its life. When cleaning, use clean, soft and lint-free cloth. Dip appropriate amount of LCD panel cleaning detergent on the cloth and wipe the whole panel quickly, and then use another cloth to wipe the panel thoroughly.

24. Pixel defect—The LCD panel is a high technology product, giving you finely detailed pictures. Occasionally, a few non-active pixels may appear on the screen as a fixed point of blue, green or red. Please note that this does not affect the performance of your product.

25. Installation of an external antenna -

When installing an outside antenna to the television equipment, be sure the antenna system is grounded so as to provide some protection against voltage surges and built-up static charges. Section 810 of the National Electrical Code provides information with respect to:

- proper grounding of the mast and supporting structure;
- grounding of the lead-in wire to an antenna discharge unit;
- size of grounding conductors;
- location of antenna-discharge unit;
- connection to grounding electrodes;
- and requirements for the grounding electrode.

EXAMPLE OF ANTENNA GROUNDING AS PER NATIONAL ELECTRICAL CODE

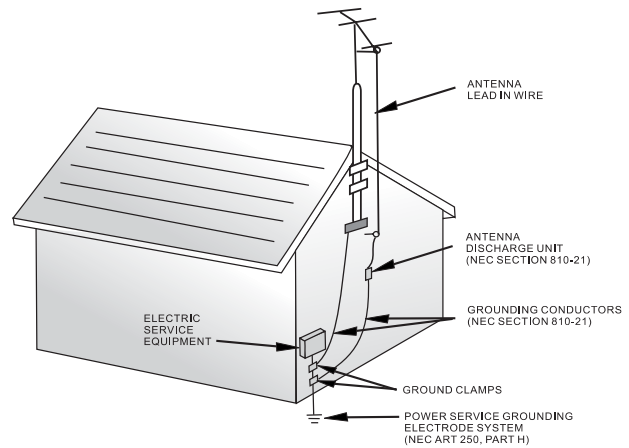

For added protection for this television equipment during a lightning storm, or when it is left unattended and unused for long periods of time, unplug it from the wall outlet and disconnect the antenna. This will prevent damage to the equipment due to lightning and power-line surges.

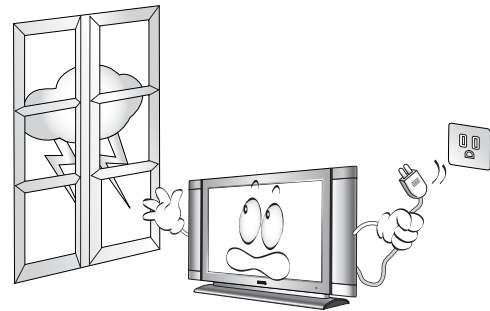

An outside antenna system should not be located in the vicinity of overhead power lines or other electric light or power circuits, or where it can collide with such power lines or circuits. When installing an outside antenna system, extreme care should be taken to keep from touching such power lines or circuits, as contact with them might be fatal.

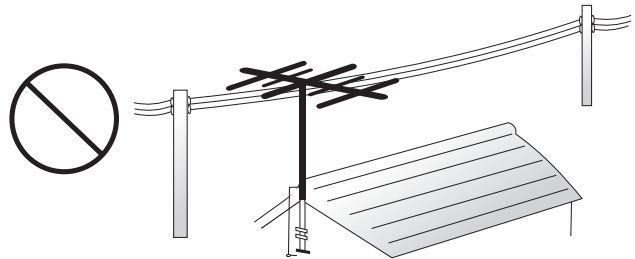

Note to CATV system installer: This reminder is provided to call the CATV system installer's attention to Article 820-40 of the National Electrical Code that provides guidelines for proper grounding and, in particular, specifies that the cable ground shall be connected to the grounding system of the building, as close to the point of cable entry as practical."

WARNING: FCC Regulations state that any unauthorized changes or modifications to this equipment not expressly approved by the manufacturer could void the user's authority to operate this equipment. (U.S.A. ONLY)

v Table of Contents

Introduction.....	1
Functions and Features	1
Package Contents.....	2
Getting to Know Your TV	3
Main Unit (Front View)	3
Control Panel.....	3
Main Unit (Rear View).....	4
Setting up Your TV.....	5
Connecting the Power Cord	5
Connecting the Antenna	5
Connecting CATV	5
Antenna.....	6
Installation of an Outdoor Antenna.....	6
Making Connection.....	6
Connecting AV Equipment.....	7
Connecting Composite (AV) Video Signal.....	7
Connecting S-Video Signal	7
Connecting Component Video Input (Y CB/PB CR/PR) Signals	8
Connecting Audio Output Signals	9
Remote Control	10
Using the Remote Control	12
Batteries.....	12
Notes on Using Batteries	13
Using the Remote Control	14
Power on, Power off and Standby	14
Switching Inputs	14
Adjusting Audio.....	15
Changing Channels.....	15
Adjusting User Situation Modes.....	16
Adjusting Aspect Ratio	16
Going to Favorite Channels	17
Selecting TV or CATV Input.....	17
Adding/Deleting Sequential Channels.....	18
Using the Sleep Timer	18
Adjusting Backlight	19

Display Information 19

The On-Screen Display (OSD) Menu 20

How to Use the OSD Menu 21

AUDIO Menu 22

PICTURE Menu..... 23

 Saving Picture Settings to Personal Mode 24

TV Menu 25

 Setting up Favorite Channels 25

 Setting up Closed Caption..... 26

 Setting up V-CHIP..... 26

 Movie Ratings 26

 TV Ratings..... 27

 USA TV Ratings 27

 Canadian English TV Ratings 28

 Canadian French TV Ratings 28

 Adjusting V-Chip Setting 29

 First-Time Setup 29

 Movie Ratings 29

 TV Ratings 29

 Setting up Canadian English and Canadian French TV Ratings 29

 Setting up USA TV Ratings 29

 Canceling the V-CHIP Block Screen While V-CHIP Block is Activated 29

 Changing V-CHIP Blocking Password 29

SETUP Menu 30

Troubleshooting..... 31

TV 31

Antenna 32

Specifications 33

Dimensional Drawings..... 34

1 Introduction

Thank you for purchasing the BenQ DV2050 Liquid Crystal Display Television. Your DV2050 will bring you years of high-quality viewing enjoyment. It is also extremely easy to operate, and provides exceptionally high image quality.

The DV2050 is also extremely versatile. You can install your TV on the wall (optional wall-mounting kit is required) or set it on a table, and it can be used under any type of illumination.

This manual will explain the operation of the DV2050 Liquid Crystal Display Television, including the set's functions and features and other important information. Before installing or operating your liquid crystal display TV, please take the time to thoroughly read this manual, particularly the sections on safety.

Functions and Features

The DV2050 Liquid Crystal Display Television has many useful functions, including:

- 800 x 600 image resolution
- 500 nits brightness
- 500:1 contrast ratio
- Compatibility with all digital TV (DTV) formats (with external tuner), including 1080i, 720p, 576p, 480p and 480i
- Multiple image formats for diverse viewing conditions
- Shortcut buttons:
 1. Stereo / Bi-Lingual Television Sound
 2. Sleep timer
 3. Back light adjustment
 4. Auto Calibration
 5. Aspect Ratio Adjustment
 6. Graphic OSD

2 Package Contents

Please ensure that the following items are included with your DV2050 Liquid Crystal Display TV. If any item is missing or damaged, contact an authorized dealer immediately.



DV2050 LCD TV (x1)



User's manual (x1)



Power cord (x1)



Composite video (AV) cable
(x1)



Remote control (x1)

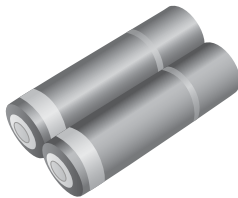

AAA batteries (x2)

 **Different countries have different AC power cord types.**

3 Getting to Know Your TV

Main Unit (Front View)

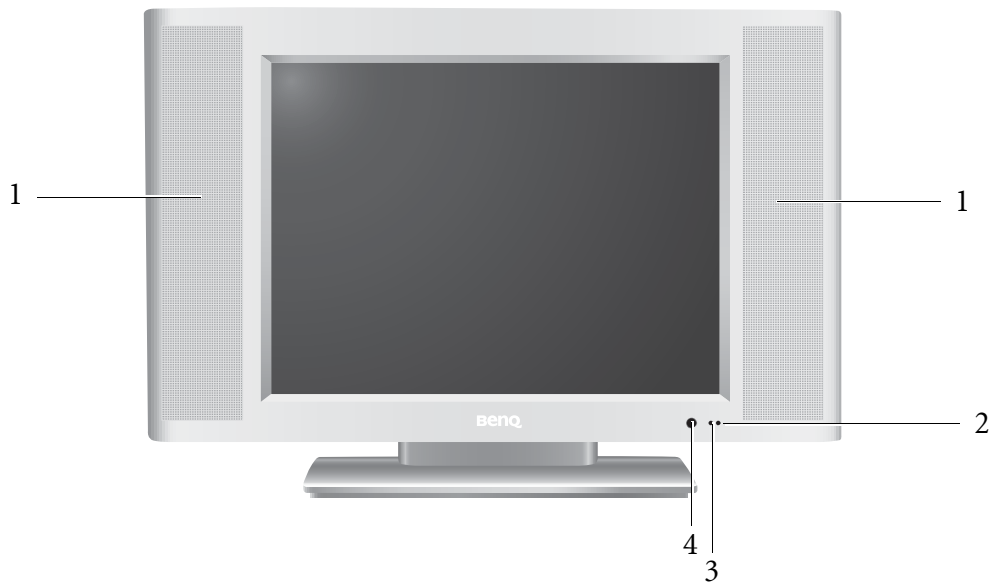

No.	Name	Description
1	Speaker	High-quality speakers for delivering excellent sounds.
2	Power indicators	<ul style="list-style-type: none"> • When the TV is powered on, the green power indicator lights up. • When the TV is in standby mode, the red indicator lights up.
3	Sleep timer indicator	This indicator will light up in amber if the sleep timer function is activated.
4	Remote control sensor window	Receives the signal from the remote control.

Control Panel

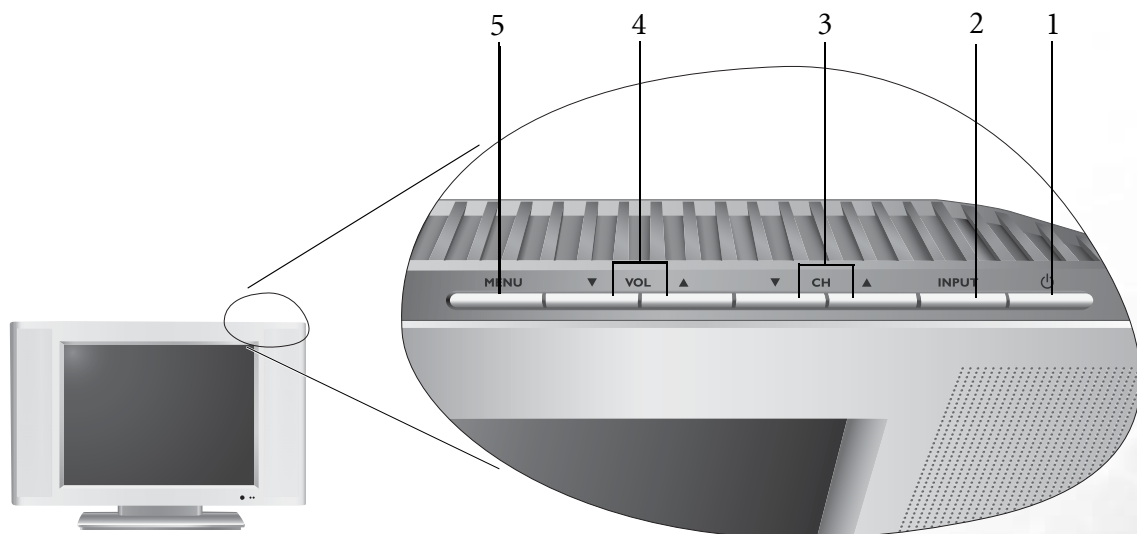

No.	Name	Description
1	Power	Press the Power button to turn on the DV2050 when it is in "standby" mode. Press this button once more to turn the DV2050 "off" by placing it into "standby" mode.
2	INPUT	This button allows you to switch among TV/Video signal sources.

3	Channel (▼)/(▲)	<ul style="list-style-type: none"> • These two buttons allow direct selection of channels. • When the OSD main screen is active, pressing these buttons allows selection of options.
4	Volume (▼)/(▲)	<ul style="list-style-type: none"> • Press Volume ▲ to increase the volume, or Volume ▼ to decrease it. • When the OSD main screen is active, pressing these buttons allows selection of settings.
5	MENU	Press this button to display the on-screen display (OSD) menu. Press this button once again to close the OSD menu.

Main Unit (Rear View)



No.	Name	Description
1	ANTENNA/CABLE	Connect your antenna (not provided) to this input.
2	AV1	<ul style="list-style-type: none"> • VIDEO (Composite (AV) signal input, RCA connector): Connect the Composite video output of your AV device here. • AUDIO(Audio input, L/R): Connect the audio out of your AV device here. This input is used common to both AV and S-VIDEO input. • S-VIDEO (S-VIDEO input): Connect the S-VIDEO OUT of your AV device here.
3	COMPONENT	<ul style="list-style-type: none"> • Y C_B/P_B C_R/P_R (Y C_B/P_B C_R/P_R input): Connect the component image output of your AV devices or HDTV decoder here. The Y (green) connector can also be used as a second composite signal input. • AUDIO(Audio input, L/R): Connect the audio out of your AV device here.
4	AUDIO OUT	Connect the audio input of an amplifier or here.
5	DOWNLOAD	This terminal is for service purpose only.
6	AC INLET	Connect the power cord (provided) to this input.

4 Setting up Your TV

Connecting the Power Cord

1. Connect the female end of the AC power cord to the AC input on the TV.
2. As shown in the diagram, connect the male end to a wall power outlet.

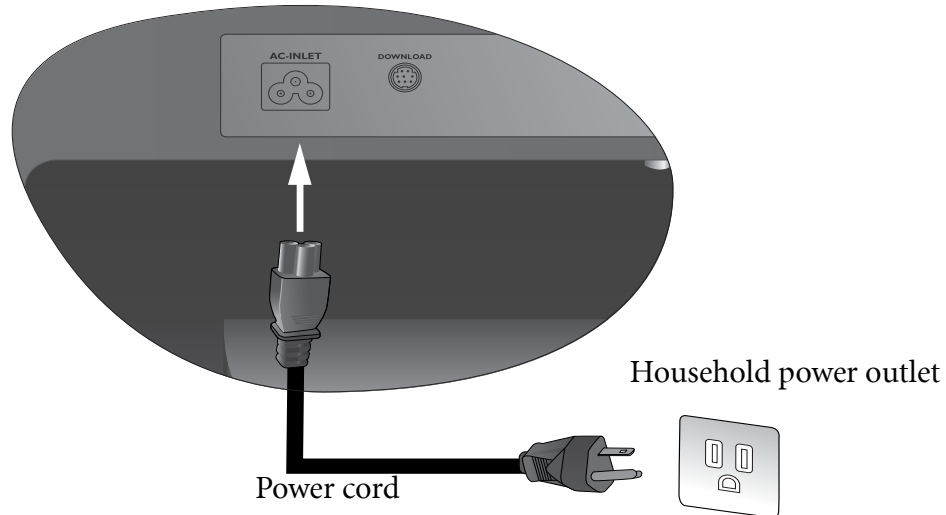

- This product must be operated only from the type of power source indicated on the marking label (AC 100~240V 50/60 Hz).
- If the TV will not be used for a long period of time, it should be unplugged from the wall outlet.

Connecting the Antenna

Connecting CATV

Your BenQ TV has an internal 75 ohm coaxial cable connector, so antennal hook-up is very easy. When connecting a 75-ohm coaxial cable to your BenQ TV, secure it firmly to the ANTENNA connector. Some cable TV companies provide "pay per view" programming. Since the signal for these paid channels is encoded, most cable TV companies provide their own tuners/ decoders. You must install a tuner/ decoder to be able to view locked encoded programming. If you require special instructions on how to install cable service, please contact your cable TV provider. The tuner/decoder provided by your cable TV company can be used according to the following instructions.

Please note: you must have an RF switch with two inputs (A and B) (not supplied).

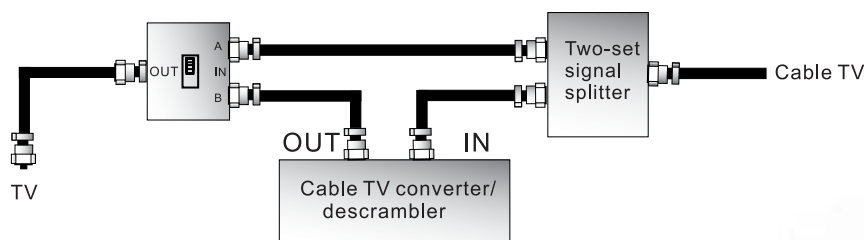

The "A" input on the RF switch (not supplied) allows you to use the TV's channel selector button to view unlocked channels. The "B" input on the RF switch (not supplied) allows you to use the channel selection button on your cable box to view locked encoded programming via the tuner/decoder.

Antenna

The antenna equipment has far more effect on reception for color TVs than on black and white models. We suggest you use a good-quality outdoor antenna. Following are simple explanations for the connection of various types of antennas.

1. Generally speaking, 75 ohm systems have a round cable with an F-shaped connector which requires no tools. Attach the cable directly to the input (not included).
2. 300 ohm systems have a flat "dual lead" type cable. A 300-75 ohm transformer may be used to attach the antenna to a 75 ohm input (not included).



Installation of an Outdoor Antenna

For best reception it is recommended that an Outdoor antenna be used.

A: Use a combination VHF/UHF outdoor antenna.

B: Use separate VHF and/ or UHF outdoor antennas.

Connect the lead from the outdoor antenna to the ANTENNA input on the rear of the TV.

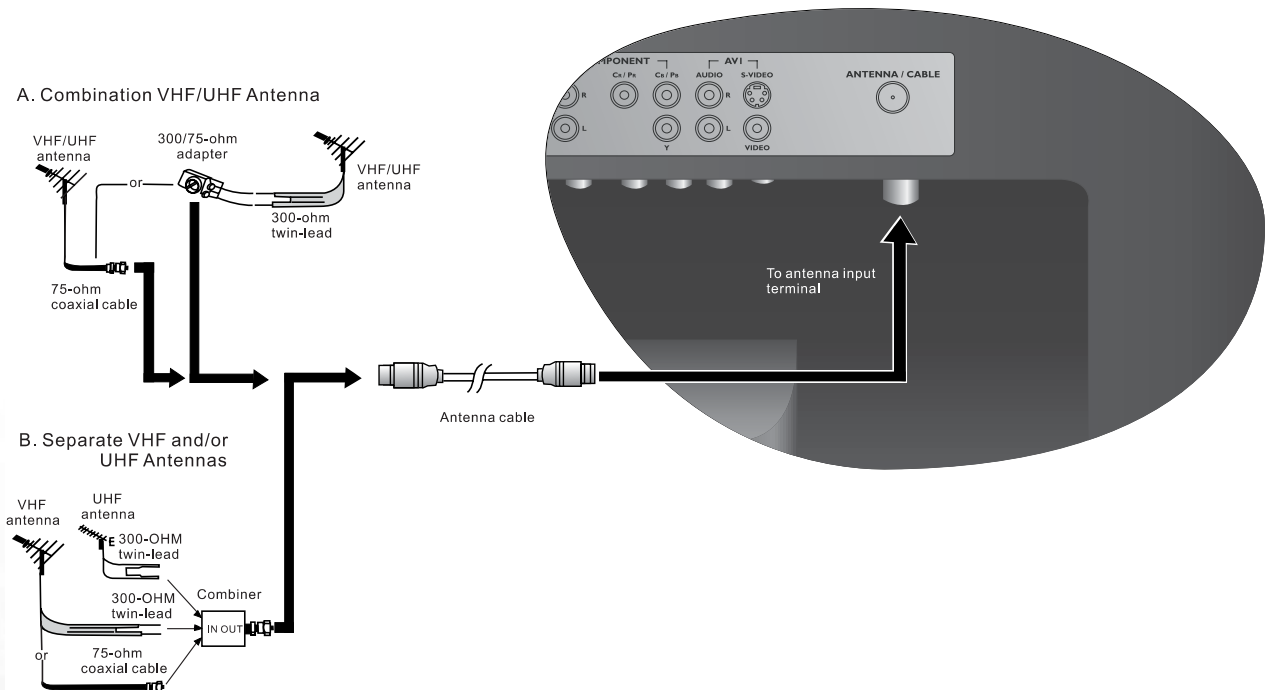

Making Connection

- Before connecting any component, please familiarize yourself with the location and type of each input. If incorrect connections are made, picture or color quality may be adversely affected. Please ensure that all connectors are firmly seated.
- Your DVD player, VCR or home theatre system can be connected to the rear of the TV so that you can enjoy a complete audio-visual experience. Before connecting external devices, turn off the power to the TV for safety.

Connecting AV Equipment

Connecting Composite (AV) Video Signal

Connect the Composite (AV) output of your AV equipment to the Composite (AV) signal terminal on the TV using a Composite (AV) video cable (RCA connector) as illustrated.

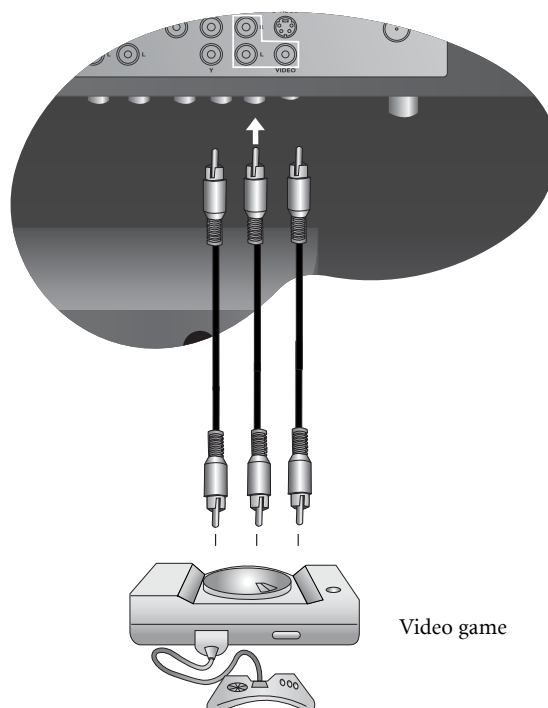

- ☞ Composite video input is the most commonly used signal input. However, this type of input also provides a less optimal image quality. Many video sources can only output Composite video signals, for example, VCRs and camcorders. Other video sources, such as laser disc players, actually produce slightly better results when using Composite video.

Connecting S-Video Signal

Connect the S-Video output of your AV equipment to the TV's S-VIDEO terminal using an S-Video cable. Pay attention to the direction of the connector on the S-Video cable when inserting.

Connect the audio output of your AV equipment to the S-Video output of your AV equipment to the TV's S-VIDEO terminal using an S-Video cable.

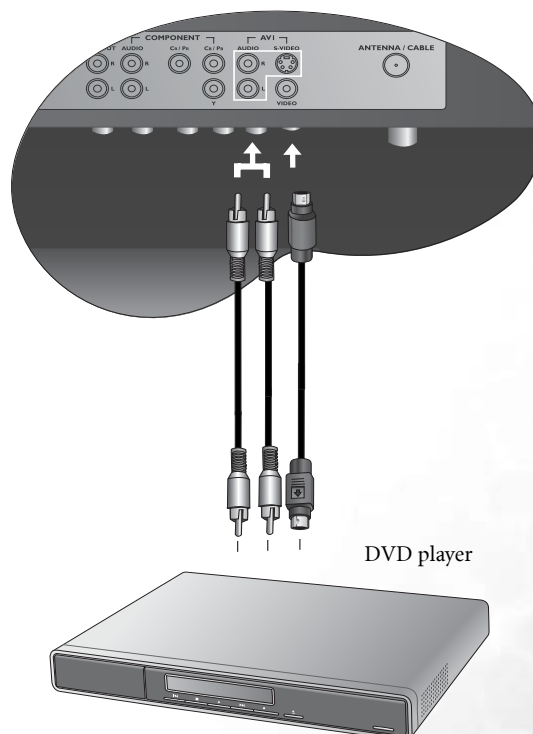

- ☞ An S-video signal provides a higher quality image to that of Composite video. It is recommended to use this input whenever possible. If your AV equipment provides a component video output (YPbPr or YCbCr), this should be used in preference to either composite or S-video signals.

Connecting Component Video Input (Y C_B/P_B C_R/P_R) Signals

Connect your AV equipment to the TV's Component Y C_B/P_B C_R/P_R input using a Component video cable.

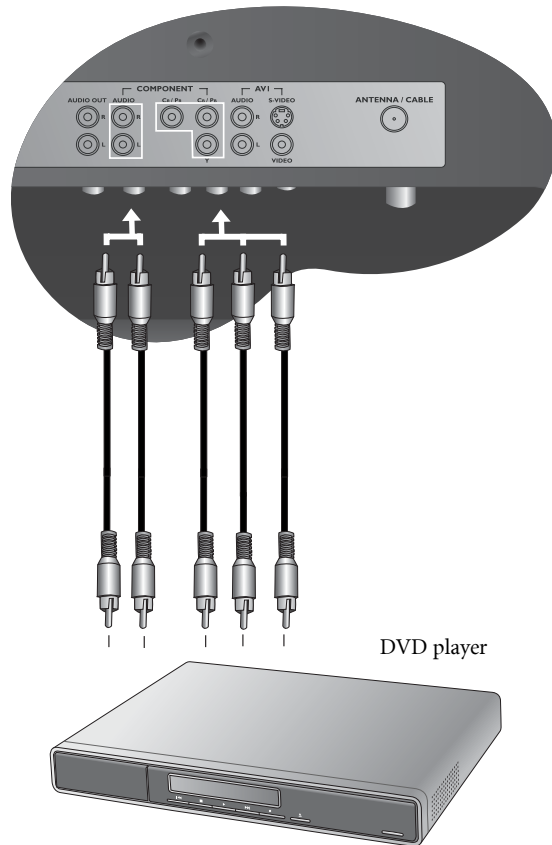

1. Of the currently available video signal types, Component video input offers the best quality. Component video output is available on progressive scan DVD players and Digital television decoders. The image quality with this type of input is superior to that obtained with S-video. All High Definition Television signals must go through this input.
2. Your BenQ TV supports 480p, 720p, 576p and 1080i HDTV signals provided by high definition AV equipment such as a HDTV decoder.
3. Ensure the connector colors match, failure to connect the colors of the cables to the corresponding colored terminals will result in an incorrectly colour image or badly distorted image.

Connecting Audio Output Signals

DV2050 provides extra audio output terminals for delivering TV audio signal to an amplifier or other audio devices.

Connect the AUDIO OUT L/R terminals on the TV to the signal input terminals of an amplifier or other audio devices using the AV cable or equivalent.

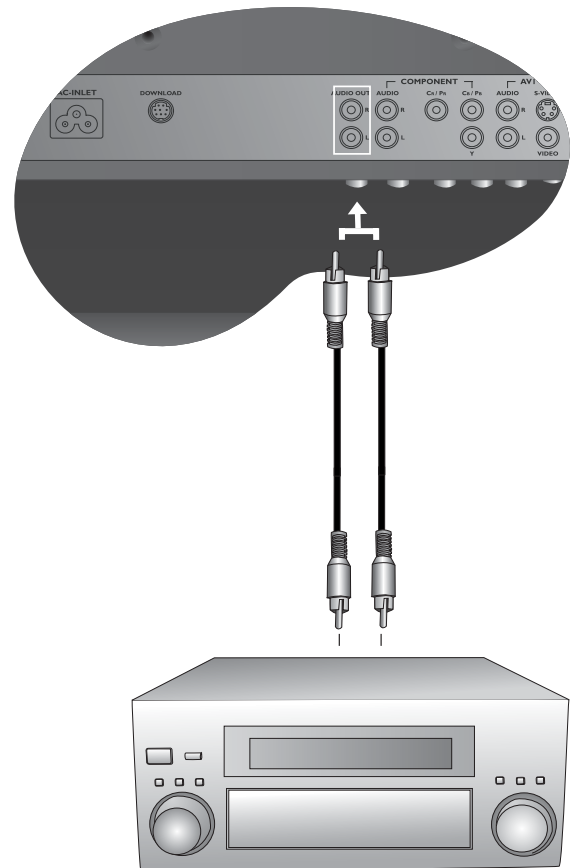

5 Remote Control

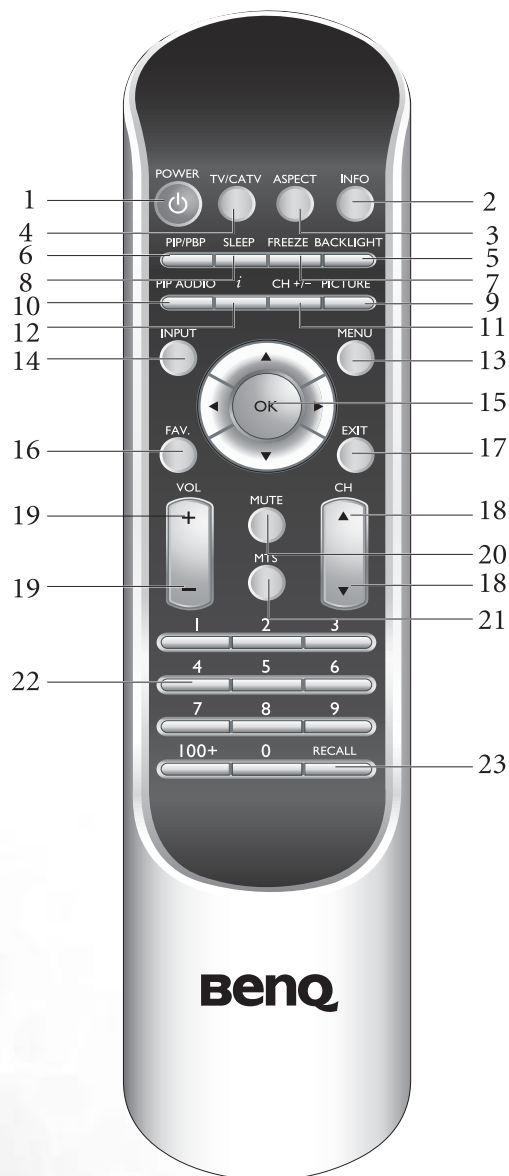

1. POWER

Press this button to power on the TV. Press it again to put the TV into standby mode.

2. INFO

Press this button to display the TV channel message and any other signal messages. Press the **EXIT** button (17) to turn the info off.

3. ASPECT

Press this button to adjust screen image aspect ratio.

4. TV/CATV

Press this button to switch between TV or cable tuner mode.

5. BACKLIGHT

Press this button to select the desired backlight level.

6. PIP/PBP

(Function not available. NOT SUPPORTED will appear on the screen if this button is pressed)

7. FREEZE

(Function not available. NOT SUPPORTED will appear on the screen if this button is pressed)

8. SLEEP

Press this button to set the automatic shut-off timer.

9. PICTURE

Press this button to select from among 4 user situation modes.

10. PIP AUDIO

(Function not available. NOT SUPPORTED will appear on the screen if this button is pressed)

11. CH +/- (add/erase)

Press this button to add the current TV channel to the sequential channel selection set. Press this button again to erase the current TV channel from the sequential channel set.

12. "i" key

(Function not available. NOT SUPPORTED will appear on the screen if this button is pressed)

13. MENU

Press this button to display the OSD (on-screen display) menu for adjusting the image, sound and functions. The function table allows you to use the **▶** or **◀** buttons to select items. Pressing this button again removes the OSD display.

14. INPUT

Press this button to select your desired input source.

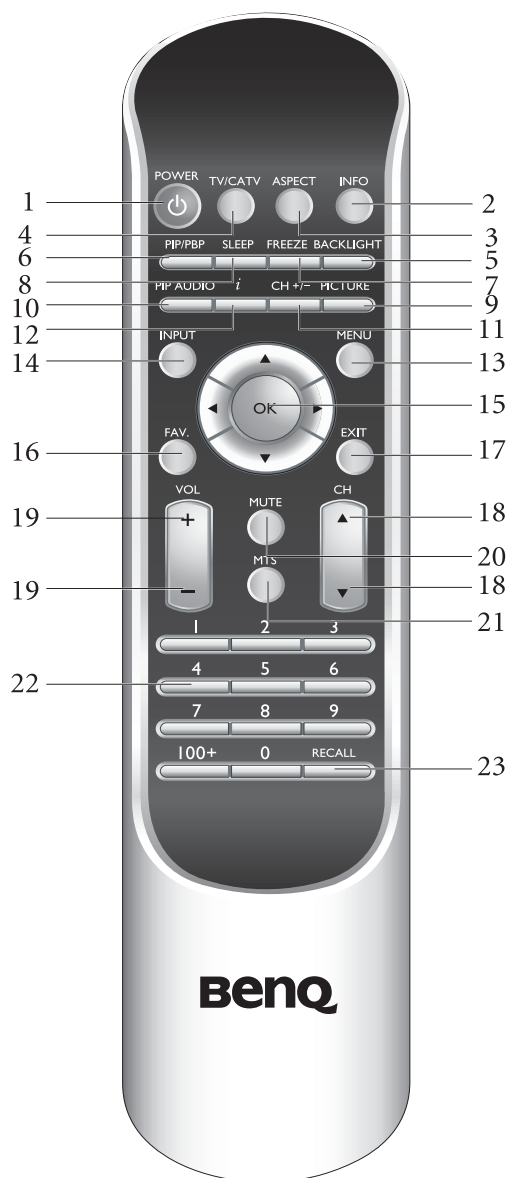

15. ▲/▼/▶/◀ and OK button

- ▲ ▼ : press the ▲ or ▼ buttons to select settings.
- ▶ ◀ : press the ▶ or ◀ buttons to adjust OSD menu settings.
- Press OK to execute selections, or to enter a submenu you have selected.

16. FAVORITE

Press this button to jump to one of the five favorite TV channels you have stored.

17. EXIT

When operating the on-screen display, press this button to return to the next higher menu level.

18. CH ▲/▼

Press this button to sequentially change channels.

19. VOL +/-

Press these buttons to raise or lower the volume level.

20. MUTE

Press this button to mute the sound output. Press it again to restore the sound output.

21. MTS (TV Sound Selection)

Press this button to toggle between stereo and mono sound reception.

22. Direct Channel select

Press these buttons to select the channel you wish to view.

23. RECALL

Press this button to toggle between the current and the previous channel you were viewing.

Using the Remote Control

When using the remote control, aim it at the remote control sensor window on the TV. If there is an object between the remote control and the signal remote control sensor window on the TV, the remote may not operate.

👉 **When using the remote control, please note:**

- **Do not strike or drop the remote. Do not expose the remote control to liquids and do not place it in humid environments.**
- **Do not install or place the remote control in direct sunlight. The heat may damage the remote control.**
- **If the remote control sensor window on the TV is in direct sunlight or strong light, the remote control may not operate normally. In this situation, change the light source or readjust the angle of your TV, or operate the remote control from a location closer to the remote control sensor window on the TV.**

Batteries

You will need to install the supplied batteries into the remote control to make it operate following the instructions below.

1. Open the lid of the remote control battery compartment.

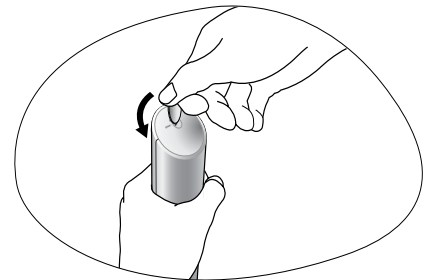

2. Insert two size-AAA batteries (included).

Ensure that the batteries are inserted with the positive and negative terminals in the correct direction corresponding to the (+) and (-) marks in the battery compartment.

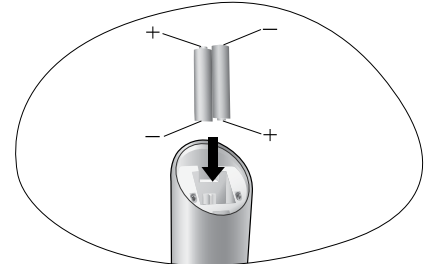

3. Close the lid of the remote control battery compartment.

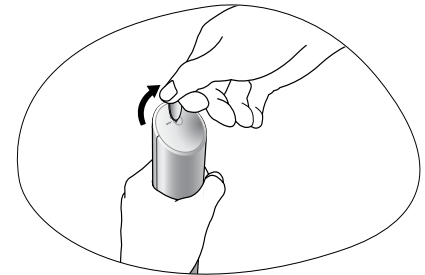

Notes on Using Batteries

The use of the wrong type of batteries may cause chemical leaks and/or explosion. Please note the following:

- Always ensure that the batteries are inserted with the positive and negative terminals in the correct direction as shown in the battery compartment.
- Different types of batteries have different characteristics. Do not mix different types.
- Do not mix old and new batteries. Mixing old and new batteries will shorten battery life and/or cause chemical leaks from the old batteries.
- When batteries fail to function, replace them immediately.
- Chemicals which leak from batteries may cause skin irritation. If any chemical matter seeps out of the batteries, wipe it up immediately using a dry cloth.
- Due to varying storage conditions, the battery life for the batteries included with your TV may be shortened. If the remote control is not used for a long period of time, remove the batteries.

6 Using the Remote Control

Power on, Power off and Standby



Turning on the TV

1. After the power cord is plugged into a wall outlet, the TV will turn on and enter standby mode automatically, and the power indicator will light up in red.
2. Press the  button on the TV, or press the **POWER** button on the remote control. The TV will turn on, and the power indicator will light up in green.
3. The TV will automatically search for a signal. If the set is already connected to a signal source, the TV will display that signal.

Turning off the TV

Press the  button on the TV again, or press the **POWER** button on your remote control again, and the TV will go into standby mode. (The power indicator will turn red).

Switching Inputs

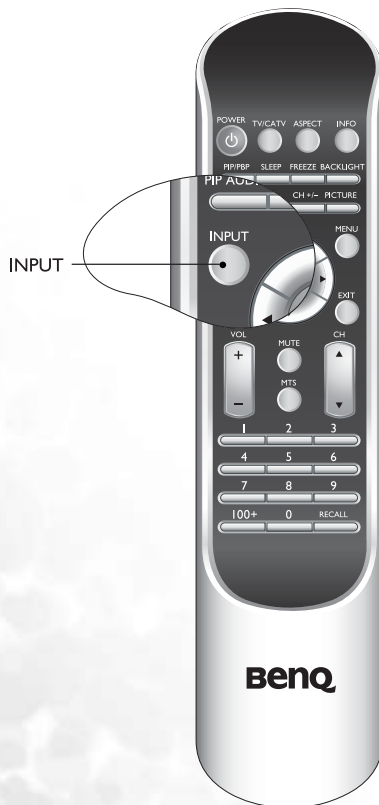

1. Turn on all connected equipment.
2. Press the **INPUT** button on your TV or press the **INPUT** button on your remote control to select input signal.

Press the input button repeatedly until your desired input is displayed. The sequence is as follows- TV, VIDEO, Y CB/PB CR/PR, TV, VIDEO...

Adjusting Audio

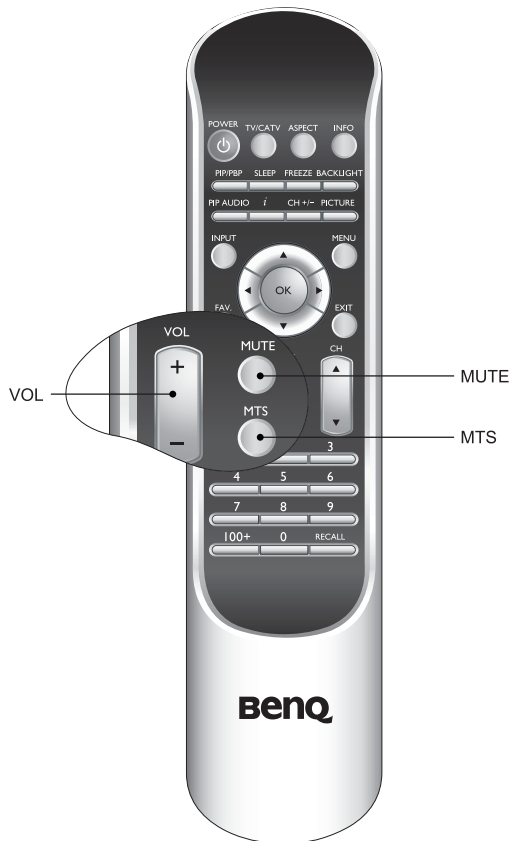

Adjusting the volume

1. Press the **VOL ▲** button on your TV or press the **VOL +** button on your remote to increase volume. The volume indicator will increase in length as volume rises.
2. Press the **VOL ▼** button on your TV, or press the **VOL -** button on your remote to decrease volume. The volume indicator will decrease in length as volume falls.

Mute setting

1. Press the **MUTE** button on your remote control to temporarily cut off the sound.
2. Press the **MUTE** button once more, or press the **Volume** or **Power** button on your TV or the remote control to restore the sound level.

MTS (TV Sound selection)

Press the **MTS** button on your remote control to toggle among "Stereo", "SAP (Second Audio Program)", or "Mono" reception.

Changing Channels

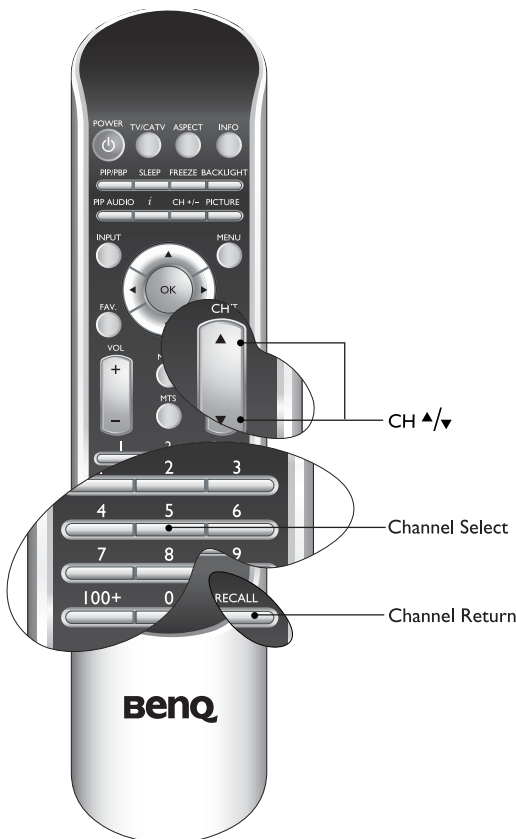

Using the Channel selection buttons on the Remote Control to Change Channels

- To select a single- or double-digit channel, press the corresponding channel selection buttons on the remote control. For example, to select channel 8, press the "0" and "8" channel selection buttons on the remote control.
- To select a triple-digit channel, press the **100+** button on the remote control followed by the rest of the digits. For example, to select channel 102, press the **100+** button, and then press the "0" and "2" buttons on the remote control.

Using the CH ▲/▼ buttons to sequentially change channels

Press **CH▲** or **CH▼** on your remote control, or press **CH▲** or **CH▼** on the TV to sequentially select the TV channels available in your area.

Using the channel button to return to the previous channel.

To return to the previous viewed channel, press the **RECALL** button **RECALL** on your remote control.

Adjusting User Situation Modes

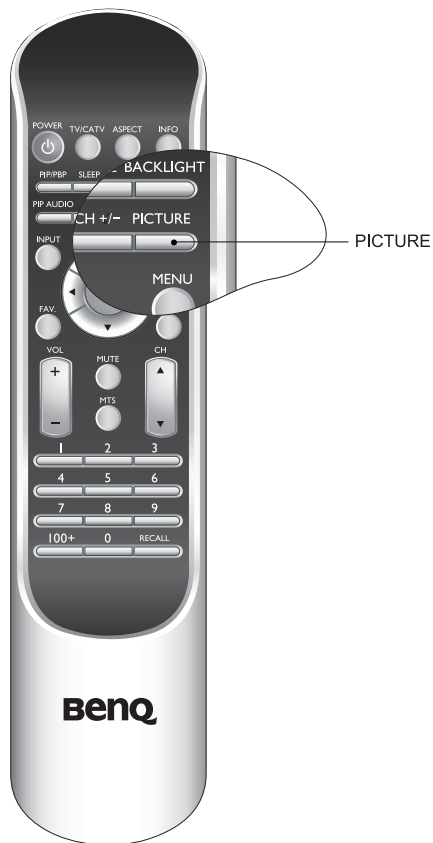

To change the user situation mode, press the **PICTURE** button on the remote control. This enables you to select from the preset memory settings (VIVID, STANDARD MODE, MOVIE MODE, SPORTS MODE and PERSONAL MODE).

Adjusting Aspect Ratio



Press the **ASPECT** button on your remote control to select the image aspect ratio you prefer. Press the button several times to cycle through various ratios.

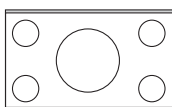

• **16:9** - For viewing 16:9 aspect ratio programs.

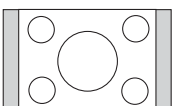

• **4:3** - For Viewing standard TV programs in correct image format.

Going to Favorite Channels

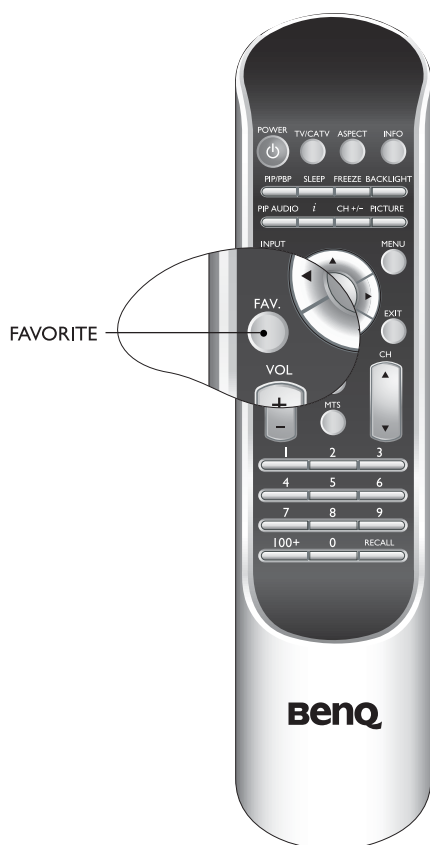

1. Press the **FAVORITE** button on your remote control to jump to your preset favorite channel memory.
2. Press the **FAVORITE** button again to jump to the next favorite channel memory, and so on. You may select from up to 5 channels to set as your favorites.

 For more information about how to set up favorite channels, please refer to "Setting up Favorite Channels" on page 25.

Selecting TV or CATV Input



Your television is equipped with a dual band tuner. If you live in an area that receives Cable Television press the **TV/CATV** button to change the tuning band from TV to CATV.

Adding/Deleting Sequential Channels



The CH +/- button allows you to alter the channels appearing in the Sequential Channel change memory.

When AUTO PROGRAM (see "TV Menu" on page 25) is complete use the CH +/- button to remove unwanted channels that may have been detected. The CH +/- button can also be used to add additional channels to the sequential channel memory.

Using the Sleep Timer

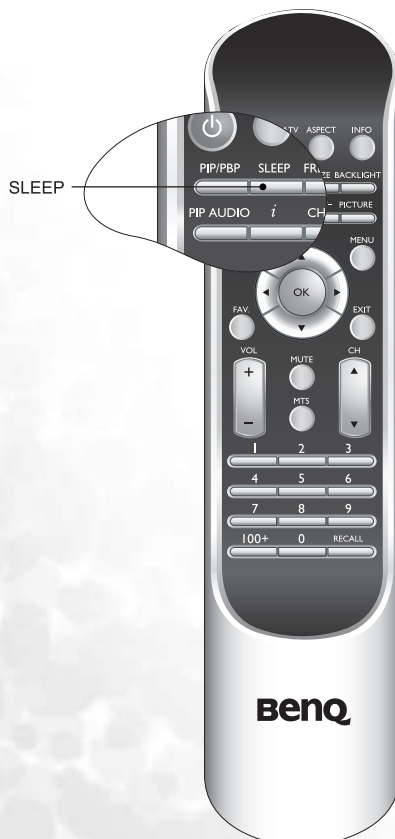

Press the **SLEEP** button on your remote control to start setting the automatic sleep timer. Press the **SLEEP** button several times to adjust the time in increments of 30 minutes, from 0 to 180 minutes.

Adjusting Backlight



To adjust the intensity of your TV's backlight, press the **BACKLIGHT** button on your remote control to select "Dark" "Normal" or "Bright".

Display Information



Press the **INFO** button on your remote control to display the signal information, including input video signal source, Video format, TV sound and current selected channel.

7 The On-Screen Display (OSD) Menu

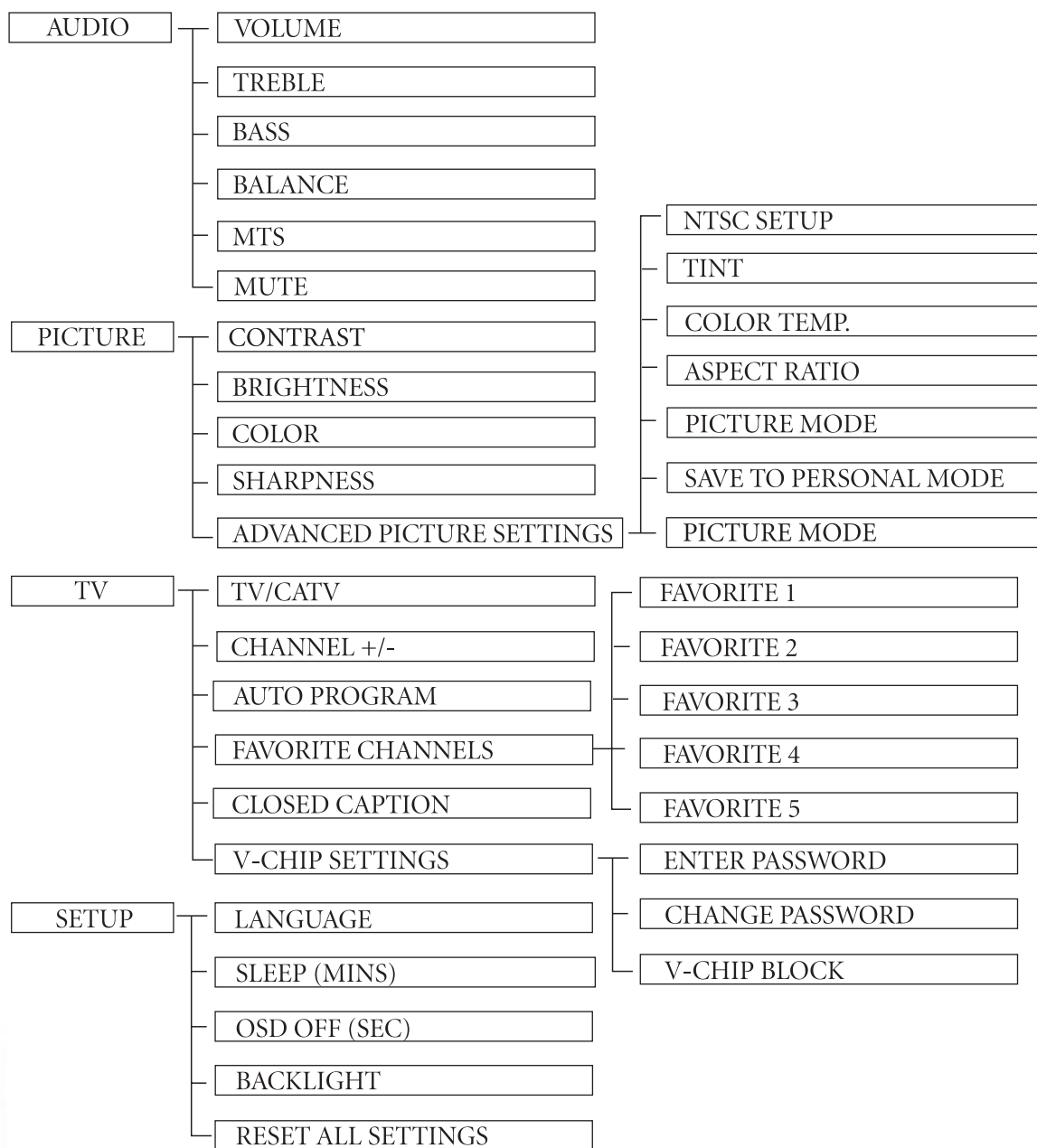

How to Use the OSD Menu

You can use the OSD menu screen to adjust all the settings on your TV. Follow the steps outlined below to select the function you desire, and refer to the pages indicated for more information.

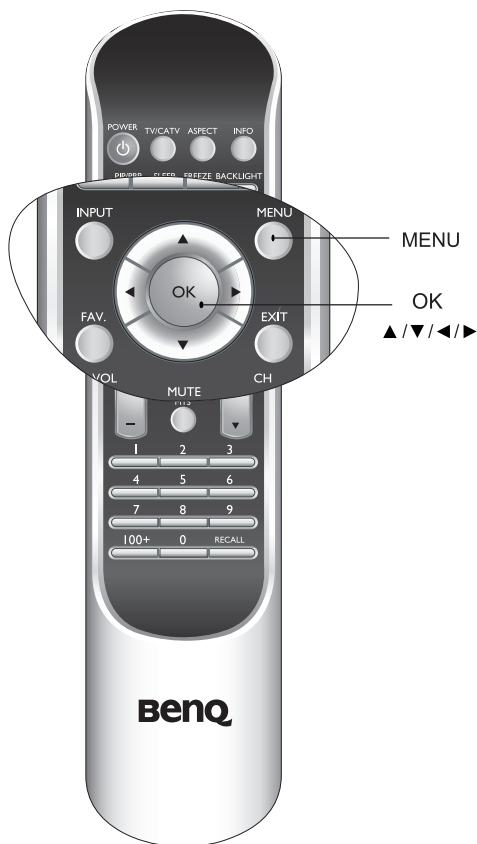

Press the **MENU** button on your remote control, or the **MENU** button on your TV to bring up the following main menu on your screen:

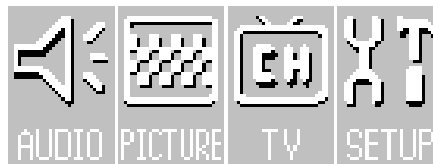

- Press the **◀**, **▶**, **▲** or **▼** buttons on the remote control, or the **CH ▲**, **CH ▼**, **VOL ▲** or **VOL ▼** buttons on the TV to select items on the main menu, choose functions or change settings.
- Press the **OK** button on the remote control, or the **INPUT** button on the TV to enter the submenu.
- Press the **EXIT** button on the remote control to return to the upper layer of menu.
- Press the **MENU** button on the remote control, or the **MENU** button on your TV to exit from the main menu.

☞ **For more information about the OSD menus, please refer to the following pages:**

- "AUDIO Menu" on page 22
- "PICTURE Menu" on page 23
- "TV Menu" on page 25
- "SETUP Menu" on page 30

AUDIO Menu

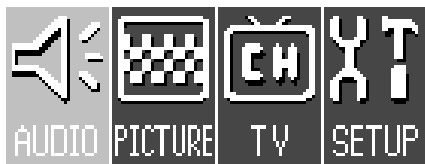

■ AUDIO MENU

VOLUME		23
TREBLE		00
BASS		00
BALANCE		00
MTS	MONO	
MUTE	NO	

ENTER: ENTER; ^ v: SELECT; <>: ADJUST

1. Press the **MENU** button on the remote control or the **MENU** button on the TV to display the main menu.
2. Press the **◀** or **▶** buttons to select **AUDIO** and then press the **OK** button to enter the submenu.
3. Press the **▲** or **▼** buttons to select an item.
4. In the **AUDIO** menu, use the **◀** or **▶** buttons to adjust the setting or select the options.

Item	Function	Operation	Range
VOLUME	Adjust volume level.	Use ▶ to increase and ◀ to decrease volume.	0 to 47
TREBLE	Adjust treble tones.	Use ▶ to increase treble, ◀ to decrease treble.	-7 to +7
BASS	Adjust bass tones.	Use ▶ to increase bass, ◀ to decrease bass.	-7 to +7
BALANCE	Adjust left and right levels.	Use ▶ to increase right volume, ◀ to increase left volume.	-12 to +12
MTS	Select TV audio.	Use the ▶ and ◀ buttons on the remote control or the VOL ▲ and VOL ▼ keys on the TV to change selection.	STEREO, SAP, MONO
MUTE	Mute the sound.	Use the ▶ and ◀ buttons on the remote control or the VOL ▲ and VOL ▼ keys on the TV to change selection.	NO, YES

PICTURE Menu

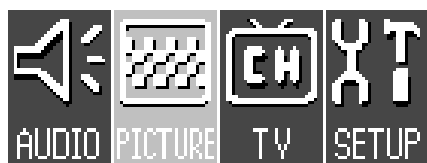

■ PICTURE MENU

CONTRAST	██████████	16
BRIGHTNESS	██████████	30
COLOR	██████████	32
SHARPNESS	██████████	04
ADVANCED PICTURE SETTINGS >		

ENTER: ENTER; ^ v: SELECT; < >: ADJUST

1. Press the **MENU** button on the remote control or the **MENU** button on the TV to display the main menu.
2. Press the **◀** or **▶** buttons to select **PICTURE** and then press the **OK** button to enter the submenu.
3. Press the **▲** or **▼** buttons to select an item.
4. In the **PICTURE** menu, use the **◀** or **▶** buttons to adjust the setting or select the options.

Item	Function	Operation	Range
CONTRAST	Adjust image contrast.	Use ▶ to increase contrast, or ◀ to reduce it.	0 to 32
BRIGHTNESS	Adjust image black level.	Press ▶ for brighter screen, ◀ for darker screen.	0 to 60
COLOR	Adjust color saturation.	Press ▶ for higher saturation, ◀ for lower saturation.	0 to 64
SHARPNESS	Adjust the sharpness level of the image.	Press ▶ for a sharper image, ◀ for softer image.	0 to 7
ADVANCED PICTURE SETTINGS - Press OK to access the following options.			
NTSC SETUP	Adjust the black level in NTSC video. Select 7.5 IRE if you are using the TV in the US.	Use the ◀ and ▶ buttons on the remote control or the VOL ▲ and VOL ▼ keys on the TV to select it.	0, 7.5 IRE
TINT	Adjust color tint.	Press ▶ for greener tones, ◀ for redder tones.	0 to 30
COLOR TEMP.	Adjust the tint of the black and white part of the image.	Use the ◀ and ▶ buttons on the remote control or the VOL ▲ and VOL ▼ keys on the TV to select your desired setting.	<ul style="list-style-type: none"> • WARM: Biased toward red • NORMAL: Standard video/TV color temperature • COOL: Biased toward blue
ASPECT RATIO	Adjust image aspect ratio.	Use the ◀ and ▶ buttons on the remote control or the VOL ▲ and VOL ▼ keys on the TV to select it.	<ul style="list-style-type: none"> • 4:3: For Viewing standard TV programs in correct image format. • 16:9: For viewing 16:9 aspect ratio programs.
SAVE TO PERSONAL MODE	Save current picture settings to personal mode.	See "Saving Picture Settings to Personal Mode" on page 24.	NO/YES
PICTURE MODE	Select a picture mode.	Use the ◀ and ▶ buttons on the remote control or the VOL ▲ and VOL ▼ keys on the TV to select it.	VIVID, STANDARD MODE, MOVIE MODE, SPORTS MODE, PERSONAL MODE

 **The brightness adjustment allows you to correctly set the black areas of the image to be just black. Detail in the dark areas of the image will be lost if the brightness is set too low.**

Saving Picture Settings to Personal Mode

1. Press the **MENU** button on the remote control or the **MENU** button on the TV to display the main menu.
2. Press the ◀ or ▶ buttons to select **PICTURE** and then press the **OK** button to enter the submenu.
3. Use the picture setting options (**BRIGHTNESS**, **CONTRAST**, **COLOR...**, etc.) to set up picture to your satisfaction.
4. Press the ▲ or ▼ buttons to select **ADVANCED PICTURE SETTINGS** and then press the **OK** button to enter the submenu.
5. Press the ▲ or ▼ buttons to select **SAVE TO PERSONAL MODE** and then press the **OK** button.
6. Press the ▲ or ▼ buttons to select **YES** and then press the **OK** button.

TV Menu

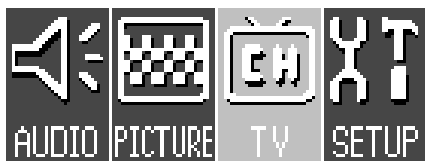

■ TV MENU

TV/CATV	CATV
CHANNEL +/-	ADDED
AUTO PROGRAM	
FAVORITE CHANNELS >	
CLOSED CAPTION	CC OFF
V-CHIP SETTINGS >	

ENTER: ENTER; ^ v: SELECT; < >: ADJUST

1. Press the **MENU** button on the remote control or the **MENU** button on the TV to display the main menu.
2. Press the **◀** or **▶** buttons to select **TV** and then press the **OK** button to enter the submenu.
3. Press the **▲** or **▼** buttons to select an item.
4. In the **TV** menu, use the **◀** or **▶** buttons to adjust the setting or select the options.

Item	Function	Operation	Range
TV/CATV	Select TV or Cable TV tuner mode.	Use the ◀ and ▶ buttons on the remote control or the VOL ▲ and VOL ▼ keys on the TV to change selection.	TV, CATV
CHANNEL +/-	Add weak or additional channels or delete unwanted channels from TV memory.	Use the ◀ and ▶ buttons on the remote control or the VOL ▲ and VOL ▼ keys on the TV to change selection.	SKIPPED, ADDED
AUTO PROGRAM	Tuner will search through all available channels and add them to the sequential channel memory.	Press OK on the remote control or INPUT on the TV to begin search.	
FAVORITE CHANNELS	Set or change favorite channels.	See "Setting up Favorite Channels" below.	FAVORITE 1, 2, 3, 4, 5
CLOSED CAPTION	Adjust Closed Caption setting.	See "Setting up Closed Caption" on page 26.	CC1, CC2, CC3, CC4, T1, T2, T3, T4, OFF
V-CHIP SETTINGS	Adjust V-CHIP setting.	See "Setting up V-CHIP" on page 26.	

Setting up Favorite Channels

1. Select the channel you want you want to set as the favorite channel.
2. Press the **MENU** button on the remote or the **MENU** key on the TV to display the main menu.
3. Press the **◀** or **▶** buttons to select **TV** and then press **OK** to enter the submenu.
4. Press the **▲** or **▼** buttons to select **FAVORITE CHANNELS** and then press **OK**.
5. Press the **▲** or **▼** buttons to select a favorite channel number (FAVORITE 1, FAVORITE 2..., FAVORITE 5) and then press **OK**.

Setting up Closed Caption

This TV is equipped with an internal Closed Caption decoder. Closed Caption is a system which allows conversations, narration, and sound effects in TV programs and home videos to be viewed as captions on the TV screen. Not all the programs and videos will offer closed captioning. Please look for the  symbol to ensure that captions will be shown.

1. Press the **MENU** button on the remote or the **MENU** key on the TV to display the main menu.
2. Press the **◀** or **▶** buttons to select **TV** and then press **OK** to enter the submenu.
3. Press the **▲** or **▼** buttons to select **CLOSED CAPTION**.
4. Press **OK** to enter the sub menu, and then choose between available choices for the selected option.

-  • **Closed Caption may malfunction (white blocks, strange characters, etc.) if signal conditions are poor or if there are problems at the broadcast source. This does not necessarily indicate a problem with your TV.**
- **If no TEXT broadcast is being received while viewing in the [TEXT] mode, the screen may become dark and blank for some programs. Should this occur, switch the Closed Caption mode to OFF.**
- **Close caption will disappear temporarily when the OSD menu is displayed on the screen.**

Setting up V-CHIP

This function allows TV programs to be restricted and TV usage to be controlled based on FCC data. It prevents children from watching violent or sexual scenes that may be harmful.

Restriction of TV programs includes two ratings that contain information about the program: the Movie Ratings and the TV Ratings. The Movie Ratings are restricted by age. TV Ratings are restricted by age and content.

Since a TV program may use either the Movie Ratings or the TV Ratings, both should be adjusted for complete control.

Movie Ratings

Ratings		
Age Base	G	GENERAL AUDIENCES. All ages admitted.
	PG	PARENTAL GUIDANCE SUGGESTED. Some material may not be suitable for children.
	PG-13	PARENTAL STRONGLY CAUTIONED. Some material may be inappropriate for children under 13.
	R	RESTRICTED. Under 17 requires accompanying parent or adult guardian.
	NC-17	NO ONE 17 AND UNDER ADMITTED.
	X	X is an older rating that is unified with NC-17 but may be encoded in the data of older movies.:

Movie Ratings (examples)

Example 1

PG-13 in the age-based rating is blocked, this will also automatically block the higher ratings R, NC-17 and X.

Example 2

R in the age-based rating is blocked, this will also automatically block the higher ratings NC-17 and X.

-  **The Movie Ratings are only age-based.**

TV Ratings

USA TV Ratings

	Rating	Content Base
Age Base	Y (All children)	The program is designed to be appropriate for all children.
	Y7 (Direct to Older Children)	The program is designed for children age 7 and above. It may be more appropriate for children who have acquired the developmental skills needed to distinguish between make-believe and reality.
	Y7FV (Directed to Older Children - Fantasy Violence)	For those programs where fantasy violence may be more intense or more combative than other programs in this category, such programs will be designated TV-Y7-FV.
	G (General Audience)	Most parents would find The program suitable for all ages. Although this rating does not signify a program designed specifically for children, most parents may let younger children watch this program unattended.
	PG (Parental Guidance Suggested)	The program contains material that parents may find unsuitable for younger children. Many parents may want to watch it with their younger children.
	14 (Parents Strongly Cautioned)	The program contains some material that many parents would find unsuitable for children under 14 years of age. Parents are strongly urged to exercise greater care in monitoring this program and are cautioned against letting children under the age of 14 watch unattended.
	MA (Mature Audience Only)	The program is specifically designed to be viewed by adults and therefore may be unsuitable for children under 17.

Example

When Y7 in the age-based rating is set to BLOCK, this will automatically block the higher ratings: Y7FV, G, PG, 14 and MA. Choosing a lower age-based rating blocks the higher age-based ratings regardless of content rating settings.

Canadian English TV Ratings

Rating		Content base
Age Base	E (Exempt (no blocking))	Exempt programming includes: news, sports, documentaries and other information programming; talk shows, music videos, and variety programming.
	C (Children)	Programming intended for children with this designation must adhere to the provisions of the Children's section of the Canadian Association of Broadcasters (CAB) Voluntary Code on Violence in TV Programming.
	C8+ (Children, eight years and older)	This classification is applied to children's programming that is generally considered acceptable for youngsters 8 years and over to view on their own. It is suggested that a parent/guardian co-view programming assigned this classification with younger children under the age of 8.
	G (General Programming, suitable for all ages)	This is programming intended for a broad, general audience. While not designed specifically for children, it is understood that younger viewers may be part of the audience. Therefore programming within this classification shall contain very little violence, either physical, verbal or emotional.
	PG (Parental Guidance)	This programming, while intended for a general audience, may not be suitable for younger children (under the age of 8). Parents/guardians should be aware that there might be content elements which some could consider inappropriate for unsupervised viewing by children in the 8-13 age range.
	14+ (Viewers 14 years and older)	Programming with this classification contains themes or content elements which might not be suitable for viewers under the age of 14. Parents are strongly cautioned to exercise discretion in permitting viewing by pre-teens and early teens without parent/guardian supervision, as programming with this classification could deal with mature themes and societal issues in a realistic fashion.
	18+ (Adult Programming)	This classification applies to programming which could contain any or all of the following content elements which would make the program unsuitable for viewers under the age of 18.

Canadian French TV Ratings

Rating		Content base
Age Base	G (Général)	Cette émission convient à un public de tous âges. Elle ne contient aucune violence ou la violence qu'elle contient est minime, ou bien traitée sur le mode de l'humour, de la caricature, ou de manière irréaliste.
	8 ans+ (Général-Déconseillé aux jeunes enfants)	Cette émission convient à un public large mais elle contient une violence légère ou occasionnelle qui pourrait troubler de jeunes enfants. L'écoute en compagnie d'un adulte est donc recommandée pour les jeunes enfants (âgés de moins de 8 ans) qui ne font pas la différence entre le réel et l'imaginaire.
	13 ans + (Cette émission peut ne pas convenir aux enfants de moins de 13 ans)	Elle contient soit quelques scènes de violence, soit une ou des scènes d'une violence assez marquée pour les affecter. L'écoute en compagnie d'un adulte est donc fortement recommandée pour les enfants de moins de 13 ans.
	16 ans + (Cette émission ne convient pas aux moins de 16 ans)	Elle contient de fréquentes scènes de violence ou des scènes d'une violence intense.
	18 ans + (Cette émission est réservée aux adultes)	Elle contient une violence soutenue ou des scènes d'une violence extrême.

Adjusting V-Chip Setting

First-Time Setup

1. Press the **MENU** button on the remote or the **Menu** key on the TV to display the main menu.
2. Press the ◀ or ▶ buttons to select **TV** and then press **OK** to enter the submenu.
3. Press the ▲ or ▼ buttons to select **V-CHIP SETTINGS** and then press **OK** to enter the submenu.
4. Press the ▲ or ▼ buttons to select **OK PASSWORD**, and then press the **OK** button.
5. Enter a 4-digit password (the factory-preset password is 2468) and press **OK** to access V-CHIP Block Settings.

Movie Ratings

1. After the password is entered, press the ▲ or ▼ buttons to select **MOVIE RATINGS**.
2. Use the ◀ or ▶ buttons to switch between available choices for the selected option.

TV Ratings

Setting up Canadian English and Canadian French TV Ratings

1. After the password is entered, press the ▲ or ▼ buttons to select **CAN EN TV. RAT** or **CAN FR TV. RAT**.
2. Use the ◀ or ▶ buttons to select a rating.

Setting up USA TV Ratings

1. After the password is entered, press the ▲ or ▼ buttons to select **USA TV RATINGS** and then press the **OK** button.
2. Use the ▲ or ▼ buttons to select a rating, and then press the ▲ or ▼ buttons to select **BLOCK** or **SHOW**.

Canceling the V-CHIP Block Screen While V-CHIP Block is Activated

1. "**The program is blocked**" will appear on the screen if you watch a program that matches the rating data you configured.
2. Enter the 4-digit password by using the channel selection keys. V-CHIP Block will be temporarily canceled. If an incorrect password is entered, it cannot be unblocked.

Changing V-CHIP Blocking Password

1. Press the **MENU** button on the remote or the **Menu** key on the TV to display the main menu.
2. Press the ◀ or ▶ buttons to select **TV** and then press the **OK** button to enter the submenu.
3. Press the ▲ or ▼ buttons to select **V-CHIP SETTINGS** and then press the **OK** button to enter the submenu.
4. Press the ▲ or ▼ buttons to select **CHANGE PASSWORD**, and then press the **OK** button.
5. Enter the old password and then press the **OK** button.
6. Enter the new password and then press the **OK** button.
7. You will be prompted to enter the new password again. Enter the new password and then press the **OK** button. Now you have successfully changed the V-CHIP Blocking password.

SETUP Menu

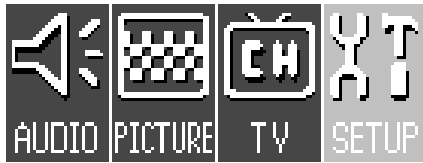

■ SETUP MENU

LANGUAGE	ENGLISH
SLEEP(MINS)	000
OSD OFF(SEC)	020
BACKLIGHT	BRIGHT
RESET ALL SETTINGS	

ENTER: ENTER; ▲▼: SELECT; <>: ADJUST

1. Press the **MENU** button on the remote control or the **Menu** key on the TV to display the main menu.
2. Press the ◀ or ▶ buttons to select **SETUP** and then press **OK** to enter the submenu.
3. Press the ▲ or ▼ buttons to select an item.
4. In the **SETUP** menu, after selecting the desired option, and pressing **OK**, use the ◀ or ▶ buttons to adjust the setting or select the options.

Item	Function	Operation	Range
LANGUAGE	Select language for the OSD menu.	Use the ◀ and ▶ buttons on the remote control or the VOL ▲ and VOL ▼ keys on the TV to change selection.	ENGLISH, FRANÇAIS ESPAÑOL
SLEEP (MINS)	Set Sleep to automatically turn TV off.	Use the ◀ and ▶ buttons on the remote control or the VOL ▲ and VOL ▼ keys on the TV to select different setting values.	0, 30, 60, 90, 120, 150, 180
OSD OFF (SEC)	Set the duration of the OSD menu.	Use the ◀ and ▶ buttons on the remote control or the VOL ▲ and VOL ▼ keys on the TV to select different setting values.	5 to 60 seconds
BACKLIGHT	Adjust backlight intensity.	Use the ◀ and ▶ buttons on the remote control or the VOL ▲ and VOL ▼ keys on the TV to change selection.	DARK, NORMAL, BRIGHT
RESET ALL SETTINGS	Restore all settings to default values.	Press the OK button on the remote control or the INPUT button on the TV to execute it.	NO, YES

8 Troubleshooting

Before calling a service center, attempt the following steps to diagnose the problem.

TV

Symptoms	Possible Causes
Power does not turn ON	Ensure the power plug is securely inserted into the receptacle and wall socket.
There is no picture or sound	<ul style="list-style-type: none"> • Ensure the television power is ON (Indicated by the green LED on the front of the unit) • Try a different input source to check whether the source is at fault. • Check for mis-connection of cables or for wrong input source.
There are spots on the screen	Your TV is being affected by interference from automobiles, trains, high-voltage transmission lines, neon signs or another sources of interference. Try redirecting or relocating your antenna to reduce the affects of the interference.
Degraded colours or tints	<ul style="list-style-type: none"> • Check whether all the picture adjustments have been properly performed. • Press the "PICTURE" button on the remote control to select a different picture set-up.
Improper screen position or size	Try selecting a different aspect ration by pressing the "ASPECT" button on the remote control.
The image appears distorted	Ensure the television's aspect ratio is correctly set to suit the program source.
The image appears too bright, and there is a loss of definition in the brightest areas of the image.	<ul style="list-style-type: none"> • Reduce the contrast setting. • The DVD player is set for a high-level output. • The AV video signal has not been terminated properly somewhere in the external AV equipment.
The image appears too 'washed out', or the darkest areas of the image appear too bright.	<ul style="list-style-type: none"> • Reduce the brightness level till the black areas of the picture appear as black. • The DVD player may be set at too high a brightness level.
"Out of range" appears	<ul style="list-style-type: none"> • Check whether the input signal is acceptable to the display.
Remote control does not function properly	<ul style="list-style-type: none"> • Check for incorrect battery orientation. • Check for dead batteries • Check your distance and angle from the television. • Check whether remote control is properly being pointed at the television's remote control sensor window. • Check for any obstacle between the remote control and the remote control sensor window. • Check that the remote control sensor window is not under strong fluorescent lighting.
There is no picture or sound, just noise.	<ul style="list-style-type: none"> • Make sure the antenna cable is properly connected. • Change channels to confirm if the symptom is still present.
Picture is not clear.	<ul style="list-style-type: none"> • Make sure the antenna cable is properly connected. • Change channels to confirm if the symptom is still present.

No sound.	<ul style="list-style-type: none"> • Check whether you have selected Mute for Audio setting. • Make sure the volume is not set to minimum. • Check the AV cables for disconnection.
-----------	--

Antenna

Symptoms	Possible Causes
The picture is not sharp or the picture moves contains image movement.	<ul style="list-style-type: none"> • The reception may be weak. • Change channels to confirm if the symptom is still present. • Make sure the outside antenna is not disconnected. • Make sure the antenna is facing the right direction.
The picture is doubled or tripled	<ul style="list-style-type: none"> • Make sure the antenna is facing the right direction. • Picture ghosting is caused by reflections from buildings, large metal structures and mountains. Carefully realign your antenna to minimise the ghost images. Ultimately a higher quality antenna professionally installed may be necessary to reduce the ghosting.
The picture is spotted	<ul style="list-style-type: none"> • There may be interference from automobiles, trains, high voltage lines, neon lights, etc. • There may be interference between the antenna cable and power cable. Try positioning them further apart.
There are stripes on the screen or colours fade	<ul style="list-style-type: none"> • Is the television receiving interference from other devices? Transmission antennas of radio broadcasting stations and transmission antennas of amateur radios and cellular phones may also cause interference. • Use the television as far away as possible from devices that may cause possible interference.

Specifications

Model		DV2050
Size		20.1 inches
Aspect ratio		4:3, 16:9
Resolution		800 x 600
Pitch		0.51 (H) x 0.51 (V) mm
Brightness		500 nit
Contrast ratio		500:1
Response time		16 ms
Speaker		5W x 2
Signal inputs	TV	TV tuner x1
	Video	AV in (RCA pin) x 1 S-VIDEO (Mini din 4 pin) x 1 Component (RCA pin) x1 Audio in (L/R, RCA pin) x 2
Signal outputs		Audio out (L/R, RCA pin) x 1
Video System		NTSC
Scan modes		1080i, 720p, 576p, 480p, 480i
Power supply		AC 100-240 V, 50/60 Hz

 Design and specifications are subject to change without notice.

10 Dimensional Drawings

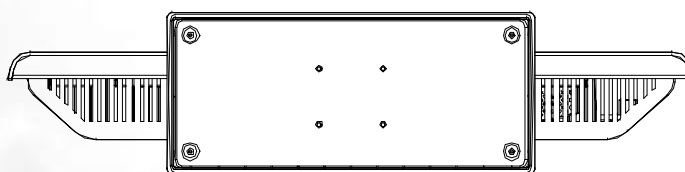
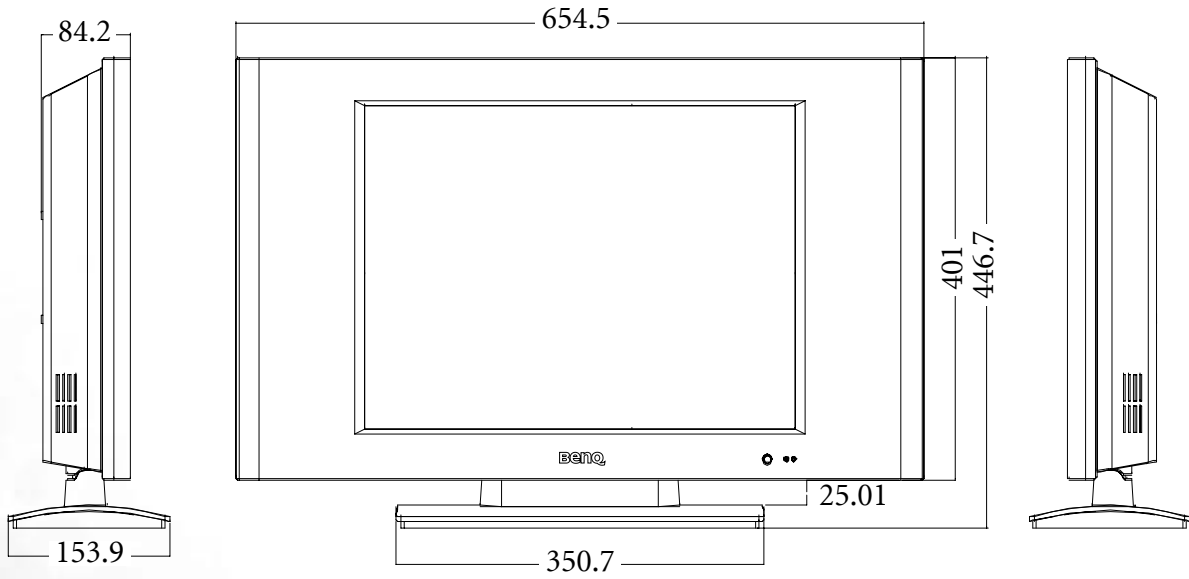
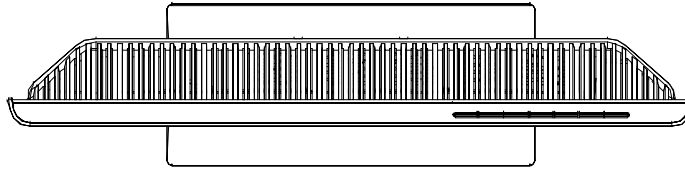
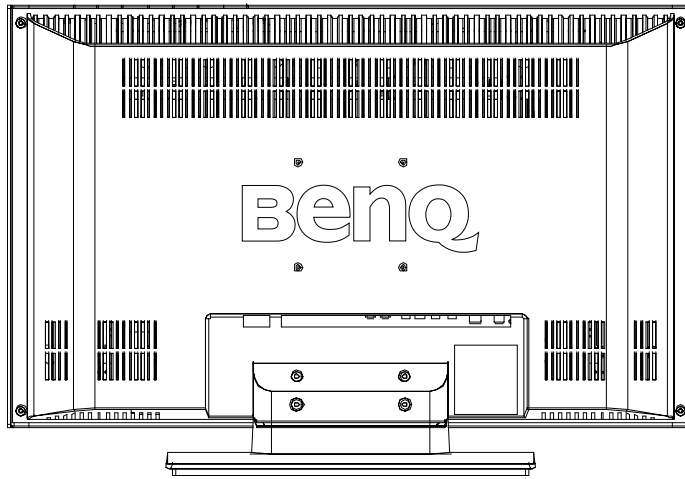

Unit: mm

Free Manuals Download Website

<http://myh66.com>

<http://usermanuals.us>

<http://www.somanuals.com>

<http://www.4manuals.cc>

<http://www.manual-lib.com>

<http://www.404manual.com>

<http://www.luxmanual.com>

<http://aubethermostatmanual.com>

Golf course search by state

<http://golfingnear.com>

Email search by domain

<http://emailbydomain.com>

Auto manuals search

<http://auto.somanuals.com>

TV manuals search

<http://tv.somanuals.com>