



# Big Green<sup>®</sup>

DEEP CLEANER

## USER'S GUIDE

### 1672 SERIES

3 Safety Instructions

4 Product View

5-6 Assembly

6-11 Operations / Special Tools

12 Maintenance

13 Troubleshooting

14 Replacement Parts

15 Consumer Services

16 Warranty



Thanks for buying a BISSELL Big Green®

We're glad you purchased a BISSELL Big Green® multi-purpose deep cleaner. Everything we know about floor care went into the design and construction of this complete, high-tech home cleaning system.

Your Big Green is well made, and we back it with a limited two-year warranty. We also stand behind it with a knowledgeable, dedicated Consumer Services department, so, should you ever have a problem, you'll receive fast, considerate assistance.

My great-grandfather invented the floor sweeper in 1876. Today, BISSELL is a global leader in the design, manufacture, and service of high quality homecare products like your Big Green.

Thanks again, from all of us at BISSELL.

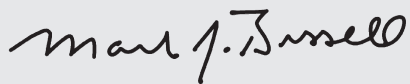

Mark J. Bissell  
President and Chief Executive Officer

# IMPORTANT SAFETY INSTRUCTIONS

**When using an electrical appliance, basic precautions should be observed, including the following:** Read all instructions before using your Big Green. Always connect to a properly grounded outlet. Unplug from outlet when not in use and before servicing.

**⚠️ WARNING:** To reduce the risk of electrical shock, use indoors only. Always install float before any wet cleaning operation.

- Do not leave machine when it is plugged in
- Do not service machine when it is plugged in
- Do not use with damaged cord or plug
- Do not use machine if it has been dropped, damaged, left outdoors or dropped into water
- Do not use outdoors
- Do not handle unit with wet hands
- Do not pull or carry by cord, use cord as a handle, close door on cord, pull cord around sharp corners or edges, run appliance over cord, or expose cord to heated surfaces
- Do not carry the appliance while in use
- Do not unplug by pulling on cord
- Do not handle plug or appliance with wet hands
- Do not use without ball and ball cage in place
- Do not use without dry filter bag or motor filter in place except when wet vacuuming or deep cleaning
- Do not put any object into appliance openings, use with blocked opening, or restrict air flow
- Do not expose hair, loose clothing, fingers or body parts to openings or moving parts
- Do not pick up hot or burning objects
- Do not pick up flammable or combustible materials (lighter fluid, gasoline, kerosene, etc.) or use in the presence of explosive liquids or vapor
- Do not use appliance in an enclosed space filled with vapors given off by oil base paint, paint thinner, some moth proofing substances, flammable dust, or other explosive or toxic vapors
- Do not pick up toxic material (chlorine bleach, ammonia, drain cleaner, gasoline, etc.)
- Do not modify the 3-prong grounded plug
- Do not allow to be used as a toy
- Do not use for any purpose other than described in this User's Guide
- Use dry filter bag and motor filter when dry vacuuming

- Use only manufacturer's recommended attachments
- Use only cleaning products formulated by BISSELL for use in this appliance.
- Keep openings free of dust, lint, hair, etc.
- Keep appliance on a level surface
- Turn off all controls before unplugging
- Unplug by grasping the plug, not the cord
- Be extra careful when cleaning stairs
- Pay close attention when working around children

**WARNING:** The Power Cord on this product contains lead, a chemical known to the State of California to cause birth defects or other reproductive harm.

**WASH HANDS AFTER HANDLING.**

**SAVE THESE INSTRUCTIONS FOR FUTURE USE.**

THIS MODEL IS FOR HOUSEHOLD USE ONLY.

**THIS APPLIANCE MUST BE GROUNDED WHEN IN USE.**

Grounding provides a safe path of resistance for electrical equipment, reducing the risk of shock should the appliance malfunction. The cord has an equipment-grounding conductor and a grounding plug. This three-prong plug must only be plugged into an outlet that is properly installed and grounded in accordance with all local codes and ordinances.

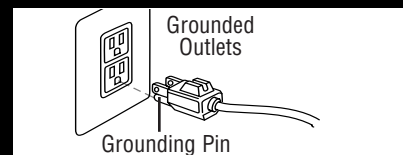

**⚠️ WARNING:** Improper connection of the equipment-grounding conductor can result in a risk of electrical shock. Check with a qualified electrician or service person if you aren't sure if the outlet is properly grounded. **DO NOT MODIFY THE PLUG.** If it will not fit the outlet, have a proper outlet installed by a qualified electrician. This appliance is designed for use on a nominal 120-volt circuit, and has a grounding attachment plug that looks like the plug in the drawing above. Make certain that the appliance is connected to an outlet having the same configuration as the plug. No plug adapter should be used with this appliance.

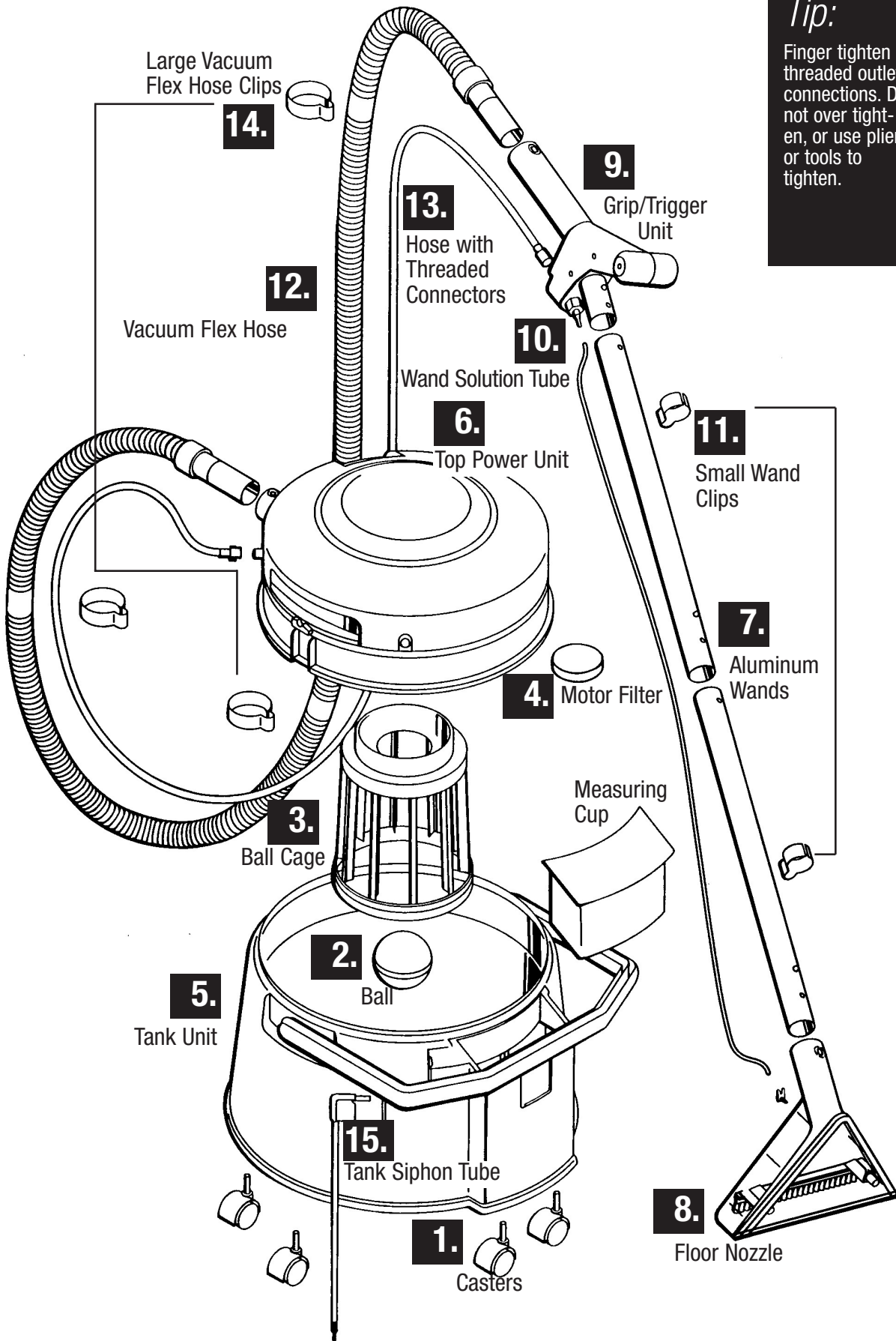

*Tip:*  
 Finger tighten threaded outlet connections. Do not over tighten, or use pliers or tools to tighten.

## How To Use This Guide

This User's Guide has been designed to help you get the most satisfaction from your BISSELL Big Green. You'll find assembly and operating instructions, safety precautions and pre-cleaning tips, as well as maintenance and troubleshooting instructions. Please read this Guide thoroughly before assembling your Big Green cleaner.

Pay particular attention to the product diagram, assembly instructions, and part names. Locate and organize all parts before assembly. Familiarize yourself with the parts and where they fit. Following this User's Guide will greatly enhance your ability to get the most performance from your BISSELL Big Green for many years.

### Tip:

Several parts are packed inside the collection tank/tank unit. Separate tank unit from top power unit to find these parts. Also, match the number on the written instructions to the number on the assembly picture to better understand each assembly step.

## How To Put It Together

- 1. Casters.** Locate 4 casters inside plastic packaging in collection tank. Turn tank unit upside down. Insert four casters and push until they snap into place.
- 2. Ball.** Place ball on raised area of recovery tank bottom.  
**NOTE: Ball may have an unusual color due to recycled high density polyethylene (HDPE) used in its manufacture.**
- 3. Ball Cage.** Position ball cage over ball and press cage firmly onto raised area.
- 4. Motor Filter.** Locate motor filter and insert it into cavity on the underside of the top power unit.
- 5. Tank Unit.** Flip carrying handle down over filling cavity on tank unit.
- 6. Top Power Unit.** Place top power unit on tank unit. **Twist top power unit until it drops into place on tank unit. Flip up carrying handle to lock units.**
- 7. Aluminum Wands.** Fit bottom wand section into top aluminum wand section. Latch button pops through hole to lock sections together.  
**NOTE: Wands are identical and interchangeable. Buttons must be on upper end of wands for proper assembly. Aluminum wands fit together snugly.**
- 8. Floor Nozzle.** Fit floor nozzle over bottom wand and lock with latch button.
- 9. Grip/Trigger Unit.** Fit grip/trigger unit into top wand lock with latch button.

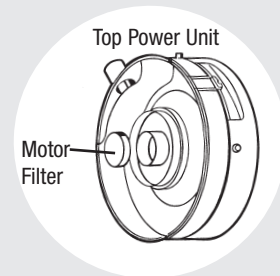
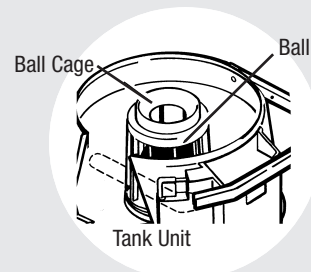

## How To Put It Together Continued

- 10. Wand Solution Tube.** Connect wand solution tube to spray tip on floor nozzle and to cap valve on grip/trigger unit.
- 11. Small Wand Clips.** Secure tube to wand with two small wand clips.
- 12. Vacuum Flex Hose.** Connect vacuum flex hose to grip/trigger unit and lock with latch buttons. Insert vacuum flex hose into inlet on top power unit and lock in place.
- 13. Hose with Threaded Connectors.** Attach hose with threaded connectors to threaded outlet on grip/trigger unit. Finger tighten only. Press hose into molded slot under grip/trigger unit. Attach other end to threaded outlet on power unit. Finger tighten only.
- 14. Vacuum Flex Hose Clips.** Hold vacuum flex hose and hose with threaded connectors together. Snap three large vacuum flex hose clips in place at three clip bands on flex hose.
- 15. Tank Siphon Tube.** Pull up tank siphon tube next to filling cavity on tank unit. Insert firmly into opening on power unit.

**Assembly is now complete.**

## Special Attachments For Every Job

See individual sections for proper usage of all accessories

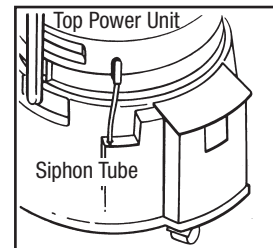
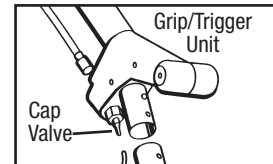
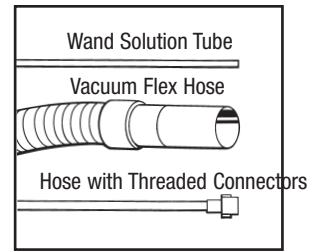

Make sure the power and tank units are properly aligned and locked with the carrying handle before pulling up siphon tube assembly and inserting it into power unit.

### For Wet/Deep Cleaning

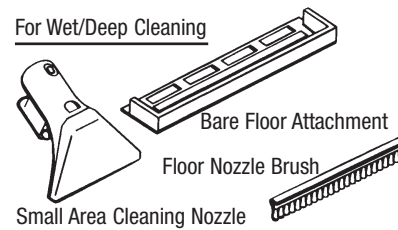

### For Dry Vacuuming

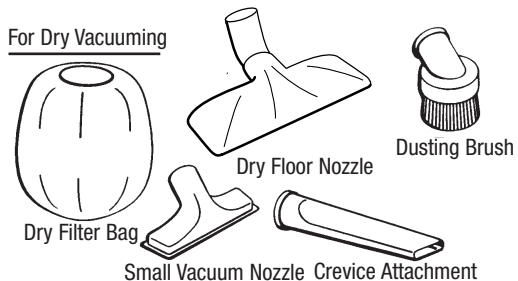

## How To Begin

### Deep Cleaning Carpet

1. Vacuum carpet (see page 10, HOW TO DRY VACUUM).
2. Decide where to begin — and end — your job. Clean in 3' X 4' sections, starting in areas farthest from exit. Plan to leave a path open to empty collection tank and replenish filling cavity.
3. Carpeting will dry in two to four hours, depending on carpet style and air circulation in room. A floor fan speeds drying.
4. Plan activities to give carpet time to dry.
5. Replace furniture on damp carpeting by placing waxed paper under legs until floor dries completely.

### Deep Cleaning Upholstery

1. Check manufacturer's tag before cleaning. "W" or "WS" on the tag means you can use your Big Green. If tag is coded with an "S" (with diagonal strike-through), or says "Dry Clean Only," do not proceed.
2. If manufacturer's tag is missing or not coded, check with your furniture dealer.
3. If possible, check upholstery stuffing. Colored stuffing may bleed through fabric when wet.

### Cleaning Bare Floors

1. The Big Green is not recommended for cleaning wood floors.
2. Use only Bissell® Floor Care cleaning solution on no-wax floors. Never use Bissell® Carpet Cleaner or other carpet cleaners on bare floors.
3. Sweep before starting.
4. Remove old wax before cleaning.
5. Leave an exit path.
6. Allow at least 1/2 hour drying time.

#### *Tip:*

Always vacuum before you clean. If possible, move large furniture aside. But if it's not possible to move your furniture, don't worry - your Big Green features a cleaning wand that easily maneuvers under and around furniture.

#### *Tip:*

Deep cleaning carpeting and upholstery regularly can reduce dust and allergens in your home.



# How To Deep Clean Carpet

## Getting Ready

1. Remove dry filter bag from ball cage.
2. Remove concentrate measuring cup from filling cavity on side of tank unit.
3. Pour two gallons of hot tap water (temperature should not exceed 120° F/48° C) **into filling cavity** until level reaches bottom of three vertical lines **in tank unit**.
4. Shake bottle of BISSELL Carpet Care. Fill measuring lid to fill line (10 ounces). Empty measuring lid into filling cavity and replace measuring lid.
5. Plug power cord into approved grounded outlet.

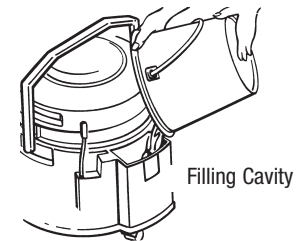
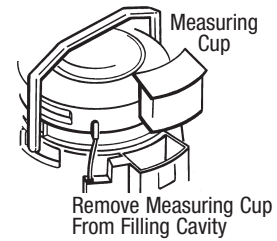

## Pre-treating

1. Pre-treat highly soiled areas: Press on pump/spray switch, hold floor nozzle 4" - 6" above soiled carpet, and pull trigger to spray cleaning solution.
2. Wait 5-10 minutes. Scrub tough stains with floor nozzle brush.



### Tip:

Use only BISSELL Carpet Care in this appliance. Use of cleaning formulas which contain lemon or pine oil may damage this appliance and void warranty.

## Deep Cleaning

1. Turn on pump/spray and vacuum/suction switches. Place floor nozzle directly on carpet at arm's length. Pull trigger to spray cleaning solution while pulling wand toward you.
2. Repeat, keeping floor nozzle firmly against carpet surface. Continue until no more dirt can be removed. **Do not overwet.**
3. Release spray trigger. **Vacuum area until no more cleaning solution can be removed.**
4. Continue to clean entire carpet, working in 3' x 4' sections.
5. If the machine loses suction, stops spraying and/or motor noise rises in pitch, empty the tank [see WHEN YOU'RE DONE, page 9]. Failure to empty tank will damage unit.
6. If floor nozzle stops spraying, turn off pump immediately and check cleaning solution level. **Never run pump dry.**

Vacuum/suction switch

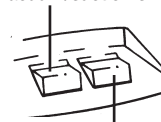

Pump/spray switch

### Tip:

Deep cleaning stairs and high traffic areas on a regular basis can prolong carpet life.



## When You're Done

1. Turn off pump/spray and vacuum/suction switches. Unplug from outlet.
2. Remove tank siphon tube, flip down carrying handle and lift top power unit from tank unit.
3. Carry tank unit to a toilet or sink to empty. With carrying handle in one hand, place other hand in gripping slot under filling cavity on tank unit. Lift and pour to empty.
4. Make sure ball and ball cage are firmly seated on raised area. Replace power unit and lock in place with carry handle.
5. See PUTTING IT AWAY on page 12.

## How To Clean Upholstery And Small Areas

### Getting Ready

1. Disconnect wand solution tube and aluminum wands from grip/trigger unit.
2. Moisten O-ring at base of cap valve with soapy water.
3. Align small area cleaning nozzle with cap valve and vacuum tube on grip/trigger unit.
4. Press latch button on vacuum tube and slide small area cleaning nozzle on until latch button locks in place.
5. Check manufacturer's tag and/or test fabric in an inconspicuous place.

### Cleaning

1. Turn on vacuum/suction and pump/spray switches.
2. Depress trigger and pull small area cleaning nozzle toward you.
3. Release trigger and repeat action to extract excess moisture.
4. Repeat until area is clean.
5. See WHEN YOU'RE DONE, above and PUTTING IT AWAY, page 12.

### Tip:

To clean upholstery, disconnect wand solution tube and aluminum wand from grip/trigger unit. Moisten O-ring at base of cap valve with soapy water. Align the Small Area Cleaning Nozzle with the cap valve and vacuum tube on grip/trigger unit, then press latch button on vacuum tube and slide together until latch button locks in place.

### Tip:

Check upholstery stuffing before cleaning. Colored stuffing may bleed through fabric when wet.

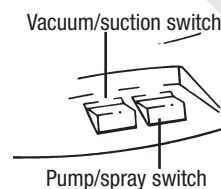

## How To Clean Bare Floors

### Getting Ready

1. Attach bare floor attachment to bottom of floor nozzle with rubber and brush strips facing out. Align front edges and snap together.
2. Fill measuring lid twice with Bissell Floor Care and empty into filling cavity.
3. Pour two gallons of hot tap water **into filling cavity**. Water level should reach the bottom of three vertical lines **in tank unit**.

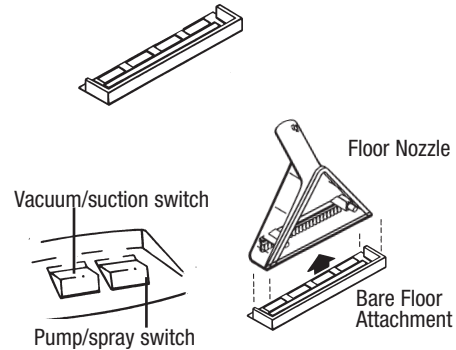

### Cleaning

1. Turn vacuum/suction and pump/spray switches on.
2. Depress trigger and pull floor nozzle toward you.
3. Release trigger and repeat action to extract excess moisture.
4. Disconnect bare floor attachment. Turn off machine, hold floor nozzle away from you, push bare floor tool off with thumbs.
5. See WHEN YOU'RE DONE, page 9 and PUTTING IT AWAY, page 12.

#### *Tip:*

To clean bare floors, attach Bare Floor Attachment to bottom of Floor Nozzle with the rubber and brush strips facing out. Align front edges

## How To Dry Vacuum

1. Make sure tank unit is dry before proceeding.
2. Check motor filter. Clean if necessary.
3. Pull dry filter bag over ball cage, catching edge of bag over lip at bottom of cage.
4. Place ball on raised area at bottom of tank unit.
5. Position ball cage over ball and press firmly onto raised area.
6. Remove two small aluminum wand clips and floor nozzle from wand.

## How To Dry Vacuum

7. Attach one of four dry vacuuming tools.
8. Insert tank siphon tube in tank unit.
9. Turn on vacuum/suction switch. Vacuum as usual.
10. Empty collection tank when it is half full.
11. See PUTTING IT AWAY, page 12.

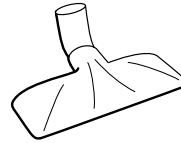

### Tip:

Always check motor filter before dry vacuuming. Clean if necessary.

## How To Wet Vacuum

### Getting Ready

1. Remove dry filter bag from ball cage.
2. Place ball on raised area on bottom of tank unit.
3. Position ball cage over ball and press firmly onto raised area.
4. Insert tank siphon tube in tank unit.
5. Attach bare floor tool to floor nozzle.

Vacuum/suction switch

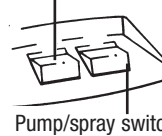

Pump/spray switch

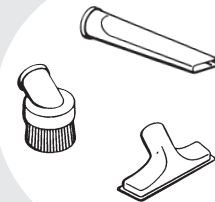

### Cleaning

1. Turn on vacuum/suction switch. Do **not** turn on pump/spray switch or pump damage may occur.
2. Place Big Green in a dry area of the floor.
3. Vacuum as usual.
4. If the machine loses suction and/or motor noise rises in pitch, empty the tank [see WHEN YOU'RE DONE]. Failure to empty tank will damage unit.
5. See WHEN YOU'RE DONE, page 9 and PUTTING IT AWAY, page 12.

Vacuum/suction switch

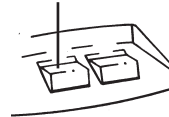

### Tip:

Clean water spills can be picked up from surfaces directly. No cleaning solution is necessary.

## Putting It Away

### After Deep Cleaning/Wet Vacuuming

1. Rinse filling cavity with clean water. Leave about 1/2 gallon of clean water in filling cavity.
2. Hold floor nozzle over bucket or sink.
3. Turn on pump/spray switch, pull trigger for 30 seconds, and empty power unit.
4. Empty filling cavity of excess water.
5. Drain solution hoses.
6. Empty and rinse collection tank.
7. Rinse and dry collection tank, ball cage, ball, wands, and tools.
8. Remove tank siphon tube from opening on power unit.
9. Remove filter from end of tank siphon tube, clean filter under running water, then replace filter in end of tank siphon tube.
10. Replace tank siphon tube in opening in power unit.
11. We recommend that you air dry before closing unit for storage.

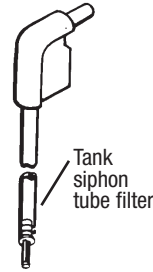

#### *Tip:*

Always clean floor nozzle spray tip and tank siphon tube filter before storing appliance.

### After Dry Vacuuming

1. Remove **motor filter** from top power unit and rinse with water. Squeeze to remove water, then air dry before reinstalling. Clean after each vacuuming.
2. Remove **dry filter bag** from ball cage. Shake to remove surface dirt. Rinse bag by hand in warm water. Air dry before reinstalling.

### **Weak or no suction / motor suddenly runs louder / motor runs hot.**

#### **Possible Causes**

- ❶ Vacuum is not operating
- ❷ Collection tank unit is full
- ❸ Air leak
- ❹ Dirty filter(s)
- ❺ Power unit improperly attached
- ❻ Kink/blockage in hoses/tubes

#### **Remedies**

- ❶ Check electrical plug  
Vacuum/switch on?  
Call BISSELL Consumer Services (see page 15)
- ❷ Empty collection tank
- ❸ Check all vacuum connections  
Secure all latch buttons
- ❹ See PUTTING IT AWAY, After Dry Vacuuming,  
Steps 1-2 (see page 12)
- ❺ Reposition top power unit on tank unit  
Carrying handle in place to lock tank unit and  
top power unit?
- ❻ Straighten hoses/tubes  
Check aluminum wands/vacuum flex  
hose/solution hose and tube for obstructions

### **Reduced spray or no spray / Leaking connections.**

#### **Possible Causes**

- ❶ Tank siphon tube filter clogged
- ❷ Filling cavity empty
- ❸ Spray tip clogged
- ❹ Tank siphon tube/Solution hose/  
Wand solution tube kinked/disconnected
- ❺ Pump is not operating
- ❻ Connections not tight

#### **Remedies**

- ❶ See PUTTING IT AWAY Steps 9-11 (see page 12)
- ❷ Refill filling cavity
- ❸ See PUTTING IT AWAY Step 8 (see page 12)
- ❹ Tighten loose connections  
Relax kinks in solution tubes/hoses
- ❺ Check electrical plug  
Pump/spray switch on?  
Call BISSELL Consumer Services (see page 15)
- ❻ Finger tighten all connections  
(do not use pliers or other tools)

**⚠ WARNING:**  
To reduce the risk  
of fire, electric  
shock or injury  
unplug from outlet  
before servicing.

# BISSELL Replacement Parts

Item	Part No.	Part Name
1	210-4706	Vacuum flex hose
2	555-9129	Large vacuum flex hose clips (3)
3	555-9013	Hose with threaded connectors
4	216-4181	Grip/trigger unit
5	210-1188	Dusting brush
6	010-9156	Crevice attachment
7	010-6055	Small vacuum nozzle
8	213-9152	Drain clean-out attachment
9	203-1659	Cap valve assembly
10	555-9008	Wand solution tube
11	555-6502	Small wand clips (2)
12	215-9151	Small nozzle
13	555-9044	Aluminum wands (2, interchangeable)
14	603-2920	Top power unit
15	017-3533	Motor filter
16	213-3537	Filter bag
17	213-1526	Ball cage
18	213-3004	Measuring cup
19	213-0329	Ball
20	215-9075	Tank unit (includes filling cavity, collection tank, and handle)
21	214-1523	Wall storage rack with screws (optional on (optional on some models)
22	555-9011	Tank siphon tube
23	555-9036	Tank siphon tube filter
24	210-2283	Caster (individual)
25	210-4740	Dry floor nozzle
26	215-6150	Spray tip
27	555-9005	Floor nozzle
28	555-9003	Floor nozzle brush
29	213-0471	Bare floor attachment

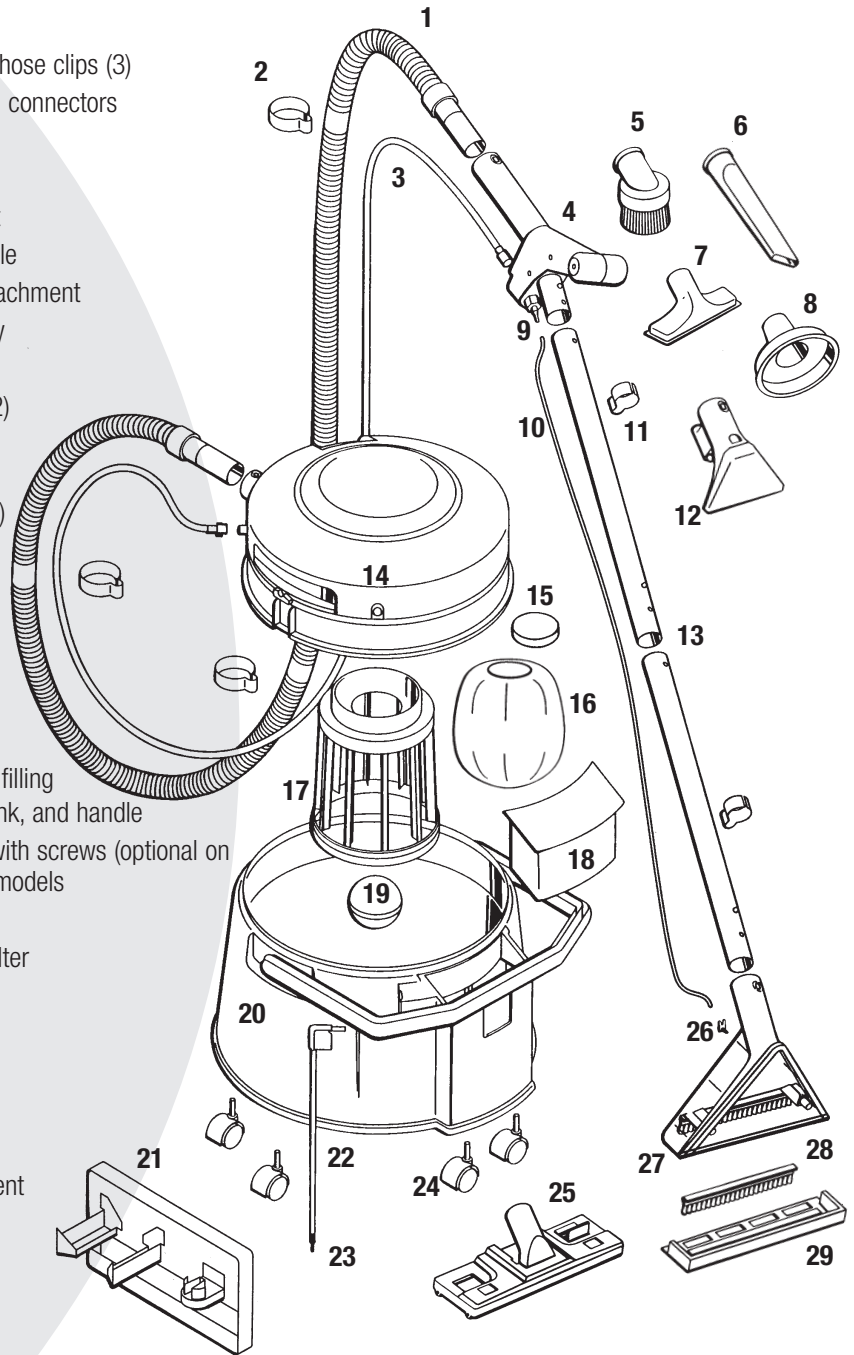



## BISSELL Consumer Services

For information about repairs or replacement parts, or questions about your warranty, call:

**BISSELL Consumer Services**

**1-800-237-7691**

Monday - Friday            8 a.m. — 10 p.m. ET

Saturday                    9 a.m. — 8 p.m. ET

Or write:

BISSELL Homecare, Inc.

PO Box 3606

Grand Rapids, MI 49501

ATTN: Consumer Services

Or visit the BISSELL website - **[www.bissell.com](http://www.bissell.com)**

When contacting BISSELL, have model number of unit available.

Please record your Model Number: \_\_\_\_\_

Please record your Purchase Date: \_\_\_\_\_

**NOTE: Please keep your original sales receipt. It is your warranty.**

You may purchase replacement parts from your retailer, by using the order form in this User's Guide, by calling BISSELL Consumer Services or by visiting our website. To locate a retailer near you, or to place an order using Visa, MasterCard, Discover or American Express, call

**BISSELL Consumer Services**

**1-800-237-7691**

Monday - Friday            8 a.m. — 10 p.m. ET

Saturday                    9 a.m. — 8 p.m. ET

Or visit our Website - **[www.bissell.com](http://www.bissell.com)**

## About Your Warranty

This warranty gives you specific legal rights, and you may also have other rights which may vary from state to state. If you need additional instruction regarding this warranty or have questions regarding what it may cover, please contact BISSELL Consumer Services by E-mail, telephone, or regular mail as described below.

### Limited Two Year Warranty

Subject to the \*EXCEPTIONS AND EXCLUSIONS identified below, upon receipt of the product BISSELL Homecare, Inc. will repair or replace (with new or remanufactured components or products), at BISSELL's option, free of charge from the date of purchase by the original purchaser, for two years any defective or malfunctioning part.

See information below on "If your BISSELL product should require service".

This warranty applies to product used for personal, and not commercial or rental service. This warranty does not apply to fans or routine maintenance components such as filters, belts, or brushes. Damage or malfunction caused by negligence, abuse, neglect, unauthorized repair, or any other use not in accordance with the User's Guide is not covered.

### If your BISSELL product should require service:

Call BISSELL Consumer Services at the number below or visit the BISSELL website - **www.bissell.com** to locate a BISSELL Authorized Service Center in your area. If there are no authorized BISSELL Service Centers in your area, select the "Customer Service" tab, and follow the instructions for contacting us via email. A BISSELL Representative will issue you a Return Authorization Number and a pre-paid mailing label to return the unit to BISSELL for warranty repair.

The machine should be returned with a photocopy of your proof of purchase. (Your dated sales receipt is your proof of date of purchase in the event of a warranty claim - do not send original.)

If you need information about repairs or replacement parts, or if you have questions about your warranty, select the "Customer Service" tab on our website and follow the instructions for contacting us by e-mail.

Or call:

#### **BISSELL Consumer Services**

1-800-237-7691

Monday - Friday 8 a.m. - 9 p.m. EST

Saturday 9 a.m. - 5 p.m. .EST

Or write:

#### **BISSELL HOMECARE, INC.**

PO Box 3606

Grand Rapids MI 49501

ATTN: Consumer Services

BISSELL HOMECARE, INC. IS NOT LIABLE FOR INCIDENTAL OR CONSEQUENTIAL DAMAGES OF ANY NATURE ASSOCIATED WITH THE USE OF THIS PRODUCT. BISSELL'S LIABILITY WILL NOT EXCEED THE PURCHASE PRICE OF THE PRODUCT.

Some states do not allow the exclusion or limitation of incidental or consequential damages, so the above limitation or exclusion may not apply to you.

\*EXCEPTIONS AND EXCLUSIONS FROM THE TERMS OF THE **LIMITED WARRANTY**

THIS WARRANTY IS EXCLUSIVE AND IN LIEU OF ANY OTHER WARRANTIES EITHER ORAL OR WRITTEN. ANY IMPLIED WARRANTIES WHICH MAY ARISE BY OPERATION OF LAW, INCLUDING THE IMPLIED WARRANTIES OF MERCHANTABILITY AND FITNESS FOR A PARTICULAR PURPOSE, ARE LIMITED TO THE TWO YEAR DURATION FROM THE DATE OF PURCHASE AS DESCRIBED ABOVE.

Some states do not allow limitations on how long an implied warranty lasts, so the above limitation may not apply to you. Download from [Www.Somanuals.com](http://Www.Somanuals.com). All Manuals Search And Download.



©2003 BISSELL Homecare, Inc  
Grand Rapids, Michigan  
All rights reserved. Printed in USA  
Part Number 010-5859  
Rev 7/03

Visit our website at:  
[www.bissell.com](http://www.bissell.com)



## Free Manuals Download Website

<http://myh66.com>

<http://usermanuals.us>

<http://www.somanuals.com>

<http://www.4manuals.cc>

<http://www.manual-lib.com>

<http://www.404manual.com>

<http://www.luxmanual.com>

<http://aubethermostatmanual.com>

Golf course search by state

<http://golfingnear.com>

Email search by domain

<http://emailbydomain.com>

Auto manuals search

<http://auto.somanuals.com>

TV manuals search

<http://tv.somanuals.com>