

**CHICAGO POWER  
ELECTRIC® SYSTEMS**

# 1.5 AMP ELECTRONIC ONBOARD BATTERY CHARGER

Model 99857

## SET UP AND OPERATING INSTRUCTIONS



Distributed exclusively by Harbor Freight Tools®.

3491 Mission Oaks Blvd., Camarillo, CA 93011

Visit our website at: <http://www.harborfreight.com>



**Read this material before using this product.  
Failure to do so can result in serious injury.  
SAVE THIS MANUAL.**

Copyright© 2008 by Harbor Freight Tools®. All rights reserved. No portion of this manual or any artwork contained herein may be reproduced in any shape or form without the express written consent of Harbor Freight Tools. Diagrams within this manual may not be drawn proportionally. Due to continuing improvements, actual product may differ slightly from the product described herein. Tools required for assembly and service may not be included.

**For technical questions or replacement parts, please call 1-800-444-3353.**

## SAVE THIS MANUAL

Keep this manual for the safety warnings and precautions, assembly, operating, inspection, maintenance and cleaning procedures. Write the product's serial number in the back of the manual near the assembly diagram (or month and year of purchase if product has no number). Keep this manual and the receipt in a safe and dry place for future reference.

## IMPORTANT SAFETY INFORMATION

In this manual, on the labeling, and all other information provided with this product:



This is the safety alert symbol. It is used to alert you to potential personal injury hazards. Obey all safety messages that follow this symbol to avoid possible injury or death.



### DANGER

**DANGER** indicates a hazardous situation which, if not avoided, will result in death or serious injury.



### WARNING

**WARNING** indicates a hazardous situation which, if not avoided, could result in death or serious injury.



### CAUTION

**CAUTION**, used with the safety alert symbol, indicates a hazardous situation which, if not avoided, could result in minor or moderate injury.

### NOTICE

**NOTICE** is used to address practices not related to personal injury.

### CAUTION

**CAUTION**, without the safety alert symbol, is used to address practices not related to personal injury.

## General Battery Charger Safety Warnings



**WARNING** Read all safety warnings and instructions. Failure to follow the warnings and instructions may result in electric shock, fire and/or serious injury. Save all warnings and instructions for future reference. The term "Battery Charger" in the warnings refers to your mains-operated (corded) Battery Charger.

1. **Work area safety**
  - a. **Keep work area clean and well lit.** Cluttered or dark areas invite accidents.
  - b. **Do not operate Battery Chargers in explosive atmospheres, such as in the presence of flammable liquids, gases or dust.** Battery Chargers create sparks which may ignite the dust or fumes.
  - c. **Keep children and bystanders away while operating a Battery Charger.** Distractions can cause you to lose control.
2. **Electrical safety**
  - a. **Battery Charger plug must match the outlet. Never modify the plug in any way. Do not use any adapter plugs with grounded Battery Chargers.** Unmodified plugs and

*matching outlets will reduce risk of electric shock.*

- b. Avoid body contact with grounded surfaces such as pipes, radiators, ranges and refrigerators.** *There is an increased risk of electric shock if your body is grounded.*
  - c. Do not expose Battery Chargers to rain or wet conditions.** *Water entering a Battery Charger will increase the risk of electric shock.*
  - d. Do not abuse the cord. Never use the cord for carrying, pulling or unplugging the Battery Charger. Keep cord away from heat, oil, sharp edges or moving parts.** *Damaged or entangled cords increase the risk of electric shock.*
  - e. When operating a Battery Charger outdoors, use an extension cord suitable for outdoor use.** *Use of a cord suitable for outdoor use reduces the risk of electric shock.*
  - f. If operating a Battery Charger in a damp location is unavoidable, use a Ground Fault Circuit Interrupter (GFCI) protected supply.** *Use of a GFCI reduces the risk of electric shock.*
- 3. Personal safety**
- a. Stay alert, watch what you are doing and use common sense when operating a Battery Charger. Do not use a Battery Charger while you are tired or under the influence of drugs, alcohol or medication. A moment of inattention while operating Battery Chargers may result in serious personal injury.**
  - b. Use personal protective equipment. Always wear eye protection. Safety equipment such as dust mask,**
- non-skid safety shoes, hard hat, or hearing protection used for appropriate conditions will reduce personal injuries.*
- c. Do not overreach. Keep proper footing and balance at all times.** *This enables better control of the Battery Charger in unexpected situations.*
  - d. Dress properly. Do not wear loose clothing or jewelry. Keep your hair, clothing and gloves away from moving parts.** *Loose clothes, jewelry or long hair can be caught in moving parts.*
  - e. Only use safety equipment that has been approved by an appropriate standards agency. Unapproved safety equipment may not provide adequate protection. Eye protection must be ANSI-approved and breathing protection must be NIOSH-approved for the specific hazards in the work area.**
- 4. Battery Charger use and care**
- a. Do not force the Battery Charger. Use the correct Battery Charger for your application.** *The correct Battery Charger will do the job better and safer at the rate for which it was designed.*
  - b. Disconnect the plug from the power source from the Battery Charger before making any adjustments, changing accessories, or storing Battery Chargers.** *Such preventive safety measures reduce the risk of starting the Battery Charger accidentally.*
  - c. Store idle Battery Chargers out of the reach of children and do not allow persons unfamiliar with the**

**Battery Charger or these instructions to operate the Battery Charger. Battery Chargers are dangerous in the hands of untrained users.**

**d. Maintain Battery Chargers. Check for breakage of parts and any other condition that may affect the Battery Charger's operation. If damaged, have the Battery Charger repaired before use. Many accidents are caused by poorly maintained Battery Chargers.**

**e. Use the Battery Charger in accordance with these instructions, taking into account the working conditions and the work to be performed. Use of the Battery Charger for operations different from those intended could result in a hazardous situation.**

## **5. Battery use and care**

**a. When battery is not in use, keep away other metal objects, like paper clips, coins, keys, nails, screws or other small metal objects, that can make a connection from one terminal to another. Shorting the battery terminals together may cause burns or a fire.**

**b. Under abusive conditions, liquid may be ejected from the battery; avoid contact. If contact accidentally occurs, flush with water. If liquid contacts eyes, additionally seek medical help. Liquid ejected from the battery may cause irritation or burns.**

## **6. Service**

**a. Have your Battery Charger serviced by a qualified repair person using only identical replacement**

**parts. This will ensure that the safety of the Battery Charger is maintained.**

## **Battery Charger Safety Warnings**

1. Maintain labels and nameplates on the tool. These carry important safety information. If unreadable or missing, contact Harbor Freight Tools for a replacement.
2. Avoid contact with battery acid. If splashed, unplug Battery Charger and immediately wash effected area with clean water.
3. Turn vehicle OFF and allow to cool before plugging in Battery Charger. Remove keys from vehicle ignition before plugging in Battery Charger.
4. Before operation, check to be sure Battery Charger cables are connected to the correct battery posts. Red must be connected to the Positive (+) terminal. Black cable must be connected to the Negative (-) terminal.
5. Keep Output Wires (12) and Power Cable (8) clear of fan, fan belt, pulleys and any other moving parts of the engine.
6. Only use Battery Charger in a well ventilated area to prevent build up of explosive gasses.
7. Do not allow the Red and Black terminals of the Battery Charger or the vehicle battery cables to touch. Do not allow the Red cables to touch the frame or any metal part of the vehicle. Contact can cause an electrical short resulting in sparks, burn injury or damage to property.
8. Only use in 12 VDC systems. Do not use in any other voltage system.

9. Do not attempt to start or jump a vehicle with this Battery Charger plugged in. Do not use this Battery Charger to charge a dead, damaged or severely discharged battery. This charger is designed to “top off” and maintain a battery at or near 12 VDC.
10. Do not leave the Charger unattended when it is plugged into an electrical outlet. Unplug the Charger from its electrical outlet before leaving.
11.  The battery charger may get hot during use. The charger’s heat can build up to unsafe levels and create a fire hazard if it does not receive adequate ventilation, due to an electrical fault, or if it is used in a hot environment.  
Do not place the charger on a flammable surface. Do not obstruct any vents on the charger. **Especially avoid placing the charger on carpets and rugs; they are not only flammable, but they also obstruct vents under the charger.**
12. This product is not a toy. Keep it out of reach of children.
13. People with pacemakers should consult their physician(s) before use. Electromagnetic fields in close proximity to heart pacemaker could cause pacemaker interference or pacemaker failure. In addition, people with pacemakers should:
  - Avoid operating alone.
  - Do not use with power switch locked on.
  - Properly maintain and inspect to avoid electrical shock.
  - Any power cord must be properly grounded. Ground Fault Circuit Inter-
- rupter (GFCI) should also be implemented – it prevents sustained electrical shock.
14. **WARNING:** Handling the cord on this product will expose you to lead, a chemical known to the State of California to cause cancer, and birth defects or other reproductive harm. Wash hands after handling. (California Health & Safety Code § 25249.5, et seq.)
15. **WARNING:** The brass components of this product contain lead, a chemical known to the State of California to cause birth defects (or other reproductive harm). (California Health & Safety code 25249.5, et seq.)
16. The warnings, precautions, and instructions discussed in this instruction manual cannot cover all possible conditions and situations that may occur. It must be understood by the operator that common sense and caution are factors which cannot be built into this product, but must be supplied by the operator.



**SAVE THESE INSTRUCTIONS.**

---

## GROUNDING

---

**⚠WARNING** TO PREVENT ELECTRIC SHOCK



**AND DEATH FROM INCORRECT GROUNDING WIRE CONNECTION:**

Check with a qualified electrician if you are in doubt as to whether the outlet is properly grounded. Do not modify the power cord plug provided with the tool. Never remove the grounding prong from the plug. Do not use the tool if the power cord or plug is damaged. If damaged, have it repaired by a service facility before use. If the plug will not fit the outlet, have a proper outlet installed by a qualified electrician.

---

### Grounded Tools: Tools with Three Prong Plugs

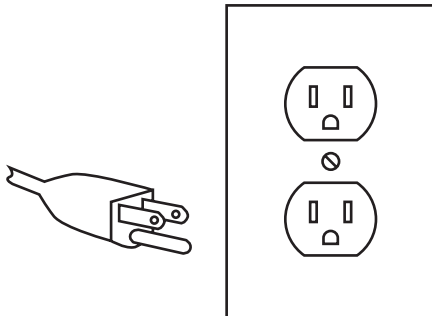

#### 3-Prong Plug and Outlet

1. Tools marked with "Grounding Required" have a three wire cord and three prong grounding plug. The plug must be connected to a properly grounded outlet. If the tool should electrically malfunction or break down, grounding provides a low resistance path to carry electricity away from the user, reducing the risk

of electric shock. (See 3-Prong Plug and Outlet.)

2. The grounding prong in the plug is connected through the green wire inside the cord to the grounding system in the tool. The green wire in the cord must be the only wire connected to the tool's grounding system and must never be attached to an electrically "live" terminal. (See 3-Prong Plug and Outlet.)
3. The tool must be plugged into an appropriate outlet, properly installed and grounded in accordance with all codes and ordinances. The plug and outlet should look like those in the preceding illustration. (See 3-Prong Plug and Outlet.)

---

### Double Insulated Tools: Tools with Two Prong Plugs

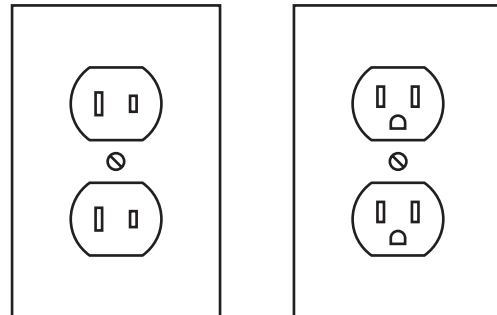

#### Outlets for 2-Prong Plug

1. Tools marked "Double Insulated" do not require grounding. They have a special double insulation system which satisfies OSHA requirements and complies with the applicable standards of Underwriters Laboratories, Inc., the Canadian Standard Association, and the National Electrical Code. (See Outlets for 2-Prong Plug.)

- Double insulated tools may be used in either of the 120 volt outlets shown in the preceding illustration. **(See Outlets for 2-Prong Plug.)**

### Extension Cords

- Grounded** tools require a three wire extension cord. **Double Insulated** tools can use either a two or three wire extension cord.
- As the distance from the supply outlet increases, you must use a heavier gauge extension cord. Using extension cords with inadequately sized wire causes a serious drop in voltage, resulting in loss of power and possible tool damage. **(See Table A.)**
- The smaller the gauge number of the wire, the greater the capacity of the cord. For example, a 14 gauge cord can carry a higher current than a 16 gauge cord. **(See Table A.)**
- When using more than one extension cord to make up the total length, make sure each cord contains at least the minimum wire size required. **(See Table A.)**
- If you are using one extension cord for more than one tool, add the nameplate amperes and use the sum to determine the required minimum cord size. **(See Table A.)**
- If you are using an extension cord outdoors, make sure it is marked with the suffix "W-A" ("W" in Canada) to indicate it is acceptable for outdoor use.
- Make sure the extension cord is properly wired and in good electrical con-







dition. Always replace a damaged extension cord or have it repaired by a qualified electrician before using it.

- Protect the extension cords from sharp objects, excessive heat, and damp or wet areas.

<b>RECOMMENDED MINIMUM WIRE GAUGE FOR EXTENSION CORDS* (120/240 VOLT)</b>					
<b>NAMEPLATE AMPERES (at full load)</b>	<b>EXTENSION CORD LENGTH</b>				
	<b>25'</b>	<b>50'</b>	<b>75'</b>	<b>100'</b>	<b>150'</b>
0 – 2.0	18	18	18	18	16
2.1 – 3.4	18	18	18	16	14
3.5 – 5.0	18	18	16	14	12
5.1 – 7.0	18	16	14	12	12
7.1 – 12.0	18	14	12	10	-
12.1 – 16.0	14	12	10	-	-
16.1 – 20.0	12	10	-	-	-

**TABLE A** \* Based on limiting the line voltage drop to five volts at 150% of the rated amperes.

### Symbology

	Double Insulated
	Canadian Standards Association
	Underwriters Laboratories, Inc.
	Volts Alternating Current
	Amperes
	No Load Revolutions per Minute (RPM)

## SPECIFICATIONS

Electrical Requirements	120 V~ / 60 Hz
Output Voltage	12 VDC / 1.5 Amps
Charging Method	3-Stage trickle charge
Status Indicators	Red, Yellow and Green LED lights
Overload Protection	On / Off trickle charging with Thermal Overload Protection
Additional Protection	Short Circuit and Polarity Protection

## UNPACKING

When unpacking, check to make sure that the item is intact and undamaged. If any parts are missing or broken, please call Harbor Freight Tools at the number shown on the cover of this manual as soon as possible.

## INSTRUCTIONS FOR PUTTING INTO USE



Read the **ENTIRE IMPORTANT SAFETY INFORMATION** section at the beginning of this manual including all text under subheadings therein before set up or use of this product.



**TO PREVENT SERIOUS INJURY**

**FROM ACCIDENTAL OPERATION:**

Unplug the tool from its electrical outlet and disconnect from battery before assembling or making any adjustments to the tool.

**Note:** For additional information regarding the parts listed in the following pages, refer to the Assembly Diagram near the end of this manual.

## Mounting

1. The Battery Charger must be mounted near the battery in the engine compartment of the vehicle.
2. Leave at least 2-1/2" clearance in front of the Output Wires (12) Plug.
3. You can mount the Charger on the vehicle engine compartment wall near the battery, or you can mount it on a bracket held in place by the battery.

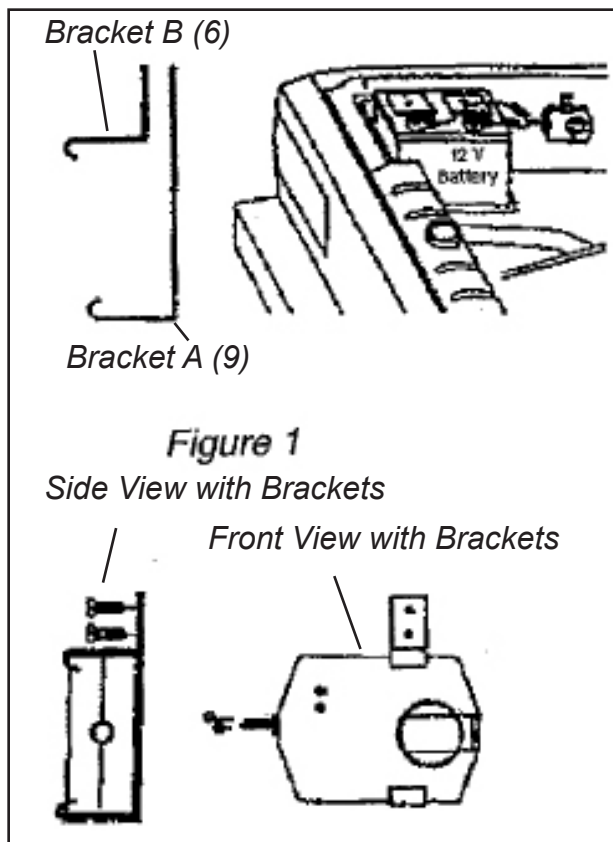

4. For Engine Compartment Wall mounting, mark and predrill wall using Bracket A (9) or Bracket B (6) as a template. See Figure 1 above. Be



sure that there are no wires, hoses or other components behind the wall that will be damaged by drilling. Use Brackets A and B to grip the Battery Charger. Attach to the compartment wall using two Self Tapping Screws (12).

5. For mounting under the battery, assemble Brackets A, B and C (9, 6 and 5) as shown in *Figure 2* below.

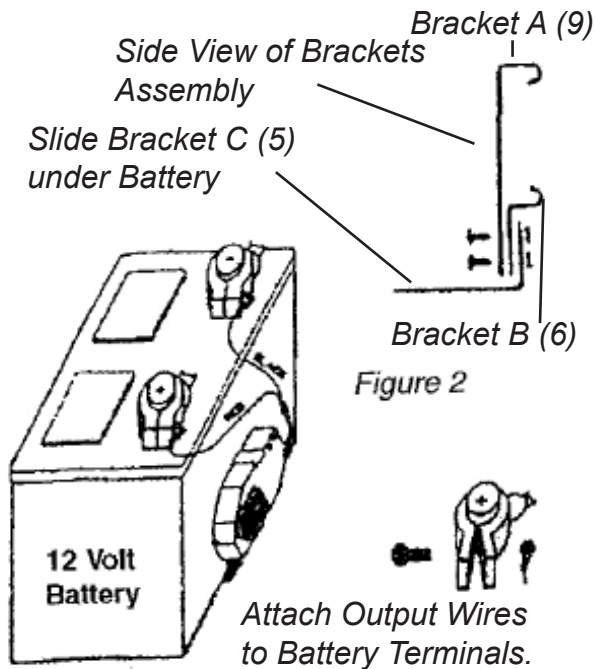

6. Slide Bracket C (5) under the battery to hold the Charger in place.
7. Be sure the Battery Charger is firmly attached and will not come loose during normal vehicle use or during a sudden stop. Periodically check the Charger to be sure it is still firmly attached. A loose Battery Charger can become damaged, or damage vehicle components.
8. Be sure the vehicle ignition switch is in the OFF position. Using the vehicle battery clamp bolts, attach the round connectors of the Output Wires (12)

to the battery. Be sure the Red Output Wire is attached to the Positive (+) terminal and the Black Output wire is attached to the Negative (-) terminal. Be sure all connections are tight.

9. Keep Output Wires (12) and Power Cable (8) clear of fan, fan belt, pulleys and any other moving parts of the engine.

### Functions

1. When plugged in, this Battery Charger will charge a 12 VDC battery, and maintain the charge. You can see the state of charge by observing the LED lights on the Charger.

### 3 Stage Charging

1. This charger automatically works in three stages, depending on the condition of your battery.

2. 1st stage: Constant Current. When the battery is severely discharged, the Charger applies Constant Current. This stage speedily charges the battery while protecting against damage, loss of Hydrogen or even explosion. The battery is charged to a maximum of 14.8 Volts DC.
3. 2nd Stage: Constant Voltage. This is a speed charge cycle for batteries nearly full. It will top off the battery at 14.8 Volts DC, utilizing a 200 mA trickle charge.
4. 3rd stage: Floating Constant Voltage. This stage maintains a fully charged battery in its best condition by constantly applying small "ticks" of charge. The battery will never fall below 13.5 Volts DC.

## **OPERATING INSTRUCTIONS**



Read the **ENTIRE IMPORTANT SAFETY INFORMATION** section at the beginning of this manual including all text under subheadings therein before set up or use of this product.

### **Tool Set Up**



**TO PREVENT SERIOUS INJURY:**

**Use only an appropriate extension cord in good condition to operate this Battery Charger.**

See pages 6 and 7 of this manual for information on safe use of extension cords.

## **Work Piece and Work Area Set Up**

1. Designate a work area that is clean, ventilated and well-lit. The work area must not allow access by children or pets to prevent injury and distraction.
2. Route the power cord along a safe route to reach the work area without creating a tripping hazard or exposing the power cord to possible damage. The power cord must reach the work area with enough extra length to allow free movement while working.
3. To prevent electrical shock, avoid moisture or water in the work area.

## **General Operating Instructions**

1. Be sure the vehicle engine is OFF, the engine is cool and the key is removed from the ignition.
2. Never "Jump" or attempt to start the vehicle while the Battery Charger is plugged in.
3. Do not attempt to charge a damaged or "dead" battery with this tool. This charger is designed to "top off" and maintain vehicle batteries at or near 12 VDC. Attempting to charge damaged or discharged batteries with this tool may cause the battery or the charger to overheat, possibly causing damage or explosion.
4. Plug your extension cord into the Power Cable (8). Plug the extension cord into a GFCI protected 120 VAC outlet.
5. Observe the LED lights on the charger to determine the operational status of the circuit and the charger.

LED Color	ON / OFF	Condition
Green Red	OFF OFF	Charger is not operating. Check connections and status of 120 VAC circuit.
Green Yellow Red	ON ON OFF	120 VAC is present and charger is operating.
Green Red Yellow	ON OFF OFF	120 VAC is present. Battery is fully charged.
Green Red Yellow	ON/OFF ON OFF	Battery Voltage is under 9V.

6. Periodically check the Battery Charger during operation to be sure it does not overheat.
7. Before starting or operating the vehicle, unplug and put away the extension cord.

---

## MAINTENANCE AND SERVICING

---



Procedures not specifically explained in this manual must be performed only by a qualified technician.



**TO PREVENT SERIOUS INJURY**

**FROM TOOL FAILURE:**  
Do not use damaged equipment. If abnormal heat occurs, or Charger overheats, have the problem corrected before further use.

## Cleaning and Maintenance.

**BEFORE EACH USE**, inspect the general condition of the Charger. Check for loose screws, misalignment or binding of moving parts, cracked or broken parts, damaged electrical wiring, and any other condition that may affect its safe operation.

1. **AFTER USE**, clean external surfaces of the tool with clean cloth.
2. **⚠WARNING!** If the supply cord of this Battery Charger is damaged, it must be replaced only by a qualified service technician.

<b>Troubleshooting</b>		
<b>Problem</b>	<b>Possible Causes</b>	<b>Likely Solutions</b>
Tool will not operate. LED lights off.	1. No power at outlet. 2. Cord not connected.	1. Check power at outlet. 2. Check that cord is plugged in.
LED lights on, but tool does not charge battery	1. Loose or dirty connection at battery terminals.	1. Check connections. Clean and re-tighten.
 <b>Follow all safety precautions whenever diagnosing or servicing the tool. Disconnect power supply before service.</b>		

### **PLEASE READ THE FOLLOWING CAREFULLY**

THE MANUFACTURER AND/OR DISTRIBUTOR HAS PROVIDED THE PARTS LIST AND ASSEMBLY DIAGRAM IN THIS MANUAL AS A REFERENCE TOOL ONLY. NEITHER THE MANUFACTURER OR DISTRIBUTOR MAKES ANY REPRESENTATION OR WARRANTY OF ANY KIND TO THE BUYER THAT HE OR SHE IS QUALIFIED TO MAKE ANY REPAIRS TO THE PRODUCT, OR THAT HE OR SHE IS QUALIFIED TO REPLACE ANY PARTS OF THE PRODUCT. IN FACT, THE MANUFACTURER AND/OR DISTRIBUTOR EXPRESSLY STATES THAT ALL REPAIRS AND PARTS REPLACEMENTS SHOULD BE UNDERTAKEN BY CERTIFIED AND LICENSED TECHNICIANS, AND NOT BY THE BUYER. THE BUYER ASSUMES ALL RISK AND LIABILITY ARISING OUT OF HIS OR HER REPAIRS TO THE ORIGINAL PRODUCT OR REPLACEMENT PARTS THERETO, OR ARISING OUT OF HIS OR HER INSTALLATION OF REPLACEMENT PARTS THERETO.

<b>PARTS LIST</b>		
<b>Part</b>	<b>Description</b>	<b>Qty.</b>
1	LED Light	3
2	Top Cover	1
3	Radiator	1
4	Printed Circuit Board	1
5	Bracket C	1
6	Bracket B	1
7	Bottom Cover	1
8	Power Cable	1
9	Bracket A	1
10	2.5 x 12 Self Tapping Screws	4
11	Transformer	1
12	Output Wires	1

# ASSEMBLY DIAGRAM

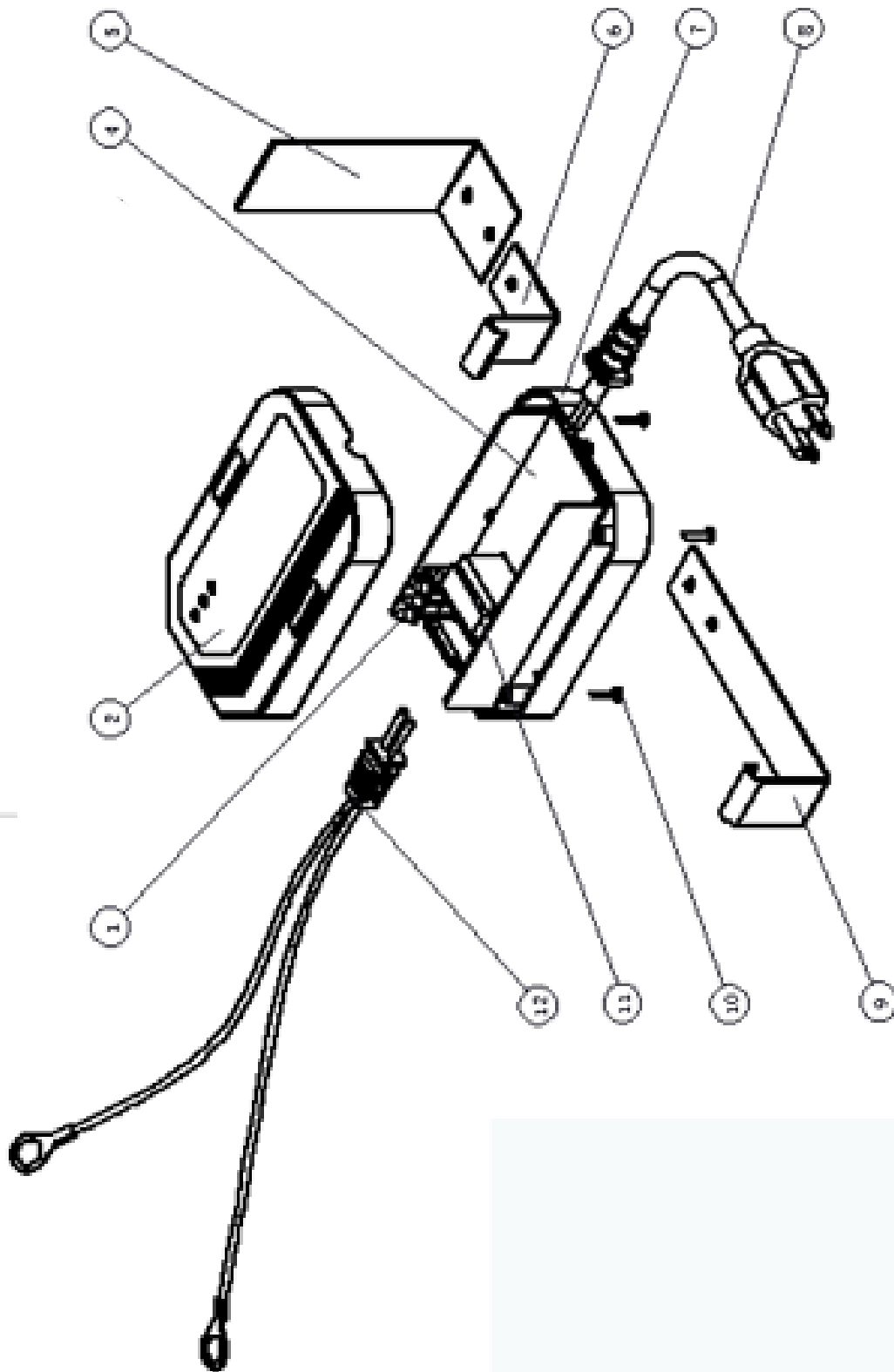

---

## LIMITED 90 DAY WARRANTY

---

Harbor Freight Tools Co. makes every effort to assure that its products meet high quality and durability standards, and warrants to the original purchaser that this product is free from defects in materials and workmanship for the period of 90 days from the date of purchase. This warranty does not apply to damage due directly or indirectly, to misuse, abuse, negligence or accidents, repairs or alterations outside our facilities, criminal activity, improper installation, normal wear and tear, or to lack of maintenance. We shall in no event be liable for death, injuries to persons or property, or for incidental, contingent, special or consequential damages arising from the use of our product. Some states do not allow the exclusion or limitation of incidental or consequential damages, so the above limitation of exclusion may not apply to you. THIS WARRANTY IS EXPRESSLY IN LIEU OF ALL OTHER WARRANTIES, EXPRESS OR IMPLIED, INCLUDING THE WARRANTIES OF MERCHANTABILITY AND FITNESS.

To take advantage of this warranty, the product or part must be returned to us with transportation charges prepaid. Proof of purchase date and an explanation of the complaint must accompany the merchandise. If our inspection verifies the defect, we will either repair or replace the product at our election or we may elect to refund the purchase price if we cannot readily and quickly provide you with a replacement. We will return repaired products at our expense, but if we determine there is no defect, or that the defect resulted from causes not within the scope of our warranty, then you must bear the cost of returning the product.

This warranty gives you specific legal rights and you may also have other rights which vary from state to state.

**3491 Mission Oaks Blvd. • PO Box 6009 • Camarillo, CA 93011 • (800) 444-3353**

**Record Product's Serial Number Here:** \_\_\_\_\_

**Note:** If product has no serial number, record month and year of purchase instead.

**Note:** Some parts are listed and shown for illustration purposes only, and are not available individually as replacement parts.

## Free Manuals Download Website

<http://myh66.com>

<http://usermanuals.us>

<http://www.somanuals.com>

<http://www.4manuals.cc>

<http://www.manual-lib.com>

<http://www.404manual.com>

<http://www.luxmanual.com>

<http://aubethermostatmanual.com>

Golf course search by state

<http://golfingnear.com>

Email search by domain

<http://emailbydomain.com>

Auto manuals search

<http://auto.somanuals.com>

TV manuals search

<http://tv.somanuals.com>