

# TABLE OF CONTENTS

SECTION		PAGE
<b>1</b>	<b>INTRODUCTION</b> .....	<b>3</b>
<b>2</b>	<b>THINGS TO KNOW BEFORE STARTING YOUR VEHICLE</b> .....	<b>7</b>
<b>3</b>	<b>UNDERSTANDING THE FEATURES OF YOUR VEHICLE</b> .....	<b>47</b>
<b>4</b>	<b>UNDERSTANDING YOUR INSTRUMENT PANEL</b> .....	<b>87</b>
<b>5</b>	<b>STARTING AND OPERATING</b> .....	<b>117</b>
<b>6</b>	<b>WHAT TO DO IN EMERGENCIES</b> .....	<b>157</b>
<b>7</b>	<b>MAINTAINING YOUR VEHICLE</b> .....	<b>175</b>
<b>8</b>	<b>MAINTENANCE SCHEDULES</b> .....	<b>225</b>
<b>9</b>	<b>IF YOU NEED CONSUMER ASSISTANCE</b> .....	<b>235</b>
<b>10</b>	<b>INDEX</b> .....	<b>243</b>



---

# INTRODUCTION

## CONTENTS

---

■ Introduction . . . . .	4	■ Warnings And Cautions . . . . .	6
■ How To Use This Manual . . . . .	4	■ Vehicle Identification Number . . . . .	6

### INTRODUCTION

This manual has been prepared with the assistance of service and engineering specialists to acquaint you with the operation and maintenance of your Crossfire. It is supplemented by a Warranty Information Booklet and various customer-oriented documents. You are urged to read these publications carefully. Following the instructions and recommendations in this manual will help assure safe and enjoyable operation of your vehicle.

**NOTE:** After you read the manual, it should be stored in the vehicle for convenient reference and remain with the vehicle when sold.

When it comes to service, remember that your authorized dealer knows your vehicle best, has the factory-trained technicians and genuine Mopar® parts, and is interested in your satisfaction.

### WARNING!









**Engine exhaust, some of its constituents, and certain vehicle components contain or emit chemicals known to the State of California to cause cancer and birth defects or other reproductive harm.**

### HOW TO USE THIS MANUAL

Consult the table of contents to determine which section contains the information you desire.

The detailed index, at the rear of this manual, contains a complete listing of all subjects.

Consult the following table for a description of the symbols that may be used on your vehicle or throughout this owner's manual:

			<b>BRAKE</b> BRAKE SYSTEM WARNING PARKING BRAKE						
			 FAILURE OF ANTI-LOCK BRAKING SYSTEM						
									
									
									<b>BAS ESP</b> BRAKE ASSIST SYSTEM / ELECTRONIC STABILITY PROGRAM
									
<b>CHECK ENGINE</b> ENGINE		<b>SRS AIRBAG</b> SUPPLEMENTAL RESTRAINT SYSTEM							
									

**WARNINGS AND CAUTIONS**

This manual contains **WARNINGS** against operating procedures which could result in an accident or bodily injury. It also contains **CAUTIONS** against procedures which could result in damage to your vehicle. If you do not read this entire manual you may miss important information. Observe all Warnings and Cautions.

**VEHICLE IDENTIFICATION NUMBER**

The vehicle identification number (VIN) is located beneath the left front corner of the instrument panel, visible through the windshield. This number also appears on the Automobile Information Disclosure Label affixed to a window on your vehicle. Save this label as a convenient record of your vehicle identification number and optional equipment.

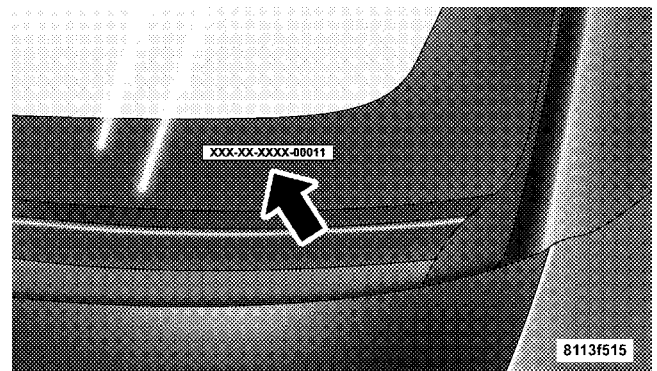

---

# THINGS TO KNOW BEFORE STARTING YOUR VEHICLE

## CONTENTS

---

■ A Word About Your Keys . . . . .	9	□ Emergency Unlocking Feature . . . . .	13
□ Keys . . . . .	9	□ Start Lockout . . . . .	13
□ Obtaining Replacement Keys . . . . .	9	■ Remote Keyless Entry . . . . .	14
□ Ignition Key Removal . . . . .	10	□ To Unlock The Doors . . . . .	14
□ Key-In-Ignition Reminder . . . . .	10	□ To Lock The Doors . . . . .	14
■ Glove Compartment Lock . . . . .	10	□ Panic Alarm . . . . .	15
■ Door Locks . . . . .	11	□ To Use The Panic Alarm . . . . .	15
□ Central Locking Switch . . . . .	12	□ General Information . . . . .	15
□ Automatic Central Locking . . . . .	12	□ Transmitter Battery Service . . . . .	16
□ General Notes On The Central Locking System . . . . .	13	■ Security Alarm System . . . . .	17
		□ Tow-Away Alarm . . . . .	17

**8 THINGS TO KNOW BEFORE STARTING YOUR VEHICLE**

■ Power Windows . . . . .	.18	■ Engine Break-In Recommendations . . . . .	.43
■ Rear Liftgate Release . . . . .	.19	■ Safety Tips . . . . .	.44
■ Occupant Restraints . . . . .	.20	□ Exhaust Gas . . . . .	.44
□ Lap/Shoulder Belts . . . . .	.21	□ Safety Checks You Should Make Inside The Vehicle . . . . .	.44
□ Seat Belts And Pregnant Women . . . . .	.25	□ Periodic Safety Checks You Should Make Outside The Vehicle . . . . .	.45
□ Seat Belt Extender . . . . .	.25		
□ Supplemental Restraint System (SRS) - Airbag . . . . .	.26		
□ Child Restraint . . . . .	.36		



**A WORD ABOUT YOUR KEYS**

You can insert the double-sided keys into the locks with either side up.

The dealer that sold you your new vehicle has the key code numbers for your vehicle locks. These numbers can be used to order duplicate keys only from an authorized dealer. Ask your dealer for these numbers and keep them in a safe place.

**CAUTION!**

**An unlocked car is an invitation to thieves. Always remove the key from the ignition and lock all the doors when leaving the vehicle unattended.**

**Keys**

Included with your vehicle are two remote controls with folding keys. The remote control operates all locks on the vehicle, including the locking fuel filler door.

To release the key from the folded position, press the button. The key unfolds from the fob.

The transmitter for the remote control is located in the key fob.

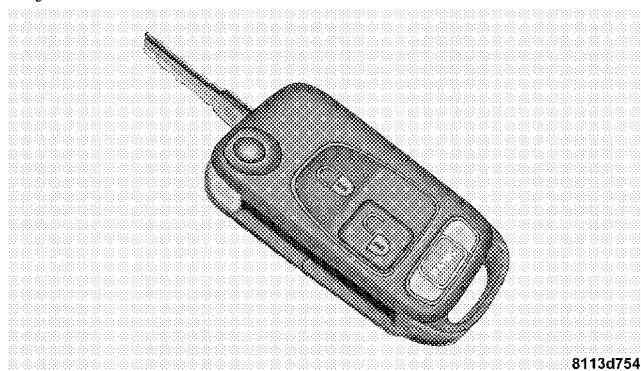

8113d754

**Obtaining Replacement Keys**

Your vehicle is equipped with a theft deterrent locking system requiring a special key manufacturing process. For security reasons, replacement keys can only be obtained from your authorized dealer.

**Important!**

Removing the key from the steering lock activates the start lock-out. The engine cannot be started.

## 10 THINGS TO KNOW BEFORE STARTING YOUR VEHICLE

Turning the key in the steering lock to the ON/RUN position deactivates the start lock-out.

**NOTE:** In case the engine cannot be started, and START and ERROR are shown in the odometer display field, the system is not operational. Contact an authorized dealer.

### Ignition Key Removal

Turn the key to the LOCK position and remove the key.

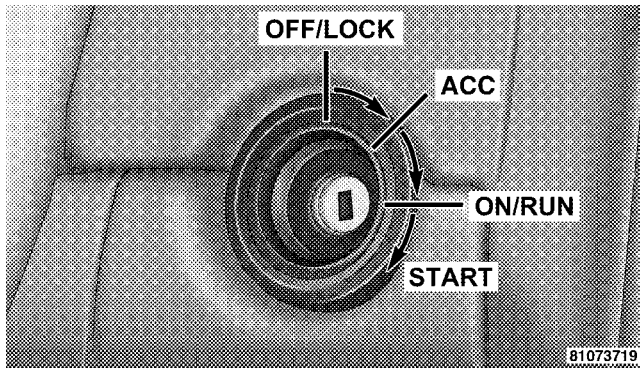

**NOTE:** For vehicles with automatic transmissions, if you try to remove the key before you place the shift lever in PARK, the key may become trapped temporarily in the

key cylinder. If this occurs, turn the key clockwise slightly, then remove the key as described.

### Key-In-Ignition Reminder

Opening the driver's door when the key is in the ignition sounds a signal to remind you to remove the key.

### GLOVE COMPARTMENT LOCK

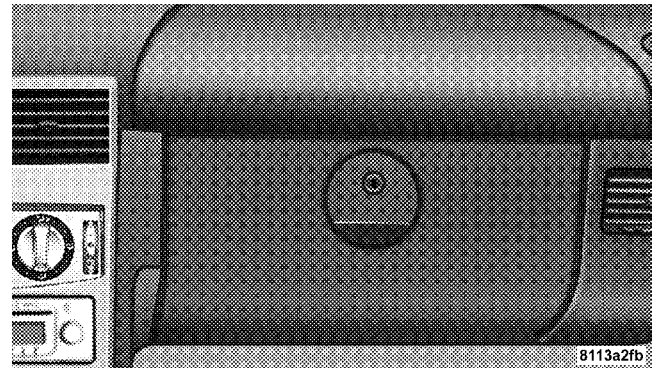

The glove compartment can be locked by turning the key straight up to the vertical or right position, and then removing the key.

To unlock the glove compartment, turn the key to the horizontal or left position, and then remove the key.

### DOOR LOCKS

The vehicle doors can be locked when the doors are closed by either manually pressing the button down at the top of the door panel, pressing and releasing the bottom portion of the central locking switch located in the console, or by pressing and releasing the Lock transmit button on the key fob. Also, by turning the key clockwise in the driver's door, both doors, liftgate and fuel door will lock.

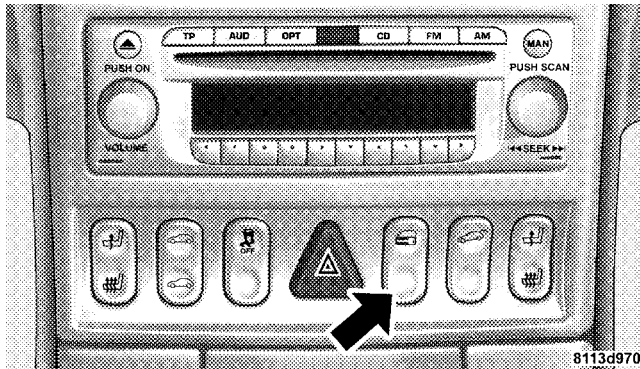

The doors can be unlocked by pulling on the inside door handle, pressing and releasing the top portion of the central locking switch located in the console, or by pressing and releasing the Unlock transmit button on the key fob. Both doors can also be unlocked by turning the key counterclockwise in the driver's door.

**NOTE:** If the key in the ignition switch is in the ON/RUN position, the vehicle cannot be locked or unlocked with the remote control.

When you lock the vehicle, both door lock buttons should move down. If either one stays up, the respective door is not properly closed. You should then unlock the vehicle, open and reclose the door, and lock the vehicle again.

Each individual door can be locked with the respective door lock button - the driver's door can only be locked when it is closed. If the vehicle has previously been locked from the outside, only the door being opened from the inside will unlock, and the alarm will come on. The other door, the rear liftgate, and fuel filler door will remain locked.

**NOTE:** In case of a malfunction in the central locking system, the doors can be locked and unlocked individually. To lock, turn the key in the driver's door lock clockwise, or push down the lock buttons. To unlock, turn the key in the driver's door lock counterclockwise, or pull the inside door handles.

**WARNING!**

**For personal security and safety in the event of an accident, lock the vehicle doors as you drive and when you park and leave the vehicle.**

**Central Locking Switch**

The central locking switch is located in the console. The doors and rear liftgate can only be locked with the central locking switch if both doors are closed.

If the vehicle was previously locked with the remote control or key, the doors and rear liftgate cannot be unlocked with the central locking switch. If the vehicle

was previously locked with the central locking switch, the complete vehicle is unlocked when a door is opened from the inside.

**NOTE:** The fuel filler door cannot be locked or unlocked with the central locking switch.

**Automatic Central Locking**

The central locking switch also operates the automatic central locking feature. With the automatic central locking feature activated, the doors and rear liftgate are locked at vehicle speeds of approximately 9 mph (15 km/h) or more; however, the fuel filler door remains unlocked.

To activate this feature, turn the key to the ON/RUN position and hold the upper portion of the switch for a minimum of five seconds. To deactivate, turn the key to the ON/RUN position and hold the lower portion of the switch for a minimum of five seconds.

**NOTE:** If the doors are unlocked with the central locking switch after activating the automatic central

locking feature and neither door is opened, the doors remain unlocked even at vehicle speeds of approximately 9 mph (15 km/h) or more.

**NOTE:** If you attempt to lock the doors with the key in the ignition and the driver's door open, the doors will not lock.

#### **General Notes On the Central Locking System**

If the key in the ignition switch is in the ON/RUN position, the vehicle cannot be locked or unlocked with the remote control.

If the vehicle cannot be locked or unlocked at any time with the remote control, it may be necessary to change the batteries in the remote.

**NOTE:** To help prevent the vehicle battery from discharging during short periods of inactivity, perform the following:

1. Make sure that the rear liftgate, hood and doors are completely closed.
2. Make sure that remote transmitter is operating and that the battery is good.

3. Make sure that the hood, rear liftgate and door switches are in adjustment.

Perform the quick system check which follows: Use the remote transmitter to set the alarm. If the parking lamps flash three times, the system is operating properly. If not, there is a problem with a switch or the system. See your authorized dealer for service.

#### **Emergency Unlocking Feature**

In the case of an accident, the doors unlock automatically a short time after a strong deceleration is detected, such as in a collision (this is intended to aid rescue and exit). However, the key must still be in the ignition.

#### **Start Lockout**

Removing the key from the ignition switch activates the start lockout. The engine cannot be started. Turning the key to the ON/RUN position deactivates the start lockout. If the engine cannot be started, and the messages START and ERROR are shown in the odometer display field, the system is not operational. Contact an authorized dealer.

### REMOTE KEYLESS ENTRY

This feature allows you to lock or unlock the vehicle from remote locations using a hand-held transmitter located in the key fob. You don't have to point the transmitter at the vehicle to activate the system. The vehicle doors, rear liftgate, and fuel filler door can be locked and unlocked using the remote control.

#### To Unlock the Doors:

Press and release the unlock button on the key fob.

**NOTE:** If within 40 seconds of unlocking with the key fob, neither door is opened, the key is not inserted in the ignition switch, or the central locking switch is not activated, the vehicle will automatically lock.

Press the Unlock transmit button on the key fob once to unlock driver's door, rear liftgate, and fuel filler door. Press the Unlock transmit button twice to unlock both doors, rear liftgate, and fuel filler door.

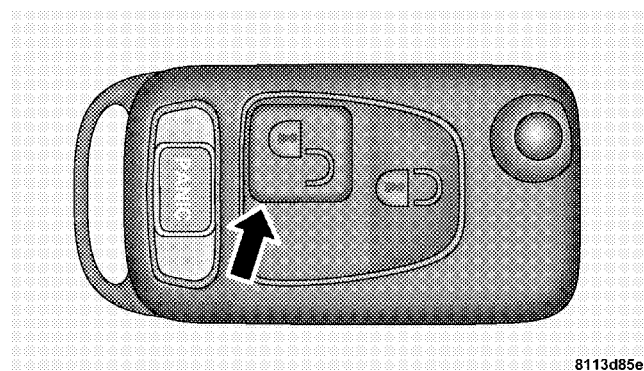

#### To Lock The Doors:

Press the Lock button on the key fob once. All turn signal lights blink three times to indicate that the vehicle is locked. If the turn signal lights do not blink, a door or rear liftgate is not closed properly.

The entire vehicle, including the fuel filler door, may be locked or unlocked by using the key in the driver's door. The doors and liftgate can be locked or unlocked by pressing the central locking switch located in the center console.

If the vehicle cannot be locked or unlocked by pressing the transmit button, then it may be necessary to change the batteries in the remote control.

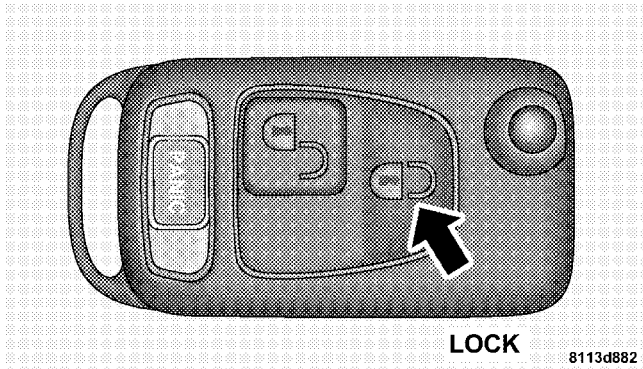

**Panic Alarm**

The panic alarm unlocks the driver's door, turns on the interior lights, flashes the foglights and sounds the horn for about three minutes or until the alarm is turned off. The vehicle can be driven while in the Panic mode.

**To Use the Panic Alarm:**

Press and hold the Panic button to activate the alarm. Press and hold the Panic button or unlock the door with the key to deactivate the alarm. The alarm will also shut off after three minutes or when vehicle speed reaches 15 mph (24 km/h).

2

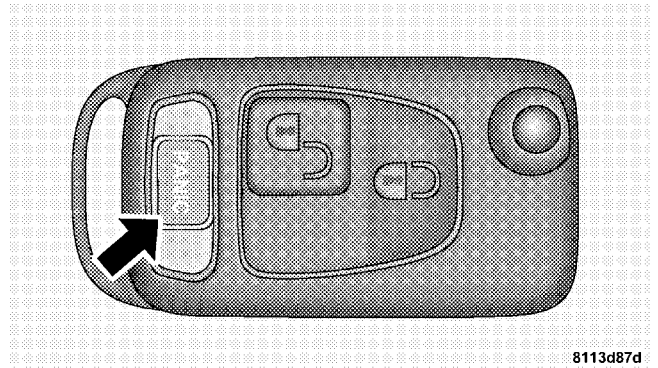

**General Information**

This transmitter complies with FCC rules part 15. Operation is subject to the following conditions:

1. This device may not cause harmful interference.

## 16 THINGS TO KNOW BEFORE STARTING YOUR VEHICLE

2. This device must accept any interference that may be received, including interference that may cause undesired operation.

### Transmitter Battery Service

The recommended replacement Lithium battery is Panasonic® CR 2025 or equivalent.

To change the batteries:

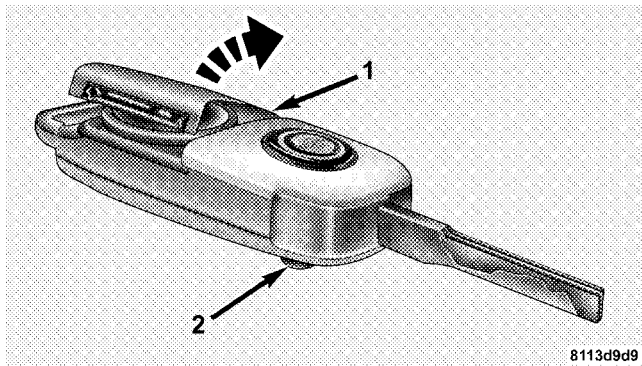

- Press release button (2) on the key fob. The key folds out.
- Press the battery cover (1) in the direction of the arrow.

- Remove the old batteries.

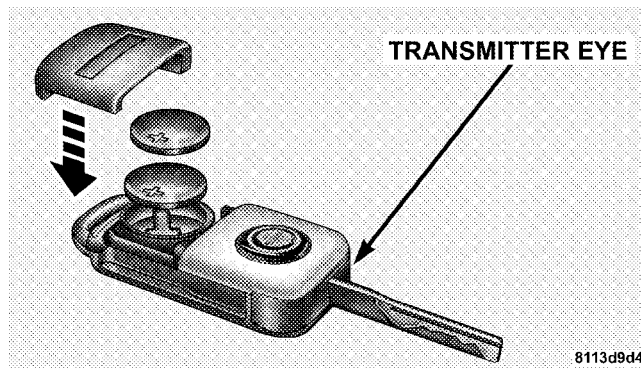

- Insert the new batteries in the direction of the arrow with the positive symbol facing upwards.
- Replace the battery cover and press on it until you feel it engage.

**NOTE:** Only replace the batteries in pairs.

The system may have to be resynchronized if the transmitter is without voltage for several minutes. To synchronize, aim the transmitter eye at the vehicle and briefly press either the Lock or the Unlock button twice. Within



approximately 30 seconds, insert the key in the ignition and turn it to the ON/RUN position. The remote control should once again be operational.

### SECURITY ALARM SYSTEM

The system monitors the doors, rear liftgate, hood, and ignition for unauthorized operation. The security alarm system is automatically armed or disarmed with the remote control or any of your vehicle's keys by locking or unlocking the vehicle.

The antitheft alarm is armed within approximately 10 seconds after locking the vehicle. A blinking light in the tow away alarm switch indicates that the alarm is armed. Once the alarm system has been armed, the exterior vehicle lights will flash and an alarm will sound when a door, the rear liftgate, the hood, or the glove compartment is opened, or if someone attempts to raise the vehicle for towing. The alarm will flash the exterior lamps for approximately three minutes and sound an audible alarm for 30 seconds. The alarm will stay on even if the activating element is immediately closed.

### Tow-Away Alarm

The tow-away alarm switch is located on the console. To deactivate for towing or jacking up the vehicle, press and release the upper portion of the switch. Press and release the lower portion to activate it again.

After the alarm system has been armed, the exterior vehicle lights will flash and an alarm will sound when someone attempts to raise the vehicle. The alarm will flash the exterior lamps for approximately three minutes and sound an audible alarm for 30 seconds. The alarm will stay on even if the vehicle is immediately lowered.

To cancel the alarm, insert the key into the ignition switch or press a transmit button on the key fob.

To prevent triggering the tow-away alarm feature when parking on a surface subject to movement (such as a ferry), switch off the tow-away alarm. To do so, turn the key in the ignition switch to the OFF/LOCK or ACC position, or remove the key from the ignition switch. Press the tow-away alarm switch and the indicator light will illuminate briefly. Exit the vehicle, and lock the vehicle with the key or the remote control.

## 18 THINGS TO KNOW BEFORE STARTING YOUR VEHICLE

The tow-away alarm remains switched off until the vehicle is locked again with the key or the remote control, at which time it is automatically reactivated.

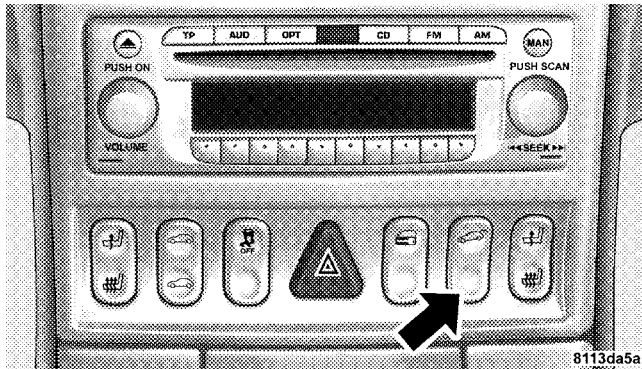

### POWER WINDOWS

The power window switches are located in the console.

To operate, turn the key in the ignition switch to the ACC or ON/RUN position. Press the switch in to the resistance point to open; release the switch when the window is in the desired position.

For express opening of windows, press the switch past the resistance point and release; the window lowers to the fully open position. To interrupt the procedure, briefly press the switch again and release.

When closing the windows, be sure that there is no danger of anyone being harmed by the closing procedure.

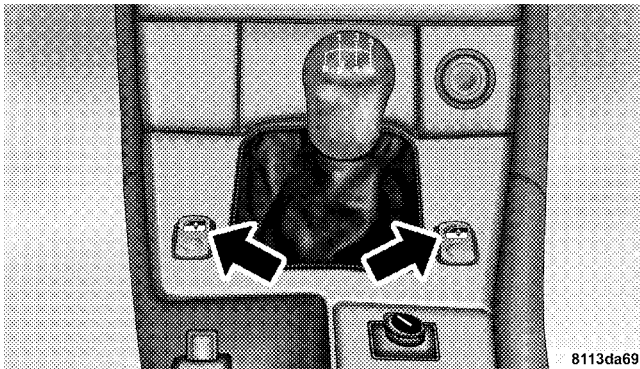

**WARNING!**

When leaving the vehicle, always remove the key from the ignition switch, and lock the vehicle. Do not leave children unattended in the vehicle, or with access to an unlocked vehicle. Unsupervised use of vehicle equipment can cause serious personal injury.

**REAR LIFTGATE RELEASE**

You can open the rear liftgate by using the handle located on the liftgate just above the rear license plate pocket.

2

**WARNING!**

Do not allow children to have access to the rear cargo area by climbing into the rear cargo area from outside, or through the inside of the vehicle. Always close the liftgate when your vehicle is unattended. Once in the cargo area, young children may not be able to escape, even if they entered through the rear seat. If trapped in the cargo area, children can die from suffocation or heat stroke.

**OCCUPANT RESTRAINTS**

Some of the most important safety features in your vehicle are the restraint systems. These include the lap/shoulder seat belts for the driver and passenger, emergency tensioning retractors for the seat belts, and front and side airbags for the driver and passenger. If you will be carrying children too small for adult-size belts, the passenger side seat belt also can be used to hold infant and child restraint systems.

Please pay close attention to the information in this section. It tells you how to use your restraint system properly to keep you and your passengers as safe as possible.

**WARNING!**

**In a collision, you and your passengers can suffer much greater injuries if you are not properly buckled up. You can strike the interior of your vehicle or other occupants, or you can be thrown out of the vehicle. Always be sure you and others in your vehicle are buckled up properly.**

Buckle up even though you are an excellent driver, even on short trips. Someone on the road may be a poor driver and cause a collision that includes you. This can happen far away from home or on your street.

Research has shown that seat belts save lives. They also can reduce the seriousness of injuries in a collision. Some of the worst injuries happen when people are thrown from the vehicle. Seat belts provide protection from that, and they reduce the risk of injury caused by striking the inside of the vehicle. **Everyone** in a motor vehicle needs to be buckled up all the time.

**Lap/Shoulder Belts**

Each seating position is equipped with a combined lap/shoulder belt system.

The belt webbing retractor will lock only during very sudden stops or impacts. This feature allows the shoulder part of the belt to move freely with you under normal conditions. But, in a collision, the belt will lock and reduce the risk of your striking the inside of the vehicle or being thrown out. The seat belts are also equipped with emergency tensioning retractors. These tensioning retractors are located in each belt's inertia reel and become operationally ready with the key in the ignition switch turned to the ACC or ON/RUN positions. The emergency tensioning retractors are designed to activate during frontal and rear impacts. They remove slack from the belts in such a way that the seat belts fit more snugly against the body, restricting its forward movement as much as possible.

In cases of other frontal impacts, rollovers, certain side impacts, rear collisions or other accidents without sufficient frontal or rear impact forces, the emergency tensioning retractors will not be activated. The driver and passenger will then be protected by the fastened seat belts and inertia reel in the usual manner.

**WARNING!**

- **Wearing a seat belt incorrectly is dangerous. Seat belts are designed to go around the large bones of your body. These are the strongest parts of your body and can take the forces of a collision the best. Wearing your belt in the wrong place could make your injuries in a collision much worse. You might suffer internal injuries, or you could even slide out of part of the belt. Follow these instructions to wear your seat belt safely and to keep your passengers safe, too.**
- **Two people should never be belted into a single seat belt. People belted together can crash into one another in an accident, hurting one another badly. Never use a lap/shoulder belt or a lap belt for more than one person, no matter what their size.**

**Lap/Shoulder Belt Operating Instructions**

1. Enter the vehicle and close the door. Sit back and adjust the seat.

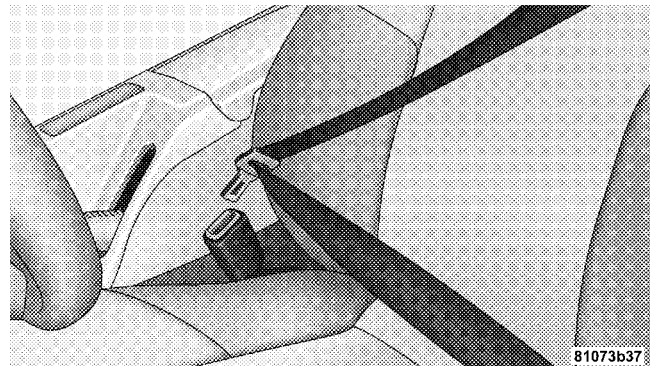

81073b37

2. The seat belt latch plate is above the back of your seat. Grasp the latch plate and pull out the belt. Slide the latch plate up the webbing as far as necessary to make the belt go around your lap.

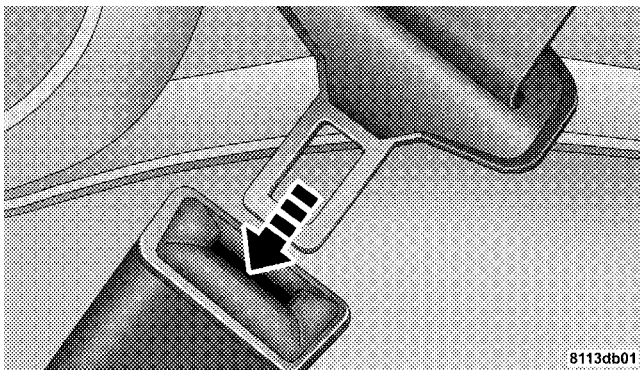

3. When the belt is long enough to fit, insert the latch plate into the buckle until you hear a “click.”

4. Position the lap belt across your thighs, below your abdomen. To remove slack in the lap belt portion, pull up a little on the shoulder belt, as shown.

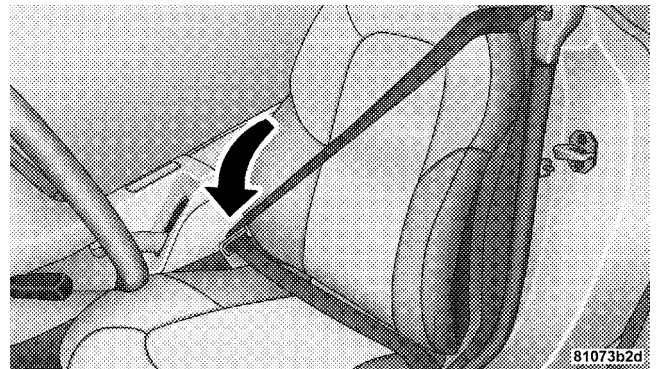

5. To loosen the lap belt if it is too tight, tilt the latch plate away from you and pull on the lap belt. Remember that a snug belt reduces the risk of sliding under the belt in a collision.

6. Position the shoulder belt on your chest so that it is comfortable and not resting on your neck. The retractor will withdraw any slack in the belt.

7. To release the belt, push the red button on the buckle. The belt will automatically retract to its stowed position. If necessary, slide the latch plate down the webbing to allow it to retract fully.

**WARNING!**

- A belt that is buckled into the wrong buckle will not protect you properly. The lap portion could ride too high on your body, possibly causing internal injuries. Always buckle your belt into the buckle nearest you.
- A belt that is too loose will not protect you as well. In a sudden stop you could move too far forward, increasing the possibility of injury. Wear your seat belt snugly.
- A belt that is worn under your arm is very dangerous. Your body could strike the inside surfaces of the vehicle in a collision, increasing head and neck injury. A belt worn under the arm can cause internal injuries. Ribs aren't as strong as shoulder bones. Wear the belt over your shoulder so that your strongest bones will take the force in a collision.
- A shoulder belt placed behind you will not protect you from injury during a collision. You are more likely to hit your head in a collision if you do not wear your shoulder belt. The lap and shoulder belt are meant to be used together.

**WARNING!**

- A lap belt worn too high can increase the risk of internal injury in a collision. The belt forces won't be at the strong hip and pelvic bones, but across your abdomen. Always wear the lap belt as low as possible and keep it snug.
- A twisted belt can't do its job as well. In a collision it could even cut into you. Be sure the belt is straight. If you can't straighten a belt in your vehicle, take it to an authorized dealer and have it fixed.

**WARNING!**

Seat belt systems must always be replaced after an impact severe enough to fire the emergency locking retractors. If there is any question about the condition of your seat belt system, take the vehicle to an authorized dealer for an inspection.



**WARNING!**

**A frayed or torn belt could rip apart in a collision and leave you with no protection. Inspect the belt system periodically, checking for cuts, frays, or loose parts. Damaged parts must be replaced immediately. Do not disassemble or modify the system. Seat belt assemblies must be replaced after an accident if they have been damaged (bent retractor, torn webbing, etc.)**

**Seat Belts and Pregnant Women**

We recommend that pregnant women use the seat belts throughout their pregnancy. Keeping the mother safe is the best way to keep the baby safe.

Pregnant women should wear the lap part of the belt across the thighs and as snug across the hips as possible. Keep the belt low so that it does not come across the abdomen. That way the strong bones of the hips will take the force if there is a collision.

**Seat Belt Extender**

If a seat belt is too short even when fully extended, an authorized dealer can provide you with a seat belt extender. This extender should be used only if the existing belt is not long enough. When it is not required, remove the extender and store it.

**WARNING!**

**Using a seat belt extender when not needed can increase the risk of injury in a collision. Only use the extender when the lap belt is not long enough when it is worn low and snug, and in the recommended seating positions. Remove and store the extender when not needed.**

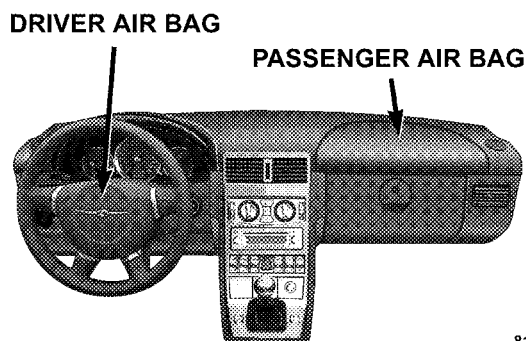
**Supplemental Restraint System (SRS) - Airbag**

81159dba

This vehicle has airbags for the driver and passenger as a supplement to the seat belt restraint systems. The driver's airbag is mounted in the steering wheel. The passenger frontal airbag is mounted in the instrument panel, under a cover marked SRS/AIRBAG.

These airbags inflate in higher speed frontal impacts. They work with the instrument panel knee bolster and the seat belts to provide improved protection for the driver and passenger.

The vehicle is also equipped with side airbags, located in the driver and passenger doors. Side airbags also work with seat belts to improve occupant protection.

**WARNING!**

- Do not put anything on or around the front airbag covers or attempt to manually open them. You may damage the airbags and you could be injured because the airbags are not there to protect you. These protective covers are designed to open only when the airbags are inflated.
- Do not place objects between you and the side airbags; the performance could be adversely affected and/or objects could be pushed into you, causing serious injury.
- Do not attach cup holders or any other objects on or around the door. The inflating side airbag could drive objects into occupants, causing serious injury.

The seat belts are designed to protect you in many types of collisions. The front airbags deploy only in moderate to severe front collisions. In certain types of collisions, both the front and side airbags may be triggered. But even in collisions where the airbags work, you need the seat belts to keep you in the right position for the airbags to protect you properly.

**Here are some simple steps you can take to minimize the risk of harm from a deploying airbag.**

1. Infants in rear-facing child safety seats should **NEVER** ride in the front seat of a vehicle with a passenger frontal airbag unless the airbag is shut OFF. See "Passenger Airbag On/Off Switch" and "To Shut Off the Passenger Airbag." The rear-facing seat places them too close to the passenger air bag in the event of a crash. An airbag deployment can cause severe injury or death to infants in this position.

Children that are not big enough to properly wear the vehicle seat belt (see section on "Child Restraint") should be secured in child safety seats or booster seats that are appropriate for the child's age, height, and weight.

Older children who do not use child safety seats or booster seats should ride properly buckled. Never allow children to place the shoulder belt behind them or under the arm.

If a child from 1 to 12 years old must ride in the vehicle, move the seat as far back as possible, shut off the passenger airbag, and use the proper child restraint. See the section on "Child Restraint."

You should read the instructions provided with your child restraint or belt-positioning booster seat to make sure that you are using it properly.

2. All occupants should wear their lap and shoulder belts properly.
3. The driver and passenger seats should be moved back as far as practical to allow the front airbags room to inflate.
4. Do not lean against the door, as the side airbags will inflate forcefully into the space between you and the door. (See the section on "Side Airbags.")

**WARNING!**

- **Relying on the airbags alone could lead to more severe injuries in a collision. The airbags work with your seat belt to restrain you properly. In some collisions the airbags won't deploy at all. Always wear your seat belts even though you have airbags.**
- **Being too close to the steering wheel or instrument panel during airbag deployment could cause serious injury.**
- **Airbags need room to inflate. Sit back, comfortably extending your arms to reach the steering wheel or instrument panel.**
- **The side airbags also need room to inflate. Do not lean against the door. Sit upright in the center of the seat.**

**Airbag System Components**

The airbag system consists of the following:

- Airbag control module and internal crash sensor

- AIRBAG readiness light
- Driver and passenger frontal airbag/inflator units
- Driver and passenger side airbag/inflator units
- Passenger airbag On/Off switch and indicator light
- Unique steering wheel and column
- Unique instrument panel
- Interconnecting wiring
- Knee impact bolster
- Side impact sensors

**How the Front Airbag System Works**

- A crash sensor in the occupant compartment determines if a frontal impact is severe enough to require the airbag. The sensor will not detect side, roll over, or rear impacts. The sensor is connected to the diagnostic unit and to the airbag/inflator unit.
- The Occupant Restraint Controller monitors the readiness of the electronic parts of the system whenever the ignition switch is in the START or ON/RUN positions.

These include all of the items listed above except the knee bolster, the instrument panel, and the steering wheel and column.

- The Occupant Restraint Controller also turns on the AIRBAG light in the instrument panel for four seconds when the ignition is first turned on, then turns the light off. If it detects a malfunction in any part of the system, it turns on the light either momentarily or continuously depending on the condition that is present at the time.
- The airbag/inflator units are in the center of the steering wheel and in the instrument panel. The words SRS/AIRBAG are embossed on the airbag covers.

### WARNING!

**Ignoring the AIRBAG light in your instrument panel could mean you won't have the airbags to protect you in a collision. If the light does not come on, stays on after you start the vehicle, or if it comes on as you drive, have the airbag system checked right away.**

### WARNING!

**Do not put anything on or around the airbag covers or attempt to manually open them. You may damage the airbags and you could be injured because the airbags are not there to protect you. These protective covers are designed to open only when the airbags are inflated.**

- When the crash sensor detects an impact requiring the airbags, it signals the inflator units. A large quantity of nontoxic nitrogen gas is generated to inflate the airbags. The airbag covers separate and fold out of the way as the airbags inflate to their full size. The airbags then quickly deflate while helping to restrain the driver and passenger. The airbag gas is vented through the airbag material towards the instrument panel. In this way the airbags do not interfere with your control of the vehicle.

### 30 THINGS TO KNOW BEFORE STARTING YOUR VEHICLE

- The knee impact bolster helps protect the knees and working with the seat belts, position you for the best interaction with the airbags.

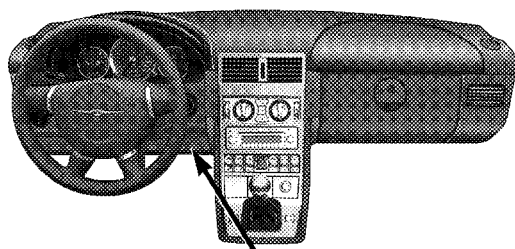

**KNEE BOLSTER**

8113e94b

#### If a Deployment Occurs

##### **WARNING!**

**Deployed airbags can't protect you in another collision. Have the airbags replaced by an authorized dealer as soon as possible.**

The airbag system is designed to deploy when the impact sensors detect a moderate-to-severe frontal collision, to help restrain the driver and passenger, and then to immediately deflate.

**NOTE:** A frontal collision that is not severe enough to need airbag protection will not activate the system. This does not mean something is wrong with the airbag system.

If you do have a collision which deploys the airbags, any or all of the following may occur:

- The nylon airbag material may sometimes cause abrasions and/or skin reddening to the driver and passenger as the airbags deploy and unfold. The abrasions are similar to friction rope burns or those you might get sliding along a carpet or gymnasium floor. They are not caused by contact with chemicals. They are not permanent and normally heal quickly. However, if you haven't healed significantly within a few days, or if you have any blistering, see your doctor immediately.
- As the airbags deflate, you may see some smoke-like particles. The particles are a normal by-product of the

process that generates the nontoxic nitrogen gas used for airbag inflation. These airborne particles may irritate the skin, eyes, nose, or throat. If you have skin or eye irritation, rinse the area with cool water. For nose or throat irritation, move to fresh air. If the irritation continues, see your doctor. If these particles settle on your clothing, follow the garment manufacturer's instructions for cleaning.

- It is not advisable to drive your vehicle after the airbags have been deployed. If you are involved in another collision, the airbags will not be in place to protect you.

#### How the Side Impact Airbag System Works

- The side impact airbags are located in the doors above the armrest.
- Separate crash sensors in the vehicle determine if a side impact is severe enough to require the airbag on the side of the vehicle subjected to an impact. As with the frontal system, the sensors are connected to the diagnostic unit and the airbag/inflator units.

- When a side impact above a predetermined threshold occurs, the sensors signal the inflator on the impacted side of the vehicle. A large quantity of nontoxic nitrogen gas is generated to inflate the airbag. The door panel opens to allow the airbag to inflate to its full size.

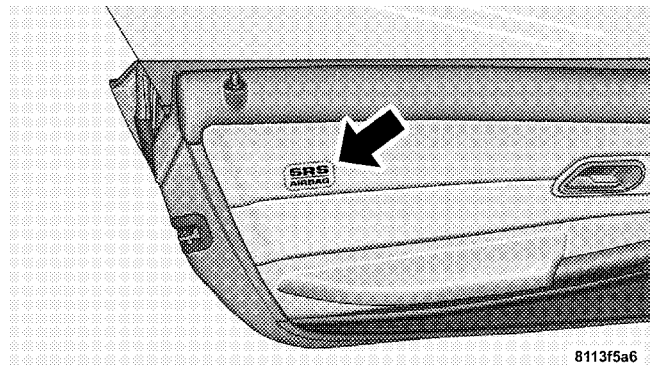

8113f5a6

**WARNING!**

- **Do not put anything on or around the airbag covers or attempt to manually open them. You may damage the airbags and you could be injured because the airbags are not there to protect you. These protective covers are designed to open only when the airbags are inflated.**
- **Do not attach cup holders or any other objects on or around the door. The inflating side airbag could drive the objects into occupants, causing serious injury.**

- The operational readiness of the side airbag system is verified by the airbag indicator light in the instrument cluster when turning the key in the ignition switch to the ON/RUN position. If no fault is detected, the light will go out after approximately four seconds. After the light goes out, the system continues to monitor the components and circuitry of the airbag system and will indicate a malfunction by coming on again. If the light does not come on at all, or if it fails to go out after the four seconds, or if it comes on thereafter, a malfunction in the system has been detected. See your authorized dealer for service.



**WARNING!**

- The door mounted side airbag deploys with considerable force. Being too close to the door panel during airbag deployment could cause serious injury or death.
- All occupants must be in the appropriate restraint for their size and age, especially children 12 and under.
- To help avoid the potential for serious injury and death should the side airbag be activated, please follow these guidelines:
  1. Occupants, especially children, should never lean against the door in the area where the side airbag inflates;
  2. Occupants need to sit upright in the center of the seat to give the side airbag room to inflate;
  3. Always use the appropriate restraint for the occupant and ensure it is properly used.

**Passenger Front Airbag On/Off Switch**

The on/off switch is located at the right end of the instrument panel and is accessible by opening the passenger door.

The on/off switch is to be used only when the passenger is:

- an infant (less than 1 year old),
- a child, age 1 to 12,
- an adult with a medical condition which makes passenger airbag inflation (deployment) a greater risk for the passenger than the risk of hitting the dashboard (instrument panel) or windshield in a crash.

### 34 THINGS TO KNOW BEFORE STARTING YOUR VEHICLE

If the airbag is turned off when there is any other occupant at that position, the supplemental restraint provided by the airbag will not be available.

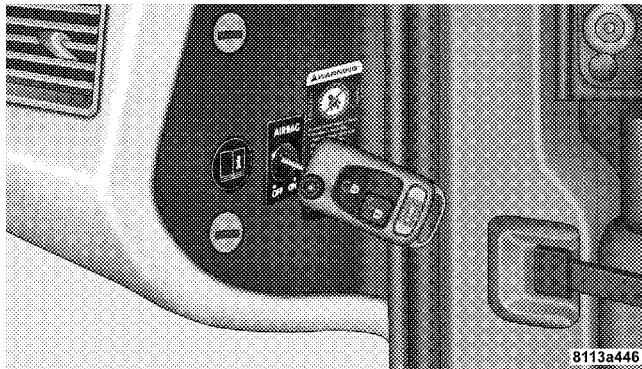

To turn OFF the passenger front airbag, use the on/off switch located on the instrument panel.

**NOTE:** When the passenger airbag is turned off, the yellow airbag off light will illuminate.

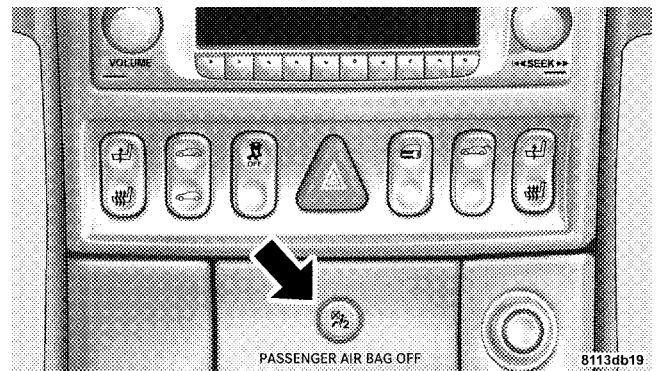

#### To Shut Off the Passenger Airbag:

- Place the ignition key in the on/off switch, turn the key clockwise, and remove the key from the switch. This will shut off the passenger front airbag.
- The air bag will remain off until the switch is turned back to the ON position.

- The switch does NOT turn off the side airbag.

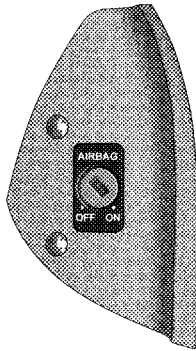

810d7a6f

**To Turn On the Passenger Airbag:**

- Place the ignition key in the on/off switch, turn the key counterclockwise, and remove the key from the switch. This will turn on the passenger airbag. The Passenger Airbag Off light on the console will turn off, or will not be illuminated when the ignition is turned to the ON position.

2

**WARNING!**

**The airbag may malfunction and serious injury could result if key is left in the airbag shut off switch. Always remove the key.**

### Maintaining Your Airbag System

#### WARNING!

- **Modifications to any part of the airbag system could cause it to fail when you need it. You could be injured because the airbag is not there to protect you. Do not modify the components or wiring, including adding any kind of badges or stickers to the airbag covers. Do not modify the front bumper or vehicle body structure.**
- **You need proper knee impact protection in a collision. Do not mount or locate any aftermarket equipment on or behind the knee impact bolster.**
- **You can be injured if you are too close to either airbag cover when the airbags inflate. It is dangerous to try to repair any part of the airbag system yourself. Don't try to repair the airbag system. Be sure to tell anyone who works on your vehicle that it has airbags.**

### Airbag Light



You will want to have the airbags ready for your protection in case of a collision. While the airbag Supplemental Restraint System (SRS) is designed to be maintenance free, if any of the following occurs, have an authorized dealer service the system immediately.

- The AIRBAG light does not come on or flickers during the four seconds when the ignition switch is first turned on.
- The light remains on or flickers after the four second interval.
- The light flickers or comes on and remains on while driving.

### Child Restraint

Everyone in your vehicle needs to be buckled up all the time, babies and children, too. Every state in the United States and all Canadian provinces require that small children ride in proper restraint systems. This is the law, and you can be prosecuted for ignoring it.

**WARNING!**

**In a collision, an unrestrained child, even a tiny baby, can become a missile inside the vehicle. The force required to hold even an infant on your lap could become so great that you could not hold the child, no matter how strong you are. The child and others could be badly injured. Any child riding in your vehicle should be in a proper restraint for the child's size.**

**Infants and Child Restraints**

There are different sizes and types of restraints for children from newborn size to the child almost large enough for an adult safety belt. Always check the child seat Owner's Manual to ensure you have the right seat for your child. Use the restraint that is correct for your child:

- Safety experts recommend that children ride rearward-facing in the vehicle until they are at least one year old and weigh at least 9 kg (20 lbs.). Two

types of child restraints can be used rearward-facing: infant carriers and "convertible" child seats.

- The infant carrier is only used rearward-facing in the vehicle. It is recommended for children who weigh up to about 20 lbs. (9 kg). "Convertible" child seats can be used either rearward-facing or forward-facing in the vehicle. Convertible child seats often have a higher weight limit in the rearward-facing direction than infant carriers do, so they can be used rearward-facing by children who weigh more than 20 lbs. (9 kg) but are less than one year old. Both types of child restraints are held in the vehicle by the lap/shoulder belt or the LATCH child restraint anchorage system. (See the LATCH - Child Seat Anchorage System section.)
- Rearward-facing child seats must **NEVER** be used in the front seat of a vehicle with the front passenger airbag unless the airbag is turned off. An airbag deployment could cause severe injury or death to infants in this position.

**WARNING!**

- A rearward facing infant restraint must not be used unless the passenger airbag has been shut off. A rearward facing infant restraint may be struck by a deploying passenger airbag which may cause severe or fatal injury to the infant.
- Improper installation can lead to failure of a child restraint. It could come loose in a collision. The child could be badly injured or killed. Follow the manufacturer's directions exactly when installing a child restraint.

Here are some tips on getting the most out of your child restraint:

- Before buying any restraint system, make sure that it has a label certifying that it meets all applicable Safety Standards. We also recommend that you make sure that you can install the child restraint in the vehicle where you will use it before you buy it.

- The restraint must be appropriate for your child's weight and height. Check the label on the restraint for weight and height limits.
- Carefully follow the instructions that come with the restraint. If you install the restraint improperly, it may not work when you need it.
- Buckle the child into the seat according to the seat manufacturer's directions.
- When your child restraint is not in use, secure it in the vehicle with the seat belt or remove it from the vehicle. Do not leave it loose in the vehicle. In a sudden stop or collision, it could strike the occupants and cause serious personal injury.

**NOTE:** For additional information refer to [www.seatcheck.org](http://www.seatcheck.org) or call 1-866-SEATCHECK.

**Older Children and Child Restraints**

Children who weigh more than 20 lbs. (9 kg) and who are older than one year can ride forward-facing in the vehicle. Forward-facing child seats and convertible child seats used in the forward-facing direction are for children who weigh 20 to 40 lbs. (9 to 18 kg) and who are older

than one year. These child seats are also held in the vehicle by the lap/shoulder belt or the LATCH child restraint anchorage system. (See LATCH - Child Seat Anchorage System section.)

The belt-positioning booster seat is for children weighing more than 40 lbs. (18 kg), but who are still too small to fit the vehicle's seat belts properly. If the child cannot sit with knees bent over the vehicle's seat cushion while the child's back is against the seat back, they should use a belt-positioning booster seat. The child and belt-positioning booster seat are held in the vehicle by the lap/shoulder belt.

#### **Children Too Large For Booster Seats**

Children who are large enough to wear the shoulder belt comfortably, and whose legs are long enough to bend over the front of the seat when their back is against the seat back, should use the lap/shoulder belt.

- Make sure that the child is upright in the seat.
- The lap portion should be low on the hips and as snug as possible.

- Check belt fit periodically. A child's squirming or slouching can move the belt out of position.
- If the shoulder belt contacts the face or neck, move the child closer to the center of the vehicle. Never allow a child to put the shoulder belt under an arm or behind their back.

#### **LATCH - Child Seat Anchorage System (Lower Anchors and Tether for Children)**

Your vehicle's passenger seat is equipped with the child restraint anchorage system called LATCH. The LATCH system provides for the installation of the child restraint without using the vehicle's belts, instead securing the child restraint using lower anchorages and upper tether straps from the child restraint to the vehicle structure. LATCH-compatible child restraints are now available.

#### **Installing the LATCH-Compatible Child Restraint System**

We urge that you carefully follow the directions of the manufacturer when installing your child restraint. These

#### 40 THINGS TO KNOW BEFORE STARTING YOUR VEHICLE

are general instructions, and not all child restraint systems will be installed exactly as described here. Again, carefully follow the installation instructions that were provided with the child restraint system.

The passenger seat lower anchorages are round bars, located at the rear of the seat cushion where it meets the seat back, and are just visible when you lean in to install the child restraint. You will easily feel them if you run your finger along the intersection of the seat back and seat cushion surfaces.

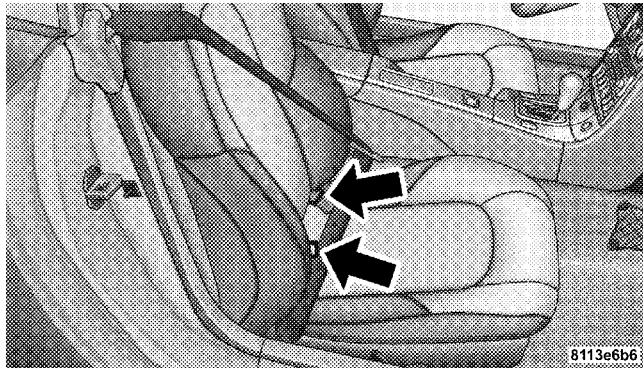

The passenger seat tether anchorage is located on the back of the seat cushion frame. It is visible by moving the passenger seat forward in the vehicle.

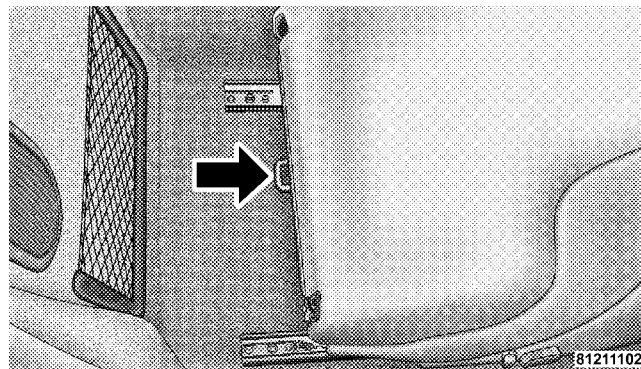

Many, but not all LATCH-Compatible child restraint systems will be equipped with separate straps on each side, with each having a hook or connector for attachment to the lower anchorage and a means of adjusting the tension in the strap. Forward-facing toddler restraints and some rear-facing infant restraints will also be



equipped with a tether strap, a hook for attachment to the tether strap anchorage and a means of adjusting the tension of the strap.

You will first loosen the adjusters on the lower straps and on the tether strap so that you can more easily attach the hooks or connectors to the vehicle anchorages. Next, you can attach the tether strap to the anchor by moving the passenger seat forward. Route the child restraint tether directly over the top of the seat, through the strap near the top of the seat back, and attach the hook to the anchor bar. Recline the seat back and move the passenger seat as far rearward as possible. Next, attach the lower hooks to the passenger seat lower anchor bars by pushing aside the seat cover material. Finally, tighten all three straps as you push the child restraint rearward and downward into the seat, removing slack in the straps according to the child restraint manufacturer's instructions.

### WARNING!

**Improper installation of a child restraint to the LATCH anchorages can lead to failure of an infant or child restraint. The child could be badly injured or killed. Follow the manufacturer's directions exactly when installing an infant or child restraint.**

2

#### **Installing Child Restraints Using the Vehicle Seat Belt**

Child restraints can be securely fastened in the passenger seat using the seat belts. For this purpose, the passenger seat belt retractor provides two modes of operation - normal emergency locking and automatic locking. For child restraint installation, the retractor switches to automatic locking when the belt is pulled out to the full extent of its travel. As the belt retracts, the retractor locks to prevent the belt from being pulled out again. Pulling the belt snugly over the child restraint toward the retractor secures the restraint in place. When the belt retracts fully after child restraint removal, normal (emergency locking)

retractor action is restored. Any seat belt system will loosen with time, so check the belt occasionally and pull it tight if necessary.

If your child restraint is equipped with a tether strap, attach it to the vehicle by first moving the seat back fully forward. Next, route the child restraint tether directly over the top of the seat, through the strap near the top of the seat back, and attach the hook to the anchor bar. Recline the seat back and move the passenger seat as far rearward as possible. Remove slack in the tether strap as you push the child restraint downward and rearward, following the child restraint manufacturer's instructions.

#### **Child Restraint Tether Anchor - General Information**

Child restraints having tether straps and hooks for connection to tether anchors have been available for some time. In fact, many child restraint manufacturers will provide add-on tether strap kits for certain of their older products. There is a tether strap anchor behind the passenger seat.

To attach the tether strap to the anchor, move the seatback fully forward. Pass the child restraint tether

hook over the top of the seat, through the strap near the top of the seat back, and attach it to the anchor bar behind the passenger seat, below the seatback. After securing the tether hook to the bar, recline the seatback fully rearward and move the seat to its most rearward position.

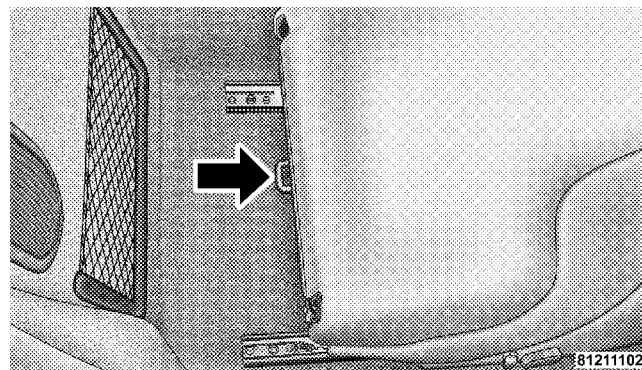

Install the child restraint and return the seatback to an upright position. Remove slack from the tether strap according to the child restraint manufacturer's directions.

**WARNING!**

**An incorrectly anchored tether strap could lead to increased head motion and possible injury to the child. Use only the anchor position directly behind the child seat to secure a child restraint top tether strap.**

**Transporting Pets**

Deploying airbags could harm your pet. An unrestrained pet will be thrown about and possibly injured, or injure a passenger during panic braking or in a collision.

Pets should be restrained in pet harnesses or pet carriers that are secured by seat belts.

**ENGINE BREAK-IN RECOMMENDATIONS**

The engine in your new Crossfire does not require a long break-in period. Following these few simple guidelines is all that is necessary for a good break-in.

- Drive your vehicle at moderate vehicle and engine speeds during the first 1,000 miles (1,600 km).
- Do not make any full throttle starts and avoid full throttle acceleration.
- Use the proper transmission gear for your speed range.
- Avoid excessive idling.
- Check the engine oil level at every fuel fill.

**NOTE:** A new engine may consume some oil during the first few thousand miles of operation. This should be considered as a normal part of the break-in and not an indication of a problem.

**SAFETY TIPS****Exhaust Gas****WARNING!**

**Exhaust gases can injure or kill. They contain carbon monoxide (CO) which is colorless and odorless. Breathing it can make you unconscious and can eventually poison you. To avoid breathing (CO) follow the safety tips below.**

- Do not run the engine in a closed garage or in confined areas any longer than needed to move your vehicle in or out of the area.
- If it is necessary to sit in a parked vehicle with the engine running, adjust your heating or cooling controls to force outside air into the vehicle. Set the blower at high speed.
- To avoid drawing exhaust gases into the vehicle, close the rear liftgate while driving. However, if for some reason it must remain open, close all windows. Adjust

the heating or cooling system to force outside air into the vehicle. Set the blower at high speed.

**Safety Checks You Should Make Inside the Vehicle****Seat Belts**

Inspect the belt system periodically, checking for cuts, frays and loose parts. Damaged parts must be replaced immediately. Do not disassemble or modify the system.

Seat belt assemblies must be replaced after an accident if they have been damaged (bent retractor, torn webbing, etc.). If there is any question regarding belt or retractor condition, see your authorized dealer.

**Airbag Light**

The light should come on and remain on for four seconds as a bulb check when the ignition switch is first turned ON. If the bulb is not lit during starting, have it replaced. If the light stays on or comes on while driving, have the system checked by an authorized dealer.

**Defrosters**

Check operation by pressing the A/C control button, selecting the defrost mode and placing the blower control on high speed. You should be able to feel the air directed against the windshield.

**Periodic Safety Checks You Should Make Outside the Vehicle****Tires**

Examine tires for excessive tread wear or uneven wear patterns. Check for stones, nails, glass, or other objects lodged in the tread. Inspect for tread cuts or sidewall cracks. Check wheel nuts for tightness and tires for proper pressure.

**Lights**

Have someone observe the operation of exterior lights while you work the controls. Check turn signal and high beam indicator lights on the instrument panel.

**Fluid Leaks**

Check area under vehicle after overnight parking for fuel, water, oil, or other fluid leaks. Also, if gasoline fumes are present, the cause should be corrected immediately.

**NOTE:** Use of the air conditioning may cause puddles of water to form under the vehicle.



---

# UNDERSTANDING THE FEATURES OF YOUR VEHICLE

## CONTENTS

---

■ Console Features . . . . .	.49	□ Outside Mirrors . . . . .	.55
□ Storage Compartments . . . . .	.49	□ Power Remote Control Outside Mirrors . . . . .	.56
□ Ashtray . . . . .	.51	□ Vanity Mirrors . . . . .	.57
□ Coin Holder . . . . .	.52	■ Seats . . . . .	.57
□ Power Outlet/Cigar Lighter . . . . .	.52	□ Driver Eight-Way Power Seat . . . . .	.57
□ Glove Compartment . . . . .	.53	□ Passenger Four-Way Power Seat . . . . .	.58
■ Cupholder . . . . .	.53	□ Heated Seats . . . . .	.59
■ Mirrors . . . . .	.54	■ To Open And Close The Hood . . . . .	.59
□ Adjusting The Inside Day/Night Mirror . . . . .	.54	■ Interior Lights . . . . .	.60
□ Exterior Mirrors Folding Feature . . . . .	.55	□ Front Map/Reading Lights . . . . .	.61
□ Heated Remote Control Mirrors . . . . .	.55	□ Battery Saver Feature . . . . .	.61

#### 48 UNDERSTANDING THE FEATURES OF YOUR VEHICLE

□ Instrument Panel Lighting . . . . .	.61	■ Brake Assist System (BAS) . . . . .	.73
□ Night Security Illumination . . . . .	.61	■ Electronic Stability Program (ESP) . . . . .	.74
■ Exterior Lights . . . . .	.62	□ Synchronizing ESP . . . . .	.76
□ Headlights And Parking Lights . . . . .	.62	■ Electronic Speed Control . . . . .	.77
□ Daytime Running Lights (Where Applicable) . . . . .	.62	□ To Vary The Speed Setting . . . . .	.78
□ Fog Lights . . . . .	.63	□ To Deactivate . . . . .	.79
□ Standing Lights . . . . .	.63	□ To Resume Speed . . . . .	.79
■ Multifunction Control Lever . . . . .	.64	□ Using Speed Control On Hills . . . . .	.79
□ Turn Signals . . . . .	.64	■ Garage Door Opener . . . . .	.80
□ Headlight Dimmer Switch . . . . .	.65	□ Programming The Universal Transceiver . . . . .	.81
□ Passing Light . . . . .	.65	□ Gate Operator/Canadian Programming . . . . .	.83
□ Windshield Wipers And Washer . . . . .	.66	□ Using The Universal Transceiver . . . . .	.84
□ Mist Function . . . . .	.66	□ Erasing Universal Transceiver Buttons . . . . .	.84
■ Telescoping Steering Column . . . . .	.67	□ Reprogramming a Single Button . . . . .	.84
■ Tire Pressure Monitor System . . . . .	.68	□ Security . . . . .	.85
■ Rear Spoiler . . . . .	.71	■ Umbrella Hook . . . . .	.85



### CONSOLE FEATURES

The console has a power outlet/cigar lighter, an ash tray with a coin holder, a cupholder, and the passenger airbag light. In addition, there are switches to control the heated seats, rear spoiler, electronic stability program (ESP), hazard flashers, central locking, rear defroster and towing alarm.

Operating controls for the heating and air conditioning systems, power windows, power mirrors, and the automatic transmission program mode selector switch (if equipped) are also located in the console.

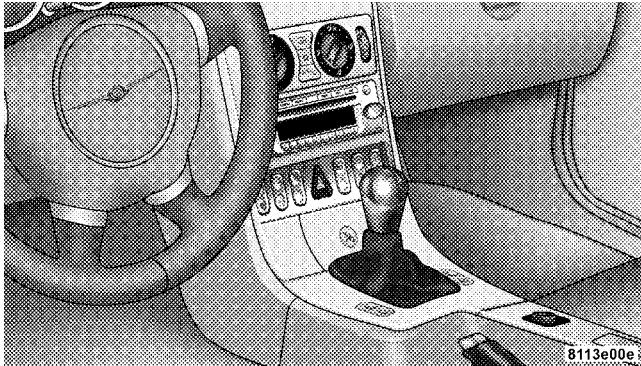

### Storage Compartments

There is a storage compartment in the console. To open the storage compartment, lift the lid with the finger depressions on either side. To close, lower the lid until the lock engages.

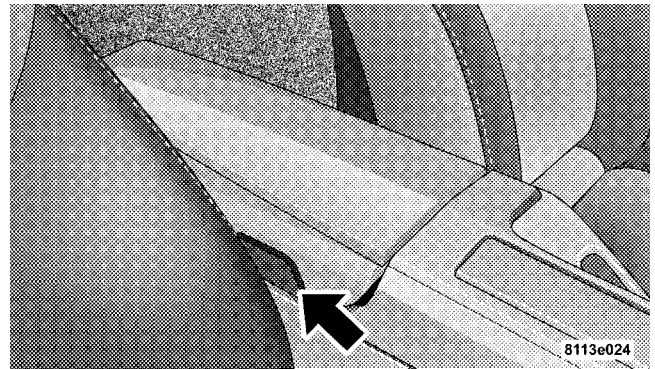

3

50 UNDERSTANDING THE FEATURES OF YOUR VEHICLE

A cargo net for storage is located in the footwell area on the passenger side.

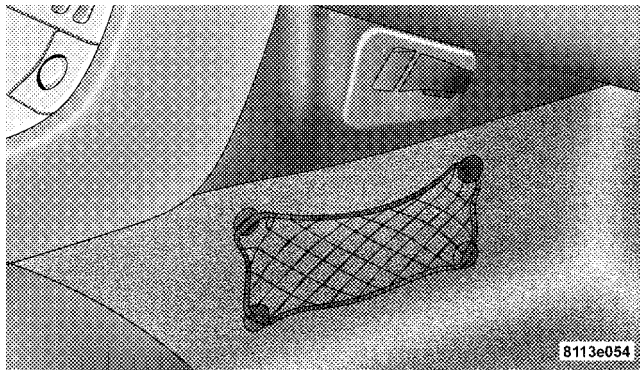

Additionally, storage pockets are located on the wall behind each seat and on each door panel.

A storage pouch is located on the rear wall between the seats, and the driver's sunvisor has a document strap.

**WARNING!**

**Keep compartment lids closed. This will help to prevent stored objects from being thrown about and injuring vehicle occupants during an accident.**

**Ashtray**

Lightly touch the bottom of the ashtray cover. The ashtray will open automatically.

To remove the ashtray insert, pull the ashtray past the detent. Hold both sides of the insert, and pull up. To install the ashtray, place it in the frame and push down to engage.

**WARNING!**

**Remove the ashtray only with the vehicle stopped and the ignition off. Otherwise, the vehicle might move unexpectedly as a result of unintended contact with the gear selector lever.**

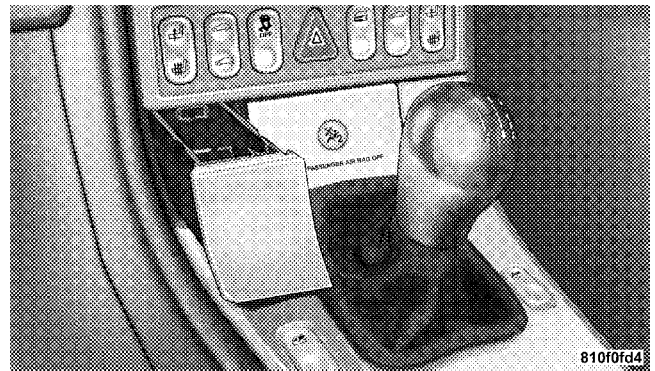

**Coin Holder**

With the ashtray open, folding down the cover plate reveals the coin holder, which can accommodate nine coins in various sizes up to a U.S. quarter. The coin slots are shaped to retain the coins, and the cover plate ensures that the coins remain in the coin holder.

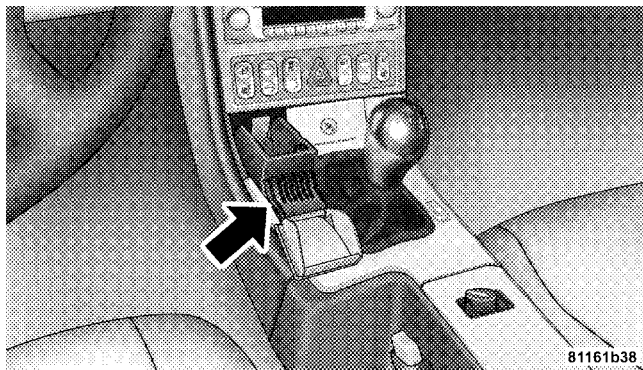
**Power Outlet/Cigar Lighter**

The dual-purpose power outlet is located in the console, next to the passenger airbag off warning light. The power outlet can accommodate a lighter or electrical accessories

up to a maximum of 15 amps. The outlet is protected by a 15 amp fuse, located behind the fuse cover on the left end of the instrument panel.

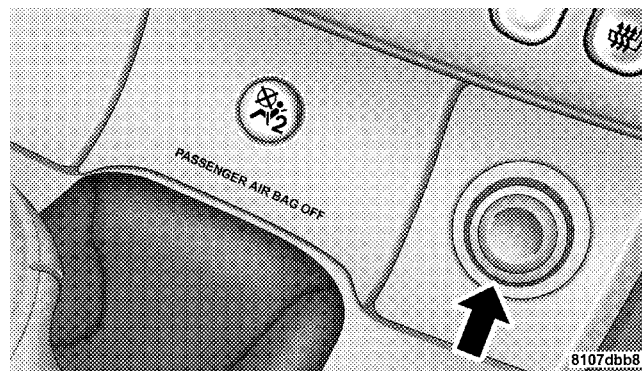

The lighter will operate only when the ignition switch is in the ON/ACC position. It heats up when pushed in and pops out automatically when ready for use. To preserve the heating element, do not hold the lighter in the heating position.

**Glove Compartment**

To lock the glove compartment, turn the key to the right and remove. To unlock, turn the key to the left and remove.

Pull on the handle to open the glove compartment.

**CUPHOLDER**

The cupholder is located in the console. To open the cupholder, gently press downward on the front edge of the top panel, and then release. The cupholder will open automatically.

When the cupholder is no longer needed, push forward on the top edge of the door and rotate it down into the console until it engages.

The cupholder is designed to hold beverage containers up to 20 oz. (1 L).

**CAUTION!**

**Only use containers that fit into the cupholder. Overfilled containers could spill during vehicle maneuvers.**

## MIRRORS

### Adjusting The Inside Day/Night Mirror

The mirror should be adjusted to center on the view through the rear window.

### Automatic Dimming Mirror Feature

When the ignition switch is in the ON or RUN position, the automatic antiglare feature is activated. This feature automatically responds to changes in light sensitivity, and adjusts mirror brightness accordingly.

To aid visibility while backing the vehicle, the dimming feature is turned off when reverse gear is selected.

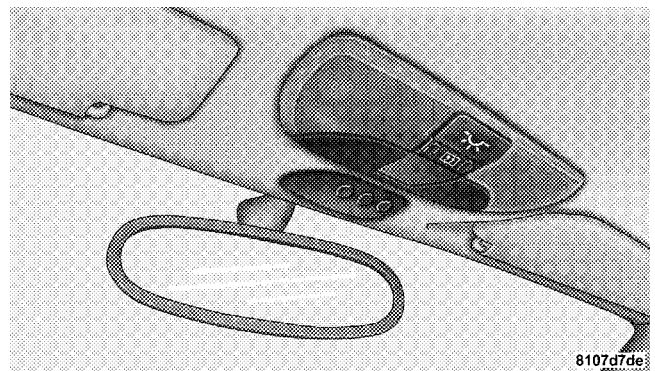

### WARNING!

**If the mirror breaks in an accident, liquid electrolyte may escape the mirror housing. Liquid electrolyte has an irritating effect. Do not allow the liquid to come into contact with eyes, skin, respiratory system, or clothing. Should this occur, immediately flush the affected area with water and seek medical help if necessary.**

**Exterior Mirrors Folding Feature**

All exterior mirrors are hinged to move forward or rearward to resist damage. The hinges have three detent positions: full forward, full rearward, and normal.

**Heated Remote Control Mirrors**

Both outside mirrors are heated to melt frost or ice when the Rear Window Defroster switch is depressed.

**Outside Mirrors**

Adjust the outside mirrors to center on the adjacent lane of traffic, with a slight overlap of the view seen in the inside mirror.

**WARNING!**

**Vehicles and other objects seen in the passenger side convex mirror will look smaller and farther away than they actually are. Relying too much on your passenger side mirror could cause you to collide with another vehicle or other object. Use your inside mirror to judge the size or distance of objects seen in the convex mirror.**

### Power Remote Control Outside Mirrors

The mirrors can be adjusted by using the remote control located in the console. Rotate the switch to the right to select the right mirror, rotate to the left to select the left mirror. Then use the switch to adjust the selected mirror to the desired direction.

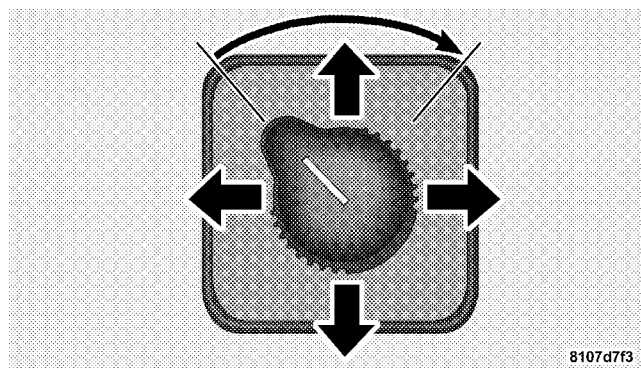
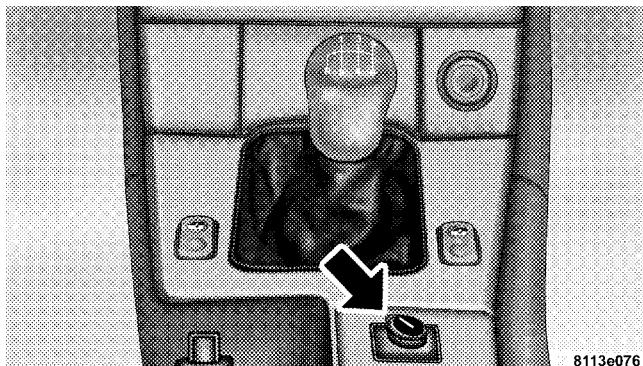



**Vanity Mirrors**

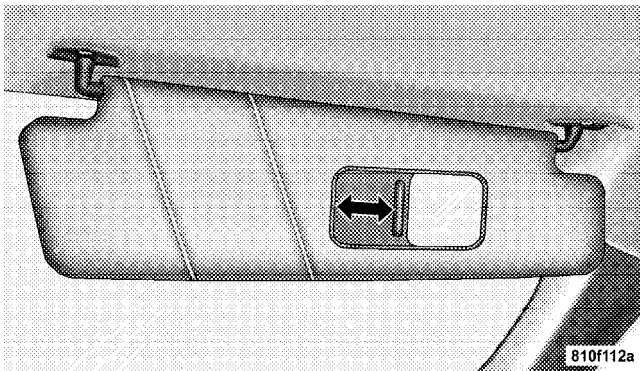

A vanity mirror is on each sun visor. To use the mirror, rotate the sun visor down and slide open the mirror cover.

**SEATS**

**Driver Eight-Way Power Seat**

The switches to adjust the power seats are located on the outboard side of each seat. The driver's seat features eight-way power adjustment - horizontal, vertical, cushion tilt and back angle.

3

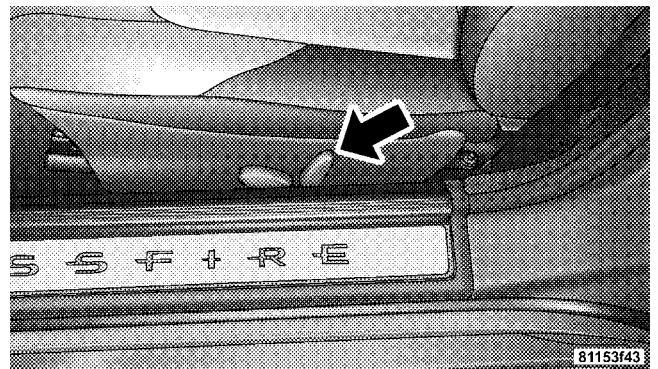

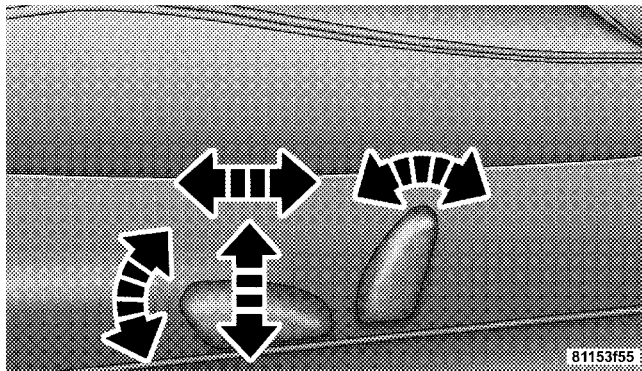

### Passenger Four-Way Power Seat

The switches to adjust the passenger seat are also on the outboard side of the seat. The passenger seat provides four-way adjustment - horizontal and back angle.

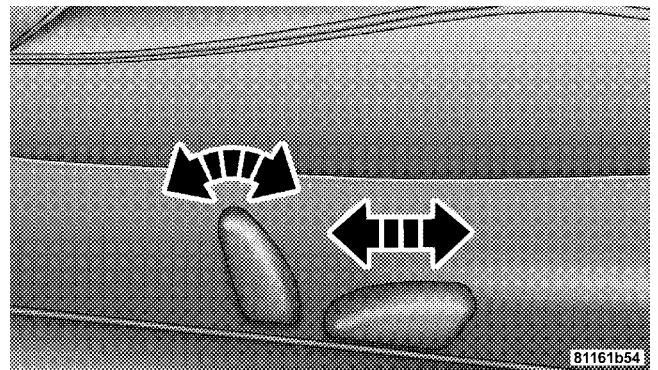

### Heated Seats

This feature heats the driver and passenger seats. The controls for the heated seats are located on the instrument panel, below the radio.

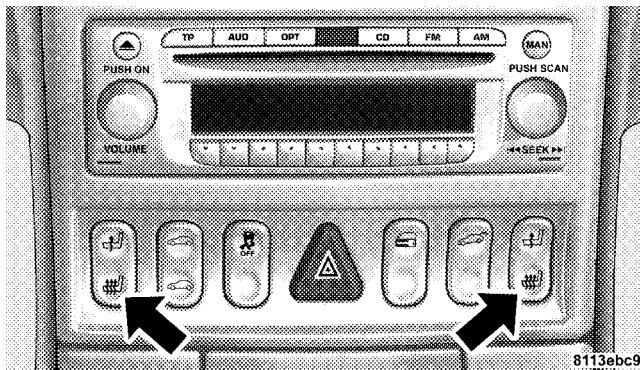

After turning the ignition switch ON, you can choose the HI, LO, or OFF setting. Indicators on the switches show which setting has been selected.

The heated seats setting will automatically switch from HI to LO after approximately 5 minutes.

### TO OPEN AND CLOSE THE HOOD

To open the hood, pull the release lever located inside your vehicle, below the instrument panel.

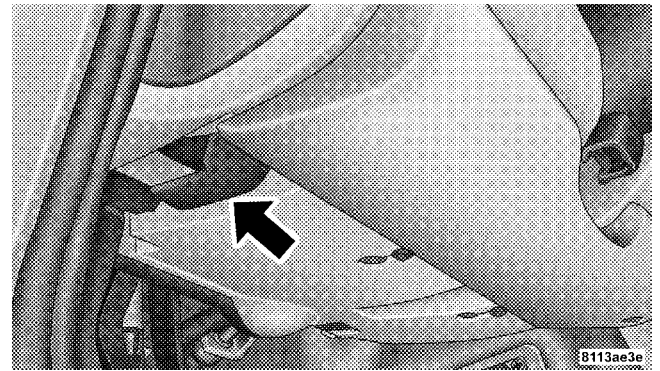

Then, reach under the hood and pull upward on the safety latch and lift the hood.

To prevent possible damage, close the hood by dropping it from approximately 12 inches (30 cm).

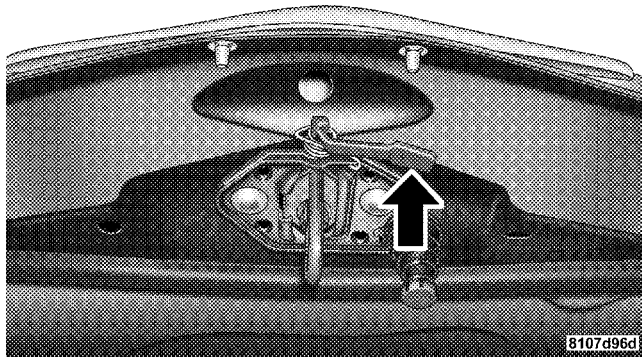

**WARNING!**

**If the hood is not fully latched, it could fly up when the vehicle is moving, and block your forward vision. You could have a collision. Be sure all hood latches are fully latched before driving.**

**INTERIOR LIGHTS**

A two-position mode selector switch controls the interior lights located in the overhead console.

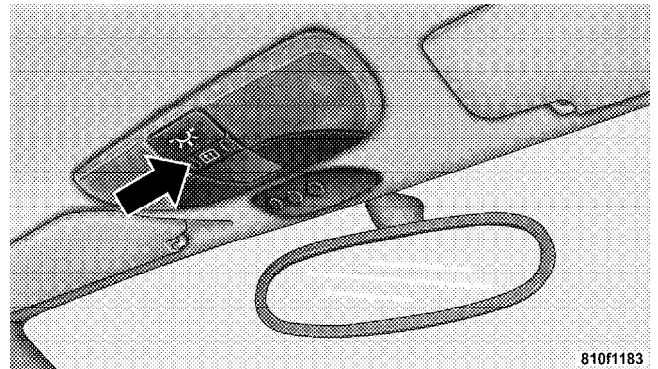

The AUTO mode turns the lights on when a door is open or ajar, or when locking or unlocking the vehicle. AUTO mode also has a "fade to off" feature. When the doors are closed or locked, they gradually "fade" off.

The OFF position turns off the interior lights feature.

**Front Map/Reading Lights**

These lights are located between the sun visors. A single centrally located switch operates both lights.

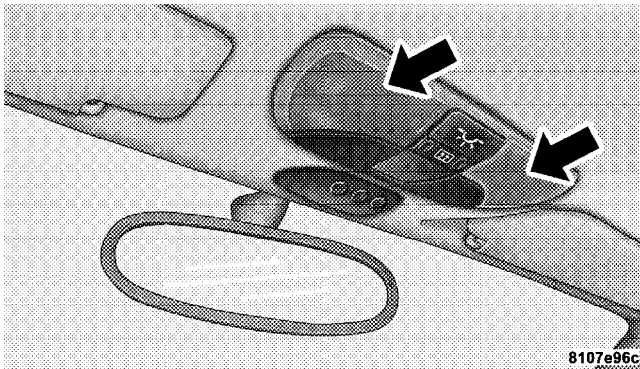

**Battery Saver Feature**

To prevent battery drain if a door is left open or ajar, the interior lights will turn off automatically after 15 minutes. After the door is closed, the interior lights will return to their normal function.

**Instrument Panel Lighting**

With the parking lights or headlights on, rotate the dimmer control to the left of the speedometer to increase or decrease brightness of the instrument panel.

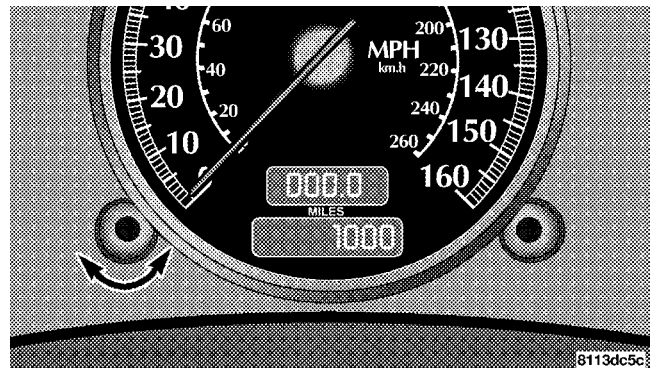

3

**Night Security Illumination**

For added security when exiting the vehicle after driving with the exterior lights on, the lights will switch on again for approximately 30 seconds after closing the last door. The lights-on timing can be changed at your authorized dealer.

## EXTERIOR LIGHTS

### Headlights and Parking Lights

When the headlight switch is turned clockwise from OFF to the first position, the parking lights, taillights, side marker lights, license plate lights and instrument panel lights are all illuminated.

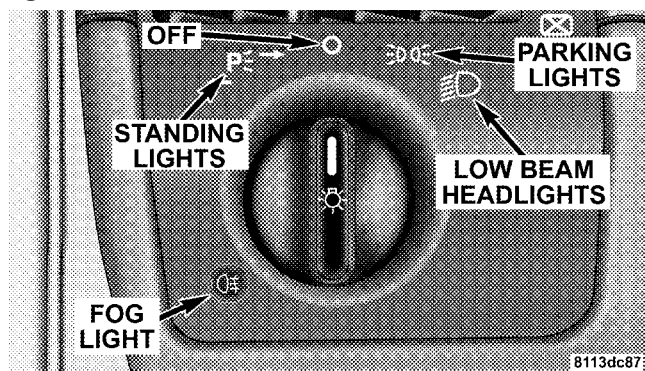

The headlights turn on when the switch is turned to the second position.

### Lights-On Reminder

If the headlights or parking lights are left on after the ignition is turned off, a warning will sound if the driver's door is opened.

### Daytime Running Lights (Where Applicable)

#### VEHICLES WITH AUTOMATIC TRANSMISSION

The low beam headlights, parking lights, side marker lights, taillights and license plate lights are automatically switched on whenever the vehicle is started and the transmission gear selector is in a driving position.

#### VEHICLES WITH MANUAL TRANSMISSION

The low beam headlights, parking lights, side marker lights, taillights, and license plate lights are automatically switched on whenever the vehicle is started and the parking brake is released.

For nighttime driving, the exterior lights switch should be in the low beam position to permit activation of the high beam headlights.

**Fog Lights**

To operate the fog lights, pull the headlight switch out one stop, with the parking lights and/or low beam headlights on. A light to the lower left of the headlight switch will illuminate when the fog lights are on.

To turn off the fog lights, push the headlight switch in fully. Selecting high beam headlights will also turn off the fog lights.

**Standing Lights**

When the vehicle is parked on the street, the standing lights (left or right side parking lights) can be turned on, making your vehicle more visible to passing vehicles.

To operate the standing lights, turn the headlight switch counterclockwise one stop (right lamps) or two stops (left lamps) from the OFF position. To turn off the standing lights, return the headlight switch to the OFF position.

The standing lights cannot be operated when the ignition switch is in the ON/RUN position.

**CAUTION!**

**Standing lamps are intended for short term use when parking. If these lights are left on for a long period of time, your car's battery may drain, causing a possible starting problem. Assure that the headlamp switch is in the OFF position when leaving the vehicle.**

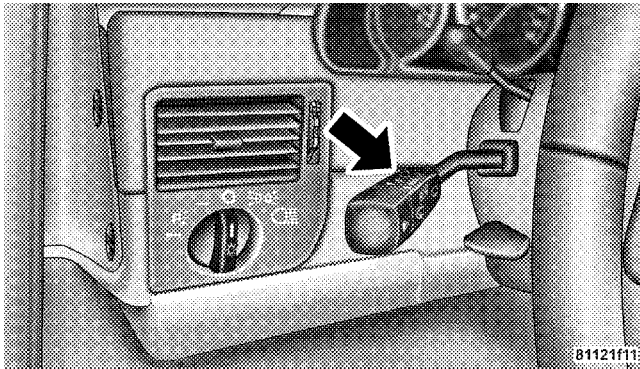
**MULTIFUNCTION CONTROL LEVER****Turn Signals**

Move the multifunction control lever up to activate the right turn signal; move the lever down to activate the left turn signal. An arrow on the inside of the speedometer will flash to indicate operation.

To signal minor directional changes, such as changing lanes, move the control lever just to the point of resistance, and hold it there.

To operate the turn signals continuously, move the control lever up or down past the point of resistance. The operation is automatically canceled when the steering wheel is turned to a large enough degree.

If one of the turn signal lights fail, the turn signal indicator system flashes and sounds at a faster than normal rate. If an indicator fails to light when the control lever is moved, it may mean that the fuse or indicator bulb is defective.

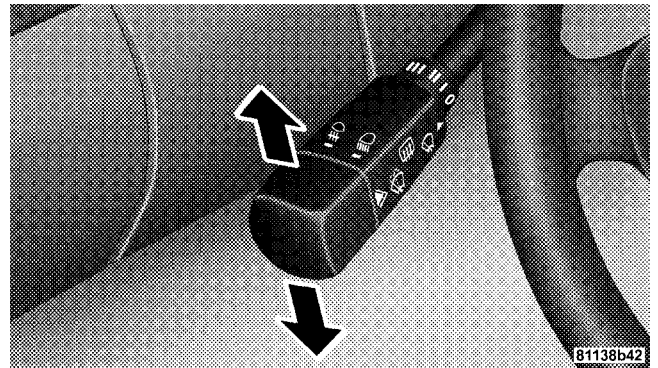



**Headlight Dimmer Switch**

Push the multifunction control lever toward the instrument panel to turn the headlights to high beam. Pull the lever toward you to switch to low beam.

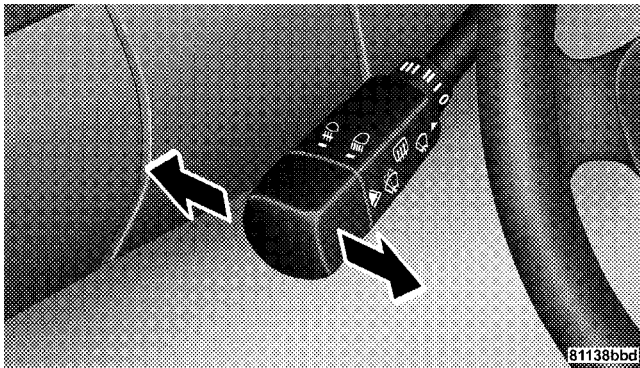

**Passing Light**

You can signal another vehicle with your headlights by lightly pulling the multifunction control lever toward the steering wheel. This will cause the headlamps to turn on at high beam and remain on until the control lever is released.

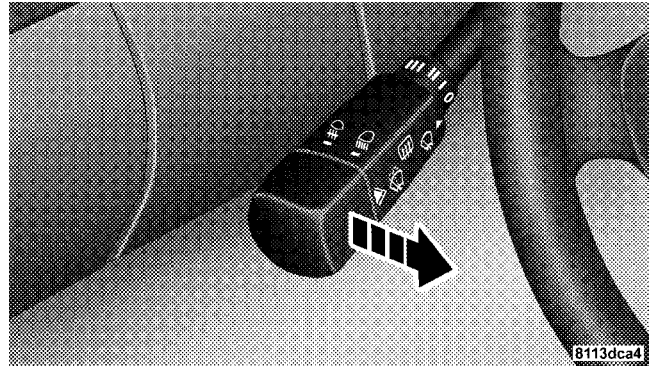

### Windshield Wipers And Washer

The wipers and washer are operated by a switch in the multifunction control lever. Turn the end of the lever to select desired wiper speed: off, intermittent, normal, or fast.

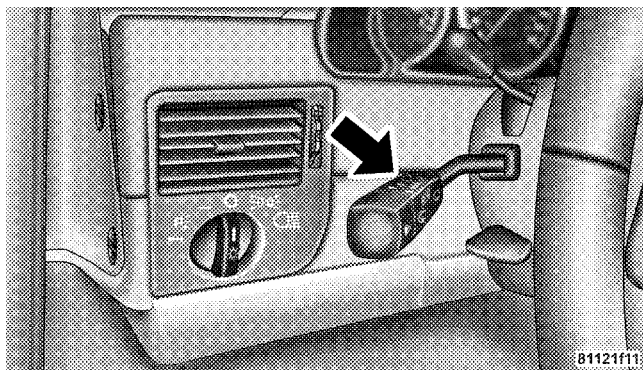

Push the end of the lever inward and hold it to activate the wiper and washer together.

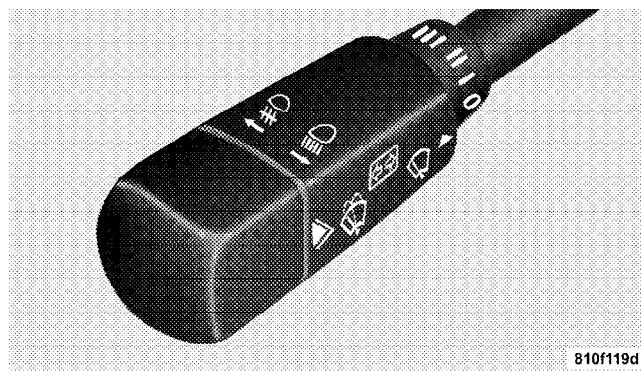

### Mist Function

Push the end of the multifunction control lever inward briefly for a single wipe without adding washer fluid. Use this feature only when the windshield is wet.

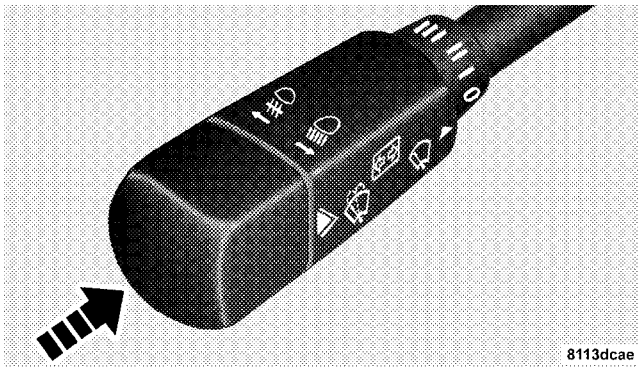

8113dcae

**WARNING!**

Sudden loss of visibility through the windshield could lead to an accident. You might not see other vehicles or other obstacles. To avoid sudden icing of the windshield during freezing weather, warm the windshield with the defroster before and during windshield washer use.

**TELESCOPING STEERING COLUMN**

Unlock the steering column by pulling out the handle located directly below the column. The indicator light located in the instrument cluster will come on. To lengthen or shorten the steering wheel, pull out or push in the steering wheel. Lock the steering column in position by pushing the handle in until it engages. The indicator light in the instrument cluster will go out.

3

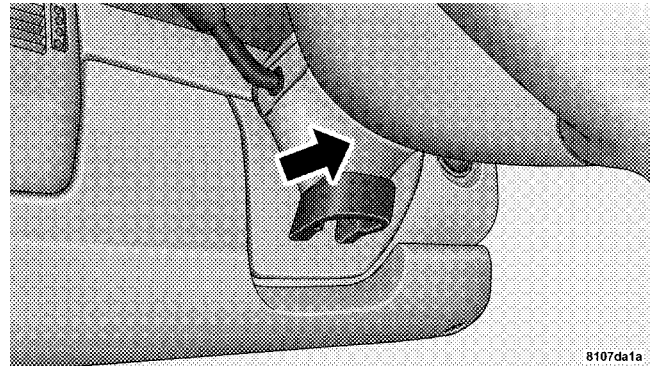

8107da1a

**WARNING!**

Do not adjust the steering wheel while driving. The telescoping adjustment must be locked while driving. Adjusting the steering wheel while driving, or driving without the telescoping adjustment locked could cause the driver to lose control of the vehicle.

**NOTE:** If the indicator light in the instrument cluster does not go out after starting the engine, the telescoping column is not locked properly. Do not drive the vehicle until you have properly locked the steering column.

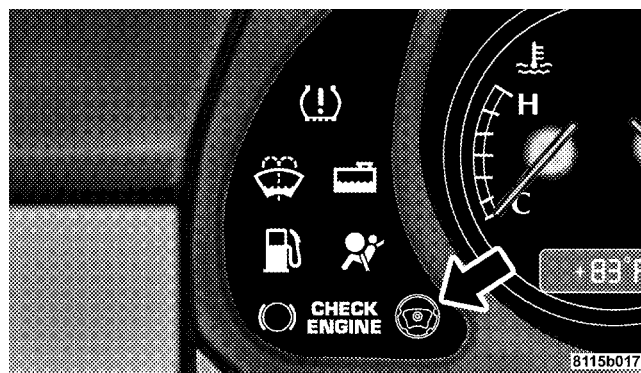
**TIRE PRESSURE MONITOR SYSTEM**

The Tire Pressure Monitor (TPM) system uses wireless technology to monitor tire pressure levels. Sensors mounted to each wheel as part of the valve stem transmit tire pressure readings to a receiver located inside the vehicle.

**NOTE:** The TPM system can inform you about a low tire pressure condition, but it does not replace normal tire maintenance. The TPM system is not intended to provide you with notification of rapid tire pressure loss.

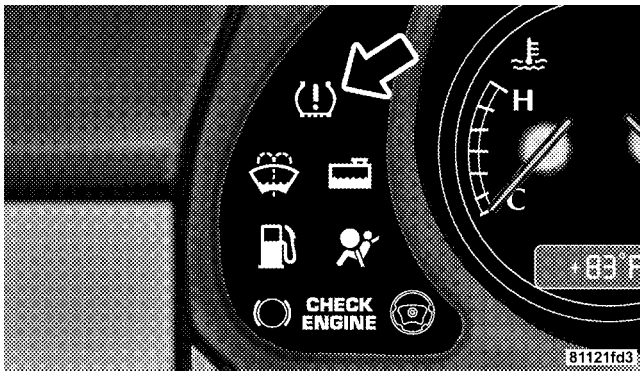

**CAUTION!**

The TPM system is designed to monitor your tire pressure and will not function as a tire pressure gauge. After adjusting the air pressure in a tire, there will be a delay before the system updates the display.

The TPM system will cause the indicator lamp in the instrument cluster to illuminate whenever the pressure in one tire falls 25% below the recommended pressure shown on the vehicle's tire label.

**NOTE:** The pressure in your tires changes with temperature. A significant decrease in temperature could reduce cold inflation pressure below the TPM setpoint. For example, tires inflated to the proper cold inflation pressure on a warm day or in a warm garage could illuminate the TPM indicator lamp on the following day if the temperature is very cold. **ALWAYS** check the pressure in your tires if the TPM lamp is illuminated.

3

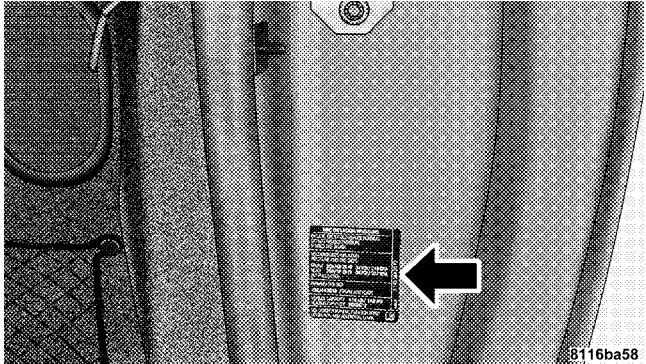

**CAUTION!**

**The TPM system has been optimized for the original equipment tires and wheels. TPM system pressures have been established for the tire size equipped on your vehicle. Undesirable operation or sensor damage may result when using replacement equipment that is not of the same size, type, and/or style. Aftermarket wheels can cause sensor damage. Do not use aftermarket tire sealant or balance beads, as damage to the sensors may result.**

**NOTE:** The standard TIREFIT system (refer to What To Do In Emergencies for more information) is specifically designed to operate in conjunction with the TPM system, and will not damage the sensors.

If your tire pressure is low, you should correct your tire inflation pressure as soon as possible and inspect all of your tires. Low tire pressure will cause the tire pressure light to illuminate and the alert will sound. They will remain on for the rest of the driving cycle, or until the tire pressure is corrected.

In addition to monitoring tire pressures, the TPM system also monitors faults within the system. If the TPM light and alarm continue after the tire pressure has been corrected, see your authorized dealer.

This device complies with part 15 of FCC rules and with RSS-210 of Industry Canada. Operation is subject to the following conditions:

1. This device may not cause harmful interference.
2. This device must accept any interference that may be received, including interference that may cause undesired operation.

**NOTE:** Changes and modifications not expressly approved by the party responsible for compliance could void the user's authority to operate the equipment.

### REAR SPOILER

A rear spoiler enhances vehicle stability. The rear spoiler deploys automatically when vehicle speed reaches 62 mph (100 km/h). The spoiler begins to retract at 39 mph (62 km/h). When retracted, the spoiler fits between the quarter panels, and aft of the liftgate window.

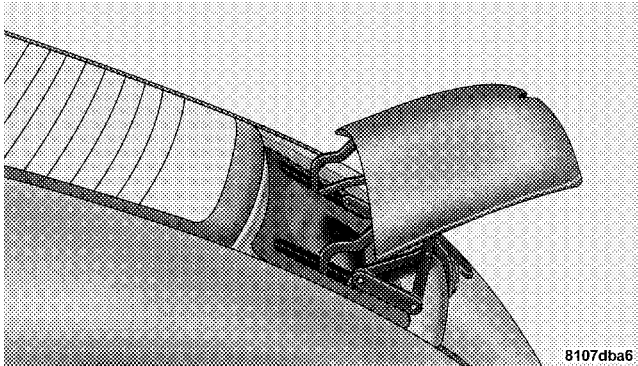

The spoiler can also be deployed at lower speeds using an override switch mounted in the center console.

Once manually deployed, the spoiler will only retract by pressing the bottom of the spoiler switch. The spoiler will then retract in steps as long as the switch is depressed. If the switch is depressed until the spoiler is fully retracted, a short beep will be heard, and automatic control will be reestablished.

The spoiler control also incorporates an emergency stop feature. If, for any reason, spoiler motion needs to be stopped, pressing either the top or bottom of the switch will stop the spoiler motion. Once the deployment speed is reached, however, the spoiler deploys to its full up position.

## 72 UNDERSTANDING THE FEATURES OF YOUR VEHICLE

Should a malfunction occur that prevents the spoiler from deploying automatically, a red warning light will illuminate in the override switch and an audible warning will sound.

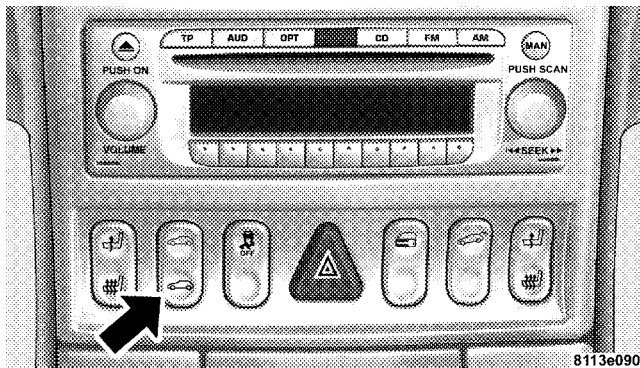

### WARNING!

**Do not drive the vehicle at speeds above 62 mph (100 km/h) if the red spoiler warning indicator is illuminated. You could have reduced vehicle stability and control.**

### WARNING!

**Keep hands and fingers away from the spoiler and spoiler linkage when the spoiler is deploying or retracting. The linkage could pinch your fingers and cause serious injury.**



**BRAKE ASSIST SYSTEM (BAS)****WARNING!**

**BAS cannot prevent the natural laws of physics from acting on the vehicle, nor can it increase braking efficiency beyond that afforded by the condition of the vehicle brakes and tires or the traction afforded. The BAS cannot prevent accidents, including those resulting from excessive speed in turns, following another vehicle too closely, or hydroplaning. Only a safe, attentive, and skillful driver can prevent accidents. The capabilities of a BAS-equipped vehicle must never be exploited in a reckless or dangerous manner which could jeopardize the user's safety or the safety of others.**

The BAS is designed to maximize the vehicle's braking capability during emergency braking maneuvers. The system applies maximum power boost to the brakes more quickly in emergency braking conditions than might otherwise be afforded solely by the driver's braking style. This can help reduce braking distances. The

BAS complements the antilock brake system (ABS). Applying the brakes very quickly results in maximum BAS assistance. To receive the benefit of the system, you must apply continuous full braking power during the stopping sequence. Do not reduce brake pedal pressure.

Once the brake pedal is released, the BAS is deactivated.

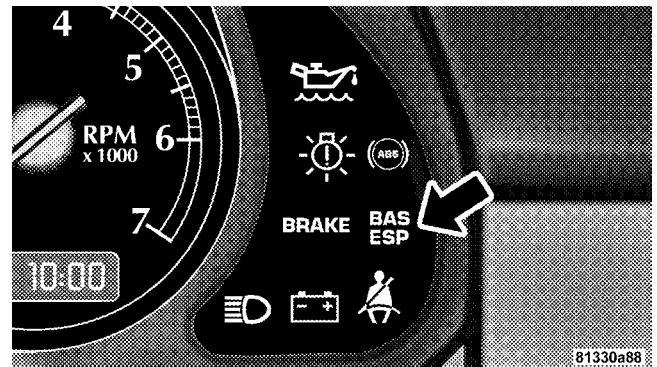

The malfunction indicator lamp for the Electronic Stability Program is combined with the BAS. The yellow BAS/ESP malfunction indicator light in the instrument cluster and the yellow ESP warning light in the speedometer dial come on with the key in the ignition switch

turned to the ON/RUN position. They should go out with the engine running. If the BAS/ESP malfunction indicator light comes on continuously with the engine running, a malfunction has been detected in either system.

If the malfunction indicator light stays illuminated, have the BAS and ESP checked at your authorized dealer as soon as possible.

### ELECTRONIC STABILITY PROGRAM (ESP)

#### WARNING!

**ESP cannot prevent the natural laws of physics from acting on the vehicle, nor can it increase the traction afforded. The ESP cannot prevent accidents, including those resulting from excessive speed in turns, or hydroplaning. Only a safe, attentive, and skillful driver can prevent accidents. The capabilities of an ESP-equipped vehicle must never be exploited in a reckless or dangerous manner which could jeopardize the user's safety or the safety of others.**

The ESP enhances directional control and reduces driving wheel spin of the vehicle under various driving conditions.

The ESP system corrects for over/understeering of the vehicle by applying brakes to the appropriate wheel. Engine torque is also limited. The ESP warning light, located in the instrument cluster, starts to flash as soon as the tires lose traction and the wheels begin to spin.

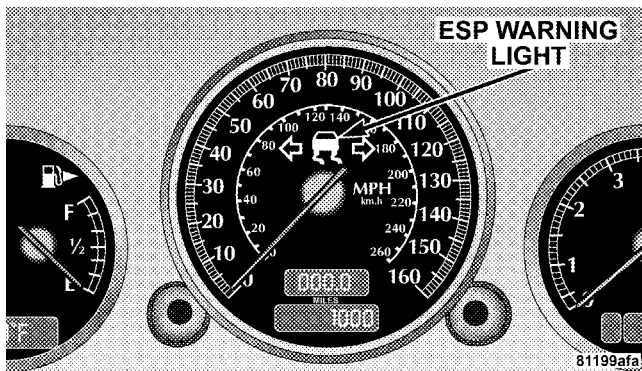

To improve the vehicle's traction when driving with snow chains, or starting off in deep snow, sand or gravel, switch off the ESP system by pressing the upper half of the ESP switch.

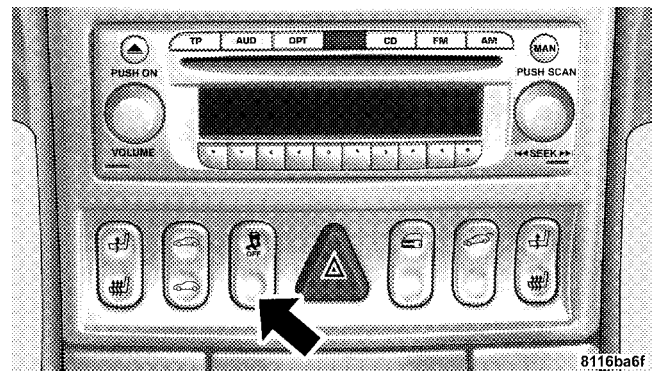

With the ESP system switched off, the engine torque reduction feature is cancelled. Therefore, the enhanced vehicle stability offered by ESP is unavailable. ESP always operates under braking, even with the switch in the OFF position. If one drive wheel loses traction and begins to spin, the brake is applied by the ESP system until the wheel regains sufficient traction. The traction control engages at approximately 24 mph (40 km/h), and switches off at 50 mph (80 km/h).

If the ESP warning light begins to flash during acceleration, ease up on the accelerator and apply as little throttle

as possible. Be sure to adapt your speed and driving to the prevailing road conditions. When the ESP warning light is illuminated continuously, the ESP is switched off. To return to the enhanced vehicle stability offered by ESP, press the lower half of the switch (the ESP warning light in the speedometer dial goes out). Avoid spinning one drive wheel. This may cause serious damage to the drive train and is not covered by the DaimlerChrysler warranty.

**CAUTION!**

**If the vehicle is towed with the front axle raised, the engine must be shut off (key in the ignition switch to the OFF/LOCK or ACC position). Otherwise the ESP will immediately be engaged and will apply the rear wheel brakes.**

**Synchronizing ESP**

If the power supply was interrupted (battery disconnected or discharged), the BAS/ESP malfunction indicator light may be illuminated with the engine running. To re-synchronize the ESP, and cancel the malfunction indicator light, the steering angle sensor will need to be recalibrated.

1. Turn the ignition switch to the ON/RUN position.
2. Rotate the steering wheel to the center position.
3. Rotate the steering wheel completely to the left, and then rotate the steering wheel completely to the right.
4. Bring the steering wheel back to the center position.
5. The BAS/ESP malfunction indicator light will go out.

If the BAS/ESP malfunction indicator light is still illuminated, the vehicle should be serviced at an authorized dealer.

### ELECTRONIC SPEED CONTROL

The electronic speed control automatically maintains the set speed by actively regulating the throttle setting. Any speed above approximately 20 mph (30 km/h) can be maintained with the electronic speed control by operating the lever.

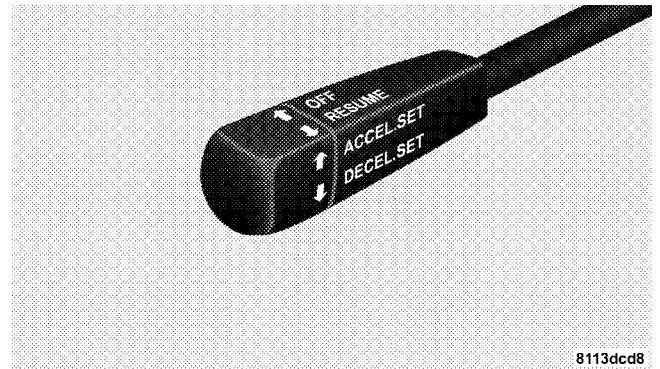
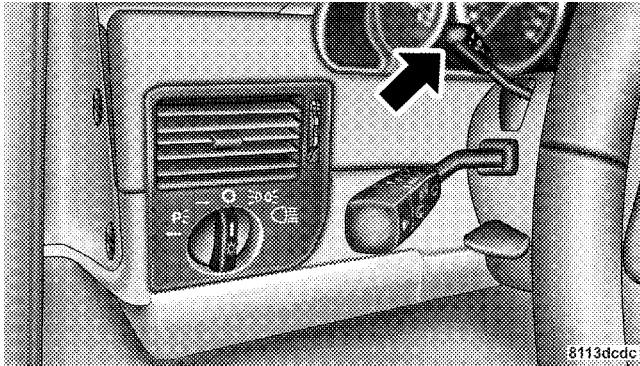

To accelerate and set a speed, lift the lever up. Lift and hold the lever to accelerate, or lift and release to set a speed. To decelerate and set a speed, press the lever down. Press down and hold the lever to decelerate, or press down and release to set a speed.

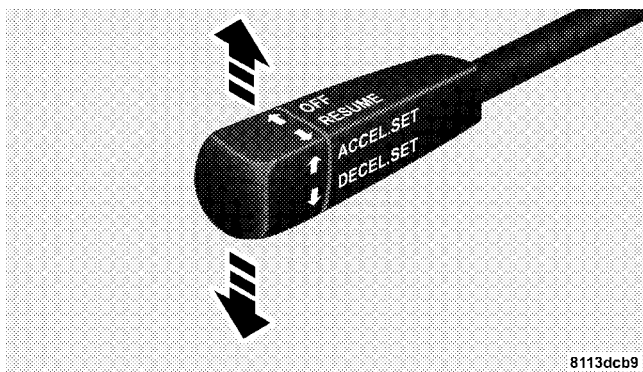

### WARNING!

**Leaving the electronic speed control system on when not in use is dangerous. You could accidentally set the system or cause it to go faster than you want. You could lose control and have an accident. Always leave the system OFF when you are not using it.**

#### To Vary The Speed Setting

If a set speed needs to be adjusted slightly, lift up or hold down the speed control lever briefly until the desired speed is reached. A single tap on the lever up or down will change the speed in 0.6 mph (1 km/h) increments. When the lever is released, the newly set speed remains.

To increase the speed for passing, use the accelerator. After the accelerator is released, the previously set speed will resume automatically.

### To Deactivate

A soft tap on the brake pedal, or normal brake pressure while slowing the vehicle, will deactivate the speed control without erasing the memory. Pushing the speed control lever forward or turning the key in the ignition switch to the OFF/LOCK position will turn off the speed control and erase the memory.

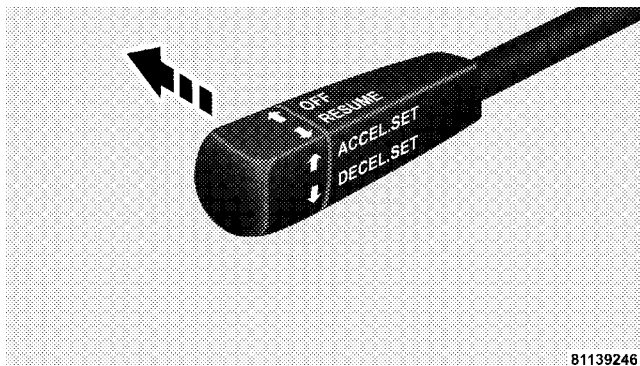

### To Resume Speed

To resume a previously set speed, pull the speed control lever toward you, and then release. The resume feature can be used at any speed above 20 mph (30 km/h).

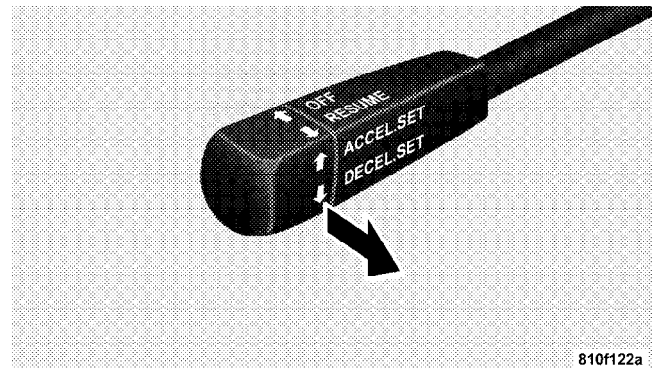

3

**NOTE:** Moving the gear selector lever to the “N” position will switch the speed control off.

### Using Speed Control On Hills

Your vehicle is equipped with interactive speed control. This feature activates when driving up or down hills with the speed control engaged and the driver’s foot off the accelerator.

**WARNING!**

Speed control can be dangerous where the system can't maintain a constant speed. Your vehicle could go too fast for the conditions, and you could lose control. An accident could be the result. Don't use speed control in heavy traffic or on roads that are winding, icy, snow-covered, or slippery.

For vehicles with automatic transmission:

On a downgrade or an upgrade, downshifting will occur automatically to allow the engine's braking power to maintain the set speed. When more level roadway is reached, the transmission will automatically upshift to fifth gear.

For vehicles with manual transmission:

The set speed control is switched off when declutching exceeds four seconds during downshifting. In some cases, you may have to step on the brake pedal to slow down sufficiently to achieve the desired speed.

**NOTE:** On very steep hills, a greater speed loss or gain may occur. It may be preferable to drive without speed control.

**GARAGE DOOR OPENER**

The HomeLink® Universal Transceiver replaces up to three remote controls (hand-held transmitters) that operate devices such as garage door openers, motorized gates, or home lighting. The transceiver triggers these devices at the push of a button. The transceiver operates off your vehicle's battery and charging system: no batteries are needed.

For additional information on HomeLink®, call 1-800-355-3515, or on the internet at [www.homelink.com](http://www.homelink.com).



**WARNING!**

A moving garage door can cause injury to people and pets in the path of the door. People or pets could be seriously or fatally injured. Only use this transceiver with a garage door opener that has a “stop and reverse” feature, as required by federal safety standards. This includes most garage door opener models manufactured after 1982. Do not use a garage door opener without these safety features, as it could cause injury or death. Call toll-free 1-800-355-3515 or, on the internet at [www.homelink.com](http://www.homelink.com) for safety information and assistance.

**Programming The Universal Transceiver**

For best results, install a new battery in the hand-held transmitter before programming. If your garage door opener (located in the garage) is equipped with an antenna, make sure that the antenna is hanging straight down.

1. Turn off the engine.

**WARNING!**

Vehicle exhaust contains carbon monoxide, a dangerous gas. Do not run the vehicle's engine while programming the transceiver. Exhaust gas can cause serious injury or death.

3

**WARNING!**

Your motorized door or gate will open and close while you are programming the universal transceiver. Do not program the transceiver if people or pets are in the path of the door or gate. A moving door or gate can cause serious injury or death to people and pets or damage to objects.

2. Turn the ignition to the ON/RUN position.
3. Erase the factory test codes by pressing the two outside buttons. Release the buttons when the light in the overhead console display begins to flash (about 20 seconds).

**NOTE:** Step 3 does not have to be followed to program additional hand-held transmitters.

4. Choose one of the three buttons to program. Place the hand-held controller 1–3 inches (25–76 mm) from the universal transceiver while keeping its indicator light in view.

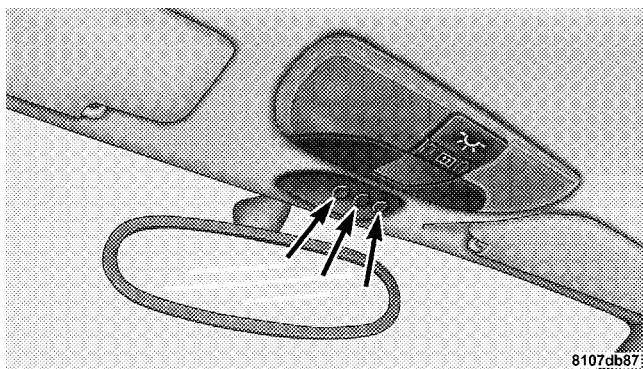

5. Using both hands, press the hand-held transmitter button and the desired universal transceiver button. Do not release the buttons until Step 6 has been completed.

**NOTE:** Some gate operators and garage door openers may require you to replace this Programming Step 5 with procedures noted in the “Gate Operator/Canadian Programming” section.

6. The indicator light in the universal transceiver will begin to flash, first slowly and then rapidly. Release both buttons after the indicator light changes from slow to rapid flash. If, after 90 seconds, the indicator does not flash rapidly or goes out, return to Step 1 and repeat the procedure.

7. Press and hold the just programmed universal transceiver button and observe the indicator light. If the indicator stays on constantly, programming is complete and your device should activate when the universal transceiver button is pressed and released.

**NOTE:** To program the remaining two universal transceiver buttons, begin with Programming Step 4. Do not repeat Steps 1, 2, and 3.

If the indicator light blinks rapidly for two seconds and then turns to a constant light, continue with

Programming Steps 8-10 to complete programming of a rolling code equipped device (most commonly a garage door opener).

8. At the garage door opener receiver (motor-head unit) in the garage, locate the “learn” or “smart” button. This can usually be found where the hanging antenna wire is attached to the motor-head unit.

9. Firmly press and release the “learn” or “smart” button. (The name and color of the button may vary by manufacturer.)

**NOTE:** There are 30 seconds in which to initiate Step 10.

10. Return to the vehicle and firmly press, hold for two seconds and release the programmed universal transceiver button. Repeat the “press/hold/release” sequence a second time, and, depending on the brand of the garage door opener (or other rolling code equipped device), repeat this sequence a third time to complete the programming.

The universal transceiver should now activate your rolling code equipped device.

If you do not successfully program the universal transceiver to learn the signal of your hand-held transmitter, call toll free for customer assistance at 1-800-355-3515, or on the internet at [www.homelink.com](http://www.homelink.com).

### Gate Operator/Canadian Programming

Canadian radio-frequency laws require transmitter signals to “time-out” (or quit) after several seconds of transmission. This may not be long enough for the universal transceiver to pick up the signal during programming. Similar to this Canadian law, some U.S. gate operators are designed to “time-out” in the same manner.

If you live in Canada or you are having difficulties programming a gate operator by using the programming procedures (regardless of where you live), replace Programming Step 5 with the following:

**NOTE:** If programming a garage door opener or gate operator, it is advised to unplug the device during the “cycling” process to prevent possible overheating.

5. Continue to press and hold the universal transceiver button while you press and release every two seconds (“cycle”) your hand-held transmitter until the frequency

signal has successfully been accepted by the universal transmitter. (The indicator light will flash slowly and then rapidly.) Proceed with Programming Step 6 to complete.

#### **Using the Universal Transceiver**

To operate the universal transceiver, simply press and release the programmed button. Activation will now occur for the programmed device (i.e. garage door opener, gate operator, security system, entry door lock, home/office lighting, etc.) For convenience, the hand-held transmitter of the device may also be used at any time.

#### **Erasing Universal Transceiver Buttons**

To erase programming from the three buttons (individual buttons cannot be erased but can be reprogrammed – see below), follow this procedure:

- Press and hold the two outer universal transceiver buttons until the indicator light begins to flash after 20 seconds. Release both buttons. Do not hold for longer than 30 seconds. The universal transceiver is now in the program (or learning) mode and can be programmed at any time beginning with Programming Step 4.

#### **Reprogramming a Single Button**

To program a device using a universal transceiver button previously programmed, follow these steps:

1. Press and hold the desired universal transceiver button. DO NOT release the button.
2. The indicator light will begin to flash after 20 seconds. Without releasing the universal transceiver button, proceed with Programming Step 4.

**Security**

If you sell your vehicle, be sure to erase the frequencies.

To erase all of the previously programmed frequencies, hold down both outside buttons until the light begins to flash.

This device complies with part 15 of FCC rules and with RS-210 of Industry Canada. Operation is subject to the following conditions:

1. This device may not cause harmful interference.
2. This device must accept any interference that may be received, including interference that may cause undesired operation.

**NOTE:** Changes or modifications not expressly approved by the party responsible for compliance could void the user's authority to operate the equipment.

HomeLink® is a trademark owned by Johnson Controls, Inc.

**UMBRELLA HOOK**

Your Crossfire is equipped with an umbrella hook. This feature is located behind and between the two seats, just above the map pocket.



---

# UNDERSTANDING YOUR INSTRUMENT PANEL

## CONTENTS

---

■ Instruments And Controls . . . . .	.88	■ Compact Disc Maintenance . . . . .	109
■ Instrument Cluster . . . . .	.89	■ Radio Antenna . . . . .	110
■ Instrument Cluster Description . . . . .	.89	■ Radio Operation And Cellular Phones . . . . .	110
■ “Infinity Modulus” AM/FM Stereo Radio With Single-Disc CD Player . . . . .	101	■ Climate Controls . . . . .	110
□ Infinity Modulus Entertainment Systems . . . . .	101	□ Temperature Control . . . . .	111
□ CD Player Operation . . . . .	106	□ Fan Control . . . . .	111
□ User Menu . . . . .	107	□ Basic Setting - Heater . . . . .	111
□ User Memory (User – 1, 2, 3) . . . . .	108	□ Basic Setting - Air Conditioner . . . . .	112
□ Mono/Stereo . . . . .	108	□ Dust Filter . . . . .	116
□ Driver – L/R . . . . .	108	□ Operating Tips . . . . .	116
□ Telephone Mute Characteristics . . . . .	109		

**INSTRUMENTS AND CONTROLS**

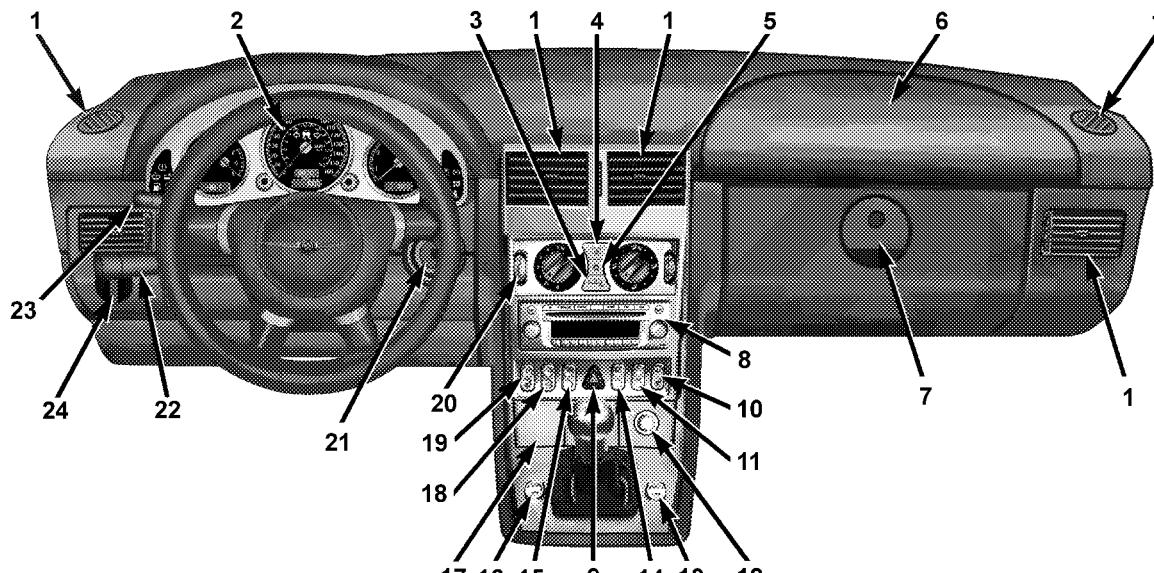

- |                          |                           |                                |                         |                                 |
|--------------------------|---------------------------|--------------------------------|-------------------------|---------------------------------|
| 1. Air Outlets           | 6. Passenger Airbag       | 11. Anti-Towing Protection     | 16. Driver Power Window | 21. Ignition Switch             |
| 2. Instrument Cluster    | 7. Glove Compartment      | 12. Power Outlet/Cigar Lighter | 17. Ashtray/Coinholder  | 22. Multifunction Control Lever |
| 3. Air Recirculation     | 8. Audio System           | 13. Passenger Power Window     | 18. Spoiler Control     | 23. Speed Control Lever         |
| 4. Rear Window Defroster | 9. Hazard Warnings        | 14. Central Locking            | 19. Driver Heated Seat  | 24. Headlight Switch            |
| 5. Air Conditioning      | 10. Passenger Heated Seat | 15. ESP Off                    | 20. Climate Control     |                                 |

8113e19b



**INSTRUMENT CLUSTER**

The instrument cluster displays are activated by either opening the door, pressing the left button within the cluster, or turning the key in the ignition switch to the ON/RUN position.

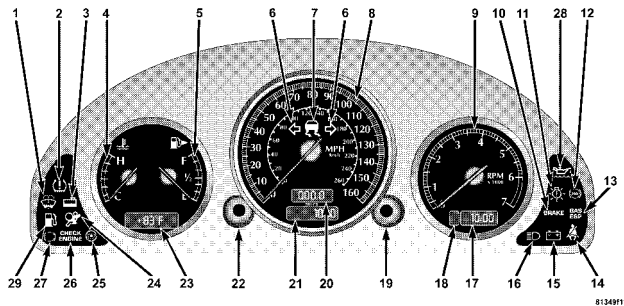

**INSTRUMENT CLUSTER DESCRIPTION**

**1. Low Windshield Washer System Fluid Level Warning Light**



With the key in the ignition switch turned to the ON/RUN position, the indicator light comes on. It should go out when the engine is running.

If the indicator light does not go out after starting the engine, or if it comes on while driving, the fluid reservoir is less than 1/4 filled.

The reservoir should be refilled at the next opportunity with commercially available premixed windshield washer solvent/antifreeze or water, depending on ambient temperature.

The reservoir for the windshield washer system is located in the engine compartment and the cap is marked with the above symbol.

## 2. Low Tire Pressure Indicator Light



The tire pressure monitor (TPM) system uses wireless technology to monitor tire pressure levels. Sensors, mounted to each wheel as part of the valve stem, transmit tire pressure readings to a receiver located in the vehicle.

If the light is illuminated, the pressure in one of the tires on the vehicle has dropped to at least 25% below the recommended pressure on the vehicle's tire label. Additionally, the indicator light will illuminate if a fault has been detected in the TPM system.

### CAUTION!

**The TPM system is designed to monitor your tire pressure and will not function as a tire pressure gauge. After adjusting the air pressure in a tire, there will be a delay before the system updates the display.**

**NOTE:** The TPM system can inform you about a low tire pressure condition, but it does not replace normal tire maintenance. The TPM system is not intended to provide you with notification of rapid pressure loss.

**NOTE:** The pressure in your tires changes with temperature. A significant decrease in temperature could reduce cold inflation pressure below the TPM setpoint. **ALWAYS** check the pressure in your tires if the TPM lamp is illuminated.

## 3. Coolant Indicator Light



This indicator illuminates when the engine coolant has dropped below the required level in the reservoir or the coolant temperature is too high (see the Temperature gauge section).

To check the coolant level, the vehicle must be parked on level ground and the engine stopped.

Check coolant level only when the coolant is cold.

**WARNING!**

You or others can be badly burned by hot coolant or steam from your radiator. If you see or hear steam coming from under the hood, don't open the hood until the radiator has had time to cool. Never try to open a cooling system pressure cap when the radiator or coolant bottle is hot.

**4. Engine Coolant Temperature Gauge**

This gauge shows engine coolant temperature. Any reading between the Hot and Cold gauge marks show that the engine cooling system is operating properly. The gauge pointer may show a higher temperature when driving in hot weather, up mountain grades, or in heavy stop-and-go-traffic.

If the pointer rises to the red (Hot) area, stop the vehicle and turn off the engine until the problem is corrected.

**CAUTION!**

Continuing to drive with an overheated engine cooling system can cause damage to the engine or other components.

**5. Fuel Gauge**

When the ignition is in the ON/RUN position, the pointer will show the level of fuel remaining in the tank. The arrow to the right of the gas pump symbol shows which side of the vehicle the fuel filler door is located on.

**6. Turn Signal Indicators**

To signal minor directional changes, such as changing lanes, move the multifunction control lever to the point of resistance only and hold it there. The arrows will flash in unison with the corresponding exterior turn signal.

To operate the turn signals continuously, move the multifunction control lever past the point of resistance up or down. The switch is automatically canceled when the steering wheel is turned to a large enough degree.

The arrows in the instrument cluster will flash in unison with the respective exterior turn signal.

### **7. Electronic Stability Program (ESP) Indicator Light**

 The yellow ESP indicator light in the speedometer dial comes on with the key in the ignition switch turned to the ON/RUN position. It should go out with the engine running.

If the ESP indicator light flashes during acceleration, apply as little throttle as possible. While driving, ease up on the accelerator. Adapt your speed and driving to the prevailing road conditions, and do not switch off the ESP.

### **8. Speedometer**

The speedometer shows the vehicle speed in miles-per-hour and kilometers-per-hour.

### **9. Tachometer**

This gauge shows engine speed in revolutions-per-minute (RPM) times 1,000.

The red markings on the tachometer indicate excessive engine speed. Ease off on the accelerator before reaching the red area.

### **10. Brake System Warning Light**

**BRAKE** The dual brake system provides a reserve braking capability if a failure occurs in a portion of the hydraulic system.

This light monitors both the brake fluid level and the parking brake. If the light comes on, it indicates either that the parking brake is on or there is a low fluid level in the brake master cylinder. Since this vehicle is equipped with anti-lock brakes (ABS), the brake light may also indicate reduced braking performance due to the loss of electronic brake proportioning. If the parking brake is off and the light remains on, have the brake system inspected as soon as possible.

The warning light should be checked frequently to assure that it is operating properly. This can be done by turning the ignition switch to START. The light should come on. If the red brake light does not come on when the ignition is turned to the ON/RUN position, have the brake light repaired promptly.

**WARNING!**

**Driving a vehicle with the brake light on is dangerous. Part of the brake system may have failed. It will take longer to stop the vehicle. You could have an accident. Have the vehicle checked immediately.**

**NOTE:** This light shows only that the parking brake is on. It does not show the degree of brake application.

The brake warning light will come on if the ABS light is not functioning and there is an ABS system malfunction.

**11. Light Outage Indicator**

With the key in the ignition switch turned to the ON/RUN position, an indicator light comes on. It should go out when the engine is running. If the indicator light does not go out after starting the engine, or if it comes on while driving, it indicates a failure in the parking light, taillight, stoplight, or low beam headlight.

The indicator light will come on when the exterior light fails. If a brake light fails, the light outage indicator will come on when applying the brake and stays on until the engine is turned off.

**NOTE:** If additional lighting equipment is installed (e.g., auxiliary headlights, etc.) be certain to connect into the fuse before the failure indicator monitoring unit in order to avoid damaging the system.

**12. Antilock Warning Indicator Light**

The ABS warning indicator light comes on with the key in the ignition switch turned to the ON/RUN position, and should go out with the engine running.

If the ABS warning indicator light comes on while the engine is running, it indicates that the ABS has detected a malfunction and has switched off. In this case, the brake system functions in the usual manner, but without antilock assistance.

If the ABS light is on, have the system checked at your authorized dealer as soon as possible.

**13. Brake Assist Indicator Light**

**BAS** The indicator light for the Brake Assist System (BAS) is combined with the Electronic Stability Program (ESP). This yellow indicator light in the instrument cluster comes on with the key in the ignition switch turned to the ON/RUN position. The BAS/ESP warning indicator light also comes on when a malfunction is detected in either the Brake Assist System or the Electronic Stability Program. It should go out with the engine running. If the BAS/ESP indicator light comes on continuously, see an authorized dealer as soon as possible.

**14. Seat Belt Indicator Light**

With the key in the ignition, the light comes on, and a warning sounds for a short time if the driver's seat belt is not fastened.

After starting the engine, the seat belt indicator light blinks and a chime sounds periodically for up to 90 seconds to remind the driver and passenger to fasten the seat belts. Fastening the seat belts will extinguish the light and silence the chime.

The seat belt indicator light will remain lit until the seat belts are fastened.

**15. Charging System Indicator Light**

Should the charging system indicator light fail to come on prior to starting when the key is in the ignition switch in the ON/RUN position, or should it fail to go out after starting or during operation, it indicates a malfunction that must be repaired immediately at an authorized dealer.

If the charging system indicator light comes on, or a loss of power steering assistance is noticeable while the engine is running, this may indicate that the accessory drive belt has broken. Should this condition occur, the belt must be replaced before continuing to operate the vehicle.

**CAUTION!**

The accessory drive belt also drives the water pump. Operating the vehicle with a failed belt can cause engine overheating and possible severe engine damage.

**16. High Beam Indicator Light**

This indicator will illuminate when the headlights are in the high beam setting.

To activate the high beams, push the multifunction control lever past the point of resistance, toward the instrument panel.

**17. Electronic Digital Clock**

A digital readout in the instrument cluster shows the time in hours and minutes whenever the ignition switch is in the ON/RUN or ACC position.

When the ignition switch is in the OFF/LOCK position, timekeeping is accurately maintained.

The display can be adjusted with the knob/button located to the left of the clock.

**18. Gear Indicator**

For automatic transmission vehicles, the current gear shift selector range is indicated in the gear range indicator display.

**19. Push Button for Time Setting**

To adjust the time display, turn the key in the ignition switch to the ON/RUN or ACC position. The knob/button located just to the left of the clock is used to change the time. Pull out the knob and turn it to the left for hour adjustment; pull out the knob and turn it to the right for minute adjustment.

**20. Trip Odometer, Flexible Service System (FSS) Indicator**

This display shows the distance traveled since last reset.

To reset:

- Press the button to the left of the display once (with the key in the ON/RUN position).

- Press the button twice (with the key removed or in the OFF/LOCK or ACC position).

### **21. Main Odometer, Flexible Service System (FSS)**

This shows the total distance the vehicle has been driven.

U.S. Federal regulations require that upon transfer of vehicle ownership, the seller certify to the purchaser the correct distance that the vehicle has been driven. Therefore, if the odometer reading is changed during repair or replacement be sure to keep a record of the reading before and after service so that the correct distance can be determined.

### **22. Push Button for Activating the Instrument Cluster, Intensity of Instrument Lights, for Resetting Trip Odometer and Flexible Service System (FSS) Indicator**

Press the knob/button to illuminate the display. To vary the intensity of the instrument cluster lights, rotate the knob/button.

To reset the trip odometer, press the knob/button once with the key in the ON/RUN position. Press the knob/button twice with the key removed or in the OFF/LOCK or ACC position.

The FSS permits a flexible service schedule that is directly related to the operating conditions of the vehicle.



There are two symbols which will appear in the main odometer display field prior to the next suggested service. This symbol represents Service A.



This second symbol represents Service B.



Depending on operating conditions throughout the year, the next service is calculated and displayed next to this symbol in days remaining before the next service is required.



Likewise, the next service may be calculated and displayed next to this symbol as distance remaining before the next service is required.



The counter can also be reset by any individual after the indicated service has been performed. To do so:

1. Turn key to the ON/RUN position.
2. Within one second press the knob/button twice.
3. The present status for days or distance is displayed. Within 10 seconds turn the key to OFF/LOCK.
4. Press and hold the knob/button, while turning the key to ON/RUN again. The present status for days or distance is displayed once more. Continue to hold the knob/button.

After approximately 10 seconds, a signal sounds and the display shows 7,000 miles (11,000 km) for approximately 10 seconds.

5. Release the knob/button.

If the FSS counter was inadvertently reset, have an authorized dealer correct it.

The message is displayed for approximately 10 seconds when turning the key to the ON/RUN position,

or while driving when reaching the service warning threshold. It can be canceled manually by pressing the knob/button.

Once the suggested term has passed, the message plus either the symbol for Service A or the symbol for Service B preceded by a - (minus symbol) blinks for approximately 30 seconds and a signal sounds every time when turning the key to the ON/RUN position.

The FSS display can also be called up for approximately 10 seconds with the display illuminated by pressing the knob/button twice within one second.

Following a completed A or B service your authorized dealer sets the counter to 7,000 miles (11,000 km).

**NOTE:** When disconnecting vehicle battery for one or more days at a time, such days will not be counted. Any such days not counted by FSS can be added by your authorized dealer.

The interval between services is determined by the type of vehicle operation. Driving at extreme speeds, and cold

starts combined with short distance driving in which the engine does not reach normal operating temperature, reduce the interval between services.

However you choose to set your reference numbers, the scheduled services as posted in the Service Booklet must be followed to properly care for your vehicle.

### **23. Outside Temperature Display**

The temperature display is located on the left side of the instrument cluster, below the fuel and engine temperature gauges.

The sensor for the outside temperature indicator is located in the front fascia area. Due to its location, the sensor can be affected by road or engine heat during idling or slow driving. This means that the accuracy of the displayed temperature can only be verified by comparison to a thermometer placed next to the sensor, not by comparison to external displays (e.g., bank signs, etc.).

Adaptation to ambient temperature takes place in steps and depends on the prevailing driving conditions (stop-and-go or moderate, constant driving) and amount of temperature change.

### **WARNING!**

**The outside temperature indicator is not designed to serve as an ice-warning device and is unsuitable for that purpose. Indicated temperatures just above the freezing point do not guarantee that the road surface is free of ice.**

### **24. Airbag Light**



The operational readiness of the airbag system is verified by the airbag indicator light in the instrument cluster when turning the key in the ignition switch to the ACC or ON/RUN position. If no fault is detected, the light will go out after approximately 4 seconds. After the lamp goes out, the system continues to monitor the components and circuitry of the airbag system and will indicate a malfunction by coming on again.

The light will come on and remain on for 4 seconds as a bulb check when the ignition switch is first turned ON. If

the bulb is not lit during starting, have it replaced. If the light stays on, or comes on while driving, have the system checked by an authorized dealer.

### WARNING!

**In the event a malfunction of the airbag is indicated, the airbag may not be operational. For your safety, we strongly recommend that you visit an authorized dealer immediately to have the system checked; otherwise the airbag may not be activated when needed in an accident, which could result in serious or fatal injury, or it might deploy unexpectedly and unnecessarily which could also result in injury.**

#### 25. Telescoping Wheel Indicator Light



With the key in the ignition and turned to the ON/RUN position, the indicator light in the instrument cluster comes on. It should go out when the engine is running. If the indicator light does not go out after starting the engine, the telescoping steering column is not locked properly.

### WARNING!

**Do not drive the vehicle until you have properly locked the steering column.**

#### 26. Check Engine Light

**CHECK ENGINE** This light is part of an onboard diagnostic system that monitors the emissions and engine control systems. If a problem is detected in one of these systems, the Check Engine light will come on. The light comes on and stays on briefly as a bulb check when the ignition is first turned on.

Certain conditions, such as a loose or missing gas cap, or poor fuel quality may illuminate the light after the engine is started. Be sure the gas cap is tightened every time you refuel.

If the Check Engine light remains on continuously and the vehicle is driving normally, you may still drive the vehicle. In most situations, the vehicle will not require towing. However, we recommend that you have the system checked at an authorized dealer as soon as possible.

If the vehicle is not driving normally, and the Check Engine light flashes or remains on continuously, it is an alert to serious conditions that could lead to loss of power or severe catalytic converter damage. The vehicle should be serviced at an authorized dealer as soon as possible.

### 27. Brake Wear Indicator Light



With the key in the ignition and turned to the ON/RUN position, the brake wear indicator light comes on. The light goes out when the engine is running.

If the indicator light comes on during braking, this indicates the brake pads are worn down.

Have the brake system checked at your authorized dealer as soon as possible.

### 28. Oil Level Indicator Light



With the key in the ignition switch turned to the ON/RUN position, the oil level indicator light comes on. It should go out immediately when the engine is running. If the light does

not go out, or comes on while driving, the engine oil level has dropped to approximately the minimum mark on the dipstick.

### CHECKING ENGINE OIL LEVEL

A sensor in the oil pan allows oil level to be checked without opening the hood. It provides an accurate measurement of oil level, whereas the low engine oil level indicator warns that oil level is definitely too low. With the vehicle parked on a level surface, the engine is warmed up and shut off for approximately five minutes. When the ignition switch is turned to the ON/RUN position, an ISO oil level icon appears in the trip odometer window and a “clock” icon in the cumulative odometer display. Pressing the knob to the left of the speedometer twice displays one of the following messages:

- OK
- -1.0 Q (-1.0L)
- -1.5 Q (-1.5L)
- -2.0 Q (-2.0L)
- HI

The indicated amount of oil must be added to the engine if the message -2.0 Q (-2.0L) blinks and a signal sounds. The HI message indicates that the excess oil must be removed from the pan to avoid possible engine or catalytic converter damage. If the ISO oil level icon and “clock” icon remain on when attempting to check oil level and no message follows, or if the low engine oil level warning lamp comes on, a malfunction in the engine oil level system is indicated. A conveniently located dipstick allows manual checking of the oil level.

If no leaks are noted, continue to drive to the nearest service station where the engine oil should be topped to the “full” mark on the dipstick with an approved oil.

### 29. Low Fuel Warning Light



When the fuel level drops to about 2 gallons (7.5 liters), this symbol will light and remains lit until fuel is added.

### “INFINITY MODULUS” AM/FM STEREO RADIO WITH SINGLE-DISC CD PLAYER

#### INFINITY MODULUS Entertainment Systems

A premium Infinity Modulus AM/FM stereo, single-disc CD audio system is standard equipment in your Crossfire. It feeds a six-channel, 240-watt amplifier with dual subwoofers mounted in the back panel behind the seats, and four door-mounted speakers.

4

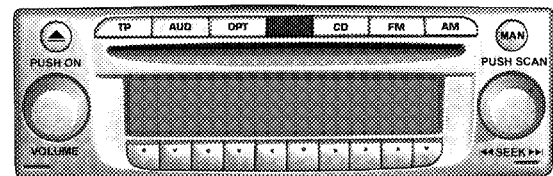

810aecb6

**Power/Volume Control**

To activate the audio system, press the ON/OFF knob on the left. If the unit was switched off using the ignition switch, it will switch on again with the ignition switch.

Press the ON/OFF knob within three seconds of turning the ignition switch off to prevent the radio from switching off.

The unit can also be operated without the ignition switch turned on by pressing the ON/OFF knob, but it will switch off automatically after one hour.

The volume is controlled by rotating the ON/OFF knob to the left or right.

**Audio (AUD) Settings**

- Bass (BASS)

Press the AUD button repeatedly until BASS appears. Rotate the right rotary control for the desired level (from -9 to +9).

- Treble (TREB)

Press the AUD button repeatedly until TREB appears. Rotate the right rotary control for the desired level (from -9 to +9).

- Balance (BAL)

Press the AUD button repeatedly until BAL appears. Rotate the right rotary control for the desired level (from -9 to +9).

- Linear adjustment (LINEAR)

The tone values for the set signal source (e.g., radio/FM) are set to "0" (mean value). Press and hold the AUD button for more than 4 seconds until FM LINEAR appears (which affects FM only). Press and hold the AUD button for more than eight seconds until ALL LINEAR appears (which affects both radio and CD).

- Mute function (MUTE)

To activate the mute function in all modes and wavebands, press the TP button. The mute function is cancelled by either pressing the TP button again, or by turning the volume control.

**NOTE:** After six seconds without any action, or by pressing OPT, CD, AM, FM, or TP, the current setting is cancelled, and the new setting is stored.

#### **FM1 – FM2 – FM AS – BEST FM**

The system has four FM memory modes that can be selected by repeatedly pressing the FM button.

**FM1** – One of ten memorized FM station frequencies can be selected by pressing a multifunction button.

**FM2** – A second set of ten memorized FM station frequencies can be selected by pressing a multifunction button.

**FM AS** – An autostore feature will store the 9 current stations with the strongest signal on station buttons 1-9 in the order of their signal quality.

Press the FM button repeatedly until FM AS is displayed to perform an autostore scan. Press the multifunction button labeled AS repeatedly until AS-SEEK is displayed. To select the stored stations, press the 1-9 buttons.

**BEST FM** – The BEST FM function automatically memorizes and continuously updates the frequencies of stations in order of their signal strength.

The strongest station comes up first when BEST FM is selected. Stations with stronger or weaker signals are selected by turning the right rotary knob.

To select the displayed station, press the right rotary control/push button.

**Tuning FM stations** – Rotating the right rotary control to the right or left will change the FM frequency to the next higher or lower station with a strong signal. To manually step through each frequency or tune in a station with a weaker signal, press the MAN button first, and then rotate the rotary control right or left.

**Storing FM stations** – 10 frequencies can be stored on FM 1 and on FM 2 by pressing a multifunction button for three seconds; a tone will confirm that the selection was set.

**Scan Search FM (SC)** – To activate, press the right rotary control/push button until SC is displayed.

Beginning with the currently set frequency, the next station scanned will be heard for eight seconds. Press the right rotary control/push button if you wish to keep the current station. Once the scan begins, it will continue until either a station or program is retained or until another mode is selected.

#### **Radio Data System (RDS) Stations**

##### **PTY (Program Type)**

The program type of the selected station can be displayed for 10 seconds, or scanned in order of ascending frequency for eight seconds each.

To activate, press the OPT button in FM mode, then press the multifunction PT button. You can pre-select one of the currently available PTY by turning the right rotary control/push button and the program type scan search begins.

Press the button again to keep the received program. If the selected station does not transmit a PTY identification, the display will show NO PTY. If all criteria for evaluating RDS are not met, the unit will only display the frequency.

The following are examples of program types displayed:

- NEWS – News Service
- SOFT – Soft Music
- INFORM – Information Programs
- NOSTALGA – Nostalgia
- SPORTS – Sports Reports
- JAZZ – Jazz Music
- TALK – Talk Programs
- CLASSICL – Classical
- ROCK – Rock Music
- R B – R&B
- CLS ROCK – Classic Rock
- SOFT R B – Soft R&B
- ADLT HIT – Adult Hits
- LANGUAGE – Language Program
- SOFT RCK – Soft Rock



- REL MUSC – Religious Music
- TOP 40 – Top 40
- REL TALK – Religious Talk
- COUNTRY – Country Music
- PERSNLTY – Personality
- OLDIES – Oldies Format
- PUBLIC – Public Radio
- WEATHER – Weather Forecast
- PTY 24-28 – Not Specified
- NO PTY – No Program Type

#### **AM-AM AS**

The system has two AM modes available. Press the AM button repeatedly until the band or operation mode is selected. To search in this mode, press the right rotary control/push button and the abbreviation SC is displayed. Receivable stations can be heard for eight seconds. Press the control again to keep the received station.

Once the scan search begins, it will continue until either a station is retained or until another mode is selected.

Tuning AM stations – Rotating the right rotary control to the right or left will change the AM frequency to the next higher or lower station with a strong signal. To manually step through each frequency or tune in a station with a weaker signal, press the MAN button first, and then rotate the rotary control right or left.

Storing AM stations – 10 frequencies can be stored on AM by pressing a multifunction button for three seconds; a tone will confirm that the selection was set.

AM AS – An autostore feature will store the 9 current stations with the strongest signal on station buttons 1-9 in the order of their signal quality. Press the AM button repeatedly until AM AS is displayed to perform an autostore scan. Press the multifunction button labeled AS repeatedly until AS-SEEK is displayed. To select the stored stations, press the 1-9 buttons.

**General Information**

This radio complies with Part 15 of FCC rules and with RSS-210 of Industry Canada. Operation is subject to the following conditions:

1. This device may not cause harmful interference,
2. This device must accept any interference received, including interference that may cause undesired operation.

**NOTE:** Changes or modifications not expressly approved by the party responsible for compliance could void the user's authority to operate the equipment.

**CD Player Operation**

To activate the CD function, press the CD button; CDS is shown in the display. If no CD disc is present, the display briefly shows NO CDS and the radio mode remains active.

Insert the CD into the slot with the printed side up. The unit will display the number of tracks and total playback time. After the last track has been played back, the unit automatically begins to play the first track again.



To eject a disc, briefly press and release the EJT button.

If the power is turned off, the disc will remain in the CD slot for protection.

Features of the CD player:

- **Skipping Tracks**

Turn the right rotary control/push button. Turn further to the left or right to skip multiple tracks. If a track was played for less than eight seconds, the system will skip to the next track.

- **Scan Tracks (SC)**

Push the right rotary control/push button until the display shows SC. All tracks are played back for eight seconds each. Press the button again to cancel this feature.

- **Fast Forward/Rewind (<<, >>)**

Press and hold the multifunction button >> for audible fast forward play. Press and hold the multifunction button << for audible fast rewind play. The relative time is displayed during this operation and continues for an additional eight seconds after releasing the function button.

- **Relative Time Display (T)**

Press the multifunction button T for the time of the currently playing track to be displayed for approximately eight seconds.

- **Random Play (RP)**

Press the multifunction button RP for random generation of the next track to be played. Press the button again to cancel the feature.

**NOTE:** To protect the unit from excessive heat, a temperature protection device has been integrated into the circuitry. When a high operating temperature is detected, CD TEMP is displayed for eight seconds and

the unit switches back to the last source (AM or FM). Allow sufficient cool down time and retry.

#### **User Menu**

The following functions can be customized to your personal needs in the user menu:

- USER – User Memory
- M/S – Mono/Stereo Setting
- DRIVER – Left/Right Hand Drive Setting
- PHONE – Telephone Characteristics
- LED – LED Setting

To enter the USER menu, press the OPT button for more than three seconds. USER then appears on the display, and another user action must be entered within six seconds or this menu is exited automatically. Your current setting can be cancelled and the selections made will be saved by pressing either the CD, AM, FM or TP buttons momentarily.

**User Memory (USER – 1, 2, 3)**

You can program up to three user memories, which saves the sound settings, and the last received station when the unit is switched off. To activate, first enter the user menu. One of the three users can now be selected by turning the right rotary/push button. You can also call up the Mono/Stereo setting by pressing the right rotary/push button at this time.

**Mono/Stereo**

In order to suppress reception-related interference, three different parameters can be set to optimize reception.

To activate, call up the user menu, then press the right rotary control/push button repeatedly until STEREO, STO AUTO or MONO is displayed (depending on the currently selected setting, you may need to turn the knob also for your selection).

- **STO AUTO** – Setting for normal operation. The unit switches from stereo to mono and back, depending on the reception conditions (for nearly all reception areas, this is the optimal setting).

- **STEREO** – Setting for exceptional conditions. The unit is constantly set for stereo reception (primarily for private broadcasters in urban areas).
- **MONO** – Setting for receptions with constant reflection, the unit is constantly set for monaural reception.

You can also call up the Setting DRIVER mode by pressing the right rotary/push button at this time.

**Driver – L/R**

If a telephone with hands-free operation is installed, the call is routed through the speaker system. The setting DRIVER is used to set the appropriate speaker side (left or right).

To activate, call up the user menu, then press the right rotary control/push button repeatedly until DRIVER L or DRIVER R is displayed (depending on the currently selected setting, you may need to turn the knob also for your selection). You can also call up the Telephone mute characteristics mode by pressing the right rotary/push button at this time.

**Telephone mute characteristics**

If a telephone with hands-free operation is installed, the call may be routed through the speaker system. This eliminates the need for an additional speaker (if the signal lines are connected to the unit). The following settings are available:

- PH MUTE – Switching radio to mute.
- AUDIO PH – Telephone call via the car radio.

Call up the user menu, then press the right rotary control/push button repeatedly until AUDIO PH or PH MUTE is displayed (depending on the currently selected setting, you may need to turn the knob also for your selection).

**COMPACT DISC MAINTENANCE**

To keep the compact discs in good condition, take the following precautions:

1. Handle the disc by its edge; avoid touching the surface.
2. If the disc is stained, clean the surface with a soft cloth, wiping from center to edge.
3. Do not apply paper or tape to the disc; avoid scratching the disc.
4. Do not use solvents such as benzine, thinner, cleaners, or antistatic sprays.
5. Store the disc in its case after playing.
6. Do not expose the disc to direct sunlight.
7. Do not store the disc where temperatures may become too high.

**RADIO ANTENNA**

The radio antenna is located in the rear liftgate glass and requires no maintenance.

**RADIO OPERATION AND CELLULAR PHONES**

Under certain conditions, the operation of a cellular phone in your vehicle can cause erratic or noisy performance from your radio. This condition may be lessened or eliminated by relocating the cellular phone antenna. This condition is not harmful to the radio. If your radio performance does not satisfactorily “clear” by the repositioning of the antenna, it is recommended that the radio volume be turned down or off during cellular phone operation.

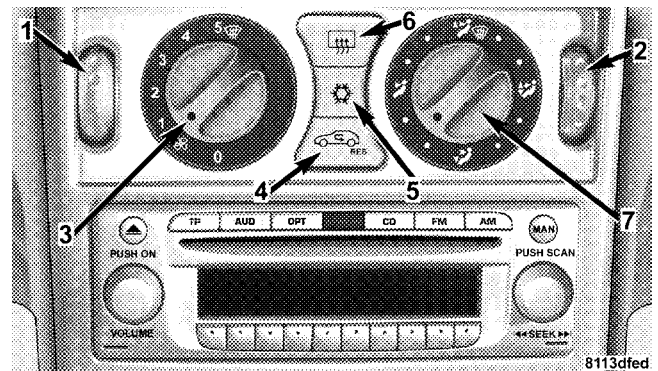
**CLIMATE CONTROLS**

1. Driver Temperature Control
2. Passenger Temperature Control
3. Fan Speed Control
4. Air Recirculation/REST
5. Air Conditioning ON/OFF
6. Rear Window Defroster
7. Air Distribution (Mode) Control

The climate control system allows you to balance the temperature, amount and direction of the air circulating throughout the vehicle.

The system is always at operational readiness, except when manually switched off. The climate control only operates with the engine running.

The climate control removes a considerable amount of moisture from the air during operation in the air conditioning mode, therefore it is considered normal operation for water to drip on the ground through ducts in the underbody.

The settings and controls are as follows:

#### Temperature Control

Use the driver or passenger temperature control to regulate the temperature of the air inside the passenger compartment. The blue area of the control indicates cooler temperatures, while the red area indicates warmer temperatures.

The temperature selector should be left at the desired temperature setting so that the system can automatically reach that selection as quickly as possible. The inside

temperature will not heat or cool any quicker by setting the selector higher or lower upon initial start up.

#### Fan Control



Use this control to regulate the amount of air volume moving through the system in any mode you select. Turn the control clockwise to increase fan speed; counterclockwise to decrease fan speed.

#### Basic Setting - Heater



Select a temperature for each side of the passenger compartment. Select air volume with the fan control switch and set the fan control at least to position 2 to prevent windows from fogging up. Set the air distribution control switch to the tri-level setting. Turn the defroster outlets for the side windows to the detent positions. Open center air outlets as desired.



Select a temperature for each side of the passenger compartment. Select air volume with the fan control switch. Then select the panel setting on the air distribution control switch to force air from the panel outlets.



Select a temperature for each side of the passenger compartment. Select air volume with the fan control switch. Then select the Bi-Level setting on the air distribution control switch to force air from both the upper panel outlets and the floor outlets.

#### Basic Setting - Air Conditioner



Press the air conditioning ON/OFF switch. The light in the switch will illuminate. Select a temperature for each side of the passenger compartment. Select the air volume with the fan control switch, at least to position 1. Set the air distribution control switch to one of the positions shown above. Open center air outlets. Open left and right side air outlets.

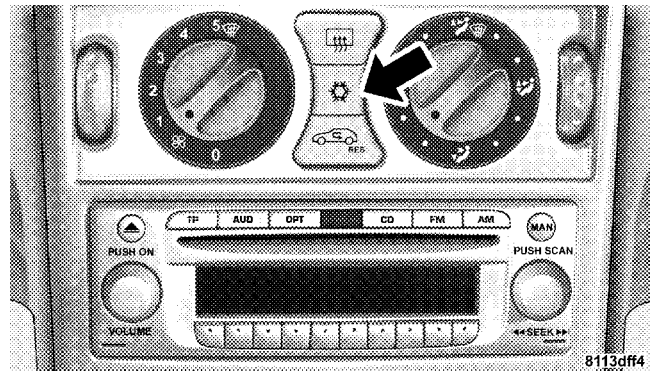

**NOTE:** The dot between the air distribution control icons is a mix position between the two modes.

Slight changes in engine speed or power may be noticed when the compressor is on. This is a normal occurrence, since the compressor will cycle on and off to maintain comfort and increase fuel economy.

**NOTE:** If your air conditioning performance seems lower than expected, check the front of the A/C condenser for an accumulation of dirt or insects.



### Defrosting

 Set the temperature selectors to the maximum heating position, set the fan control to position 5, and the air distribution to the defrost position. Close the center air outlets. Close the left and right side air outlets. Turn the defroster outlets for the side windows to the detent position.

### Defogging Windows Fogged Up On Inside

Press the A/C button; the indicator light should illuminate. Switch off the air recirculation; the indicator light should go out. Set the air distribution control switch to the defrost position. Increase air volume with the fan control switch. Close the center, left, and right side air outlets. Turn the defroster outlets for the side windows to the detent position.

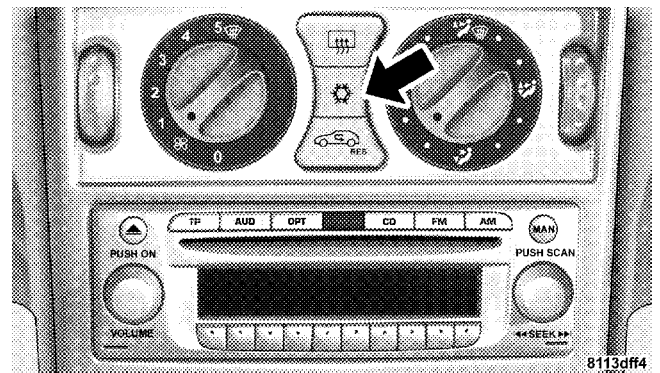

4

### Windshield Fogged Up On Outside

Switch on the windshield wipers. Set the air distribution control switch to the defrost position. Increase air volume with the fan control switch. Close the center and right side air outlets. Turn the defroster outlets for the side windows to the detent position.

### Ventilation

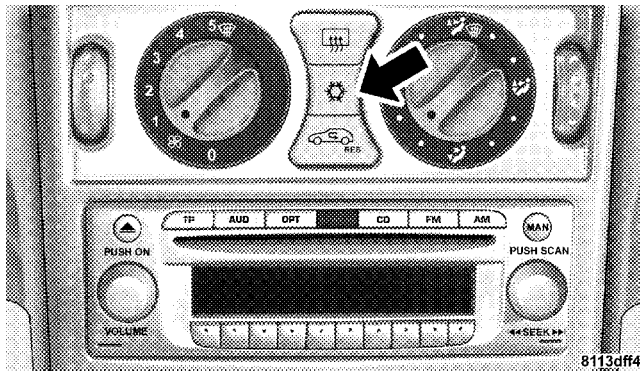

To receive outside air through the panel outlets, turn off the Air Conditioning ON/OFF switch. The light in the switch should be off. Set the controls as above for basic air conditioning.

### Climate Control - OFF

To switch the climate control off, set the air volume control switch to position 0. The fresh air supply to the vehicle interior is shut off. While driving, use this setting only temporarily, otherwise the windshield could fog up.

### Rear Window Defroster



Turn the key in the ignition switch to the ON/RUN position. To select, press the rear window defroster button once and release. The indicator light in the switch should illuminate. To cancel, press the rear window defroster button again and release.

**NOTE:** Heavy accumulation of snow and ice should be removed before activating the defroster. The rear window defroster uses a large amount of power. To keep the battery drain to a minimum, turn off the defroster as soon as the window is clear. The defroster is automatically turned off after a maximum of 12 minutes of operation.

If several components in the vehicle are consuming power simultaneously, or the battery is only partially charged, it is possible that the defroster will automatically turn itself off. When this happens, the indicator light inside the switch starts blinking. As soon as the battery has sufficient voltage, the defroster automatically turns itself back on.

**CAUTION!**

To avoid damaging the electrical conductors, do not use scrapers, sharp instruments, or abrasive window cleaners on the interior surface of the rear window. Labels can be peeled off by soaking with warm water.

**Air Recirculation/REST**

This mode can be selected to temporarily reduce the entry of annoying odors or dust into the vehicle's interior. Outside air does not flow into the vehicle's interior. To select, press the recirculation button. To cancel, press the recirculation button again.

The system will automatically switch from recirculated air to fresh air after approximately five minutes at outside temperatures below approximately 40°F (5°C); after approximately 30 minutes, at outside temperatures above approximately 40°F (5°C); after approximately five minutes, if the A/C button is pressed.

At high outside temperatures, the system automatically engages the recirculated air mode for approximately 30 minutes, thereby increasing the cooling capacity performance. Press the recirculation button again to extend the recirculated air mode.

**Residual Engine Heat Utilization (REST)**

With the engine switched off, it is possible to continue heating the interior for a short while. Air volume is controlled automatically. Select a temperature for each side of the passenger compartment. Set the air distribution control switch to the desired position.

To select, turn the key in the ignition switch to the ACC or the OFF/LOCK position or remove. Press the recirculation button. The indicator light in the button illuminates. This function selection will not activate if the battery charge level is insufficient.

To cancel, press the recirculation button. The indicator light in the button goes out. The system will automatically shut off if you turn the key in the ignition switch to the ON/RUN position, after approximately 30 minutes, or if the battery voltage drops.













**NOTE:** This vehicle is equipped with an air conditioner system that uses R-134a (HFC: hydrofluorocarbon) as a refrigerant. Repairs should always be performed by a qualified technician, and refrigerant should be collected in a recovery system for recycling.

**Dust Filter**

Nearly all dust particles and pollen are filtered out before outside air enters the passenger compartment through the air distribution system.

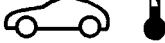
**NOTE:** Keep the air intake grille in front of windshield free of snow and debris.

**Operating Tips**

WEATHER	CONTROL SETTINGS
<p>HOT WEATHER AND VEHICLE INTERIOR IS VERY HOT</p> 	<p>Start vehicle and press Air Recirculation button  and turn on A/C. Set Fan Control to High. Roll windows down to flush out hot air. Roll windows up after hot air is flushed out. Turn Mode Control to  and set Fan and Temp Knobs as desired once car has cooled.</p>
<p>WARM WEATHER</p> 	<p>Set the Mode Control to  position and turn A/C on in sunny weather. Choose the  position for cloudy or dark conditions with A/C on.</p>
<p>COOL OR COLD HUMID CONDITIONS</p> 	<p>Set the Mode Control to  position and turn the A/C on in sunny weather. Choose the  position and turn on the A/C in cloudy or dark conditions.</p>
<p>COLD DRY CONDITIONS</p> 	<p>Use the  position in sunny weather, the  position in cloudy or dark weather, and the  Mode Knob setting for snowy or very cold weather that requires extra heat to the windshield.</p>

8118231d

---

# STARTING AND OPERATING

## CONTENTS

---

■ Starting Procedures . . . . .	119	□ Park Position . . . . .	125
□ Normal Starting . . . . .	119	□ Reverse . . . . .	126
□ Extremely Cold Weather (Below -20°F Or -29°C) . . . . .	120	□ Neutral . . . . .	126
□ If Engine Fails To Start . . . . .	120	□ Drive . . . . .	126
□ After Starting . . . . .	121	□ AutoStick® Gear Selection . . . . .	126
■ Transmission Shifting . . . . .	121	□ Gear Ranges . . . . .	128
□ Manual Transmission . . . . .	121	□ Program Mode Selector Switch . . . . .	128
□ Recommended Shift Speeds . . . . .	122	□ Emergency Operation (Limp Home Mode) . . . . .	129
□ Automatic Transmission . . . . .	123	■ Parking Brake . . . . .	130
□ Stopping . . . . .	124	■ Brake System . . . . .	131
□ Maneuvering . . . . .	125	□ Brake Assist System (BAS) . . . . .	131

118 STARTING AND OPERATING

□ Electronic Stability Program (ESP) . . . . .	133	□ Replacement Tires . . . . .	146
□ Synchronizing ESP . . . . .	135	□ Tire Rotation Recommendations . . . . .	147
□ ESP Control Switch . . . . .	135	□ Alignment And Balance . . . . .	149
□ Anti-Lock Brake System (ABS) . . . . .	136	■ Fuel Requirements . . . . .	149
□ Brake Pad Break-In . . . . .	139	□ Reformulated Gasoline . . . . .	150
■ Power Steering . . . . .	139	□ Gasoline/Oxygenate Blends . . . . .	150
■ Tires . . . . .	140	□ MMT In Gasoline . . . . .	150
□ Tire Inflation Pressures . . . . .	141	□ Materials Added To Fuel . . . . .	151
□ Tire Pressure Monitor System . . . . .	142	□ Sulfur In Gasoline . . . . .	151
□ High Speed Operation . . . . .	143	■ Adding Fuel . . . . .	152
□ Tire Spinning . . . . .	143	□ Fuel Filler Cap (Gas Cap) . . . . .	152
□ Tire Chains . . . . .	143	■ Vehicle Loading . . . . .	154
□ Original Equipment Tires . . . . .	144	□ Roof Luggage Rack . . . . .	154
□ Snow Tires . . . . .	144	■ Trailer Towing . . . . .	155
□ Tread Wear Indicators . . . . .	145		

**STARTING PROCEDURES****WARNING!**

**Do not leave animals or children inside parked vehicles in hot weather; interior heat build up may cause serious injury or death.**

Be sure that the parking brake is engaged and that selector lever is in the NEUTRAL or PARK position (gearshift lever in Neutral). Turn the key in the ignition switch to the ON/RUN position. Apply the brakes before shifting into any driving gear.

**Normal Starting****Vehicles with automatic transmissions:**

Do not depress the accelerator. Simply turn the key in the ignition switch clockwise to the START position and release when the engine starts. If the engine will not run, turn the key counterclockwise to the OFF/LOCK position and repeat the starting procedure. If there are several unsuccessful attempts, have the system checked at the nearest authorized dealer.

**Vehicles with manual transmissions:**

Do not depress the accelerator. Fully depress the clutch pedal, otherwise the engine cannot be started due to the integrated safety interlock. Simply turn the key in the ignition switch clockwise to the START position and release when the engine starts. The starter will engage until the engine is running. If the engine will not run, turn the key counterclockwise to the OFF/LOCK position and repeat the starting procedure. If there are several unsuccessful attempts, have the system checked at the nearest authorized dealer.

**NOTE:** Due to the starter non-repeat feature, the key must be turned completely to the left before attempting to start the engine again.

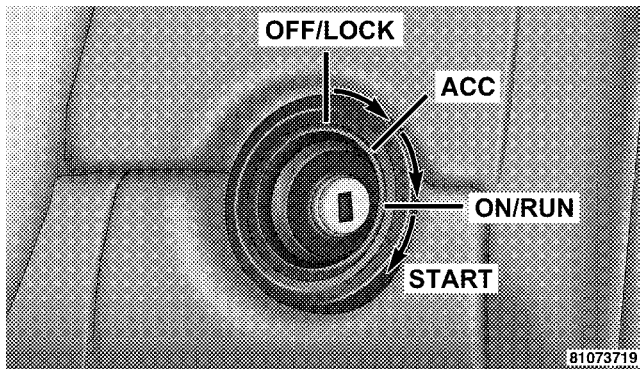

#### Extremely Cold Weather (below -20°F or -29°C)

For reliable starting in areas where temperatures frequently drop below -20°F (-29°C), we recommend the use of an externally powered battery and an electric engine block heater. Advice on these items and installation is available at your authorized dealer.

#### If Engine Fails to Start

##### CAUTION!

Do not try to push or tow your vehicle to get it started. Your vehicle cannot be started this way. Pushing with another vehicle may damage the transmission or the rear of your vehicle. See Section 6 of this manual for proper jump-starting procedures.

##### WARNING!

Never pour fuel or other flammable liquid into the throttle body air inlet opening in an attempt to start the vehicle. This could result in a flash fire, causing serious personal injury.

If the engine fails to start after you have followed the Normal Starting procedure, it may be flooded. Push the



accelerator pedal all the way to the floor and hold it there while cranking the engine. This should clear any excess fuel in case the engine is flooded.

### CAUTION!

**To prevent damage to the starter, do not crank the engine for more than 15 seconds at a time. Wait 10 to 15 seconds before trying again.**

If the engine has been flooded, it may start to run, but not have enough power to continue running when the key is released. If this occurs, continue cranking with the accelerator pedal pushed all the way to the floor. Release the accelerator pedal and the key once the engine is running smoothly.

If the engine shows no sign of starting after two 15-second periods of cranking with the accelerator pedal held to the floor, the Normal Starting procedure should be repeated.

### After Starting

The idle speed will automatically decrease as the engine warms up.

## TRANSMISSION SHIFTING

### Manual Transmission



**NOTE:** The parking brake should be engaged and the gear selector placed in REVERSE before leaving the vehicle, especially on an incline. To place the transmission in REVERSE, lift up on the shifter knob, push it to the left and pull it back.

Fully depress the clutch pedal before you shift gears. As you release the clutch pedal, lightly depress the accelerator pedal.

Be sure the transmission is in **FIRST** gear, (not **THIRD**), when starting from a stopped position. Damage to the clutch can result from starting in **THIRD**.

**NOTE:** If there is a need to restart your engine, you must recycle your ignition switch to the **OFF** position before restarting the engine.

For most city driving, you will find it easier to use only the lower gears. For steady highway driving with light accelerations, sixth gear is recommended.

Never drive with your foot resting on the clutch pedal, or try to hold the vehicle on a hill with the clutch pedal partially engaged. This will cause abnormal wear on the clutch.

Never shift into **REVERSE** until the vehicle has come to a complete stop.

**NOTE:** During cold weather, until the transmission lubricant has warmed, you may have difficulty shifting. This is normal and not harmful to the transmission.

### Recommended Shift Speeds

To use your manual transmission for both fuel economy and performance, it should be upshifted as shown in the chart. Shift at the vehicle speeds listed for acceleration.

Earlier upshifts during cruise conditions (relatively steady speeds) will result in increased fuel economy, and may be used as indicated.

Higher upshift speeds may be used to obtain a desired acceleration rate.

MANUAL TRANSMISSION RECOMMENDED SHIFT SPEEDS					
	1-2	2-3	3-4	4-5	5-6
MPH	15	25	40	45	50
(km/h)	(24)	(40)	(64)	(72)	(80)

**WARNING!**

When leaving the vehicle, always remove the key from the ignition switch, and lock the vehicle. Do not leave children unattended in the vehicle, or with access to an unlocked vehicle. Children could move the gearshift lever, which could result in an accident or serious injury.

**WARNING!**

Skipping more than one gear while downshifting could cause you to lose control of your vehicle. You could have an accident.

**CAUTION!**

If you skip more than one gear while downshifting or downshift at too high an engine speed, you could damage the engine, transmission, or clutch.

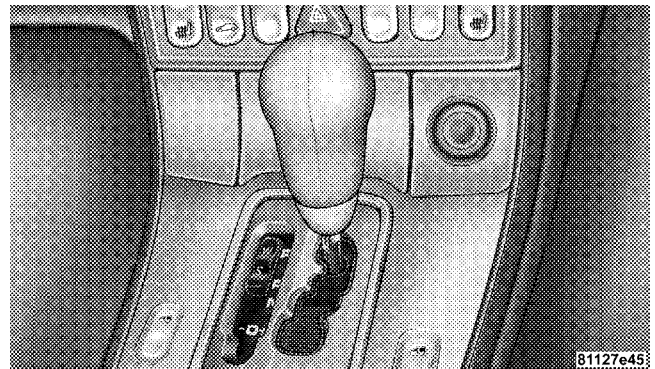
**Automatic Transmission**

The automatic transmission selects individual gears automatically, dependent upon:

- Selector lever position
- Program mode selector switch
- Accelerator position
- Vehicle speed

The gear shifting process is continuously adapted, dependent on the driving style, the driving situation and the road characteristics.

The selector lever is automatically locked while in the PARK position. To move the selector lever out of the PARK position, the brake pedal must be firmly depressed before the shift lock will release.

Shift the selector lever to the desired position only when the engine is idling normally and the brake pedal is applied. Do not release the brake until ready to drive. The vehicle may otherwise accelerate quickly when the selector lever is in DRIVE or REVERSE position.

**NOTE:** After selecting any driving position, wait a moment to allow the gear to fully engage before accelerating, especially when the engine is cold.

#### WARNING!

**It is dangerous to shift the selector lever out of PARK or NEUTRAL if the engine speed is higher than idle speed. If your foot is not firmly on the brake pedal, the vehicle could accelerate quickly forward or in reverse. You could lose control of the vehicle and hit someone or something. Only shift into gear when the engine is idling normally and when your foot is firmly on the brake pedal.**

#### Stopping

For brief stops, leave the transmission in gear and hold the vehicle with the brake pedal. For longer stops with the engine idling, shift into the NEUTRAL or PARK position and hold the vehicle with the parking brake. When stopping the vehicle uphill, do not hold it with the accelerator; use the brake. This avoids unnecessary transmission heat build-up.

### Maneuvering

To maneuver in tight areas, control the vehicle speed by gradually releasing the brakes. Accelerate gently and never abruptly step on the accelerator.

To rock a vehicle out of soft ground (mud or snow), alternately shift from forward to reverse, while applying only slight acceleration. Rocking a vehicle free in this manner may cause the ABS or traction system malfunction indicator light to come on. Turn off the engine and restart the engine to clear the malfunction indication.

### Park Position

The PARK position is to be used when parking the vehicle. Engage only with the vehicle stopped. The PARK position is not intended to serve as a brake when the vehicle is parked. Rather, the driver should always use the parking brake in addition to placing the selector lever in PARK to secure the vehicle.

**NOTE:** The key can be removed from the ignition switch only with the selector lever in the PARK position. With the key removed, the selector lever is locked in the PARK position.

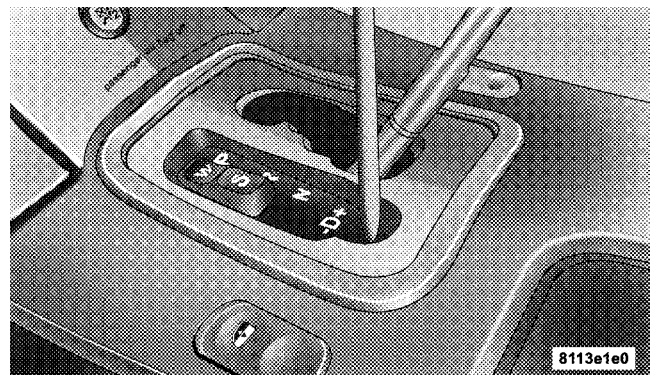

With a malfunction in the vehicle's electrical system, the selector lever could remain locked in the PARK position. To unlock the selector lever manually, insert the end of the multipurpose tool from the glove box (or ball point pen) into the covered opening below the position "D" of the shift pattern. While pushing the tool down, move the selector lever out of the PARK position. After removal of the tool from the opening, the cover will not close fully. Only after moving the selector lever to the "D+" and "D-" positions does the cover return to its closed position.

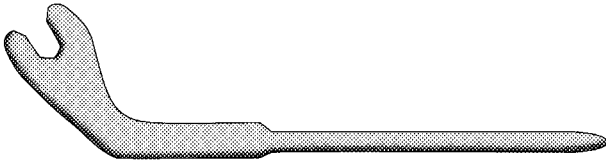

8119a19e

**Reverse**

Shift into REVERSE gear only when the vehicle is completely stopped.

Dependent on the program mode selector switch position "S" or "W," the maximum speed in the REVERSE gear is different. However, it is not possible to change the program mode while in REVERSE.

**Neutral**

No power is transmitted from the engine to the drive axle. When the brakes are released, the vehicle can be moved freely (pushed or towed). Do not engage in NEUTRAL position while driving except to coast when the vehicle is in danger of skidding (e.g., on icy roads).

**NOTE:** Coasting the vehicle, or driving for any other reason with selector lever in NEUTRAL can result in transmission damage that is not covered by the Limited Warranty.

**Drive**

The transmission automatically upshifts through fifth gear. The DRIVE position provides optimum driving characteristics under all normal operating conditions.

**AutoStick® Gear selection**

The transmission gear can be selected by pressing the selector lever to the right or the left with the selector lever in the DRIVE position. The gear currently selected is indicated in the instrument cluster display. Briefly press selector lever in the "D-" direction. The transmission will shift from the current gear to the next lower gear. Shifting

into another gear that allows for quicker acceleration or to slow the vehicle down is possible. Downshifts can also be performed.

Press and hold the selector lever in the “D-” direction. The transmission will shift from the current gear directly to the best gear for acceleration.

**NOTE:** To avoid overrevving the engine when the selector lever is moved in “D-” direction, the transmission will not shift to a lower gear if the engine’s revolutions per minute limit would be exceeded.

Briefly press the selector lever in the “D+” direction. The transmission will shift from the current gear to the next higher gear.

Press and hold the selector lever in the “D+” direction. The transmission will shift from the current gear directly to gear “D.”

### WARNING!

**On slippery road surfaces, never downshift in order to obtain braking action. This could result in drive wheel slip and reduced vehicle control. Your vehicle’s ABS will not prevent this type of loss of control. You could lose control of your vehicle and have an accident.**

**NOTE:** With transmission in gear “D,” “4,” or “3,” upshifting from FIRST to SECOND to THIRD gear may be delayed, depending on vehicle speed and engine temperature. This allows the catalytic converter to heat up more quickly to operating temperatures.

The delayed upshift is effective with vehicle speeds below 31 mph (50 km/h) at partial throttle and engine temperatures below 95°F (35°C). To prevent the engine from laboring at low RPM when driving uphill or with your vehicle heavily loaded, the automatic transmission will downshift when necessary to maintain engine RPM within the best torque range.

### Gear Ranges

#### “P” PARK

**NOTE:** If the key is in the ON/RUN position, you must press the brake pedal to shift out of the PARK position.

PARK supplements the parking brake by locking the transmission. The engine can be started in this range. Never attempt to use PARK while the vehicle is in motion.

Apply the parking brake when leaving the vehicle in this range.

#### “R” REVERSE

Shift into this range only after the vehicle has come to a complete stop.

#### “N” NEUTRAL

The engine may be started in this range. Use this range for starting your vehicle if it is moving or being towed.

#### “D” OVERDRIVE

This range should be used for most city and highway driving. It provides the smoothest upshifts and downshifts and best fuel economy.

### Program mode selector switch

The transmission is provided with a selector switch for Standard “S” and Winter/Wet “W” (snow and ice) program modes.

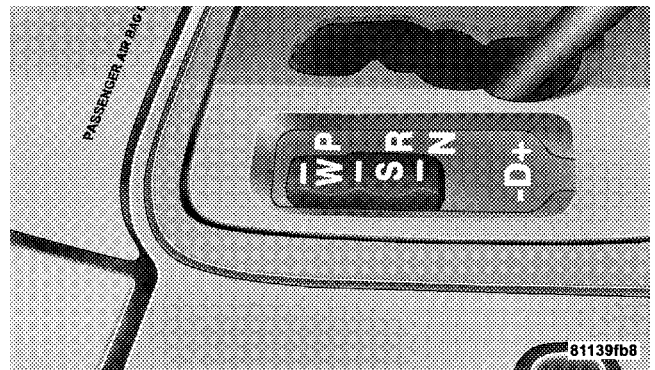

For standard mode, press the “S” symbol on the switch. Use this mode for all regular driving. The vehicle starts out in FIRST gear.



Depressing the accelerator pedal rapidly or nearly to the floor while driving (kickdown position), rather than depressing the accelerator pedal in slow, small movements, will cause the automatic transmission to shift down into a lower gear. Rapid release of the accelerator pedal will normally result in an upshift. This gear shifting process is dependent on the current vehicle speed.

For Winter/Wet (snow and ice) mode, press the “W” symbol on the switch. The vehicle starts out in SECOND gear, unless FIRST gear has been selected, or the accelerator pedal is in the kickdown position. The “W” mode helps to improve traction and driving stability of the vehicle. The gear shifting process occurs at lower vehicle and engine speeds than in the “S” program mode.

### CAUTION!

**Never change the program mode when the selector lever is out of the PARK position. It could result in a change of driving characteristics for which you may not be prepared.**

### Emergency Operation (Limp Home Mode)

If vehicle acceleration worsens, or the transmission no longer shifts, the transmission is most likely operating in Limp Home Mode which engages when there is a malfunction of the transmission.

This condition may be accompanied by the CHECK ENGINE light in the instrument cluster coming on.

In this mode only the SECOND gear or REVERSE gear can be activated.

To engage SECOND gear or REVERSE:

1. Stop the vehicle.
2. Move the selector lever to the PARK position.
3. Turn off the engine.
4. Wait approximately 10 seconds.
5. Restart the engine.
6. Move the selector lever to the DRIVE position (for SECOND gear), or move the selector lever to the REVERSE position (for REVERSE gear).

Have the transmission checked at your authorized dealer as soon as possible.

### PARKING BRAKE

**BRAKE** When you apply the parking brake with engine running, the brake system warning light in the instrument cluster will come on.

**NOTE:** This light, when illuminated with parking brake application, shows only that the parking brake is on. It does not show the degree of brake application.

**NOTE:** If the light remains on with the parking brake released, a brake system malfunction is indicated. Have the brake system serviced by an authorized dealer immediately.

Before leaving the vehicle, make sure that the parking brake is fully applied. For manual transmission vehicles, place the gear selector in REVERSE. For vehicles equipped with automatic transmissions, place the gear selector in the PARK position.

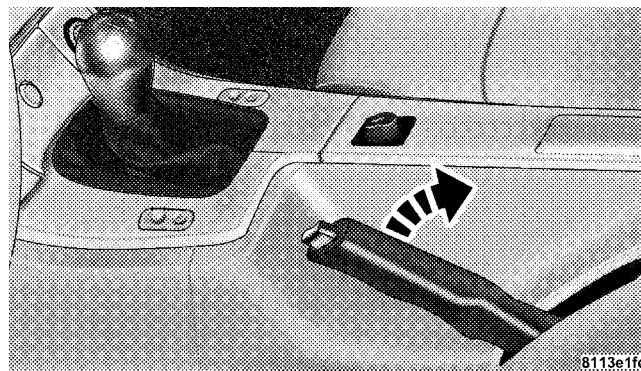

To release the parking brake, slightly pull up the handle while pushing the lock button, and guide the lever downward to its stop. The brake warning light in the instrument cluster should go out.

A warning sounds if you start to drive without having released the parking brake.

When parking on a hill, you must set the parking brake **before** placing the gear selector in PARK. If you don't, the load on the transmission locking mechanism may make it difficult to move the selector out of PARK. As an added

precaution, turn the front wheels toward the curb on a downhill grade and away from the curb on an uphill grade.

The parking brake should always be applied when the driver is not in the vehicle.

**WARNING!**

**Be sure the parking brake is fully disengaged before driving; failure to do so can lead to brake failure and an accident.**

**WARNING!**

**Do not leave children unattended in a vehicle. A child could be injured, or could injure others, if left unattended.**

**BRAKE SYSTEM**

Your vehicle is equipped with power brakes as standard equipment. In the event power assist is lost for any reason (for example, repeated brake applications with the engine off), the brakes will still function. The effort required to brake the vehicle will be much greater than that required with the power system operating.

If either the front or rear hydraulic system loses normal capability, the remaining system will still function with some loss of overall braking effectiveness. This will be evident by increased pedal travel during application, greater pedal force required to slow or stop, and activation of the brake warning light during brake use.

**Brake Assist System (BAS)**

The BAS is designed to maximize the vehicle's braking capability during emergency braking maneuvers. Maximum power boost is applied to the brakes more quickly in emergency braking conditions. This can help reduce braking distances relative to what ordinary driving and braking style might do.

The BAS complements the antilock brake system (ABS). Applying the brakes very quickly results in maximum

BAS assistance. To receive the benefit of the system you must apply continuous, full braking power during the stopping sequence. Do not reduce brake pedal pressure.

### WARNING!

**BAS cannot prevent the natural laws of physics from acting on the vehicle, nor can it increase braking efficiency beyond that afforded by the condition of the vehicle brakes and tires or the traction afforded. The BAS cannot prevent accidents, including those resulting from excessive speed in turns, following another vehicle too closely, or hydroplaning. Only a safe, attentive, and skillful driver can prevent accidents. The capabilities of a BAS-equipped vehicle must never be exploited in a reckless or dangerous manner which could jeopardize the user's safety or the safety of others.**

Once the brake pedal is released, the BAS is deactivated.

The malfunction indicator light for the BAS is combined with the Electronic Stability Program (ESP) malfunction indicator light.

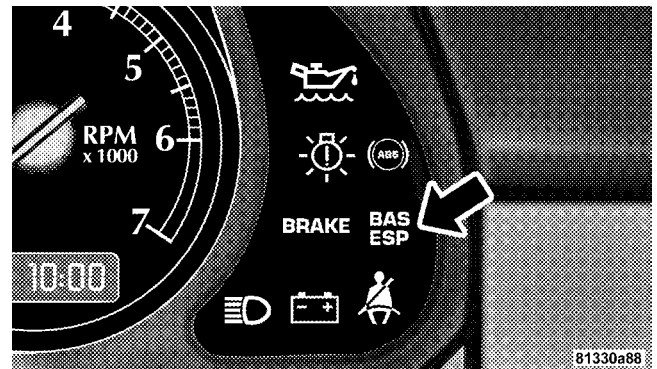

The BAS/ESP malfunction indicator light in the instrument cluster comes on with the key in the ignition switch turned to the ON/RUN position and should go out with the engine running. If the BAS/ESP malfunction indicator light comes on steadily while the engine is running, a malfunction has been detected in either the BAS or ESP

system. As a result, it is possible that only partial engine output will be available, and pressing the accelerator pedal will require more effort.

If the BAS malfunctions, the brake system functions in the usual manner, but without BAS.

With the ABS malfunctioning, the BAS and ESP will be disabled. In this condition, both malfunction indicator lights come on while the engine is running. If the malfunction indicator light stays illuminated, have the BAS and ESP checked at your authorized dealer as soon as possible.

#### **Electronic Stability Program (ESP)**

The ESP enhances directional control and reduces wheel-spin under various driving conditions. When ESP is active, engine torque is limited and the ESP warning light starts to flash.

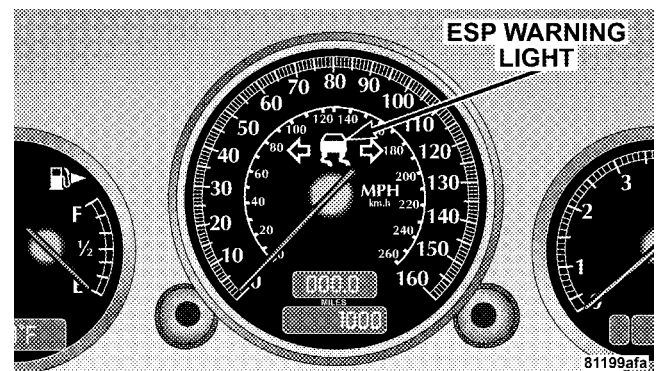

In winter operation, the effectiveness of the ESP can be enhanced by equipping the vehicle with DaimlerChrysler recommended mud and snow (M+S) rated radial-ply tires and/or snow chains.

**WARNING!**

ESP cannot prevent the natural laws of physics from acting on the vehicle, nor can it increase the traction afforded. The ESP cannot prevent accidents, including those resulting from excessive speed in turns, or hydroplaning. Only a safe, attentive, and skillful driver can prevent accidents. The capabilities of an ESP equipped vehicle must never be exploited in a reckless or dangerous manner which could jeopardize the user's safety or the safety of others.

The ESP warning light starts to flash at any vehicle speed as soon as the tires lose traction and the wheels begin to spin.

If the ESP warning light flashes during acceleration, ease up on the accelerator and apply as little throttle as possible. While driving, adapt your speed to the prevailing road conditions.

**CAUTION!**

If the vehicle is towed with the front axle raised (see the What To Do In Emergencies section in this manual), the engine must be shut off (key in the ignition switch turned to the OFF/LOCK or ACC position). Otherwise, the ESP will immediately be engaged and will apply the rear wheel brakes.

**NOTE:** When the ESP warning light is illuminated continuously, the ESP is switched off. Adapt your speed and driving to the prevailing road conditions.

**NOTE:** Avoid spinning of one drive wheel. This may cause serious damage to the drivetrain which is not covered by the DaimlerChrysler Limited Warranty.

**NOTE:** If the ESP warning light flashes during acceleration, ease up on the accelerator.

**NOTE:** ESP should not be switched off during normal driving. Disabling of the system under normal operating conditions will eliminate the benefits of the ESP system.

### Synchronizing ESP

If the power supply was interrupted (battery disconnected or discharged), the BAS/ESP malfunction indicator light may be illuminated with the engine running. To re-synchronize the ESP, and cancel the malfunction indicator light, the steering angle sensor will need to be recalibrated.

1. Turn the ignition switch to the ON/RUN position.
2. Rotate the steering wheel to the center position.
3. Rotate the steering wheel completely to the left, and then rotate the steering wheel completely to the right.
4. Bring the steering wheel back to the center position.
5. The BAS/ESP malfunction indicator light will go out.

If the BAS/ESP malfunction indicator light is still illuminated, the vehicle should be serviced at an authorized dealer.

### ESP Control switch

The ESP control switch is located in the center console. When the ESP is switched off, the warning light in the instrument cluster comes on. When the ESP is switched on, the warning light goes out.

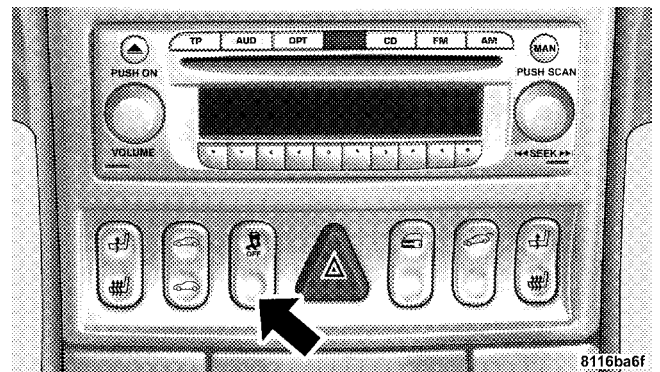

To improve the vehicle's traction when driving with snow chains, or starting off in deep snow, sand, or gravel, switch off the ESP by pressing the upper half of the ESP switch. The ESP warning light will then be continuously

illuminated. With the ESP system switched off, the engine torque reduction feature is cancelled. Therefore, the enhanced vehicle stability offered by ESP is unavailable.

**CAUTION!**

**Snow chains should never be used without the recommended mud and snow (M+S) rated radial-ply tires. Damage to your vehicle may result from such usage.**

ESP always operates under braking, even with the switch in the OFF position.

If one drive wheel loses traction and begins to spin, the ESP system will apply the brake at the affected wheel until the wheel regains sufficient traction. The traction control engages at vehicle speeds between approximately 24 mph (40 km/h), and switches off at 50 mph (80 km/h).

To return to the enhanced vehicle stability offered by ESP, press the lower half of the switch (the ESP warning light goes out).

**Anti-Lock Brake System (ABS)**

The ABS gives increased vehicle stability and brake performance under most braking conditions. The system automatically “pumps” the brakes during severe braking conditions to prevent wheel lock-up. The system operates to prevent wheel lock-up and help avoid skidding on slippery surfaces.

**NOTE:** The ABS improves steering control of the vehicle during hard braking maneuvers.

The ABS prevents the wheels from locking up above a vehicle speed of approximately 5 mph (8 km/h) independent of road surface conditions.

At the instant one of the wheels is about to lock up, a slight pulsation can be felt in the brake pedal, indicating that the ABS is in the regulating mode.

Keep firm and steady pressure on the brake pedal while experiencing the pulsation. Continuous, steady brake pedal pressure results in optimal braking power while maintaining the ability to steer the vehicle.



In the case of an emergency brake maneuver, keep continuous full pressure on the brake pedal. In this manner only can the ABS be most effective.

On slippery road surfaces, the ABS will respond even with light brake pedal pressure because of the increased likelihood of locking wheels. The pulsating brake pedal can be an indication of hazardous road conditions and functions as a reminder to take extra care while driving.

#### WARNING!

**Significant over- or under-inflation of tires, or mixing sizes of front or rear tires or wheels on the vehicle can reduce braking effectiveness. Maintain proper tire pressure and always use the tires and wheels specified in this manual for your vehicle.**

The anti-lock brake system conducts a low-speed self-test at about 12 mph (20 km/h). If you have your foot lightly on the brake while this test is occurring, you may feel slight pedal movement. The movement can be more

apparent on ice and snow. The anti-lock brake system pump motor makes a low humming noise during operation, which is normal.

#### WARNING!

**Pumping of the brake pedal will diminish the effectiveness of the anti-lock brakes and may lead to an accident. Pumping makes the stopping distance longer. Just press firmly on your brake pedal when you need to slow down or stop.**

**NOTE:** During severe braking conditions, a pulsing sensation may occur and a clicking noise will be heard. This is normal, indicating that the anti-lock brake system is functioning.

The ABS malfunction indicator light in the instrument cluster comes on with the key in the ignition switch turned to the ON/RUN position, and should go out with the engine running. If the ABS light does not illuminate

briefly during this procedure, or remains on after the engine is running, have the system checked by an authorized dealer.

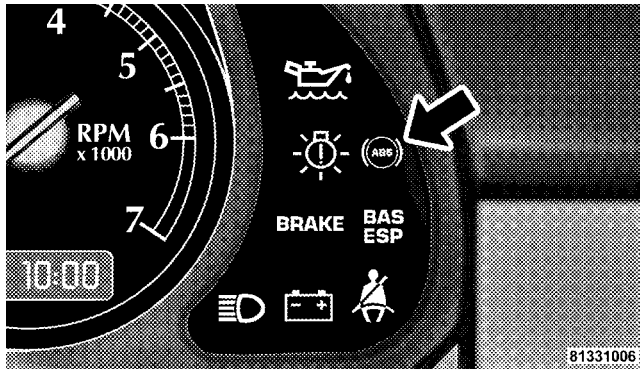

When the ABS malfunction indicator light in the instrument cluster comes on while the engine is running, it indicates that the ABS has detected a malfunction and has switched off. In this case, the brake system functions in the usual manner, but without antilock assistance. With the ABS malfunctioning, the BAS and ESP are also switched off. Both malfunction indicator lights come on with the engine running. If the charging voltage falls

below 10 volts, the malfunction indicator light comes on and the ABS is switched off. When the voltage is above this value again, the malfunction indicator light should go out and the ABS is operational. If the malfunction indicator light stays illuminated, have the system checked at your authorized dealer as soon as possible.

#### WARNING!

**ABS cannot prevent the natural laws of physics from acting on the vehicle, nor can it increase braking or steering efficiency beyond that afforded by the condition of the vehicle brakes and tires or the traction afforded. The ABS cannot prevent accidents, including those resulting from excessive speed in turns, following another vehicle too closely, or hydroplaning. Only a safe, attentive, and skillful driver can prevent accidents. The capabilities of an ABS-equipped vehicle must never be exploited in a reckless or dangerous manner which could jeopardize the user's safety or the safety of others.**

**WARNING!**

To use your brakes and accelerator more safely, follow these tips:

- Do not “ride” the brakes by resting your foot on the pedal. This could overheat the brakes and result in unpredictable braking action, longer stopping distances, or brake damage.
- When descending mountains or hills, repeated braking can cause brake fade with loss of braking control. Avoid repeated heavy braking by downshifting the transmission whenever possible.
- Do not drive too fast for road conditions, especially when roads are wet or slushy. A wedge of water can build up between the tire tread and the road. This hydroplaning action can cause loss of traction, braking ability, and control.
- After going through deep water or a car wash, brakes may become wet, resulting in decreased performance and unpredictable braking action. Dry the brakes by gentle, intermittent pedal action while driving at very slow speeds.

**Brake Pad Break-In**

The brakes on your vehicle do not require a long break-in period, but avoid repeated hard brake applications from high speeds during initial break-in. Also avoid severe brake loading such as may be encountered when descending long mountain grades.

**POWER STEERING**

The power-assisted steering system of your vehicle provides mechanical steering capability in the event power assist is lost.

If, for some reason, the hydraulic pressure is interrupted, it will still be possible to steer your vehicle. Under these conditions, you will observe a substantial increase in steering effort.

## TIRES

Please take the time to read the tire warranty booklet in your Owner's Manual package. It contains valuable information on tire maintenance.

Specific recommendations on guidelines for long-term tire storage should be requested of the tire manufacturer. Please refer to the tire warranty booklet for contact information.

### 1. Safety

**NOTE:** Unequal tire pressures from one side of the vehicle to the other can cause the vehicle to drift to the right or left.

### WARNING!

- **Under-inflation increases tire flexing and can result in tire failure.**
- **Over-inflation reduces a tire's ability to cushion shock.**
- **Objects on the road and chuck holes can cause damage that may result in tire failure.**
- **Unequal tire pressures can cause steering problems. You could lose control of your vehicle.**
- **Over-inflated or under-inflated tires can affect vehicle handling and can fail suddenly, resulting in loss of vehicle control.**

### 2. Economy

Improper inflation pressures can cause uneven wear patterns to develop across the tire tread. These abnormal wear patterns will reduce tread life resulting in a need for earlier tire replacement. Under-inflation also increases tire rolling resistance and results in higher fuel consumption.

### 3. Ride Comfort And Vehicle Stability

Proper tire inflation contributes to a comfortable ride. Over-inflation produces a jarring and uncomfortable ride. Both under-inflation and over-inflation affect the stability of the vehicle and can produce a feeling of sluggish response or over-responsiveness.

Unequal tire pressures can cause erratic and unpredictable steering response.

#### Tire Inflation Pressures

The proper tire pressure for your vehicle is listed on a label attached to the driver's side door latch pillar. The pressure should be checked and adjusted at least once every month. Check more often if subject to a wide range of outdoor temperatures, as tire pressures vary with temperature changes.

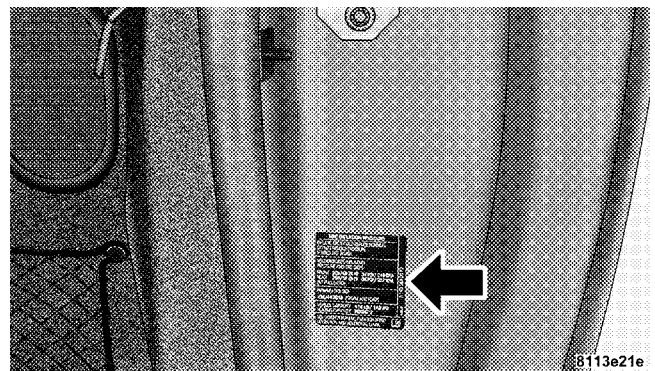

Inflation pressures specified on the label are always "Cold Inflation Pressure". Cold inflation pressure is defined as the tire pressure after the vehicle has not been driven for at least 3 hours, or driven less than a mile after a 3 hour period. The cold inflation pressure must not exceed the maximum values molded into the tire side wall.

Tire pressure may increase from 2 to 6 psi (13 to 40 kPa) during operation. Do NOT reduce this normal pressure build up or your tire pressure will be too low.

### Tire Pressure Monitor System



The Tire Pressure Monitor System (TPM) monitors the pressure in all tires. The TPM system uses wireless technology to monitor tire pressure levels. Sensors, mounted to each wheel as part of the valve stem, transmit tire pressure readings to a computer which monitors for low pressure. If low pressure is measured, the TPM Indicator Light will illuminate.

The TPM system informs you of a low tire pressure condition. If this occurs, correct your tire inflation pressure as soon as possible, and inspect all of your tires. Be sure to use a high quality gauge when adjusting pressure. The TPM system is designed to periodically monitor your tire pressure but cannot be expected to function as a tire pressure gauge. There can be a delay between the instant you adjust the air pressure in a tire and when the system updates the display. The TPM system is not intended to provide you with notification of rapid air loss.

The TPM system will cause the indicator lamp in the instrument cluster to illuminate whenever the pressure in one tire falls 25% below the recommended pressure shown on the tire label.

**NOTE:** A TPM system does not replace normal tire maintenance.

#### CAUTION!

**The TPM system has been optimized for the original equipment tires and wheels. TPM system pressures have been established for the tire size equipped on your vehicle. Undesirable operation or sensor damage may result when using replacement equipment that is not of the same size, type, and/or style. Aftermarket wheels can cause sensor damage. Do not use aftermarket tire sealant or balance beads as damage to the sensors may result. The standard TIREFIT system (see Tirefit Tire Repair and Jacking Instructions in the What To Do In Emergencies section) is specifically designed to operate in conjunction with the TPM system, and will not damage the sensors.**

**NOTE:** The pressure in your tires changes with temperature. A significant decrease in temperature could

reduce cold inflation pressure below the TPM setpoint. For example, tires inflated to the proper cold inflation pressure on a warm day or in a warm garage could illuminate the TPM indicator lamp on the following day if the temperature is very cold. **ALWAYS** check the pressure in your tires if the TPM lamp is illuminated.

### High Speed Operation

DaimlerChrysler Corporation advocates driving at safe speeds within posted speed limits. Where speed limits or conditions are such that the vehicle can be driven at high speeds, correct tire inflation pressure is very important.

When driving at speeds above 100 mph on a closed track, for example, the tire pressure of your vehicle must be increased.

### Tire Spinning

When stuck in mud, sand, snow, or ice conditions, do not spin your vehicle's wheels above 30 mph (48 km/h).

See the paragraph on Freeing A Stuck Vehicle in section 6 of this manual.

### WARNING!

**Fast spinning tires can be dangerous. Forces generated by excessive wheel speeds may cause tire damage or failure. A tire could explode and injure someone. Do not spin your vehicle's wheels faster than 30 mph (48 km/h) when you are stuck. And don't let anyone near a spinning wheel, no matter what the speed.**

5

### Tire Chains

The RUD-matic® DISC is the only tire chain system approved for use on the Chrysler Crossfire.

Chains should only be used on the rear wheels and only with the recommended winter mud and snow (M+S) tires and wheels. Follow the manufacturer's mounting instructions.

Tire chains should only be driven on snow-covered roads at speeds not to exceed 30 mph (48 km/h). Remove chains as soon as possible when driving on roads without snow.

When driving with tire chains, press the ESP control switch to OFF.

**CAUTION!**

**Damage to the vehicle may result if unapproved tire chains are used.**

**Original Equipment Tires**

Your vehicle is equipped with either sport performance tires or all-season performance tires. The sport performance tires offer the maximum road handling capability in dry and wet weather conditions. The all-season performance tires, while offering slightly less road handling capability, are able to provide traction capability in snow and ice conditions. Both types of tires are rated for high speed operation. It is important that you know what type of tires your vehicle is equipped with so that you understand their traction and handling characteristics for various road conditions. Replacement tires should be of the same size and speed rating to continue to provide the same level of performance you are accustomed to.

**Snow Tires**

Some areas of the country require the use of snow tires during winter. See the recommended snow type winter tire applications in this section.

**WARNING!**

**Your vehicle may be equipped with sport performance tires that are optimized for driving in dry and wet weather conditions. However, these tires have reduced traction capability in snow and ice. When driving your Crossfire in these conditions with these tires, you must take special care to maintain control and avoid accidents. We recommend that you equip your vehicle with "SNOW" or "ALL SEASON" tires on all four wheels for driving in snowy and icy conditions.**

If you need snow tires, the recommended size for the front and rear tires is the same size as the original equipment front tires. This size tire on the rear allows the use of tire chains on the rear wheels. Selection of this size



tire also requires the purchase of two additional wheels with the same size specification as the original equipment front wheels.

Snow tires may have a lower speed rating than factory equipped tires and may not match the maximum vehicle speed.

Snow tires should not be operated at sustained speeds over 75 mph (120 km/h).

#### **Tread Wear Indicators**

Tread wear indicators are in the original equipment tires to help you in determining when your tires should be replaced.

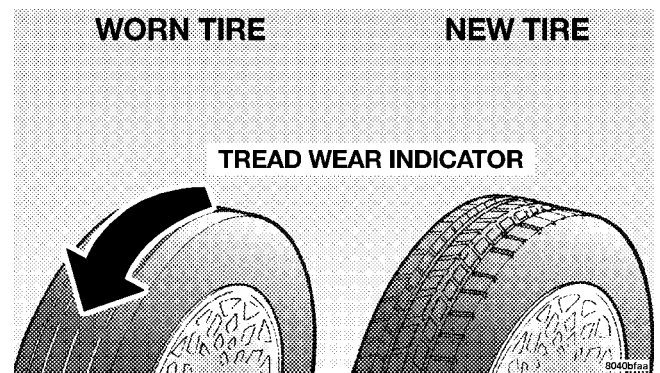

These indicators are molded into the bottom of the tread grooves and will appear as bands when the tread depth becomes 1/16 inch (2 mm). When the indicators appear in two or more adjacent grooves, the tire should be replaced.

Many states have laws requiring tire replacement at this point.

**Replacement Tires**

The tires on your new vehicle provide a balance of many characteristics. They should be inspected regularly for wear and correct inflation pressure. DaimlerChrysler Corporation strongly recommends that you use tires equivalent to the originals in size, quality and performance when replacement is needed (see the paragraph on tread wear indicators). Failure to use equivalent replacement tires may adversely affect the safety, handling, and ride of your vehicle. We recommend that you contact your original equipment dealer on any questions you may have on tire specifications or capability.

Sport Performance (Y speed rating) tires and All-Season Performance (W speed rating) tires

Front 225/40 ZR18 . . . . . 32 psi (221 kPa)

Rear 255/35 ZR19 . . . . . 33 psi (227 kPa)

Sport Performance (Y speed rating) tires and All-Season Performance (W speed rating) tires above 100 mph (161 km/h)

Front 225/40 ZR18 . . . . . 36 psi (248 kPa)

Rear 255/35 ZR19 . . . . . 36 psi (248 kPa)

Winter tires

Front 225/40 VR18 M+S . . . . . 33 psi (227 kPa)

Rear 225/40 VR18 M+S . . . . . 36 psi (248 kPa)

**WARNING!**

Do not use a tire, wheel size or rating other than that specified for your vehicle. Some combinations of unapproved tires and wheels may change suspension dimensions and performance characteristics, resulting in changes to steering, handling, and braking of your vehicle. This can cause unpredictable handling and stress to steering and suspension components. You could lose control and have an accident resulting in serious injury or death. Use only the tire and wheel sizes with load ratings approved for your vehicle.

Never use a tire small than the minimum tire size listed on your vehicle's tire label located on the driver's door latch pillar. Using a smaller tire could result in tire overloading and failure. You could lose control and have an accident.

Failure to equip your vehicle with tires having adequate speed capability can result in sudden tire failure and loss of vehicle control.

Overloading your tires is dangerous. Like under-inflation, overloading can cause tire failure. Use tires of the recommended load capacity for your vehicle and never overload them.

**CAUTION!**

Replacing original tires with tires of a different size may result in false speedometer and odometer readings. Check with your authorized dealer before replacing tires with a different size.

**Tire Rotation Recommendations**

Tires on the front and rear axles of vehicles operate at different loads and perform different steering, driving and braking functions. For these reasons, they wear at unequal rates, and tend to develop irregular wear patterns.

These effects can be reduced by timely rotation of tires. The benefits of rotation are especially worthwhile with aggressive tread designs such as those on all season type tires. Rotation will increase tread life, help to maintain mud, snow and wet traction levels, and contribute to a smooth, quiet ride.

**5**

Rotate your tires at intervals shown on the maintenance schedules. More frequent rotation is permissible if desired. The reasons for any rapid or unusual wear should be corrected before rotating.

**TIRE ROTATION PATTERN**

← **FRONT OF VEHICLE**

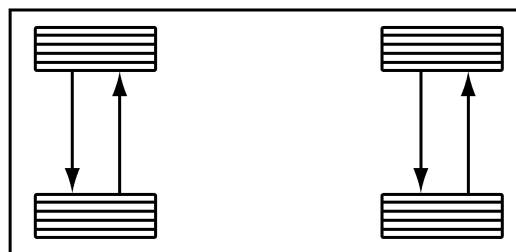

**4 TIRE ROTATION**

### Alignment And Balance

The suspension components of your vehicle should be inspected and aligned when needed to obtain full tire tread mileage.

Poor suspension alignment may result in:

- Fast tire wear
- Uneven tire wear, such as feathering and one-sided wear
- Vehicle pull to right or left

Tires may also cause vehicle to pull to the left or right. Alignment will not correct this condition. See your authorized dealer for proper diagnosis.

Improper alignment will not cause vehicle vibration. Vehicle vibration may be a result of tire and wheel out-of-balance. Proper balancing will reduce vibration and avoid tire cupping and spotty wear.

### FUEL REQUIREMENTS



Your engine is designed to meet all emissions regulations and provide satisfactory fuel economy and optimum performance when using high quality unleaded gasoline having an octane rating of 91 or higher. DaimlerChrysler Corporation requires the use of 91 octane or higher premium fuel to minimize the potential for engine damage.

Light spark knock at low engine speeds is not harmful to your engine. However, continued heavy spark knock at high speeds can cause damage and should be reported to your authorized dealer immediately. Engine damage resulting from operating with a heavy spark knock may not be covered by the new vehicle warranty.

Poor quality gasoline can cause problems such as hard starting, stalling and stumble. If you experience these problems, try another brand of gasoline before considering service for the vehicle.

Over 60 automobile manufacturers around the world have issued and endorsed consistent gasoline specifications (the World Wide Fuel Charter, WWFC) to define

fuel properties necessary to deliver enhanced emissions, engine performance, and durability for your vehicle. DaimlerChrysler Corporation recommends the use of gasolines that meet the WWFC specifications if they are available.

#### **Reformulated Gasoline**

Many areas of the country require the use of cleaner burning fuel, referred to as "Reformulated Gasoline".

Reformulated gasolines contain oxygenates and are specially blended to reduce vehicle emissions and improve air quality.

DaimlerChrysler Corporation supports the use of reformulated gasolines. Properly blended reformulated gasolines will provide excellent performance and durability of engine and fuel system components.

#### **Gasoline/Oxygenate Blends**

Some fuel suppliers blend unleaded gasoline with materials called oxygenates such as 10% ethanol, MTBE and ETBE. Oxygenates are required in some areas of the

country during the winter months to reduce carbon monoxide emissions. Fuels blended with these oxygenates may be used in your vehicle.

#### **CAUTION!**

**DO NOT use gasolines containing Methanol. Use of these blends may result in starting and drivability problems and may damage critical fuel system components.**

Problems that result from using methanol/gasoline blends are not the responsibility of DaimlerChrysler Corporation and may not be covered by the Limited Warranty. While MTBE is an oxygenate made from Methanol, it does not have the negative effects of Methanol.

#### **MMT in Gasoline**

MMT is a manganese containing metallic additive that is blended into some gasolines to increase the octane number. Gasolines blended with MMT offer no performance advantage beyond gasolines of the same octane number

without MMT. Gasolines blended with MMT have shown to reduce spark plug life and reduce emission system performance in some vehicles. DaimlerChrysler Corporation recommends using gasolines without MMT. Since the MMT content of gasoline may not be indicated on the pump, you should ask your gasoline retailer whether or not his/her gasoline contains MMT.

MMT is prohibited in both Federal and California reformulated gasolines.

In Canada, MMT can be used at levels higher than those allowed in the United States. For this reason, it is even more important to look for gasolines without MMT in Canada.

#### **Materials Added to Fuel**

All gasoline sold in the United States is required to contain effective detergent additives. Use of additional detergents or other additives is not needed under normal conditions and would result in unnecessary cost. Therefore, you should not have to add anything to the fuel.

#### **Sulfur in Gasoline**

If you live in the Northeast United States, your vehicle may have been designed to meet California low emission standards with cleaner burning California reformulated gasoline with low sulfur. If such fuels are not available in states adopting California emission standards, your vehicle will operate satisfactorily on fuels meeting Federal specifications, but emission control system performance may be adversely affected.

Gasoline sold outside of California is permitted to have higher sulfur levels, which may affect the performance of the vehicle's catalytic converter. This may cause the CHECK ENGINE light to illuminate. DaimlerChrysler Corporation recommends that you try a different brand of unleaded gasoline having lower sulfur to determine if the problem is fuel-related prior to returning your vehicle to an authorized dealer for service.

**CAUTION!**

If the CHECK ENGINE Light is flashing, immediate service is required. See the Onboard Diagnostic System (OBDII) paragraph in the Maintaining Your Vehicle section of this manual.

**CAUTION!**

Damage to the fuel system or emission control system could result from using an improper gas cap. A poorly fitting cap could let impurities into the fuel system. The CHECK ENGINE light will come on if the gas cap is not properly secured.

**ADDING FUEL****Fuel Filler Cap (Gas Cap)**

The gas cap is located under the fuel filler door, on the passenger's side of the vehicle. To open the door, be sure it is unlocked, then gently press the rear edge of the door until a click can be heard, then release. The door rear edge will spring open enough to grasp and pull it completely open. If the central locking system does not release the fuel filler door, see your authorized dealer for service. If the gas cap is lost or damaged, be sure the replacement cap has been designed for use with this vehicle.

**NOTE:** The fuel tank filler tube has a restricting door about 2 inches (50 mm) down from the opening. If fuel is poured from a portable container, the container should have a flexible nozzle long enough to force open the restricting door.

**CAUTION!**

To avoid fuel spillage and overfilling, do not "top off" the fuel tank after filling.

With the key in the ignition switch turned to the ON/RUN position, the fuel reserve warning light comes on. It should go out immediately when the engine is running.



If the warning light does not go out after starting the engine, or if it comes on while driving, it indicates that the fuel level is down to the reserve quantity of approximately 2.1 gallons (8 liters).

Leaving the engine running and the fuel cap open can cause the CHECK ENGINE light to illuminate.

**NOTE:**

- When the fuel nozzle “clicks” or shuts off, the fuel tank is full.
- Tighten the gas cap until you hear a single click. This is an indication that the gas cap is properly tightened. The CHECK ENGINE light will come on if the gas cap is not properly secured. Make sure that the gas cap is tightened each time the vehicle is refueled.

**WARNING!**

- **Never have any smoking materials lit in or near the vehicle when the gas cap is removed or the tank is filled.**
- **Never add fuel to the vehicle when the engine is running.**
- **A fire may result if gasoline is pumped into a portable container that is inside of a vehicle. You could be burned. Always place gas containers on the ground outside the vehicle while filling.**

**VEHICLE LOADING**

The load carrying capacity of your vehicle is in the following chart and on the tire pressure label attached to the driver door pillar.

## Vehicle Loading Capacities

Front Seat Occupants . . . . .	2
Cargo Capacity (with two persons) . . . .	115 lbs. (52 kg)
Rated Vehicle Capacity. . . . .	415 lbs. (188 kg)

**Roof Luggage Rack**

External racks do not increase the total load carrying capacity of the vehicle. Be sure that the total occupant and luggage load inside the vehicle, plus the load on the roof luggage rack, do not exceed the rated vehicle capacity. The maximum recommended roof load for your vehicle is 110 lbs. (50 kg).

**CAUTION!**

- To prevent damage to the roof of your vehicle, **DO NOT** carry any loads on the roof luggage rack which may come in contact with the roof panel. The load should be secured and placed on top of the rack, not directly on the roof. If it is necessary to place some part of the load on the roof, place a blanket or some other protection between the load and the roof surface.
- To avoid damage to the roof luggage rack and vehicle, do not exceed the rated load capacity of your roof luggage rack system maximum load capacity. Always distribute heavy loads as evenly as possible and secure the load appropriately.
- Long loads which extend over the windshield, such as wood panels or surfboards, should be carefully secured to both the front and rear of the vehicle.
- Travel at reduced speeds and turn corners carefully when carrying large or heavy loads on the roof luggage rack. Wind forces, due to natural causes or nearby truck traffic, can add sudden upward loads. This is especially true on large flat loads and may result in damage to the cargo or your vehicle.

**WARNING!**

Cargo must be securely tied before driving your vehicle. Improperly secured loads can fly off the vehicle, particularly at high speeds, resulting in personal injury or property damage. Follow the roof luggage rack "Cautions" when carrying cargo on your roof rack.

**TRAILER TOWING**

Trailer towing with your Crossfire is not recommended.



---

## WHAT TO DO IN EMERGENCIES

### CONTENTS

---

■ Hazard Warning Flasher . . . . .	158	■ Driving On Slippery Surfaces . . . . .	169
■ If Your Engine Overheats . . . . .	158	□ Traction . . . . .	169
■ TIREFIT Tire Repair And Jacking . . . . .	160	■ Freeing A Stuck Vehicle . . . . .	170
□ TIREFIT . . . . .	160	■ Towing A Disabled Vehicle . . . . .	170
□ Preparations For Jacking . . . . .	163	□ Towing Eyes . . . . .	171
□ Jack Location And Instructions . . . . .	164	□ Tow-Away Alarm . . . . .	174
■ Jump-Starting The Battery . . . . .	167		

**HAZARD WARNING FLASHER**

The flasher switch is located in the console. Push in the flasher switch and all front and rear directional signals will flash. Press the flasher switch a second time to turn the flashers off.

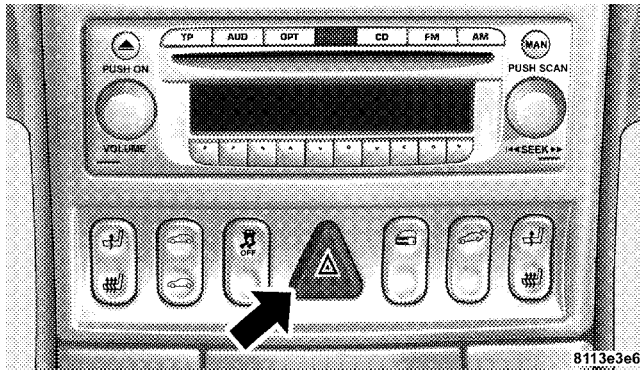

Do not use this emergency warning system when the vehicle is in motion. Use it when your vehicle is disabled and is creating a safety hazard for other motorists.

If it is necessary to leave the vehicle to go for service, the flasher system will continue to operate with the ignition key removed and the vehicle locked.

**NOTE:** With extended use, the flasher may run down your battery.

**IF YOUR ENGINE OVERHEATS**

During severe operating conditions and stop-and-go city traffic, the coolant temperature may rise close to the red area on the gauge.

The engine should not be operated with the coolant temperature in the red area. Doing so may cause serious damage which is not covered by the DaimlerChrysler Limited Warranty.

In any of the following situations, you can reduce the potential for overheating by taking the appropriate action.

- **On the highways** – Slow down and use the highest gear possible.
- **In city traffic** – While stopped, put the transmission in Neutral, but do not increase engine idle speed.
- **In city traffic** – While moving, shift into the highest gear possible to reduce engine RPM.

**NOTE:** There are steps that you can take to slow down an impending overheat condition. If your air conditioner is on, turn it off. The air conditioning system adds heat to the cooling system and turning off the A/C removes this heat. You can also turn the temperature control to maximum heat, the mode control to floor, and the fan control to high. This allows the heater core to act as a supplement to the radiator and aids in removing heat from the cooling system.

**CAUTION!**

Driving with a hot cooling system could damage your vehicle. If temperature gauge reads "H," pull over and stop the vehicle. Idle the vehicle with the air conditioner turned off until the pointer drops back into the normal range. If the pointer remains on the "H," turn the engine off immediately, and call for service.

**WARNING!**

A hot cooling system is dangerous. You or others could be badly burned by steam or boiling coolant. If your temperature gauge pointer is in the red area, turn off the engine immediately. You may want to call an authorized dealer for service. If you decide to look under the hood yourself, see Section 7 of this manual. Follow the warnings under the Cooling System Pressure Cap paragraph.

**TIREFIT TIRE REPAIR AND JACKING****TIREFIT**

Small punctures, particularly those in the tread, can be sealed with TIREFIT. Foreign objects (e.g., screws or nails) should not be removed from the tire. TIREFIT can be used in outside temperatures down to approximately -4°F (-20°C).

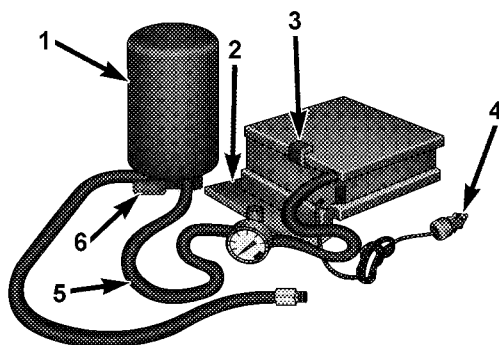

1. TIREFIT sealant bottle
2. Air pump flap
3. Recess in air pump
4. Power plug and cable
5. Air pump hose with pressure gauge
6. Hose connection on sealant bottle

810b5640



**WARNING!**

Cuts or punctures larger than approximately 0.16 in. (4 mm), tire damage caused by driving with extremely low tire pressure or on a flat tire, or a damaged wheel can pose a hazard while driving. TIREFIT should not be used in such circumstances. Do not drive the vehicle under such circumstances. Contact your nearest authorized dealer for assistance.

Take care not to allow the contents of TIREFIT to come in contact with hair, eyes or clothing. TIREFIT is harmful if inhaled, swallowed or absorbed through the skin: It causes skin, eye and respiratory irritation. Any contact with eyes or skin should be flushed immediately with plenty of water. If clothing comes in contact with TIREFIT, change clothing as soon as possible.

In case of allergic reaction or rash, consult a physician immediately. Keep TIREFIT out of reach of children. If swallowed, rinse mouth immediately with plenty of water and drink plenty of water. Do not induce vomiting! Consult a physician immediately.

Keep away from open flame or heat source.

**Sealing tire with TIREFIT**

1. Set the parking brake and turn on the hazard warning flashers.
2. Move the transmission selector lever to the PARK position (manual transmission to FIRST or REVERSE gear) and turn off the engine.
3. Remove the TIREFIT kit and electric air pump from the area below the cargo compartment carpet.
4. Open flap (2) on the electric air pump.
5. Pull the power plug (4) and air hose (5) along with the pressure gauge out of the air pump housing.
6. Screw the air hose (5) onto the hose connection on the TIREFIT sealant bottle (1).
7. Holding the sealant bottle by the top, insert it downwards into the recess (3) on the air pump.
8. Unscrew the valve cap from the valve on the deflated tire.
9. Screw the filler hose from the sealant bottle on the tire valve.

10. Insert the power plug (4) into the power point on the instrument panel.
  11. Turn the ignition key to the ON/RUN position.
  12. Press the switch on the air pump to 1. The air pump should start to inflate the tire.
  13. After five minutes, the tire should be inflated to at least 26 psi (1.8 bar) on the pressure gauge.
  14. If the tire doesn't inflate to this level, press the air pump switch to 0, disconnect the TIREFIT system from the tire, and drive the vehicle back and forth approximately 30 feet (9.1 m) to distribute the sealant more evenly within the tire.
  15. Attach the air pump hose directly to the tire, press the switch to 1, and inflate the tire again. **NOTE:** If a tire pressure of 26 psi (1.8 bar) is not reached after five minutes, the tire is too badly damaged. Do not attempt to drive the vehicle further, and call for assistance.
  16. If a tire pressure of 26 psi (1.8 bar) is obtained, press the air pump switch to 0, turn the ignition switch to the OFF/LOCK position, and disconnect the TIREFIT system.
  17. Drive the vehicle for about 10 minutes to ensure optimum distribution of the tire sealant within the tire.
  18. Check the pressure in the tire. If the pressure is above 19 psi (1.3 bar), inflate the tire to the pressure indicated on the tire pressure label on the driver side latch pillar.
  19. Have the tire inspected at the earliest opportunity at an authorized dealer or tire service center.
- NOTE:** Do not exceed 50 mph (80 km/h) until the tire has been inspected.
- NOTE:** If a pressure of at least 19 psi (1.3 bar) cannot be maintained in the tire, the tire is too badly damaged. Do not attempt to drive the vehicle further, and call for assistance.
- NOTE:** Do not operate the electric air pump for more than eight minutes to avoid overheating. The air pump may be used again once it has cooled down.
- NOTE:** Replace the TIREFIT sealant bottle once every four years to assure optimum operation of the system.
- NOTE:** If TIREFIT is liquid, clean water and a damp cloth will remove the material from the vehicle or tire and

wheel components. Once TIREFIT sealing material has dried, it can easily be peeled off and properly discarded.

### Preparations for Jacking

#### WARNING!

Getting under a jacked-up vehicle is dangerous. The vehicle could slip off the jack and fall on you. You could be crushed. Never get any part of your body under a vehicle that is on a jack. Never start or run the engine while the vehicle is on a jack. If you need to get under a raised vehicle, take it to a service facility where it can be raised on a lift.

#### WARNING!

Do not attempt to repair a tire on the side of the vehicle close to traffic. Pull far enough off the road to avoid the danger of being hit when operating the jack or repairing a tire.

Jacking the vehicle should only be necessary in the event that a tire has been severely damaged, and must be replaced. (See TIREFIT Tire Repair section for a description of cuts and punctures that may be repairable with TIREFIT.)

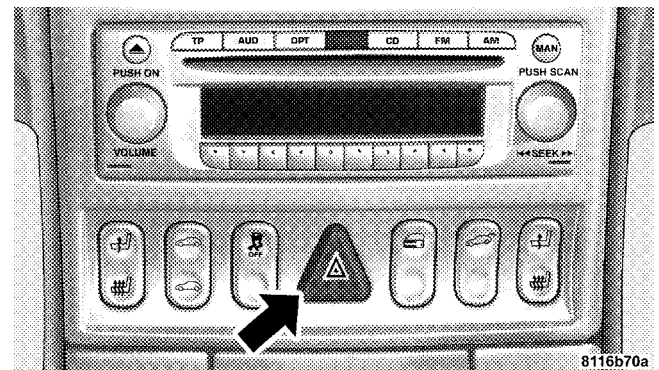

- Turn on the hazard warning flashers and park the vehicle on a firm, level surface; avoid ice or slippery areas.
- Firmly set the parking brake and shift the transmission selector lever into PARK (manual transmission to FIRST or REVERSE gear).

- Turn off the engine.
- Block the wheel diagonally opposite the flat tire.

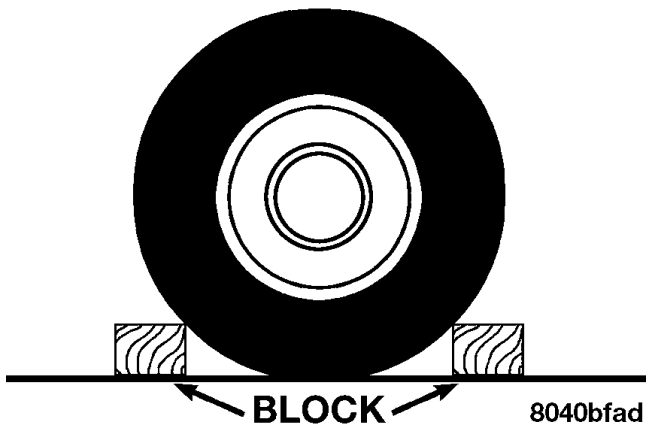

- Passengers must not remain in the vehicle when the vehicle is jacked.

**NOTE:** The jack is designed exclusively for jacking up the vehicle at the specified jack location points built beneath either side of the vehicle.

#### Jack Location and Instructions

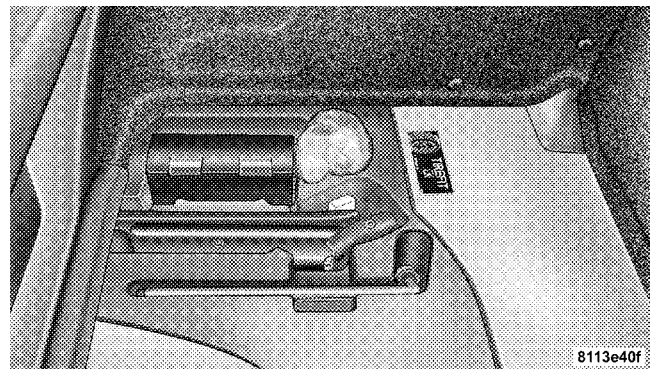

1. Remove the jack and jack handle from stowage in the rear liftgate area.

2. The lifting points for the jack are located beneath the outer edge of the body side, directly behind the front wheel housings, and in front of the rear wheel housings.

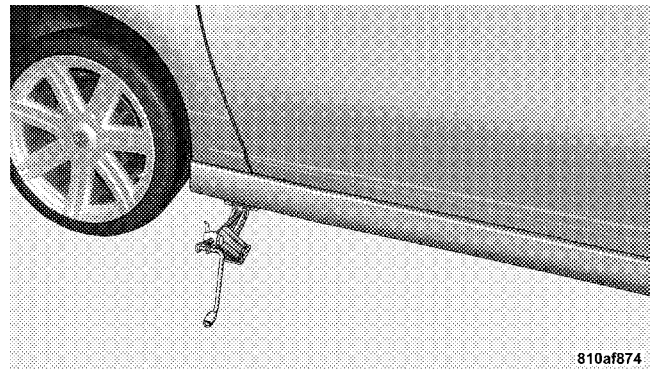
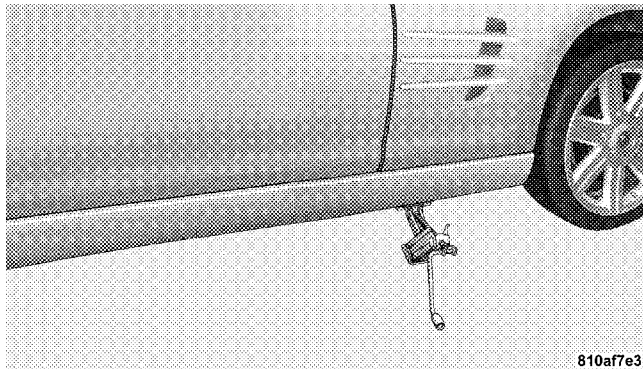

**NOTE:** Do not raise the vehicle until you are sure the jack is securely engaged, as shown.

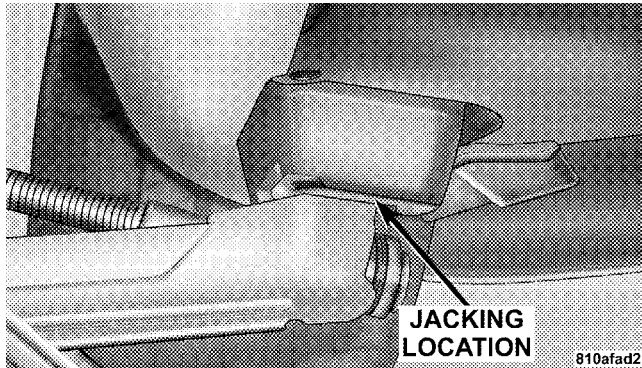

3. Holding the jack, insert the cradle under the lifting points. Crank the handle clockwise until the jack base meets the ground. Place the jack on firm ground. Position the jack so that it is always level, even if the vehicle is parked on an incline. Raise the vehicle only until the tire just clears the surface. Minimum tire lift provides maximum stability.

4. Replace the tire.

5. Lower the vehicle by cranking the handle counter-clockwise, then remove the jack assembly.

**NOTE:** Before storing the jack, it should be fully collapsed.

6. Ensure proper tire pressure.

#### WARNING!

Raising the vehicle higher than necessary can make the vehicle less stable. It could slip off the jack and hurt someone near it. Raise the vehicle only enough to make the necessary repair.

#### WARNING!

A loose jack or tool thrown forward in a collision or hard stop could endanger the occupants of the vehicle. Always stow the jack parts and tools in the places provided.

**JUMP-STARTING THE BATTERY****WARNING!**

Take care to avoid the radiator cooling fan whenever the hood is raised. It can start any time the ignition switch is on. You can be hurt by the fan.

**CAUTION!**

Do not try to push or tow your vehicle to get it started. Your vehicle cannot be started this way. Pushing with another vehicle may damage the transmission or the rear of your vehicle. If your vehicle has a discharged (dead) battery, booster cables may be used to obtain a start from another vehicle. This type of start can be dangerous if done improperly, so follow the procedure carefully.

**WARNING!**

Battery fluid is a corrosive acid solution; do not allow battery fluid to contact eyes, skin or clothing. Don't lean over battery when attaching clamps or allow the clamps to touch each other. If acid splashes in eyes or on skin, flush contaminated area immediately with large quantities of water.

A battery generates hydrogen gas that is flammable and explosive. Keep flame or spark away from the vent holes. Do not use a booster battery or any other booster source with an output that exceeds 12 volts.

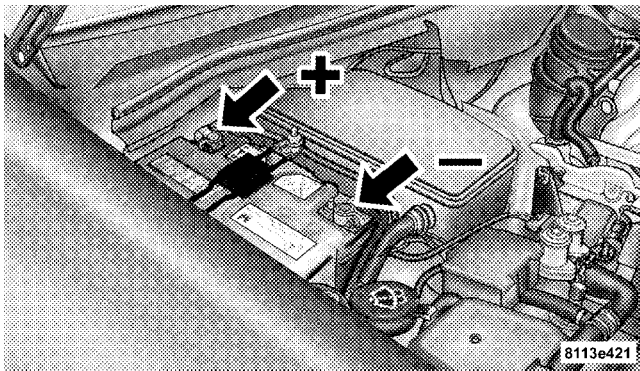

1. Wear eye protection and remove any metal jewelry such as watch bands or bracelets that might make an inadvertent electrical contact.

2. When boost is provided by a battery in another vehicle, park that vehicle within booster cable reach but without letting the vehicles touch. Set the parking brake, place the transmission in Neutral and turn the ignition OFF for both vehicles.

3. Turn off the heater, radio and all unnecessary electrical loads.

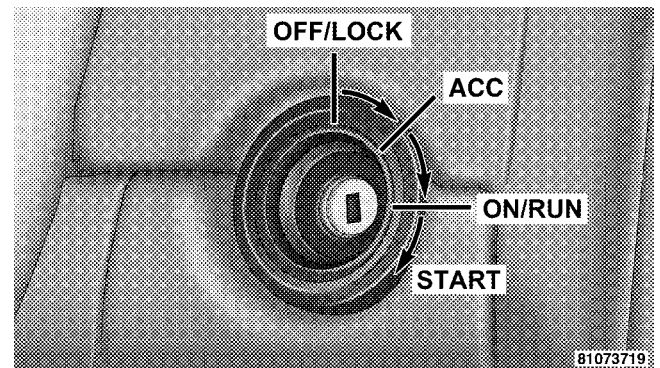

4. Connect one end of a jumper cable to the positive jump-start attachment of the booster battery. Connect the other end of the same cable to the positive jump-start attachment of the discharged battery.

5. Connect the other cable, first to the negative jump-start attachment of the booster battery and then to the engine of the vehicle with the discharged battery. Make sure you have good contact on the engine.



6. Start the engine in the vehicle which has the booster battery, let the engine idle a few minutes, then start the engine in the vehicle with the discharged battery.

7. When removing the jumper cables, reverse the above sequence exactly. Be careful of the moving belts and fans.

**NOTE:** If engine does not run after several unsuccessful starting attempts, have it checked at the nearest authorized dealer.

#### DRIVING ON SLIPPERY SURFACES

##### WARNING!

**Rapid acceleration on slippery surfaces is dangerous. You could lose control of the vehicle and possibly have an accident. Accelerate slowly and carefully whenever there is likely to be poor traction (ice, snow, rain, mud, loose sand, etc.).**

#### Traction

When driving on wet or slushy roads, it is possible for a wedge of water to build up between the tire and road surface. This is hydroplaning and may cause partial or complete loss of vehicle control and stopping ability. To reduce this possibility, the following precautions should be observed:

1. Slow down during rainstorms or when roads are slushy.
2. Slow down if the road has standing water or puddles.
3. Replace tires when tread wear indicators first become visible.
4. Keep tires properly inflated.
5. Maintain enough distance between your vehicle and the vehicle in front to avoid a collision in a sudden stop.

**FREEDING A STUCK VEHICLE**

In order to free a stuck vehicle you must turn off the Electronic Stability Program (ESP) before attempting to “rock” the vehicle.

If your vehicle becomes stuck in mud, sand or snow, it can often be moved by a rocking motion. Turn your steering wheel right and left to clear the area around the front wheels. Then shift back and forth between Reverse and Drive. Usually the least accelerator pedal pressure to maintain the rocking motion without spinning the wheels is most effective.

**NOTE:** ESP should be turned on again after freeing the vehicle from a stuck condition.

**CAUTION!**

**Racing the engine or spinning the wheels too fast may lead to transmission/axle overheating and failure. It can also damage the tires. Do not spin the wheels above 30 mph (48 km/h).**

**TOWING A DISABLED VEHICLE**

We recommend that the vehicle be transported using flat bed equipment. This method is preferable to other types of towing.

**CAUTION!**

**Important! If towing the vehicle, please note the following: With the automatic central locking activated and the key in the ignition switch turned to the ON/RUN position, the vehicle doors lock if the left front wheel and the right rear wheel are turning at vehicle speeds of approximately 9 mph (15 km/h) or more. To prevent the vehicle door locks from locking, deactivate the automatic central locking.**

**CAUTION!**

If the vehicle is towed with the front wheels raised, the engine must be shut off (key in the ignition switch turned to the OFF/LOCK or ACC positions). Otherwise, the ESP will immediately be engaged and will apply the rear wheel brakes. Switch off the tow-away alarm as well as the automatic central locking system.

Towing restrictions for vehicles with automatic transmission: The vehicle may be towed with all wheels on the ground and the transmission selector lever in the Neutral position for distances up to 30 miles (48 km) and at a speed not to exceed 30 mph (48 km/h). The key must be turned to the ON/RUN position in the ignition. To be certain to avoid a possibility of damage to the transmission, however, we recommend the drive shaft be disconnected at the rear axle drive flange for any towing beyond a short tow to a nearby garage.

Always comply with applicable state or local towing ordinances.

**CAUTION!**

- Do not attempt to tow this vehicle from the front with sling-type towing equipment. Damage to the front fascia will result.
- Always use wheel lift equipment when towing from the front. The only other approved method of towing is with a flatbed truck.
- Do not tow the vehicle from the rear. Damage to the rear sheet metal and fascia will occur.
- Do not push or tow this vehicle with another vehicle as damage to the bumper fascia and transmission may result.

**Towing Eyes**

The vehicle is equipped with front and rear towing eyes to allow towing with the wheels on the ground or to allow the vehicle to be easily drawn up on a flatbed tow truck. The rear towing eye is located on the right side of the vehicle below the rear fascia. The front hook is

172 WHAT TO DO IN EMERGENCIES

located behind the lower grille in the fascia. For access, a snap-in grille must be removed using the multifunction tool from the glovebox.

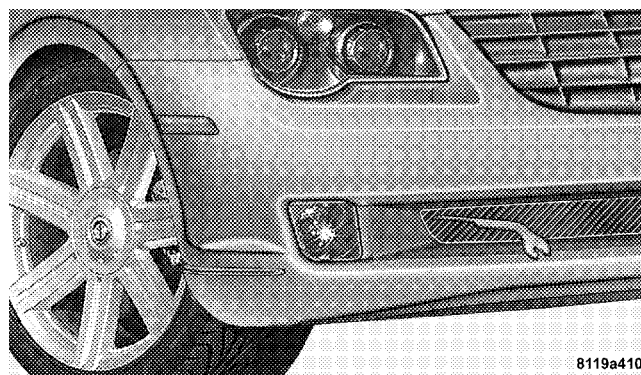
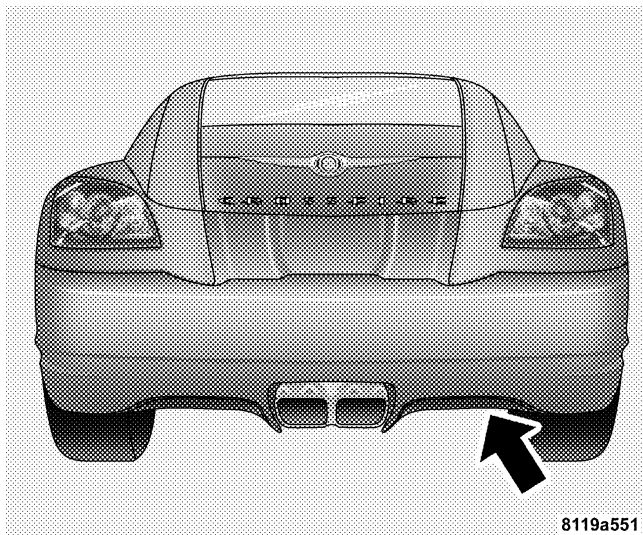

Insert the tool (or similar sized screwdriver) into the slot in the grille as shown, and rotate it to the left to detach. The front towing eye is now accessible.

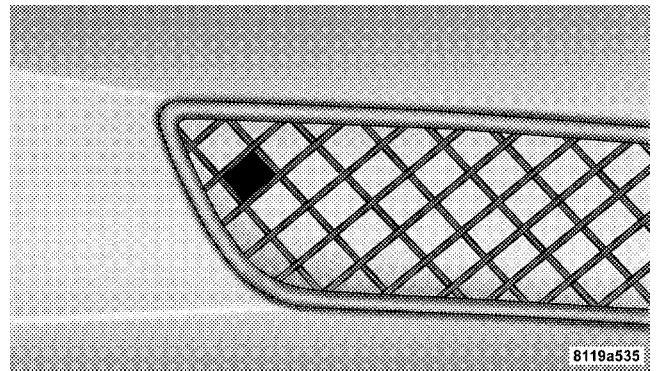
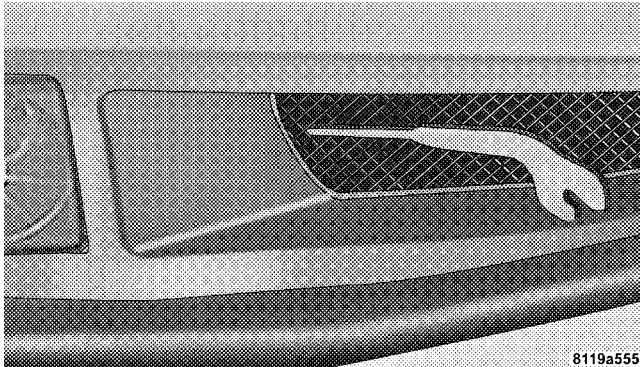

### Tow-Away Alarm

Once the alarm system has been armed, the exterior vehicle lights will flash and an alarm will sound when anyone attempts to raise the vehicle for towing. The alarm will last approximately three minutes in the form of flashing exterior lights. At the same time, an alarm will sound for 30 seconds. The alarm will stay on even if the vehicle is immediately lowered. To cancel the alarm, insert the key in the ignition switch or press the transmit button on the key fob.

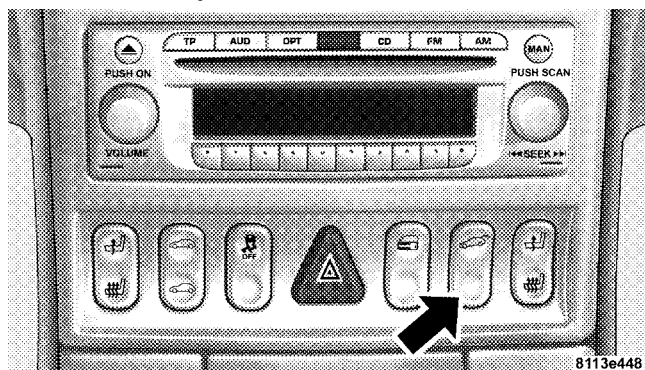

To prevent triggering the tow-away alarm feature, press the tow-away alarm switch to turn off the tow-away alarm before towing the vehicle, or when parking on a surface subject to movement, such as a ferry or auto train. To do so, turn the key in the ignition switch to the OFF/LOCK or ACC positions, or remove key from the ignition switch. Press the upper half of the tow-away alarm switch. The indicator light will illuminate briefly. Then, exit the vehicle and lock with a key or the remote control. The tow-away alarm remains switched off until the vehicle is locked again with a key or the remote control, at which time it is automatically reactivated.

---

## MAINTAINING YOUR VEHICLE

### CONTENTS

---

■ 3.2L Engine . . . . .	177	□ Power Steering Fluid . . . . .	189
■ Onboard Diagnostic System (OBD II) . . . . .	178	□ Chassis Lubrication . . . . .	190
■ Emissions Inspection And Maintenance Programs . . . . .	179	□ Body Lubrication . . . . .	190
■ Replacement Parts . . . . .	180	□ Windshield Wiper Blades . . . . .	191
■ Dealer Service . . . . .	180	□ Windshield Wiper Blade Replacement . . . . .	191
■ Maintenance Procedures . . . . .	181	□ Windshield Washer Reservoir . . . . .	192
□ Engine Oil . . . . .	181	□ Exhaust System . . . . .	192
□ Ignition Wiring System . . . . .	187	□ Cooling System . . . . .	193
□ Crankcase Emission Control System . . . . .	187	□ Hoses And Vacuum/Vapor Harnesses . . . . .	197
□ Maintenance-Free Battery . . . . .	187	□ Brakes . . . . .	197
□ Air Conditioner . . . . .	188	□ Automatic Transmission . . . . .	199

176 MAINTAINING YOUR VEHICLE

□ Manual Transmission . . . . .	200	□ Front And Rear Sidemarker Lights . . . . .	214
□ Appearance Care And Protection From Corrosion . . . . .	201	□ Tail, Stop, Back Up And Turn Signal Lights . . .	214
■ Fuses . . . . .	206	□ License Plate Light . . . . .	215
□ Engine Compartment Fuses . . . . .	206	□ Headlight Aiming . . . . .	215
□ Relay Control Module Fuses . . . . .	210	■ Vehicle Storage . . . . .	216
□ Interior Fuses . . . . .	211	■ Specifications . . . . .	218
■ Replacement Bulbs . . . . .	212	■ Fluid Capacities . . . . .	220
□ Interior Light Bulbs . . . . .	212	■ Recommended Fluids, Lubricants And Genuine Parts . . . . .	221
□ Exterior Light Bulbs . . . . .	212	□ Engine . . . . .	221
■ Exterior Light Bulb Service . . . . .	213	□ Chassis . . . . .	222
□ Headlights . . . . .	213	□ Body . . . . .	223
□ Front Turn Signal And Parking/Standing Lights . . . . .	214		



### 3.2L ENGINE

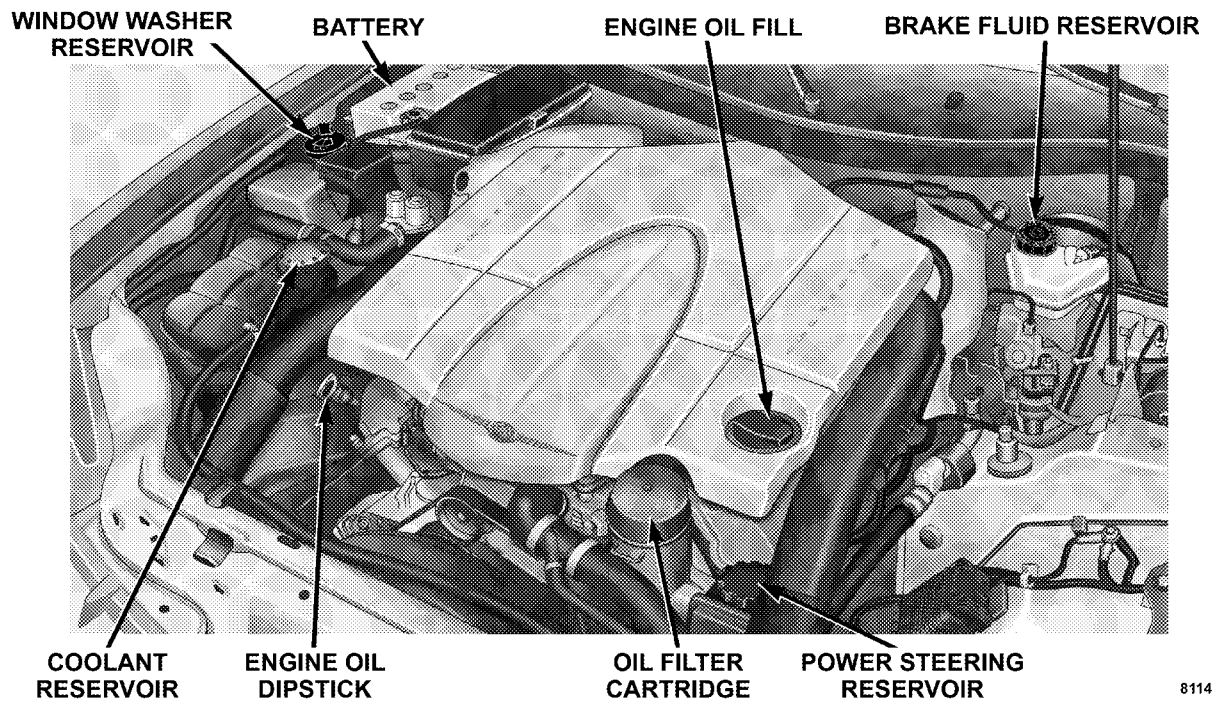

81142f34

**ONBOARD DIAGNOSTIC SYSTEM (OBD II)**

To meet new government regulations and promote cleaner air, your Crossfire is equipped with a sophisticated onboard diagnostic system called OBD II. This system monitors the performance of the emissions and engine control systems. When these systems are operating properly, your vehicle will provide excellent performance and fuel economy, as well as engine emissions well within current government regulations.

If any of these systems require service, the OBD II system will turn on the CHECK ENGINE Light. It will also store diagnostic codes and other information to assist your service technician in making repairs. Although your vehicle will usually be drivable and not need towing, see your authorized dealer for service as soon as possible.

**CAUTION!**

**Prolonged driving with the CHECK ENGINE light on could cause further damage to the emission control system. It could also affect fuel economy and drivability. The vehicle must be serviced before any state emissions tests can be performed.**

If the CHECK ENGINE light is flashing, severe catalytic converter damage and power loss will soon occur. Immediate service is required.

If the gas cap is not tightened properly, the CHECK ENGINE light may come on. Be sure the gas cap is tightened every time you add fuel. Tighten the cap until you hear it "click" once.

## EMISSIONS INSPECTION AND MAINTENANCE PROGRAMS

In some localities, it may be a legal requirement to pass an inspection of your vehicle's emissions control system. Failure to pass could prevent vehicle registration.

**CHECK ENGINE** For states which have an I/M (Inspection and Maintenance) requirement, this check verifies the following: the CHECK ENGINE Light is functioning and is not on when the engine is running, and that the OBD (Onboard Diagnostic) system is ready for testing.

Normally, the OBD system will be ready. The OBD system may **not** be ready if your vehicle was recently serviced, if you recently had a dead battery, or a battery replacement. If the OBD system should be determined not ready for the I/M test, your vehicle may fail the test.

Your vehicle has a simple ignition key actuated test which you can use prior to going to the test station. To check if your vehicle's OBD system is ready, you must do the following:

1. Insert your ignition key into the ignition switch.
2. Turn the ignition to the ON/RUN position, but do not crank or start the engine.
3. If you crank or start the engine, you will have to start this test over.
4. As soon as you turn your key to the ON/RUN position, you will see your CHECK ENGINE light come on as part of a normal bulb check.
5. Approximately 15 seconds later, one of two things will happen:
  - a. The CHECK ENGINE light will flash for about 10 seconds and then return to being fully illuminated until you turn off the ignition key or start the engine. This means that your vehicle's OBD system is **not ready** and you should **not** proceed to the I/M station.
  - b. The CHECK ENGINE light will not flash at all and will remain fully illuminated until you turn off the ignition key or start the engine. This means that your vehicle's OBD system is **ready** and you can proceed to the I/M station.

If your OBD system is **not ready**, you should see your authorized dealer or repair facility. If your vehicle was recently serviced or had a battery failure or replacement, you may need to do nothing more than drive your vehicle as you normally would in order for your OBD system to update. A recheck with the above test routine may then indicate that the system is now ready.

Regardless of whether your vehicle's OBD system is ready or not ready, if the CHECK ENGINE light is illuminated during normal vehicle operation, you should have your vehicle serviced before going to the I/M station. The I/M station can fail your vehicle because the CHECK ENGINE light is on with the engine running.

#### **REPLACEMENT PARTS**

Use of genuine Mopar® parts for normal/scheduled maintenance and repairs is highly recommended to insure the designed performance. Damage or failures caused by the use of non-Mopar® parts for maintenance and repairs will not be covered by the warranty offered by DaimlerChrysler Corporation.

#### **DEALER SERVICE**

Your dealer has the qualified service personnel, special tools and equipment to perform all service operations in an expert manner. Service Manuals are available which include detailed service information for your Crossfire. Refer to these manuals before attempting any procedure yourself.

**NOTE:** Intentional tampering with emissions control systems can result in civil penalties being assessed against you.

**WARNING!**

**You can be badly injured working on or around a motor vehicle. Do only that service work for which you have the knowledge and the proper equipment. If you have any doubt about your ability to perform a service job, take your vehicle to a competent technician.**

**MAINTENANCE PROCEDURES**

The pages that follow contain the maintenance service recommended by the engineers who designed your vehicle.

Besides the maintenance items for which there are fixed maintenance intervals, there are other items that should operate satisfactorily without periodic maintenance. However, if a malfunction of these items does occur, it could adversely affect the engine or vehicle performance. These items should be inspected if a malfunction is observed or suspected.

**Engine Oil****Checking Oil Level**

To assure proper engine lubrication, the engine oil must be maintained at the correct level. Check the oil level at regular intervals, such as every fuel stop.

You can check the oil level using the procedure described in Checking Engine Oil Level in the Understanding Your Instrument Panel section, or by checking the engine oil dipstick.

The best time to check the engine oil level is about 5 minutes after a fully warmed engine is shut off, or before starting the engine after it has sat overnight.

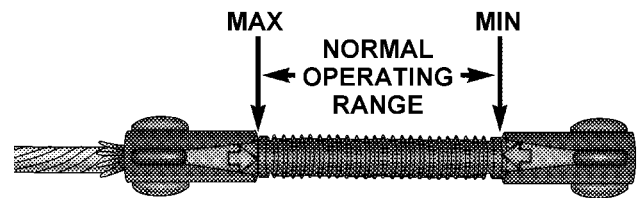
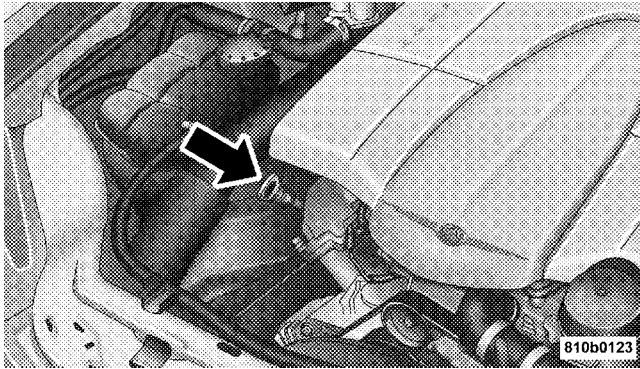

81073c4c

Checking the oil while the vehicle is on level ground will improve the accuracy of the oil level readings. Maintain the oil level between the MIN and MAX markings on the dipstick. Adding one quart of oil when the reading is at the MIN mark will result in a MAX reading on this engine.

### Change Engine Oil

The oil change interval for your Crossfire is initially set at 7,000 miles (11,000 km).

The Flexible Service System (FSS) in your vehicle evaluates engine temperature, oil level, vehicle speed, engine speed, distance driven, and the time elapsed since your last service. It determines when your vehicle needs maintenance service and alerts you in advance. The next necessary service is indicated by the FSS in your instrument cluster.

**NOTE:** Also see the FSS system details in the Understanding Your Instrument Panel section of this manual.

Very light duty driving cycles (most trips more than 10 miles [16 km] at moderate speeds in moderate temperature conditions) can extend the service interval beyond 7,000 miles (11,000 km).

If **ANY** of the following apply to your driving, the oil change interval can be reduced significantly:

- Day and night temperatures are below 32°F (0°C)
- Stop-and-go driving

- Extensive engine idling
- Driving in dusty conditions
- Short trips of less than 10 miles (16 km)
- More than 50% of your driving is at sustained high speeds during hot weather, above 90°F (32°C)
- Taxi, Police, or delivery service (commercial service)

Observe the oil change interval indicated by your FSS system. This system will monitor the driving conditions seen by your vehicle, and will recommend the best interval for servicing your vehicle to maintain it in top condition.

#### CAUTION!

**Overfilling or underfilling the crankcase will cause oil aeration or loss of oil pressure. This could damage your engine.**

### Engine Oil Selection

Only use synthetic engine oils, approved to MB 229.3 or MB 229.5, such as Mobil 1 SAE 0W-40. The FFS may not alert for an oil change at the proper interval if an unapproved engine oil is used; engine damage and reduced engine life may result.

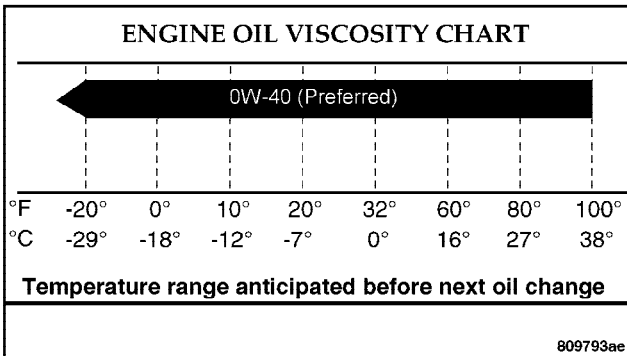

### Materials Added To Engine Oils

Do not add materials (other than leak detection dyes) to engine oil. Engine oil is an engineered product and its performance may be impaired by supplemental additives.

### Disposing of Used Engine Oil

Care should be taken in disposing of used engine oil from your vehicle. Used oil, indiscriminately discarded, can present a problem to the environment. Contact your dealer, service station, or governmental agency for advice on how and where used oil can be safely discarded in your area.

### Engine Oil Filter

The engine oil filter should be replaced at every engine oil change.

### Engine Oil Filter Selection

All DaimlerChrysler Corporation engines have a full-flow type disposable oil filter. Use a filter of this type for replacement. The quality of replacement filters varies considerably. Only high quality filters should be used to assure most efficient service. Mopar® Engine Oil Filters are high quality oil filters and are recommended.

### Drive Belts - Check Condition and Tension

At the distance shown in the maintenance schedules, check all drive belts for condition and proper tension. Improper belt tension can cause belt slippage and failure.



Inspect the drive belts for evidence of cuts, cracks, or glazing and replace them if there is any sign of damage which could result in belt failure. If adjustment is required, adjust the belts according to the specifications and procedures shown in the Service Manual.

Special tools are required to properly measure tension and to restore belt tension to factory specifications. Also, check belt routing to make sure there is no interference between the belts and other engine components.

### Spark Plugs

Spark plugs must fire properly to assure engine performance and emission control. New plugs should be installed at the distance specified in the appropriate maintenance chart. The entire set should be replaced if there is any malfunction due to a faulty spark plug. Check the specifications section for the proper type of spark plug for use in your vehicle.

### Engine Air Cleaner Filter

Under normal driving conditions, replace the air filter at each interval called out by FSS.

### WARNING!

**The air cleaner can provide a measure of protection in the case of engine backfire. Do not remove the air cleaner unless such removal is necessary for repair or maintenance. Make sure that no one is near the engine compartment before starting the vehicle with the air cleaner removed. Failure to do so can result in serious personal injury.**

### Engine Fuel Filter

A plugged fuel filter can cause hard starting or limit the speed at which a vehicle can be driven. Should an excessive amount of dirt accumulate in the fuel tank, frequent filter replacement may be necessary. See your authorized dealer for service.

### Catalytic Converter

The catalytic converter requires the use of unleaded fuel only. Leaded gasoline will destroy the effectiveness of the catalyst as an emission control device.

Under normal operating conditions, the catalytic converter will not require maintenance. However, it is important to keep the engine properly serviced to assure proper catalyst operation and prevent possible catalyst damage.

If the CHECK ENGINE light is flashing, immediate service is required.

#### CAUTION!

**Damage to the catalytic converter can result if your vehicle is not kept in proper operating condition. In the event of engine malfunction, particularly involving engine misfire or other apparent loss of performance, have your vehicle serviced promptly. Continued operation of your vehicle with a severe malfunction could cause the converter to overheat, resulting in possible damage to the converter and the vehicle.**

#### WARNING!

**A hot exhaust system can start a fire if you park over materials that can burn. Such materials might be grass or leaves coming into contact with your exhaust system. Do not park or operate your vehicle in areas where your exhaust system can contact anything that can burn.**

In unusual situations involving grossly malfunctioning engine operation, a scorching odor may suggest severe and abnormal catalyst overheating. If this occurs, stop the vehicle, turn off the engine and allow it to cool. Service, including a tune up to DaimlerChrysler Corporation's specifications, should be obtained immediately.

To minimize the possibility of catalyst damage:

- Do not shut off the engine or interrupt the ignition when the transmission is in gear and the vehicle is in motion.
- Do not try to start the engine by pushing or towing the vehicle.

- Do not idle the engine with any spark plug wires disconnected for a prolonged period.

#### **Ignition Wiring System**

The ignition cables should be kept clean and properly connected. Terminals should be fully seated. Cracked, damaged, or faulty cables should be replaced.

#### **Crankcase Emission Control System**

Proper operation of this system depends on freedom from sticking or plugging due to deposits.

Check ventilation hose for indication of damage or plugging deposits. Replace if necessary.

#### **Maintenance-Free Battery**

The top of the maintenance-free battery is permanently sealed. You will never have to add water, nor is periodic maintenance required.

#### **WARNING!**

**Battery posts, terminals and related accessories contain lead and lead compounds. Wash hands after handling.**

**Battery fluid is a corrosive acid solution and can burn or even blind you. Don't allow battery fluid to contact your eyes, skin or clothing. Don't lean over a battery when attaching clamps. If acid splashes in eyes or on skin, flush the area immediately with large amounts of water.**

**Battery gas is flammable and explosive. Keep flame or sparks away from the battery. Don't use a booster battery or any other booster source with an output greater than 12 volts. Don't allow cable clamps to touch each other.**

**CAUTION!**

It is essential when replacing the cables on the battery that the positive cable is attached to the positive post and the negative cable is attached to the negative post. Battery posts are marked positive (+) and negative (-) and identified on the battery case. Cable clamps should be tight on the terminal posts and free of corrosion. Apply grease to posts and clamps after tightening.

If a "fast charger" is used while the battery is in the vehicle, disconnect both vehicle battery cables before connecting the charger to battery. Do not use a "fast charger" to provide starting voltage as battery damage can result.

**Air Conditioner**

Check the air conditioning system at the start of the warm weather season.

**NOTE:** If your air conditioning performance seems lower than expected, check the front of the A/C condenser for an accumulation of dirt or insects. Clean with

a gentle water spray from behind the radiator and through the condenser as required. Fabric front fascia protectors may reduce air flow to the condenser, reducing air conditioning performance.

**WARNING!**

The air conditioning system contains refrigerant under high pressure. To avoid risk of personal injury or damage to the system, adding refrigerant or any repair requiring lines to be disconnected should be done by an experienced repair person.

**Refrigerant Recovery And Recycling**

The air conditioning system of your vehicle contains R-134a, a refrigerant that does not deplete the ozone layer in the upper atmosphere. The DaimlerChrysler Corporation recommends that air conditioning service be done by facilities using refrigerant recycling and recovery equipment that meets SAE standard J1991.

### Power Steering Fluid

No power steering fluid service is required. The system is filled at the factory with Pentosin CHF 11S. Steering noise and reduced component life may result if an unapproved fluid is used.



8118c2cf

During scheduled maintenance, check the power steering fluid level at the power steering fluid reservoir. Normally, it will not be necessary to add power steering fluid.

Before removing the reservoir cap, wipe the outside of the cap and reservoir so that no dirt can fall into the reservoir.

The power steering pump has a dipstick. Fluid level should be maintained at the proper level indicated on the dipstick. If necessary, add fluid to restore to the proper indicated level. With a clean cloth, wipe any spilled fluid from all surfaces.

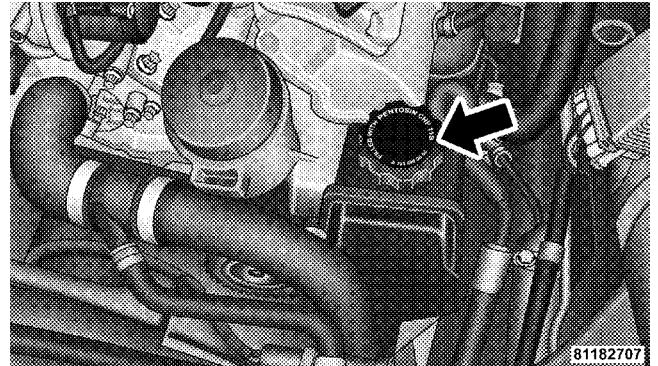

## Chassis Lubrication

### Front Suspension Ball Joints

There are two front suspension lower ball joints that are permanently lubricated. Inspect these ball joints whenever under-vehicle service is done.

### Steering Linkage

Inspect tie rod ends whenever the vehicle is serviced. They are permanently lubricated and do not require periodic lubrication.

### Drive Shaft Universal Joints

Your vehicle has four constant velocity universal joints. Periodic lubrication of these joints is not required. However, the joint boots should be inspected for external leakage or damage when other maintenance is performed.

If leakage or damage is evident, replace the universal joint boot and grease immediately.

Continued operation could result in failure of the universal joint due to water and dirt contamination of the grease. This would require complete replacement of the joint assembly.

## Body Lubrication

Locks and all body pivot points, including such items as seat tracks, doors, and rear liftgate hinges, should be lubricated periodically to assure quiet, easy operation and to protect against rust and wear.

### Hood Latch

When performing other under hood services, the hood latch release mechanism and safety catch should be inspected, cleaned, and lubricated.

It is important to maintain proper lubrication to insure that the hood mechanisms work properly and safely. Multi-Purpose Lubricant, NLGI Grade 2, should be applied sparingly to all pivot and sliding contact areas.

### Driver's Door Lock Cylinder

The driver's door lock cylinder should be lubricated twice a year, preferably in the fall and spring. Apply a small amount of a high quality lubricant, such as Mopar® Lock Cylinder Lubricant directly into the lock cylinder (avoid excess lubricant).

Insert the key into the lock cylinder and rotate from the unlocked to the locked position without adding more

lubricant. Repeat this procedure three or four times. Wipe all the lubricant off the key with a clean cloth, to avoid soiling clothing.

### Windshield Wiper Blades

Clean the rubber edges of the wiper blades and the windshield periodically with a sponge or soft cloth and a mild non-abrasive cleaner, or use the washer solvent. This will remove accumulations of salt or road film and help reduce streaking and smearing.

Operation of the wipers on dry glass for long periods may cause deterioration of the wiper blades. Always use washer fluid when using the wipers to remove salt or dirt from a dry windshield. Avoid using the wiper blades to remove frost or ice from the windshield. Make sure that they are not frozen to the glass before turning them on to avoid damaging the blade. Keep the blade rubber out of contact with petroleum products such as engine oil, gasoline, etc.

### Windshield Wiper Blade Replacement

1. Lift the wiper arm away from the glass.
2. Rotate the blade 45 degrees to gain access to the release tab.
3. Push the release tab as shown in the illustration and slide the wiper blade assembly down along the arm. Gently place the wiper arm on the windshield.

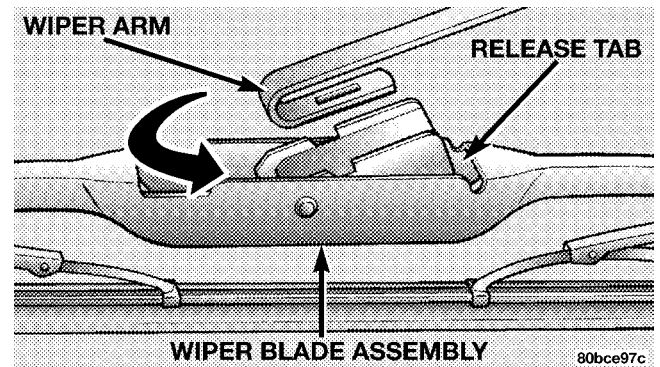

4. Install the new blade assembly onto the wiper arm tip until it locks in place.

### Windshield Washer Reservoir

The washer fluid reservoir is located in the engine compartment and should be checked for fluid level at regular intervals. Fill the reservoir with windshield washer solvent (not radiator antifreeze) rated not to freeze at  $-25^{\circ}\text{F}$  ( $-31^{\circ}\text{C}$ ). Operate the system for a few seconds to flush out the residual water.

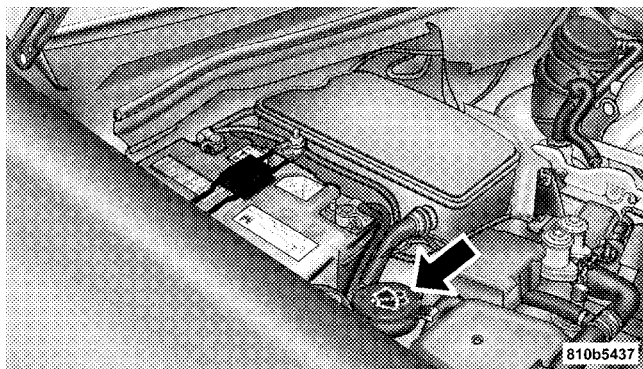

### WARNING!

**Do not overfill the washer reservoir. Do not attempt to fill to the top of the filler neck. Fluid may leak out onto the floor or driveway causing a potential slip and fall hazard. When the indicator light first illuminates, the maximum fill amount is 1 gallon or 4 liters.**

### WARNING!

**Commercially available windshield washer solvents are flammable. They could ignite and burn you. Care must be exercised when filling or working around the washer solution.**

### Exhaust System

The best protection against carbon monoxide entry into the vehicle body is a properly maintained engine exhaust system.



If you notice a change in the sound of the exhaust system, or if exhaust fumes can be detected inside the vehicle, or when the underside or rear of the vehicle is damaged, have a competent technician inspect the complete exhaust system and adjacent body areas for broken, damaged, deteriorated, or mispositioned parts. Open seams or loose connections could permit exhaust fumes to seep into the passenger compartment. In addition, inspect the exhaust system each time the vehicle is raised for lubrication or oil change. Replace as required.

#### **WARNING!**

**Exhaust gases can injure or kill. They contain carbon monoxide which is colorless and odorless. Breathing it can make you unconscious and can eventually poison you. Follow the above precautions to keep your exhaust system as safe as possible.**

### Cooling System

#### **WARNING!**

- **When working near the radiator cooling fan, disconnect the fan motor lead or turn the ignition switch to the OFF position. The fan is temperature controlled and can start at any time the ignition key is in the ON position.**
- **You or others can be badly burned by hot coolant or steam from your radiator. If you see or hear steam coming from under the hood, don't open the hood until the radiator has had time to cool. Never try to open a cooling system pressure cap when the radiator is hot.**

7

#### Coolant Checks

Check coolant protection every 12 months (before the onset of freezing weather, where applicable). If the coolant is dirty or rusty in appearance, the system should be drained, flushed and refilled with fresh coolant.

Check the front of the radiator and condenser for an accumulation of bugs, leaves, etc. Clean the radiator and condenser by gently spraying water from a garden hose at the back of the radiator core.

Check the recovery bottle tank tubing for condition and tightness of connection at the bottle and radiator. Inspect the entire system for leaks.

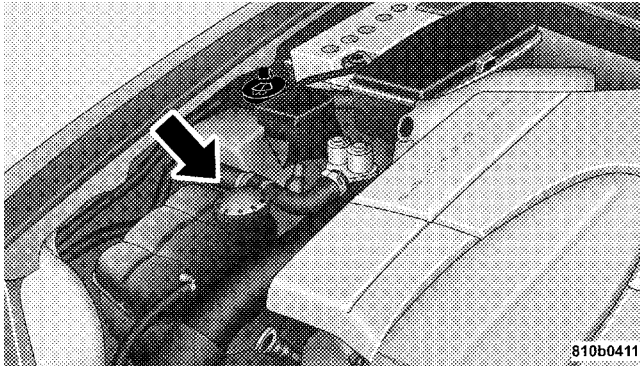

#### **Cooling System - Drain, Flush and Refill**

At the intervals shown on the Maintenance Schedules, the system should be drained, flushed and refilled.

If the solution is dirty and contains a considerable amount of sediment, clean and flush with a reliable cooling system cleaner. Follow with a thorough rinsing to remove all deposits and chemicals.

#### **Engine Coolant Disposal**

Used ethylene glycol based engine coolant is a regulated substance requiring proper disposal. Check with your local authorities to determine the disposal rules for your community. Do not store ethylene glycol based engine coolant in open containers or allow it to remain in puddles on the ground. Prevent ingestion by animals or children. If ingested by a child, contact a physician immediately.

#### **Selection Of Coolant**

Use only coolant approved to MB 325.0, such as Valvoline GO5, or an equivalent extended life coolant. Refer to the recommended Fluids, Lubricants and Genuine Parts for correct coolant type.

**CAUTION!**

**Failure to use the proper antifreeze could cause radiator plugging and engine overheating. Do not mix antifreeze brands or types. Do not use plain water alone or alcohol base antifreeze products. Do not use additional rust inhibitors or antirust products, as they may not be compatible with the radiator coolant and may plug the radiator.**

**Adding Coolant**

When adding coolant, a minimum solution of 50% ethylene glycol antifreeze coolant and water should be used. Use higher concentrations (not to exceed 70%) if temperatures below -34°F (-37°C) are anticipated.

Use only high purity water, such as distilled or deionized water when mixing the water/antifreeze solution. The use of lower quality water will reduce the amount of corrosion protection in the engine cooling system.

**NOTE:** Mixing coolant types other than Mopar® products will decrease the life of the engine coolant and will require more frequent coolant changes.

Please note that it is the owner's responsibility to maintain the proper level of protection against freezing, according to the temperatures occurring in the area where the vehicle is operated.

**Cooling System Pressure Cap**

The cap must be fully tightened to prevent loss of coolant, and to insure that coolant will return to the radiator from the coolant reserve tank.

The cap should be inspected and cleaned if there is any accumulation of foreign material on the sealing surfaces.

**WARNING!**

**The warning words "DO NOT OPEN WHEN HOT" near the cooling system reservoir cap are a safety precaution. Never add coolant when the engine is overheated. Do not loosen or remove the cap to cool an overheated engine. Heat causes pressure to build up in the cooling system. To prevent scalding or injury, do not remove the pressure cap while the system is hot or under pressure.**

**WARNING!**

**Do not use a pressure cap other than the one specified for your vehicle. Personal injury or engine damage may result.**

**Points to Remember**

**NOTE:** When the vehicle is stopped after a few miles/kilometers of operation, you may observe vapor coming from the front of the engine compartment. This is normally a result of moisture from rain, snow, or high humidity accumulation on the radiator and being vaporized when the thermostat opens, allowing hot water to enter the radiator.

If an examination of your engine compartment shows no evidence of radiator or hose leaks, the vehicle may be safely driven. The vapor will soon dissipate.

- Do not overfill the coolant bottle.
- Check coolant freeze point in the system.
- If frequent coolant additions are required, or if the level in the recovery bottle does not drop when the engine cools, the cooling system should be pressure tested for leaks.
- Maintain a coolant concentration of a minimum of 50% ethylene glycol Extended Life Coolant and high quality water with recommended antifreeze for proper corrosion protection of your engine cooling system that contains aluminum components.
- Make sure that the radiator and coolant bottle hoses are not kinked or obstructed.
- Keep the front of the radiator clean. If your vehicle has air conditioning, keep the front of the condenser clean, also.
- Do not change the thermostat for summer or winter operation. If replacement is ever necessary, install **ONLY** the correct type thermostat. Other designs may result in unsatisfactory coolant performance, poor fuel economy, and increased emissions.

### Hoses And Vacuum/Vapor Harnesses

Inspect surfaces of hoses and nylon tubing for evidence of heat and mechanical damage. Hard or soft spots, brittle rubber, cracking, checking, tears, cuts, abrasions, and excessive swelling indicate deterioration of the rubber.

Pay particular attention to the hoses nearest to high heat sources such as the exhaust manifold. Inspect hose routing to be sure hoses do not touch any heat source or moving component that may cause heat damage or mechanical wear.

Insure nylon tubing in these areas has not melted or collapsed. Inspect all hose connections such as clamps and couplings to make sure they are secure and no leaks are present. Components should be replaced immediately if there is any evidence of degradation that could cause failure.

### Brakes

In order to assure brake system performance, all brake system components should be inspected periodically. Suggested service intervals can be found in the Maintenance section.

### WARNING!

**Riding the brakes can lead to brake failure and possibly an accident. Driving with your foot resting or riding on the brake pedal can result in abnormally high brake temperatures, excessive lining wear, and possible brake damage. You wouldn't have your full braking capacity in an emergency.**

### Brake and Power Steering System Hoses

When servicing the vehicle for scheduled maintenance, inspect surface of hoses and nylon tubing for evidence of heat and mechanical damage. Hard and brittle rubber, cracking, checking, tears, cuts, abrasions, and excessive swelling suggest deterioration of the rubber. Particular attention should be made to examining those hose surfaces nearest to high heat sources, such as the exhaust manifold.

Inspect all hose clamps and couplings to make sure they are secure and no leaks are present.

Insure nylon tubing in these areas has not melted or collapsed.

**NOTE:** Often, fluids such as oil, power steering fluid, and brake fluid are used during assembly plant operations to ease the assembly of hoses to couplings. Therefore, oil wetness at the hose-coupling area is not necessarily an indication of leakage. Actual dripping of hot fluid when systems are under pressure (during vehicle operation) should be noted before hose is replaced based on leakage.

**NOTE:** Inspection of brake hoses should be done whenever the brake system is serviced and at every engine oil change.

#### **WARNING!**

**Worn brake hoses can burst and cause brake failure. You could have an accident. If you see any signs of cracking, scuffing, or worn spots, have the brake hoses replaced immediately.**

#### **Brake Master Cylinder**

The fluid level in the master cylinder should be checked when performing under hood services, or immediately if the brake system warning light is on.

Be sure to clean the top of the master cylinder area before removing the cap. If necessary, add fluid to bring the fluid level up to the requirements described on the brake fluid reservoir. Fluid level can be expected to fall as the brake pads wear. Brake fluid level should be checked when pads are replaced. However, low fluid level may be caused by a leak and a checkup may be needed.

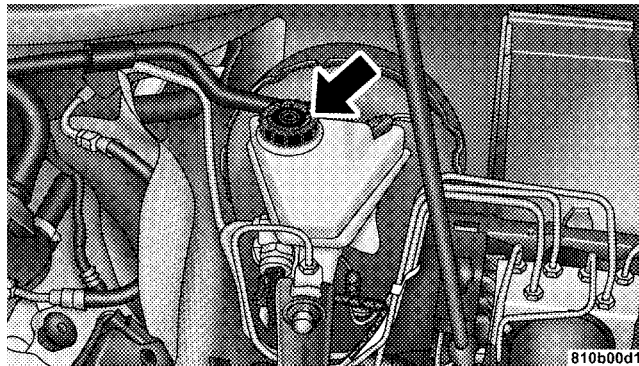

Use brake fluid approved to MB 331.0, or a DOT 4 brake fluid with: minimum dry boiling point (ERBP) 500°F, minimum wet boiling point (WERBP) 356°F, maximum viscosity 1500 mm<sup>2</sup>/s, conforming to FMVSS 116 and ISO 4925.

#### WARNING!

**Use of a brake fluid that may have a lower initial boiling point or unidentified as to specification, may result in sudden brake failure during hard prolonged braking. You could have an accident.**

#### WARNING!

**Use only brake fluid that has been in a tightly closed container to avoid contamination from foreign matter. Use of contaminated fluid may result in reduced brake performance or a sudden brake failure. You could have an accident.**

#### CAUTION!

**Do not allow petroleum-based fluid to contaminate the brake fluid as seal damage will result!**

#### Automatic Transmission

The fluid in the automatic transmission should be changed at 80,000 miles (129,000 km), along with the transmission fluid filter. After that, the transmission fluid is filled for life.

#### Selection of Lubricant

It is important that the proper lubricant is used in the transmission to assure optimum transmission performance. Use only ATF approved to MB 236.10, MB 236.12. Synthetic Dexron III® Automatic Transmission Fluid may be substituted. Refer to the Recommended Fluids, Lubricants and Genuine Parts section for the correct fluid type. It is important that the transmission fluid be maintained at the prescribed level using the recommended fluid.

**CAUTION!**

Using a transmission fluid other than the fluid recommended by DaimlerChrysler Corporation may cause deterioration in transmission shift quality and/or torque converter shudder. Using a transmission fluid other than that recommended by the DaimlerChrysler Corporation will result in more frequent fluid and filter changes. Refer to the Recommended Fluids, Lubricants and Genuine Parts section for correct fluid type.

**Fluid Level Check**

Regular automatic transmission fluid level checks and changes are not required. For this reason the dipstick is omitted.

If you notice fluid loss or gear shift malfunction, have your authorized dealer check the transmission fluid level.

**Fluid and Filter Changes**

Automatic transmission fluid and filter should be changed at 80,000 miles (129,000 km). The fluid is then filled for life.

**NOTE:** Refer to Section 8 of this manual for Maintenance Schedules.

**Manual Transmission****Selection of Lubricant**

No fluid service is required. Use only fluid approved to MB 236.2. SAE 5W-20 engine oil, meeting API SL or GF-3, may be substituted. Refer to the Recommended Fluids, Lubricants and Genuine Parts section for the correct fluid type.

**Fluid Level Check**

Check the fluid level by removing the fill plug. The fluid level should be between the bottom of the fill hole and a point not more than 3/16 inch (4.76 mm) below the bottom of the hole.



**CAUTION!**

**Do not overfill. Dirt and water in the transmission can cause serious damage. To prevent dirt and water from entering the transmission after checking or replenishing fluid, make certain that the dipstick cap is seated properly.**

Add fluid, if necessary, to maintain the proper level.

**Frequency of Fluid Change**

Under normal operation conditions, the fluid installed at the factory will give satisfactory lubrication for the life of the vehicle. Fluid changes are not necessary unless the lubricant has become contaminated with water. If contaminated with water, the fluid should be changed immediately.

**Special Additives**

Do not add any fluid additives to the transmission. The only exception to this policy is the use of special dyes to aid in detecting fluid leaks. The use of transmission sealers should be avoided as this may adversely affect seals.

**Appearance Care and Protection from Corrosion****Protection of Body and Paint from Corrosion**

Vehicle body protection requirements vary according to geographic locations and usage. Chemicals that make roads passable in snow and ice, and those that are sprayed on trees and road surfaces during other seasons, are highly corrosive to the metal in your vehicle. Outside parking, which exposes your vehicle to airborne contaminants, road surfaces on which the vehicle is operated, extreme hot or cold weather and other extreme conditions will have an adverse effect on paint, metal trim, and underbody protection.

The following maintenance recommendations will enable you to obtain maximum benefit from the corrosion resistance built into your vehicle.

**What Causes Corrosion?**

Corrosion is the result of deterioration or removal of paint and protective coatings from your vehicle.

The most common causes are:

- Road salt, dirt and moisture accumulation.
- Stone and gravel impact.
- Insects, tree sap and tar.
- Salt in the air near seacoast localities.
- Atmospheric fallout/industrial pollutants.
- Bird droppings.

**Washing**

- Wash your vehicle regularly. Always wash your vehicle in the shade using a mild car wash soap, and rinse the panels completely with clear water.
- If insects, tar or other similar deposits have accumulated on your vehicle, wash it as soon as possible.

- Use Mopar® auto polish to remove road film and stains and to polish your vehicle. Take care never to scratch the paint.
- Avoid using abrasive compounds and power buffing that may diminish the gloss or thin out the paint finish.

**CAUTION!**

**Do not use abrasive or strong cleaning materials such as steel wool or scouring powder, which will scratch metal and painted surfaces.**

**Special Care**

- If you drive on salted or dusty roads or if you drive near the ocean, hose off the undercarriage at least once a month.
- It is important that the drain holes in the lower edges of the doors, rocker panels and rear liftgate / decklid be kept clear and open.

- If you detect any stone chips or scratches in the paint, touch them up immediately. The cost of such repairs is considered the responsibility of the owner.
- Use Mopar® touch-up paint on scratches or chips as soon as possible. Your dealer has touch-up paint to match the color of your vehicle.
- If your vehicle is damaged due to an accident or similar cause which destroys the paint and protective coating, have your vehicle repaired as soon as possible. The cost of such repairs is considered the responsibility of the owner.
- If you carry special cargo such as chemicals, fertilizers, deicer salt, etc., be sure that such materials are well packaged and sealed.
- Aluminum wheels should be cleaned regularly with mild soap and water to prevent corrosion. To remove heavy soil, select a non-abrasive, non-acidic cleaner. Do not use scouring pads or metal polishes. Avoid automatic car washes that use acidic solutions or harsh brushes that may damage the wheels' protective finish.

### Wheel And Wheel Trim Care

All wheels and wheel trim, especially Aluminum, should be cleaned regularly, using mild soap and water to maintain their luster and to prevent corrosion. Wash them with the same soap solution as the body of your vehicle. Rinse the wheels thoroughly.

When cleaning extremely dirty wheels, care must be taken in the selection of tire and wheel cleaning chemicals and equipment to prevent damage to the wheels. Only Mopar® Wheel Cleaners are recommended. Any of the "DO NOT USE" items listed below can damage wheels and wheel trim.

#### DO NOT USE:

- Any abrasive cleaner
- Any abrasive cleaning pad (such as steel wool) or abrasive brush
- Any cleaner that contains an acid which can react with and discolor the chrome surface.
- Oven cleaner

- A car wash that uses carbide-tipped wheel cleaning brushes or acidic solutions.

**CAUTION!**

**Many wheel cleaners contain acids that may harm the wheel surface.**

**Interior Care**

Use Mopar® Fabric Cleaner to clean fabric upholstery and carpeting.

Use Mopar® Vinyl Cleaner to clean vinyl upholstery. Mopar® Vinyl Cleaner is specifically recommended for vinyl trim.

**Leather Seat Care and Cleaning**

Leather is best preserved by regular cleaning with a damp soft cloth. Small particles of dirt can act as an abrasive and damage the leather surface and should be removed immediately with a damp cloth. Stubborn soils can be removed easily with a soft cloth and Mopar® Total Clean. Care should be taken to avoid soaking your

leather upholstery with any liquid. Please do not use polishes, oils, cleaning fluids, solvents, detergents, or ammonia based cleaners to clean your leather upholstery. Application of a leather conditioner is not required to maintain the original condition.

**CAUTION!**

**The use of vinyl, leather or plastic protectants may cause excessive gloss and/or discoloration of interior trim parts.**

**WARNING!**

**Do not use volatile solvents for cleaning purposes. Many are potentially flammable, and if used in closed areas they may cause respiratory harm.**

**Cleaning Headlights**

Your vehicle has plastic headlights that are lighter and less susceptible to stone breakage than glass headlights.

Plastic is not as scratch resistant as glass and therefore different lens cleaning procedures must be followed.

To minimize the possibility of scratching the lenses and reducing light output, avoid wiping with a dry cloth. To remove road dirt, wash with a mild soap solution followed by rinsing.

Do not use abrasive cleaning components, solvents, steel wool or other aggressive material to clean the lenses.

#### **Glass Surfaces**

All glass surfaces should be cleaned on a regular basis with any commercial household-type glass cleaner. Never use an abrasive-type cleaner. Use caution when cleaning inside rear windows equipped with electric defrosters. Do not use scrapers or other sharp instruments which may scratch the elements.

#### **Instrument Panel Cover**

The instrument panel cover has a low glare surface which minimizes reflections in the windshield. Do not use protectants or other products which may cause undesirable reflections. Use soap and warm water to restore the low glare surface.

#### **Cleaning Plastic Instrument Cluster Lenses**

The lenses in front of the instruments in the vehicle are molded in clear plastic. When cleaning the lenses, care must be taken to avoid scratching the plastic.

- Clean with a wet soft rag. A mild soap solution may be used, but do not use high alcohol content or abrasive cleaners. If soap is used, wipe clean with a clean damp rag.
- Dry with a soft tissue.

#### **Seat Belt Maintenance**

Do not bleach, dye or clean the belts with chemical solvents or abrasive cleaners. This will weaken the fabric.

If the belts need cleaning, use a mild soap solution or lukewarm water. Do not remove the belts from the vehicle to wash them.

Replace the belts if they appear frayed or worn or if the buckles do not work properly.

## FUSES

### Engine Compartment Fuses

The engine compartment fuses are located under the hood on the driver's side, between the brake master cylinder and the left front fender.

To remove the lid, squeeze the tabs together located at the front of the fusebox. Then lift the lid up by the tabs. The lid will then slide off the top of the fuse box. To replace the lid, place the two hinge-like tabs at the rear of the lid under the tabs on the fusebox. Push down on the front of the lid until the tabs at the front click.

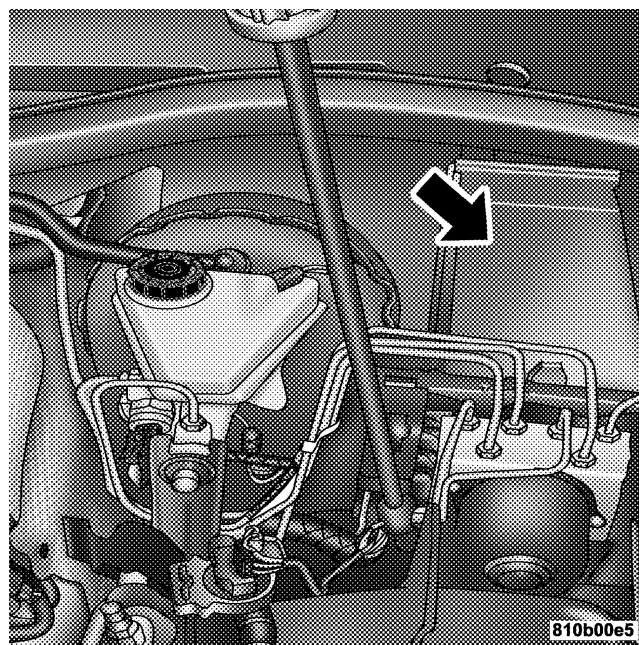

**CAUTION!**

When replacing a blown fuse, it is important to use only a fuse having the correct amperage rating. The use of a fuse with a rating other than indicated may result in a dangerous electrical system overload. If a properly rated fuse continues to blow, it shows a problem in the circuit that must be corrected.

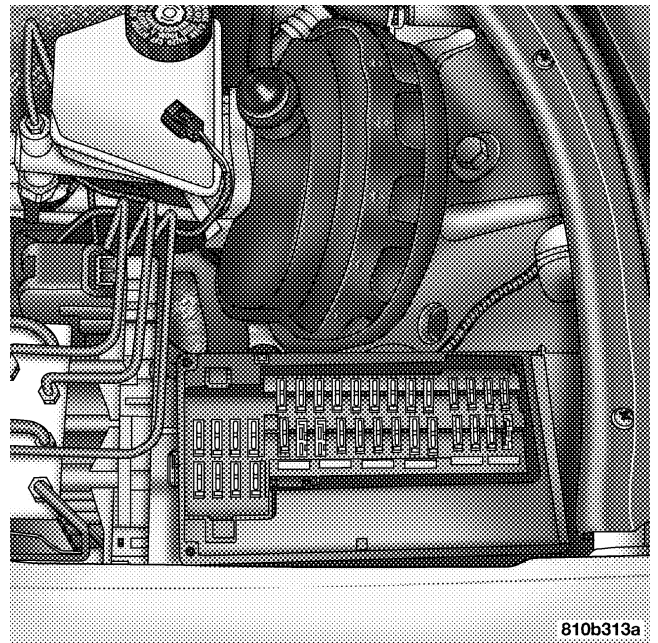

**Engine Compartment Fuses**

Cavity	Fuse	Circuits
1	5 Amp Beige	Garage Door Opening Signal, TPM and Seat Heater
2	5 Amp Beige	Occupant Restraint Controller Passenger Airbag Off
3	5 Amp Beige	Indicator, Safety Restraint System and Indicator, Passenger Airbag Off
4	30 Amp Green	Wiper Motor
5	15 Amp Blue	Radio
6	15 Amp Blue	Exterior Mirror Adjustment, Left And Right
7	5 Amp Beige	Electronic Transmission Control (Park/Reversing Lock), Photo- chromatic Rearview Mirror and BCM
8	15 Amp Blue	Radio

Cavity	Fuse	Circuits
9	10 Amp Red	Roof Light, Horn, Anti-Theft Alarm, Liftgate Light and Tire Pressure Control
10	5 Amp Beige	Speed Control
11	15 Amp Blue	Ignition Coil 6 Cyl.
12	10 Amp Red	Heated Washer Nozzles
13	10 Amp Red	Spare
14	20 Amp Yellow	Diagnostic Socket
15	5 Amp Beige	Residual Engine Heat Utilization
16		Spare
17		Spare
18		Spare
19	40 Amp Orange	Power Window, Front



Cavity	Fuse	Circuits
20	10 Amp Red	Spoiler Motor
21	30 Amp Green	Seat Adjustment Right Side
22	30 Amp Green	Seat Adjustment Left Side
23	15 Amp Blue	Sound Booster (Amplifier)
24	30 Amp Green	Seat Heater
25	20 Amp Yellow	Pneumatic Control Unit, Rear Window Defroster
26	20 Amp Yellow	Central Locking
30		Spare
31	15 Amp Blue	Cigar Lighter, Glove Compartment Light
32	15 Amp Blue	Wiper, Washer Pump, Headlight Flasher
33	5 Amp Beige	Residual Engine Heat Utilization

Cavity	Fuse	Circuits
34		Spare
35	15 Amp Blue	Radio Frequency Remote Control, Hazard Warning Flasher, Instrument Cluster, Residual Engine Heat Utilization
36	30 Amp Green	Residual Engine Heat Utilization
37	5 Amp Beige	Circulating Air, Instrument Cluster, Radio Frequency Remote Control, Residual Engine Heat Utilization

### Relay Control Module Fuses

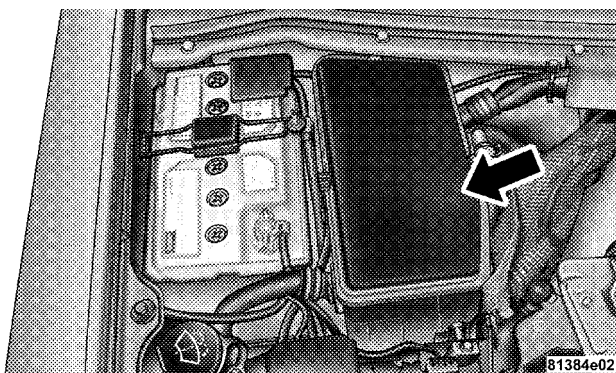

The relay control module fuses are located in the Control Module Box next to the battery in the engine compartment. Slide the control module box cover retaining clips forward and lift the cover from the control module box to gain access to the relay control module fuses.

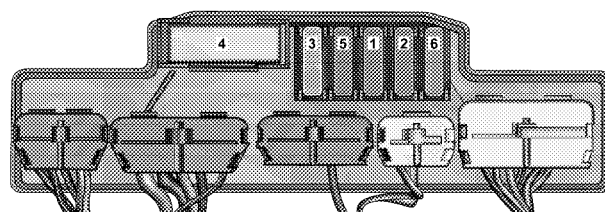

01385041

#### Relay Control Module Fuses

Cavity	Fuse	Circuits
1	15 Amp Blue	Traction System
2	15 Amp Blue	Engine Control 2
3	15 Amp Blue	Engine Control 1
4	40 Amp Orange	Air Pump

Cavity	Fuse	Circuits
5	15 Amp Blue	Fuel Pump
6	15 Amp Blue	Horn

**Interior Fuses**

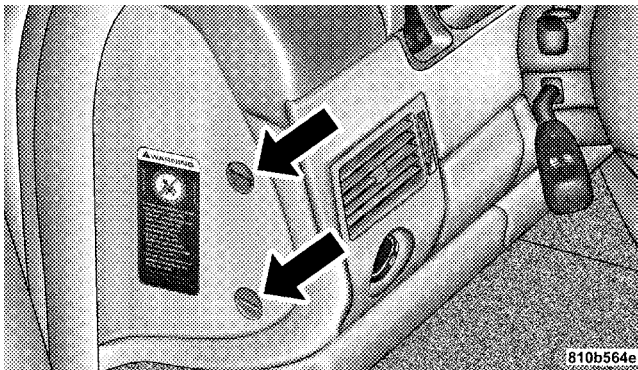

The fuse access door is located on the end of the instrument panel on the driver's side behind the trim panel cover. Use a coin or flat blade screwdriver to open and close this access door.

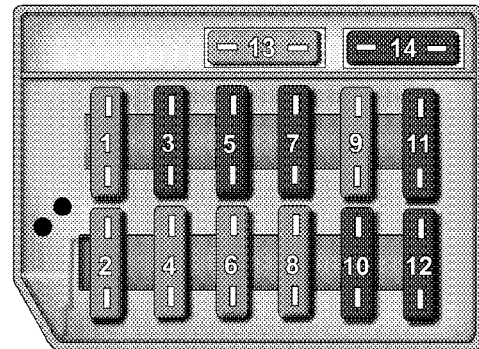

8113fcb2

**Interior Fuses**

Cavity	Fuse	Circuits
1		Not Assigned
2	15 Amp Blue	Brake Lamp/Speed Control
3	7.5 Amp Brown	Right High Beam, High Beam Indicator Light
4	15 Amp Blue	Reverse/Turn signal Light, Auto Dimming Rear View Mirror Control

Cavity	Fuse	Circuits
5	7.5 Amp Brown	Left High Beam
6	15 Amp Blue	Right Low Beam
7	7.5 Amp Brown	Right Parking/Tail Light Side Marker
8	15 Amp Blue	Left Low Beam
9	15 Amp Blue	Fog Light
10	7.5 Amp Brown	Left Parking/Tail Light Side Marker
11	7.5 Amp Brown	License Plate/Instrument Cluster Lighting/Symbol Lighting
12	7.5 Amp Brown	Rear Fog Light (European Mar- kets Only)
13		Not Used
14		Not Used

## REPLACEMENT BULBS

### Interior Light Bulbs

For lighted switches and interior lights, see your authorized dealer for servicing requirements.

### Exterior Light Bulbs

Bulb	Bulb No.
Headlight - High and Low Beam . . . . .	12V55W H7U
Front Turn Signal . . . . .	Y21W
Front Parking/Standing Light . . . . .	W5W
Front Side Marker Light . . . . .	W5W
Rear Marker Light . . . . .	W5W
Center High-Mounted Stop Light (CHMSL) . . . . .	LED
Front Fog Lights . . . . .	HB455W
Rear Turn Signal Light . . . . .	Y21W
Rear Tail and Stop Light . . . . .	21/5W
Backup Light . . . . .	21W
License . . . . .	168

**EXTERIOR LIGHT BULB SERVICE****Headlights****WARNING!**

Halogen lamps contain pressurized gas. A bulb can explode if you:

- touch or move it when hot,
- drop the bulb,
- scratch the bulb

Wear eye and hand protection.

**NOTE:** To prevent a possible electrical short circuit, switch off light prior to replacing a bulb.

1. Push the tab down at the top end of the cover and remove.
2. Disconnect the electrical connector.
3. Release the spring clamps holding the bulb in place, and pull out the bulb. Replace the bulb and reverse the removal procedure exactly.

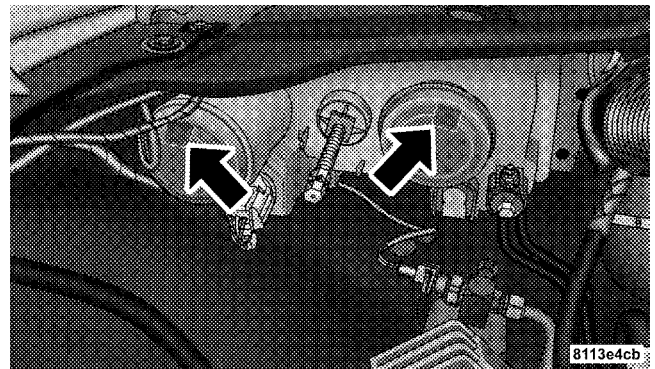
**CAUTION!**

Do not touch the new bulb with your fingers. Oil contamination will severely shorten bulb life. If the bulb comes in contact with an oily surface, clean the bulb with rubbing alcohol.

**Front Turn Signal and Parking/Standing Lights**

- Twist the bulb socket counterclockwise and pull out. Push the bulb into the socket, turn counterclockwise and remove.
- Replace the bulb, push in and twist clockwise. Reinstall the socket, and turn clockwise.

**Front and Rear Sidemarkers Lights**

1. Push the front sidemarker assembly in and slide it forward. Push the rear sidemarker assembly in and slide rearward. The assembly will release from the fascia.
2. Twist the bulb socket counterclockwise and pull out. Push the bulb into the socket, turn counterclockwise and remove.
3. Replace the light, push in and twist clockwise.
4. Realign the two tabs and push the light in until it engages into the lock.

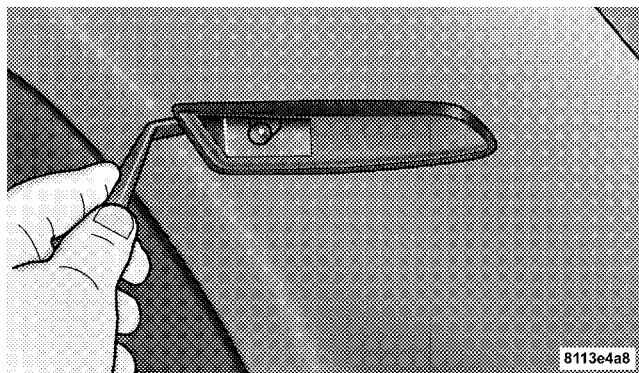
**Tail, Stop, Back Up and Turn Signal Lights**

1. Open the rear liftgate and remove the access door in the trim panel.
2. Twist the bulb socket counterclockwise and pull out.
3. Replace the light and return to open socket, turn clockwise until it stops.

4. Replace the access door in the trim panel.

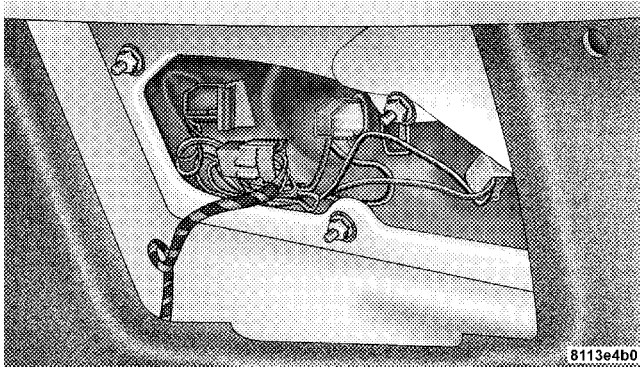

#### License Plate Light

1. Remove the two lens assembly mounting screws.
2. Pull the bulb out of the socket.
3. Replace the bulb and reattach the lens assembly.
4. Align and resecure the two lens assembly mounting screws.

**NOTE:** Be sure not to over-torque the mounting screws or permanent damage to the lens may occur.

**NOTE:** Always test the operation of all lights after service operations have been performed to validate an effective repair.

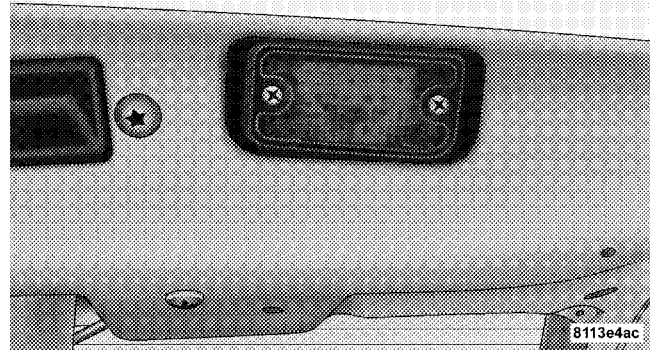

#### Headlight Aiming

The headlights on your new vehicle were aimed at the factory. The factory setting was made at a no load setting. A great increase in weight will change the aiming and it may be necessary to readjust the headlights if carrying an excessive amount of weight in the rear cargo area. To readjust the headlights first mark the position of the headlights on a wall prior to loading the vehicle. Load

the vehicle and then readjust the headlights to the original position. If any further adjustments are necessary contact your manufacturer's dealer. A detailed service procedure is contained in the manufacturer's Service Manual. Information on purchasing a Service Manual can be found at the back of this Owner's Manual.

#### VEHICLE STORAGE

We recommend that you follow these guidelines before storing your Crossfire for extended periods.

- Fill the gas tank. This will prevent water condensation inside the tank. If you plan on storing your vehicle more than two months, add an anti-oxidant fuel stabilizer to the gas tank.
- Change the oil to remove any corrosive combustion-related acids in the crankcase.
- Wash and wax the vehicle to protect the finish.
- Cover the vehicle whenever possible to prevent accidental damage to the finish.
- Store the vehicle in a dry, well-ventilated location.

- If the vehicle will be subjected to freezing temperatures, remove the battery and store it in a dry, well-ventilated place. If the vehicle is not going to be driven in the next three weeks, follow the battery recharge procedure in the Service Manual, then disconnect the battery at the negative terminal.

#### CAUTION!

**Use care when disconnecting the remote positive cable. It is connected to the battery and can short out to any metal on the vehicle. Always tape or wrap the exposed cable end to prevent electrical shorts.**

Disconnecting the battery causes the engine control system to lose memory of some "learned" functions. The engine may run rough when first started after a battery disconnect until the control module "relearns" these functions.



Check the battery every four to six weeks to ensure that the voltage is above 12.40. Voltage will drop more rapidly in hot temperatures. If battery voltage drops below 12.40, follow the battery recharge procedure in the Service Manual.

- Check that the radiator coolant level of protection is to at least  $-20^{\circ}\text{F}$  ( $-29^{\circ}\text{C}$ ).
- Block the wheels. Do not apply the parking brake.
- Make sure that all tires are inflated to the optimum pressure.
- Cut blocks of plywood about the same size of the tires. Cover each block with indoor/outdoor carpeting and place them between the tires and concrete. This will prevent tire flat spotting.

- For long term storage, remove the tires and put the vehicle up on blocks. Stack the tires on plywood and cover with a tarp to prevent flat spotting.
- Move the wiper blades away from the windshield.

**NOTE:** To help prevent the battery from discharging during shorter periods of inactivity, perform the following:

1. Make sure that the rear liftgate, hood, and doors are completely closed.
2. Make sure that the remote transmitter is operating and that the battery is good.
3. Make sure that the hood, rear liftgate and door switches are in adjustment.
4. Use the remote transmitter to set the alarm.

**SPECIFICATIONS****Engine Specifications**

Engine Size	195.2 CID (3.2 Liters)
Mode of Operation	4-stroke engine, gasoline injection
No. of Cylinders	6
Horsepower (SAE J 1349)	215 hp (160 kW) @ 5700 rpm
Bore	3.54 in. (89.90 mm)
Stroke	3.30 in. (84.00 mm)
Torque (SAE J 1349)	229 ft. lbs. (310 N·m) @ 3000 rpm
Firing Order	1-4-3-6-2-5
Compression Ratio	10:1
Spark Plugs	Bosch F 8 DPER/ NGK PFR 5-11
Spark Plug Gap	0.039 in. (1.0 mm)
Tightening Torque	15-22 ft. lbs. (20-30 N·m)
Maximum Engine Speed	6000 rpm
Accessory Drive Belt	94.1 in. (2390 mm)

**Performance Specifications (approximate)**

Maximum Speed	150 mph (242 km/h)
Acceleration 0-60 mph	6.5 seconds
1/4 mile time	14.9 seconds at 96 mph (154 km/h)

**Gear Ratios - 6-Speed Manual Transmission**

First	4.459
Second	2.614
Third	1.723
Fourth	1.245
Fifth	1.000
Sixth	0.838
Reverse	4.062

**Gear Ratios - 5-Speed Automatic Transmission**

First	3.95
Second	2.423
Third	1.486
Fourth	1.00
Fifth	0.833
Reverse	3.147/1.93

**Body Specifications**

Overall Length	159.8 in. (4058 mm)
Maximum Width	69.5 in. (1766 mm)
Maximum Width With Mirrors	76.9 in. (1954 mm)
Overall Height	51.5 in. (1307 mm)
Front Track	58.8 in. (1493 mm)
Rear Track	59.1 in. (1502 mm)
Wheelbase	94.5 in. (2400 mm)
Front Overhang	32.4 in. (822 mm)
Rear Overhang	32.9 in. (836 mm)
Front Ground Clearance	5.0 in. (127 mm)
Rear Ground Clearance	5.8 in. (147 mm)
Turning Radius	32.9 ft. (10.3 m)
Weight	3061 lbs. (1389 kg)
Maximum Vehicle Load	415 lbs. (188 kg)
Luggage Capacity	7.7 cu. ft. (215 l)

**FLUID CAPACITIES**

	<b>U.S.</b>	<b>Metric</b>
<b>Fuel (Approximate)</b>	15.8 Gallons	60.0 Liters
<b>Fuel Tank Reserve</b>	2.1 Gallons	8.0 Liters
<b>Engine Oil (with filter)</b>		
3.2 L Engine	8.5 Qts.	8.0 Liters
<b>Cooling System *</b>		
3.2 L Engine	11.8 Qts.	11.2 Liters
<b>Manual Transmission</b>	1.9 Qts.	1.8 Liters
<b>Automatic Transmission</b>	8.5 Qts.	8.0 Liters
<b>Rear Axle</b>	1.4 Qts.	1.3 Liters
<b>Power Steering Reservoir</b>	1.1 Qts.	1.0 Liters
<b>Brake Reservoir</b>	.5 Qts.	.5 Liters
<b>Windshield Washer Reservoir</b>	7.4 Qts.	7.0 Liters

\* Includes heater and coolant recovery bottle filled to MAX level.

**RECOMMENDED FLUIDS, LUBRICANTS AND GENUINE PARTS****Engine**

<b>Component</b>	<b>Fluids, Lubricants and Genuine Parts</b>
Engine Coolant	Use coolant approved to MB 325.0, such as Valvoline GO5, or an equivalent extended life coolant.
Engine Oil	Only use synthetic engine oils, approved to MB 229.3 or MB 229.5, such as Mobil 1 SAE 0W-40. The FSS may not alert for an oil change at the proper interval if an unapproved engine oil is used; engine damage and reduced engine life may result.
Engine Oil Filter	Mopar® 5102905AA or equivalent
Spark Plugs	Bosch F 8 DPER/NGK PFR 5-11
Spark Plug Gap	0.039 in (1.0 mm)
Fuel Selection	Premium Unleaded 95 Octane/Minimum 91 Octane

**Chassis**

<b>Component</b>	<b>Fluids, Lubricants and Genuine Parts</b>
Automatic Transmission	Only use ATF approved to MB 236.10, MB 236.12. Synthetic Dexron III® Transmission Fluid may be substituted.
Brake Master Cylinder	Use brake fluid approved to MB 331.0, or a DOT 4 brake fluid with: minimum dry boiling point (ERBP) 500°F (260°C), minimum wet boiling point (WERBP) 356°F (180°C), maximum viscosity 1500 mm <sup>2</sup> /s, conforming to FMVSS 116 and ISO 4925.
Clutch Fluid	Use brake fluid approved to MB 331.0, or a DOT 4 brake fluid with: minimum dry boiling point (ERBP) 500°F (260°C), minimum wet boiling point (WERBP) 356°F (180°C), maximum viscosity 1500 mm <sup>2</sup> /s, conforming to FMVSS 116 and ISO 4925.
Manual Transmission Fluid	No fluid service required. Only use fluid approved to MB 236.2. SAE 5W-20 engine oil, meeting API SL or GF-3, may be substituted.
Power Steering Reservoir	No fluid service required. Filled at the factory with Pentosin CHF 11S. Steering noise and reduced component life may result if an unapproved fluid is used.
Rear Axle Fluid	Only use synthetic SAE 75W-85 axle lubricant that meets MB 231.1. Reduced axle durability may result if an unapproved product is used.
Tire Pressure	Refer to label on driver's door frame.

**Body**

<b>Component</b>	<b>Fluids, Lubricants and Genuine Parts</b>
Hinges: Door Liftgate / Decklid Hood Springs and Links	Mopar® Spray White Lube Mopar® Multi-Purpose Lube NLGI Grade 2 EP, GC-LB Mopar® Spray White Lube
Latches: Liftgate/Decklid Hood/Safety Catch Door	Mopar® Spray White Lube Mopar® Multi-Purpose Lube NLGI Grade 2 EP, GC-LB Mopar® Spray White Lube
Seat Regulator and Track	Mopar® Multi-Purpose Lube NLGI Grade 2 EP, GC-LB
Window System Components	Mopar® Spray White Lube
Lock Cylinders	Mopar® Lock Cylinder Lube
Spoiler	Mopar® Spray White Lube





---

## MAINTENANCE SCHEDULES

### CONTENTS

---

<ul style="list-style-type: none"> <li>■ Introduction .....226</li> <li>■ Warranty .....226</li> <li>■ Emission Control System Maintenance .....227</li> <li>■ Maintenance Schedules .....227                             <ul style="list-style-type: none"> <li>□ Scope Of Work For “A” Schedule Maintenance Service .....228</li> <li>□ Scope Of Work For “B” Schedule Maintenance Service .....228</li> </ul> </li> <li>■ FSS System .....230</li> </ul>	<ul style="list-style-type: none"> <li>■ Regular Check-Ups .....231                             <ul style="list-style-type: none"> <li>□ Additional Periodic Maintenance .....232</li> </ul> </li> <li>■ Special Maintenance Requirements .....233                             <ul style="list-style-type: none"> <li>□ Coolant .....233</li> <li>□ Dust Filter For Heating/Ventilation Replacement .....234</li> </ul> </li> <li>■ Engine Oil Change And Filter Replacement . . .234</li> </ul>
---	--

**INTRODUCTION**

This is intended as a guide to the service requirements of your vehicle.

It contains all necessary instructions concerning service intervals and operations which have to be carried out.

Scope and frequency of maintenance work primarily depend on the vehicle's operating conditions. In the interest of maintaining the vehicle's operating safety, the specified work should be performed regularly and in good time.

Our vehicles are subject to ongoing development. Technical progress may also affect the scope of service work performed.

"Daily vehicle checks" before starting a journey are the responsibility of the driver.

**WARRANTY**

The DaimlerChrysler Corporation Dealer network is at your disposal for maintenance work. Each of these workshops has the equipment and tools, the specially trained, skilled and experienced personnel and receives regular technical instruction from DaimlerChrysler Corporation to ensure that your vehicle is inspected and maintained thoroughly and in accordance with the latest procedures.

Please follow the instructions given in this Owner's Manual and ensure that they are observed, even if you hand the vehicle over to a third party for use or care. By not observing these instructions you may void your warranty rights.

If the specified oil and maintenance services are not carried out regularly or at the time intervals specified, a decision as to the validity of a warranty claim can only be made after DaimlerChrysler Corporation has investigated your claim.

The use of Special lubricant additives is not recommended. The use of such additives may affect your warranty rights. With regard to legal stipulations concerning emissions control, please note that engines have

to be serviced and adjusted in accordance with special instructions and using special measuring equipment. Modifications to or interference with the emissions control systems are not permissible.

All DaimlerChrysler Corporation dealers are familiar with the relevant and applicable regulations.

#### **EMISSION CONTROL SYSTEM MAINTENANCE**

The "Scheduled" maintenance services, listed in **bold type** must be done at the times or mileages specified to assure the continued proper functioning of the emission control system. These, and all other maintenance services included in this manual, should be done to provide best vehicle performance and reliability. More frequent maintenance may be needed for your Crossfire in severe operating conditions such as dusty areas and very short trip driving.

Inspection and service also should be done any time a malfunction is suspected.

**NOTE:** Maintenance, replacement, or repair of the emission control devices and systems on your vehicle

may be performed by any automotive repair establishment or individual using any automotive part which has been certified pursuant to U.S. EPA or, in the State of California, California Air Resources Board regulations.

#### **MAINTENANCE SCHEDULES**

There are two maintenance schedules that show the **required** service for your vehicle.

Schedule "A" typically rotates with Schedule "B." Follow Schedule "A" after the first service interval, Schedule "B" after the second service interval, and so on. In some cases where the service interval has been extended due to very light duty driving, a Schedule "B" service may be indicated following a previous Schedule "B" service. There are additional service tasks required under Schedule "B."

Your Flexible Service System (FSS) — see Understanding Your Instrument Panel section — should give you an exact indication of when your vehicle should be scheduled for service and which schedule to follow.

**Additional Periodic Maintenance** items should also be performed beyond the items listed in the following charts to assure the optimum performance of your Crossfire.

**SCOPE OF WORK FOR "A" SCHEDULE MAINTENANCE SERVICE**

**Oil Change**

- Change oil and replace filter

**Maintenance**

- Lubricate hood hinges, latch, and secondary latch
- Reset FSS Display

**Function Check**

- Horn, hazard warning flashers, turn signals, and indicator lamps
- Headlamps and exterior lighting
- Windshield wipers and washer system

**Inspection**

- Check front and rear brake pads for lining thickness

- Check tires for damage and general condition
- Check tire inflation pressures and correct if necessary

**Fluid Levels**

Check fluid levels for the following systems and correct if necessary. Should there be a loss of fluid that cannot be explained by regular use, trace and eliminate the cause.

- Engine cooling system (check corrosion inhibitor/antifreeze)
- Hydraulic brake system
- Power steering system
- Windshield washer system

**SCOPE OF WORK FOR "B" SCHEDULE MAINTENANCE SERVICE**

**Oil Change**

- Change oil and replace filter

**Maintenance**

- Rotate tires

- Replace dust filter
- Lubricate hood hinges, latch, and secondary latch
- Reset FSS Display

#### Function Check

- Horn, hazard warning flashers, turn signals, and indicator lamps
- Headlamps and exterior lighting
- Windshield wipers and washer system
- Check seat belts for damage and proper function
- Test hydraulic brakes and check parking brake function

#### Inspection

- Check front and rear brake pads for lining thickness
- Check condition of front and rear brake discs
- Check tires for damage and general condition
- Check tire inflation pressures and correct if necessary

- Check major underbody components for leakage or damage (if there are signs of leakage, determine cause and repair)
- Check condition of front axle ball joints and rubber boots
- Check condition of steering components and rubber boots
- Check underhood components for leakage or damage (if there are signs of leakage determine cause and repair)
- Check condition of accessory drive belt
- Check headlamp aiming, adjust if necessary
- Check windshield wiper blades, replace if necessary

#### Fluid Levels

Check fluid levels for the following systems and correct if necessary. Should there be a loss of fluid that cannot be explained by regular use, trace and eliminate the cause.

- Engine cooling system (check corrosion inhibitor/antifreeze)

**230 MAINTENANCE SCHEDULES**

- Hydraulic brake system
- Power steering system
- Windshield washer system

**FSS SYSTEM**

The Flexible Service System (FSS) permits a flexible service schedule that is directly related to the operating conditions of the vehicle. See the Understanding Your Instrument Panel section for details on how to use the FSS.

The oil change interval for your Crossfire is initially set at 7,000 miles (11,000 km). Very light duty driving cycles (most trips more than 10 miles [16 km] at moderate speeds in moderate temperature conditions) can extend the service interval beyond 7,000 miles (11,000 km). If **ANY** of the following apply to your driving, the oil change interval can be reduced significantly:

- Day or night temperatures are below 32°F (0°C).
- Stop and go driving.
- Extensive engine idling.

- Driving in dusty conditions.
- Short trips of less than 10 miles (16 km).
- More than 50% of your driving is at sustained high speeds during hot weather, above 90°F (32°C).

There are two symbols which will appear in the main odometer display field prior to the next suggested service.



This symbol represents Service A.



This second symbol represents Service B. Service B rotates with Service A and includes additional service tasks.



The next service is normally calculated and displayed next to the Service A or Service B symbol as distance remaining before the next service is required.



Depending on operating conditions throughout the year, a clock symbol may appear next to the service symbol. When this occurs, the next service is calculated and displayed in days remaining before the next service is required.

You should have the maintenance performed within the stated time period or distance.

Following a completed A or B service your authorized dealer sets the counter to 7,000 miles (11,000 km).

**NOTE:** When disconnecting vehicle battery for one or more days at a time, such days will not be counted. Any such days not counted by FSS can be added by your authorized dealer.

The interval between services is determined by the type of vehicle operation. Driving at extreme speeds, and cold starts combined with short distance driving in which the engine does not reach normal operating temperature, reduce the interval between services.

Regardless of the service interval determined by your FSS, the scheduled services as posted in this manual must be followed to properly care for your vehicle.

### REGULAR CHECK-UPS

To maintain the safe operation of your vehicle, it is recommended that you perform the following tasks on a regular basis (i.e., weekly or whenever the vehicle is refueled).

#### CAUTION!

**Failure to perform the required maintenance items may result in damage to the vehicle.**

#### *At Each Stop for Fuel*

- Check the engine oil level about 5 minutes after a fully warmed engine is shut off. Checking the oil level while the vehicle is on level ground will improve the accuracy of the oil level reading. See the procedure described in Checking Your Engine Oil in the Understanding Your Instrument Panel section or under Engine Oil in the Maintaining Your Vehicle section. Add oil only when the level is at or below the ADD or MIN mark.

**232 MAINTENANCE SCHEDULES**

- Check the windshield washer solvent and add if required.
- Inspect wiper blade condition.
- Check operation of lighting systems.
- Inspect tires for unusual wear, damage, and pressure (at least every 14 days).
- Mechanical assemblies (e.g., engine, transmission, etc.) - check for leaks.

***Once a Month***

- Inspect the battery and clean and tighten the terminals as required.
- Check the fluid levels of coolant reservoir, brake master cylinder and power steering and add as needed.
- Check all lights and all other electrical items for correct operation.

**Additional Periodic Maintenance**

The following maintenance items should be performed during the scheduled maintenance nearest the time elapsed and/or distance shown. Follow the interval that occurs first.

Every 2 years:

- Inspect body for paint damage.
- Check chassis and supporting body parts for damage and corrosion.

At approximately every 50,000 miles (80,000 km) or 4 years:

- Check condition of driveshaft flex discs.
- Retighten locking bolts for steering (observe torque).



At approximately every 60,000 miles (96,000 km) or 4 years:

- Replace fuel filter.
- Replace air cleaner filter element.

At approximately 80,000 miles (129,000 km):

- Change the automatic transmission fluid and filter. After this change it is filled for life. The manual transmission comes filled for life from the factory.

At approximately every 100,000 miles (161,000 km) or 5 years:

- Replace spark plugs.

Every 100,000 miles (161,000 km) or 5 years:

- Replace engine coolant using Extended Life Coolant.

### WARNING!

**You can be badly injured working on or around a motor vehicle. Do only that service work for which you have the knowledge and the right equipment. If you have any doubt about your ability to perform a maintenance service, take your vehicle to a competent technician.**

### SPECIAL MAINTENANCE REQUIREMENTS

#### Coolant

Have the corrosion inhibitor/antifreeze concentration in the coolant checked before the onset of winter (once a year in countries with high prevailing temperatures). Have the coolant replaced every five years or 100,000 miles (161,000 km).

**Dust Filter for Heating/Ventilation Replacement**

The dust filter is replaced during routine maintenance service. The filter element must be replaced with "B" Schedule service or every 18,500 miles (30,000 km) to maintain effectiveness. However, if operating conditions are dusty, these filters should be replaced more frequently. A cover in the HVAC unit that can be reached from the passenger foot well provides access to the filter element.

**ENGINE OIL CHANGE AND FILTER REPLACEMENT**

The recommended oil and filter change interval is based on FSS or 1 year. Please refer to the heading FSS System in this section for a full description of the use and interpretation of symbols in the FSS system. Only use synthetic engine oils, approved to MB 229.3 or MB 229.5, such as Mobil 1 SAE 0W-40. The FFS may not alert for an oil change at the proper interval if an unapproved engine oil is used; engine damage and reduced engine life may result. Information is available from your authorized dealer. The oil filter should always be changed when the oil is changed.

---

## IF YOU NEED CONSUMER ASSISTANCE

### CONTENTS

---

■ Suggestions For Obtaining Service For Your Vehicle . . . . .	236	■ Reporting Safety Defects . . . . .	240
□ Prepare For The Appointment . . . . .	236	□ In Canada . . . . .	240
□ Prepare A List . . . . .	236	■ Publication Order Forms . . . . .	240
□ Be Reasonable With Requests . . . . .	236	■ Department Of Transportation Uniform Tire Quality Grades . . . . .	241
■ If You Need Assistance . . . . .	236	□ Treadwear . . . . .	241
■ Warranty Information . . . . .	239	□ Traction Grades . . . . .	242
■ Mopar® Parts . . . . .	240	□ Temperature Grades . . . . .	242

**SUGGESTIONS FOR OBTAINING SERVICE FOR YOUR VEHICLE****Prepare For The Appointment**

If you're having warranty work done, be sure to have the right papers with you. Take your warranty folder. All work to be performed may not be covered by the warranty; discuss additional charges with the service manager. Keep a maintenance log of your vehicle's service history. This can often provide a valuable clue to the current problem.

**Prepare A List**

Make a written list of your vehicle's problems or the specific work you want done. If you've had an accident, or work done that is not on your maintenance log, let the service advisor know.

**Be Reasonable With Requests**

If you list a number of items, and you must have your vehicle by the end of the day, discuss the situation with the service advisor and list the items in order of priority. At many dealers you may obtain a rental vehicle at a

minimal daily charge. If you need a rental, it is advisable to make these arrangements when you call for an appointment.

**IF YOU NEED ASSISTANCE**

DaimlerChrysler and its dealers are vitally interested in your satisfaction. We want you to be happy with our products and services.

Your selling dealer is best equipped and most anxious to provide prompt resolution for any warranty issue or related matter that you may experience. Authorized dealers have the facilities, factory-trained technicians, special tools, and the latest information to assure your vehicle is fixed correctly and in a timely manner. DaimlerChrysler has empowered its dealers to make warranty and repair decisions that ensure you are not inconvenienced. There is no need for you to wait for a decision from the DaimlerChrysler Corporation. If a special circumstance occurs that requires information from the DaimlerChrysler Corporation, we have asked the dealer's service management to make the contact on your behalf.

This is why you should always talk to your dealer's service manager first. Most matters can be resolved with this process.

- If for some reason you are still not satisfied, talk to the general manager or owner of the dealership. They want to know if you need assistance.
- If your dealership is unable to resolve the concern, you may contact the DaimlerChrysler Corporation's Customer Center.

Any communication to the DaimlerChrysler Corporation's Customer Center should include the following information:

- Owner's name and address
- Owner's telephone number (home and office)
- Dealership name
- Vehicle identification number
- Vehicle delivery date and mileage

***DaimlerChrysler Motors Corporation Customer Center***

P.O. Box 21-8004  
 Auburn Hills, MI 48321-8004  
 Phone: (800) 992-1997

***DaimlerChrysler Canada Inc. Customer Center***

P.O. Box 1621  
 Windsor, Ontario N9A 4H6  
 Phone: (800) 465-2001

***In Mexico contact:***

A.V. Prolongacion Paseo de la Reforma, 1240  
 Sante Fe C.P. 05109  
 Mexico, D.F.

In Mexico (915) 729-1248 or 729-1240  
 Outside Mexico (525) 729-1248 or 729-1240

***Customer Assistance For The Hearing Or Speech Impaired (TDD/TTY)***

To assist customers who have hearing difficulties, the DaimlerChrysler Corporation has installed special TDD (Telecommunication Devices for the Deaf) equipment at its Customer Center. Any hearing or speech impaired customer who has access to a TDD or a

conventional teletypewriter (TTY) in the United States can communicate with the DaimlerChrysler Corporation by dialing 1-800-380-CHRY.

***Service Contract***

You may have purchased a service contract for your vehicle to help protect you from the high cost of unexpected repairs after your DaimlerChrysler Corporation's new vehicle limited warranty expires. The DaimlerChrysler Corporation stands behind only the DaimlerChrysler Corporation's Service Contracts. If you purchased a DaimlerChrysler Corporation Service Contract, you will receive Plan Provisions and an Owner Identification Card in the mail within three weeks of your vehicle delivery date. If you have any questions about your service contract, call the DaimlerChrysler Corporation Service Contract National Customer Hotline at 1-800-521-9922.

The DaimlerChrysler Corporation will not stand behind any service contract that is not the DaimlerChrysler Corporation's Service Contract. It is not responsible for any service contract other than the DaimlerChrysler

Corporation's Service Contract. If you purchased a service contract that is not a DaimlerChrysler Corporation Service Contract, and you require service after your DaimlerChrysler Corporation's new vehicle limited warranty expires, please refer to your contract documents, and contact the person listed in those documents.

We appreciate that you have made a major investment when you purchased your new Crossfire. Your dealer has also made a major investment in facilities, tools, and training to assure that you are absolutely delighted with your ownership experience. You'll be pleased with their sincere efforts to resolve any warranty issues or related concerns.

**WARRANTY INFORMATION**

See your DaimlerChrysler Corporation Warranty Information Booklet for more information on warranty coverage and transfer of warranty.

DESCRIPTION	1 Yr/ 12,000	2 Yr/ 24,000	3 Yr/ 36,000	3 Yr/ 50,000	3 Yr/ Unimtd	5 Yr/ 100,000	7 Yr/ 70,000	8 Yr/ 80,000
Basic Limited Warranty Coverage								
<b>Special Extended Warranty Coverage</b>								
Powertrain Limited Warranty (\$100 deductible)				1st Owner & 2nd Owner with Paid Powertrain Transfer				
	2nd Owner if Powertrain Not Transferred and 3rd (And After) Owners							
Anti-Corrosion Perforation Limited Warranty: All Panels								
Outer Panels								
Federal Emission Warranty								
Federal Emission Warranty - Specified Components								
California Emission Warranty								
California Emission Warranty - Specified Components								

**NOTE:** Vehicles used as a police vehicle, taxi, limousine, postal delivery vehicle, ambulance or rental vehicle are covered only under the 3 year/36,000 mile Basic Limited Warranty.

8132c269

### **MOPAR® PARTS**

Mopar® fluids, lubricants, parts, and accessories are available from your authorized dealer. They will help you keep your vehicle operating at its best.

### **REPORTING SAFETY DEFECTS**

In the 50 states of the United States and Washington, D.C.: If you believe that your vehicle has a defect which could cause a crash or cause injury or death, you should immediately inform the National Highway Traffic Safety Administration (NHTSA) in addition to notifying the DaimlerChrysler Corporation.

If NHTSA receives similar complaints, it may open an investigation, and if it finds that a safety defect exists in a group of vehicles, it may order a recall and remedy campaign. However, NHTSA cannot become involved in individual problems between you, your dealer, and the DaimlerChrysler Corporation.

To contact NHTSA, you may either call the Auto Safety Hotline toll-free at 1-800-424-9393 (or 366-0123 in Washington, D.C. area) or write to: NHTSA, U.S. Dept. of

Transportation, Washington, D.C. 20590. You can also obtain other information about motor vehicle safety from the Hotline.

### **In Canada:**

If you believe that your vehicle has a safety defect, you should contact the Customer Service Department immediately. Canadian customers who wish to report a safety defect to the Canadian government should write to Transport Canada, P.O. Box 8880, Ottawa Postal Station, Ottawa, Ontario K1G 3J2.

### **PUBLICATION ORDER FORMS**

To order the following manuals, you may use either the website or the phone numbers listed below. Visa, Mastercard, American Express, and Discover orders are accepted. If you prefer mailing your payment, please call for an order form.

**NOTE:** A street address is required when ordering manuals. (No P.O. Boxes).



- *Service Manuals.*

These comprehensive service manuals provide the information that students and professional technicians need in diagnosing/troubleshooting, problem solving, maintaining, servicing and repairing DaimlerChrysler Corporation vehicles. A complete working knowledge of the vehicle, system and/or components is written in straightforward language with illustrations, diagrams and charts.

- *Owner's Manuals.*

These manuals have been prepared with the assistance of service and engineering specialists to acquaint you with specific Chrysler group vehicles. Included are starting, operating, emergency and maintenance procedures as well as specifications, capabilities and safety tips.

Call Toll Free at **1-800-890-4038 (U.S.)** or **1-800-387-1143 (Canada)**

Or

Visit us on the World Wide Web at:

[www.techauthority.daimlerchrysler.com](http://www.techauthority.daimlerchrysler.com)

or

[www.daimlerchrysler.ca/manuals](http://www.daimlerchrysler.ca/manuals)

#### **DEPARTMENT OF TRANSPORTATION UNIFORM TIRE QUALITY GRADES**

The following describes the tire grading categories established by the National highway Traffic Safety Administration. The specific grade rating assigned by the tire's manufacturer in each category is shown on the sidewall of the tires on your car.

All Passenger Car Tires Must Conform to Federal Safety Requirements in Addition to These Grades.

#### **Treadwear**

The treadwear grade is a comparative rating based on the wear rate of the tire when tested under controlled conditions on a specified government test course. For example, a tire graded 150 would wear one and a half

(1 1/2) times as well on the government course as a tire graded 100. The relative performance of tires depends upon actual conditions of their use, however, and may depart significantly from the norm due to variations in driving habits, service practices and differences in road characteristics and climate.

#### **Traction Grades**

The traction grades, from highest to lowest, are A, B, and C, and they represent the tire's ability to stop on wet pavement as measured under controlled conditions on specified government test surfaces of asphalt and concrete. A tire marked C may have poor traction performance.

#### **WARNING!**

##### **WARNING!**

The traction grade is based on braking (straight ahead) traction tests and does not include cornering (turning) performance.

#### **Temperature Grades**

The temperature grades are A (highest), B, and C, representing the tire's resistance to the generation of heat and its ability to dissipate heat when tested under controlled conditions on a specified indoor laboratory test wheel. Sustained high temperature can cause the material of the tire to degenerate and reduce tire life, and excessive temperature can lead to sudden tire failure. The grade C corresponds to a level of performance which all passenger car tires must meet under the Federal Motor Vehicle Safety Standard No. 109. Grades B and A represent higher levels of performance on the laboratory test wheel than the minimum required by law.

#### **WARNING!**

The temperature grade is established for a tire that is properly inflated and not overloaded. Excessive speed, underinflation, or excessive loading, either separately or in combination, can cause heat buildup and possible tire failure.

---

# INDEX

- ABS (Anti-Lock Brake) System . . . . . 93  
Adding Engine Coolant (Antifreeze) . . . . . 195  
Adding Fuel . . . . . 152  
Aiming Headlights . . . . . 215  
Air Cleaner, Engine . . . . . 185  
Air Conditioning . . . . . 110,188  
Air Conditioning Filter . . . . . 234  
Air Conditioning Refrigerant . . . . . 188  
Air Conditioning System . . . . . 188  
Air Pressure, Tires . . . . . 141  
Airbag . . . . . 26  
Airbag Deployment . . . . . 30  
Airbag Light . . . . . 29,98  
Airbag Maintenance . . . . . 36  
Airbag On/Off Switch . . . . . 33,38  
Alignment and Balance . . . . . 149  
Antenna . . . . . 110  
Antifreeze (Engine Coolant) . . . . . 220  
Anti-Lock Warning Light . . . . . 93  
Appearance Care . . . . . 201  
Ashtrays and Lighter . . . . . 51  
Automatic Door Locks . . . . . 13  
Automatic Transmission . . . . . 123,199  
Fluid and Filter Changes . . . . . 200  
Fluid Level Check . . . . . 200  
Fluid Type . . . . . 199  
Special Additives . . . . . 201  
Autostick . . . . . 126  
Ball Joints . . . . . 190  
Battery . . . . . 94,187  
    Saving Feature . . . . . 61  
Belts, Drive . . . . . 184  
Belts, Seat . . . . . 20  
Body Mechanism Lubrication . . . . . 190  
Brake Assist System . . . . . 73  
Brake, Parking . . . . . 130  
Brake System . . . . . 131,197  
    Anti-Lock . . . . . 131  
    Hoses . . . . . 197  
    Master Cylinder . . . . . 198  
Break-In Recommendations, New Vehicle . . . . 43,139  
Bulbs, Light . . . . . 212  
Capacities, Fluid . . . . . 218  
Capacity, Cargo Weight . . . . . 154

- Carbon Monoxide Warning . . . . . 44
- Cargo Compartment
  - Capacity . . . . . 154
- Catalytic Converter . . . . . 185
- CD Player . . . . . 101,106
- Chains, Tire . . . . . 143
- Changing A Flat Tire . . . . . 160
- Charging System Light . . . . . 94
- Checks, Safety . . . . . 44
- Child Restraint . . . . . 36
- Child Restraint Tether Anchors . . . . . 42
- Cigar Lighter . . . . . 52
- Circuit Breakers . . . . . 206
- Clean Air Gasoline . . . . . 150
- Cleaning
  - Glass . . . . . 205
  - Headlights . . . . . 204
- Climate Control . . . . . 110
- Coin Holder . . . . . 52
- Compact Disc Maintenance . . . . . 109
- Console . . . . . 49
- Contract, Service . . . . . 238
- Converter, Catalytic . . . . . 163
- Coolant . . . . . 194,233
- Cooling System . . . . . 193
  - Adding Coolant (Antifreeze) . . . . . 195
  - Coolant Level . . . . . 193
  - Disposal of Used Coolant . . . . . 194
  - Drain, Flush, and Refill . . . . . 194
  - Points to Remember . . . . . 195,196
  - Pressure Cap . . . . . 195
  - Rubber and Plastic Components . . . . . 197
  - Selection of Coolant . . . . . 194
- Corrosion Protection . . . . . 201
- Crankcase Emission Control System . . . . . 187
- Cup Holder . . . . . 53
- Customer Assistance . . . . . 236
- Cylinders, Lock . . . . . 190
- Dealer Service . . . . . 180
- Defroster, Windshield . . . . . 45
- Disposal
  - Engine Oil . . . . . 184
- Door Locks, Automatic . . . . . 13
- Drive Belts . . . . . 184
- Drive Shaft Universal Joints . . . . . 190

- Driving  
  On Slippery Surfaces . . . . . 169
- Electronic Speed Control . . . . . 77
- Electronic Stability Program . . . . . 74
- Emergency, In Case of  
  Hazard Warning Flasher . . . . . 158  
  Jump Starting . . . . . 167  
  Overheating . . . . . 158  
  Towing . . . . . 170
- Emission Control System Maintenance . . . . 179,227
- Engine  
  Break-In Recommendations . . . . . 43  
  Checking Oil Level . . . . . 181  
  Compartment . . . . . 177  
  Oil . . . . . 181,220  
  Oil Change Interval . . . . . 183  
  Oil Selection . . . . . 184
- Exhaust Gas Caution . . . . . 44
- Exhaust System . . . . . 192
- Exterior Lights . . . . . 212
- Filters  
  Air Cleaner . . . . . 185  
  Air Conditioning . . . . . 234  
  Engine Fuel . . . . . 185  
  Engine Oil . . . . . 184
- Fluid Capacities . . . . . 218,220
- Fluid Leaks . . . . . 45
- Fluid Level Checks  
  Manual Transmission . . . . . 200
- Four-Way Hazard Flasher . . . . . 158
- Freeing A Stuck Vehicle . . . . . 170
- Fuel . . . . . 149  
  Adding . . . . . 152  
  Additives . . . . . 151  
  Filler Cap . . . . . 152  
  Filter . . . . . 185  
  Octane Rating . . . . . 149
- Fuses . . . . . 206
- Garage Door Opener . . . . . 80
- Gas Cap . . . . . 152
- Gasoline . . . . . 220
- Gasoline/Oxygenate Blends . . . . . 150

Gear Ratios . . . . .	218	Instrument Panel Cover . . . . .	205
Glass Cleaning . . . . .	205	Instrument Panel Lens Cleaning . . . . .	205
Glove Compartment . . . . .	53	Interior Appearance Care . . . . .	204
Hazard Warning Flasher . . . . .	158	Introduction . . . . .	4
Headlights		Jack Location . . . . .	164
Aiming . . . . .	215	Jack Operation . . . . .	160
Cleaning . . . . .	204	Jump Starting . . . . .	167
Dimmer Switch . . . . .	65	Key-In Reminder . . . . .	10
Heater . . . . .	110	Keyless Entry System . . . . .	14
Hood Latch Maintenance . . . . .	190	Keys . . . . .	9
Hood Release . . . . .	59	Knee Bolster . . . . .	26
Hoses . . . . .	197	Lap/Shoulder Belts . . . . .	21
Ignition		Light Bulbs . . . . .	212
Key . . . . .	9	Lights	
Wiring System . . . . .	187	Airbag . . . . .	29,98
Illuminated Entry . . . . .	61	Anti-Lock Warning . . . . .	93
Infant Restraint . . . . .	37	Back-Up . . . . .	214
Inflation Pressure Tires . . . . .	141	Daytime Running . . . . .	62
Inside Rearview Mirror . . . . .	54	Exterior . . . . .	62
Instrument Cluster . . . . .	89	Exterior Check . . . . .	45
Instrument Panel and Controls . . . . .	88		

Fog	63	Fluid Level Check	200
Hazard Warning Flasher	158	Frequency of Fluid Change	201
Headlights	62	Lubricant Selection	200
Instrument Cluster	61	Marker Lights, Side	214
Interior	60,212	Master Cylinder	198
License	215	Mirrors	54
Lights On Reminder	62	Electric Powered	56
Malfunction Indicator	99	Electric Remote	55
Map Reading	61	Exterior Folding	55
Park	62,214	Heated	55
Rear Tail	214	Outside	55
Seat Belt Reminder	94	Rearview	54
Turn Signal	214	Vanity	57
Loading Vehicle		Monitor, Tire Pressure System	68,142
Capacities	154	Mopar Parts	180,240
Lubrication, Body	190	Multi-Function Control Lever	64
Maintenance Free Battery	187	Occupant Restraints	20
Maintenance Procedures	181	Oil, Engine	181
Maintenance Schedules	227	Change Interval	183
Malfunction Indicator Light	99,179	Checking	181
Manual, Service	240	Disposal	184
Manual Transmission	121,200	Filter	184



Materials Added to	184	Radio Operation	110
Recommendation	184	Rear Liftgate	19
Oil Filter, Selection	184	Rear Spoiler	71
Onboard Diagnostic System	178,179	Recommended Fluids, Lubricants and Genuine Parts	221
Overheating, Engine	158	Reformulated Gasoline	150
Owner's Manual	240	Refrigerant	188
Paint Care	201	Remote Keyless Entry	14
Parking Brake	130	Replacement Tires	146
Passing Light	65	Reporting Safety Defects	240
Pets	43	Residual Engine Heat Utilization (REST)	115
Pets, Transporting	43	Restraints, Child	36
Power		Restraints, Infant	37
Outlet	52	Restraints, Occupant	20
Steering	139,189	Rotation, Tires	147
Steering, Checking	189	Safety Checks Inside Vehicle	44
Windows	18	Safety Checks Outside Vehicle	45
Pregnant Women and Seat Belts	25	Safety Tips	44
Program Mode Selector Switch	128	Schedule, Maintenance	227
Programming Transmitters	83,84	Seat Belts	20
Radio	101	And Pregnant Women	25
Radio Antenna	110	Extender	25

Inspection	44	Storage	216
Maintenance	205	Storage Bin	49
Operating Instructions	22	Stuck, Freeing	170
Reminder	94	Sulfur in Gasoline	151
Seats	57	Supplemental Restraint System - Airbag	26
Cleaning	204	Telescoping Steering Column	67
Service Assistance	236	Temperature Gauge, Engine Coolant	159
Service Contract	238	Theft Alarm	17
Service Manuals	240	Theft System	17
Shift Speeds	121,122	TIREFIT	160
Slippery Surfaces, Driving On	169	Tires	140,241
Snow Chains	143	Air Pressure	141
Snow Tires	144	Alignment	149
Spark Plugs	185	Balancing	149
Specifications	218	Chains	143
Standing Lights	63	Changing	160,164
Starting	119	Inflation Pressures	141
Cold Weather	120	Pressure Monitor System	68,142
Emergency (Jump Starting)	167	Quality Grading	241
Engine Fails to Start	120	Replacement	146
Steering		Rotation	147
Linkage	190	Safety	45
Power	139		

Snow Tires	144	Vacuum/Vapor Harnesses	197
Spinning	143	Vehicle Identification Number	6
Tread Wear Indicators	145	Vehicle Loading	154
Tow-Away Alarm	17,174	Vehicle Storage	216
Towing	170	Vehicle Theft Alarm	17
Disabled Vehicle	170	Warnings and Cautions	6
Trailer	155	Warranty Information	239
Towing Eyes	171	Washer, Adding Fluid	192
Traction	169	Washing Vehicle	202
Trailer Towing	155	Wheel and Wheel Trim Care	203
Transmission		Windows	
Automatic	123,199	Power	18
Fluid	199	Windshield Defroster	45
Manual	121,200	Windshield Washers	66
Shifting	121,122	Windshield Wiper Blades	191
Transporting Pets	43	Windshield Wipers	66
Tread Wear Indicators	145	Wiper Blade Replacement	191
Turn Signals	64	Wiring, Ignition	187
Umbrella Hook	85		
Uniform Tire Quality Grades	241		
Universal Transmitter	81,84		

## Free Manuals Download Website

<http://myh66.com>

<http://usermanuals.us>

<http://www.somanuals.com>

<http://www.4manuals.cc>

<http://www.manual-lib.com>

<http://www.404manual.com>

<http://www.luxmanual.com>

<http://aubethermostatmanual.com>

Golf course search by state

<http://golfingnear.com>

Email search by domain

<http://emailbydomain.com>

Auto manuals search

<http://auto.somanuals.com>

TV manuals search

<http://tv.somanuals.com>