

Notice to Installers

The servicing instructions in this notice are for use by qualified service personnel only. To reduce the risk of electric shock, do not perform any servicing other than that contained in the operating instructions, unless you are qualified to do so.

Note to System Installer

For this apparatus, the coaxial cable shield/screen shall be grounded as close as practical to the point of entry of the cable into the building. For products sold in the US and Canada, this reminder is provided to call the system installer's attention to Article 820-93 and Article 820-100 of the NEC (or Canadian Electrical Code Part 1), which provides guidelines for proper grounding of the coaxial cable shield.



This symbol is intended to alert you that uninsulated voltage within this product may have sufficient magnitude to cause electric shock. Therefore, it is dangerous to make any kind of contact with any inside part of this product.

Ce symbole a pour but d'alerter toute personne qu'un contact avec une pièce interne de ce produit, sous tension et non isolée, pourrait être suffisant pour provoquer un choc électrique. Il est donc dangereux d'être en contact avec toute pièce interne de ce produit.



CAUTION
RISK OF ELECTRIC SHOCK
DO NOT OPEN



AVIS
RISQUE DE CHOC ÉLECTRIQUE
NE PAS OUVRI

CAUTION: To reduce the risk of electric shock, do not remove cover (or back). No user-serviceable parts inside. Refer servicing to qualified service personnel.

WARNING
TO PREVENT FIRE OR ELECTRIC SHOCK, DO NOT EXPOSE THIS UNIT TO RAIN OR MOISTURE.



This symbol is intended to alert you of the presence of important operating and maintenance (servicing) instructions in the literature accompanying this product.

Ce symbole a pour but de vous avertir qu'une documentation importante sur le fonctionnement et l'entretien accompagne ce produit.

20070131 SysInstaller 820 US/Canada/Intl

IMPORTANT SAFETY INSTRUCTIONS

Read These Instructions

Keep These Instructions

Heed All Warnings

Follow All Instructions

Power Source Warning

A label on this product indicates the correct power source for this product. Operate this product only from an electrical outlet with the voltage and frequency indicated on the product label. If you are uncertain of the type of power supply to your home or business, consult your service provider or your local power company.

The AC inlet on the unit must remain accessible and operable at all times.

Ground the Product

**WARNING: Avoid electric shock and fire hazard! Do not defeat the safety purpose of the polarized or grounding-type plug. A polarized plug has two blades with one wider than the other. A grounding-type plug has two blades and a third grounding prong. The wide blade or the third prong is provided for your safety. If the provided plug does not fit into your outlet, consult an electrician for replacement of the obsolete outlet.**

If this product connects to coaxial cable wiring, be sure the cable system is grounded (earthed). Grounding provides some protection against voltage surges and built-up static charges.

Outdoor Grounding System

If this product connects to an outdoor antenna or cable system, be sure the antenna or cable system is grounded (earthed). This provides some protection against voltage surges and built-up static charges.

Article 810 of the National Electric Code (NEC) ANSI/NFPA No. 70-1990, provides the following information:

- Grounding of the mast and supporting structure
- Grounding the lead-in wire to an antenna discharge unit
- Size of the grounding conductors
- Location of the antenna-discharge unit
- Connection to grounding electrodes
- Requirements for the grounding electrodes (see the following antenna grounding diagram as recommended by NEC ANSI/NFPA 70)

**WARNING: Avoid electric shock and fire hazard! Do not locate an outside antenna system in the vicinity of overhead power lines or power circuits. Touching power lines or circuits might be fatal.**

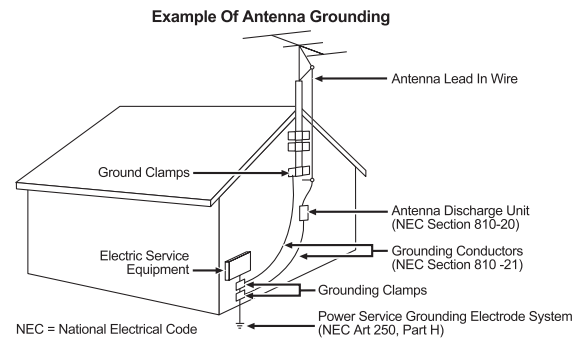

T11518

Protect the Product from Lightning

For added protection, unplug this apparatus during lightning storms or when unused for long periods of time. In addition to disconnecting the AC power from the wall outlet, disconnect the signal inputs.

Verify the Power Source from the On/Off Power Light

When the on/off power light is not illuminated, the apparatus may still be connected to the power source. The light goes out when the apparatus is turned off, regardless of whether it is still plugged into an AC power source.

Eliminate AC Mains Overloads

**WARNING: Avoid electric shock and fire hazard! Do not overload AC mains, outlets, extension cords, or integral convenience receptacles. For products that require battery power or other power sources to operate them, refer to the operating instructions for those products.**

Prevent Power Cord Damage

Protect the power cord from being walked on or pinched, particularly at plugs, convenience receptacles, and the point where the cord exits from the apparatus.

Provide Ventilation and Select a Location

- Do not block any ventilation openings. Install in accordance with the manufacturer's instructions.
- Do not place this apparatus on a bed, sofa, rug, or similar surface.
- Do not place this apparatus on an unstable surface.
- Do not install near any heat sources such as radiators, heat registers, stoves, or other apparatus (including amplifiers) that produce heat.
- Do not install this apparatus in an enclosure, such as a bookcase or rack, unless the installation provides proper ventilation.
- Do not place entertainment devices (such as VCRs or DVDs), lamps, books, vases with liquids, or other objects on top of this product.

Protect from Exposure to Moisture and Foreign Objects

Do not use this apparatus near water.

**WARNING: Avoid electric shock and fire hazard! Do not expose this product to liquids, rain, or moisture.**

**WARNING: Avoid electric shock and fire hazard! Unplug this product before cleaning. Clean only with a dry cloth. Do not use a liquid cleaner or an aerosol cleaner. Do not use a magnetic/static cleaning device (dust remover) to clean this product.**

**WARNING: Avoid electric shock and fire hazard! Never push objects through the openings in this product. Foreign objects can cause electrical shorts that can result in electric shock or fire.**

Accessories Warnings

**WARNING: Avoid electric shock and fire hazard! Only use attachments/accessories specified by your service provider or the manufacturer.**

Service Warnings

**WARNING: Avoid electric shock! Do not open the cover of this product. Opening or removing the cover may expose you to dangerous voltages. If you open the cover, your warranty will be void. This product contains no user-serviceable parts. Refer all servicing to qualified service personnel.**

Servicing is required when the apparatus has been damaged in any way, such as a power-supply cord or plug is damaged, liquid has been spilled or objects have fallen into the apparatus, the apparatus has been exposed to rain or moisture, does not operate normally, or has been dropped.

Check Product Safety

Upon completion of any service or repairs to this product, the service technician must perform safety checks to determine that this product is in proper operating condition.



Cisco Explorer 4540HDC and 4550HDC Set-Top with Multi-Stream CableCARD Interface



Protect the Product when Moving It

Always disconnect the power source when moving the apparatus or connecting or disconnecting cables.

**WARNING: Avoid personal injury and damage to this product! Use only with the cart, stand, tripod, bracket, or table specified by the manufacturer or sold with the apparatus. When a cart is used, use caution when moving the cart / apparatus combination to avoid injury from tip-over.**

20070802 Set-Top Cable US & Canada

United States FCC Compliance

This device has been tested and found to comply with the limits for a Class B digital device, pursuant to part 15 of the FCC Rules. These limits are designed to provide reasonable protection against such interference in a residential installation. This equipment generates, uses, and can radiate radio frequency energy. If not installed and used in accordance with the instructions, it may cause harmful interference to radio communications. However, there is no guarantee that interference will not occur in a particular installation. If this equipment does cause harmful interference to radio or television reception, which can be determined by turning the equipment OFF and ON, the user is encouraged to try to correct the interference by one or more of the following measures:

- Reorient or relocate the receiving antenna.
- Increase the separation between the equipment and receiver.
- Connect the equipment into an outlet on a circuit different from that to which the receiver is connected.
- Consult the cable company or an experienced radio/television technician for help.

Any changes or modifications not expressly approved by Scientific-Atlanta, Inc., could void the user's authority to operate the equipment.

The information shown in the FCC Declaration of Conformity paragraph below is a requirement of the FCC and is intended to supply you with information regarding the FCC approval of this device. *The phone numbers listed are for FCC-related questions only and not intended for questions regarding the connection or operation for this device. Please contact your cable service provider for any questions you may have regarding the operation or installation of this device.*

FCC Declaration of Conformity

This device complies with Part 15 of FCC Rules. Operation is subject to the following two conditions: 1) the device may not cause harmful interference, and 2) the device must accept any interference received, including interference that may cause undesired operation.

Explorer 4540HDC and 4550HDC
Models: 4540HDC and 4550HDC
Manufactured by: Scientific-Atlanta, Inc.
5030 Sugarloaf Parkway
Lawrenceville, Georgia 30044 USA
Telephone: 770-236-1077

Canada EMI Regulation

This Class B digital apparatus complies with Canadian ICES-003.
Cet appareil numérique de la class B est conforme à la norme NMB-003 du Canada.

20060628 FCC Standard



Scientific Atlanta, A Cisco Company
5030 Sugarloaf Parkway, Box 465447
Lawrenceville, GA 30042

770.236.5000

www.scientificatlanta.com

Cisco, Cisco Systems, the Cisco logo, the Cisco Systems logo, Scientific Atlanta, and Explorer are registered trademarks or trademarks of Cisco Systems, Inc. and/or its affiliates in the U.S. and certain other countries.

CableCARD and M-Card are trademarks of Cable Television Laboratories, Inc.
HDMI, the HDMI logo, and High-Definition Multimedia Interface are trademarks or registered trademarks of HDMI Licensing LLC.

All other trademarks mentioned in this document are the property of their respective owners.

Product and service availability is subject to change without notice.

© 2007, 2008 Cisco Systems, Inc. All rights reserved.

March 2008 Printed in United States of America Part Number 4012225 Rev B

Welcome

The Cisco Explorer 4540HDC (digital-only tuning) and 4550HDC (analog and digital tuning) set-tops deliver high-definition programming with exceptional picture and audio quality. Through the 4540HDC and 4550HDC you can also access interactive services, such as video-on-demand and pay-per-view programs. Contact your service provider for information about these and other available services. Use the instructions in this guide to install the 4540HDC or the 4550HDC and to access your program services.

The consumer support website provides news and information about this product. For more information, please refer to www.scientificatlanta.com/products/consumers/new_cableboxes.htm

Safety First

Before using this set-top, read the IMPORTANT SAFETY INSTRUCTIONS section of this guide.

Watch TV

Press the following remote control keys to access services and programs:

- Guide—Display the on-screen program guide
- Arrows—Highlight a program in the schedule
- Info—Display program description
- Select—Watch a specific program in the guide

Avoid Screen Burn-In

Images such as letterbox bars or side bars, bright closed-captioning backgrounds, station logos, or any other stationary images may cause the HDTV screen to age unevenly and cause damage to your HDTV. Refer to the user's guide that came with your HDTV for more information about screen burn-in.

Automatic Software Updates

A message appears on the TV screen when the set-top and the Multi-Stream CableCARD™ (M-Card™) module are receiving software updates. In addition, download information also appears on the front panel of the set-top during these updates. Wait for the current time to display on the front panel before continuing. When the time appears, the update is complete.

Performance Tips

If the set-top does not perform as expected, the following tips may help.

No picture

- Verify that the M-Card module is installed.
- Verify that the power to your TV is turned on.
- If the set-top is plugged into a wall switch, verify the switch is in the ON position. (Avoid plugging into an outlet that is controlled by a wall switch.)
- Verify that all cables are properly connected.
- The current channel may not be available in your service package. Try selecting another channel to see if a picture appears.

No color

- Verify that the HDTV is in HD mode. If necessary, re-run the HDTV Setup Wizard to select HD mode.
- Verify the current TV program is broadcast in color.
- Adjust the TV color controls.

No sound

- If your setup includes a VCR or stereo, verify that you have properly connected them to the set-top.
- Verify the volume is turned up.
- Verify the mute function is not on.

Front Panel Features

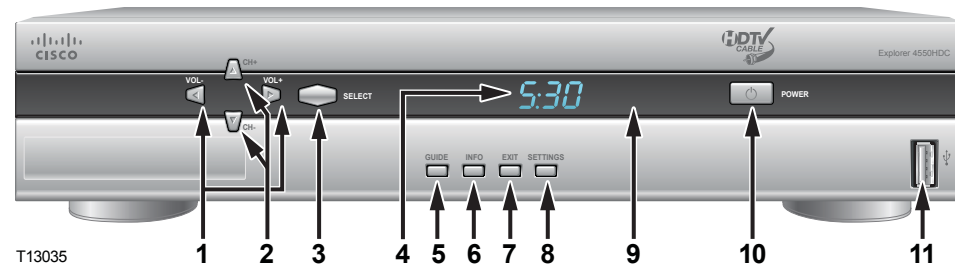

T13035

- | | |
|---|--|
| <p>1 VOL +, VOL -
 2 CH+, CH -
 3 Select
 4 LED Display</p> <p>5 Guide
 6 Info
 7 Exit
 8 Settings
 9 IR Sensor
 10 Power
 11 USB Port</p> | <p>Increases and decreases the volume</p> <p>Scrolls up and down through the channels</p> <p>Provides access to your on-screen selection</p> <p>Displays the selected channel number and time of day. The LED also displays the following:</p> <ul style="list-style-type: none"> • Message () • HDTV • Power () • Output Resolution (1080i, 720p, 480p, or 480i) • AUTO - Automatically outputs native scan rates that your TV can accept <p>Accesses on-screen services, such as the on-screen guide, video-on-demand, or pay-per-view</p> <p>Displays a description of the selected program. This button is available from the on-screen guide and while viewing a program</p> <p>Exits menus, the on-screen guide, and program information</p> <p>Provides access to the Settings menu</p> <p>Receives the infrared signal from the remote control</p> <p>Turns the set-top on and off</p> <p>Connects to external equipment, such as a keyboard or mouse (reserved for future use)</p> |
|---|--|

Note: This illustration may vary from the actual product.

Safety and Performance Tips

- Keep the top of the set-top free of all objects and electronic devices, including your TV.
- Always set the set-top on its feet, never on its side.

Back Panel Connections

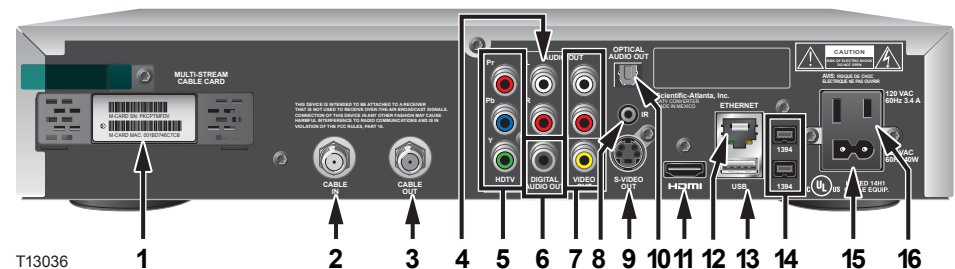

T13036

- | | |
|--|---|
| <p>1 Multi-Stream CableCARD
 2 Cable In
 3 Cable Out
 4 Audio Out (Left, Right)
 5 HDTV (PrPbY/V)
 6 Digital Audio Out
 7 Out 2 (Secondary Video/Audio Out)
 8 IR
 9 S-Video Out
 10 Optical Audio Output
 11 HDMI
 12 Ethernet
 13 USB
 14 1394 Firewire
 15 AC Power Input
 16 AC Outlet</p> | <p>Slot for M-Card module, which decrypts subscription digital channels. This set-top will not operate correctly without an M-Card module. Obtain an M-Card module from your service provider</p> <p>Connects to a coaxial cable that delivers the signal from your service provider</p> <p>Connects to a coaxial cable that sends analog audio and video signals to a TV or VCR. These signals are standard-definition TV (SDTV) video and stereo audio</p> <p>Connects to RCA cables that send analog audio signals (left and right) to the stereo inputs on a TV</p> <p>Connects to the component video input (YPbPr) on the HDTV, when in HD mode</p> <p>Connects to an RCA cable that sends a digital audio signal to a surround-sound receiver or other digital audio device</p> <p>Connects to either a VCR or to another set of inputs (composite) on your TV</p> <p>Connector reserved for future use</p> <p>Connects to an S-Video cable that sends an S-Video signal to your TV or VCR. This signal is standard definition, but higher quality than other SDTV connections</p> <p>Connects to an optical cable that sends a digital audio signal to a surround-sound receiver or other digital audio device</p> <p>Connects an HDMI™ cable to the HDMI input of an HDTV. HDMI supports both digital audio and video. May be used to connect to a DVI interface using an HDMI-to-DVI adaptor for video and separate audio connections. Any of the following audio connections may be used: Audio Out: Left, Right (4); Digital Audio Out (6); or Optical Audio Output (10)</p> <p>Connects to an Ethernet network</p> <p>Connects to external USB devices such as a keyboard or a mouse</p> <p>Connects to display devices that are equipped with a 1394 input</p> <p>Connects to the power cord to deliver power to the set-top</p> <p>Connects to the AC power cord from another device, such as a TV</p> |
|--|---|

Note: This illustration may vary from the actual product.

Connecting to an HDTV with Component Input (YPbPr)

Use the connection diagram and follow these steps to connect the set-top to an HDTV that has a component video connector (YPbPr) and an audio left/right connector.

1. Insert the M-Card module if not already installed.
2. Connect the set-top to the coaxial cable coming from the wall.
3. Connect the Y (green) connector on the HDTV to the Y (green) connector on the set-top; connect the Pb (blue) connector on the HDTV to the Pb (blue) connector on the set-top; and connect the Pr (red) connector on the HDTV to the Pr (red) connector on the set-top.
4. Connect the left audio (white) connector on the HDTV to the left audio (white) connector on the set-top, and connect the right audio (red) connector on the HDTV to the right audio (red) connector on the set-top.
5. Plug the set-top and the HDTV into an AC power source.

Important: To potentially protect the set-top from power surge damage, ground (earth) your cable product to provide some protection against voltage surges and built-up static charges. You may be able to reduce the risk of damage from voltage surges, which can be caused by lightning storms and power outages, by plugging the set-top into a surge protector.

6. Wait several minutes for the set-top to receive the latest software, programming, and service information. When you see one of the following displays on the front panel of the set-top, that indicates that the update is complete:

- Current time
- Four dashes (----

Note: If four dashes are displayed, you must call your service provider to get the set-top authorized.

7. To begin watching TV, turn on the HDTV and press Power on the front panel of the set-top, or press Power on the remote control.

Explorer 4540HDC and 4550HDC

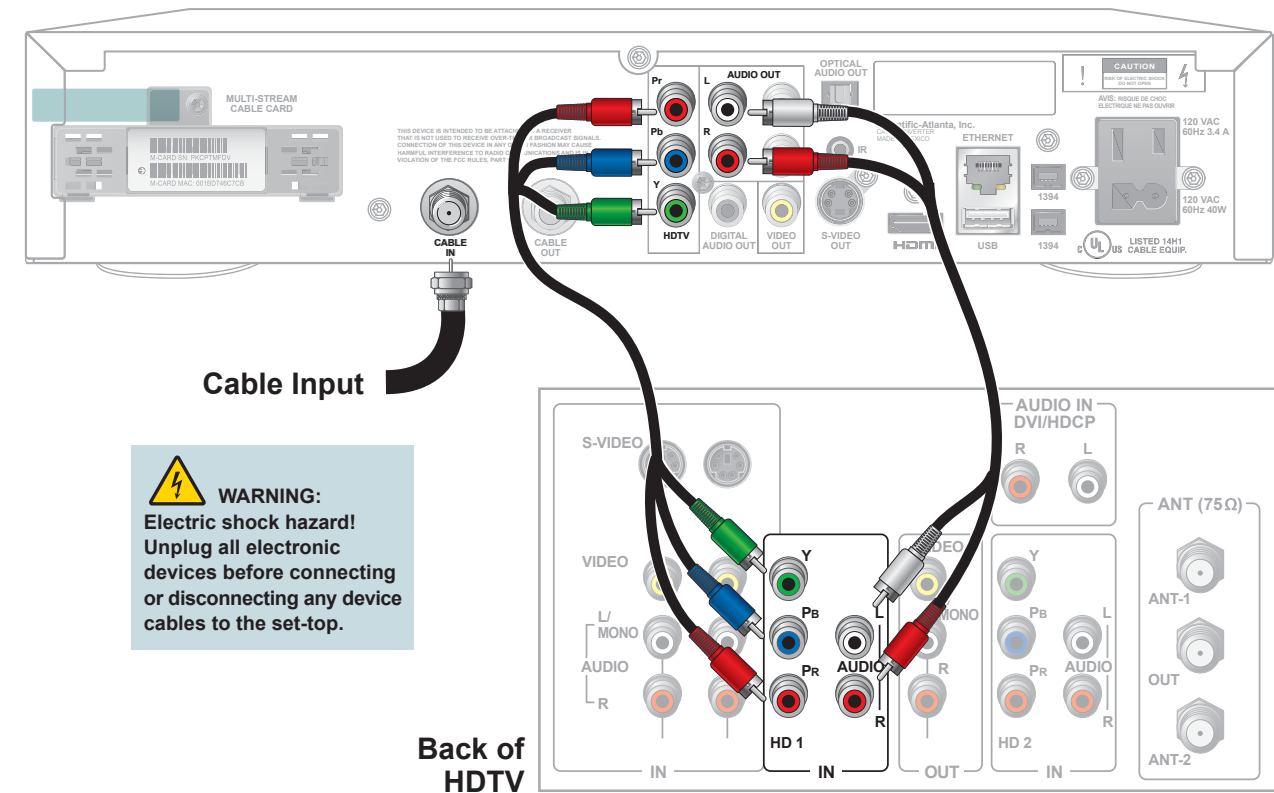

T13037

U.S. Patents

A patent notice is affixed to this product. In addition, the product may also be covered by one or more of the following patents:

4,498,169; 4,692,919; 4,748,667; 4,829,569; 4,866,770; 4,885,775; 4,888,799; 4,890,319; 4,922,456; 4,922,532; 4,924,498; 4,965,534; 4,991,011; 5,003,384; 5,012,510; 5,029,207; 5,045,816; 5,053,883; 5,054,071; 5,058,160; 5,142,575; 5,142,690; 5,146,526; 5,155,590; 5,214,390; 5,225,902; 5,225,925; 5,235,619; 5,237,610; 5,239,540; 5,241,610; 5,247,364; 5,255,086; 5,257,403; 5,267,071; 5,270,809; 5,271,041; 5,272,752; 5,282,028; 5,285,497; 5,287,351; 5,301,028; 5,309,514; 5,317,391; 5,319,709; 5,341,425; 5,347,388; 5,347,389; 5,357,276; 5,359,601; 5,361,156; 5,367,571; 5,379,141; 5,379,145; 5,381,481; 5,390,337; 5,400,401; 5,406,558; 5,418,782; 5,420,866; 5,420,923; 5,425,101; 5,428,404; 5,430,568; 5,434,610; 5,436,749; 5,438,370; 5,440,632; 5,442,472; 5,455,570; 5,457,701; 5,471,492; 5,477,199; 5,477,262; 5,477,282; 5,477,370; 5,481,389; 5,481,542; 5,485,221; 5,493,339; 5,497,187; 5,500,758; 5,502,499; 5,506,904; 5,519,780; 5,539,822; 5,550,825; 5,579,055; 5,579,057; 5,583,562; 5,592,551; 5,596,606; 5,600,378; 5,602,933; 5,640,388; 5,657,414; 5,675,575; 5,684,876; 5,715,515; 5,724,525; 5,734,822; 5,740,300; 5,742,677; 5,754,940; 5,757,416; 5,771,064; 5,774,859; 5,825,829; 5,826,167; 5,850,305; 5,854,703; 5,870,474; 5,892,607; 5,920,626; 5,923,755; 5,930,024; 5,930,515; 5,937,067; 5,963,352; 5,966,163; 5,982,424; 5,991,139; 5,999,207; 6,005,631; 6,005,938; 6,016,163; 6,028,941; 6,029,046; 6,052,384; 6,055,244; 6,072,532; 6,105,134; 6,148,039; 6,157,719; 6,188,729; 6,195,389; 6,212,278; 6,215,530; 6,219,358; 6,240,103; 6,243,145; 6,246,767; 6,252,964; 6,272,226; 6,292,081; 6,292,568; 6,320,131; 6,374,275; 6,405,239; 6,411,602; 6,417,949; 6,424,714; 6,424,717; 6,433,906; 6,438,139; 6,463,586; 6,467,091; 6,476,878; 6,493,876; 6,510,519; 6,516,002; 6,516,412; 6,526,508; 6,538,595; 6,546,013; 6,560,340; 6,567,118; 6,570,888; 6,622,308; 6,629,227; 6,664,984; 6,667,994; 6,671,879; 6,674,967; 6,678,891; 6,714,598; 6,721,352; 6,721,956; 6,725,459; 6,738,982; 6,744,892; 6,744,967; 6,751,271; 6,760,918; 6,795,972; 6,802,077; 6,804,708; 6,811,447; 6,817,028; 6,822,972; 6,823,385; 6,832,386; 6,845,106; 6,868,473; 6,874,075; 6,889,191; 6,909,471; 6,917,622; 6,917,628; 6,922,412; 6,927,806; 6,928,656; 6,931,058; 6,937,729; 6,969,279; 6,971,008; 6,971,121; 6,978,310; 6,986,156; 6,988,900; 6,996,838; 7,010,801; 7,053,960; 7,065,213; 7,069,578; 7,069,572; D348065; D354959; D359737; D363932; D390217; D434753; D507240; D507535; D513407; D516518; RE36368; RE36988

Free Manuals Download Website

<http://myh66.com>

<http://usermanuals.us>

<http://www.somanuals.com>

<http://www.4manuals.cc>

<http://www.manual-lib.com>

<http://www.404manual.com>

<http://www.luxmanual.com>

<http://aubethermostatmanual.com>

Golf course search by state

<http://golfingnear.com>

Email search by domain

<http://emailbydomain.com>

Auto manuals search

<http://auto.somanuals.com>

TV manuals search

<http://tv.somanuals.com>