

Convection Electric Range
Cuisinière à convection électrique

BERC 24100 SS

User manual
Manuel d'utilisation

Blomberg

⚠ WARNING: If the information in this manual is not followed exactly, a fire or explosion may result causing property damage, personal injury or death.

Anti-Tip stability device

⚠ WARNING:

"A child or adult can tip the range and be killed.

"Failure to do so can result in death or serious burns to children or adults."

Install the anti-tip device to the structure and/or the range."

"Engage the range to the anti-tip device by anti-tip brackets given with oven as shown in Figure.2."

"Re-engage the anti-tip device if the range is moved.

Install anti-tip device packed with range.

See installation instructions.

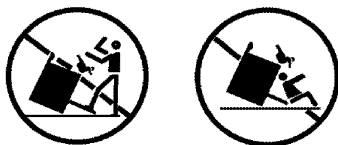

Do not operate the range without anti-tip device in place and engaged.

After installation cautiously grip the rear of the range to ensure the anti-tip bracket is engaging the rear foot of range."

This appliance is intended for normal household use only. It is not approved for outdoor or other non-household uses (including sea or air-going vessels). See the Statement of Limited Warranty. If you have any questions, contact the manufacturer.

Do not repair or replace any part of the appliance unless specifically recommended in this manual. Refer all servicing to a factory authorized service center.

Please read these instructions before installation or using your appliance!

Dear Customer,

We would like you to obtain best performance with your product that has been manufactured in modern facilities and passed through strict quality control procedures.

Therefore, we advise you to read through this user manual carefully before using your product and keep it for future reference. If you hand over the product to someone else, deliver the user manual as well.

The user manual will help you use the product in a fast and safe way.

The instructions will help you to operate the appliance quickly and safely.

- Upon delivery, please check that the appliance is not damaged. If you note any transport damage, please contact your point of sale immediately and do not connect and operate the appliance!
- Before you connect and start using the appliance, please read this manual and all enclosed documents. Please note in particular the safety instructions.
- Keep all documents so that you can refer to the information again later on. Please keep your receipt for any repairs which may be required under warranty.
- When you pass on the appliance to another person, please provide all documents including original date of purchasing. Warranty is not valid if the product is sold second hand.
- If you should decide not to use this appliance any longer (or decide to substitute an older model), before disposing of it, it is recommended that it be made inoperative in an appropriate manner in accordance to health and environmental protection regulations, ensuring in particular that all potentially hazardous parts be made harmless, especially in relation to children who could play with old appliances. Remove the door and the warming drawer before disposal to prevent entrapment.

Explanation of symbols

Throughout this User Manual the following symbols are used:



Important information or useful hints about usage.



Warning for hazardous situations with regard to life and property.



Warning for electric shock.



Warning for risk of fire.



Warning for hot surfaces.

Table of Contents

1 Important Instructions	5	Cooking times table.	23
Basic safety instructions	5	Baking and roasting.	23
Safety for children	7	How to operate the broil	25
Safety when working with electricity.	7	Cooking times table for broiling	26
Intended use	7	How to use the alarm clock.	26
Disposal	8		
Packaging material	8	6 Maintenance and Care	27
Future transportation	8	General information	27
		How to clean the burner/plate	27
2 Installation	9	Cleaning the control panel.	27
Installation and connection	9	Cleaning the oven	27
Clearances & Dimensions	9	Removal of oven door	28
Important notes to the consumer.	9	Replacing the oven lamp.	28
Important Notes to the Installer	11		
Anti-Tip stability device installation		7 General Information	30
instructions	12	Overview	30
Connection to the main supply	12	Technical Data.	31
Backsplash.	13	Accessories supplied with the unit.	32
		Wire shelf	32
3 Preparation	15		
Tips for saving energy	15	8 Troubleshooting	33
Initial operation	15	Electrical equipment	33
Setting the time.	15		
First cleaning of the appliance	16	9 Warranty Statement for	
Initial heating	16	Blomberg electric and gas	
		ranges	34
4 How To Use The Hob	17		
General information on cooking.	17		
Tips for glass ceramic burner/plate	17		
How to use burners/plates	18		
5 How to Operate the Oven	20		
General information on baking, roasting			
and broiling	20		
Tips for baking.	20		
Tips for roasting.	20		
Tips for broiling	20		
How to use the electric oven	20		
How to operate the oven timer	22		

1 Important Instructions

Basic safety instructions

- This appliance is not intended for use by persons (including children) with reduced physical, sensory or mental capabilities, or lack of experience and knowledge, unless they have been given supervision or instruction concerning use of appliance by a person responsible for their safety. Children should be supervised to ensure that they do not play with the appliance.
- Proper installation - Be sure your appliance is properly installed and grounded by a qualified technician
- Never use your appliance for warming or heating the room.
- Wear proper apparel - loose-fitting or hanging garments should never be worn while using the appliance.
- User servicing - Do not repair or replace any part of the appliance unless specifically recommended in the manual. All other servicing should be referred to a qualified technician.
- Use proper pan size - this appliance is equipped with one or more surface units of different size. Select utensils having flat bottoms large enough to cover the surface unit heating element. The use of undersized utensils will expose a portion of the heating element to direct contact and may result in ignition of clothing. Proper relationship of utensil to burner will also improve efficiency.
- Never leave surface units unattended at high heat settings - boilover causes smoking and greasy spillovers that may ignite.
- Protective liners- do not use aluminum foil to line oven bottoms, except as suggested in the manual. Improper installation of these liners may result in a risk of electric shock, or fire.
- Glazed cooking utensils - only certain types of glass, glass/ceramic, ceramic, earthenware, or other glazed utensils are suitable for range-top service without breaking due to the sudden change in temperature.
- Utensil handles should be turned inward and not extend over adjacent surface units - to reduce the risk of burns, ignition of flammable materials, and spillage due to unintentional contact with the utensil, the handle of a utensil should be positioned so that it is turned inward, and does not extend over adjacent surface units.
- Use care when opening door- let hot air or steam escape before removing or replacing food.
- Placement of oven racks -always place oven racks in desired location while oven is cool. If rack must be moved while oven is hot, do not let potholder contact hot heating element in oven.
- Use only dry potholders- moist or damp potholders on hot surfaces may result in burns from steam. Do not let potholder touch hot heating elements. Do not use a towel or other bulky clothes.
- Do not cook on broken cook-top - if cook-top should break, cleaning solutions and spillovers may penetrate the broken cook-top and create a risk of electric shock. Contact a qualified technician immediately.

- **Clean cook-top with caution** - if a wet sponge or cloth is used to wipe spills on a hot cooking area, be careful to avoid steam burn. Some cleaners can produce noxious fumes if applied to a hot surface.
- **"Do not touch surface units or areas near units** - Surface units may be hot even though they are dark in color. Areas near surface units may become hot enough to cause burns. During and after use, do not touch, or let clothing or other flammable materials contact surface units or areas near units until they have had sufficient time to cool. Among these areas are the cook-top and surfaces facing the cook-top."
- **"Do not touch heating elements or interior surfaces of oven** - Heating elements may be hot even though they are dark in color. Interior surfaces of an oven become hot enough to cause burns. During and after use, do not touch, or let clothing or other flammable materials contact heating elements or interior surfaces of oven until they have had sufficient time to cool. Other surfaces of the appliance may become hot enough to cause burns - among these surfaces are oven vent openings and surfaces near these openings, interior surfaces of the oven cavity, oven doors, and window"
- Never use when judgment or coordination is impaired by the use of alcohol and/or drugs.
- Do not operate the appliance if it is defective or shows any visible damage.
- Be careful when using alcoholic drinks in your dishes. Alcohol evaporates in high temperatures and may cause fire since it will catch fire when it gets in contact with hot surfaces.
- Do not heat closed food containers and glass jars. Pressure that may build-up in the jar can cause it to burst.
- Do not use the oven for a storage area. Items stored in an oven can ignite.
- Storage in or on Appliance- Flammable materials should not be stored in an oven or near surface units.
- **Fire risk!** Do not store flammable material in the oven and/or in the warming drawer.
- Keep appliance area clear and free from combustible materials, gasoline, and other flammable vapors.
- **Do not use water on grease fires.** Smother fire or flame or use dry chemical or foam type extinguisher.
- Do not use the oven to dry newspapers. If overheated, they can catch on fire.
- Do not leave paper products, cooking utensils or food in the oven when not in use.
- Do not leave empty pots or pans on plates that are switched on. They might get damaged.
- Since it may be hot, do not leave plastic or aluminum dishes on the surface of appliance. These kind of dishes should not be used to keep food either.
- Do not place baking trays, dishes or aluminium foil directly onto the bottom of the oven. The heat accumulation might damage the bottom of the oven.
- Keep all ventilation slots clear of obstructions.
- The manufacturer declines all liability for injury to persons or damage to property caused by incorrect or improper use of the appliance.

- Do not use the oven with front door glass removed or broken.
- Check that all controls on the appliance are switched off after use.

i IMPORTANT: Call the authorized service for installation of the appliance to be used. After this procedure, guarantee period will be started.

Safety for children

! WARNING Stepping, leaning or sitting on the door or drawers of this range can result in serious injuries and also cause damage to the range. Do not allow children to climb or play around the range. The weight of a child on an open door may cause the range to tip, resulting in serious burns or other injury.

- Do not leave children alone - children should not be left alone or unattended in area where appliance is in use. They should never be allowed to sit or stand on any part of the appliance.

i "CAUTION": Do not store items of interest to children in cabinets above a range or on the backguard of a range - children climbing on the range to reach items could be seriously injured."

- Accessible parts may be hot when the broil is in use. Young children should be kept away.
- The packaging materials will be dangerous for children. Keep the packaging materials away from children. Please dispose of all parts of the packaging according to environmental standards.

Safety when working with electricity

! WARNING: Before installing, turn power OFF at the service panel. Lock service panel to prevent power from being turned ON accidentally.

! WARNING: Personal injury or death from electrical shock may occur if the range is not installed by a qualified installer or electrician.

Any additions, changes or conversions required in order for this appliance to satisfactorily meet the application needs must be made by a qualified technician.

- In case of any damage, switch off the appliance and disconnect it from the main supply by removing the fuse or switching off the circuit breaker.
- Ensure that the fuse rating is correct.
- Do not operate the appliance barefooted.
- Never touch the appliance with wet hands or feet.
- Do not soak removable heating elements. Heating elements should never be immersed in water.

Intended use

The appliance is designed for domestic use only. Commercial use is not admissible.

This appliance is not intended to use at mobile homes, recreational vehicles.

This appliance should not be used for warming the plates under the broil, hanging towels and dish cloths on the handles, for drying and the space heating purposes.

All openings in the wall behind the appliance and in the floor under the appliance shall be sealed.

The manufacturer shall not be held liable for any damage caused by improper use or handling errors.

The appliance can be used for defrosting, baking, roasting and broiling food.

Disposal

Packaging material

⚠ DANGER: Risk of suffocation by the packaging materials!

Packing elements (i.e. plastic bags, polystyrene foam, nails, packing straps, etc.) should not be left around within easy reach of children, as these may cause serious injuries.

The packaging material and transport locks are made from materials that are not harmful to the environment. Please dispose of all parts of the packaging according to environmental standards. This is beneficial to the environment.

Future transportation

Do not carry out cleaning or maintenance operations on the appliance without having previously disconnected it from the electric power supply.

i NOTICE: Do not place other items on the top of the appliance. The appliance must be transported upright.

Store the appliance's original box and transport the appliance in its original carton. Follow the guidance marks that are printed on the carton.

i IMPORTANT: Verify the general appearance of your equipment by identifying possible damage during the transportation.

To prevent the wire shelf and tray inside the oven from damaging the oven door, place a strip of cardboard onto the inside of the oven door that lines up with the position of the trays. Tape the oven door to the side walls.

If you do not have the original carton

Pack the appliance in bubble wrap or thick cardboard and tape it securely in order to prevent damage during transportation.

2 Installation

To ensure that critical air gaps are maintained under the appliance, we recommend that this appliance is mounted on a solid base and that the feet do not sink into any carpet or soft flooring.

The kitchen floor must be able to carry the weight of the appliance plus the additional weight of cookware and bakeware and food.

- If an appliance hood is to be fitted, refer to the manufacturer's instructions regarding fixing height.
- Any kitchen furniture next to the appliance must be heat-resistant (212 °F min.).

Installation and connection

⚠ IMPORTANT: Do not install the appliance next to refrigerators or freezers. The heat emitted by the appliance will lead to an increased energy consumption of cooling appliances.

- For installation the appliance must be connected in accordance with all local electrical regulations.

⚠ IMPORTANT: Unit is heavy and requires a least two persons or proper equipment to move.

i NOTICE:

Material damage!

The door and/or handle must not be used for lifting or moving the appliance.

- The appliance must be placed directly on the floor. It must not be placed onto a base or a pedestal.

Clearances & Dimensions

Dimensions that are shown in figure must be used. Given dimensions provide minimum clearance. There needs to be a 30-inch minimum clearance between the top of the cooking surface and the bottom of unprotected wood or metal cabinets or a 24-inch minimum when bottom of wood or metal cabinets are protected by not less than a 1/4-inch flame retardant millboard covered with not less than no. 29 msg sheet-steel, 0.015-inch stainless steel, 0.024-inch aluminum or 0.020-inch copper.

To eliminate the risk of burns or fire by reaching over heated surface units, cabinet storage space located above the surface units should be avoided. If cabinet storage is to be provided, the risk can be reduced by installing a range hood that projects horizontally a minimum of 5 inches beyond the bottom of the cabinets.

Important notes to the consumer

Keep this manual for future reference.

- As when using any range generating heat, there are certain safety precautions you should follow. These are listed in the front of this manual. Read and follow carefully.
- Be sure your range is installed and grounded properly by a qualified installer or service technician.
- To eliminate the need to reach over the cooktop, cabinet storage space above the cooktop should be avoided.

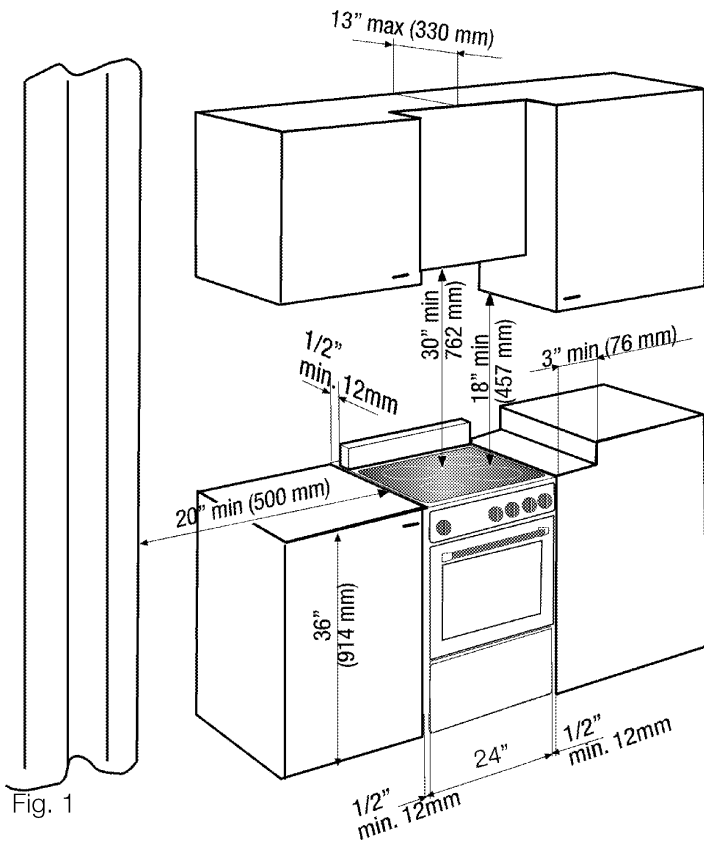

Do not install closer than 1/2" (12mm) from any adjacent surface

Fig. 1

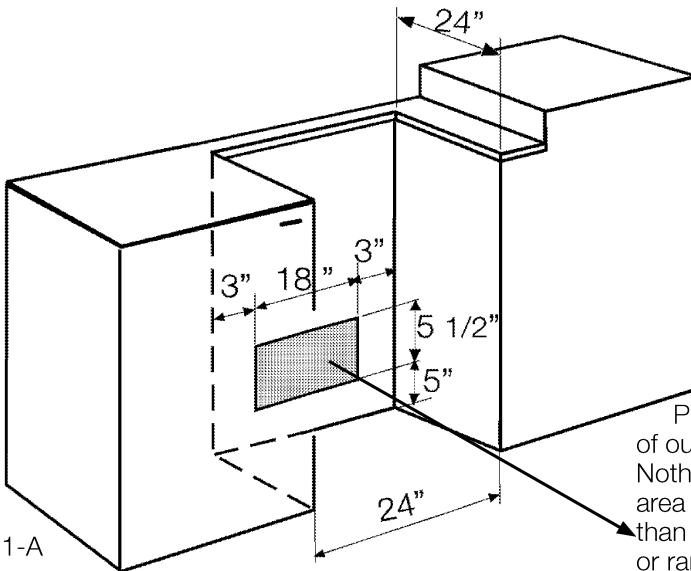

Proper positioning of outlet must be flush. Nothing located in shaded area can extend more than 2" (5,1 cm) from wall or range will not slide all the way back.

Fig. 1-A

Important Notes to the Installer

Read manual before installing the range.
Observe all governing codes and ordinances.

Be sure to leave these instructions with the consumer.

Be sure your range is installed and grounded properly by a qualified installer or service technician.

⚠ IMPORTANT: Before installing the range in an area covered with linoleum or any other synthetic floor covering, make sure the floor covering can withstand heat at least 90°F (32.2°C) above room temperature without shrinking, warping or discoloring.

Do not install the range over carpeting unless you place an insulating pad or sheet of 1/4inch (0.64cm) thick plywood between the unit and carpeting.

⚠ WARNING

All ranges can tip and injury to persons could result.

- Install the Anti-Tip Device packed with appliance.
- A risk of tip-over may exist if the appliance is not installed in accordance with these instructions.
- If the range is pulled away from the wall for cleaning, service or any other reason, ensure that the Anti-Tip Device is properly re-engaged when the range is pushed back against the wall. In the event of abnormal usage (such as a person standing, sitting or leaning on an open door), failure to take this precaution can result in tipping of the range. Personal injury might result from spilled hot liquids or from the range itself.

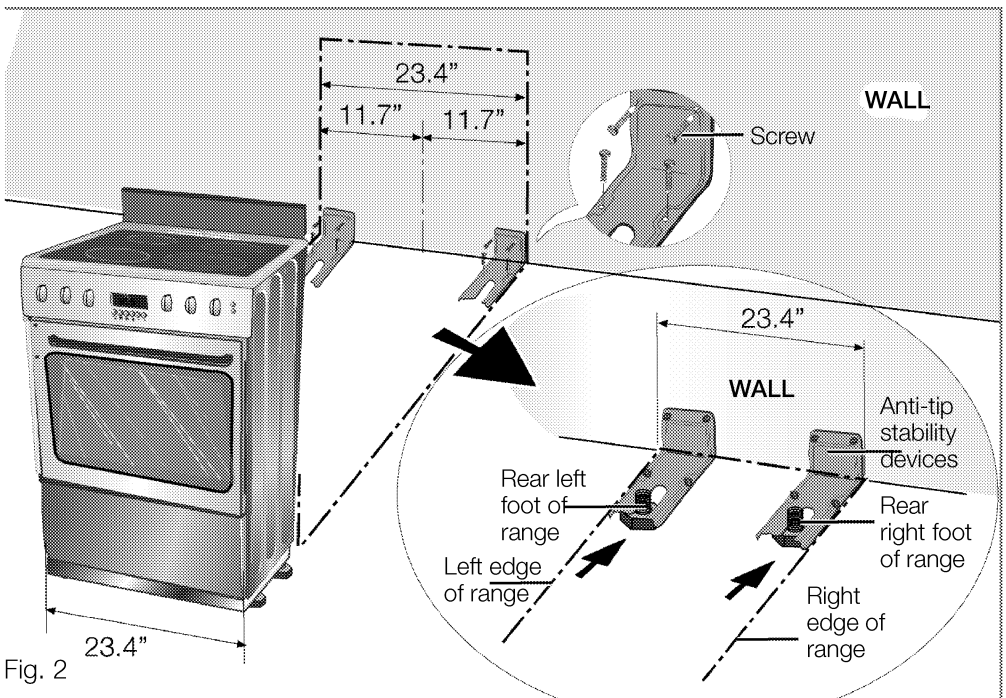

Fig. 2

Anti-Tip stability device installation instructions

There is only one anti-tip stability device within product.

You can use it for right back foot or left back foot.

1. The anti-tip device has to be attached to the floor as shown in Figure 3.

The dimension for the bracket location from the floor is to be determined after the appliance feet have been adjusted to the proper installation height shown in the installation instructions and the appliance has been leveled.

Fasten Bracket (Floor Mounting only)

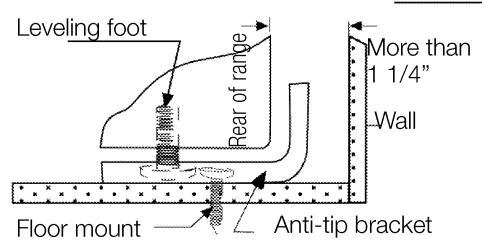

Fig. 3

2. Locate the anti-tip device on the wall at the measured dimension from where the left side of the appliance (facing range) is to be located.

3. Slide range into place making sure the anti-tip device to be faced the anti-tip hole on the cooktop and screwed.

Tip Over Hazard

A child or adult can tip the range and be killed. Connect anti-tip bracket to rear range foot. Reconnect the anti-tip bracket,

if the range is moved. Failure to follow these instructions can result in death or serious burns to children and adults.

⚠ WARNING: Electrical shock hazard!

- Use extreme caution when drilling holes into the wall or floor. There may be concealed electrical wires located behind the wall or under the floor.
- Identify the electrical circuits that could be affected by the installation of the Anti Tip Device, then turn off power to these circuits.

Failure to follow these instructions may result in electrical shock or other personal injury.

Connection to the main supply



WARNING:

Electrical shock hazard

Electrically ground range.

Failure to do so can result in death, fire, or electrical shock.

⚠ .DANGER: Risk of electric shock!

Before starting any work on the electrical installation, please disconnect the appliance from the mains supply.

Disconnect power before servicing. Use 8 gauge copper for 6 gauge aluminium wire. Electrically ground range.

Failure to follow these instructions can result in death, fire, or electrical shock.

⚠ IMPORTANT: Electrical installation should comply with national and local codes.

⚠ IMPORTANT: This appliance must be properly grounded to avoid shock hazard!

Our company shall not held responsible for any damage caused by using the appliance without grounded receptacle. The range must be electrically grounded in accordance with local codes or, in the absence of local codes, with the National Electrical Code, ANSI/NFPA No. 70-latest edition, in Canada Canadian Electrical Code. Installation should be made by a Licensed electrician.

⚠️ WARNING: Risk of electric shock, short circuit or fire by damage of the main power supply!

The main power supply lead must not be clamped, bent or trapped or come into contact with hot parts of the appliance. If the main power cable is damaged, it must be replaced by a qualified electrician.

For installations where grounding through the neutral conductor is prohibited.

The main supply data must correspond to the data specified on the rating plate of the appliance. The rating plate is either seen when the door or the lower cover is opened.

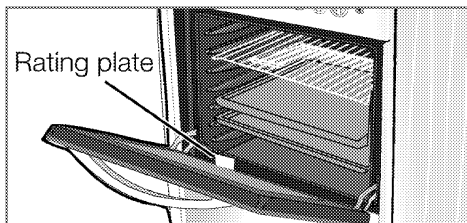

- Be sure that electrical connection and wire size adequate and in conformance with CSA standard C22.1, Canadian electrical code part.1-latest edition and all local codes and ordinances a time delay min 40 A fuse or circuit breaker is recommended.

- The range is equipped with a CSA International Certified Power Cord intended to be plugged into a standard 14-50 R wall receptacle. Be sure the wall receptacle is within reach of range's final location.
- Do not use an extension cord.

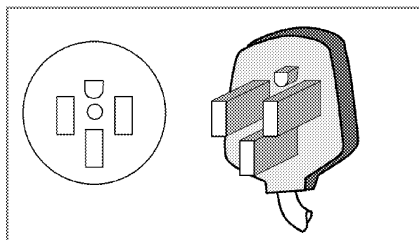

- To align the appliance with the worktop, adjust the feet turning right or left hand as required.

Backsplash

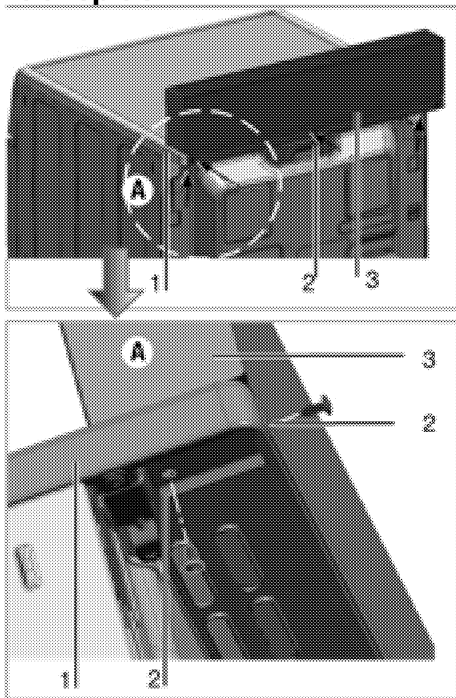

1. Burner plate

2. Assembling Screw hole

3. Backsplash

Place the backsplash (3) on to burners' plate (1) as seen on picture.

Screw the screws (2) on the rear left and rear right side also below of burners plate.

For products with cooling fan

The cooling fan cools both the built-in cabinet and the front of the product.

i Cooling fan continues to operate for about 20-30 minutes after the oven is switched off.

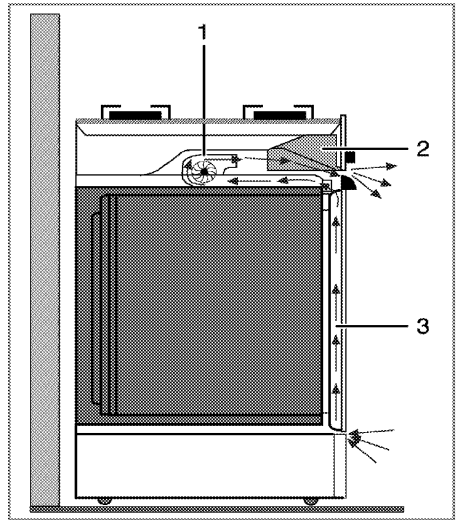

1. Cooling fan
2. Control panel
3. Door

3 Preparation

Tips for saving energy

The following tips will help you to use your appliance in an ecological way and to save energy:

- Use dark colored and enamel coated trays, since the heat transmission will be better.
- While cooking your meals, perform a preheating operation if it is advised in the user manual or cooking instructions.
- During cooking, do not open the oven door frequently.
- Try to cook more than one type of meal within the oven at the same time (You can cook two different meals at the same time by locating cooking bowls on the same shelf). It will be suitable to cook more than one meal after each other. The oven will already be hot.
- Defrost frozen meals before cooking them.
- You can save energy by switching off your oven a few minutes before the end of the cooking time (The oven door should not be opened).
- Use pots/pans with lids for cooking. Without a lid, the energy consumption may be up to four times higher.
- Choose the burner/plate which is suitable to the saucepan base. Always choose the correct size of saucepans for your meals. For larger burners/plates more energy is needed.
- Take care to use flat base saucepans while cooking on electrical cookers.
- Pots with an even and thick bottom provide better thermal conduction.

You can save up to 1/3 of electricity.

- Pots and pans should match the size of plates. The bottom of the pot or pan should not be smaller than the plate.
- Keep plates and pan bottoms clean. Dirt will reduce the heat transmission between plate and pan bottoms.
- In case of longer cooking times, switch off the plate 5 to 10 minutes before the end of the cooking time. When you use the residual heat, you can save up to 20 % of electricity.

Initial operation

Before first usage of your appliance, don't forget to remove the sticker on the digital timer screen.

Setting the time

⚠ IMPORTANT: Before using the oven the clock time must be set. If the clock time is not set, the main oven will not work.

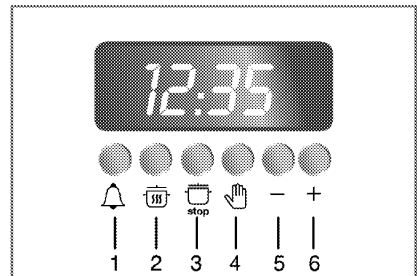

Keys for:

- 1 Alarm clock
- 2 Duration
- 3 End of cooking time
- 4 Manual mode & Time of the day
Keys for time adjustment:
- 5 Minus key
- 6 Plus key

1. Press key 4.
2. Set clock with key 5 or key 6. By pressing the key shortly, you advance or reset the clock by one minute. When you keep the individual key pressed, the minutes are advanced or reset quickly.

First cleaning of the appliance

 **IMPORTANT:** When removing appliance for cleaning and/or service;

Disconnect AC power supply.

Carefully remove the range by pulling outward.

Range is heavy, use care in handling.

 **NOTICE:** The surface might get damaged by some detergents or cleaning materials.

Do not use aggressive detergents, cleaning powder/cream or any sharp objects. Be careful to avoid steam burn. Some cleaners can produce noxious fumes if applied to a hot surface.

1. Remove all packaging materials.
2. Wipe the surfaces of the appliance with a damp cloth or sponge and dry with a cloth.

Initial heating

 **WARNING:** Hot surfaces may cause burns!

Do not touch the hot surfaces of the appliance. Use oven gloves. Keep children away from the appliance.

 **IMPORTANT:** Smell and smoke may emit during first heating. Ensure that the room is well ventilated.

Any production residues or conservation layers must be burnt off before the first use. Heat up the appliance for about 30 minutes and then switch it off.

Electric oven

1. Take all baking trays and racks from the oven.
2. Close oven door.
3. Select top and bottom heat with the function knob.
4. Select the highest temperature with the thermostat knob; see How to use the electric oven, page 20.
5. Heat approximately 30 minutes.
6. Switch off oven; see How to use the electric oven, page 20.

Broil oven

1. Take all baking trays and wire shelf from the oven.
2. Close oven door.
3. Select highest power of the broil; see How to operate the broil, page 25.
4. Heat approximately 30 minutes.
5. Switch off broil; see How to operate the broil, page 25.

4 How To Use The Hob

General information on cooking

⚠ DANGER:

Risk of fire by overheated oil!

When you heat oil, do not leave it unattended.

Never try to extinguish the fire with water! When oil has caught fire, immediately cover the pot or pan with a lid. Switch off the burner/plate if safe to do so and phone the fire service.

Only use flat bottomed pots or pans.

- Use pans which have sufficient capacity for the amount of food being cooked so they don't boil over and cause unnecessary cleaning.

Do not place lids on the burners.

Always position pans centrally over the burners. When transferring pans from one burner to another always lift the pans do not slide them.

This appliance is equipped with one or more surface units of different size. Select utensils having flat bottoms large enough to cover the surface unit heating element. The use of undersized utensils will expose a portion of the heating element to direct contact and may result in ignition of clothing. Proper relationship of utensil to burner will also improve efficiency.

Never Leave Surface Units Unattended at High Heat Settings. Boilover causes smoking and greasy spillovers that may ignite.

Make sure reflector Pans or Drip Bowls are in Place. Absence of these pans or bowls during cooking may subject wiring or components underneath to damage.

Tips for glass ceramic burner/plate

- The glass ceramic surface is heat-resistant and insensitive to large temperature deviations.
- Do not use the glass ceramic burner/plate for keeping objects or as cutting surface.

Do not cook popcorn in prepackaged aluminum containers on the cooktop. They could leave aluminum marks that cannot be removed completely.

- Use pot and pans with ground bottoms. Sharp edges cause scratches on the surface.
- Do not use aluminium pots and pans. Aluminium damages the glass ceramic surface.
- Only certain types of glass, glass/ceramic, ceramic earthenware or other glazed utensils are suitable for range-top service without breaking due to the sudden change in temperature.
- Do not cook foods directly on the cook-top.
- For foods containing sugar in any form, clean up all spills and soils as soon as possible. Allow the cook-top to cool down slightly. Then, while wearing oven mitts, remove the spills while the surface is still warm. If sugary spills are allowed to cool down, they can adhere to the cook-top and can cause pitting and permanent marks.
- If a wet sponge or cloth is used to wipe spills on a hot cooking area, be careful to avoid steam burn. Some cleaners can produce noxious fumes if applied to a hot surface. Utensil handles should be turned inward and

not extend over adjacent surface units. To reduce the risk of burns, ignition of flammable materials, and spillage due to unintentional contact with the utensil, the handle of a utensil should be positioned so that it is turned inward, and does not extend over adjacent surface units.

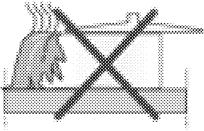

Splashes may damage the ceramic surface and can cause fire.

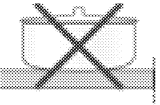

Do not use pots that have concave or convex bottoms.

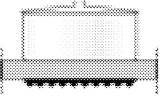

Use pot and pans with smooth bottoms. They ensure a good heat transfer.

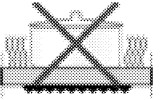

If the pan is too small energy is wasted

⚠ DANGER:

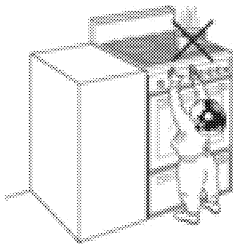

Tipping of pan

Make sure that the handles of cookware do not stick out over the edge of the appliance, to avoid them being knocked over by accident. This also makes it more difficult for children to reach the cooking pans.

- Ensure handles of pans cannot accidentally be caught or knocked

and do not get hot by adjacent heating zones. Avoid pans that are unstable and easily tipped. Pans that are too heavy to move easily when filled can also be a hazard.

Do not store items of interest to children in cabinets above a range or on the backguard of a range. Children climbing on the range to reach items could be seriously injured.

How to use burners/plates

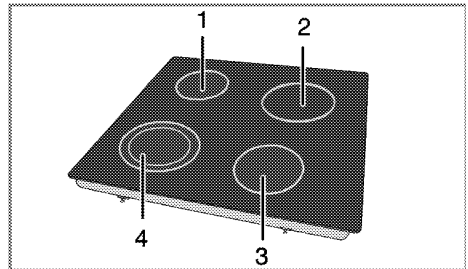

- 1 Single-circuit cooking plate 5,5- 6,3
 - 2 Single-circuit cooking plate 7-8
 - 3 Single-circuit cooking plate 5,5- 6,3
 - 4 Dual-circuit cooking plate 4,7 - 8,3 inches
- is list of advised diameter of pots to be used on related burners.

⚠ DANGER:

Broken glass!

Do not let any objects fall onto the plate. Even small objects (e.g. salt shaker) may damage the burner/plate.

Do not use glass ceramic plates with cracks. Water may enter into the cracks and cause a short circuit.

If the surface is damaged in any way (e. g. visible cracks), switch off the device immediately to reduce the risk of an electric shock.

If cooktop should break, cleaning solutions and spillovers may

penetrate the broken cook-top and create a risk of electric shock. Contact a qualified technician immediately.

The glass ceramic burner/plate is equipped with an operating lamp and a residual heat indicator.

The residual heat indicator indicates the position of the switched on plate and remains illuminated after switching off. (When the temperature of the plate falls below touchable temperature the indicator light will go off). Weak flicker illumination is not a problem at residual heat indicator light.

i NOTICE:

Quick heating glass-ceramic plates emit a bright light when they are switched on. Do not stare to bright light.

Switching the plate on

The plate control knobs are used for operating the plates. To obtain the desired cooking power, turn the hob control knobs to the corresponding level.

Cooking level	1	2	3
	warming	stewing, simmering	cooking, roasting

Switching the plate off

Turn plate control knob to off position (top).

How to operate on the multiple region plates (model dependant)

Plates with multiple region are used for different diameter of pans.

By changing the knob position in clockwise direction or counter clockwise direction, the diameter of active zone can be adjusted.



1. Single circuit zone knob
2. Hotplate warning lamp
3. Dual cooking zone knob

Switch off multiple zone hotplates

1. In order to turn off the plate, set the knob to "OFF" position by turning it .

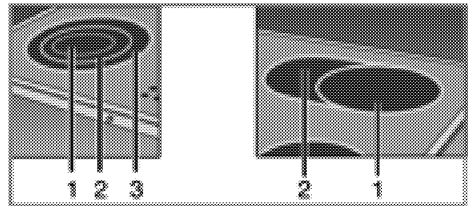

- 1 Stage 1
- 2 Stage 2
- 3 Stage 3

i NOTICE:

The 2nd or 3rd zones of multiple region hotplates will not operate by themselves.

5 How to Operate the Oven

General information on baking, roasting and broiling

DANGER

Risk of scalding by hot steam!

Stand away from the range when opening oven door. Hot air or steam which escapes can cause burns to hands, face, and/or eyes.

Let hot air or steam escape before removing or replacing food.

Tips for baking

- Use non-stick coated appropriate metal plates or aluminum containers or heat-resistant silicone moulds.
- Make best use of the space on the rack.
- It is recommended to place the baking mould in the middle of the rack.
- Select the correct shelf position before turning the oven or broil on do not move oven shelves when hot.
- Always place oven racks in desired location while oven is cool. If rack must be moved while oven is hot, do not let potholder contact hot heating element in oven.
- Keep the oven door closed.

Tips for roasting

- Seasoning with lemon juice and black pepper will improve the cooking performance when cooking a whole chicken, turkey or a large piece of meat.
- Meat with bones takes about 15 to 30 minutes longer before it is cooked than a roast of the same size without bones.

- You should calculate about 4 to 5 minutes cooking time per centimeter height of the meat.
- Let meat rest in the oven for about 10 minutes after the cooking time. The juice is better distributed all over the roast and does not run out when the meat is cut.
- Fish in a fire-resistant dish should be placed on the rack at the medium or lower level.

Tips for broiling

Broiling is ideal for cooking meat, fish and poultry and will achieve a nice brown surface without it drying out to much. Flat pieces, meat skewers and sausages are particularly suited for broiling as are vegetables with a high water content such as tomatoes and onions.

- Distribute the pieces to be broiled on the wire shelf.
- If the broiling is on the wire shelf, locate a dripping pan under it in order to collect the fat.
- Add some water in dripping pan for easy cleaning.

How to use the electric oven

IMPORTANT:

Before using the oven, the clock time must be set. If the clock time is not set, the main oven will not work.

IMPORTANT:

Food Poisoning Hazard

Do not let food sit in oven more than one hour before or after cooking.

Doing so can result in food poisoning or sickness.

WARNING:

Never cover any slots, holes or passages in the oven bottom or cover an entire rack with materials such as aluminium foil. Doing so blocks airflow through the oven and may cause carbon monoxide poisoning. Aluminium foil linings may also trap heat, causing a fire hazard.

Select temperature and operating mode

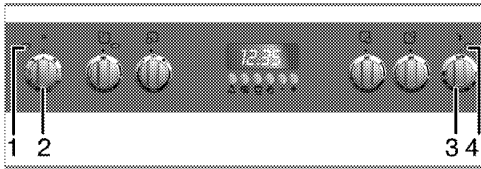

1. Function lamp 2. Function knob
3. Thermostat knob 4. Thermostat lamp

The operating modes of the electric oven are selected with the function knob. The temperature is adjusted with the thermostat knob.

All oven functions are turned off by turning the relevant knob to off (upper) position.

1. Set thermostat knob to the desired temperature.
 2. Set function knob to the required operating mode.
- » The oven heats up to the adjusted temperature and maintains it. During heating, temperature lamp stays on.

Switch off electric oven

Turn function knob and thermostat knob to off position (top).

Shelf positions

It is important to position the wire shelf on side rack correctly. The wire shelf must be placed so that it will fit into the opening of the wire shelf as illustrated in the figure.

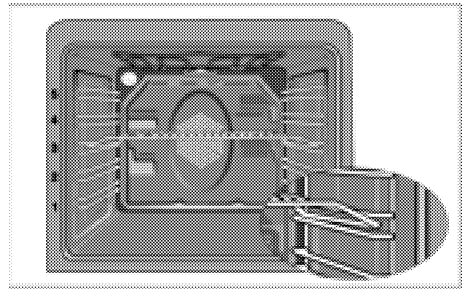

Operating modes

All functions for the ovens are listed in this section.

The order of operating modes shown here might deviate from the arrangement on your appliance.

Static



Top and bottom heat are on. The foodstuffs are heated simultaneously from the upper and lower part. Suitable for cakes, cookies or cakes and casseroles in baking moulds. Cook with one tray only.

Bottom heat



Only bottom heat is on. Is particularly suitable for dishes, such as pizza, which are required to be baked from bottom.

Top and bottom heat with convection air



Top and bottom heat plus fan (in the rear wall) are on. The hot air is distributed evenly and quickly all over the oven by the fan. Cook with one tray only.

Operating with fan



The oven is not heated. Only the fan and lamp are in operation. Suitable for thawing frozen granular food slowly at room temperature and cooling down the cooked food.

Hot air



Warm air heated by the rear heater is evenly distributed throughout the oven rapidly by means of the fan. It is suitable for cooking your meals in different rack levels and preheating is not required in most cases. Suitable for cooking with multi trays.

"3D" function



Top heat, bottom heat plus ring heat with fan (in the rear wall) are on. The food to be cooked is evenly and quickly cooked all around. Cook with one tray only.

Broil



The large (under the oven roof) is in operation. Suitable for broiling larger quantities.

- Put big or medium-sized portions in correct shelf position under the broil heater for broiling.
- Set the temperature to maximum level.
- Turn the food after half of the broiling time.

Broil with convection air



The broil effect is not as strong as with normal broiling.

- Put small or medium-sized portions in correct shelf position under the broil heater for broiling.
- Set the temperature to maximum level.
- Turn the food after half of the broiling time.

How to operate the oven timer

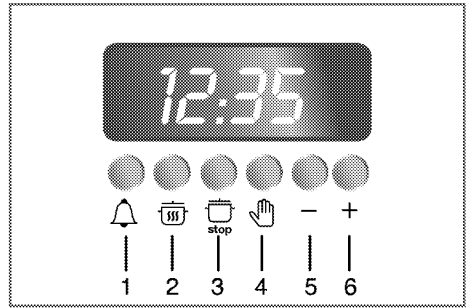

Keys for:

- 1 Alarm clock
 - 2 Duration
 - 3 End of cooking time
 - 4 Manual mode & Time of the day
- Keys for time adjustment:

- 5 Minus key
- 6 Plus key

i IMPORTANT:

The maximum time to be set for the end of the cooking process is 10 hours. In case of power cut, program will be canceled. Reprogram is needed.

Switch on fully automatic operation

In this mode of operation, after setting the finishing time, you can set time of cooking. Oven adjust and starts automatically.

1. Press key 3.
 2. Set end of the cooking time with key **5** or key **6**. By pressing the key shortly, you advance or reset the clock by one minute. When you keep the key pressed, the minutes are advanced or reset quickly.
- » The indication "**AUTO**" lights up on the display.
3. Keep key 2 pressed.

4. Set the cooking time with key 5 or key 6. By pressing the key shortly, you advance or reset the clock by one minute. When you keep the key pressed, the minutes are advanced or reset quickly.
5. Put your dish into the oven.
6. Select operating mode and temperature.
 - » The oven is heated up to the set temperature and keeps this temperature until the end of the cooking time that has been selected. During the cooking process, the cooking symbol on the display is lit.
9. Press key **3** as soon as the cooking process has been completed and an alarm sounds.
10. Switch the oven off with the thermostat knob and/or the function knob.
11. Press key **4**.
 - » The indication "**AUTO**" on the display goes off.

Switch on semi-automatic operation

In this mode of operation, after set the time of cooking, oven start the cooking.

1. Press key **2**.
2. Set the cooking time with key **5** or key **6**. By pressing the key shortly, you advance or reset the clock by one minute. When you keep the key pressed, the minutes are advanced or reset quickly.
 - » The indication "**AUTO**" lights up on the display.
3. Put your dish into the oven.
4. Select operating mode and temperature.
 - » The oven is heated up to the set temperature and keeps this temperature until the end of the

cooking time that has been selected. During the cooking process, the cooking symbol on the display is lit.

5. Press key **3** as soon as the cooking process has been completed and an alarm sounds.
6. Switch the oven off with the thermostat knob and/or the function knob.
7. Press key **4**.
 - » The indication "**AUTO**" on the display goes off.

IMPORTANT:

When you press key 2 during the cooking process, the display will show the remaining cooking time for a short moment.

Interrupting the cooking process

1. Keep key **2** pressed.
2. Keep key **5** pressed until "**0.00**" is shown as remaining cooking time on the display.
3. Release key **2**.
4. Press key **4**.
 - » The indication "**AUTO**" on the display goes off.
5. Switch the oven off with the thermostat knob and/or the function knob.

Cooking times table





























IMPORTANT:

The values indicated in the table below are data indicative. They may vary according to the type of food as well as your preferences of cooking.

Baking and roasting

IMPORTANT:

Level 1 is the **bottom** level in the oven.

Food	Cooking level number		Rack position	Temperature (°F)	Cooking time (min.) (approx.)
Cake in tray	One level		4	350	25 ... 30
Cake in mould	One level		2	355	40 ... 50
Cakes in paper	One level		3	350	25 ... 30
	2 levels		1 - 5	350	30 ... 40
	3 levels		1 - 3 - 5	360	45 ... 55
Sponge cake	One level		3	390	5 ... 10
	2 levels		1 - 5	350	20 ... 30
Cookies	One level		3	350	25 ... 30
	2 levels		1 - 5	350-375	30 ... 40
	3 levels		1 - 3 - 5	350	35 ... 45
Dough pastry	One level		2	390	30 ... 40
	2 levels		1 - 5	390	45 ... 55
	3 levels		1 - 3 - 5	390	55 ... 65
Filled savory pastry	One level		2	390	25 ... 35
	2 levels		1 - 5	390	35 ... 45
	3 levels		1 - 3 - 5	375	45 ... 55
Leaven	One level		2	390	35 ... 45
	2 levels		1 - 3	375	35 ... 45
Lasagna	One level		2-3	390	30 ... 40
Pizza	One level		2	390 ... 430	15 ... 20
Lamb haunch (casserole)	One level		3	25 min. max after 355...375	70 ... 90
Roast chicken	One level		3	15 min. max after 355... 375	55 ... 65
	One level		2	15 min. max after 355...375	55 ... 65
Turkey (5.5 kg)	One level		2	25 min. max after 355...375	150 ... 210
	One level		2	25 min. max after 355...375	160 ... 210
Fish	One level		2	390	20 ... 30
	One level		3	390	20 ... 30

While cooking with 2 trays at the same time, place the deep tray to the upper shelf and shallow tray to the lower shelf.

It is suggested to perform preheating for all foods.

(**) For preheating, set the required temperature, the thermostat lamp will go out when the required temperature is reached.

Tips for baking cakes

1. If pastry is too dry,
 - » Increase the temperature by 50°F and reduce the cooking time.
2. If pastry dropped,
 - » Use less liquid or lower the temperature by 50°F.
3. If pastry is too dark on top,
 - » Place it on a lower rack, lower temperature, and increase the cooking time.
4. If cooked well on the inside but sticky on the outside,
 - » Use less liquid, lower the temperature, and increase the cooking time.

Tips for baking pastry

1. If the pastry is too dry,
 - » Increase the temperature some 50°F and decrease the cooking time.
 - » Dampen the layers of dough with a sauce composed of milk, oil, egg and yogurt.
2. If the pastry takes too long to bake,
 - » Make sure that the thickness of the pastry you have prepared does not exceed the depth of the tray and remain level with it.
3. If the upper side of the pastry gets browned, but the lower part is not cooked,
 - » Make sure that the amount of sauce you have used for the pastry is not too much at the bottom of the pastry. Try to scatter the sauce equally between and on the dough layers for an even browning.
 - » Cook the pastry in accordance with the mode and temperature given in the cooking table. If the bottom part is still not browned enough, place it on one-layer-lower shelf next time.

Tips for cooking vegetables

1. If the vegetable dish runs out of juice and gets to dry,
 - » Since using a lid during cooking will keep the juice of the dish in the pan, cook your vegetable dishes in a pan with a lid instead of a tray.
2. If a vegetable dish does not get cooked,
 - » Boil the vegetables beforehand or prepare them like canned food and put in the oven.

How to operate the broil

IMPORTANT:

Before using the oven the clock time must be set. If the clock time is not set, the main oven will not work.



WARNING:

Hot surfaces may cause burns!

Close oven door during broiling.

Switch on broil

1. Set the function knob onto the broil symbol.
 2. Set broil temperature.
 3. Preheat for approximately 5 minutes, if it is necessary.
- » The thermostat lamp is switched on.

Switch off broil

1. Turn broil control knob to off position (top).

Shelf positions

For optimum broil coverage, position the wire shelf towards the front of the oven just out of contact with the glass door. Placing the wire shelf fully to the rear of the oven will reduce the broil coverage.

Cooking times table for broiling

Broiling with electric broil

Food	Rack positionl	Grilling time (approx.)
Fish	4...5	20...25 min.#
Sliced chicken	4...5	25...35 min.
Lamb chops	4...5	20...25 min.
Roast beef	4...5	25...30 min.#
Veal chops	4...5	25...30 min.#
Toast bread	4	1...2 min.
# depending on thickness		

How to use the alarm clock

In addition to using the timer for cooking, it can be also used as a reminder or an alarm clock.

As soon as the defined period of time has expired, the alarm clock will emit a signal. The alarm clock has no influence on the functions of the oven.

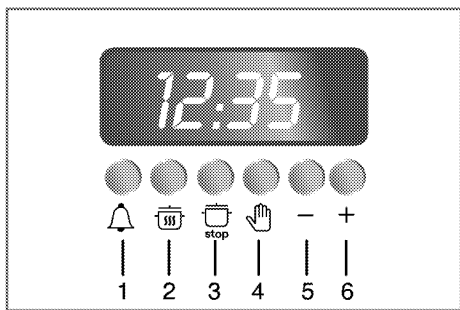

Keys for:

- 1 Alarm clock
- 2 Duration
- 3 End of cooking time
- 4 Manual mode & Time of the day

Keys for time adjustment:

- 5 Minus key
- 6 Plus key

Setting the alarm clock

1. Press key 1.

i IMPORTANT:

The maximum alarm time can be 11 hours and 59 minutes.

2. With key **5** or key **6** you can set the period of time which is to elapse before the alarm signal sounds. By pressing the key shortly, you advance or reset the clock by one minute. When you keep the individual key pressed, the minutes are advanced or reset quickly.

» The alarm clock symbol on the display lights up.

i IMPORTANT:

When you press key 1 while the alarm clock is activated, the display will show the remaining cooking time for a short moment.

Switching off the alarm

1. Press any key as soon as the alarm signal sounds.
- » The alarm clock symbol on the display is extinguished.

In order to cancel set alarm time;

1. To reset the alarm time, key **1** pressed.
2. Keep key **5** pressed until "0.00" is shown as remaining time on the display.

» The alarm clock symbol on the display is extinguished.

6 Maintenance and Care

General information

DANGER:

Risk of electric shock!

Switch off the electricity before cleaning appliance to avoid an electric shock.

DANGER

Hot surfaces may cause burns!

Allow the appliance to cool down before you clean it.

NOTICE

The surface might get damaged by some detergents or cleaning materials.

Do not use aggressive detergents, cleaning powder/cream or any sharp objects. Be careful to avoid steam burn. Some cleaners can produce noxious fumes if applied to a hot surface.

Clean the appliance thoroughly after each use; in this way it will be possible to remove cooking residues more easily, thus avoiding these from burning the next time the appliance is used.

No special cleaning agents are required for cleaning the appliance. It is recommended to use warm water with washing liquid, a soft cloth or sponge and use a dry cloth for drying.

Do not use any abrasive cleaning materials!

IMPORTANT:

Do not use steam cleaners for cleaning.

How to clean the burner/plate

Ceramic plates

Always rinse off fully with a clean cloth wrung out in clean water (as residue could

damage the ceramic glass surface next time the plate is used).

In no case should crusts be scratched off with serrated edge knives, steel wool or the like.

Remove calcium stains (yellow staining) with small amounts of decalcifying agents such as Durgol, vinegar or lemon juice.

Do not allow vinegar, coffee, milk, saltwater, lemon or tomato juice to remain in contact with enamel parts (i.e. inside the oven).

Apply agent with a sponge and, in the event of heavier soiling, let it work in for a longer period of time. Afterwards, wash off burner/plate with water.

IMPORTANT:

Sugar-based food such as custard and syrup should immediately be scraped off without waiting for the surface to cool down. Otherwise the burner/plate may be permanently damaged.

Cleaning the control panel

NOTICE

Damage of the control panel!

Do not remove the control knobs for control panel cleaning.

Clean control panel and control knobs.

Cleaning the oven

No oven cleaner or any other special cleaning agent is required for cleaning the oven. It is recommended to wipe the oven with a damp cloth while it is still warm.

Do not allow fat or oils to build up in the oven base, or oven accessories.

To clean the side wall,

1. Remove the front section of the side rack by pulling it in the opposite direction of the side wall.
2. Remove the side rack completely by pulling it towards you.

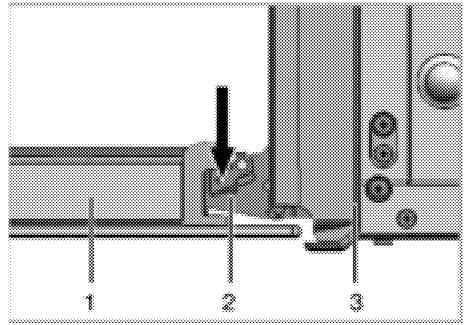
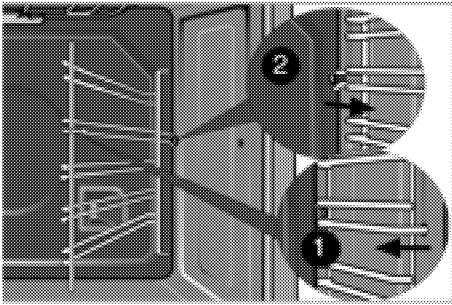

- 1 Front door
- 2 Hinge
- 3 Oven

Catalytic walls

Side walls or just back wall of oven interior may be covered with catalytic enamel.

The catalytic walls of the oven must not be cleaned. The porous surface of the walls is self-cleaning by absorbing and converting spitting fat (steam and carbon dioxide).

Clean oven door

Don't use any harsh abrasive cleaners or sharp metal scrapers for cleaning the oven door. They could scratch the surface and destroy the glass.

Removal of oven door

1. Open the front door.
2. Open the clips at the hinge housing on the right and left hand sides of the front door by pressing them down as illustrated in the figure.

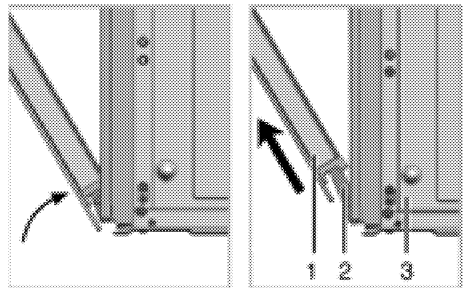

3. Move the front door to half-way.
4. Remove the front door by pulling it upwards to release it from the right and left hinges.

⚠ NOTICE

Steps carried out during removing process should be performed in reverse order (steps 4, 3, 2 and 1) to reattach the door. Do not forget to close the clips at the hinge housing when reinstalling the door.

Replacing the oven lamp

⚠ NOTICE

Hot surfaces may cause burns!

Make sure that the appliance is switched off and cooled down in order to avoid the risk of an electrical shock.

The lenses must be in place when using the oven.

The lenses serve to protect the light bulb from breaking.

The lenses are made of glass. Handle carefully to avoid breakage. Broken glass could cause an injury.

NOTICE

Position of lamp might vary from diagram.

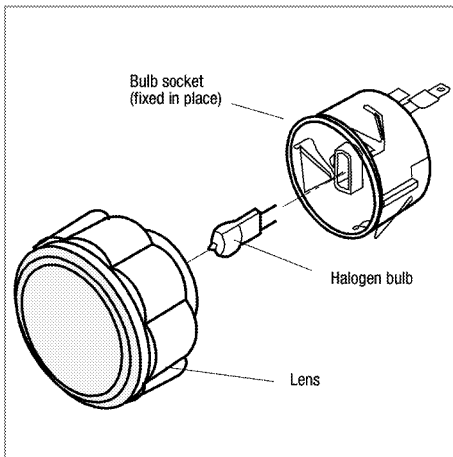

Each oven is equipped with one halogen lights located in the back wall of the oven. The lights are switched on when the door is opened or when the oven is in a cooking cycle. The oven lights are not illuminated during self clean. Each light assembly consist of a removable lens, a light bulb as well as a light socket housing that is fixed in place. Light bulb replacement is considered to be a routine maintenance item.

To replace a light bulb:

1. Read warning on this page.
2. Turn off power at the main power supply (your fuse or breaker box).

7 General Information

Overview



- | | | | |
|---|------------------|----|----------------------|
| 1 | Ceramic hotplate | 6 | Foot |
| 2 | Wire shelf | 7 | Shelf positions |
| 3 | Handle | 8 | Control panel |
| 4 | Front door | 9 | Vitroceramic surface |
| 5 | Bottom drawer | 10 | Splashback |

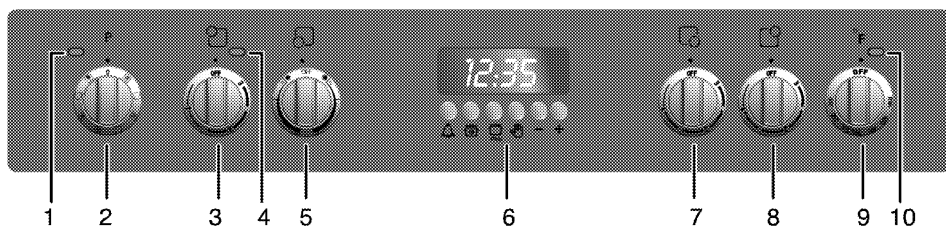

- | | | | |
|---|--|----|--|
| 1 | Function lamp | 6 | Digital timer |
| 2 | Function knob | 7 | Single-circuit cooking plate Front right |
| 3 | Single-circuit cooking plate rear left | 8 | Single-circuit cooking plate Rear right |
| 4 | Hotplate warning lamp | 9 | Thermostat knob |
| 5 | Dual-circuit cooking plate front left | 10 | Thermostat lamp |

Technical Data

GENERAL	
Outer dimensions (height/width/depth)	33 1/3 X23 1/2 x 23 1/2 inches
Voltage/frequency	120/240 V ~ 60 Hz
Total electric consumption	9,6 kW
Fuse protection	min. 40 A
Cable type / cross section /length	DTR 4x10 AWG / max. 6 ft
Burners- BERC 24100 SS	
Rear left	Single-circuit cooking plate
Size	6,3 inches
Power	1500 W
Front left	Dual-circuit cooking plate
Size	4,7 – 8,3 inches
Power	750- 2200 W
Front right	Single-circuit cooking plate
Size	5,5 inches
Power	1200 W
Rear right	Single-circuit cooking plate
Size	7 inches
Power	1800 W
Oven	
Inside illumination	15–25 W
Broil power consumption	2.2 kW

Accessories supplied with the unit

i IMPORTANT:

Accessories supplied can vary depending on the product model. All the accessories described in the user manual may not exist on your product.

Wire shelf

Can be used for roasting and as deposit for baking, roasting and casserole dishes.

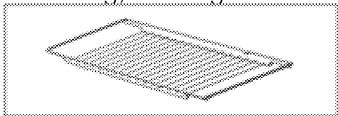

Placing drawer

Position drawer roller (2) on top of oven roller (1) and slide drawer between two rails

- Do not use the warming drawer as a storage drawer.
- Do not touch the interior surface of the range.

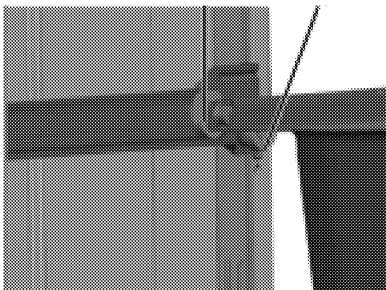
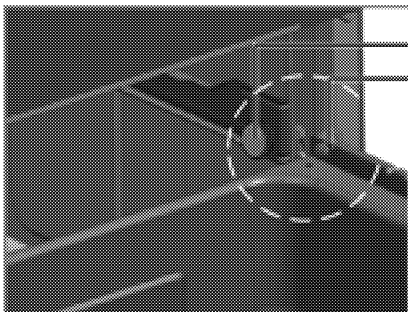

1. Oven roller
2. Drawer roller

i IMPORTANT: Do not remove drawer while hot or during operation. Be sure drawer is empty before removing.

Proper positioning of the wire shelf on sliding shelves.

It is important to position the broil and/or dripping pan on the wire shelves correctly. Slide the broil or the dripping pan completely between the 2 rails and make sure it is stable before putting a dish on it (Please see the following figure).

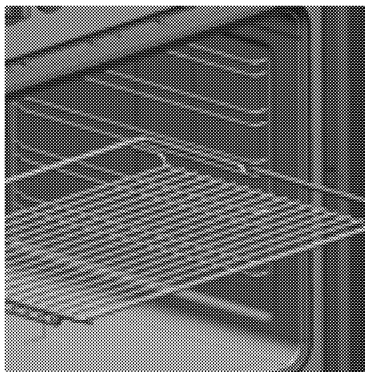
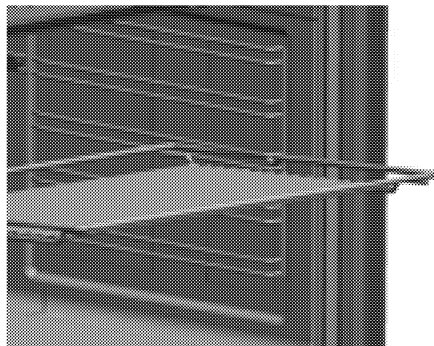

8 Troubleshooting

DANGER

Risk of electric shock, short circuit or fire by unprofessional repairs!

Repairs on the appliance must be carried out by an approved service centre.

Normal operating conditions

- Smoke and smell may emit for a couple of hours during the first operation.
- It is normal that steam escapes during operation.
- When the metal parts are heated, they may expand and cause noise.

Before you call the service, please check the following points

Electrical equipment

Malfunction/problem	Possible cause	Advice/remedy
The appliance does not work.	The mains fuse is defective or has tripped.	Check fuses in the fuse box. If necessary, replace or reset them.
	Appliance's plug can not be connected to the grounded socket.	Check the plug connection.
	Timer buttons do not work.	Keylock may be enabled. Please disable it(See; How to use the program lock,
Oven light does not work	Oven lamp is defective.	Replace oven lamp.
	No current.	Check fuses in the fuse box. If necessary, replace or reset them.
Oven does not heat.	Function knob and/thermostat knob are not set.	Set function knob and thermostat knob.
	If the appliance has a timer, the timer may not be set.	Set the time.
	No power.	Check main power supply and fuse box.

Clock/ timer (If the appliance has a digital timer)

Malfunction/problem	Possible cause	Advice/remedy
Clock display is blinking or clock symbol is on.	Power was interrupted previously.	Set time Then switch the oven off with function knobs, set the oven function again.

If the problem has not been solved:

1. Separate unit from the mains supply (deactivate or unscrew fuse).
2. Call the after-sales service of your store reseller.

IMPORTANT:

Do not attempt to repair the appliance yourself. There are no customer service items inside the appliance.

9 Warranty Statement for Blomberg electric and gas ranges

The warranties provided by Blomberg in these statements only apply to Blomberg electric and gas ranges sold to the original purchaser or homeowner in the US and Canada. This warranty is not transferable.

To obtain warranty service, please contact our nearest distributor as listed by state or call 1800-459-9848. You will need your electric or gas range model number, serial number, retailer name and address, where purchased and purchase date / installation date.

This warranty gives you specific legal rights, and you may also have other rights which vary from state to state.

All warranties stated below are based upon normal household use. **The use of the product in a commercial setting will void all warranties.**

Service must also be performed by an authorized Blomberg Service Agency.

Cosmetic defects must be reported within 10 business days from installation

1 year * limited warranty from date of first installation Blomberg will repair or replace at no cost to the consumer any defective parts of the electric and gas ranges and the labor incurred.

2 year * ++ limited warranty from date of first installation (Parts only) Blomberg will repair or replace any parts at no cost to the consumer if material defects or workmanship have caused the damage or failure of these components. Labor charges are the responsibility of the consumer

2-5 year * ++ limited warranty from date of first installation (Parts only) Blomberg will repair or replace oven cavity at no cost to the consumer if material defects or workmanship have caused the damage or failure of these components.

Labor charges are the responsibility of the consumer

Disclaimers of warranties and exclusions: Warranty does not cover service costs by an authorized service agent to correct installation, electrical problems or educational instruction on the use of the electric and gas ranges. The warranty also does not cover defects or damage caused by an act of god (such as storms, floods, fires, mudslides, etc.), damage cause by use of the electric and gas ranges for purposes other than those for which it was designed, misuse, abuse, accident, alteration, improper installation, maintenance, travel fees, service calls outside normal service hours, unauthorized service work or work.

This product is fully tested and went through official quality assurance inspections before leaving the original manufacturing site.

Warranty terms for this Blomberg household appliance is not valid if the product is altered, tampered, modified, additional parts assembled, fixed and repacked by an authorized distributor, servicer, a third party retailer, reseller or by any other unauthorized person(s).

TO THE EXTENT PERMITTED BY LAW, THIS WARRANTY IS IN LIEU OF ALL OTHER EXPRESSED AND IMPLIED WARRANTIES, INCLUDING THE IMPLIED WARRANTIES OF MERCHANTABILITY AND FITNESS FOR A PARTICULAR PURPOSE. BLOMBERG UNDERTAKES NO RESPONSIBILITY FOR THE QUALITY OF THIS PRODUCT EXCEPT AS OTHERWISE PROVIDED IN THIS WARRANTY STATEMENT. BLOMBERG ASSUMES NO RESPONSIBILITY THAT THE PRODUCT WILL BE FIT FOR ANY PARTICULAR PURPOSE FOR WHICH YOU MAY BE BUYING THIS PRODUCT, EXCEPT AS OTHERWISE PROVIDED IN THIS WARRANTY STATEMENT.

Blomberg does not assume any responsibility for incidental or consequential damages. Such damages include, but are not limited to, loss of profits, loss of savings or revenue, loss of use of the cooker or any associated equipment, cost of capital, cost of any substitute equipment, facilities or services, downtime, the claims of third parties, and injury to property. Some states do not allow the exclusion or limitation of incidental or consequential damages, so the above limitations or exclusion may not apply to you.

* Installation date shall refer to either purchase date or 5 business days after delivery of the product to the home, whichever is later.

++Parts replaced will assume the identity of the original parts and their original warranty.

No Other Warranties. This Warranty Statement is the complete and exclusive warranty from the manufacturer. No employee of Blomberg or any other party is authorized to make any warranty statements in addition to those made in this Warranty Statement.

Please keep this warranty card, user manual and your sales slip for future reference.

HOW TO GET SERVICE

Please contact the Distributor for your State or Province as listed on the Distributor Contact List, or call our Toll Free Number at 1 800 459 9848 for direction to an Authorized Blomberg Service Agent. 02 01

Free Manuals Download Website

<http://myh66.com>

<http://usermanuals.us>

<http://www.somanuals.com>

<http://www.4manuals.cc>

<http://www.manual-lib.com>

<http://www.404manual.com>

<http://www.luxmanual.com>

<http://aubethermostatmanual.com>

Golf course search by state

<http://golfingnear.com>

Email search by domain

<http://emailbydomain.com>

Auto manuals search

<http://auto.somanuals.com>

TV manuals search

<http://tv.somanuals.com>