

OWNER'S GUIDE

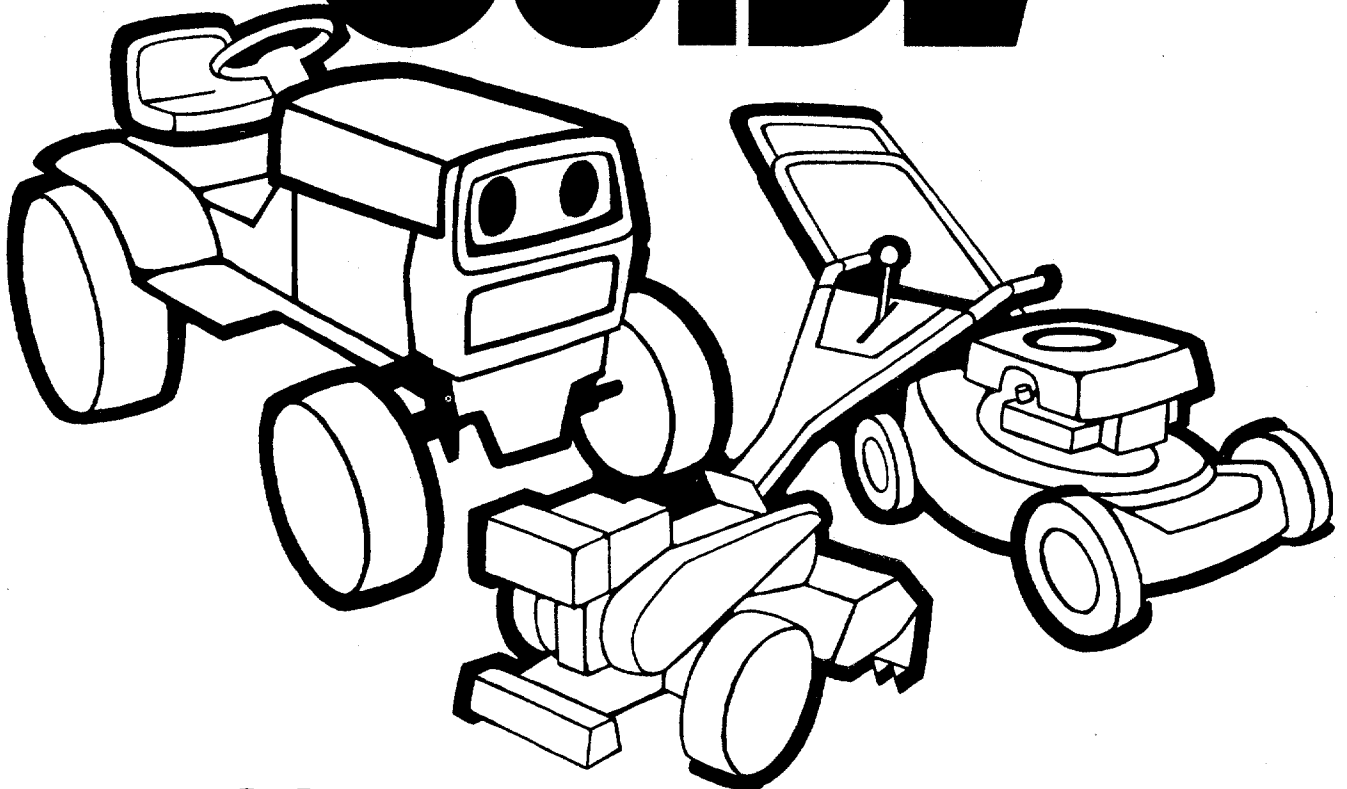

**ASSEMBLY
OPERATION
MAINTENANCE
PARTS LIST**

**IMPORTANT:
Read Safety Rules
and Instructions**

**MODEL NUMBER
110-670A**

**20"
ROTARY
MOWER**

INDEX

Safe Operation Practices.....	3	Using Your Rotary Mower.....	10
Assembly Instructions.....	4	Off-Season Storage.....	10
Operation Instructions.....	6	Exploded Parts View.....	12
Adjustments.....	7	Repair Parts List.....	13
Lubrication.....	8	Parts Information.....	Back Cover
Maintenance.....	8		

LIMITED WARRANTY

For one year from the date of original retail purchase, MTD PRODUCTS INC will either repair or replace, at its option, free of charge, F.O.B. factory or authorized service firm, any part or parts found to be defective in material or workmanship. Transportation charges for any parts submitted for replacement under this warranty must be paid by the purchaser unless such return is requested by MTD PRODUCTS INC.

This warranty will not apply to any part which has become inoperative due to misuse, excessive use, accident, neglect, improper maintenance, alterations, or unless the unit has been operated and maintained in accordance with the instructions furnished. This warranty does not apply to the engine, motor, battery, battery charger or component parts thereof. Please refer to the applicable manufacturer's warranty on these items.

This warranty will not apply where the unit has been used commercially.

Warranty service is available through your local authorized service dealer or distributor. If you do not know the dealer or distributor in your area, please write to the Customer Service Department of MTD.

The return of a complete unit will not be accepted by the factory unless prior written permission has been extended by MTD.

This warranty gives you specific legal rights. You may also have other rights which vary from state to state.



TO PURCHASERS OF INTERNAL COMBUSTION ENGINE EQUIPPED MACHINERY OR DEVICES IN THE STATE OF CALIFORNIA

The equipment which you have just purchased does not have a spark arrester. If this equipment is used on any forest covered land, brush covered land, or grass covered unimproved land in the State of California, before using on such land, the California law requires that a spark arrester be provided. In addition, spark arrester is required by law to be in effective working order. The spark arrester must be attached to the exhaust system and comply with Section 4442 of the California Public Resources Code.

IMPORTANT

It is suggested that this manual be read in its entirety before attempting to assemble or operate. Keep this manual in a safe place for future reference and for ordering replacement parts.

This unit is shipped WITHOUT GASOLINE or OIL. See operating section of this manual for proper fuel and engine oil recommendations.

Your rotary mower is a precision piece of power equipment, not a plaything. Therefore, exercise extreme caution at all times.

SAFE OPERATION PRACTICES FOR WALK-BEHIND MOWERS

TRAINING

1. Read the Operating and Service Owner's Manual carefully. Be thoroughly familiar with the controls and the proper use of the equipment.
2. Never allow children to operate a power mower. Only persons well acquainted with these rules of safe operation should be allowed to use your mower.
3. Keep the area of operation clear of all persons, particularly small children and pets. Stop engine when they are in the vicinity of your mower. Although the area of operation should be completely cleared of foreign objects, a small object may have been overlooked and could be accidentally thrown by the mower in any direction.

PREPARATION

1. Thoroughly inspect the area where the equipment is to be used. Remove all stones, sticks, wire, bones and other foreign objects which could be picked up and thrown by the mower in any direction.
2. Do not operate equipment when barefoot or wearing open sandals. Always wear substantial footwear.
3. Do not wear loose fitting clothing that could get caught on the mower.
4. Check the fuel before starting the engine. Do not fill the gasoline tank indoors, when the engine is running, or while the engine is still hot. Wipe off any spilled gasoline before starting the engine.
5. Disengage the self-propelled mechanism or drive clutch on units so equipped before starting the engine.
6. Never attempt to make a wheel or cutting height adjustment while the engine is running.
7. Mow only in daylight or in good artificial light.
8. Never operate the equipment in wet grass. Always be sure of your footing. Keep a firm hold on the handle and walk, never run.

OPERATION

1. Do not change the engine governor settings or overspeed the engine. Excessive engine speeds are dangerous.
2. Do not put hands or feet near or under rotating parts. Keep clear of the discharge opening at all times.
3. Stop the blade(s) when crossing gravel drives, walks or roads.
4. After striking a foreign object, stop the engine, remove the wire from the spark plug, and thoroughly inspect the mower for any damage. Repair the damage before restarting and operating the mower.
5. If the equipment should start to vibrate abnormally, stop the engine and check immediately for the cause. Vibration is generally a warning of trouble.
6. Stop the engine whenever you leave the mower, before cleaning the mower housing, and when making any repairs or inspections.
7. When cleaning, repairing or inspecting, make certain the blade and all moving parts have stopped. Disconnect the spark plug wire, and keep the wire away from the plug to prevent accidental starting.
8. Before attempting to unclog the mower or discharge chute, stop the engine and be sure the blade(s) have stopped completely. Disconnect the spark plug wire and keep the wire away from the plug to prevent accidental starting.
9. Do not run the engine indoors.
10. Shut the engine off and wait until the blade comes to a complete stop before removing the grass catcher or unclogging chute.
11. Mow across the face of slopes, never up-and-down. Exercise extreme caution when changing direction on slopes. Do not mow excessively steep slopes.
12. Always disconnect electric mowers (line operated) before cleaning, repairing or adjusting.
13. Never operate mower without proper guards, plates or other safety protective devices in place.
14. Keep washout ports and other mower-housing service openings closed when mowing.

MAINTENANCE AND STORAGE

1. Check the blade and engine mounting bolts at frequent intervals for proper tightness.
2. Keep all nuts, bolts, and screws tight to be sure the equipment is in safe working condition.
3. Never store the equipment with gasoline in the tank inside of a building where fumes may reach an open flame or spark. Allow the engine to cool before storing in any enclosure.
4. To reduce fire hazard, keep the engine free of grass, leaves, or excessive grease.
5. Check the grass catcher bag frequently for wear or deterioration. For safety protection replace only with new bag meeting original equipment specifications.

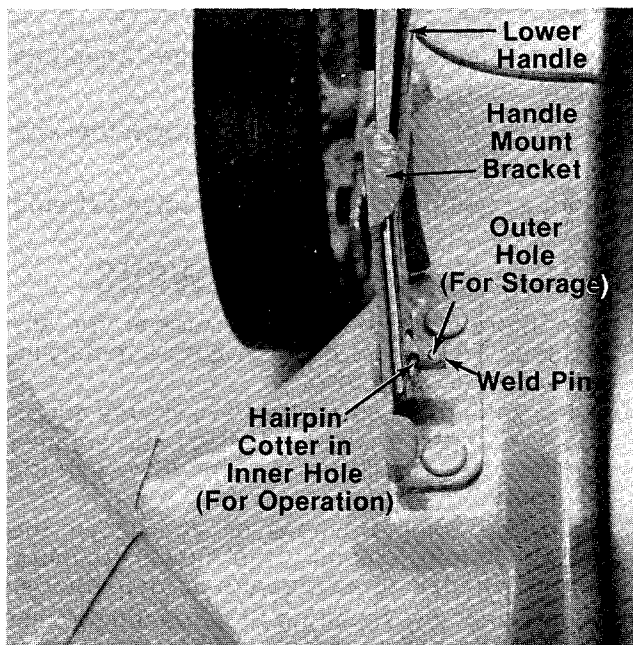

FIGURE 1.

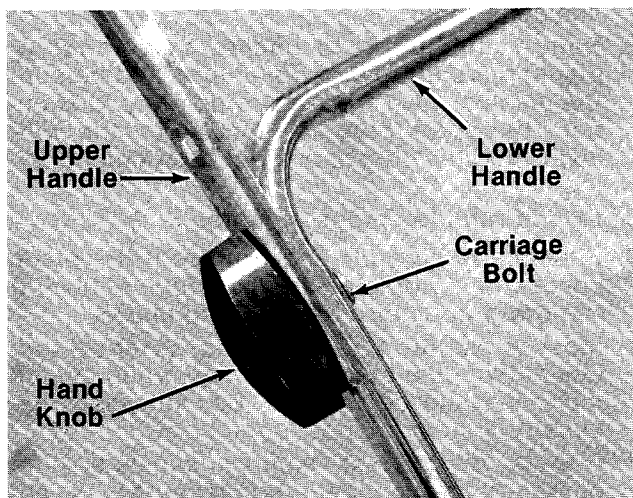

FIGURE 2.

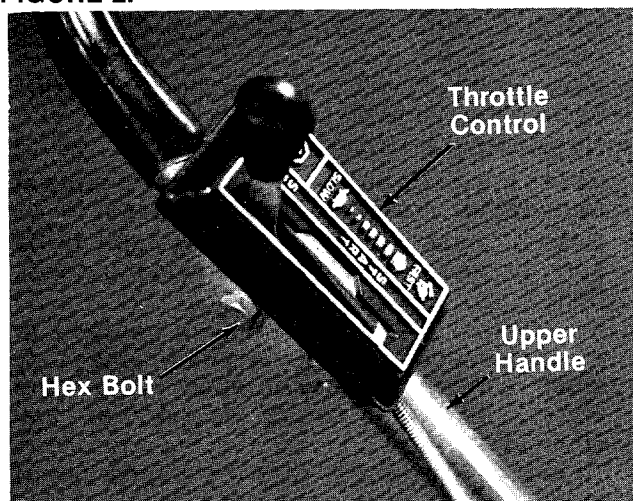

FIGURE 3.

ASSEMBLY INSTRUCTIONS

HANDLE ASSEMBLY

1. Extend throttle control which is attached to the engine at the rear of the mower and place on the floor. Be careful not to bend or kink control wire.
2. Fasten lower handle in position over weld pins in handle mount brackets on deck. Secure with hairpin cotters in inner hole on weld pin. See figure 1.

NOTE

There are two (2) holes in the handle mount brackets. Place the lower handle against the brackets and secure with hairpin cotter in the inner hole. Inner hole is for operation. Outer hole is for storage.

NOTE

It may be necessary to pull open the ends of the lower handle. This will insure a tight fit when assembled into handle mount brackets.

3. Assemble upper handle to lower handle. Secure with two carriage bolts and hand knobs as shown in figure 2. The knobs may be assembled either to the inside or the outside of the handle.

NOTE

There are two height positions for the handle. See adjustment section.

4. Place the throttle control in position on **right** side of upper handle. Secure with hex bolt and lock nut. See figure 3.

NOTE

Reference to right and left hand sides of the unit is observed from the operating position.

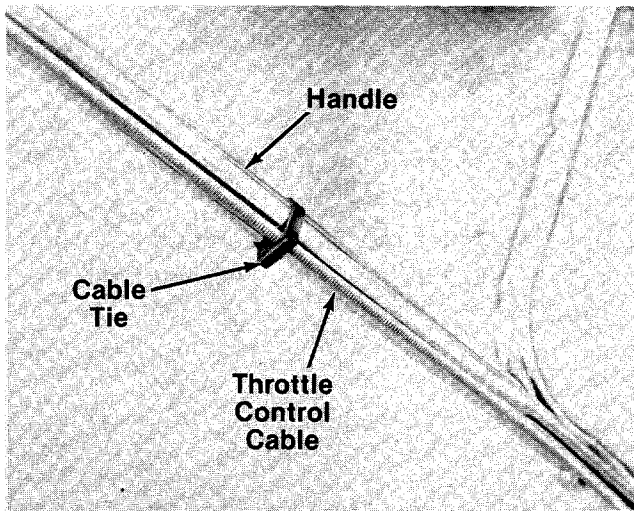

FIGURE 4.

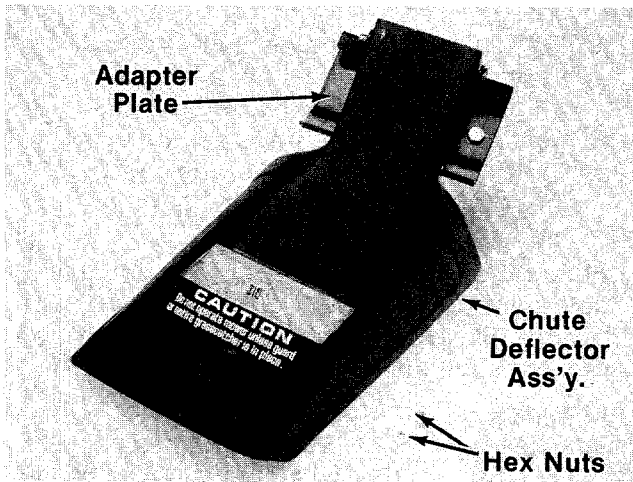

FIGURE 5.

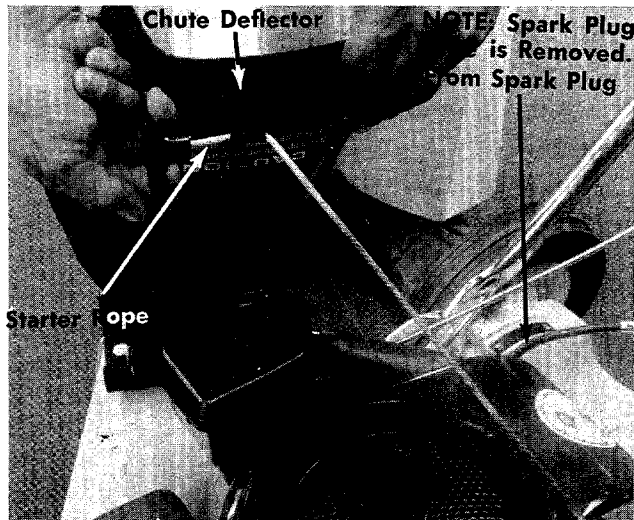

FIGURE 6.

5. Secure throttle control cable to handle with ties provided. See figure 4.
- ← 6. Check ALL nuts and bolts for correct tightness.

CHUTE DEFLECTOR ASSEMBLY

1. Remove and ground the spark plug wire. See figure 6.
2. Place the chute deflector assembly in position on the deck, with the weld bolts on adapter plate through the holes in the deck.
- ← 3. Start one hex nut on one weld bolt on adapter plate.
4. Lift the chute up and hold in place with the starter rope. See figure 6.
- ← 5. Start the other hex nut on the weld bolt.

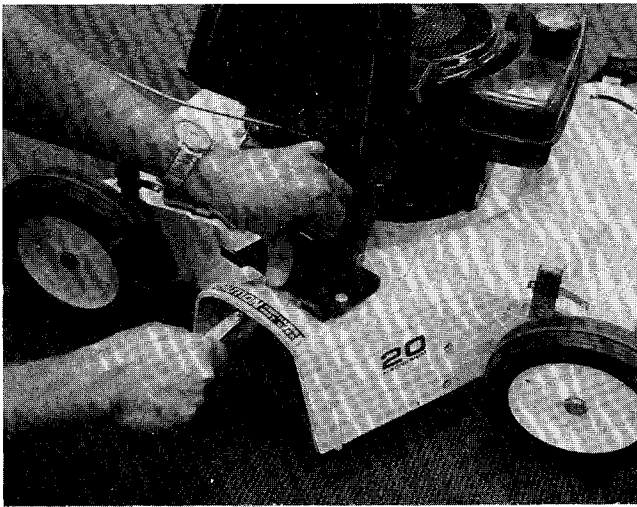

FIGURE 7.

6. Tighten two hex nuts securely, using a 7/16" wrench. See figure 7.

7. Unhook starter rope from deflector. The torsion spring will bring the deflector back into correct operating position.

OPERATION

CAUTION
DO NOT OPERATE
MOWER UNLESS
GUARD OR ENTIRE
GRASS CATCHER IS
IN ITS PROPER PLACE.



FIGURE 8.

Keep hands and feet away from the chute area on cutting deck. See figure 8.

NOTE

For shipping purposes your mower is set with the wheels in a low cutting height position. For best results raise the cutting position until it is determined which height is best for your lawn. See adjustment section.

1. **FILL SUMP WITH OIL**—Use a high quality detergent oil classified "For Service SC, SD, SE or MS". Nothing should be added to the recommended oil.

SUMMER
 (Above 40° F.)
 Use SAE 30
 If not available,
 Use SAE 10W-30
 or
 SAE 10W-40

WINTER
 (Under 40° F.)
 Use SAE 5W-20 or SAE 5W-30
 If not available,
 Use SAE 10W or SAE 10W-30

DIRECTIONS: Place the engine level. Remove cap and dipstick. Fill to "FULL" mark on dipstick. **Do not overfill.** Pour slowly. Capacity 1¼ pints.

2. **FILL FUEL TANK**—Use clean, fresh, lead-free or leaded "regular" grade automotive gasoline. Fill tank completely!

DO NOT MIX OIL WITH GASOLINE.

3. When ready to start engine, place throttle control lever on handle in "START" position and start engine in accordance with instructions in engine manual. After engine starts, move throttle control lever on handle to desired engine speed. The engine is stopped by placing control lever on handle in the "STOP" position.

4. Be sure that lawn is clear of stones, sticks, wire, or other objects which could damage lawn mower or engine. For best results and to insure more even grass distribution, do not mow when lawn is excessively wet.



IMPORTANT

After striking a foreign object, stop the engine. Remove wire from spark plug, thoroughly inspect the mower for any damage, and repair the damage before restarting and operating the mower.

ADJUSTMENTS



CAUTION

Do not at any time make any adjustment to lawn mower without first stopping engine and disconnecting spark plug wire.

EASY CUTTING HEIGHT

Thumb lever at each wheel position provides cutting height adjustment. Height of cut will be changed when the thumb lever is moved from one hole to another. Simply depress thumb lever towards wheel and move wheel and lever assembly to desired position. All wheels must be placed in the same relative position.

HANDLE POSITION

The upper handle can be adjusted to a high or low position. The operator of the lawn mower can easily adjust the handle position by unscrewing the two knobs, removing the two bolts and reassembling in the other position. No tools are necessary to make this adjustment. See figure 9.

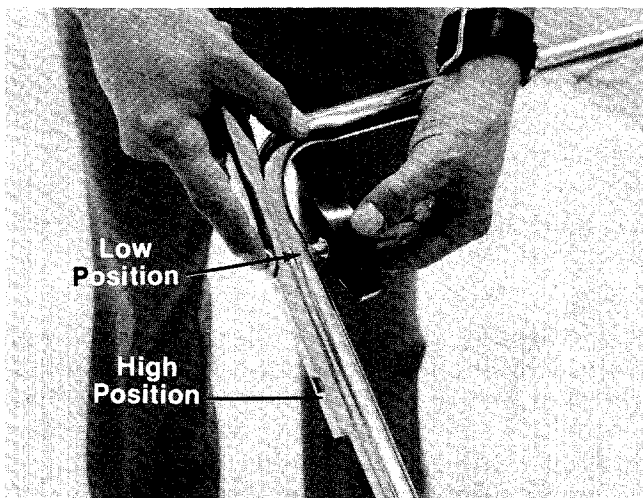

FIGURE 9.

THROTTLE

If adjustment becomes necessary, the throttle control wire assembly can be reset as follows:

1. Loosen, but do not remove, screw securing throttle control wire assembly at engine. See figure 10.
2. Move throttle control lever on handle to "FAST" position.
3. Move lever, to which control wire is fastened at engine, to full open position and retighten screw to secure throttle control wire assembly.

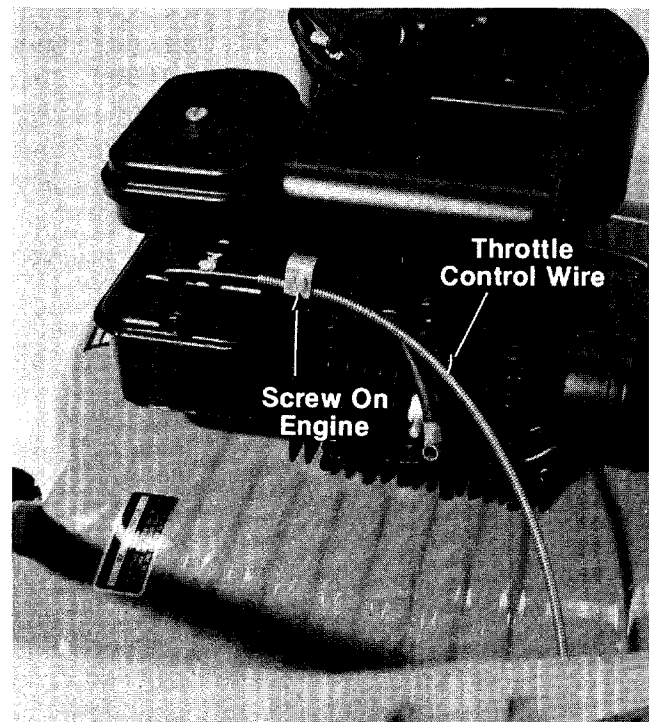

FIGURE 10.



WARNING

If any adjustments are made to the engine while the engine is running (e.g. carburetor), disengage all clutches and blades. Keep clear of all moving parts and be careful of heated surfaces and muffler.

CARBURETOR ADJUSTMENTS (See figure 11.)

Minor carburetor adjustment may be required to compensate for differences in fuel, temperature, altitude and load.

All carburetor adjustments should be made with the air cleaner on engine. Air cleaner mounting screw must be in carburetor when engine is run. Best adjustment is made with a fuel tank half full of gasoline.

To Adjust Carburetor:

1. Start engine and run long enough to warm it to operating temperature. If engine is out of adjustment so that it will not start, close the needle valve by turning it clockwise. Then open needle valve 1½ turns counterclockwise.
2. Move engine control to run engine at normal operating speed.
 - a. Turn needle valve in clockwise until engine starts to lose speed (lean mixture).
 - b. Then slowly turn needle valve out counterclockwise past the point of smoothest operation until engine just begins to run unevenly (rich mixture).
 - c. Turn needle valve back in clockwise very slowly till engine runs evenly.
 - d. Final adjustment of the needle valve should be slightly to the rich side (turn counterclockwise) of the mid-point.
3. Move engine control to "SLOW." Turn idle adjusting screw until a fast idle is obtained—(1750 R.P.M.).
4. To check adjustment, move engine control from "SLOW" to "FAST" speed. Engine should accelerate smoothly. If engine tends to stall or die out, increase idle speed or re-adjust carburetor, usually to a slightly richer mixture.

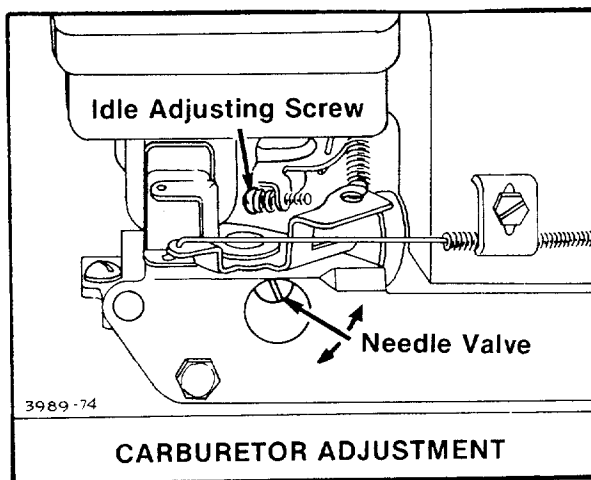

FIGURE 11.

LUBRICATION



Always stop engine and disconnect spark plug wire before cleaning, lubricating or doing any kind of work on lawn mower.

Wheels—The mower is provided with ball bearing wheels. Lubricate at least once a season with light oil.

Protective Shield—The pivot points on the protective shield should be lubricated periodically with light oil to prevent any rust or binding.

Chute Deflector—The torsion spring and pivot point should be lubricated periodically with light oil to prevent any rust or binding. Deflector must work freely.

Engine—Follow engine manual for lubrication instructions.

Throttle—Periodically lubricate throttle control lever and throttle wire assembly with a few drops of light oil (SAE No. 10 or 20) for ease of operation.

MAINTENANCE

CUTTING BLADE

The blade may easily be removed for grinding or replacement as follows:

1. Remove bolt and lock washer holding blade and blade adapter to engine crankshaft.
2. Remove blade and blade adapter from engine crankshaft.
3. Remove two bolts, lock washers and nuts holding blade to blade adapter (if necessary).

When sharpening blade, follow the original angle of grind as a guide. It is extremely important that each cutting edge receives an equal amount of grinding to prevent an unbalanced blade. An unbalanced blade will cause excessive vibration when rotating at high speeds and may cause damage to the mower.

To insure safe operation of your unit, ALL nuts and bolts must be checked periodically for correct tightness.

DECK

The underside of mower deck should be cleaned after each period of use as grass clippings, leaves, dirt and other matter will accumulate. This accumulation of grass clippings, etc., is undesirable as it will invite rust and corrosion and may cause an uneven discharge of grass clippings at the next cutting.

The deck may be cleaned by tilting the mower forward or on its side and scraping clean with a suitable tool or by washing with a stream of water from a garden hose.



CAUTION

Do not direct the stream of water at a hot engine as damage to the engine may result.

ENGINE OIL

CHECK OIL LEVEL before starting engine and after every 5 hours of operation.

ADD oil as necessary to keep level to **FULL** mark on dipstick.

Before removing dipstick, clean area around oil fill to prevent dirt from entering oil fill hole.

Engine should be in a level position when checking oil.

CHANGE OIL after first 5 hours of operation. Thereafter change every 25 hours. Change oil while engine is warm. Oil may be drained thru drain on bottom of engine. To drain completely, always place engine level when draining thru the bottom. Oil capacity 1-1/4 pints.

AIR CLEANER

CLEAN AIR CLEANER and re-oil element every 25 hours under normal conditions. Clean every few hours under extremely dusty conditions. Poor engine performance and flooding usually indicates that the air cleaner should be serviced. See figure 12.

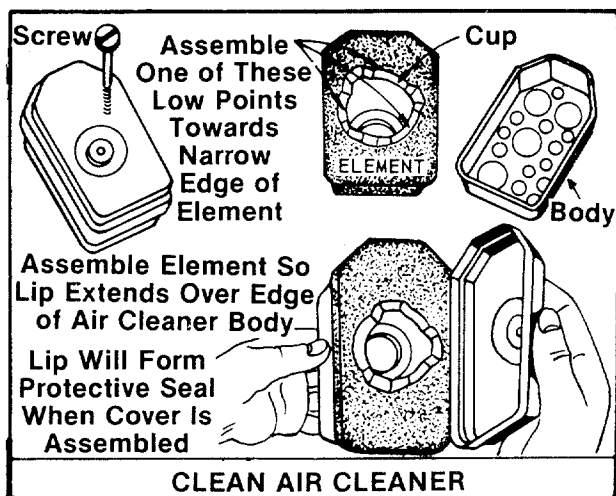

FIGURE 12.

1. Remove screw.
2. Remove air cleaner carefully to prevent dirt from entering carburetor.

3. Take air cleaner apart and clean.
 - a. **WASH** foam element in kerosene or a liquid detergent and water to remove dirt.
 - b. **DRY** foam completely by wrapping and squeezing in a cloth.
 - c. **SOAK** foam with engine oil. Squeeze to distribute and remove excess oil.
4. Reassemble parts and fasten to carburetor.

SPARK PLUG

The spark plug gap should be cleaned (see figure 13) and reset to a 0.030-inch clearance once a season (see figure 14). Spark plug replacement is recommended at the start of each mowing season; check engine parts list for correct plug type.

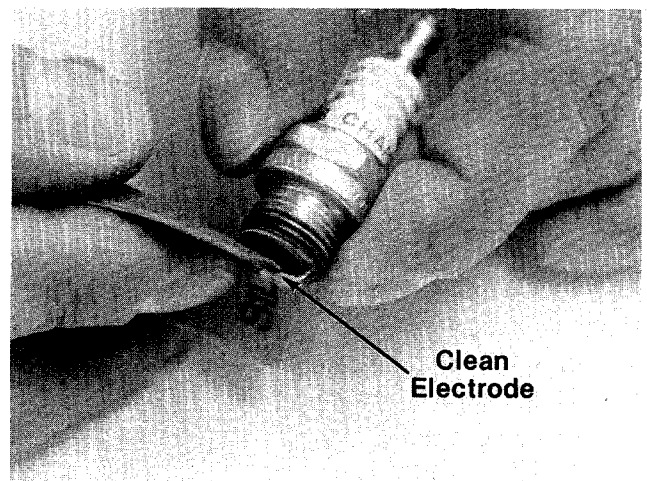

FIGURE 13.

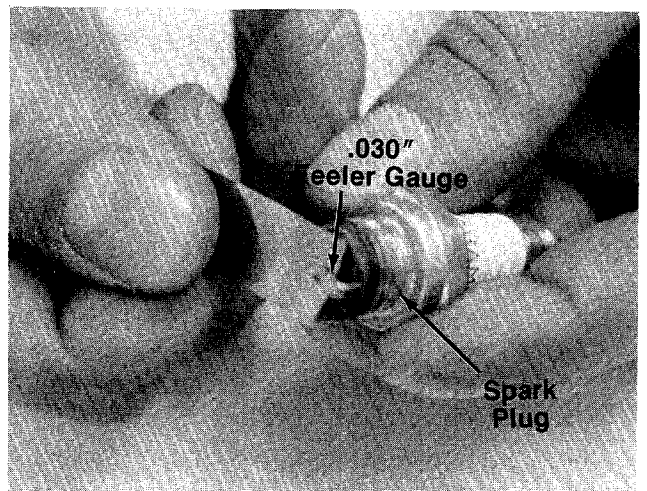

FIGURE 14.

NOTE

Whenever the spark plug is removed for cleaning, it is advisable to replace the spark plug gasket with a new gasket.

USING YOUR ROTARY MOWER

For the best results do not cut wet grass because it tends to stick to the underside of the mower, thus preventing proper discharge of grass clippings. If wet grass must be cut, reduce walking speed to help distribute the clippings more effectively.

New grass should be treated as wet grass, otherwise a normal walking speed is about the right pace for efficient mowing.

The best mowing pattern is one that allows the clippings to discharge towards the uncut part of the lawn. This permits recutting of the clippings to further pulverize them. When cutting high weeds, discharge towards cut portion, then recut at right angles to first direction.

Lawn should be cut in the fall as long as there is growth.

OFF-SEASON STORAGE

The following steps should be taken to prepare lawn mower for storage.

1. Clean and lubricate mower thoroughly as described in the lubrication instructions.
2. Refer to Engine Manual for correct engine storage instructions.
3. Coat mower's cutting blade with chassis grease to prevent rusting.
4. Place blocks under deck to raise tires clear of floor.
5. Store mower in a dry, clean area.

HANDLE STORAGE

The handle may be placed in an upright position for storage.

Move the hairpin cotters to the outer hole on weld pins. See figure 1. Press inward on the bottom of the lower handle and push forward. The handle will lock in this position.

Reverse the above procedure to place the handle in the operating position.

The handle may also be folded away completely for storage.

1. Remove hairpin cotters from inner hole on weld pins on handle mount brackets. Place in outer hole.
2. Loosen the two hand knobs on each side of the handle.

3. Pull inward on the bottom of each side of the lower handle and push forward.
4. Fold the upper handle back and down as shown.

To Take the Handle out of Storage Position.

1. Lift the upper handle up and towards the rear as shown.
2. Pull the handle back until it locks into the operator's position.
3. Tighten the two hand knobs securely.
4. Move the hairpin cotters to the inner hole on the weld pins.

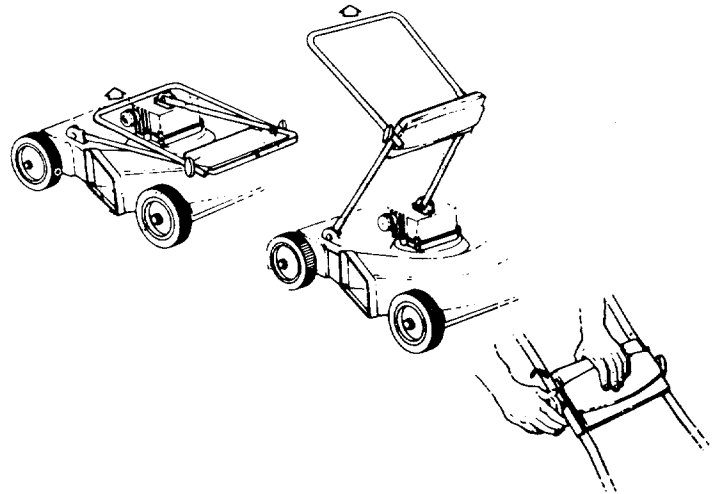

 **NOTE**

The use of any accessory on this Rotary Mower other than those manufactured by the mower manufacturer is **not** recommended.

GRASS CATCHER Model No. 190-003A is available as optional equipment for the mower shown in this manual.



WARNING

1. The mower should not be operated without the entire grass catcher or chute deflector in place.
2. The mower should not be operated without the protective shield on the rear of the deck in place.

 **NOTE:**

Under normal usage bag material is subject to wear and should be checked periodically. Be sure any replacement bag complies with the mower manufacturer's recommendations.

For replacement bags, use only factory authorized replacement bag No. 764-0176.

110-670A

IF YOU WRITE TO US ABOUT THIS ARTICLE
OR IF YOU ORDER REPLACEMENT PARTS AL-
WAYS MENTION THIS MODEL & SERIAL NO
MODEL

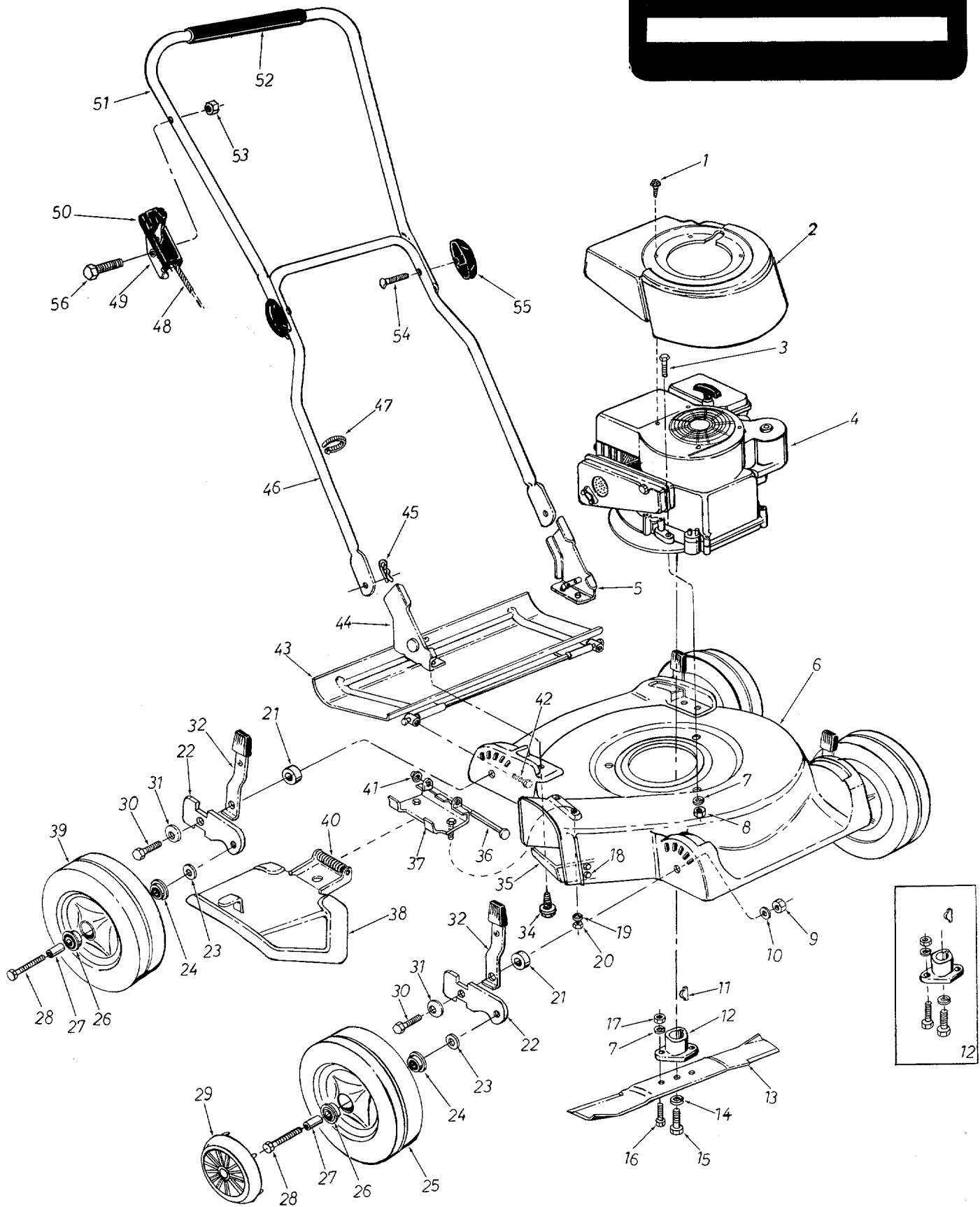

PARTS LIST FOR MODEL 110-670A

REF. NO.	PART NO.	COLOR CODE	DESCRIPTION	NEW PART	REF. NO.	PART NO.	COLOR CODE	DESCRIPTION	NEW PART
1	710-0227		Hex Wash. Hd. AB-Tap Scr. #8-32 x .50"		29	731-0124		Hub Cap	
2	731-0276		Engine Shroud		30	710-0459		Hex Bolt 3/8-24 x 1.50" Lg. H.T.	
3	710-0442		Hex Bolt 5/16-18 x 1.50" Lg.*		31	736-0219		Belleville Wash.	
4	—		Engine		32	10949		Spring Lever Ass'y. w/Knob	
5	12935		Handle Mount Brkt. Ass'y.—L.H.		34	710-0603		Hex Wash. Hd. Self-Tap Scr. 5/16-18 x .50" Lg.	
6	11442	—462	20" Deck Ass'y.		35	11156	—462	Internal Bar	
7	736-0119		L-Wash. 5/16" Scr.*		36	711-0555		Pivot Pin	
8	712-0267		Hex Nut 5/16-18 Thd.*		37	12266	—462	Adapter Plate Ass'y.	
9	712-0711		Hex Jam Nut 3/8-24 Thd.*		38	12245	—462	Chute Deflector Ass'y.—Comp.	
10	736-0169		L-Wash. 3/8" Scr.*		39	734-0845		Rear Wheel Ass'y.—Comp.	
11	714-0365		#6 Hi-Pro Key 5/32 x 5/8" Dia.		40	732-0253		Torsion Spring	
12	10769		Blade Adapter Kit		41	726-0106		Push-On Flange Palnut	
13	742-0123		Blade—20"		42	710-0567		Hex Bolt 1/4-28 x .62" Lg.	
14	736-0217		L-Wash. 3/8" Scr. H.D.		43	11199	—462	Protective Shield	
15	710-0459		Hex Bolt 3/8-24 x 1.50" Lg. H.T.		44	12946		Handle Mount Brkt. Ass'y.—R.H.	
16	710-0117		Hex Bolt 5/16-24 x 1.00" Lg. H.T.		45	714-0104		Hairpin Cotter	
17	712-0123		Hex Nut 5/16-24 Thd.*		46	749-0373		Lower Handle	N
18	710-0252		Hex Bolt 1/4-20 x .75" Lg.*		47	726-0188		Cable Tie	
19	736-0329		L-Wash. 1/4" Scr.*		48	746-0174		Conduit and Wire	
20	712-0117		Hex Nut 1/4-28 Thd.		49	746-0249		Throttle Control Ass'y.—Comp.	
21	748-0195		Shoulder Spacer		50	731-0344		Plastic Cover	
22	10937		Pivot Bar		51	749-0384		Upper Handle	N
23	736-0105		Bell. Wash.		52	718-0145		Grip	
24	741-0484		Ball Bearing		54	710-0405		Curved Hd. Carr. Bolt 5/16-18 x 1.75" Lg.	
25	734-0844		Front Wheel Ass'y. Comp.		55	09966		Hand Knob	
26	741-0267		Ball Bearing		56	710-0606		Hex Bolt 1/4-20 x 1.50" Lg.*	
27	750-0434		Spacer						
28	710-0347		Hex Bolt 3/8-16 x 1.75" Lg.*						

*For faster service obtain standard nuts, bolts and washers locally. If these items cannot be obtained locally, order by part number and size as shown on parts list.

(462—Red Flake)

When ordering parts if color or finish is important, use color code shown at left (e.g. Red Flake Finish—11442 (462).)

NOTE: The engine is not under warranty by the mower manufacturer. . . If repairs or service are needed on the engine, please contact your nearest authorized engine service outlet. Check the "Yellow Pages" of your telephone book under "Engines—Gasoline."



This instruction manual covers various models and all specifications shown do not necessarily apply to your model. Specifications subject to change without notice or obligation.

PARTS INFORMATION

POWER EQUIPMENT PARTS AND SERVICE

Parts and service for all MTD manufactured power equipment are available through the authorized service firms listed below. All orders should specify the model number of your unit, parts number, description of parts and the quantity of each part required.

ALABAMA	BIRMINGHAM	
Auto Electric & Carburetor Co.	2625 4th Ave. S.	35233
ARKANSAS	FORT SMITH	
Mity Mite Motors, Inc.	4515 South 16th Street	72901
	NORTH LITTLE ROCK	
Sutton's Lawn Mower Shop	Rt. 4 Box 368.	72117
CALIFORNIA	PORTERVILLE	
Billious	75 North D Street	93257
	SAN BERNARDINO	
Lawn Mower Supply Co.	25608 E. Baseline	92410
	SAN FRANCISCO	
J.W. Jewett Co.	981 Folsom St.	94107
COLORADO	DENVER	
South Denver Lawn Equip.	527 West Evans	80223
FLORIDA	JACKSONVILLE	
Radco Distributors	2403 Market St.	32206
	OPA LOCKA	
Small Eng. Dist.	2351 N.W. 147th St.	33054
GEORGIA	EAST POINT	
East Point Cycle & Key.	2834 Church St.	30344
ILLINOIS	LYONS	
Keen Edge Co.	8615 Ogden Ave.	60534
INDIANA	ELKHART	
Parts & Sales Inc.	2101 Industrial Pkwy.	46514
IOWA	DUBUQUE	
Power Lawn & Garden Equip.	2551 J.F. Kennedy.	52001
LOUISIANA	NEW ORLEANS	
Suhren Engine Co.	8330 Earhart Blvd.	70118
MARYLAND	TAKOMA PARK	
Center Supply Co.	6867 New Hampshire Ave.	20012
MASSACHUSETTS	SPRINGFIELD	
Morton B. Collins Co.	300 Birnie Ave.	01107
MICHIGAN	LANSING	
Lorenz Service Co.	2500 S. Pennsylvania.	48910
	MOUNT CLEMENS	
Power Equipment Dist.	36463 South Gratiot.	48043
MINNESOTA	HOPKINS	
Hance Distributing Inc.	420 Excelsior Ave. W.	55343
	ST. PAUL	
Power Tools Inc.	3771 Sibley Memorial Hwy.	55122
MISSISSIPPI	BILOXI	
Biloxi Sales & Service, Inc.	506 Caillavet St.	39533
MISSOURI	KANSAS CITY	
Automotive Equip. Service	3117 Holmes St.	64109
	ST. JOSEPH	
Ross-Frazier Supply Co.	8th and Monterey	64503
	ST. LOUIS	
Henzler, Inc.	2015 Lemay Ferry Rd.	63125
NEW JERSEY	BELLMAWR	
Lawnmower Parts Inc.	717 Creek Rd.	08030
	RUTHERFORD	
Feld Distributor	28 Glen Rd.	07070
NEW YORK	CARTHAGE	
Gamble Dist., Inc.	West End Ave.	13619

BRIGGS AND STRATTON, TECUMSEH AND PEERLESS PARTS AND SERVICE

Briggs & Stratton, Tecumseh and Peerless parts and service should be handled by your nearest authorized engine service firm. Check the yellow pages of your telephone directory under the listing **Engines—Gasoline**, Briggs & Stratton or Tecumseh Lauson.

	SYRACUSE	
GTP Leisure Products Inc.	420 Marcellus St.	13204
NORTH CAROLINA	GOLDSBORO	
Smith Hardware Co.	515 N. George St.	27530
	GREENSBORO	
Dixie Sales Company	327 Battleground Ave.	27402
OHIO	CARROLL	
Stebe's Mid-State Mower Supply ...	Box 366-71 High St. ...	43112
	CLEVELAND	
Bleckrie, Inc.	7900 Lorain Ave.	44102
	WADSWORTH	
National Central.	687 Seville Rd.	44281
	YOUNGSTOWN	
Burton Supply Co.	1301 Logan Ave. Box 929 ...	44501
OKLAHOMA	ADA	
Ada Auto Supply	301 E. 12th St.	74820
	MUSKOGEE	
Victory Motors, Inc.	605 S. Cherokee.	74401
	OKLAHOMA CITY	
Forest Sales Inc.	1039 NW 63rd St.	73116
OREGON	PORTLAND	
Kenton Supply Co.	8216 N. Denver Ave. ...	97217
PENNSYLVANIA	CHESTER	
Stull Equipment Corp.	742 W. Front St.	19013
	HARRISBURG	
EECO Inc.	4021 N. 6th St.	17110
	PHILADELPHIA	
Thompson Rubber Co.	5222-24 N. Fifth St. ...	19120
	PITTSBURGH	
Bluemont Co.	11125 Frankstown Rd.	15235
TENNESSEE	KNOXVILLE	
Master Repair Service.	2000 Western Ave. ...	37927
	MEMPHIS	
Memphis Cycle & Supply Co.	421 Monroe Ave.	38103
American Sales & Service, Inc.	1922 Lynnbrook.	38116
TEXAS	DALLAS	
Marr Brothers, Inc.	423 E. Jefferson.	75203
	FORT WORTH	
Woodson Sales Corp.	1702 N. Sylvania	76111
	HOUSTON	
Bullard Supply Co.	2409 Commerce St.	77003
	SAN ANTONIO	
Catto & Putty, Inc.	414 Live Oak	78298
UTAH	SALT LAKE CITY	
A-1 Engine & Mower Co.	437 E. 9th St.	84111
VERMONT	BURLINGTON	
Vermont Hdwe. Co. Inc.	180 Flynn Ave.	05401
VIRGINIA	RICHMOND	
RBI Corp.	963 Myers St.	23260
WASHINGTON	SEATTLE	
Bailey's Inc.	1414 14th Ave.	98102
WEST VIRGINIA	CHARLESTON	
Young's, Inc.	233 Virginia St., E.	25301
WISCONSIN	APPLETON	
Automotive Supply Co.	123 S. Linwood Ave. ...	54911

WARRANTY PARTS AND SERVICE POLICY

The purpose of warranty is to protect the customer from defects in workmanship and materials, defects which are NOT detected at the time of manufacture. It does not provide for the unlimited and unrestricted replacement of parts. Use and maintenance are the responsibility of the customer. The manufacturer cannot assume responsibility for conditions which it has no control. Simply put, if it's the manufacturer's fault, it's the manufacturer's responsibility; if it's the customer's fault, it's the customer's responsibility.

CLAIMS AGAINST THE MANUFACTURER'S WARRANTY INCLUDES

1. Replacement of Missing Parts on new equipment.
2. Replacement of Defective Parts within the warranty period.
3. Repair of Defects within the warranty period.

All claims MUST be substantiated with the following information:

1. Model Number of unit involved.
2. Date unit was purchased or first put into service.
3. Date of failure.
4. Nature of failure.

Free Manuals Download Website

<http://myh66.com>

<http://usermanuals.us>

<http://www.somanuals.com>

<http://www.4manuals.cc>

<http://www.manual-lib.com>

<http://www.404manual.com>

<http://www.luxmanual.com>

<http://aubethermostatmanual.com>

Golf course search by state

<http://golfingnear.com>

Email search by domain

<http://emailbydomain.com>

Auto manuals search

<http://auto.somanuals.com>

TV manuals search

<http://tv.somanuals.com>