



Bosch High Performance HD LED Monitors

UML-273-90 | UML-323-90 | UML-423-90 | UML-553-90



BOSCH

en Installation Manual

Table of contents

1	Safety	5
1.1	Important safety instructions	5
1.2	Safety precautions	8
1.3	Important notices	8
1.4	Customer Support and Service	16
2	Unpacking	18
2.1	Parts List	18
3	Access and Connections	19
3.1	Front Control Panel	19
3.2	Rear Panels	20
3.3	Bottom Panel	24
3.4	Remote Control	25
3.5	Remote Control Battery Installation	26
4	Description	27
4.1	Features	27
4.2	Power	28
5	Installing the Monitor	29
5.1	Ventilation	29
5.2	Connecting Power	29
5.3	Connecting the Composite Video Signal to the Monitor	29
5.4	Connecting the Y/C (S-Video) Signal to the Monitor	30
5.5	Connecting Audio to the Monitor	30
5.6	Connecting the PC Signal to the Monitor	30
5.6.1	HDMI Connection	30
5.6.2	DVI Connection	31
5.6.3	VGA Connection	31
5.7	Connecting an Alarm Trigger	32
5.8	Single / Multiple Monitor Configuration	35
5.9	Accessory Installation	36
5.9.1	Placing the Monitor on a Desktop	37
5.9.2	Mounting the Monitor to a Wall	38
6	Navigating the Monitor	41
6.1	Navigating the Control Panel	41

6.2	Using the Monitor On-screen Display (OSD)	43
6.3	On-screen Display Menus	44
6.4	Picture Menu	45
6.5	Sound Menu	48
6.6	Option Menu	50
6.6.1	PIP Availability	52
6.7	Setting Menu	53
7	Power Management	59
7.1	Power Consumption	59
7.2	LED Indicator	59
8	Troubleshooting	60
9	Maintenance	62
10	Technical Specifications	63

1 Safety

1.1 Important safety instructions

Read, follow, and retain for future reference all of the following safety instructions. Heed all warnings on the unit and in the operating instructions before operating the unit.

1. **Cleaning** - Unplug the unit from the outlet before cleaning. Follow any instructions provided with the unit. Generally, using a dry cloth for cleaning is sufficient, but a moist fluff-free cloth or leather shammy may also be used. Do not use liquid cleaners or aerosol cleaners.
2. **Heat Sources** - Do not install the unit near any heat sources such as radiators, heaters, stoves, or other equipment (including amplifiers) that produce heat.
3. **Ventilation** - Any openings in the unit enclosure are provided for ventilation to prevent overheating and ensure reliable operation. Do not block or cover these openings. Do not place the unit in an enclosure unless proper ventilation is provided, or the manufacturer's instructions have been adhered to.
4. **Water** - Do not use this unit near water, for example near a bathtub, washbowl, sink, laundry basket, in a damp or wet basement, near a swimming pool, in an outdoor installation, or in any area classified as a wet location. To reduce the risk of fire or electrical shock, do not expose this unit to rain or moisture.
5. **Object and liquid entry** - Never push objects of any kind into this unit through openings as they may touch dangerous voltage points or short-out parts that could result in a fire or electrical shock. Never spill liquid of any kind on the unit. Do not place objects filled with liquids, such as vases or cups, on the unit.

6. **Lightning** - For added protection during a lightning storm, or when leaving this unit unattended and unused for long periods, unplug the unit from the wall outlet and disconnect the cable system. This will prevent damage to the unit from lightning and power line surges.
7. **Controls adjustment** - Adjust only those controls specified in the operating instructions. Improper adjustment of other controls may cause damage to the unit. Use of controls or adjustments, or performance of procedures other than those specified, may result in hazardous radiation exposure.
8. **Overloading** - Do not overload outlets and extension cords. This can cause fire or electrical shock.
9. **Power cord and plug protection** - Protect the plug and power cord from foot traffic, being pinched by items placed upon or against them at electrical outlets, and its exit from the unit.
10. **Power disconnect** - Units have power supplied to the unit whenever the power cord is inserted into the power source. The power cord is the main power disconnect device for switching off the voltage for all units.
11. **Power sources** - Operate the unit only from the type of power source indicated on the label. Before proceeding, be sure to disconnect the power from the cable to be installed into the unit.
 - For battery powered units, refer to the operating instructions.
 - For external power supplied units, use only the recommended or approved power supplies.
 - For limited power source units, this power source must comply with *EN60950*. Substitutions may damage the unit or cause fire or shock.
 - If unsure of the type of power supply to use, contact your dealer or local power company.

12. **Servicing** - Do not attempt to service this unit yourself. Opening or removing covers may expose you to dangerous voltage or other hazards. Refer all servicing to qualified service personnel.
13. **Damage requiring service** - Unplug the unit from the main AC power source and refer servicing to qualified service personnel when any damage to the equipment has occurred, such as:
 - the power supply cord or plug is damaged;
 - exposure to moisture, water, and/or inclement weather (rain, snow, etc.);
 - liquid has been spilled in or on the equipment;
 - an object has fallen into the unit;
 - unit has been dropped or the unit cabinet is damaged;
 - unit exhibits a distinct change in performance;
 - unit does not operate normally when the user correctly follows the operating instructions.
14. **Replacement parts** - Be sure the service technician uses replacement parts specified by the manufacturer, or that have the same characteristics as the original parts. Unauthorized substitutions may cause fire, electrical shock, or other hazards.
15. **Safety check** - Safety checks should be performed upon completion of service or repairs to the unit to ensure proper operating condition.
16. **Installation** - Install in accordance with the manufacturer's instructions and in accordance with applicable local codes.
17. **Attachments, changes or modifications** - Only use attachments/accessories specified by the manufacturer. Any change or modification of the equipment, not expressly approved by Bosch, could void the warranty or, in the case of an authorization agreement, authority to operate the equipment.

1.2 Safety precautions

Danger!



High risk: This symbol indicates an imminently hazardous situation such as “Dangerous Voltage” inside the product.

If not avoided, this will result in an electrical shock, serious bodily injury, or death.

Warning!



Medium risk: Indicates a potentially hazardous situation.

If not avoided, this could result in minor or moderate bodily injury.

Caution!



Low risk: Indicates a potentially hazardous situation.

If not avoided, this could result in property damage or risk of damage to the unit.

1.3 Important notices



Accessories - Do not place this unit on an unstable stand, tripod, bracket, or mount. The unit may fall, causing serious injury and/or serious damage to the unit. Use only with the cart, stand, tripod, bracket, or table specified by the manufacturer. When a cart is used, use caution and care when moving the cart/apparatus combination to avoid injury from tip-over. Quick stops, excessive force, or uneven surfaces may cause the cart/unit combination to overturn. Mount the unit per the manufacturer's instructions.

All-pole power switch - Incorporate an all-pole power switch, with a contact separation of at least 3 mm in each pole, into the electrical installation of the building. If it is needed to open the

housing for servicing and/or other activities, use this all-pole switch as the main disconnect device for switching off the voltage to the unit.

Coax grounding:

- Ground the cable system if connecting an outside cable system to the unit.
- Connect outdoor equipment to the unit's inputs only after this unit has had its grounding plug connected to a grounded outlet or its ground terminal is properly connected to a ground source.
- Disconnect the unit's input connectors from outdoor equipment before disconnecting the grounding plug or grounding terminal.
- Follow proper safety precautions such as grounding for any outdoor device connected to this unit.

U.S.A. models only - Section 810 of the *National Electrical Code, ANSI/NFPA No.70*, provides information regarding proper grounding of the mount and supporting structure, grounding of the coax to a discharge unit, size of grounding conductors, location of discharge unit, connection to grounding electrodes, and requirements for the grounding electrode.



Disposal - Your Bosch product was developed and manufactured with high-quality material and components that can be recycled and reused. This symbol means that electronic and electrical appliances, which have reached the end of their working life, must be collected and disposed of separately from household waste material. Separate collecting systems are usually in place for disused electronic and electrical products. Please dispose of these units at an environmentally compatible recycling facility, per *European Directive 2002/96/EC*

Electronic Surveillance - This device is intended for use in public areas only. U.S. federal law strictly prohibits surreptitious recording of oral communications.

Environmental statement - Bosch has a strong commitment towards the environment. This unit has been designed to respect the environment as much as possible.

Electrostatic-sensitive device - Use proper CMOS/MOS-FET handling precautions to avoid electrostatic discharge. NOTE: Wear required grounded wrist straps and observe proper ESD safety precautions when handling the electrostatic-sensitive printed circuit boards.

Fuse rating - For security protection of the device, the branch circuit protection must be secured with a maximum fuse rating of 16A. This must be in accordance with *NEC800 (CEC Section 60)*.

Grounding and polarization - This unit may be equipped with a polarized alternating current line plug (a plug with one blade wider than the other blade). This safety feature allows the plug to fit into the power outlet in only one way. If unable to insert the plug fully into the outlet, contact a locally certified electrician to replace the obsolete outlet. Do not defeat the safety purpose of the polarized plug.

Alternately, this unit may be equipped with a 3-pole grounding plug (a plug with a third pin for earth grounding). This safety feature allows the plug to fit into a grounded power outlet only. If unable to insert the plug into the outlet, contact a locally certified electrician to replace the obsolete outlet. Do not defeat the safety purpose of the grounding plug.

Moving - Disconnect the power before moving the unit. Move the unit with care. Excessive force or shock may damage the unit and the hard disk drives.

Outdoor signals - The installation for outdoor signals, especially regarding clearance from power and lightning conductors and transient protection, must be in accordance with *NEC725* and *NEC800 (CEC Rule 16-224 and CEC Section 60)*.

Permanently connected equipment - Incorporate a readily accessible disconnect device in the building installation wiring.

Pluggable equipment - Install the socket outlet near the equipment so it is easily accessible.

Power resupply - If the unit is forced to power down due to exceeding the specified operating temperatures, disconnect the power cord, wait for at least 30 seconds, and then reconnect the power cord.

Power lines - Do not locate the display near overhead power lines, power circuits, or electrical lights, nor where it may contact such power lines, circuits, or lights.

Rack-mount

- Ventilation - Do not place this unit in a built-in installation or rack without proper ventilation or adhering to the manufacturer's instructions. The equipment must not exceed its maximum operating temperature requirements.
- Mechanical loading - Properly mount the equipment in a rack to prevent a hazardous condition due to uneven mechanical loading.

SELV

All the input/output ports are Safety Extra Low Voltage (SELV) circuits. SELV circuits should only be connected to other SELV circuits.

Because the ISDN circuits are treated like telephone-network voltage, avoid connecting the SELV circuit to the Telephone Network Voltage (TNV) circuits.

System ground/Safety ground

The system ground is only used to comply with safety standards or installation practices in certain countries. Bosch does **not** recommend connecting system ground to safety ground unless it is explicitly required. However, if the system ground and safety ground are connected and grounding loops are causing interference in the video signal, use an isolation transformer (available separately from Bosch).

**Caution!**

Connecting System ground to Safety ground may result in ground loops that can disrupt the CCTV system.

Video loss - Video loss is inherent to digital video recording; therefore, Bosch Security Systems cannot be held liable for any damage that results from missing video information. To minimize the risk of lost digital information, Bosch Security Systems recommends multiple, redundant recording systems, and a procedure to back up all analog and digital information.

**Notice!**

This is a class A product. In a domestic environment this product may cause radio interference, in which case the user may be required to take adequate measures.

FCC & ICES Information

(U.S.A. and Canadian Models Only)

This device complies with *part 15* of the *FCC Rules*. Operation is subject to the following conditions:

- this device may not cause harmful interference, and
- this device must accept any interference received, including interference that may cause undesired operation.

NOTE: This equipment has been tested and found to comply with the limits for a **Class A** digital device, pursuant to *Part 15* of the *FCC Rules* and *ICES-003 of Industry Canada*. These limits are designed to provide reasonable protection against harmful interference when the equipment is operated in a **commercial environment**. This equipment generates, uses, and radiates radio frequency energy and, if not installed and used in accordance with the instruction manual, may cause harmful interference to radio communications. Operation of this equipment in a residential area is likely to cause harmful interference, in which case the user will be required to correct the interference at his expense.

Intentional or unintentional modifications, not expressly approved by the party responsible for compliance, shall not be made. Any such modifications could void the user's authority to operate the equipment. If necessary, the user should consult the dealer or an experienced radio/television technician for corrective action.

The user may find the following booklet, prepared by the Federal Communications Commission, helpful: *How to Identify and Resolve Radio-TV Interference Problems*. This booklet is available from the U.S. Government Printing Office, Washington, DC 20402, Stock No. 004-000-00345-4.

Informations FCC et ICES

(modèles utilisés aux États-Unis et au Canada uniquement)

Ce produit est conforme aux normes *FCC partie 15*. la mise en service est soumise aux deux conditions suivantes :

- cet appareil ne peut pas provoquer d'interférence nuisible et
- cet appareil doit pouvoir tolérer toutes les interférences auxquelles il est soumis, y compris les interférences qui pourraient influencer sur son bon fonctionnement.

AVERTISSEMENT : Suite à différents tests, cet appareil s'est révélé conforme aux exigences imposées aux appareils numériques de **Classe A** en vertu de la *section 15 du règlement de la Commission fédérale des communications des États-Unis (FCC)*. Ces contraintes sont destinées à fournir une protection raisonnable contre les interférences nuisibles quand l'appareil est utilisé dans une **installation commerciale**. Cette appareil génère, utilise et émet de l'énergie de fréquence radio, et peut, en cas d'installation ou d'utilisation non conforme aux instructions, générer des interférences nuisibles aux communications radio. L'utilisation de ce produit dans une zone résidentielle peut provoquer des interférences nuisibles. Le cas échéant, l'utilisateur devra remédier à ces interférences à ses propres frais.

Au besoin, l'utilisateur consultera son revendeur ou un technicien qualifié en radio/télévision, qui procédera à une opération corrective. La brochure suivante, publiée par la Commission fédérale des communications (FCC), peut s'avérer utile : *How to Identify and Resolve Radio-TV Interference Problems* (Comment identifier et résoudre les problèmes d'interférences de radio et de télévision). Cette brochure est disponible auprès du U.S. Government Printing Office, Washington, DC 20402, États-Unis, sous la référence n° 004-000-00345-4.

Disclaimer

Underwriter Laboratories Inc. ("UL") has not tested the performance or reliability of the security or signaling aspects of this product. UL has only tested fire, shock and/or casualty hazards as outlined in UL's *Standard(s) for Safety for Closed Circuit Television Equipment, UL 2044*. UL Certification does not cover the performance or reliability of the security or signaling aspects of this product.

UL MAKES NO REPRESENTATIONS, WARRANTIES, OR CERTIFICATIONS WHATSOEVER REGARDING THE PERFORMANCE OR RELIABILITY OF ANY SECURITY OR SIGNALING RELATED FUNCTIONS OF THIS PRODUCT.

Disclaimer

Underwriter Laboratories Inc. ("UL") has not tested the performance or reliability of the security or signaling aspects of this product. UL has only tested fire, shock and/or casualty hazards as outlined in UL's *Standard(s) for Safety for Information Technology Equipment, UL 60950-1*. UL Certification does not cover the performance or reliability of the security or signaling aspects of this product.

UL MAKES NO REPRESENTATIONS, WARRANTIES, OR CERTIFICATIONS WHATSOEVER REGARDING THE PERFORMANCE OR RELIABILITY OF ANY SECURITY OR SIGNALING-RELATED FUNCTIONS OF THIS PRODUCT.

Copyright

This manual is the intellectual property of Bosch Security Systems and is protected by copyright.

All rights reserved.

Trademarks

All hardware and software product names used in this document are likely to be registered trademarks and must be treated accordingly.

NOTE!

This manual has been compiled with great care and the information it contains has been thoroughly verified. The text was complete and correct at the time of printing. The ongoing development of the products may mean that the content of the user guide can change without notice. Bosch Security Systems accepts no liability for damage resulting directly or indirectly from faults, incompleteness or discrepancies between the user guide and the product described.

1.4 Customer Support and Service

If this unit needs service, contact the nearest Bosch Security Systems Service Center for authorization to return and shipping instructions.

Service Centers

USA

Repair Center-

Telephone: 800-566-2283

Fax: 800-366-1329

E-mail: repair@us.bosch.com

Customer Service

Telephone: 888-289-0096

Fax: 585-223-9180

E-mail: security.sales@us.bosch.com

Technical Support

Telephone: 800-326-1450

Fax: 585-223-3508 or 717-735-6560

E-mail: technical.support@us.bosch.com

Canada

Telephone: 514-738-2434

Fax: 514-738-8480

Europe, Middle East, Africa Region

Repair Center

Telephone: 31 (0) 76-5721500

Fax: 31 (0) 76-5721413

E-mail: RMADesk.STService@nl.bosch.com

Asia Region

Repair Center

Telephone: 65 63522776

Fax: 65 63521776

E-mail: rmahelpdesk@sg.bosch.com

Customer Service

Telephone: 86 (0) 756 7633117 or 86 (0) 756 7633121

Fax: 86 (0) 756 7631710

E-mail: customer.service@cn.bosch.com

Warranty and more information

For additional information and warranty queries, please contact your Bosch Security Systems representative or visit our website at www.boschsecurity.com.

2 Unpacking

This equipment should be unpacked and handled with care. If an item appears to have been damaged in shipment, notify the shipper immediately.

Verify that all the parts listed in the Parts List below are included. If any items are missing, notify your Bosch Security Systems Sales or Customer Service Representative.

The original packing carton is the safest container in which to transport the unit and must be used if returning the unit for service. Save it for possible future use.

2.1 Parts List

Quantity	Description
1	One of the following Color LED Flat Panel Monitors: UML-273-90, UML-323-90, UML-423-90 or UML-553-90
1	Installation manual (printed booklet, English version)
1	Installation manual (CD-ROM, multi-language version)
2	Power Cords, 3-wire with grounded plug 1.8 m (6 ft) long: one with a U.S plug type and one with a European Continental plug type
1	DVI-D to DVI-D cable, 1.8 m (6 ft)
1	VGA to VGA (D-Sub) cable, 1.8 m (6 ft)
1	Trigger cable
1	Remote control
2	AAA batteries

3 Access and Connections

3.1 Front Control Panel

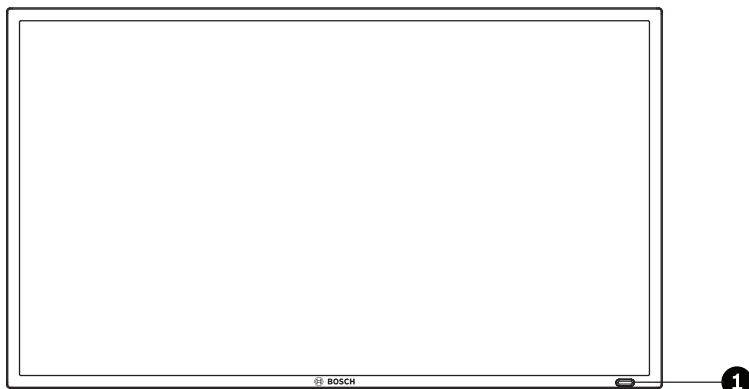

Figure 3.1: UML-273-90/UML-323-90/UML-423-90/UML-553-90 Front Panel

Ref.	Button	Description
1	IR sensor and LED Indicator	Receives the command signals from the remote control.Indicates the operating status of the monitor:Power On (green)Power Off, Standby (red)

3.2 Rear Panels

UML-273-90

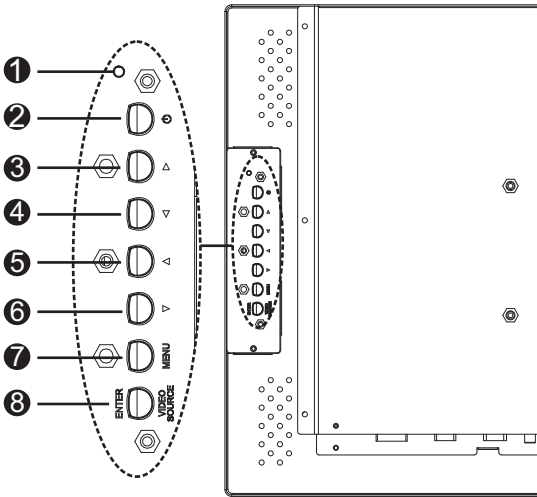

Figure 3.2: UML-273-90 Rear Panel

UML-323-90

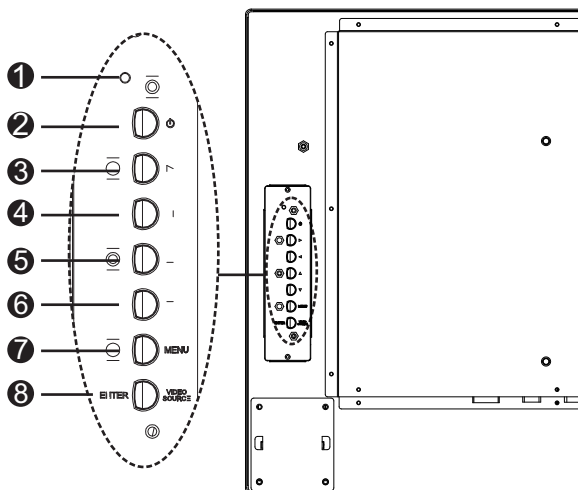

Figure 3.3: UML-323-90 Rear Panel

UML-423-90

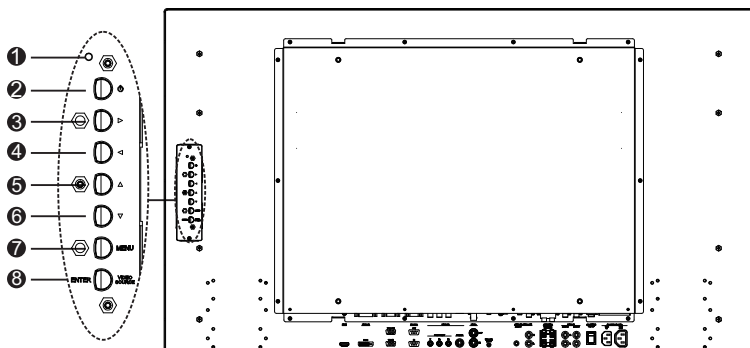

Figure 3.4: UML-423-90 Rear Panel

UML-553-90

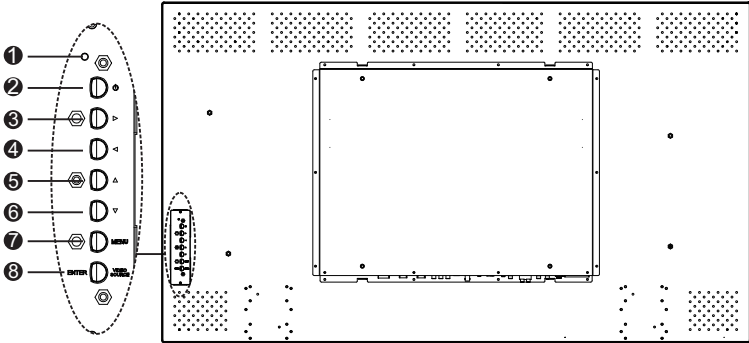





Figure 3.5: UML-553-90 Rear Panel

R ef	Button/ Part	Description	
1	LED Indicator	Indicates the operating status of the monitor: Power On (green) Power Off, Standby (red)	
2	Power	Display Power (On/Off)	
3		Increases the value when in the OSD. Increases audio volume.	Scrolls right in the OSD.
4		Decreases the value when in the OSD. Decreases audio volume.	Scrolls left in the OSD.
5		Adjusts the value when in the OSD.	Scrolls up in the OSD.

6		Adjusts the value when in the OSD. Activates the Auto Adjustment function when in PC mode.	Scrolls down in the OSD.
7	MENU	Selects the on-screen display (OSD).	
8	VIDEO SOURC E/ ENTER	Selects the signal to be displayed. Serves as the “Enter” function for OSD menus.	

3.3 Bottom Panel

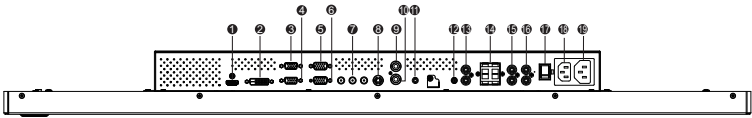
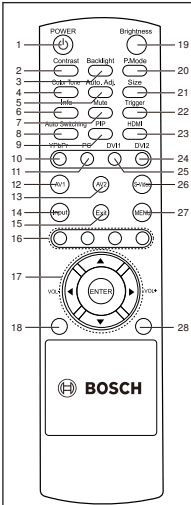

Figure 3.6: Bottom View (I/O Panel)

Re f.	Connector	Re f.	Connector
1	HDMI IN	11	TRIGGER INPUT
2	DVI-D IN	12	AUDIO IN - AUDIO 1
3	VGA OUT	13	AUDIO OUT (R/L)
4	VGA IN	14	SPEAKERS (R/L)
5	RS-232 OUT (for firmware update)	15	AUDIO IN - AUDIO 2
6	RS-232 IN (for firmware update)	16	AUDIO IN - AUDIO 3
7	VIDEO IN - COMPONENT	17	AC SWITCH ON/OFF
8	VIDEO IN - S-VIDEO	18	100 - 240 VAC IN
9	VIDEO OUT	19	100 - 240 VAC OUT
10	VIDEO IN		

3.4 Remote Control

	Re	Button	Description
	f.		
1		POWER	Turns power on and off.
2		Contrast	Adjusts picture contrast.
3		Backlight	Adjusts backlight intensity of LCD panel.
4		Color Tone	Adjusts color temperature of picture.
5		Auto. Adj.	Auto adjusts the graphics adaptor.
6		Info	Displays the settings of the selected input.
7		Mute	Mutes the sound.
8		Auto Switching	Selects the Auto Switch function.
9		PIP	Selects the Picture-in-Picture (PIP) function.
10		YPbPr	Selects YPbPr mode.
11		PC	Selects PC mode.
12		AV 1	Selects AV1 mode.
13		AV 2	no function
14		Input	Selects a signal source to display.
15		Exit	Exits the OSD menu.
16		(no function)	
17		Arrow Keys Enter	Moves the cursor down, up, left, and right in the OSD. Accepts a selection in an OSD menu.

18	(no function)	
19	Brightness	Adjusts picture brightness.
20	P. Mode	Selects the picture mode. Continuously press to change the selection.
21	Size	Selects screen ratio in Video mode. Press to change selection.
22	Trigger	Selects the trigger function.
23	HDMI	Selects HDMI mode.
24	DVI2	no function
25	DVI1	Selects DVI1 mode.
26	S-Video	Selects S-Video mode.
27	MENU	Displays the OSD Main menu. Press to return to the Main menu from anywhere in the OSD menus.
28	(no function)	

3.5 Remote Control Battery Installation

1. Turn the remote over (buttons facing down) and push down on the cover and slide it off.
2. Insert two (2) new AAA alkaline batteries, matching the batteries to the (+) and (-) marks inside the battery case.
3. Slide the battery cover back into place.

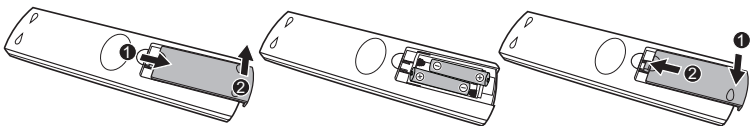

Figure 3.7: Remote Control Battery Replacement

Note: Replace batteries when required or at least once a year. Dispose of used batteries properly.

4 Description

The Bosch High Performance Family of LCD monitors display PAL or NTSC standard color pictures in CCTV systems. One (1) looping Composite Video BNC connector input, one Component Video BNC connector input, three (3) Audio input RCA, and one (1) Y/C (S-Video) input using a 4-pin mini-DIN are included. In addition, each model includes an Analog VGA input using 15-pin D-sub to accommodate the increasing use of PCs and digital video devices in security applications, an HDMI (High Definition Multimedia Input), DVI, PC-RGB (VGA) connectors.

Monitor control functions are accessed via the push buttons and on-screen display (OSD). Refer to *Access and Connections, page 19*, for front panel descriptions.

4.1 Features

- 27-inch, 32-inch, 42-inch and 55-inch models
- NTSC/PAL Auto-Detect
- VGA Input
 - 640 x 480 (60/72/75 Hz)
 - 720 x 400 (70 Hz)
 - 800 x 600 (60/75 Hz)
 - 1024 x 768 (60/75 Hz)
 - 1280 x 768 (60 Hz)
 - 1280 x 960 (60 Hz)
 - 1280 x 1024 (60 Hz)
 - 1366 x 768 (60 Hz)
 - 1600 x 1200 (60 Hz)
 - 1920 x 1080 (60 Hz)
- Composite Video Input
- Component Video Input
- Y/C Input (S-Video)
- DVI Input
- HDMI Input (480i 60Hz, 480p 60Hz, 576i 50 Hz, 576p 50Hz, 720p 50/60Hz, 1080i 50/60Hz, 1080p 50/60Hz)

- Trigger input
- On-screen Display (OSD) with Multiple Languages

4.2 Power

Model No.	Rated Voltage	Voltage Range	Power at Rated Voltage	Sync Format
UML-273-90	120/230 VAC 50/60 Hz	100 to 240 V	< 75 W	NTSC/PAL
UML-323-90	120/230 VAC 50/60 Hz	100 to 240 V	< 75 W	NTSC/PAL
UML-423-90	120/230 VAC 50/60 Hz	100 to 240 V	< 150 W	NTSC/PAL
UML-553-90	120/230 VAC 50/60 Hz	100 to 240 V	< 170 W	NTSC/PAL

5 Installing the Monitor

This chapter outlines the procedures to install the monitor. A qualified service person should install the monitor and adhere to all local codes.

5.1 Ventilation

To prevent overheating, ensure that the ventilation openings on the rear of the monitor are not covered.

5.2 Connecting Power

The Bosch Flat Panel CCTV monitors are delivered with a 3-pole US-style power cord and a 3-pole Euro-style power cord. Use the US-style power cord where 120 VAC, 60 Hz power is available; use the Euro-style power cord where 230 VAC, 50 Hz power is available. The monitor automatically adjusts to either power input voltage.

5.3 Connecting the Composite Video Signal to the Monitor

There is one (1) BNC connector located on the rear panel of the monitor for composite video input and one (1) BNC connector for composite video output (Refer to *Rear Panels*, page 20).

Note: All video inputs are passive loop-through. The impedance is automatically set to 75 ohm by the input of the signal on the input connector, while operating in a single connection mode (refer to , page 35). If a cable is also connected to the output connector, the video signal can be passed on to another monitor connected to it via the passive loop-through function. Up to three (3) monitors may be connected in this manner (refer to , page 35).

Note: To select AV1, press VIDEO SOURCE/ENTER, and then press the Up or Down arrow button, located on the front of the monitor.

5.4 Connecting the Y/C (S-Video) Signal to the Monitor

There is one (1) mini-DIN type connector for the S-Video (Y/C) input (refer to *Rear Panels*, page 20) on the rear side panel.

Note: Both Y and C inputs are terminated with 75 Ohm.

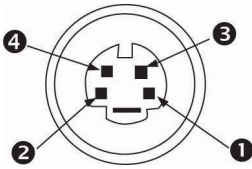

Figure 5.1: Y/C Connector pin-out

Number	Input
1	Ground
2	Ground
3	Y-signal
4	C-signal

5.5 Connecting Audio to the Monitor

There are three (3) set of stereo audio connectors for audio inputs, located on the rear panel. This audio inputs are not associated with any input terminals on the rear panel, and can be freely connected to any audio input.

5.6 Connecting the PC Signal to the Monitor

There are three ways to connect the PC signal to the monitor: HDMI, DVI, and VGA.

5.6.1 HDMI Connection

The monitor can be connected to the HDMI (High Definition Multimedia Input) by connecting a HDMI cable (not supplied).



Figure 5.2: HDMI Input

5.6.2 DVI Connection

The monitor can be connected by using the supplied DVI-D cable and connecting it to the digital DVI-D signal.



Figure 5.3: DVI Input

5.6.3 VGA Connection

You can connect PC signal to the monitor using the VGA connector on the rear panel and a VGA cable (D-SUB to D-SUB).

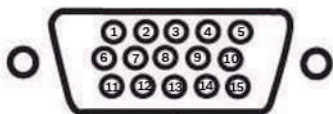

Figure 5.4: VGA Input

Pin	Description	Pin	Description	Pin	Description
1	Red Video	6	Red Ground	11	Ground
2	Green Video	7	Green Ground	12	SDA (for DDC)
3	Blue Video	8	Blue Ground	13	H-Sync or H+V Sync
4	Ground	9	N/A	14	V-Sync
5	Ground	10	Signal Cable Detect	15	SCL (for DDC)

5.7 Connecting an Alarm Trigger

The monitor contains an alarm Trigger Input and a Trigger cable. These components allow you to connect an alarm relay from a device, such as a camera or a door. Connect the two flying leads from the Trigger cable into the relay out ports of the device. Then, route the other end of the cable to the Trigger Input connector of the monitor. The following illustration depicts a typical alarm relay configuration.

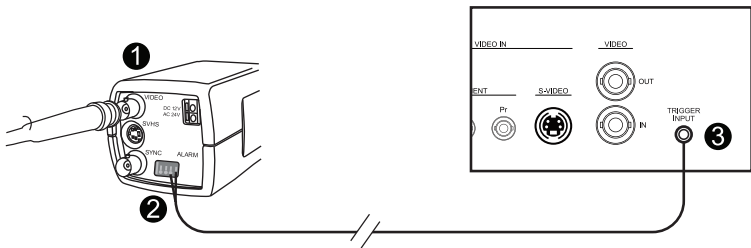

Figure 5.5: Camera to Monitor Relay







Number	Description
1	Dinion Camera
2	Flying Leads Connected to Trigger Outputs 3 and 4
3	UML Back Panel

In the above example, the flying leads of the Trigger cable are connected to Trigger output three and four of a Dinion camera. The cable is routed to the back panel of the UML monitor and the plug-end of the wire is connected to the Trigger Input port. Refer to *Setting Menu*, page 53, for configuring alarm acknowledgement.

Example: Typical Alarm Trigger Configuration

In this case, the Dinion camera is used to watch for motion. When the camera detects motion it sends an alarm to the UML monitor. The monitor, then, switches the input to display the video from the Dinion camera and sounds a buzzer.

1. Route the coax cable from the Dinion Video output to the AV1 input of the UML monitor.
2. Configure the following settings for the Dinion camera:
VMD: OSD
Area: 1
Active: On
3. Connect one flying lead to relay output three, on the back of the Dinion camera, and connect the other to relay output four.
4. Connect the other end of the Trigger Relay cable to the Trigger Input connector on the back of the monitor.
5. Plug the monitor into a power socket; then press the Power button.
6. On the monitor, access the Trigger menu:
Press the Menu button.
Press the Down arrow button to access the Setting menu.
Press the Right arrow button to enter the Setting menu.
Press the Down arrow button until Trigger is highlighted; then press the Right arrow button.
7. Make the necessary changes to the Trigger menu so that the settings match the following:

Picture		
   	Trigger Enable	On
	Trigger Input	AV1
	Buzzer	On
	Trigger Time	10
	Trigger Option	High
 :Move	 :Enter	 :Exit

5.8 Single / Multiple Monitor Configuration

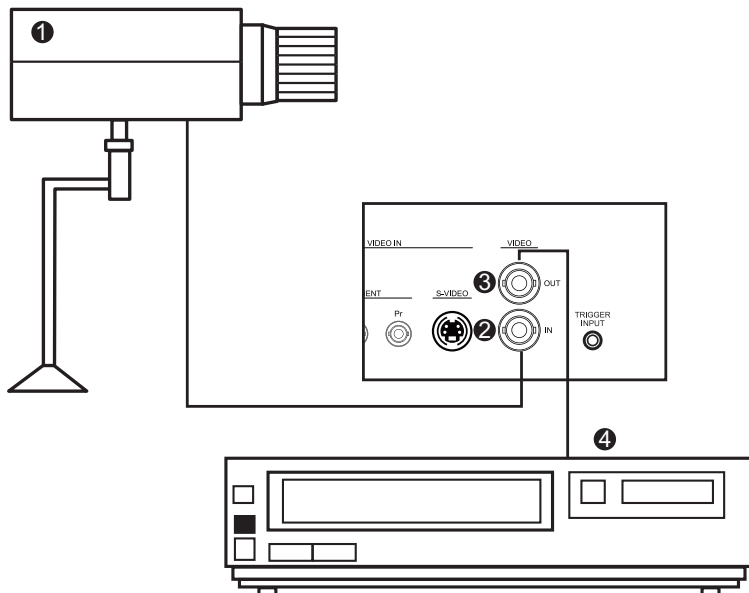

Figure 5.6: Single Monitor Configuration

Ref	Description	Ref	Description
1	Video Camera	3	Video Out
2	Video In	4	DVR

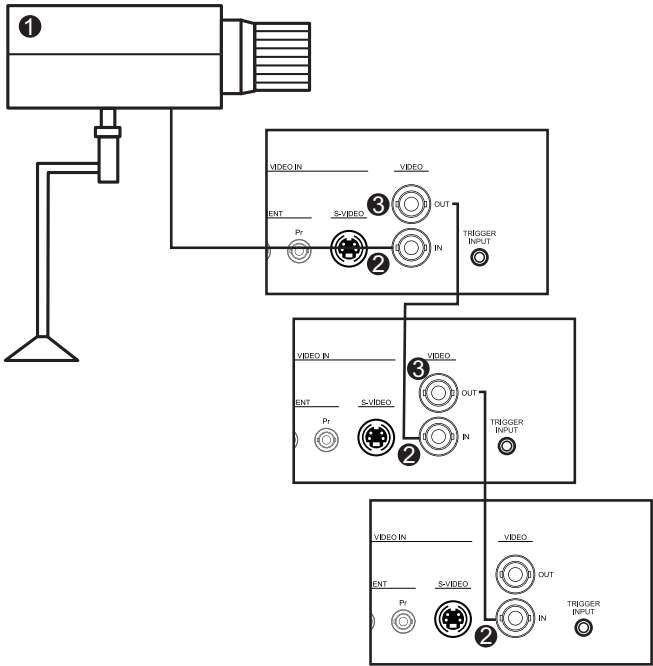

Figure 5.7: Multiple Monitor Configuration

Ref	Description
1	Video Camera
2	Video In
3	Video Out

5.9 Accessory Installation

The monitors can be placed on a desktop or mounted to a wall using mounting accessories that are sold separately. Refer to the Bosch Security Systems, Inc. Web site or contact your local customer support representative for more information.

5.9.1 Placing the Monitor on a Desktop

The following illustrations show how to install the optional stands onto the rear panel of the monitor for a desktop application.

UML-273-90

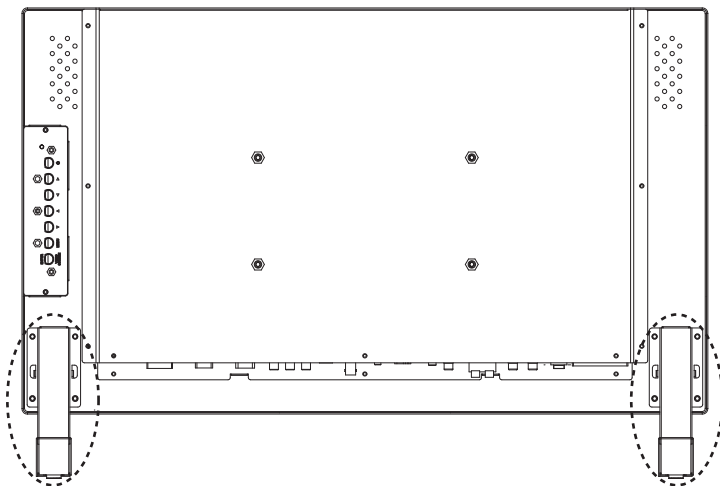

UML-323-90

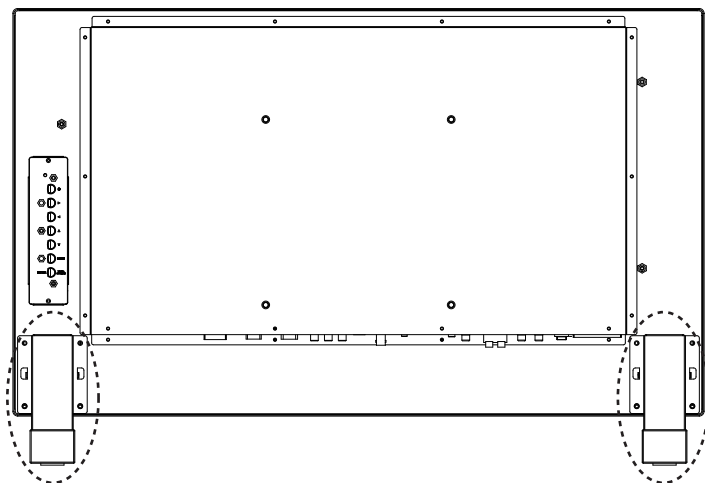

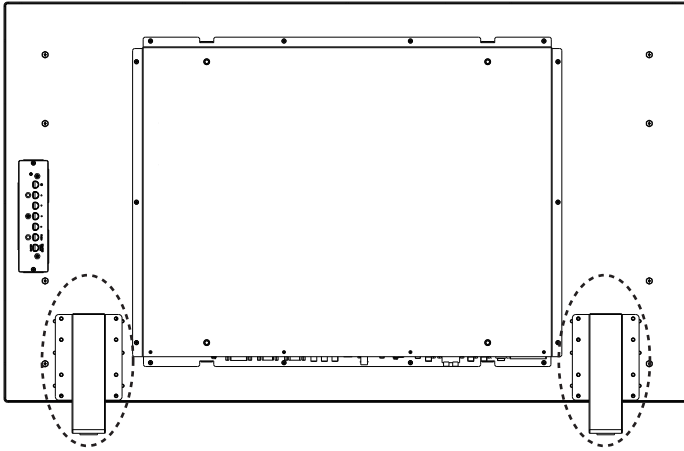
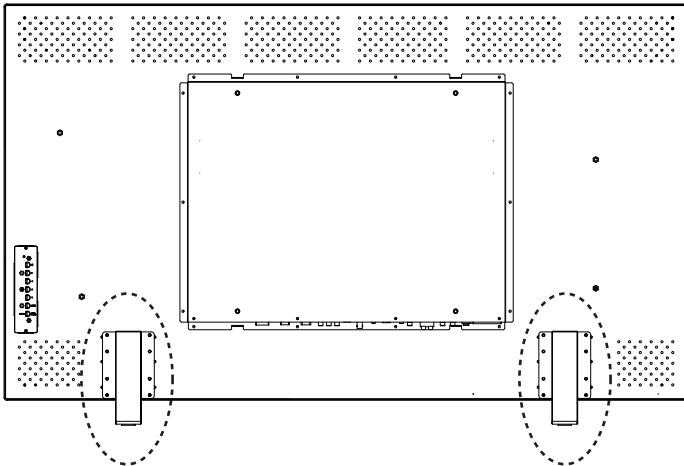
UML-423-90**UML-553-90**

5.9.2 Mounting the Monitor to a Wall

The monitor may be mounted to a wall using the mounting holes and a suitable wall mount or swivel/tilt mount. Use a UL-Listed mounting device. Ensure that the mount is strong enough to bear the weight of the monitor, as follows:

- UML-273-90: 12.35 kg (27.23 lb)
- UML-323-90: 12.5 kg (27.6 lb)
- UML-423-90: 20 kg (44.1 lbs)
- UML-553-90: 32 kg (70.5 lbs)

Refer to the figures below for the dimensions of the mounting holes.

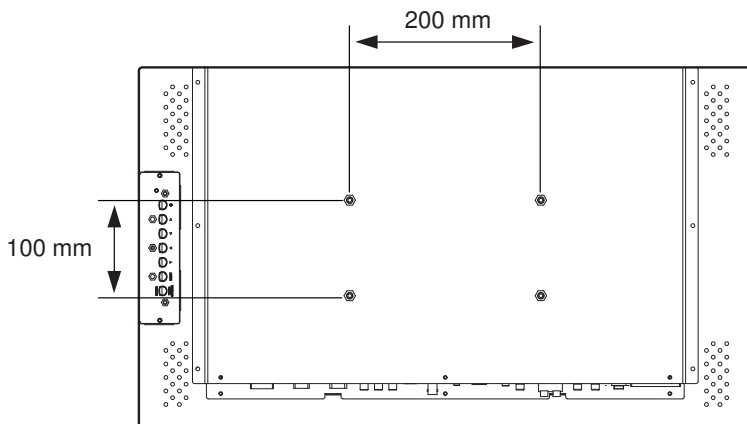

Figure 5.8: UML-273-90 - Location of mounting holes

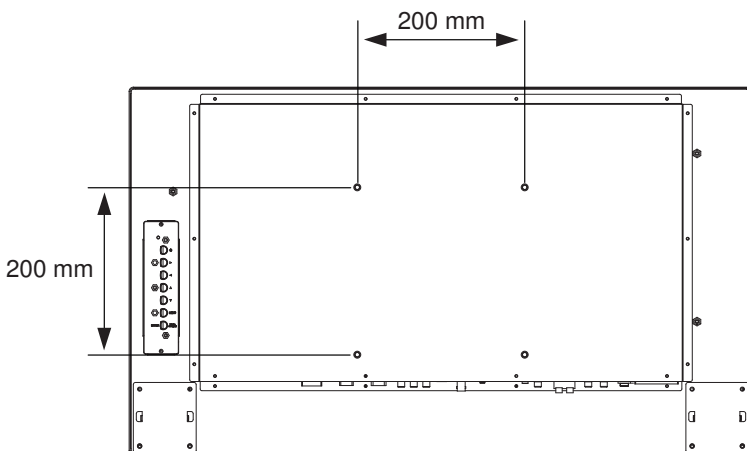

Figure 5.9: UML-323-90 - Location of mounting holes

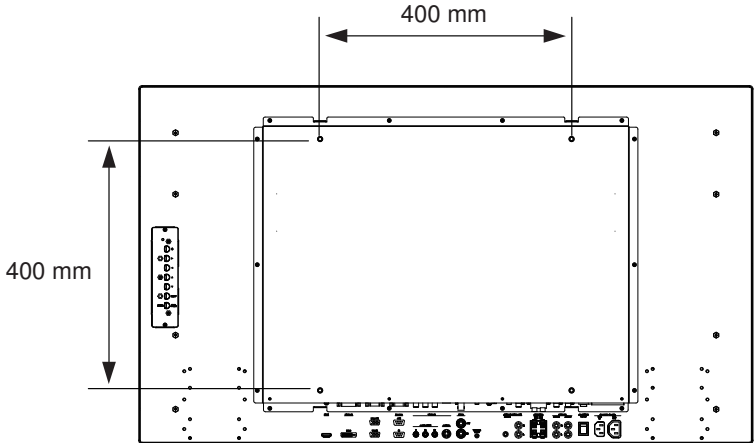

Figure 5.10: UML-423-90 - Location of mounting holes

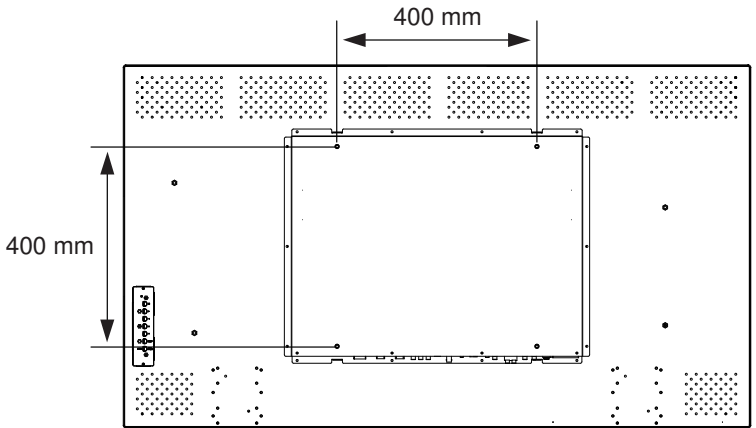

Figure 5.11: UML-553-90 - Location of mounting holes

6 Navigating the Monitor

6.1 Navigating the Control Panel

Use the control panel to make any necessary OSD adjustments. See the figure below for an explanation of the control panel.

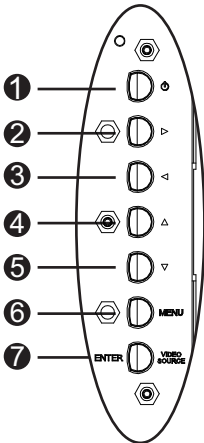





Figure 6.1: Control Panel Buttons

Ref.	Button	Description	
1	Power	Display Power (On/Off) Generate sounds from the input audio signal.	
2		Increases the value when in the OSD. Increases audio volume.	Scrolls right in the OSD.
3		Decreases the value when in the OSD. Decreases audio volume.	Scrolls left in the OSD.
4		Adjusts the value when in the OSD.	Scrolls up in the OSD.
5		Adjusts the value when in the OSD. Auto adjusts when in PC mode.	Scrolls down in the OSD.

6	Menu	Selects the on-screen display (OSD).
7	VIDEO SOURCE/ ENTER	Selects the signal to be displayed Serves as the “Enter” function for OSD menus

6.2 Using the Monitor On-screen Display (OSD)

The LCD is programmed through the on-screen display (OSD) menus and submenus where an operator can select operating parameters. To access the OSD menus, press the Menu button on the control panel. Use these controls to make any necessary adjustments to the OSD.



Notice!





When you are navigating through the OSD menus, use the SOURCE or ENTER button to select a menu and use the MENU button to exit a menu.

To navigate the set up menus, follow the steps below:

1. Connect a video source cable to the monitor.
2. Press the Power button to turn on the unit.
3. If required, press the SOURCE or ENTER button and then the and the up and down arrow buttons until a signal is displayed.
4. Press the Menu button to activate the main menu selections.
5. Press the up and down arrow buttons buttons to select a menu.
6. Press the right arrow button to enter the selected menu.
7. Press the up and down arrow buttons to select a sub-menu item.
8. Press the left and right arrow buttons to toggle the OSD values.
9. Press the Menu button to exit the selected menu and to return to the menu bar or to confirm a selection.
10. Press the Menu button again to exit the OSD menu bar.















6.3 On-screen Display Menu

There are four (4) on-screen menus that allow you to customize your settings. Press the Menu button to access the OSD menu.

Icon	Menu	Function
	Picture	Adjusts picture quality relevant settings. (The menu options differ between input signals.)
	Sound	Adjusts sound relevant settings. (The menu options differ between the Video and PC modes.)
	Option	Adjusts the Aspect Ratio, PIP, Video Source, Auto Adjustment, Clock Frequency, Phase, H Position, V Position, Ambient Light Sensor, and Auto Detection settings.
	Settings	Resets the factory default settings and adjusts the overall monitor settings.
Note: Some of the OSD menu functions may not be available according to the input source detected.		

6.4 Picture Menu

To access the Picture menu, press the Menu button on the front panel of the monitor, then press the Up and Down arrow buttons to select the Picture icon. Press the Left arrow button to enter the menu, and then press the Up and Down arrow buttons to select a submenu. When finished, press the Menu button to save any changes, then press the Menu button again to exit the OSD.







Picture		
	Picture Mode	Standard
	Contrast	50
	Brightness	50
	Color	50
	Tint	50
	Sharpness	5
	Backlight	100
	DCR	OFF
	Color Temp	9300°K
	Input Resolution	
	Blue Screen	ON
 :Move	 :Enter	 :Exit

Submenu	Definition
Picture Mode	Selects the automatic picture control mode. Choices are: Standard: applies factory default values. Vivid: for viewing very bright images. Cinema: for viewing movies. User: creates your own picture settings. This mode is automatically selected after you change the settings in the Picture menu.
Contrast	Adjusts the contrast level for video performance (range 0-100).
Brightness	Adjusts the brightness level for video performance (range 0-100).
Color	Adjusts the overall color intensity of the screen (range 0-100).
Tint	Adjusts the tint of the picture (range 0-100). NTSC only.
Sharpness	Adjusts the sharpness level for video performance (range 0-100).
DCR	When turned on, this function helps enhance image contrast when displaying dark scenes.
Color Temp	Selects the color temperature. Choices are: – 12000°K, 9300°K, and 6500°K . – Options under User: Red, Green, and Blue (range 0-255).

Input Resolution	Sets the resolution of the VGA input. This setting is required when the monitor is unable to detect the VGA input resolution correctly. Choices are Auto, 1366 x 768, 1360 x 768, 1280 x 768.
Blue Screen	Enables or disables video loss indication. Choices are: <ul style="list-style-type: none">- ON: displays a blue background when video loss is detected.- OFF: displays a black background when video loss is detected.

6.5 Sound Menu

To access the Sound menu, press the Menu button on the control panel of the monitor, then press the UP and Down arrow buttons to select the Sound icon. Press the Left arrow button to enter the menu, and then press the Up and Down arrow buttons to select a submenu. When finished, press the Menu button to save any changes, then press the Menu button again to exit the OSD.





Sound		
	Volume	100
	Mute	OFF
	Audio Source	Audio 2
	Speaker	External
		
:Move	:Enter	:Exit

Submenu	Definition
Volume	Controls the built-in speaker volume (range 0-100).

Mute	Enables/disables audio. Choices are: On and Off.
Audio Source	Selects the audio input source. Choices are: Audio 1 (audio signal from the Audio IN connector) and HDMI (audio signal from the HDMI connector).
Speaker	Sets the monitor to play audio using the external speakers, external audio devices (if connected), or built-in (internal) speaker. Choices are: External, Line-Out, and Internal.

6.6 Option Menu

To access the Option menu, press the Menu button on the control panel of the monitor, then press the UP and Down arrow buttons to select the Option icon. Press the Left arrow button to enter the menu, and then press the Up and Down arrow buttons to select a submenu. When finished, press the Menu button to save any changes, then press the Menu button again to exit the OSD.

Options		
	Aspect Ratio	Full
	PIP	
	Video Source	AV
	Auto Adjustment	External
	Clock Frequency	
	Phase	
	H Position	
	V Position	
	Ambient Light Sensor	
	Auto Detection	
 :Move	 :Enter	 :Exit

Submenu	Definition
Aspect Ration	Selects the Aspect Ratio mode. Choices are: Full and Original .

PIP	<p>Sets the PIP relevant settings.</p> <ul style="list-style-type: none"> – PIP Enable: activates the PIP feature. – Main Input and Sub Input: selects the video input source for the main picture and the sub picture. Refer to <i>PIP Availability, page 52</i>, for the availability of the input source combinations. – PIP Size: selects the size of the sub picture. Choices are: Large and Small. – PIP Position: adjusts the position of the sub picture on the main picture. Press the arrow buttons to make adjustments.
Video Source	<p>Selects the video input source. Choices are: AV, S-Video, VGA, YPbPr, DVI, and HDMI.</p>
Auto Adjustment	<p>Auto synchronizes the screen to the graphics adaptor.</p>
Clock Frequency	<p>Adjusts the monitor's clock frequency (range 0-31).</p>
Phase	<p>Adjusts the monitor's phase range (range 0-31).</p>
H Position	<p>Adjusts the monitor's horizontal position (range 0-31).</p>
V Position	<p>Adjusts the monitor's vertical position (range 0-31).</p>
Ambient Light Sensor	<p>Sets the ambient light sensor. Once enabled, the monitor automatically adjusts the image brightness as the ambient lighting conditions change. Choices are: High, Low, and OFF.</p>
Auto Detection	<p>Allows the monitor to automatically switch to and display an available input signal.</p>







6.6.1 PIP Availability

The table below summarizes the availability of the input source combinations for the PIP feature. (A “+” indicates an allowed combination, a blank cell indicates the combination is not allowed).

		Main Picture Input Source					
		AV	S-Video	Comp.	PC	DVI	HDMI
Sub Picture	AV					+	+
	S-Video					+	+
	Comp.					+	+
	PC						
	DVI	+	+	+			
	HDMI	+	+	+			

6.7 Setting Menu

To access the Setting menu, press the Menu button on the control panel of the monitor, then press the UP and Down arrow buttons to select the Setting icon. Press the Left arrow button to enter the menu, and then press the Up and Down arrow buttons to select a submenu. When finished, press the Menu button to save any changes, then press the Menu button again to exit the OSD.

Setting		
   	Language	English
	Overscan	OFF
	Key Lock	OFF
	Trigger	
	Schedule	
	Display Wall	
	Power Save	OFF
	Set Monitor ID	1
	Image Retention	ON
	Auto Adjustment	ON
	Advanced	
 :Move	 :Enter	 :Exit

Submenu	Definition
Language	Adjusts the language of the OSD. Choices are: English, French, Spanish, Dutch, German, Italian, Portuguese, Russian, Polish, Simplified Chinese and Japanese.
Overscan	Turns the overscan function on or off when displaying video (non-PC) signals
Key Lock	Enables or disables the Key Lock function.
Trigger	<p>Enables or disables the Trigger function, and configures the trigger settings when enabled:</p> <ul style="list-style-type: none"> – Trigger Enable: turns the Trigger function ON or OFF. – Trigger Input: selects the input signal source to display when a trigger signal is received. – Buzzer: turns the trigger buzzer tone ON or OFF. – Trigger Time: sets the time duration the trigger input (as set by the Trigger Input function) is displayed. Once the time expires, the monitor automatically switches back to the last viewed input. – Trigger Option: sets the trigger signal type: N/C (normal closed), N/O (normal opened), High (2~5V) or Low (0~0.6V).

Schedule

This function allows you to program up to seven (7) different scheduled time intervals for the monitor. You can select the time the monitor turns on and turns off, the days in a week it is activated, and which input source the display will use for each scheduled activation period.

- **Date and Time:** Sets up current date and time for the monitor's internal clock before using the Schedule function. Choices are Year, Month, Day, Hour, Minute, Daylight Saving Time. Once done, you will see the current date and time in this menu.
- **Schedule:** Sets up to seven (7) schedule time intervals with different video input modes.

Note:

- If you do not want to use a power on time, select "--" for the power on hour slot, and "00" for the minute slot. The monitor will only turn off at the time you set.
- If you do not want to use a power off time, select "--" for the power off hour slot, and "00" for the minute slot. The display will only turn on at the time you set.
- If no input source is selected, the default input source (Video) will be used.
- If Every Day is selected, the monitor will turn on everyday regardless of other day settings (for example, Monday, Tuesday, Wednesday...).
- Should schedule periods overlap, the power on time has priority over power off time. For example, if schedule item #1 sets the monitor to power on at 10:00 AM and off at 5:00 PM, and schedule item #2 sets

	<p>the display to power on at 4:00 PM and off at 9:00 PM on the same day, then the monitor will power on at 10:00 AM and off at 9:00 PM.</p> <ul style="list-style-type: none"> - If there are multiple schedule items programmed for the same time period, then the highest numbered schedule item has priority. For example, if schedule items #1 and #2 both set the display to power on at 7:00 AM and off at 5:00 PM, then only schedule item # 1 will take effect.
Display Wall	<p>If multiple monitors are tiled to form a display wall, use this function to set up the display wall settings:</p> <ul style="list-style-type: none"> - H Monitors: selects the number of displays on the horizontal side (range 1-10). - V Monitors: selects the number of displays on the vertical side (range 1-10). - H Position: selects the horizontal position of the monitor in the display wall matrix (range 1-10). - V Position: selects the vertical position of the monitor in the display wall matrix (range 1-10). - Frame Comp.: turns frame compensation on or off. If turned on, the monitor adjusts the image to compensate for the width of the bezels in order to accurately display the image.

<p>Power Save</p>	<p>Sets the monitor to reduce the power consumption:</p> <ul style="list-style-type: none"> - Eco: all sources can enter the power saving mode, but only a VGA signal can wake up the monitor or you have to press the Power button to wake up the monitor when other source is connected. - Standard: all source can enter the power saving mode and wake up the monitor. - Off: if no source is detected, the backlight remains on. - VGA Only: only a VGA signal can enter the power saving mode and wake up the monitor.
<p>Set Monitor ID</p>	<p>Sets the ID number for controlling the monitor via the RS 232 connection. Each monitor must have a unique ID number when multiple monitors are connected. Each monitor's ID is defined by its position within the matrix - starting on the top row, working left to right. The top left monitor will have an ID of 1. When you reach the end of the row, the next number will refer to the monitor one row down, starting at the left.</p>
<p>Image Retention</p>	<p>If turned on, the LCD monitor automatically displays swift moving patterns to prevent the formation of image retention on the screen.</p>

Auto Adjustment	Turns on or off to let the monitor auto synchronizes screen to graphics adaptor.
Advanced	<ul style="list-style-type: none"> – Restore User Default: restores default settings. – OSD Info Box: when turned ON, the monitor always displays the current input source and resolution. Select OFF to display the information box only when you press Info on the remote control. – Thermal (°C): displays the thermal status (temperature) inside the display. – Ambient Light (Lux): displays the ambient brightness detected by the display's sensor. – 5V Detect (V): displays the 5V voltage detection result. – 12V Detect (V): displays the 12V voltage detection result. – Operating Time (Day & hr): displays the duration the display has been turned on. – Input Source: displays the selected input source.

Notice!

When Key Lock is enabled through the front panel, use the front panel buttons to disable the key lock command. To disable the Key Lock feature using the front panel buttons, press and hold both the INPUT (or ENTER) and the MENU buttons until the monitor displays the Key Unlocked message.

7 Power Management

These monitors feature a power management system to “power down” upon receipt of the display power management signaling (DPMS) from a DPMS video card.

The DPMS-compliant video card performs this signaling by not sending a horizontal, vertical, or a sync signal.

The monitor enters an appropriate mode through identifying each of the three (3) modes of the signaling system.

7.1 Power Consumption

Mode	Power Consumption			
	UML-273-9 0	UML-323-90	UML-423-90	UML-553-90
ON	75 W	75 W	150 W	170 W
ACTIVE OFF	0.5 W	0.5 W	0.5 W	0.5 W

7.2 LED Indicator

The power management feature of the monitor is comprised of these stages:

Mode	LED Color	Monitor Operation
ON	Green	Normal Operation
UNSUPPORTED MODE	Green	Normal operation but the screen displays an error message.
POWER OFF	Red	Not Operational

8 Troubleshooting

Problem	Solution
No image displayed on screen	<ul style="list-style-type: none"> - Check that the power cord of the monitor is securely connected into the wall outlet or grounded extension cable or strip. - Power switch should be in the ON position and the LED lit. - Check that the Brightness and/or Contrast adjustments of the display have not been turned down to minimum levels.
Display image is not centered, is too small or too large in the PC mode	<p>Push the down arrow key to activate the Auto Adjust function.</p> <p>- or -</p> <p>Adjust the Frequency and Phase in the PC OSD submenu.</p>
Vertical or horizontal noise is present in the picture	<p>Push the down arrow key to activate the Auto Adjust function.</p> <p>- or -</p> <p>Adjust the Frequency and Phase in the PC OSD submenu.</p>

Problem	Solution
Incorrect colors	Select a color temperature in the Color Tone menu. - or - Use the Reset function to reset to the default settings.
The error message “Out of Range” is displayed	PC is operating with either a resolution or timing mode that is not supported by the monitor. Change the PC timing mode to one of the valid combinations below: <ul style="list-style-type: none">- 640 x 480 (60/72/75Hz)- 720 x 400 (70Hz)- 800 x 600 (60/75Hz)- 1024 x 768 (60/75Hz)- 1280 x 768 (60Hz)- 1280 x 960 (60Hz)- 1280 x 1024 (60Hz)- 1366 x 768 (60Hz)- 1600 x 1200 (60Hz)- 1920 x 1080 (60Hz)

9 Maintenance

To clean the LCD panel, wipe off water droplets or oil immediately with absorbent cotton or a soft lint-free cloth. Staining and discoloration may occur if left on the panel for long periods. If the surface (polarizer) of the LCD panel is dirty or stained, use absorbent cotton or a soft lint-free cloth to remove the residue as follows:

1. Turn off the display and disconnect it from the power supply.
2. Do not spray any liquid directly on the screen. Dampen a clean, soft, lint-free cloth with water only (using a paper towel or dirty cloth can scratch the screen).
3. Gently wipe the screen starting from the top of the screen to bottom wiping in a downward motion. Be careful not to press too hard to avoid damaging the screen.
4. To avoid streaking, wipe the screen again with another clean, dry, lint-free cloth.



Notice!

If water does not work, use a mild cleaner labeled for use with LCD panels, available at office supply stores.

Do not use any of the following as a cleaning agent:

- Ketone type materials
- Ethyl alcohol
- Ethyl acid
- Toluene
- Methyl chloride
- Ammonia

Use of these materials may permanently damage the polarizer due to a chemical reaction.

10 Technical Specifications

Model	UML-273-90	UML-323-90
LCD Specifications		
LCD Type	27-in. Digital LCD	32-in. Digital LCD
Backlight Type	LED	LED
Pixel Pitch (H x V)	0.31125 x 0.31125	0.3637 x 0.3637
Brightness	300 cd/m ² (typical)	350 cd/m ² (typical)
Contrast Ratio	3000:1 (typical)	3000:1 (typical)
Response Time	12 ms (typical)	6.5 ms (typical)
Resolution (H x V)	1920 x 1080	1920 x 1080
Frequency	Horizontal: 60 - 73 KHz Vertical: 47 - 63 Hz	Horizontal: 60 - 73 KHz Vertical: 47 - 63 Hz
Input Signal	Video (BNC 1ch input 1.0 Vp-p, 75 Ohm terminated, loop-through out) S-Video (Mini Din 4-pin 1ch input (Y/C)) Component (YPbPr, RCA) HDMI DVI-D PC RGB (D-Sub connector) Audio In (L/R) x 2 Line In (3.5 mm) Trigger In RS-232 (D-Sub 9 pin)	

Model	UML-273-90	UML-323-90
Output Signal	Video (BNC 1ch input 1.0 Vp-p, 75 Ohm terminated, loop-through out) Audio Out (L/R) External Speaker PC RGB (D-Sub Connector) RS-232 (D-Sub 9 pin)	
Active Display Area (H x V)	597.6 x 336.15 mm (23.53 x 13.23 in.)	698.4 mm x 392.85 mm (27.5 x 15.5 in.)
Packing Dimensions (W x H x D)	756 x 561 x 253 mm (29.76 x 22.09 x 9.96 in.)	910 x 608 x 205 mm (35.83 x 23.94 x 8.1 in.)
Net Weight	9.05 kg (with stand) (19.95 lb)	12.5 kg (27.6 lb)
Gross Weight	12.35 kg (27.23 lb)	15.1 kg (33.3 lb)
Electric Ratings	120/230 VAC, 50/60 Hz	120/230 VAC, 50/60 Hz

Model	UML-423-90	UML-553-90
LCD Specifications		
LCD Type	42-in. Digital LCD	55-in. Digital LCD
Backlight Type	LED	LED
Pixel Pitch (H x V)	0.4845 x 0.4845 mm	0.21 x 0.21 mm
Brightness	500 cd/m ² (typical)	450 cd/m ² (typical)
Contrast Ratio	4000:1 (typical)	4000:1 (typical)
Response Time	8 ms (typical)	6.5 ms (typical)
Resolution (H x V)	1920 x 1080	1920 x 1080
Frequency	Horizontal: 60 - 73 KHz Vertical: 47 - 63 Hz	Horizontal: 60 - 73 KHz Vertical: 47 - 63 Hz
Input Signal	Video (BNC 1ch input 1.0 Vp-p, 75 Ohm terminated, loop-through out) S-Video (Mini Din 4-pin 1ch input (Y/C)) Component (YPbPr, RCA) HDMI DVI-D PC RGB (D-Sub connector) Audio In (L/R) x 2 Line In (3.5 mm) Trigger In RS-232 (D-Sub 9 pin)	
Output Signal	Video (BNC 1ch input 1.0 Vp-p, 75 Ohm terminated, loop-through out) Audio Out (L/R) External Speaker PC RGB (D-Sub Connector) RS-232 (D-Sub 9 pin)	

Model	UML-423-90	UML-553-90
Active Display Area (H x V)	930.24 x 523.26 mm (36.6 x 20.6 in.)	1209.6 x 680.4 mm (47.6 x 26.8 in.)
Packing Dimensions (W x H x D)	1234 x 786 x 275 mm (48.6 x 30.9 x 10.8 in.)	1379 x 850 x 273 mm (54.3 x 33.5 x 10.7 in.)
Net Weight	20 kg (44.1 lbs)	32 kg (70.5 lbs)
Gross Weight	26 kg (57.3lbs)	37 kg (81.6 lbs)
Electric Ratings	120/230 VAC, 50/60 Hz	120/230 VAC, 50/60 Hz

Bosch Security Systems, Inc.

850 Greenfield Road

Lancaster, PA, 17601

USA

www.boschsecurity.com

© Bosch Security Systems, Inc., 2013

Free Manuals Download Website

<http://myh66.com>

<http://usermanuals.us>

<http://www.somanuals.com>

<http://www.4manuals.cc>

<http://www.manual-lib.com>

<http://www.404manual.com>

<http://www.luxmanual.com>

<http://aubethermostatmanual.com>

Golf course search by state

<http://golfingnear.com>

Email search by domain

<http://emailbydomain.com>

Auto manuals search

<http://auto.somanuals.com>

TV manuals search

<http://tv.somanuals.com>