



**HBN 13M5.O**



**Installing and  
Operating Instructions**



**Household Appliances**

Internet: <http://www.bosch-hausgeraete.de>  
Bosch Info-Team: de Tel. 01 80/5 30 40 50 (€ 0,12/Min. DTAG)

**BOSCH**

## **Making cooking as much fun as eating**

Please read this instruction manual. This will ensure that you make use of all the technical benefits the cooker has to offer.

It will provide you with important safety information. You will then be familiarised with the individual components of your new cooker. And we will show you how to make settings step by step. It is quite simple.

The tables list the settings and shelf positions for numerous well-known dishes. All these dishes are tested in our cooking studio.

In the unlikely event of a fault, look here for information on how to rectify minor faults yourself.

A detailed table of contents will help you to find your way around quickly.

Enjoy your meal!

# Table of contents

<b>Important information</b> . . . . .	<b>6</b>
Before installation . . . . .	6
Safety information . . . . .	6
Reasons for damage . . . . .	7
<b>Your new cooker</b> . . . . .	<b>8</b>
The control panel . . . . .	8
Temperature selector (hot air) – Main oven . . . . .	8
Function selector – Mini oven . . . . .	9
Temperature selector – Mini oven . . . . .	9
Control buttons and display panel . . . . .	10
Push-in control knobs . . . . .	10
Types of heating – Main oven . . . . .	11
Types of heating – Mini oven . . . . .	12
Oven and shelving accessories . . . . .	13
Cooling fan . . . . .	14
<b>Before using for the first time</b> . . . . .	<b>14</b>
Heating up the oven . . . . .	14
Pre-cleaning the accessories . . . . .	14
<b>Setting the oven</b> . . . . .	<b>15</b>
Setting procedure – Main oven . . . . .	15
Setting procedure – Mini oven . . . . .	16
If the oven is to switch off automatically – Main oven . . . . .	17
If the oven is to switch on and off automatically – Main oven . . . . .	18
<b>Time</b> . . . . .	<b>19</b>
Setting procedure . . . . .	19

# Table of contents

<b>Timer</b> .....	<b>20</b>
Setting procedure .....	20
<b>Basic settings – Main oven</b> .....	<b>21</b>
Changing the basic settings .....	22
<b>Childproof lock</b> .....	<b>23</b>
<b>Care and cleaning</b> .....	<b>23</b>
Oven exterior .....	23
Oven .....	24
Cleaning the glass panels – Main and Mini oven ...	26
Cleaning the rails .....	29
Seal .....	29
Accessories .....	29
<b>Troubleshooting</b> .....	<b>30</b>
Replacing the oven light .....	30
<b>After-sales service</b> .....	<b>31</b>
<b>Packaging and old appliances</b> .....	<b>32</b>
<b>Tables and tips</b> .....	<b>33</b>
Cakes and pastries .....	33
Baking tips .....	36
Meat, poultry, fish .....	37
Tips for roasting and grilling .....	39
Defrosting – Main oven .....	39
Energy saving tips .....	40
<b>Acrylamide in food</b> .....	<b>40</b>
What can you do? .....	41
<b>Test dishes</b> .....	<b>42</b>

## Table of contents

---

<b>Assembly instructions</b> .....	<b>43</b>
<b>For the installer and kitchen expert</b> .....	<b>43</b>
Important installation notes .....	43
Installation of the built-in oven .....	44

---

---

# Important information

Read this instruction manual carefully.

Only then will you be able to operate your cooker safely and correctly.

Please keep the instruction and installation manual in a safe place. Please pass on the instruction manual to the new owner if you sell the appliance.

---

## Before installation

### Transport damage

Check the appliance after unpacking it. Do not connect the appliance if it has been damaged in transport.

### Electrical connection

The cooker may only be connected by an approved specialist. Losses resulting from damage caused by incorrect connection will invalidate warranty claims.

---

## Safety information

This appliance is intended for domestic use only. Only use the cooker for food preparation.

### Hot oven



Open the oven door carefully. Hot steam may escape.

Never touch the internal surfaces of the oven or the heating elements. There is a risk of burning. Children must be kept at a safe distance from the appliance.

Never store combustible items in the oven. Risk of fire.

Never clamp leads of electrical appliances in the hot oven door. The insulation on the leads could melt. There is a risk of short-circuiting.

## Repairs



Incorrectly done repairs are dangerous.

There is a risk of electrocution.

Repairs may only be carried out by after-sales service technicians who have been fully trained by BSH.

If there is a fault, switch off the oven fuse at the fuse box. Call the after-sales service.

---

## Reasons for damage

### **Baking tray, aluminium foil or dishes on the oven floor**

Do not place the baking tray on the oven floor.

Do not cover it with aluminium foil.

Do not place dishes on the oven floor.

This will cause heat accumulation. The baking and roasting times will no longer be correct and the enamel will be damaged.

### **Slide-in accessories**

To avoid damage, insert slide-in accessories carefully.

### **Water in the oven**

Never pour water directly into a hot oven.

This could damage the enamel.

### **Fruit juice**

When baking very moist fruit cakes, do not put too much on the baking sheet. Fruit juice dripping from the baking sheet leaves stains that cannot be removed.

It is recommended that you use the deeper universal pan.

### **Cooling with the oven door open**

Only leave the oven to cool with the door closed. Do not allow anything to become trapped in the oven door. Even if you only leave the oven door open slightly, the fronts of adjacent units may become damaged over time.

### **Very dirty oven seal**

If the oven seal is very dirty, the oven door will no longer close properly when the oven is in use. The fronts of adjacent units could be damaged. Keep the oven seal clean.

### **Using the oven door as a seat**

Do not stand or sit on the oven door.

# Your new cooker

Here you will learn more about your new oven. The control panel and its switches and indicators are explained here. The heating modes and the accessories included with your oven will be explained here.

## The control panel

Details vary according to the appliance model.

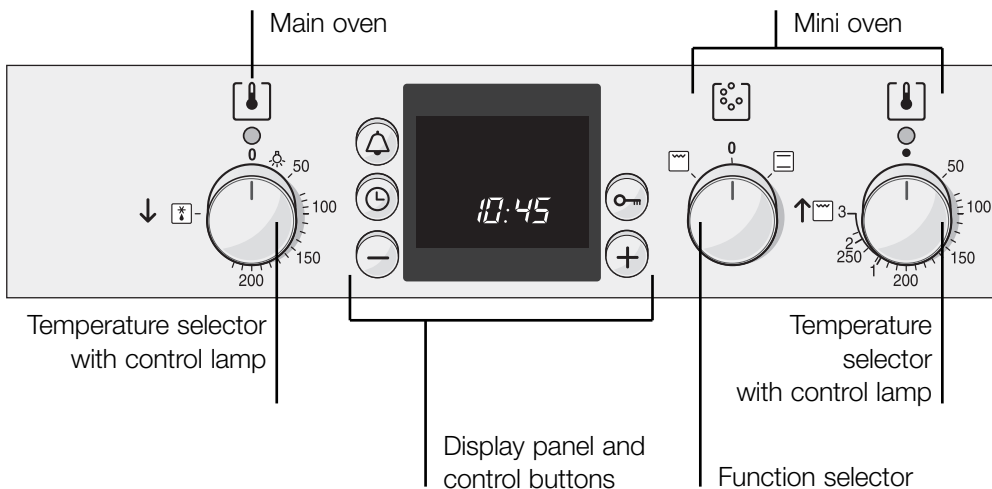

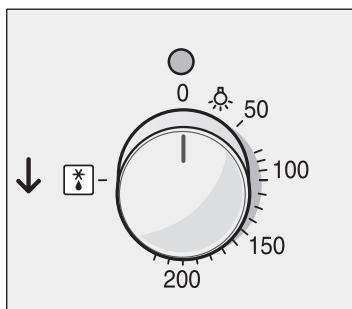

## Temperature selector Main oven

Use the temperature selector to select the type of heating for the oven.



### Settings

	Oven light
50–200	Hot air temperature in °C
	Defrost

The oven light switches on when you select a temperature.

The red oven temperature control lamps illuminates when the oven is first switches on.



## Function selector Mini oven

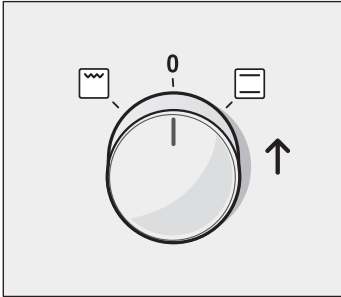

Use the function selector to select the type of heating for the oven.

### Settings



Conventional heat



Radiant grill – large area

The oven light switches on when you select a function.

## Temperature selector Mini oven

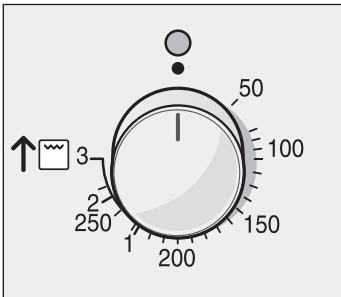

Use the temperature selector to set the temperature or grill setting.

### Temperature

50–270

Temperature range in °C

### Grill

1 Low grill

2 Medium grill

3 High grill

clean Cleaning function







The temperature symbol in the display lights up while the oven is heating up.

### Grill settings

You can select a grill setting on the radiant grill  using the temperature selector.

## Control buttons and display panel



Timer button 	Use this button to set the timer
Clock button 	Use this button to set the time of day, the cooking time  and the completion time 
Minus button 	Use this button to reduce the values set.
Plus button 	Use this button to increase the values set.
Key button 	Use this button to switch the childproof lock on and off.

The values set can be seen in the display panel.

## Push-in control knobs

The control knobs can be pushed in. Simply press the control knob to release or lock it.

The function selector can be turned clockwise or anticlockwise, whereas the temperature selector can only be turned clockwise.

## Types of heating Main oven

Different types of oven heating are available. You can therefore select the best method for cooking any dish.

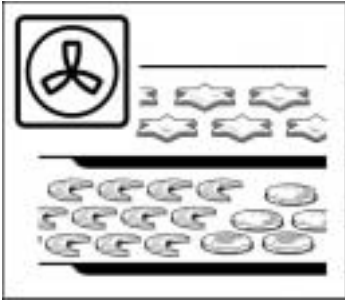

### 3D hot air

A fan in the rear panel distributes the heat from the ring heating element evenly inside the oven. Using 3D hot air, it is possible to bake cakes and pizza on two shelves. You can cook biscuits and puff pastry on three levels at the same time. The required oven temperatures are lower than those for top and bottom heating. Additional baking trays may be obtained from specialist shops. 3D hot air is ideal for drying food.

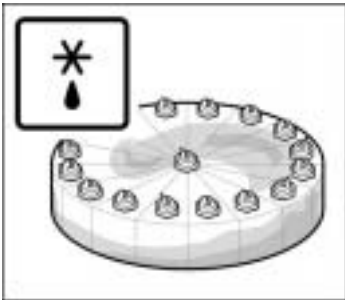

### Defrosting

A fan in the rear panel circulates the air in the oven around the frozen food. Frozen pieces of meat, poultry, bread and cakes defrost evenly.

---

## Types of heating

### Mini oven

Different types of oven heating are available. You can therefore select the best method for cooking any dish.



#### Top and bottom heating

This ensures the even distribution of heat onto the cake or roast from the top and bottom of the oven. This type of heating is best for cake mixtures in tins or for bakes. Top and bottom heating is also suitable for cooking lean roasts of beef, veal and game.

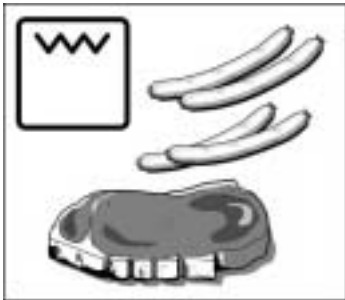

#### Radiant grill – large area

The entire area under the grill element becomes hot. This is ideal if you wish to cook several steaks, sausages, fish or slices of toast.

## Oven and shelving accessories

### Mini oven

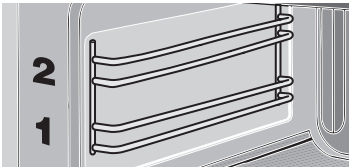

Your oven features 2 shelf positions. The shelf positions are counted from bottom to top. The numbers are marked in the oven.

### Main oven

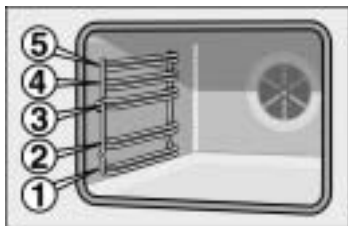

The shelf can be inserted at 5 different heights in the oven.

You can remove the shelf two thirds of the way without it tipping. This makes it easier to take food out of the oven.

### Accessories



#### HEZ 334000 wire rack

For ovenware, cake tins, roasts, grilling and frozen meals.

Place the wire racks curved downwards .

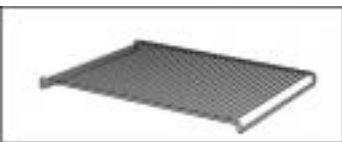

#### HEZ 324000 wire rack

for grilling. Always place the wire rack in the universal pan. Fat and meat juices are collected.



#### Universal pan HEZ 332000

for moist cakes, pastries, frozen food and large roasts. It can also be used to catch dripping fat when you are grilling directly on the wire grill.

Push the universal pan with the sloping edge facing towards the oven door.

---

## Cooling fan

The oven is fitted with a cooling fan. It switches itself on and off as necessary. The warm air escapes above the door

---

## Before using for the first time

This section will tell you everything you need to do before using the cooker for the first time.

Heat the oven and clean the accessories. Read the safety instructions in the „Important information“ section.

Firstly, check to see if the  $\ominus$  symbol and three zeros are flashing in the display.

**If the  $\ominus$  symbol and three zeros are flashing**

Set the time.

1. Press the  $\ominus$  clock button.  
12:00 appears and the  $\ominus$  clock symbol flashes.
2. Set the time using the + or – button.

The time selected is adopted after a few seconds. The cooker is now ready for use.

---

## Heating up the oven

Heat the empty oven with the door closed to remove the new oven smell.

**Method**

1. Preheat the empty oven for about 30 minutes.  
Select heat for the main and mini oven at a setting of 190 °C.  
During the initial burn-in phase, please open the kitchen windows to dissipate unpleasant odours.

---

## Pre-cleaning the accessories

Please wash the accessories thoroughly with soapy water and a cleaning cloth before using them.

---

# Setting the oven

## Switching off the oven manually

You have various options for setting the oven.

When your meal is ready, switch off the oven yourself.

## The main oven switches off automatically

You can leave the kitchen for a long period.

## The main oven switches on and off automatically

You can put your meal in the oven in the morning, for example, and set the oven so that your meal is ready at midday.

## Tables and tips

The correct settings for many dishes can be found in the Tables and tips section.

---

## Setting procedure Main oven

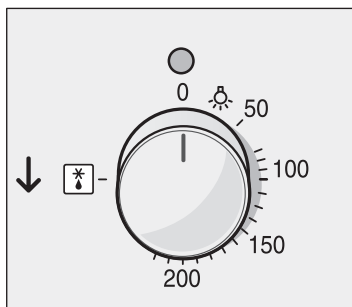

1. Set the temperature control knob to the desired temperature.

The selected temperature will be controlled automatically.

The red oven temperature control lamp illuminates when the oven is first switched on, and extinguishes when the required temperature has been reached.

## Setting procedure

Example: Mini oven

Top/bottom heating  200° C

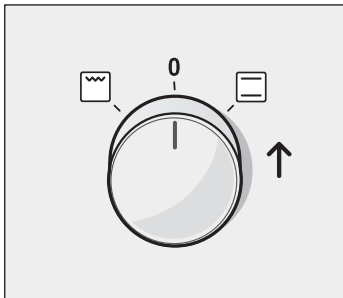

1. Select the desired type of heating using the function selector.

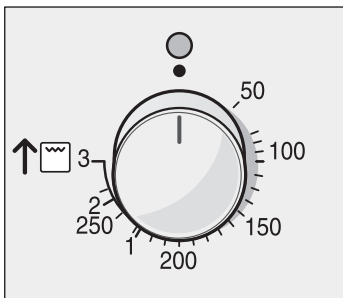

2. Use the temperature selector to set the temperature or grill setting.

### Switching off

Switch off the function selector when the meal is ready.

### Changing the setting

You may change the temperature or grill setting at any time.



## If the oven is to switch off automatically – Main oven

Example: Cooking time of 45 minutes



**The cooking time has elapsed**

**Changing the setting**

**Cancelling the setting**

**Setting the cooking time when the clock time is hidden**

Make settings as described in steps 1 and 2. Set the cooking time (duration) for your meal.

**3.** Press the ⌚ clock button.  
The cooking time symbol I->I will flash.

**4.** Set the cooking time using the + or – button.  
+ button default value = 30 minutes.  
– button default value = 10 minutes.

The oven switches on after a few seconds.  
The I->I symbol lights up in the display.

A signal sounds. The oven switches off. Press the ⌚ button twice and switch off the function selector.

Press the ⌚ clock button. Change the cooking time using the + or – button

Press the ⌚ clock button. Press the – button until the display is at zero. Switch off the function selector.

Press the ⌚ clock button twice and perform the setting as described in item 4.

## If the oven is to switch on and off automatically – Main oven

Example: Imagine – it's 10:45 a.m. The meal will take 45 minutes to cook and must be ready at 12:45 pm.



Please remember that easily spoiled foods must not be allowed to remain in the oven for too long.

Perform the settings as described in items 1 to 4. The oven starts.

**5.** Press the ⌚ clock button until the →| end symbol flashes.

In the display you will see the time when the meal will be ready.



**6.** Use the + button to set a later end time.

The setting is adopted after a few seconds. The display will show the end time until the oven switches on.

**The cooking time has elapsed**

A signal sounds. The oven switches off.

Press the ⌚ button twice and switch off the function selector.

### Note

You can change the setting while the symbol is flashing. The setting has been adopted if the symbol lights up permanently. You may change the waiting time that elapses before the setting is adopted. See the Basic settings section for more details.

# Time

When the oven is first connected, or following a power cut, the ⌚ symbol and three zeros flash in the display. Set the time.

The function selector must be switched off.

## Setting procedure

Example: 13:00



1. Press the ⌚ clock button.  
12.00 appears in the display and the ⌚ symbol flashes.



2. Set the time using the + or – button.  
The time selected is adopted after a few seconds.

**Changing the time e.g. from summer to winter timer**

**Hiding the time**

Press the ⌚ clock button twice and change the time with the + or – button.

You can hide the time. It will then only be visible when you are performing settings.  
To do this, you must change the basic setting.  
See the Basic settings section.

# Timer

You can use the timer as a kitchen timer. It operates independently of the oven.



The timer has a special signal. This means that you can tell whether the set timer period has elapsed or the cooking time is complete.

You can also set the timer if the childproof lock is active.

## Setting procedure

Example: 20 minutes



1. Press the  timer button.  
The  symbol will flash.



2. Set the timer period using the + or – button.  
+ button default value = 10 minutes.  
– button default value = 5 minutes

The timer starts after a few seconds. The  symbol lights up in the display. The time counts down visibly.

### The time has elapsed

A signal sounds. Press the  timer button. The timer display will go out.

### Changing the timer period

Press the  timer button. Change the time using the + or – button.

### Cancelling the setting

Press the  timer button. Press the – button until the display is at zero.

## The timer and cooking time count down simultaneously

The symbols light up. The timer period counts down visibly in the display.

To call up remaining cooking time  $I \rightarrow I$ , end time  $\rightarrow I$  or time  $\ominus$ : Press the  $\ominus$  clock button until the symbol in question flashes.

The value called up will then appear in the display for a few seconds.

---

# Basic settings

## Main oven

Your oven has several basic settings. You may change the basic settings for time, the signal duration and the reset time for a setting.

Basic setting	Function	Change to
Time $\ominus$ $I$ = Time in the foreground	Time display	Time $\ominus$ = Time hidden
Signal duration $\triangle$ $2$ = approx. 2 minutes	Signal after cooking time or timer period has elapsed.	Signal duration $I$ = approx. 10 seconds $3$ = approx. 5 mins
Reset time $I \rightarrow I$ $2$ = medium	Waiting time between the adjustment increments before the setting is adopted.	Reset time $I$ = short $3$ = long

## Changing the basic settings – Main oven

Example: Hiding the time

There must be no program set.



1. Press the ⌚ clock button and the + button at the same time until a **!** appears in the display. This is the basic setting for the time in the foreground.



2. Change the basic setting using the + or – button.

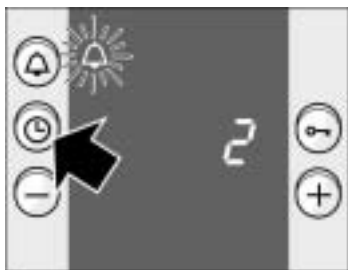

3. Conform with the ⌚ clock button.

A **2** will appear in the display for the basic setting for the signal duration.

**You do not wish to change all the basic settings**





If you do not wish to change a basic setting, press the ⌚ clock button. The next basic setting will appear.

**Correcting settings**

You may change your settings again at any time.

---

# Childproof lock – for the main oven

	<p>The oven has a childproof lock to prevent children switching it on accidentally.</p>
<b>Locking the oven</b>	<p>Press the  key button until the  symbol appears in the display. This will take approximately 4 seconds.</p>
<b>Unlocking</b>	<p>Press the  key button until the  symbol goes out.</p>
<b>Notes</b>	<p>You can set the timer and the clock even when the oven is locked.</p> <p>The childproof lock setting will be lost if there is a power cut</p>

---

# Care and cleaning

Do not use high-pressure cleaners or steam jets.

---

## Oven exterior

Wipe the oven with water and a little washing-up liquid. Dry it with a soft cloth.

Caustic or abrasive substances are not suitable. If any such substances come into contact with the frontage, wipe it off immediately with water.

### Notes

Slight differences in the colours on the appliance front are caused by the use of different materials, such as glass, plastic and metal.

Shadows on the door panel which resemble smears are reflections from the oven light.

## Appliances with stainless steel fronts

Always remove any flecks of limescale, grease, cornflour and egg white immediately. Corrosion can form under such flecks.

Use stainless steel care products. Follow the manufacturer's instructions. Try out the product on a small area first, before using on the whole surface.

## Appliances with aluminium fronts

Use a mild window-cleaning detergent. Wipe the area with a soft window cloth or a fluff-free micro-fibre cloth, using a horizontal action without applying pressure.

Aggressive cleaning products, scratchy sponges and rough cleaning cloths are not suitable.

---

## Oven

Never use coarse scouring pads or cleaning sponges. Oven cleaner may only be used on enamelled oven surfaces

### For ease of cleaning

you can switch on the oven light and detach the oven door.

### Detaching the oven door

The oven door can be easily detached.

**⚠** When pulling the door out, make sure that you do not reach into the hinge. There is a risk of injury.

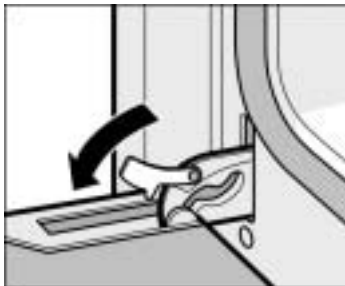

1. Open the oven door fully.
2. Move the two locking levers on the left and right-hand sides.



3. Half-close the oven door.  
With both hands, grip the door on the left and right-hand sides.  
Close the door a little more and pull it out.

After cleaning, refit the oven door in the reverse order to removal.



### **Cleaning the catalytic surfaces of the oven**

The rear wall and the top of the oven are coated with self-cleaning enamel. The surfaces clean themselves while the oven is in operation. Large splashes may only disappear after the oven has been used several times.

Never use oven cleaner on self-cleaning surfaces.

If the self-cleaning surfaces of the oven are no longer cleaning themselves sufficiently, they can be regenerated using the cleaning function.

Should the enamel become slightly stained, this will not affect its self-cleaning properties.

### **Cleaning the oven floor and the side walls**

Use hot soapy water or a vinegar solution.

It is best to use oven cleaner if the oven is very dirty. Only use oven cleaner in a cold oven.

Never use oven cleaner on the self-cleaning surfaces of the oven.

Note:

Enamel is baked on at very high temperatures. This can cause some slight colour variation. This is normal and does not affect the function. Do not use coarse scouring pads or strong cleaning agents to remove such discolorations.

The edges of thin trays cannot be completely enamelled. As a result, these edges can be rough. Anti-corrosion protection is guaranteed.

### **Cleaning the glass cover for the oven light**

It is best to clean the glass cover with washing-up liquid.

## Cleaning the glass panels Main and Mini oven

### Removal

The glass panel on the oven door can be removed to assist in cleaning.

1. Remove the oven door and lay it down on a cloth with the handle underneath.
2. Unscrew the cover at the top of the oven door. To do this, undo the right and left-hand screws (Fig. A).

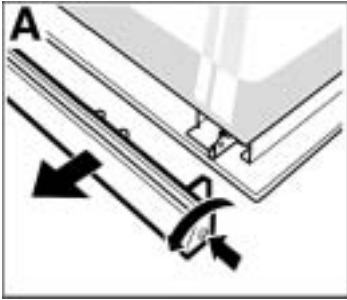

3. Slide out the top panel. (Fig. B).

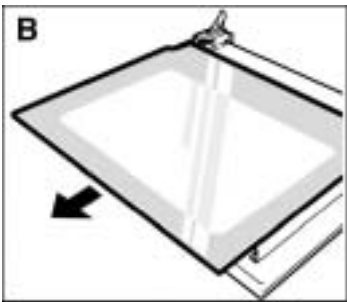

## Main oven

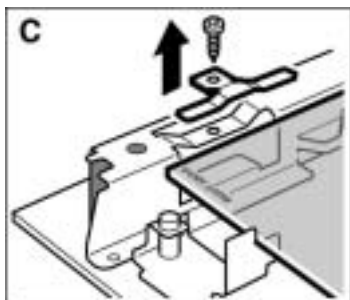

4. Unscrew the clips on the right and left and remove them (Fig. C).  
Remove the panel.

Clean the glass panels with glass cleaner and a soft cloth.

### Installation

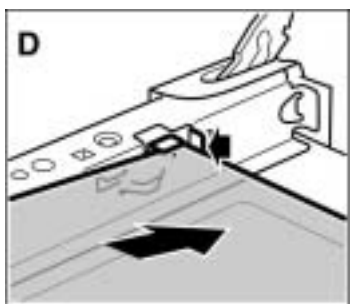

Make sure that the message „Right above“ is upside down at the bottom left of both panels.

1. Push the glass panel back at an angle. (Fig. D).

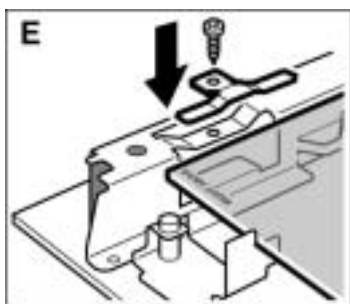

2. Fit the clips and screw them in again. (Fig E).
3. Push the top panel back in. Make sure that the smooth surface is facing outwards.
4. Replace the cover and screw it back on.
5. Refit the oven door.

**The oven must not be used again until the panels have been correctly installed.**

## Mini oven

### Removal

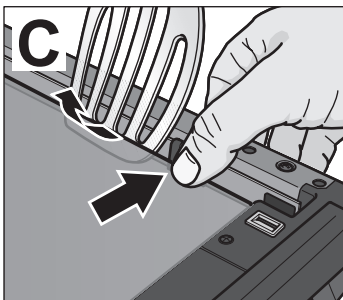

1. Press in the retaining clip with your thumb on one side and disengage the **inner door glass** e.g. with the spatula, then repeat on the other side. (Fig. C).

### Installation

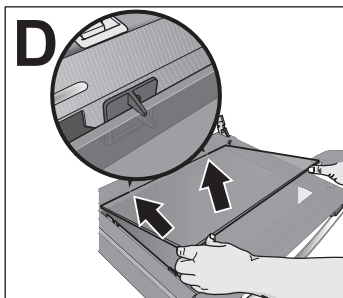

### Installation after cleaning:

1. Insert **inner door glass** into the holder. First engage the right side and then the other side. (Fig. D)
2. Push the top panel back in. Make sure that the smooth surface is facing outwards.
3. Replace the cover and screw it back on.
4. Refit the oven door.

**The oven must not be used again until the panels have been correctly installed.**

---

## Cleaning the rails

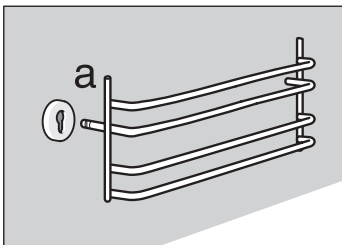
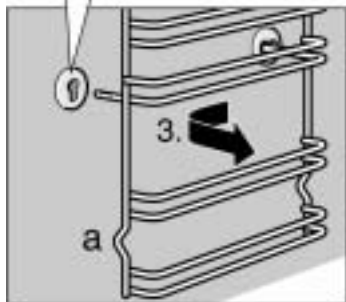
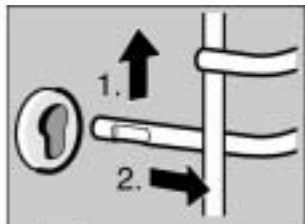

The rails can be removed for cleaning.

### To unhook the rails:

1. Lift the rail at the front in an upwards direction
2. and unhook it.
3. Then pull the whole rail forward and take it out.

Clean the rails using either washing-up liquid and a sponge or a brush.

### To hook rails back into position:

**When installing the rails, do not twist them, otherwise the shelf positions for the accessories will not correspond.**

First insert the rail in the rear socket, push it back slightly and then hook it into the front socket.

Main oven:

The rails fit both the left and right sides.  
Recess (a) must always be at the bottom.

Mini oven:

The extension (a) must always be at the top.

---

## Seal

Clean the seal on the oven with washing-up liquid.  
Never use caustic or abrasive detergents.

---

## Accessories

Immediately after use, soak the accessories in washing-up liquid. Food residues can then be easily removed with a brush or sponge.

# Troubleshooting

Should a malfunction occur, it is often only due to a minor fault. Please read the following instructions before calling the after-sales service:

Problem	Possible cause	Comments/remedy
The oven does not work.	Blown fuse	Look in the fuse box and check that the fuse is in working order.
The clock display flashes.	Power cut	Reset the time.

**Repairs may only be carried out by fully trained after-sales service technicians.**

Improper repairs may constitute serious hazards to the user.

## Replacing the oven light

If the oven light fails, it must be replaced. 40 watt heat-resistant spare bulbs can be obtained from the after-sales service or specialist shops.

Only use these bulbs.

### Method



1. Switch off the oven fuse in the fuse box.
2. Place a tea towel in the cold oven to prevent damage.
3. Unscrew the glass cover by turning it anti-clockwise.
4. Replace the oven light with one of the same type.
5. Screw the glass cover back on.
6. Remove the tea towel and switch the fuse back on.

## Replacing the glass cover

The glass cover on the oven light must be replaced if it is damaged. Replacement glass covers may be obtained from the after-sales service. To this end, please specify the E number and FD number of your appliance.

---

# After-sales service

Our after-sales service is there for you if your oven needs repairing. You will find the address and telephone number of your nearest after-sales service centre in the phone book. The after-sales service centres listed will also be happy to advise you of a service point in your local area.

## E number and FD number

Please quote the E number (product number) and the FD number (production number) of your appliance when contacting the after-sales service. The rating plate containing these numbers is found on the right, on the side of the oven door. You can make a note of these numbers in the space below to save time in the event of your appliance malfunctioning.

E no.	FD no.
-------	--------

After-sales service ☎
-----------------------

---

## Packaging and old appliances

Your new appliance was protected by suitable packaging while it was on its way to you. All materials used for this purpose are environmentally friendly and can be recycled. Please make a contribution to protecting the environment by disposing of the packaging appropriately.

Old appliances are not worthless rubbish. Environmentally-conscious recycling can reclaim valuable raw materials.

Before disposing of your old appliance, please make sure that it is unusable, or label it with a sticker stating „Caution, scrap“.



Up-to-date information on how to dispose of your old appliance and the packaging from the new one can be obtained from your retailer or local authority.

This appliance is labelled in accordance with European Directive 2002/96/EG concerning used electrical and electronic appliances (waste electrical and electronic equipment – WEEE). The guideline determines the framework for the return and recycling of used appliances as applicable throughout the EU.



---

# Tables and tips

This table contains a selection of dishes and the optimum settings at which to cook them. You can find out which type of heating and temperature is best for your dish, which accessories to use, and at which oven level the dish should be inserted. You will find a variety of tips about ovenware and preparation, and a small troubleshooting section in case anything should go wrong.

---

## Cakes and pastries

### Baking tins

It is best to use dark baking tins. You should use 3D-hot air when using thin baking tins, or glass containers. This means, however, that the baking time is increased and the cake does not brown so evenly.

Always place the cake tin on the wire rack.

### Tables

The values in the table apply to dishes placed in a cold oven. This saves energy. Shorten the baking times indicated by 5 to 10 minutes if you have preheated the oven.

The tables show which type of heating is best for different cakes and bakes.

The temperature and cooking time you select depends on the quantity and type of pastry. This is why „ranges“ are given in the tables. You should try to use a lower temperature setting to start with, since this allows more even browning. If necessary, use a higher temperature setting the next time.

More information can be found in the „Baking tips“ section which follows the tables.

# Main oven

## Baking on 1 level

Food	Dish	Shelf position	Temp. °C	Time, minutes
Victoria sandwich	20 cm tin	1	160	20-30
Light fruit cake	20 cm tin	2	160	80-90
Fruit crumble	Glass dish	3	160	35-45
Jam tarts*	12 hole bun tin	1	180	15-20
Yeast cookery* (f. ex. Pizza)	Universal pan	2	180	20-30
Tarts	20 cm plate or pie tin	3	190	40-50
Quiches	Glass dish	3	180	40-50
Swiss Roll*	Swiss roll tin	2	170	10-12
Rich Biscuits	Baking tray	1	170	15-20
Soufflés*	1,2 l soufflé dish	3	170	40-50
Pies	Pie dish	3	180	45-55
Rich fruit cake	∅ 23 cm round tin or 20 cm square cake tin	2	140	180-190
Meringues	Universal pan	3	80	100-150
Pavlova	Universal pan	3	150*+ 100	100-120
Jacket Potatoes	Universal pan	2	160	60-70
Bread	loaf tin (900 g or 2 x 450 g)	1	200	25-35
Scones*	Baking tray	1	180	15-20
Yorkshire Pudding*	12 hole bun tin	3	180	25-35

\* Preheat oven

# Main oven

## Baking on 2 or 3 levels

<b>Food</b>	<b>Dish</b>	<b>Shelf position</b>	<b>Temp. °C</b>	<b>Cooking time, min</b>
Victoria sandwich	20 cm tins	1+3	160	35-50
Scones*	Baking trays	1+3	170	20-30
Jacket potatoes	wire racks	1+3	160	60-75
Biscuits	Baking trays**	1+3 2+3+5	170 160	20-25 25-30
Small Cakes*	Baking trays**	1+3	160	25-35
Meringues	Baking trays**	1+3 2+3+5	80 80	100-150 100-150
Full meal	Universal pan + wire rack	1+4	180	75-85

\* Preheat oven

\*\* When baking on two levels, use the universal pan provided, at shelf position three. When baking on three levels, use the universal pan at shelf position two. The universal pan can be removed earlier.

---

## Baking tips

---

**You wish to cook to your own recipe.**

Refer to the instructions in the tables for similar types of food.

---

**How to check that a sponge cake is cooked properly.**

Approximately 10 minutes before the end of the baking time given in the recipe, pierce the tallest point of the cake with a cocktail stick. The cake is done if the cocktail stick comes out clean.

---

**The cake collapses.**

Next time, use less liquid or decrease the oven temperature by 10 degrees. Observe the cooking times in the recipe.

---

**The cake has risen in the centre but is lower at the edges.**

Do not grease the sides of the springform cake tin. As soon as the cake is done, carefully loosen the cake around the edges using a knife.

---

**The cake is too dark at the top.**

Insert it at a lower level in the oven, select a lower temperature and cook the cake a little while longer.

---

**The cake is too dry.**

Use a toothpick to make small holes in the finished cake. Then drizzle fruit juice or alcohol over the top. Next time you should decrease the temperature by around 10 degrees and reduce the baking times.

---

**The bread or cake (e.g. cheesecake) looks fine, but is soggy on the inside (soft, with watery areas).**

Next time you should add a little less liquid and cook for a little longer at a lower temperature. Cakes with fruit topping: Precook the base first of all. Sprinkle with almonds or breadcrumbs and then place the topping over this. Please observe the recipe and the baking times.

---

**The pastry is unevenly browned.**

Select a slightly lower temperature to ensure that the pastry is baked more evenly. Baking paper that protrudes over the food can affect the air circulation. For this reason, always cut the baking paper to fit the baking tray.

---

**The fruit cake is too light at the bottom. The fruit juice flows over.**

Use the deeper universal pan next time.

---

**You were baking on several levels. The food on the top baking tray is darker than that on the bottom baking tray.**

Always use 3D hot air when baking on several levels. Baking trays that are placed in the oven at the same time will not necessarily be ready at the same time.

---

**Condensation is formed when baking cakes containing fresh fruit.**

Baking may result in the formation of water vapour. It escapes above the door handle. The steam may settle and form water droplets on the control panel or on the fronts of adjacent units. This is a normal physical process.

---

---

## Meat, poultry, fish

### Ovenware

You may use any heat-resistant dishes. The universal pan is also suitable for larger roasts.

Always place the dishes in the centre of the wire rack.

Hot glass dishes should be placed on a dry kitchen towel after being removed from the oven. The glass could crack if placed on a cold or wet surface.

### Advice on roasting

The roasting result depends on the type and quality of meat.

Add 2 to 3 soup spoons of liquid to lean meat, and 8 to 10 soup spoons of liquid to pot roasts, depending on the size.

Meat should be turned half way through the cooking time.

When the roast is ready, switch off the oven and leave the roast to stand for 10 minutes with the oven door closed. This allows the meat juices to distribute more favourably.

### Advice on grilling

Always close the oven door when grilling.

If possible, use pieces of meat which are of the same thickness. They should be at least 2 to 3 cm thick. Such pieces will be browned evenly and stay juicy and soft in the middle. Only salt the steaks after they have been grilled.

Place the pieces of meat directly onto the wire rack. If you are grilling just one piece of meat, it will turn out best if you place it in the centre of the wire rack. You should also insert the universal pan at level 1. The meat juices are collected here and the oven is kept clean.

Turn the pieces of meat after two thirds of the cooking time indicated.

The grill element automatically switches itself off and back on again. This is normal. The number of times this happens depends on the grill setting you have selected.





## Main oven

### Roasting

Food	Shelf position	Cooking method	Temperature °C	Cooking time mins per 1 lb
Beef rare	1	hot-air	180-200	15+20
Beef medium	1	hot-air	170-190	20+20
Beef well done	1	hot-air	170-190	25+25
Beef filet	1	hot-air	170-190	20+20
Lamb medium	1	hot-air	180-200	20+25
Lamb well done	1	hot-air	180-200	25+30
Pork	1	hot-air	190-210	30+30
Chicken, Duck, Goose and Turkey up to 5 kilo	1	hot-air	200-220	25+20
Large Turkey	1	hot-air	180-200	13+13
Chops and chicken joints	1	hot-air	190-210	25

## Mini oven

### Grilling

Food	Shelf position	Cooking method	Grill setting	Cooking time mins per 1 lb
Meat steaks, bacon	2		2 or 3	12-22
Sausages and Fish fingers	1		3	15-20
Fish	1		2	10-20
Toast	2		3	4-5

## Tips for roasting and grilling

**The table does not contain information for the weight of the roast.**

Select the next lowest weight from the instructions and extend the time.

**How can you tell when the roast is ready?**

Use a meat thermometer (available from specialist shops) or carry out a „spoon test“. Press down on the roast with a spoon. If it feels firm, it is ready. If the spoon can be pressed in, it needs to be cooked for a little longer.

**The roast is too dark and the crackling is partly burnt.**

Check the shelf position and temperature.

**The roast looks good, but the juices are burnt.**

Next time, use a smaller roasting dish or add more liquid.

**The roast looks good, but the juices are too clear and watery.**

Next time, use a larger roasting dish or add less liquid.

## Defrosting Main oven

Remove the food from its packaging and place it in a suitable dish on the wire rack.

Please observe the instructions on the packaging.

The defrosting times depend on the type and amount of food.

Meal	Accessories	Level	Type of heating
<b>Frozen foods*</b> e.g. cream gateaux, cream cakes, cakes with chocolate or icing, fruit, chicken, sausages and meat, bread, rolls, pastries and other baked goods.	Wire rack	2	

\* Cover frozen food with microwave foil. Place poultry onto the plate with the breast side down.

---

## Energy saving tips

Only preheat the oven if it specifies in the recipe or in the table in the instruction manual that you should do so.

Use non-stick, black painted or enamelled tins. They absorb the heat especially well.

If you have several cakes to bake it is best to bake them one after the other. The oven is still warm. This shortens the baking time for the second cake. You can also put two baking tins in one after the other.

For long cooking times, the oven can be switched off 10 minutes before the end of the cooking time and the remaining heat can be used to finish the cooking.

---

## Acrylamide in food

### Where does acrylamide come from?

Experts are currently discussing how dangerous acrylamide in food can be. We have compiled this information sheet for you on the basis of current research.

Acrylamide in food does not come from external contamination. It is formed in the food itself during preparation – provided that the food contains carbohydrate and protein. Exactly how this happens has not yet been completely explained. However, it appears that the acrylamide content is strongly influenced by

high temperatures  
a low water content in food  
intensive browning of the food.



## What sort of foods are affected?

Acrylamide forms mostly in grain and potato products that are prepared at high temperatures, e.g.:

crisps, chips,  
toast, rolls, bread,  
baked goods made from shortcrust pastry (speciality biscuits and cakes).

---

## What can you do?

You can avoid high levels of acrylamide when baking, frying and grilling.

The following recommendations were published by AID<sup>1</sup> and BMVEL<sup>2</sup> to help you minimise acrylamide levels:

### In general

Keep cooking times as short as possible.

„Brown rather than burn“ – cook food only until it is golden brown.

The larger and thicker the food is, the less acrylamide it contains.

### Baking

Set the temperature to a maximum of 180 °C for the 3D hot air setting.

Cookies: Set the temperature to a maximum of 170 °C for the 3D hot air setting. The presence of egg or egg yolk in a recipe reduces the formation of acrylamide.

Spread oven chips evenly over the baking sheet in one layer where possible. To prevent the food from drying out quickly, place at least 400 g on each baking sheet.

<sup>1</sup> AID “Acrylamide“ information leaflet, published by AID (German Evaluation and Information Service for Nutrition, Agriculture and Forestry) and BMVEL (German Federal Ministry for Consumer Protection, Food and Agriculture), as at 12/02, Internet: <http://www.aid.de>.

<sup>2</sup> BMVEL press release 365, as at 4.12.2002, Internet: <http://www.verbraucherministerium.de>

# Test dishes for the main oven



referring to EN 60350.

## Baking

Food	Dish and notes	Shelf position	Temp. °C	Cooking time min
Small cakes (preheat oven)	baking tray	3	150-170	20-30
	baking tray + universal pan*	1+3	150-170	25-35
Fatless sponge cake	baking tin (dark coated)	1	140-160	30-40
Apple pie	2 wire racks + 2 tinplate springform cake tins ∅ 20 cm	2+4 placed diagonally	190-210	70-80
	universal pan + 2 tinplate springform cake tins ∅ 20 cm	1 in the centre alongside one another	190-210	70-80

\* When baking on two levels, use the universal pan provided, at shelf position three.

## Grilling for the mini oven

Food	Dish and notes	Shelf position	Cooking method	Temp. °C	Cooking time min
White bread (preheat oven 10 minutes)	wire rack	2		Setting 3	1-2
Beefburger*	wire rack	2		Setting 3	25-30

\* Turn the burgers over after 12-15 min. Insert the universal pan at level 1.

---

# Assembly Instructions

For the installer  
and kitchen expert!

---

## Important installation notes

Properly dispose of **packaging materials**.

Do not use **oven door handle** for transporting or handling the unit during installation.

**WARNING:** Connection and first start of the appliance may only be performed by an authorised specialist.

Connection have to be made using a mains connection cable not lighter than H05RR-F 300 V / 500 V Rubber Flexible Cable or H05VV-F 300V / 500V PVC Flexible Cable.

### **Rated consumption, rated voltage and type no. of the appliance:**

See appliance nameplate behind the oven door to the left beneath the side edge of the oven.

### **The unit's nameplate is located at on the sidewall of the unit.**

**Electrical safety** of the appliance can be ensured only if the equipment earth in the building installation has been installed according to regulations.

A separator must be installed in the household circuit. A suitable separator is a switch that has a contact gap of more than 3 mm and interrupts all poles. Other examples are LS switches, fuses and contactors.

The **connection diagramm** is located on the rear panel of the appliance.



**In the case of repairs** interrupt all power connections to the unit.

The properly installed appliance must be covered on all sides in such a fashion that not even components with rough insulation are exposed to the touch.

The cover must be removable with tools only.

## Installation of the built-in oven

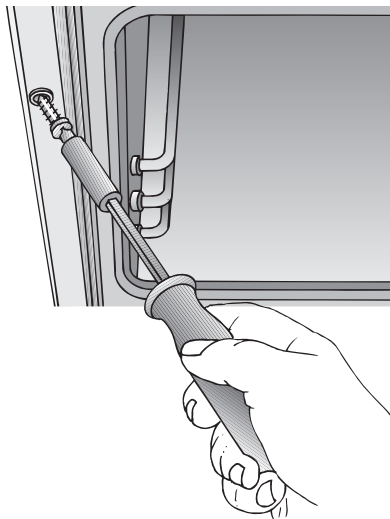

Push the oven into the cabinet aperture and align the unit until it is in a **level position**.

Open the oven door and, using one screw on each side, fasten the built-in oven to the side strips of the conversion cabinet.

When screwing in the two screws (enclosed in a bag with the built-in oven), ensure that they are pointing outwards at a slight angle. Please use these screws only.

Verify that the built-in oven is positioned securely and in a **level position**, and that the required installation dimensions have been maintained.

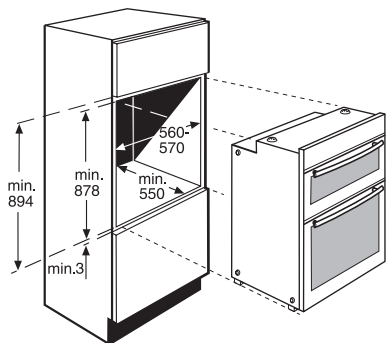

### Furniture requirements

Oven housings from virtually all lines of kitchen furniture are suitable for installing the built-in oven. However, the veneers or plastic laminates on the conversion cabinets must be applied with heat-resistant adhesive (90 °C).

If plastic laminates or cement are not sufficiently heat-resistant, warping, bubbling or detachment of the finish may result.











## Free Manuals Download Website

<http://myh66.com>

<http://usermanuals.us>

<http://www.somanuals.com>

<http://www.4manuals.cc>

<http://www.manual-lib.com>

<http://www.404manual.com>

<http://www.luxmanual.com>

<http://aubethermostatmanual.com>

Golf course search by state

<http://golfingnear.com>

Email search by domain

<http://emailbydomain.com>

Auto manuals search

<http://auto.somanuals.com>

TV manuals search

<http://tv.somanuals.com>