

brother®

USER'S GUIDE

DCP-7020

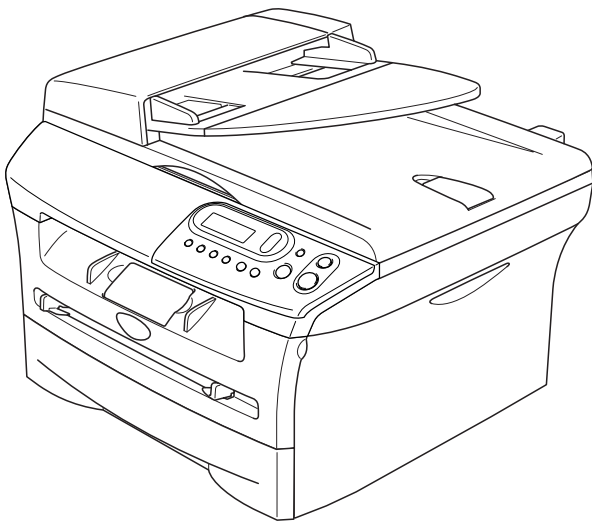

If you need to call Customer Service

Please complete the following information for future reference:

Model Number: DCP-7020

Serial Number:* _____

Date of Purchase: _____

Place of Purchase: _____

* The serial number can be displayed on the LCD screen (Menu, 3, 1). Retain this User's Guide with your sales receipt as a permanent record of your purchase, in the event of theft, fire or warranty service.

Register your product on-line at

<http://www.brother.com/registration>

By registering your product with Brother, you will be recorded as the original owner of the product. Your registration with Brother:

- may serve as confirmation of the purchase date of your product should you lose your receipt;
- may support an insurance claim by you in the event of product loss covered by insurance; and,
- will help us notify you of enhancements to your product and special offers.

The most convenient and efficient way to register your new product is on-line at <http://www.brother.com/registration>

Brother numbers

IMPORTANT

For technical help, you must call the country where you bought the DCP. Calls must be made **from within** that country.

Register your product

By registering your product with Brother International Corporation, you will be recorded as the original owner of the product. Your registration with Brother:

- may serve as confirmation of the purchase date of your product should you lose your receipt;
- may support an insurance claim by you in the event of product loss covered by insurance; and,
- will help us notify you of enhancements to your product and special offers.

Please complete and fax the Brother Warranty Registration And Test Sheet or, for your convenience and most efficient way to register your new product, register on-line at

<http://www.brother.com/registration>

Frequently asked questions (FAQs)

The Brother Solutions Center is our one-stop resource for all your DCP needs. You can download the latest software, documents and utilities, read FAQs and troubleshooting tips, and learn how to get the most from your Brother product.

<http://solutions.brother.com>



Note

You can check here for Brother driver updates.

For Customer Service

In USA: 1-800-284-4329 (voice)
1-901-379-1215 (fax)
1-800-284-3238 (TTY service for the hearing-impaired)

In Canada: 1-877-BROTHER (voice)
(514) 685-4898 (fax)

Service Center Locator (USA only)

For the location of a Brother authorized service center, call 1-800-284-4357.

Service Center Locations (Canada only)

For the location of a Brother authorized service center, call 1-877-BROTHER.

Brother fax back system (USA only)

Brother has installed an easy-to-use fax back system, so you can get instant answers to common technical questions and product information for all Brother products. This system is available 24 hours a day, 7 days a week. You can use the system to receive faxed instructions and an Index of fax back subjects.

In USA only: 1-800-521-2846

Ordering accessories and supplies

For best quality results use only genuine Brother accessories, which are available at most Brother retailers. If you cannot find the accessory you need and you have a Visa, MasterCard, Discover, or American Express credit card, you can order accessories directly from Brother. (In the USA, you can visit us online for a complete selection of the Brother accessories and supplies that are available for purchase.)

In USA: 1-888-879-3232 (voice)
1-800-947-1445 (fax)

<http://www.brothermall.com>

In Canada: 1-877-BROTHER (voice)

Description	Item
Toner Cartridge	TN-350 (Prints up to 2,500 pages)
Drum Unit	DR-350
External Wireless Print/Scan Server (Option)	NC-2200w
External Print Server (Option)	NC-2100p
User's Guide	LF6552001 (English for USA and Canada) LF6552002 (French for Canada)
Quick Setup Guide	LF6557001 (English for USA and Canada) LF6557002 (French for Canada)

Notice - Disclaimer of Warranties (USA and Canada)

BROTHER'S LICENSOR(S), AND THEIR DIRECTORS, OFFICERS, EMPLOYEES OR AGENTS (COLLECTIVELY BROTHER'S LICENSOR) MAKE NO WARRANTIES, EXPRESS OR IMPLIED, INCLUDING WITHOUT LIMITATION THE IMPLIED WARRANTIES OF MERCHANTABILITY AND FITNESS FOR A PARTICULAR PURPOSE, REGARDING THE SOFTWARE. BROTHER'S LICENSOR(S) DOES NOT WARRANT, GUARANTEE OR MAKE ANY REPRESENTATIONS REGARDING THE USE OR THE RESULTS OF THE USE OF THE SOFTWARE IN TERMS OF ITS CORRECTNESS, ACCURACY, RELIABILITY, CURRENTNESS OR OTHERWISE. THE ENTIRE RISK AS TO THE RESULTS AND PERFORMANCE OF THE SOFTWARE IS ASSUMED BY YOU. THE EXCLUSION OF IMPLIED WARRANTIES IS NOT PERMITTED BY SOME STATES IN THE USA AND SOME PROVINCES IN CANADA. THE ABOVE EXCLUSION MAY NOT APPLY TO YOU.

IN NO EVENT WILL BROTHER'S LICENSOR(S) BE LIABLE TO YOU FOR ANY CONSEQUENTIAL, INCIDENTAL OR INDIRECT DAMAGES (INCLUDING DAMAGES FOR LOSS OF BUSINESS PROFITS, BUSINESS INTERRUPTION, LOSS OF BUSINESS INFORMATION, AND THE LIKE) ARISING OUT OF THE USE OR INABILITY TO USE THE SOFTWARE EVEN IF BROTHER'S LICENSOR HAS BEEN ADVISED OF THE POSSIBILITY OF SUCH DAMAGES. BECAUSE SOME STATES IN THE USA AND SOME PROVINCES IN CANADA DO NOT ALLOW THE EXCLUSION OR LIMITATION OF LIABILITY FOR CONSEQUENTIAL OR INCIDENTAL DAMAGES, THE ABOVE LIMITATIONS MAY NOT APPLY TO YOU. IN ANY EVENT BROTHER'S LICENSOR'S LIABILITY TO YOU FOR ACTUAL DAMAGES FROM ANY CAUSE WHATSOEVER, AND REGARDLESS OF THE FORM OF THE ACTION (WHETHER IN CONTRACT, TORT (INCLUDING NEGLIGENCE), PRODUCT LIABILITY OR OTHERWISE), WILL BE LIMITED TO \$50.

Compilation and Publication Notice

Under the supervision of Brother Industries Ltd., this manual has been compiled and published, covering the latest product descriptions and specifications.

The contents of this manual and the specifications of this product are subject to change without notice.

Brother reserves the right to make changes without notice in the specifications and materials contained herein and shall not be responsible for any damages (including consequential) caused by reliance on the materials presented, including but not limited to typographical and other errors relating to the publication.

Brother® One Year Limited Warranty and Replacement Service (USA only)

Who is covered:

- This limited warranty ("warranty") is given only to the original end-use/retail purchaser (referred to in this warranty as "Original Purchaser") of the accompanying product, consumables and accessories (collectively referred to in this warranty as "this Product").
- If you purchased a product from someone other than an authorized Brother reseller in the United States or if the product was used (including but not limited to floor models or refurbished product), prior to your purchase you are not the Original Purchaser and the product that you purchased is not covered by this warranty.

What is covered:

- This Product includes a Machine and Consumable and Accessory Items. Consumable and Accessory Items include but are not limited to print heads, toner, drums, ink cartridges, print cartridges, refill ribbons, therma PLUS paper and thermal paper.
- Except as otherwise provided herein, Brother warrants that the Machine and the accompanying Consumable and Accessory Items will be free from defects in materials and workmanship, when used under normal conditions.
- This warranty applies only to products purchased and used in the United States. For products purchased in, but used outside, the United States, this warranty covers only warranty service within the United States (and does not include shipping outside the United States).

What is the length of the Warranty Periods:

- Machines: one year from the original purchase date.
- Accompanying Consumable and Accessory Items: 90 days from the original purchase date or the rated life of consumable, whichever comes first.

What is NOT covered:

This warranty does not cover:

- (1) Physical damage to this Product;
- (2) Damage caused by improper installation, improper or abnormal use, misuse, neglect or accident (including but not limited to transporting this Product without the proper preparation and/or packaging);
- (3) Damage caused by another device or software used with this Product (including but not limited to damage resulting from use of non Brother®-brand parts and Consumable and Accessory Items);

- (4) Consumable and Accessory Items that expired in accordance with a rated life; and,
- (5) Problems arising from other than defects in materials or workmanship.
- (6) Normal Periodic Maintenance Items, such as Paper Feeding Kit, Fuser and Laser Units.

This limited warranty is VOID if this Product has been altered or modified in any way (including but not limited to attempted warranty repair without authorization from Brother and/or alteration/removal of the serial number).

What to do if you think your Product is eligible for warranty service:

Report your issue to either our Customer Service Hotline at 1-800-284-4329 for Fax, MFC and DCP and 1-800-276-7746 for Printers, or to a Brother Authorized Service Center **within the applicable warranty period.** Supply Brother or the Brother Authorized Service Center with a copy of your dated bill of sale showing that this Product was purchased within the U.S. For the name of local Brother Authorized Service Center(s), call 1-800-521-2846.

What Brother will ask you to do:

After contacting Brother or a Brother Authorized Service Center, you may be required to deliver (by hand if you prefer) or send the Product properly packaged, freight prepaid, to the Authorized Service Center together with a photocopy of your bill of sale. **You are responsible for the cost of shipping, packing product, and insurance (if you desire). You are also responsible for loss or damage to this Product in shipping.**

What Brother will do:

If the problem reported concerning your Machine and/or accompanying Consumable and Accessory Items is covered by this warranty and if you first reported the problem to Brother or an Authorized Service Center within the applicable warranty period, Brother or its Authorized Service Center will repair or replace the Machine and/or accompanying Consumable and Accessory Items at no charge to you for parts or labor. The decision as to whether to repair or replace the Machine and/or accompanying Consumable and Accessory Items is made by Brother in its sole discretion.

Brother® One Year Limited Warranty and Replacement Service (USA only)

Brother reserves the right to supply a refurbished or remanufactured replacement Machine and/or accompanying Consumable and Accessory Items and use refurbished parts provided such replacement products conform to the manufacturer's specifications for new product/parts. The repaired or replacement Machine and/or accompanying Consumable and Accessory Items will be returned to you freight prepaid or made available for you to pick up at a conveniently located Authorized Service Center.

If the Machine and/or accompanying Consumable and Accessory Items are not covered by this warranty (either stage), you will be charged for shipping the Machine and/or accompanying Consumable and Accessory Items back to you and charged for any service and/or replacement parts/products at Brother's then current published rates.

The foregoing are your sole (i.e., only) and exclusive remedies under this warranty.

What happens when Brother elects to replace your Machine:

When a replacement Machine is authorized by Brother, and you have delivered the Machine to an Authorized Service Center, the Authorized Service Center will provide you with a replacement Machine after receiving one from Brother. If you are dealing directly with Brother, Brother will send to you a replacement Machine with the understanding that you will, after receipt of the replacement Machine, supply the required proof of purchase information, together with the Machine that Brother agreed to replace. You are then expected to pack the Machine that Brother agreed to replace in the package from the replacement Machine and return it to Brother using the pre-paid freight bill supplied by Brother in accordance with the instructions provided by Brother. Since you will be in possession of two machines, Brother will require that you provide a valid major credit card number. Brother will issue a hold against the credit card account number that you provide until Brother receives your original Product and determines that your original Product is entitled to warranty coverage. Your credit card will be charged up to the cost of a new Product only if: (i) you do not return your original Product to Brother within five (5) business days; (ii) the problems with your original Product are not covered by the limited warranty; (iii) the proper packaging instructions are not followed and has caused

damage to the product; or (iv) the warranty period on your original Product has expired or has not been sufficiently validated with a copy of the proof of purchase (bill of sale). The replacement Machine you receive (even if refurbished or remanufactured) will be covered by the balance of the limited warranty period remaining on the original Product, plus an additional thirty (30) days. You will keep the replacement Machine that is sent to you and your original Machine shall become the property of Brother. **Retain your original Accessory Items and a copy of the return freight bill, signed by the courier.**

Limitations:

Brother is not responsible for damage to or loss of any equipment, media, programs or data related to the use of this Product. Except for that repair or replacement as described above, Brother shall not be liable for any direct, indirect, incidental or consequential damages or specific relief. Because some states do not allow the exclusion or limitation of consequential or incidental damages, the above limitation may not apply to you.

THIS WARRANTY IS GIVEN IN LIEU OF ALL OTHER WARRANTIES, WRITTEN OR ORAL, WHETHER EXPRESSED BY AFFIRMATION, PROMISE, DESCRIPTION, DRAWING, MODEL OR SAMPLE. ANY AND ALL WARRANTIES OTHER THAN THIS ONE, WHETHER EXPRESS OR IMPLIED, INCLUDING IMPLIED WARRANTIES OF MERCHANTABILITY AND FITNESS FOR A PARTICULAR PURPOSE, ARE HEREBY DISCLAIMED.

- This Limited Warranty is the only warranty that Brother is giving for this Product. It is the final expression and the exclusive and only statement of Brother's obligations to you. It replaces all other agreements and understandings that you may have with Brother or its representatives.
- This warranty gives you certain rights and you may also have other rights that may vary from state to state.
- This Limited Warranty (and Brother's obligation to you) may not be changed in any way unless you and Brother sign the same piece of paper in which we (1) refer to this Product and your bill of sale date, (2) describe the change to this warranty and (3) agree to make that change.

Important: *We recommend that you keep all original packing materials, in the event that you ship this Product.*

**BROTHER MULTIFUNCTION CENTER/FACSIMILE MACHINE
LIMITED WARRANTY
(Canada only)**

Pursuant to this limited warranty of 1 year from the date of purchase for labour and parts, Brother International Corporation (Canada) Ltd. ("Brother"), or its Authorized Service Centers, will repair this MFC/Facsimile machine free of charge if defective in material or workmanship. This Limited Warranty does not include cleaning, consumables (including, without limitation, print cartridges, print head, toner and drum) or damage caused by accident, neglect, misuse or improper installation or operation, any damage caused from service, maintenance, modifications, or tampering by anyone other than a Brother Authorized Service Representative, or from the use of supplies or consumable items that are non-Brother products. Operation of the MFC/Facsimile machine in excess of the specifications or with the Serial Number or Rating Label removed shall be deemed abuse and all repairs thereafter shall be the sole liability of the end-user/purchaser. In order to obtain warranty service, the MFC/Facsimile machine must be delivered or shipped freight prepaid by the end user/purchaser to a "Brother" Authorized Service Center, together with your Proof of Purchase in the form of a Sales Receipt.

For laser products: Failure to remove the Toner Cartridge (and Toner Drum Unit on applicable models) during shipping will cause severe damage to the MFC/Facsimile and will VOID the Warranty. (Refer to your User's Guide for proper packaging.)

For ink-jet products: Do not remove the ink cartridges during shipping. Damage to your print head resulting from packing without the ink cartridges will VOID your warranty. (Refer to your User's Guide for proper packaging.)

BROTHER DISCLAIMS ALL OTHER WARRANTIES EXPRESSED OR IMPLIED INCLUDING, WITHOUT LIMITATION, ANY IMPLIED WARRANTIES OF MERCHANTABILITY OR FITNESS FOR A PARTICULAR PURPOSE, EXCEPT TO THE EXTENT THAT ANY WARRANTIES IMPLIED BY LAW CANNOT BE VALIDLY WAIVED.

No oral or written information, advice or representation provided by Brother, its Authorized Service Centers, Distributors, Dealers, Agents or employees, shall create another warranty or modify this warranty. This warranty states Brother's entire liability and your exclusive remedy against Brother for any failure of the MFC/Facsimile machine to operate properly.

Neither Brother nor anyone else involved in the development, production, or delivery of this MFC/Facsimile machine shall be liable for any indirect, incidental, special, consequential, exemplary, or punitive damages, including lost profits, arising from the use of or inability to use the product, even if advised by the end user/purchaser of the possibility of such damages. Since some Provinces do not allow the above limitation of liability, such limitation may not apply to you.

This Limited Warranty gives you specific legal rights and you may also have other rights which vary from Province to Province.

Warranty Service is available at Brother Authorized Service Centers throughout Canada. For Technical Support or for the name and location of your nearest Authorized Service Center call 1-877-BROTHER.

Internet support: support@brother.ca or browse

Brother's Web Site: www.brother.com

Brother International Corporation (Canada) Ltd.
1 Rue Hôtel de Ville
Dollard-Des-Ormeaux, QC H9B 3H6

At your side.
brother®

Safety precautions

We use the following icons throughout this User's Guide.



Warnings tell you what to do to prevent possible personal injury.



Electrical Hazard icons alert you to a possible electrical shock.



Hot Surface icons warn you not to touch DCP parts that are hot.



Cautions specify procedures you must follow or avoid to prevent possible damage to the DCP or other objects.



Improper Setup icons alert you to devices and operations that are not compatible with the DCP.



Notes tell you how you should respond to a situation that may arise or give tips about how the current operation works with other features.

To use the DCP safely

Please keep these instructions for later reference and read them before attempting any maintenance.



WARNING



There are high voltage electrodes inside the DCP. Before you clean the inside of the DCP, make sure you have unplugged the power cord from the AC power outlet.

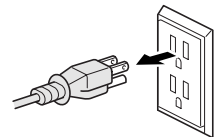

Do not handle the plug with wet hands. Doing this might cause an electrical shock.

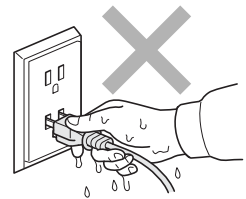

After you use the DCP, some internal parts are extremely **HOT!**
To prevent injuries, be careful not to put your fingers in the areas shown in the illustration.

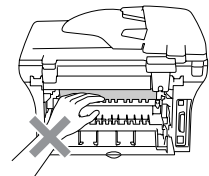
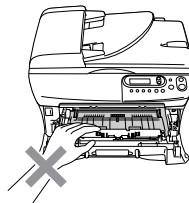

WARNING



The fuser unit is marked with a caution label. Please do not remove or damage the label.

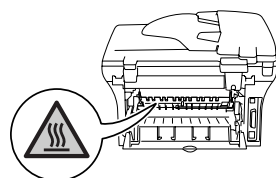

To prevent injuries, be careful not to put your hands on the edge of the DCP under the document cover or scanner cover.

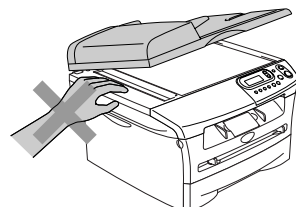
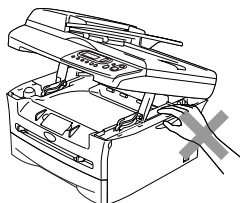

To prevent injuries, be careful not to put your fingers in the area shaded in the illustration.

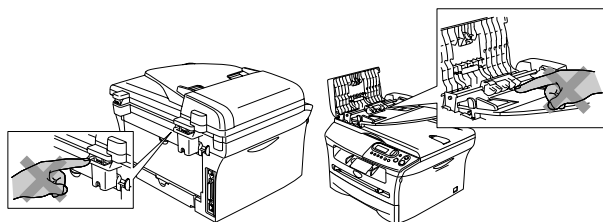

When you move the DCP, grasp the side hand holds that are at the bottom of the machine as shown in the illustration.

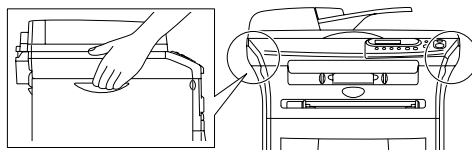

Do not use a vacuum cleaner to clean up scattered toner. Doing this might cause the toner dust to ignite inside the vacuum cleaner, potentially starting a fire. Please carefully clean the toner dust with a dry, lint-free cloth and dispose of it according to local regulations.

This product must be installed near an AC power outlet that is easily accessible. In case of an emergency, you must disconnect the power cord from the AC power outlet to shut off the power completely.

WARNING

IMPORTANT SAFETY INSTRUCTIONS

Basic safety precautions should always be followed to reduce the risk of fire, electric shock and injury to people, including the following:

1. Do not use this product near water, for example, near a bath tub, wash bowl, kitchen sink or washing machine, in a wet basement or near a swimming pool.
2. Avoid using this product during an electrical storm. There may be a remote risk of electric shock from lightning.
3. Use only the power cord provided with the DCP.

SAVE THESE INSTRUCTIONS

Table of Contents

1 Introduction

Using this Guide	1-1
Choosing a location	1-2
How to access the complete User's Guide	1-3
To view Documentation (For Windows®)	1-3
To view Documentation (For Macintosh®)	1-4
Control panel overview	1-5
Load document	1-6
Using the automatic document feeder (ADF)	1-6
Using the scanner glass	1-7
About paper	1-8
Recommended Paper	1-8
Choosing acceptable paper	1-8
How to load paper	1-10

2 Getting started

Initial Setup	2-1
Setting the Paper Type	2-1
Setting the Paper Size	2-1
Setting the Beeper Volume	2-2
Toner Save	2-2
Sleep Time	2-3
Setting the LCD Contrast	2-3
Printing the User Settings List	2-3

3 Making copies

Using the DCP as a copier	3-1
Making a single copy	3-1
Making multiple copies	3-1
Stop copying	3-1
Using the Temporary Copy keys	3-2
Enlarging or reducing the image copied	3-2
Adjusting contrast	3-3
Changing the temporary copy settings	3-4
Changing the default copy settings	3-7
Quality	3-7
Adjusting contrast	3-8
Out of Memory message	3-8

4 Software Features

4-1

5 Important information

Federal Communications Commission (FCC) Declaration of Conformity (USA only)	5-1
Industry Canada Compliance Statement (Canada only)	5-2
Disconnect device	5-2
International Energy Star® Compliance Statement.....	5-2
Laser safety	5-2
FDA regulations.....	5-2
Important safety instructions.....	5-3
Trademarks	5-4

6 Troubleshooting and routine maintenance

Troubleshooting	6-1
Error messages	6-1
Document jams	6-3
Paper jams	6-4
If you are having difficulty with your DCP	6-8
Improving the print quality	6-11
Cleaning the drum unit	6-12
Packing and shipping the DCP	6-15
Routine maintenance	6-16
Cleaning the outside of the DCP	6-16
Cleaning the scanner glass	6-17
Cleaning the laser scanner window	6-17
Cleaning the corona wire	6-19
Replacing the toner cartridge (TN-350)	6-19
How to replace the toner cartridge	6-20
Replacing the drum unit (DR-350)	6-22
Machine Information	6-24
Checking the Serial Number.....	6-24
Checking the Page Counters.....	6-24
Checking the Drum Life	6-25

A Appendix

On-screen programming	A-1
Menu table	A-1
Menu Mode.....	A-1

S Specifications

Product description	S-1
General	S-1
Print media.....	S-2
Copy	S-3
Scanner	S-3
Printer	S-4
Interfaces.....	S-4
Computer requirements.....	S-5
Consumable items	S-6
Optional External Wireless Print/Scan Server (NC-2200w).....	S-6
Optional External Print Server (NC-2100p)	S-7

I Index **I-1**

1

Introduction

Using this Guide

Throughout this Guide you will see special symbols alerting you to important warnings, notes and actions. Special fonts identify keys you should press, messages that appear on the LCD, and important points or related topics.

Bold Bold typeface identifies specific keys on the DCP's control panel.

Italics Italicized typeface emphasizes an important point or refers you to a related topic.

`Courier` Courier type face identifies the messages on the LCD of the DCP.



Warnings tell you what to do to prevent possible personal injury.



Electrical Hazard icons alert you to a possible electrical shock.



Hot Surface icons warn you not to touch DCP parts that are hot.



Cautions specify procedures you must follow or avoid to prevent possible damage to the DCP or other objects.



Improper Setup icons alert you to devices and operations that are not compatible with the DCP.



Notes tell you how you should respond to a situation that may arise or give tips about how the current operation works with other features.

Choosing a location

Place your DCP on a flat, stable surface that is free of vibration and shocks, such as a desk. Put the DCP near a standard, grounded AC power outlet. Choose a location where the temperature remains between 50° to 90.5° F (10° to 32.5°C).

! CAUTION

- Avoid placing your DCP in a high-traffic area.
- Do not place your DCP near heaters, air conditioners, water, chemicals, or refrigerators.
- Do not expose your DCP to direct sunlight, excessive heat, moisture, or dust.
- Do not connect your DCP to an AC power outlet controlled by wall switches or automatic timers.
- Disruption of power can wipe out information in the DCP's memory.
- Do not connect your DCP to an AC power outlet on the same circuit as large appliances or other equipment that might disrupt the power supply.
- Avoid interference sources, such as speakers or the base units of cordless phones.

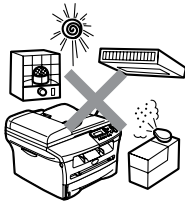

How to access the complete User's Guide

This User's Guide does not contain all the information about the DCP such as how to use the advanced features of the Printer and Scanner. When you are ready to learn detailed information about these operations, read the complete User's Guide in the 'Documentation' section of the CD-ROM.

To view Documentation (For Windows®)

From the **Start** menu, select **Brother**, **MFL Pro Suite DCP-7020** from the Programs Group, and then select **User's Guide**.

—OR—

- 1 Turn on your PC. Insert the Brother CD-ROM labeled Windows® into your CD-ROM drive.
- 2 If the model name screen appears, click your model name.
- 3 If the language screen appears, click your language.

The CD-ROM main menu will appear.

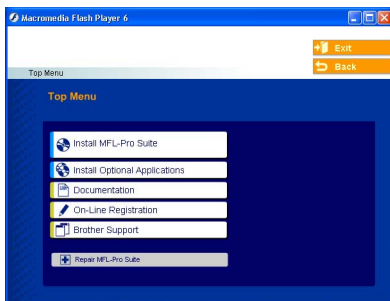

Note

If this window does not appear, use Windows® Explorer to run the setup.exe program from the root directory of the Brother CD-ROM.

- 4 Click **Documentation**.
- 5 Click the documentation you want to read.
 - **Quick Setup Guide:**
Setup and Software Installation Instructions
 - **User's Guide (2 manuals):**
User's Guide for stand-alone operations and Software User's Guide
 - **PaperPort® User's Guide:**
Document Management Software

How to find Scanning instructions

There are several ways you can scan documents. You can find the instructions as follows:

Software User's Guide:

- How to scan using Windows® in Chapter 2 (For Windows® 98/98SE/Me/2000 Professional/XP/Windows NT® Workstation Version 4.0)
- Using ControlCenter2.0 in Chapter 3 (For Windows® 98/98SE/Me/2000 Professional/XP/Windows NT® Workstation Version 4.0)
- Network Scanning (optional NC-2200w external wireless print/scan server required)

PaperPort® User's Guide

- Instructions for scanning directly from ScanSoft® PaperPort®

To view Documentation (For Macintosh®)

- 1 Turn on your Macintosh®. Insert the Brother CD-ROM labeled Macintosh® into your CD-ROM drive. The following window will appear.

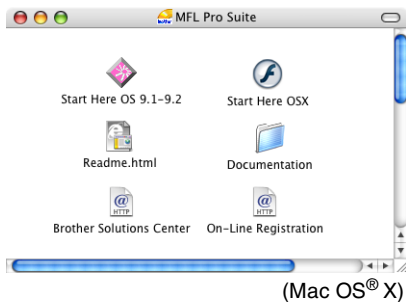

- 2 Double-click the **Documentation** icon.
- 3 The select Language screen appears, double-click your language.
- 4 Click the documentation you want to read.
 - **Quick Setup Guide:** Setup and Software Installation Instructions
 - **User's Guide (2 manuals):** User's Guide for stand-alone operations and Software User's Guide
 - **Presto!® PageManager®:** Document Management Software

How to find Scanning instructions

There are several ways you can scan documents. You can find the instructions as follows:

Software User's Guide:

- Scanning from a Macintosh® in Chapter 7 (For Mac OS® 9.1 - 9.2/Mac OS® X 10.2.4 or greater)
- Using ControlCenter2.0 (For Mac OS® X 10.2.4 or greater) in Chapter 7
- Network Scanning (optional NC-2200w external wireless print/scan server required)

Presto!® PageManager® User's Guide

- Instructions for scanning directly from Presto!® PageManager®.

Control panel overview

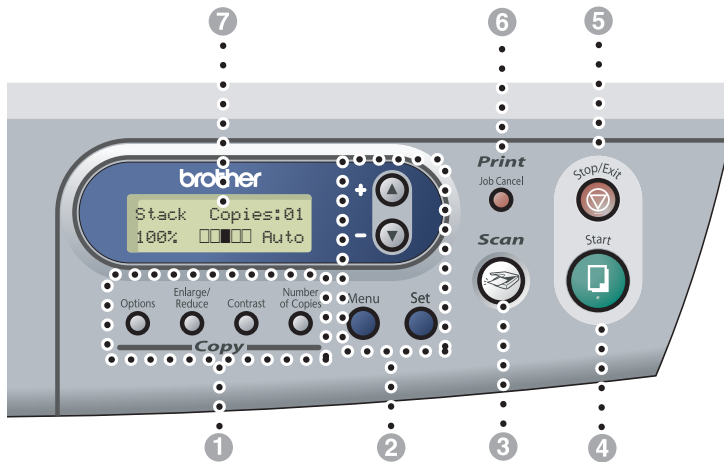

1 Copy keys

(Temporary settings):

Options

You can quickly and easily select temporary settings for copying.

Enlarge/Reduce

Lets you enlarge or reduce copies depending on the ratio you select.

Contrast

Lets you select the copy quality for your type of document.

Number of Copies

Use this key to make multiple copies.

2 Menu Mode:

Menu

Lets you access the Menu to program.

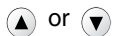

Press to scroll through the menus and options. Also you can use these keys to enter numbers.

Set

Lets you store your settings in the DCP.

3 Scan

Lets you access Scan mode.

4 Start

Lets you start making copies or start scanning.

5 Stop/Exit

Stops an operation or exits from the menu.

6 Print key:

Job Cancel

You can cancel a print job and clear the print memory.

7 Liquid Crystal Display (LCD)

Displays messages on the screen to help you set up and use your DCP.

Load document

You can make copies and scan from the ADF (automatic document feeder) and from the scanner glass.

Using the automatic document feeder (ADF)

The ADF can hold up to 35 pages and feeds each sheet individually. Use standard 20 lb (80 g/m²) paper and always fan the pages before putting them in the ADF.

Improper Setup

- **DO NOT** use paper that is curled, wrinkled, folded, ripped, stapled, paper-clipped, pasted or taped.
- **DO NOT** use cardboard, newspaper or fabric.

- Make sure documents written with ink are completely dry.
- Documents to be scanned must be from 5.8 to 8.5 in. (147.3 to 215.9 mm) wide and 5.8 to 14 in. (147.3 to 356 mm) long.

- 1 Fan the pages well. Make sure you put the documents **face up, top edge first** in the ADF until you feel them touch the feed roller.
- 2 Adjust the paper guides to fit the width of your documents.

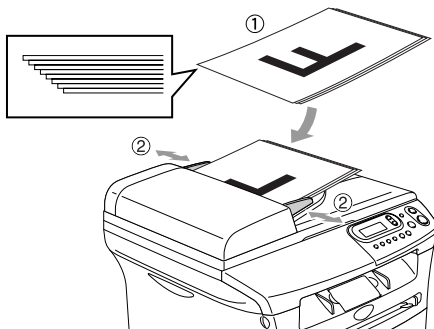

- 3 Unfold the ADF document output support flap.

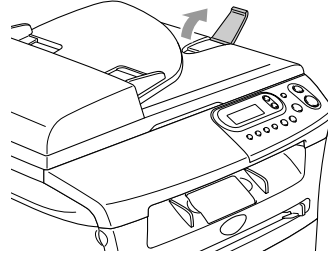

CAUTION

DO NOT pull on the document while it is feeding.

Using the scanner glass

You can use the scanner glass to copy or scan pages of a book or one page at a time. Documents can be up to Letter/A4 size (8.5 to 11 in. (215.9 to 297.4 mm)).



Note

To use the scanner glass, the ADF must be empty.

- 1 Lift the document cover.
- 2 Using the document guidelines on the left, center the document face down on the scanner glass.

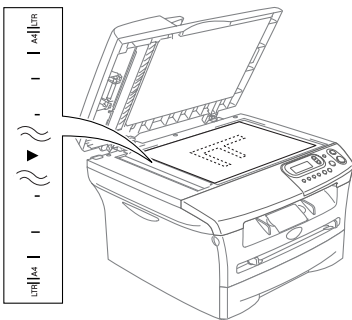

Place documents face down on the scanner glass.

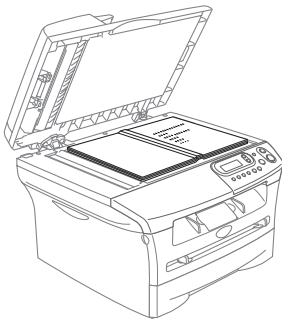

- 3 Close the document cover.



CAUTION

If the document is a book or is thick, do not slam the cover or press on it.

About paper

Recommended Paper

To get the best print quality, we suggest using the following paper.

Paper Type	Item
Plain paper	Xerox 4200DP 20 lb
	Hammermill Laser Paper 24 lb
	(Xerox Premier 80 g/m ²) (Xerox Business 80 g/m ²) (Mode DATACOPY 80 g/m ²) (IGEPA X-Press 80 g/m ²)
Recycled paper	(Xerox Recycled Supreme)
Transparency	3M CG 3300
Labels	Avery laser label #5160 (Avery laser label L7163)

- Use paper that is made for plain-paper copying.
- Use paper that is 20 to 24 lb (75 to 90 g/m²).
- Use neutral paper. Do not use acidic or alkaline paper.
- Use long-grain paper.
- Use paper with a moisture content of approximately 5%.

Choosing acceptable paper

We recommend that you test paper (especially special sizes and types of paper) on the DCP before purchasing large quantities.

For optimum printing, use a recommended type of paper, especially for plain paper and transparencies. For more information on paper specifications, call your nearest authorized sales representative or the place where you purchased your DCP.

- Use labels or transparencies that are designed for use in laser printers.
- If you are using special paper and the DCP has problems feeding it from the paper tray, try again using the manual feed slot.
- You can use recycled paper in this DCP.

! CAUTION

Do not use the following types of paper or envelopes, they may cause a paper jam and damage your machine.

Do not use:

- Inkjet paper;
- Coated paper, such as vinyl coated paper;
- Pre-printed or highly textured paper, or paper with an embossed letterhead;
- Label sheets that have had any labels removed;
- Paper that has been previously printed on;
- Paper that cannot be arranged uniformly when stacked;
- Paper that is made with a short grain;
- Damaged, curled, wrinkled, or irregularly shaped paper.

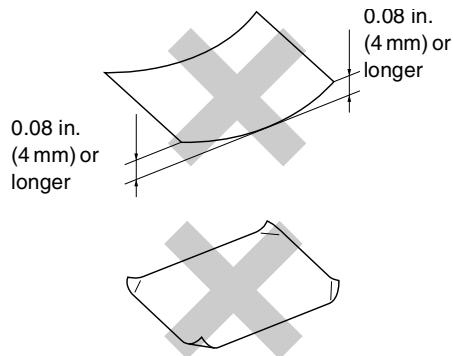

Do not use:

- Envelopes that have a baggy construction;
- Envelopes that are embossed (have raised writing on them);
- Envelopes that have clasps on them;
- Envelopes that are not sharply creased;
- Envelopes that are pre-printed on the inside.

Paper capacity of the paper trays

	Paper size	Paper types	No. of sheets
Paper tray	A4, Letter, Legal, Executive, A5, A6, B5 and B6	Plain paper, Recycled paper	up to 250
		Transparency	up to 10
Manual feed slot	Width: 2.75 - 8.5 in. (69.9 - 215.9 mm) Length: 4.56 - 16 in. (116 - 406.4 mm)	Plain paper, Recycled paper, Bond paper, Envelope, Label and Transparency	1

How to load paper

To load paper or other media in the paper tray

- 1 Pull the paper tray completely out of the DCP.

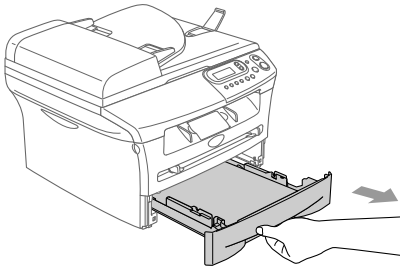

- 2 While pressing the paper guide release lever, slide the adjusters to fit the paper size. Check that the guides are firmly in the slots.

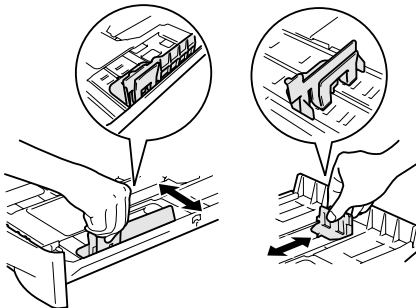

Note

For Legal size paper, pull out the back of the paper tray while holding the inside latch of the tray.

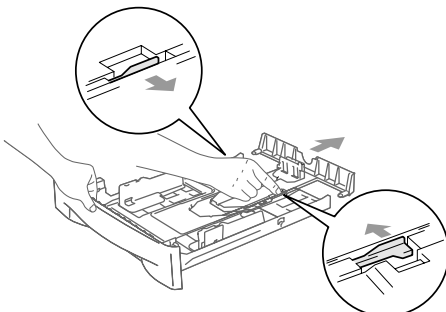

- 3 Fan the stack of paper well to avoid paper jams and mis-feeds.

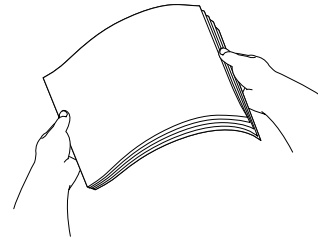

- 4 Put paper in the paper tray.

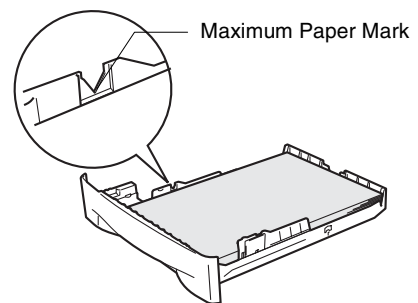

- 5 Put the paper tray firmly back in the DCP and unfold the output paper tray support flap before you use the DCP.

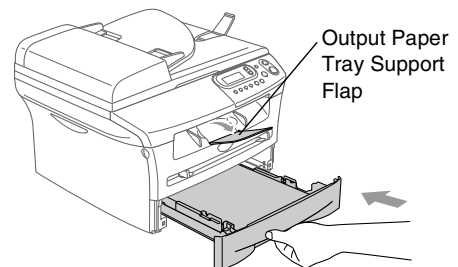

Note

When you put paper in the paper tray, please remember the following:

- Check that the paper is flat in the tray and below the maximum paper mark, and that the paper guides are touching the sides of the paper stack.
- The side to be printed on must be face down.

To load paper or other media in the manual feed slot

You can load envelopes and special print media one at a time into this slot. Use the manual feed slot to print or copy on labels, envelopes or thicker paper.

- 1 Slide the paper guides to fit the paper size.

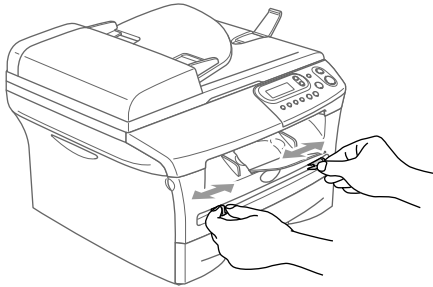

- 2 Using both hands put one sheet of paper in the manual feed slot until you feel the front edge of the paper touch the paper feed roller. Let go of the paper when you feel the DCP feed the paper in a short distance.

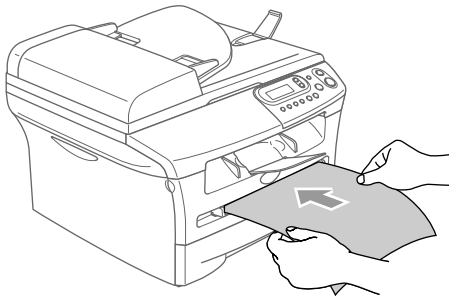

Note

When you put paper in the manual feed slot, please remember the following:

- The side to be printed on must be face up.
- Put the leading edge (top of the paper) in first and push it gently into the slot.
- Make sure that the paper is straight and in the proper position on the manual feed slot. If it is not, the paper may not be fed properly, resulting in a skewed printout or a paper jam.
- Do not put more than one sheet or envelope in the manual feed slot at a time, or you may cause the DCP to jam.
- To easily remove a small printout from the output tray, lift up the scanner cover by using both hands as shown in the illustration.

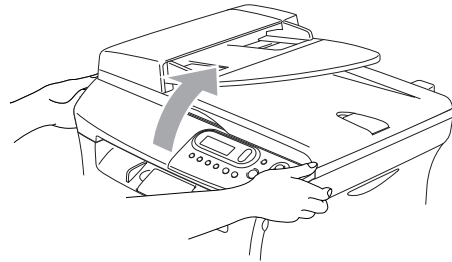

You can still use the DCP while the scanner cover is up. To close the scanner cover, push it down with both hands.

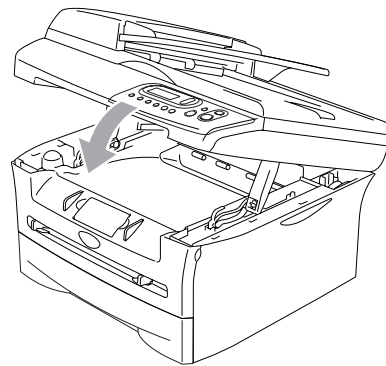



Initial Setup

Setting the Paper Type



To get the best print quality, set the DCP for the type of paper you are using.

- 1 Press **Menu** and  or  to select 1.General Setup.
Press **Set**.

- 2 Press  or  to select 1.Paper Type.

General Setup
 1.Paper Type

Press **Set**.

- 3 Press  or  to select Plain, Thin, Thick, Thicker, Transparency or Recycled Paper.
Press **Set**.

- 4 Press **Stop/Exit**.



Note

- The DCP ejects paper with printed surfaces face down onto the output paper tray in the front of the DCP. When you use transparencies or labels, remove each sheet immediately to prevent smudging or paper jams.
- You can select *Transparency* in Step 3 only if Letter, Legal or A4 paper size was selected as the paper size. (See Setting the Paper Size on this page.)

Setting the Paper Size

You can use eight sizes of paper for printing copies: Letter, Legal, A4, A5, A6, B5, B6 and Executive. When you change the size of paper you load in the tray, you will need to change the setting for paper size at the same time so your DCP can fit a reduced copy on the page.





Note

If you selected *Transparency* as the paper type, you will only be able to select Letter, Legal or A4 size paper in Step 3.



- 1 Press **Menu** and  or  to select 1.General Setup.

Press **Set**.

- 2 Press  or  to select 2.Paper Size.

General Setup
 2.Paper Size

Press **Set**.

- 3 Press  or  to select Letter, Legal, A4, A5, A6, B5, B6 or Executive.

Press **Set**.

- 4 Press **Stop/Exit**.

Setting the Beeper Volume

You can change the beeper volume. The default setting is `Med`. When the beeper is on, the DCP will beep when you press a key or make a mistake.



- 1 Press **Menu** and  or  to select 1.General Setup.

Press **Set**.

- 2 Press  or  to select 3.Beeper.

```
General Setup
3.Beeper
```

Press **Set**.

- 3 Press  or  to select Low, Med, High or Off.

Press **Set**.

- 4 Press **Stop/Exit**.

Toner Save

You can conserve toner using this feature. When you set Toner Save to `On`, print appears lighter. The default setting is `Off`.



- 1 Press **Menu** and  or  to select 1.General Setup.

Press **Set**.

- 2 Press  or  to select 4.Ecology.

```
General Setup
4.Ecology
```

Press **Set**.

- 3 Press  or  to select 1.Toner Save.

Press **Set**.





- 4 Press  or  to select On (or Off).

Press **Set**.

- 5 Press **Stop/Exit**.



Sleep Time

Setting the Sleep Time reduces power consumption by turning off the fuser inside the DCP while it is idle. You can choose how long the DCP is idle (from 00 to 99 minutes) before it goes into sleep mode. The timer is automatically reset when the DCP receives PC data or makes a copy. The factory setting is 05 minutes. While the DCP is in sleep mode you will see *Sleep* on the LCD. If you try to print or copy in sleep mode, there will be a short delay while the fuser warms up to its working temperature.

- 1 Press **Menu** and  or  to select 1.General Setup.
Press **Set**.
- 2 Press  or  to select 4.Ecology.



```
General Setup
4.Ecology
```

Press **Set**.

- 3 Press  or  to select 2.Sleep Time.

```
Ecology
2.Sleep Time
```

Press **Set**.

- 4 Use the  or  to enter the length of time the DCP is idle before it goes into sleep mode (00 to 99).

Press **Set**.

- 5 Press **Stop/Exit**.



Note

If you want to turn off sleep mode, press **Start** and **Options** simultaneously in Step 3.

Setting the LCD Contrast

You can change the contrast to help the LCD look lighter or darker.

- 1 Press **Menu** and  or  to select 1.General Setup.

Press **Set**.

- 2 Press  or  to select 5.LCD Contrast.

```
General Setup
5.LCD Contrast
```

Press **Set**.

- 3 Press  or  to select Light or Dark.

Press **Set**.

- 4 Press **Stop/Exit**.

Printing the User Settings List

You can print a list of your settings.

- 1 Press **Menu** and  or  to select 1.General Setup.

Press **Set**.

- 2 Press  or  to select 6.User Settings.

```
General Setup
6.User Settings
```

Press **Set**.

- 3 Press **Start**.

3

Making copies

Using the DCP as a copier

You can use your DCP as a copier, making up to 99 copies at a time.

The printable area of your DCP begins at approximately 0.12 in. (3 mm) from both sides and 0.12 in. (3 mm) from the top or bottom of the paper.

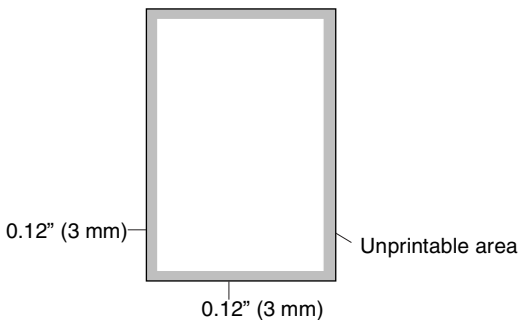

Note

The printable area shown above is for a single copy or a 1 in 1 copy using Letter or Legal size paper. The printable area changes with the paper size.

Making a single copy

- 1 Load your document.
- 2 Press **Start**.

Note

To stop copying, press **Stop/Exit**.

Making multiple copies

- 1 Load your document.
- 2 Press **Number of Copies** repeatedly until the number of copies you want appears (up to 99).

—OR—

Press **Number of Copies**, and then press or hold ▲ or ▼ to increase or decrease the number of copies.

Note

To sort the copies, press **Options** and ▲ or ▼ to select *Stack/Sort*. (See *Sorting copies using the ADF* on page 3-5.)

- 3 Press **Start**.

Stop copying

To stop copying, press **Stop/Exit**.

Using the Temporary Copy keys

When you want to quickly change the copy settings temporarily for the next copy, use the Temporary Copy keys. You can use different combinations.

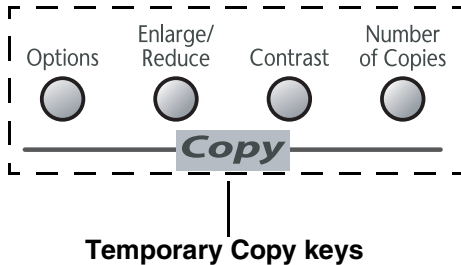

Note

- These settings are temporary, and the DCP returns to its default settings 60 seconds after copying.
- You can save the copy settings you use most often by setting them as default. (See *Changing the default copy settings* on page 3-7.)

Enlarging or reducing the image copied

You can select the following enlargement or reduction ratios.

Auto* sets the DCP to calculate the reduction ratio that best fits the size of paper.

Custom (25-400%) allows you to enter a ratio from 25% to 400%.

Press Enlarge/Reduce 	100%
	104% EXE→LTR
	141% A5→A4
	200%
	Auto*
	Custom (25-400%)
	50%
	70% A4→A5
	78% LGL→LTR
	83% LGL→A4
	85% LTR→EXE
	91% Full Page
	94% A4→LTR
97% LTR→A4	



Note

The Auto setting is available only when loading from the ADF.

- 1 Load your document.
- 2 Press **Enlarge/Reduce**.

- 3 Press ▲ or ▼ to select the enlargement or reduction ratio you want.

Press **Set**.

—OR—

You can select *Custom* (25–400%) and press **Set**.

Press ▲ or ▼ to enter an enlargement or reduction ratio from 25% to 400%.

Press **Set**.



Note

Enlargement or reduction ratio can also be increased or decreased by holding down ▲ or ▼.

- 4 Press **Start**.

—OR—

Press other temporary copy keys for more settings.



Note

- Special Copy Options (2 in 1 (P), 2 in 1 (L), 4 in 1 (P), 4 in 1 (L) or *Poster* (3 x 3)) are not available with **Enlarge/Reduce**.
- (P) means Portrait and (L) means Landscape.

Adjusting contrast

You can change the contrast to help an image look sharper and more vivid.

- 1 Load your document.

- 2 Press **Contrast**.



- 3 Press ▲ to increase the contrast.

—OR—

Press ▼ to decrease the contrast.

Press **Set**.



- 4 Press **Start**.

—OR—

Press other temporary copy keys for more settings.

Changing the temporary copy settings

Use the **Options** key to quickly set the following copy settings temporarily for the next copy.

Press 	Menu Selections  Select & Set	Options  Select & Set	Page
	Quality	Auto Text Photo	3-5
	Stack/Sort	Stack Sort	3-5
	Page Layout	Off(1 in 1) 2 in 1 (P) 2 in 1 (L) 4 in 1 (P) 4 in 1 (L) Poster(3 x 3)	3-5



Note

The factory settings are shown in **Bold**.





After you choose your settings by pressing **Set**, the LCD shows `Set` temporarily.

Press **Start** if you have finished choosing settings.



Quality





You can select the copy quality. The default setting is *Auto*.

Auto	Suitable for documents that contain both text and photographs.
Text	Suitable for documents containing only text.
Photo	Suitable for copying photographs.

- 1 Load your document.
- 2 Press **Options** and  or  to select **Quality**.
Press **Set**.
- 3 Press  or  to select the copy quality you want (*Auto*, *Text* or *Photo*).
Press **Set**.
- 4 Press **Start**.

Sorting copies using the ADF

You can sort multiple copies. Pages will be stacked in the order  (1 2 3),  (1 2 3) and so on.

- 1 Load your document.
- 2 Press **Number of Copies** repeatedly until the number you want appears (up to 99).
- 3 Press **Options** and  or  to select **Stack/Sort**.
Press **Set**.
- 4 Press  or  to select **Sort**.
Press **Set**.
- 5 Press **Start**.





Making N in 1 copies (Page Layout)

You can reduce the amount of copies by using the N in 1 copy feature. This allows you to copy two or four pages onto one page, allowing you to save paper.



Note

- Please make sure paper size is set to *Letter*, *Legal* or *A4*.
- You can use the N in 1 copy feature with 100% copy size only.
- (P) means Portrait and (L) means Landscape.

- 1 Load your document.
- 2 Press **Number of Copies** repeatedly until the number you want appears (up to 99).
- 3 Press **Options** and  or  to select **Page Layout**.
Press **Set**.
- 4 Press  or  to select 2 in 1 (P), 2 in 1 (L), 4 in 1 (P), or 4 in 1 (L).
Press **Set**.
- 5 Press **Start** to scan the document.

If you are using the scanner glass:

- After the DCP scans the page, the LCD shows:



Press ▲ to scan the next page.

- Put the next document on the scanner glass.



Press **Set**.

Repeat Steps 6 and 7 for each page of the layout.

- After all the pages of the document have been scanned, press ▼ to end.

Place document face down on the scanner glass in the direction shown below.

2 in 1 (P)

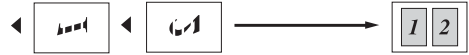

2 in 1 (L)

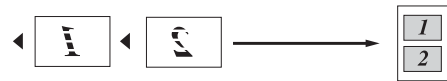

4 in 1 (P)



4 in 1 (L)

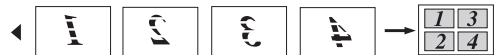

Place document face up in the ADF in the direction shown below.

2 in 1 (P)

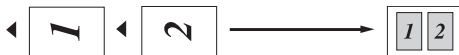

2 in 1 (L)

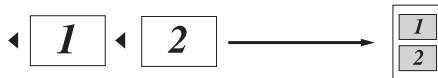

4 in 1 (P)



4 in 1 (L)



Making a poster (Page Layout)

You can create a poster. When you use the Poster feature your DCP divides your document into sections, then enlarges the sections so you can assemble them into a poster. If you want to print a poster, use the scanner glass.



Note

- Please make sure paper size is set to Letter, Legal or A4.
- For Poster copies, you cannot make more than one copy or use the Enlarge/Reduce feature.

- 1 Load your document.
- 2 Press **Options** and ▲ or ▼ to select **Page Layout**.
Press **Set**.
- 3 Press ▲ or ▼ to select **Poster (3 x 3)**.
Press **Set**.
- 4 Press **Start** to scan the document.

Poster (3x3)

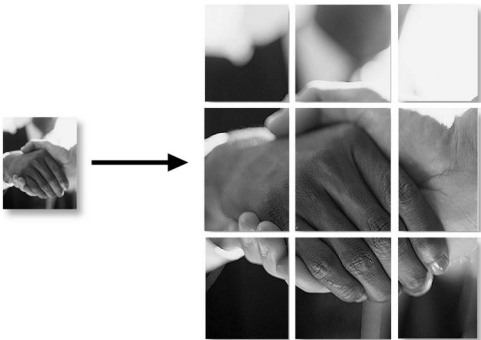

Changing the default copy settings

You can save the copy settings you use most often by setting them as default. These settings will remain until you change them again.

Quality

- 1 Press **Menu** and ▲ or ▼ to select **2.Copy**.
Press **Set**.
- 2 Press ▲ or ▼ to select **1.Quality**.

Press **Set**.
- 3 Press ▲ or ▼ to select **Auto, Text or Photo**.
Press **Set**.
- 4 Press **Stop/Exit**.

Adjusting contrast

You can change the contrast to help an image look sharper and more vivid.

- 1 Press **Menu** and ▲ or ▼ to select 2.Copy.
Press **Set**.
- 2 Press ▲ or ▼ to select 2.Contrast.

Copy
2.Contrast

 Press **Set**.
- 3 Press ▲ to increase the contrast.
—OR—
Press ▼ to decrease the contrast.
Press **Set**.
- 4 Press **Stop/Exit**.

Out of Memory message

If the memory becomes full while you are making copies, the LCD message will guide you through the next step.

If the *Out of Memory* message appears when you are scanning the first page of your document, press **Stop/Exit** and wait until the other operations in process finish and then try again.

If you were scanning subsequent pages, press **Stop/Exit** to cancel or **Start** to copy the scanned pages.

4

Software Features

The User's Guide on the CD-ROM includes the Software User's Guide for features available when connected to a computer (for example, Printing and Scanning). The availability of the features listed below varies by model:

- Using the machine as a Printer (See Chapter 1 in the Software User's Guide on the CD-ROM.)
- How to Scan (See Chapter 2 in the Software User's Guide on the CD-ROM.)
- Using ControlCenter2.0 (See Chapter 3 in the Software User's Guide on the CD-ROM.)
- Using Remote Setup (See Chapter 4 in the Software User's Guide on the CD-ROM.)
- Network Scanning (Optional NC-2200w external print/scan server required)
- Network Printing (Optional NC-2200w external print/scan server required)



Note

See also *How to access the complete User's Guide* on page 1-3.

Federal Communications Commission (FCC) Declaration of Conformity (USA only)

Responsible Party:

Brother International Corporation
100 Somerset Corporate Boulevard
Bridgewater, NJ 08807-0911 USA
TEL: (908) 704-1700

declares, that the products

Product Name: Laser DCP, DCP-7020

comply with Part 15 of the FCC Rules. Operation is subject to the following two conditions: (1) This device may not cause harmful interference, and (2) this device must accept any interference received, including interference that may cause undesired operation.

This equipment has been tested and found to comply with the limits for a Class B digital device, pursuant to Part 15 of the FCC Rules. These limits are designed to provide reasonable protection against harmful interference in a residential installation. This equipment generates, uses, and can radiate radio frequency energy and, if not installed and used in accordance with the instructions, may cause harmful interference to radio communications. However, there is no guarantee that interference will not occur in a particular installation. If this equipment does cause harmful interference to radio or television reception, which can be determined by turning the equipment off and on, the user is encouraged to try to correct the interference by one or more of the following measures:

- Reorient or relocate the receiving antenna.
- Increase the separation between the equipment and receiver.
- Connect the equipment into an outlet on a circuit different from that to which the receiver is connected.
- Call the dealer or an experienced radio/TV technician for help.

WARNING

- This DCP has been certified to comply with FCC standards, which are applied to the USA only. A grounded plug should be plugged into a grounded AC outlet after checking the rating of the local power supply for the DCP to operate properly and safely.
- For protection against the risk of electrical shock, always disconnect all cables from the wall outlet before servicing, modifying or installing the equipment.

Important

Changes or modifications not expressly approved by Brother Industries, Ltd. could void the user's authority to operate the equipment.

WARNING

Brother cannot accept any financial or other responsibilities that may be the result of your use of this information, including direct, special or consequential damages. There are no warranties extended or granted by this document.

Important - about the interface cable

A shield interface cable should be used to ensure compliance with the limits for a Class B digital device.

Industry Canada Compliance Statement (Canada only)

This Class B digital apparatus complies with Canadian ICES-003.

Cet appareil numérique de la classe B est conforme à la norme NMB-003 du Canada.

Disconnect device

This product must be installed near an AC power outlet that is easily accessible. In case of emergency, you must disconnect the power cord from the AC power outlet to shut off the power completely.

International ENERGY STAR® Compliance Statement

The purpose of the International ENERGY STAR® Program is to promote the development and popularization of energy-efficient office equipment.

As an ENERGY STAR® Partner, Brother Industries, Ltd. has determined that this product meets the ENERGY STAR® guidelines for energy efficiency.



Laser safety

This equipment is certified as a Class 1 laser product under the U.S. Department of Health and Human Services (DHHS) Radiation Performance Standard according to the Radiation Control for Health and Safety Act of 1968. This means that the equipment does not produce hazardous laser radiation.

Since radiation emitted inside the equipment is completely confined within protective housings and external covers, the laser beam cannot escape from the DCP during any phase of user operation.

FDA regulations

U.S. Food and Drug Administration (FDA) has implemented regulations for laser products manufactured on and after August 2, 1976. Compliance is mandatory for products marketed in the United States. The following label on the back of the DCP indicates compliance with the FDA regulations and must be attached to laser products marketed in the United States.

Manufactured:

BROTHER CORP. (ASIA) LTD.

BROTHER BUJI NAN LING FACTORY

Gold Garden Industry, Nan Ling Village, Buji, Rong Gang, Shenzhen, China.

This product complies with FDA for laser products except for deviations pursuant to Laser Notice No. 50, dated July 26, 2001.



WARNING

Use of controls, adjustments or performance of procedures other than those specified in this manual may result in hazardous invisible radiation exposure.

Internal laser radiation

Max. Radiation Power 5 mW

Wave Length 770 - 810 nm

Laser Class Class 3B

Important safety instructions

- 1 Read all of these instructions.
- 2 Save them for later reference.
- 3 Follow all warnings and instructions marked on the product.
- 4 Unplug this product from the wall outlet before cleaning inside of the DCP. Do not use liquid or aerosol cleaners. Use a damp cloth for cleaning.
- 5 Do not use this product near water.
- 6 Do not place this product on an unstable cart, stand, or table. The product may fall, causing serious damage to the product.
- 7 Slots and openings in the cabinet and the back or bottom are provided for ventilation; to ensure reliable operation of the product and to protect it from overheating, these openings must not be blocked or covered. The openings should never be blocked by placing the product on a bed, sofa, rug, or other similar surface. This product should never be placed near or over a radiator or heater. This product should never be placed in a built-in installation unless proper ventilation is provided.
- 8 This product should be operated from the type of power source indicated on the label. If you are not sure of the type of power available, call your dealer or local power company.
- 9 Use only the power cord supplied with this DCP.
- 10 This product is equipped with a 3-wire grounded plug. This plug will only fit into a grounded power outlet. This is a safety feature. If you are unable to insert the plug into the outlet, call your electrician to replace your obsolete outlet. Do not defeat the purpose of the grounded plug.
- 11 Do not allow anything to rest on the power cord. Do not place this product where people can walk on the cord.
- 12 If an extension cord is used with this product, make sure that the total ampere ratings on the products plugged into the extension cord do not exceed the extension cord ampere rating. Also, make sure that the total of all products plugged into the AC power outlet does not exceed 15 amperes (USA only).
- 13 Do not place anything in front of the DCP that will block printing. Do not place anything in the path of printing.
- 14 Wait until pages have exited the DCP before picking them up.
- 15 Never push objects of any kind into this product through cabinet slots, since they may touch dangerous voltage points or short out parts resulting in the risk of fire or electric shock. Never spill liquid of any kind on the product. Do not attempt to service this product yourself because opening or removing covers may expose you to dangerous voltage points and other risks and may void your warranty. Refer all servicing to a Brother Authorized Service Center. For the location of your nearest Brother Authorized Service Center, please call
In USA: 1-800-284-4357
In Canada: 1-877-BROTHER.
(See *Brother numbers* on page i.)

16 Unplug this product from the AC power outlet and refer servicing to Authorized Service Personnel under the following conditions:

- When the power cord is damaged or frayed.
- If liquid has been spilled into the product.
- If the product has been exposed to rain or water.
- If the product does not operate normally when the operating instructions are followed. Adjust only those controls that are covered by the operating instructions. Improper adjustment of other controls may result in damage and will often require extensive work by a qualified technician to restore the product to normal operation.
- If the product has been dropped or the cabinet has been damaged.
- If the product exhibits a distinct change in performance, indicating a need for service.

17 To protect your product against power surges, we recommend the use of a power protection device (Surge Protector).

18 To reduce the risk of fire, electric shock and injury to people, note the following:

- Do not use this product near appliances that use water, a swimming pool or in a wet basement.
- Use only the power cord supplied with this machine.

Trademarks

The Brother logo is a registered trademark of Brother Industries, Ltd.

Brother is a registered trademark of Brother Industries, Ltd.

Multi-Function Link is a registered trademark of Brother International Corporation.

© 2004-2005 Brother Industries, Ltd. All rights reserved.

Windows and Microsoft are registered trademarks of Microsoft in the U.S. and other countries.

Macintosh and TrueType are registered trademarks of Apple Computer, Inc.

PaperPort and OmniPage OCR are registered trademarks of ScanSoft, Inc.

Presto! PageManager is a registered trademark of NewSoft Technology Corporation.

Each company whose software title is mentioned in this manual has a Software License Agreement specific to its proprietary programs.

All other brand and product names mentioned in this User's Guide and the Software User's Guide are registered trademarks of their respective companies.

Troubleshooting

Error messages

As with any sophisticated office product, errors may occur. If this happens, your DCP identifies the problem and displays an error message. The most common error messages are shown below.

You can correct most problems by yourself. If you need more help, the Brother Solutions Center offers latest FAQs and troubleshooting tips.

Visit us at <http://solutions.brother.com>.

ERROR MESSAGES		
ERROR MESSAGE	CAUSE	ACTION
Back Cover Open	The back cover is not completely closed.	Close the back cover of the DCP.
Change Drum Soon	The drum unit is near the end of its life.	Use the drum unit until you have a print quality problem; then replace the drum unit with a new one. See <i>Replacing the drum unit (DR-350)</i> on page 6-22.
Cooling Down Wait for a while	The temperature of the drum unit or toner cartridge is too hot. The DCP will pause its current print job and go into cooling down mode. During the cooling down mode, you will hear the cooling fan running while the display on the DCP shows <i>Cooling Down</i> , and <i>Wait for a while</i> .	You must wait 20 minutes for it to cool.
Cover is Open	The front cover is not completely closed.	Close the front cover for the drum unit.
Document Jam	The document was not inserted or fed properly or the document scanned from the ADF was too long.	See <i>Document jams</i> on page 6-3. See <i>Using the automatic document feeder (ADF)</i> on page 1-6.
Data Remaining	Print data is left in the DCP's memory.	Re-start printing from your computer.
	Print data is left in the DCP's memory. The USB cable was unplugged while the computer was sending the data to the DCP.	Press Job Cancel . The DCP will cancel the job and eject the page that is being printed.
Dust on Drum	The drum unit needs to be cleaned.	See <i>Cleaning the drum unit</i> on page 6-12.
Fail to Warm up	The fuser unit is too cold.	Turn off the DCP's power switch, and check the DCP's environment. If it is in a location that is too cold or too hot, try to cool or warm the room by turning on the air conditioner or heater. Or, change the location. Then, turn on the DCP's power switch.
Unit is too Hot	The fuser unit is too hot.	

ERROR MESSAGES		
ERROR MESSAGE	CAUSE	ACTION
Machine too Hot	The inside of the machine is too hot.	Make sure you can hear the fan in the DCP spinning and the exhaust outlet isn't blocked by something. If the fan is spinning, remove some obstacles that surround the exhaust outlet, and then leave the DCP for several minutes. If the fan is not spinning, turn off the DCP and then turn it on again.
No cartridge	The toner cartridge is not installed properly.	Reinstall the toner cartridge.
No Paper Fed	The DCP is out of paper or paper is not properly loaded in the paper tray.	Refill the paper in the paper tray. —OR— Remove the paper and load it again.
Out of Memory	The DCP's memory is full.	(Copy operation in process) Press Stop/Exit and wait until the other operations in process finish and then try again. (Printing operation in process) Reduce print resolution. (See <i>Advanced tab</i> in the Software User's Guide on the CD-ROM.)
Paper jam Inside	The paper is jammed inside the DCP.	(See <i>Paper jams</i> on page 6-4.)
Paper Jam Rear	The paper is jammed in the back of the DCP.	(See <i>Paper jams</i> on page 6-4.)
Paper Jam Tray	The paper is jammed in the paper tray of the DCP.	(See <i>Paper jams</i> on page 6-4.)
Scanner Locked	The scanner needs to be reset.	Turn off the DCP and then turn it on again.
Toner Life End	The toner cartridge and drum unit assembly are not installed. —OR— Toner is used up and printing is not possible.	Re-install the toner cartridge and drum unit assembly. —OR— Replace the toner cartridge with a new one. (See <i>Replacing the toner cartridge (TN-350)</i> on page 6-19.)
Toner Low	The toner cartridge is near the end of its life and the toner will soon run out.	Order a new toner cartridge now.
Unable to Init. (Initialize)	The DCP has a mechanical problem.	Turn off the DCP's power switch, and then on again, If the error message continues, leave the DCP for several minutes and try it again.
Unable to Print		
Unable to Scan		

Document jams

If the document is jammed, follow the steps below.

Document is jammed in the top of the ADF unit

- 1 Take out any paper from the ADF that is not jammed.
- 2 Open the ADF cover.
- 3 Pull the jammed document out to the left.

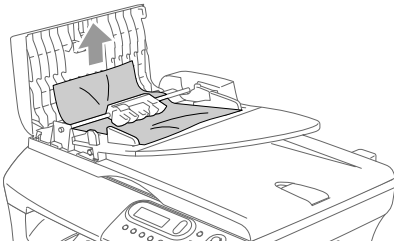

- 4 Close the ADF cover.
- 5 Press **Stop/Exit**.

Document is jammed under the document cover

- 1 Take out any paper from the ADF that is not jammed.
- 2 Lift the document cover.
- 3 Pull the jammed document out to the right.

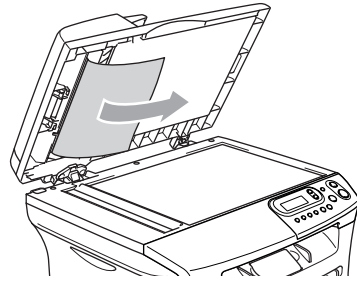

- 4 Close the document cover.
- 5 Press **Stop/Exit**.

Document is jammed at the output tray

- 1 Pull the jammed document out to the right.

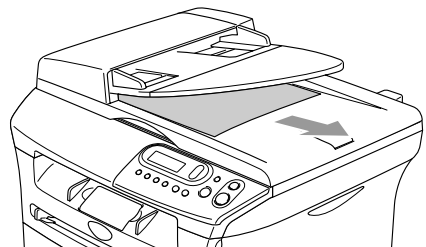

- 2 Press **Stop/Exit**.

Paper jams

To clear paper jams, please follow the steps in this section.

! WARNING

After you have just used the DCP, some parts inside the machine are extremely hot. When you open the front cover or back cover of the DCP, never touch the shaded parts shown in the following diagram.

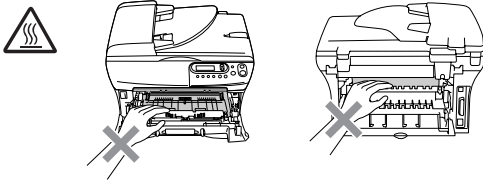

Paper is jammed inside the DCP

- 1 Pull the paper tray completely out of the DCP.
- 2 Pull the jammed paper up and out of the paper tray opening.

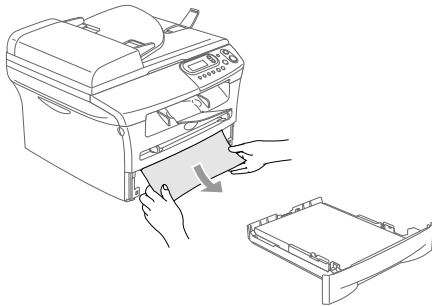

- 3 Open the front cover.

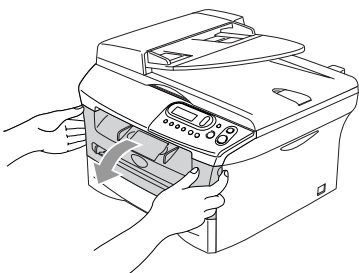

- 4 Pull out the drum unit and toner cartridge assembly. The jammed paper may be pulled out with the toner cartridge and drum unit assembly, or this may release the paper so you can pull it up and out of the paper tray opening.

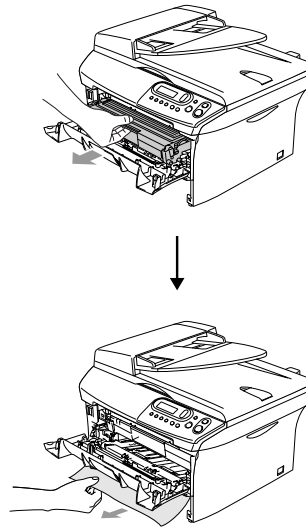

- 5 If you can not remove the drum unit and toner cartridge assembly easily, do not use extra force. Instead, lift the scanner cover and use both hands to carefully pull the jammed paper up and out of the output tray opening.

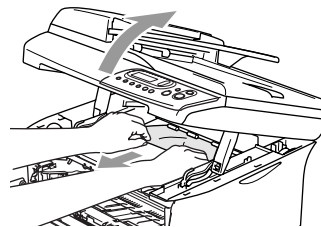

! CAUTION

To prevent damage to the DCP caused by static electricity, do not touch the electrodes shown in the following diagram.

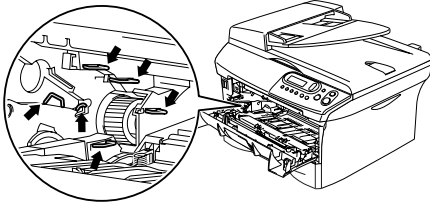

Paper is jammed at back of the DCP

- 1 Open the front cover.

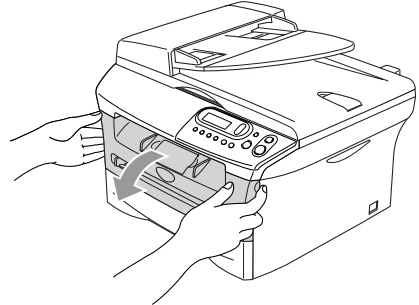

- 6 Put the drum unit and toner cartridge assembly back in the DCP.

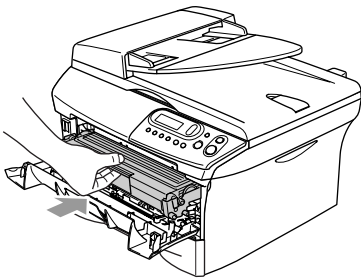

- 2 Pull out the drum unit and toner cartridge assembly.

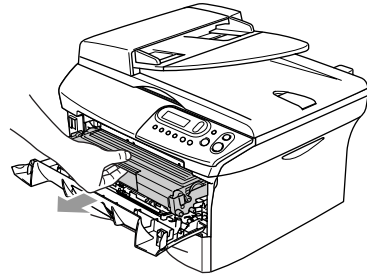

- 7 Close the front cover.

- 8 Put the paper tray in the DCP.

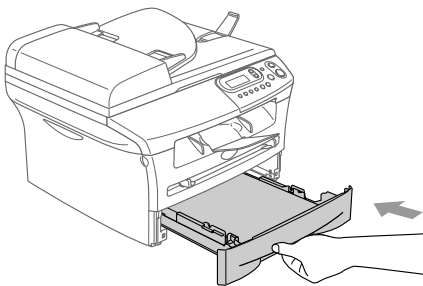

- 3 Open the back cover.

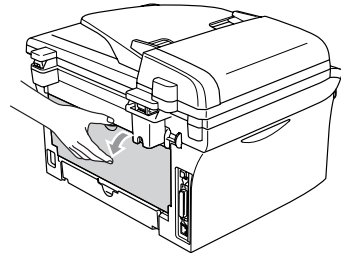

- 4 Pull the tab toward you to open the rear chute cover.

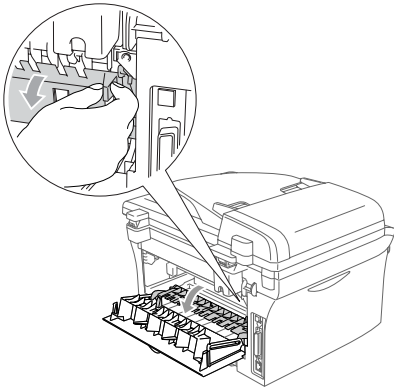

- 7 Put the drum unit and toner cartridge assembly back into the DCP.

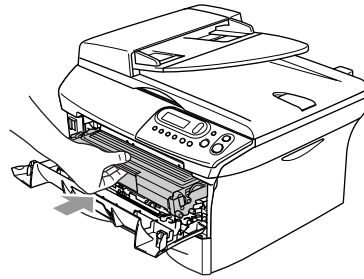

- 8 Close the front cover.

- 5 Pull the jammed paper out of the fuser unit. If the jammed paper cannot be pulled out easily, push down on the blue tab with one hand as you gently pull out the paper with the other hand.

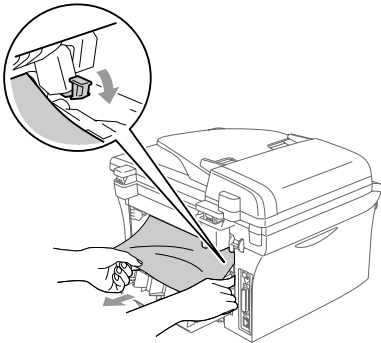

- 6 Close the back cover.

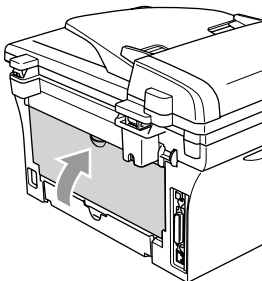

Paper is jammed inside the drum unit and toner cartridge assembly

- 1 Open the front cover.

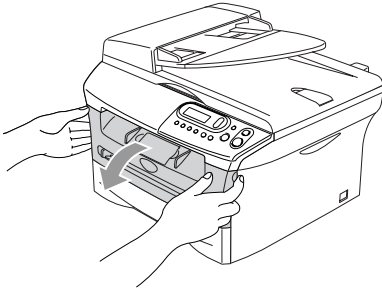

- 2 Pull out the drum unit and toner cartridge assembly.

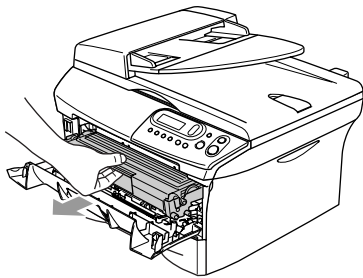

- 3 Hold down the lock lever on the left and pull the toner cartridge out of the drum unit. Take out the jammed paper if there is any inside the drum unit.

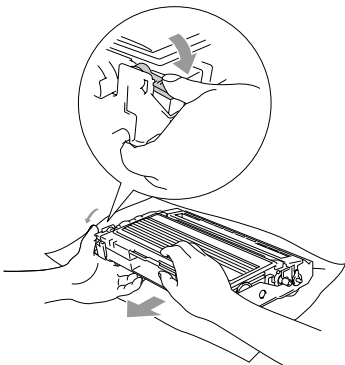

- 4 Put the toner cartridge back into the drum unit until you hear it lock into place. If you put it in properly, the lock lever will lift automatically.

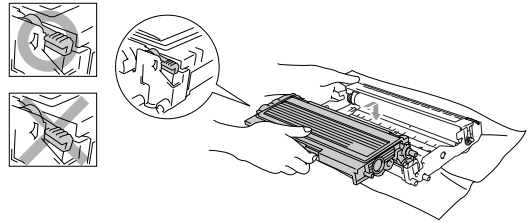

- 5 Put the drum unit and toner cartridge assembly back in the DCP.

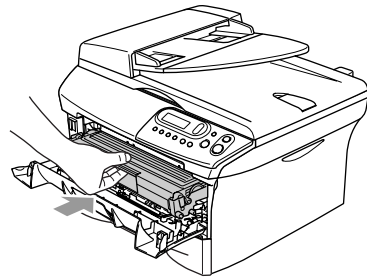

- 6 Close the front cover.

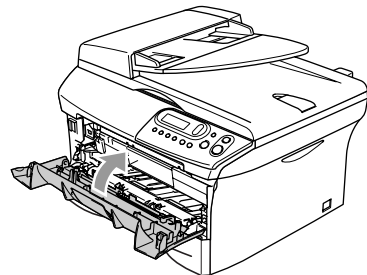

If you are having difficulty with your DCP

If you think there is a problem with your DCP, check the chart below and follow the troubleshooting tips.

The Brother Solutions Center offers the latest FAQs and troubleshooting tips.

Visit us at <http://solutions.brother.com>.







DIFFICULTY	SUGGESTIONS
Printing Difficulties	
Poor print quality	See <i>Improving the print quality</i> on page 6-11.
Vertical black lines.	Sometimes you may see vertical streaks/black lines on the printed pages. The drum unit's primary corona wire may be dirty. Clean your primary corona wire (See <i>Cleaning the corona wire</i> on page 6-19).
Copy Quality Difficulties	
Vertical black streaks or black spots appear in copies.	Sometimes you may see vertical streaks on your copies. Either the scanner or the drum unit's primary corona wire is dirty. Clean them both. (See <i>Cleaning the scanner glass</i> on page 6-17 and <i>Cleaning the corona wire</i> on page 6-19.)
Printer Difficulties	
The DCP does not print.	Please make sure: <ul style="list-style-type: none"> • The DCP is plugged in and the power switch is turned on. —OR— • The toner cartridge and drum unit are installed properly. (See <i>Replacing the drum unit (DR-350)</i> on page 6-22.) —OR— • The interface cable is securely connected between the DCP and computer. (See the Quick Setup Guide.) —OR— • Check to see if LCD is showing an error message. (See <i>Error messages</i> on page 6-1.) —OR— • DCP is online. Click Start and then Printer and Faxes. Select the 'Brother DCP-7020' and right-click. Make sure that "Use Printer Offline" is unchecked.
The DCP prints unexpectedly or it prints garbage.	Turn off the DCP's power switch and then turn it on again. Check the primary settings in your application software to make sure it is set up to work with your DCP.
The DCP prints first couple of pages correctly, then some pages have text missing.	Your computer is not recognizing the DCP's input buffer full signal. Please make sure you connect the DCP cable correctly. (See the Quick Setup Guide.)
The DCP cannot print full pages of a document. Out of Memory message occurs.	Reduce the printing resolution. (See <i>Advanced tab</i> in the Software User's Guide on the CD-ROM.) Reduce the complexity of your document and try again. Reduce the graphic quality or the number of font sizes within your application software.
My headers or footers appear when I view my document on the screen but do not appear when I print them.	Your DCP can print 62 lines per page. The top two lines and bottom two lines are a restricted area that will not accept print. Adjust the top and bottom margins in your document to allow for this.



DIFFICULTY	SUGGESTIONS
Scanning Difficulties	
TWAIN errors appear while scanning.	Make sure the Brother TWAIN driver is selected as the primary source. In PaperPort®, click Scan in the File menu and select the Brother TWAIN driver.
Software Difficulties	
Cannot install software or print.	Run the Repair MFL-Pro Suite program on the CD-ROM. This program will repair and reinstall the software.
Cannot perform '2 in 1 or 4 in 1' printing.	Check that the paper size setting in the application and in the printer driver are the same.
Cannot print when using Adobe Illustrator.	Try to reduce the print resolution. (See <i>Advanced tab</i> in the Software User's Guide on the CD-ROM.)
When using ATM fonts, some characters are missing or some characters are printed in their place.	If you are using Windows® 98/98SE/Me, select 'Printer Settings' from the 'Start' menu. Select the properties of the 'Brother DCP-7020'. Click 'Spool Setting' on the 'Details' tab. Select 'RAW' from 'Spool Data Format'.
'Unable to write to LPT1' or 'LPT1 already in use' Error Message appears.	<ol style="list-style-type: none"> 1. Make sure the DCP is on (plugged into the AC power outlet and the power switch turned on) and that it is connected directly to the computer using the IEEE-1284 bi-directional parallel cable. The cable must not go through another peripheral device (such as a Zip Drive, External CD-ROM Drive, or Switch box). 2. Make sure the DCP is not displaying an error message on the LCD Display. 3. Make sure no other device drivers, which also communicate through the parallel port, are running automatically when you boot up the computer (such as, drivers for Zip Drives, External CD-ROM Drive, etc.) Suggested areas to check: (<i>Load=, Run=command lines in the win.ini file or the Setup Group</i>) 4. Check with your computer manufacturer to confirm that the computer's parallel port settings in the BIOS are set to support a bi-directional DCP; i.e. (Parallel Port Mode – ECP)
'MFC is Busy' Error Message appears.	



DIFFICULTY	SUGGESTIONS
Paper Handling Difficulties	
The DCP does not load paper. The LCD shows <i>No Paper Fed</i> or <i>Paper Jam</i> .	If there is no paper, load a new stack of paper into the paper tray. If there is paper in the paper tray, make sure it is straight. If the paper is curled, you should straighten it. Sometimes it is helpful to remove the paper, turn the stack over and put it back into the paper tray. Reduce the amount of paper in the paper tray, and then try again. Check that the manual feed mode is not selected in the printer driver. If the LCD shows <i>Paper Jam</i> and you still have a problem, see <i>Paper jams</i> on page 6-4.
The DCP does not feed paper from the manual feed slot.	Reinsert the paper firmly, load one sheet at a time. Make sure that manual feed mode is selected in the printer driver.
How can I load envelopes?	You can load envelopes from the manual feed slot. Your application software must be set up to print the envelope size you are using. This is usually done in the Page Setup or Document Setup menu of your software. Please refer to the manual provided with your software application.
What paper can I use?	You can use plain paper, recycled paper, envelopes, transparencies and labels that are made for laser machines. (For information on paper you can use, see <i>About paper</i> on page 1-8.)
How can I clear paper jams?	See <i>Paper jams</i> on page 6-4.
Print Quality Difficulties	
Printed pages are curled.	Low quality thin or thick paper can cause this problem. Make sure you select the Paper Type that suits the media type you use. (See <i>About paper</i> on page 1-8.)
Printed pages are smeared.	The Paper Type setting may be incorrect for the type of print media you are using— OR —The print media may be too thick or have a rough surface. (See <i>About paper</i> on page 1-8 and <i>Basic tab</i> in the Software User's Guide on the CD-ROM.)
Printouts are too light.	If your DCP is not connected to a computer, turn off Toner Save mode in the DCP itself. (See <i>Toner Save</i> on page 2-2.) Set Toner Save mode to off in the Advanced tab in the printer driver. (See <i>Advanced tab</i> in the Software User's Guide on the CD-ROM.) If the printout is a copy, adjust the contrast. (See <i>Adjusting contrast</i> on page 3-8.)

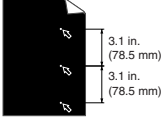
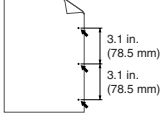
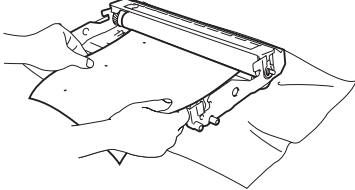

Improving the print quality

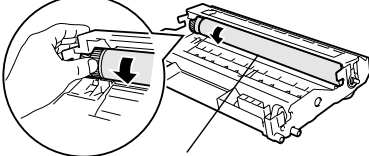
This section provides information on the following topics:

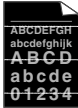
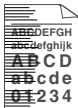
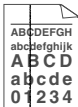
Examples of poor print quality	Recommendation
 <p>Faint</p>	<p>Check the DCP's environment. Conditions such as humidity, high temperatures, and so on may cause this print fault. (See <i>Choosing a location</i> on page 1-2.)</p> <p>If the whole page is too light, turn off Toner Save mode in the DCP menu settings or in the printer driver. (See <i>Toner Save</i> on page 2-2 or <i>Advanced tab</i> in the Software User's Guide on the CD-ROM.)</p> <p>—OR—</p> <p>If your DCP is not connected to a computer, turn off Toner Save mode in the DCP itself. (See <i>Toner Save</i> on page 2-2.)</p> <p>Clean the laser scanner window and the primary corona wire on the drum unit. (See <i>Cleaning the laser scanner window</i> on page 6-17 and <i>Cleaning the corona wire</i> on page 6-19.) If the print quality has not improved, install a new drum unit. (See <i>Replacing the drum unit (DR-350)</i> on page 6-22.)</p> <p>Install a new toner cartridge. (See <i>Replacing the toner cartridge (TN-350)</i> on page 6-19.)</p>
 <p>Gray background</p>	<p>Make sure that you use paper that meets the recommended specifications. (See <i>About paper</i> on page 1-8.)</p> <p>Check the DCP's environment - high temperatures and high humidity can increase the amount of background shading. (See <i>Choosing a location</i> on page 1-2.)</p> <p>Install a new toner cartridge. (See <i>Replacing the toner cartridge (TN-350)</i> on page 6-19.)</p> <p>Clean the primary corona wire on the drum unit. (See <i>Cleaning the corona wire</i> on page 6-19.) If the print quality has not improved, install a new drum unit. (See <i>Replacing the drum unit (DR-350)</i> on page 6-22.)</p>
 <p>Ghost</p>	<p>Make sure you use paper that meets our specifications. Rough-surfaced paper or thick print media may cause this problem.</p> <p>Make sure that you choose the appropriate media type in the printer driver or in the DCP's Paper Type menu setting. (See <i>About paper</i> on page 1-8 and <i>Basic tab</i> in the Software User's Guide on the CD-ROM.)</p> <p>Install a new drum unit. (See <i>Replacing the drum unit (DR-350)</i> on page 6-22.)</p>
 <p>Toner specks</p>	<p>Make sure that you use paper that meets our specifications. Rough-surfaced paper may cause the problem. (See <i>About paper</i> on page 1-8.)</p> <p>Clean the primary corona wire and the drum unit. (See <i>Cleaning the corona wire</i> on page 6-19 and See <i>Cleaning the drum unit</i> on page 6-12.) If the print quality has not improved, install a new drum unit. (See <i>Replacing the drum unit (DR-350)</i> on page 6-22.)</p>
 <p>Hollow print</p>	<p>Make sure that you use paper that meets our specifications. (See <i>About paper</i> on page 1-8.)</p> <p>Choose Thick paper mode in the printer driver or in the DCP's Paper Type menu setting, or use thinner paper than you are currently using. (See <i>Basic tab</i> in the Software User's Guide on the CD-ROM.)</p> <p>Check the DCP's environment because conditions such as high humidity can cause hollow print. (See <i>Choosing a location</i> on page 1-2.)</p> <p>Clean the primary corona wire on the drum unit. (See <i>Cleaning the corona wire</i> on page 6-19.) If the print quality has not improved, install a new drum unit. (See <i>Replacing the drum unit (DR-350)</i> on page 6-22.)</p>
 <p>All black</p>	<p>Clean the primary corona wire on the drum unit. (See <i>Cleaning the corona wire</i> on page 6-19.)</p> <p>If the print quality has not improved, install a new drum unit. (See <i>Replacing the drum unit (DR-350)</i> on page 6-22.)</p>

Examples of poor print quality	Recommendation
 <p>White Spots on black text and graphics at 3.1 in. (78.5 mm) intervals</p>  <p>Black Spots at 3.1 in. (78.5 mm) intervals</p>	<h2 data-bbox="463 258 872 297">Cleaning the drum unit</h2> <p data-bbox="463 314 1226 369">Dust, paper powder, glue, and so on may stick to the surface of the photosensitive drum (OPC) and cause black or white spots to appear on printed documents.</p> <p data-bbox="463 374 1226 428">Make 10 to 15 copies of a blank, white sheet of paper. (See <i>Making multiple copies</i> on page 3-1.)</p> <p data-bbox="463 434 1226 488">If you still see the spots on printed documents after making multiple copies, clean the drum unit as follows:</p> <ol data-bbox="463 494 1226 600" style="list-style-type: none"> 1 Remove the drum unit and toner cartridge assembly, and then remove the toner cartridge from the drum unit. 2 Position the print sample in front of the drum unit so you will know the exact position on the drum that is causing the poor print.  <ol data-bbox="463 823 1226 877" style="list-style-type: none"> 3 Turn the black gear on the drum as you check the surface of the OPC drum. <ul data-bbox="473 852 1159 877" style="list-style-type: none"> ! The OPC drum is photosensitive so do not touch it with your fingers.  <p data-bbox="801 1058 978 1078">OPC drum surface</p> <ol data-bbox="463 1103 1226 1232" style="list-style-type: none"> 4 When you find the substance on the drum surface that matches the print sample, gently <i>dab</i> the surface of the OPC drum with a cotton swab that is lightly dampened with isopropyl alcohol. <ul data-bbox="473 1188 1201 1232" style="list-style-type: none"> ! Do not use a scrubbing or wiping motion because this might damage the drum.  <ul data-bbox="473 1479 1226 1557" style="list-style-type: none"> ! Do not try to clean the surface of the OPC drum with a sharp object, such as a ball-point pen, because this might cause permanent damage to the drum unit. <p data-bbox="463 1599 1133 1647">If the print quality still has not improved you need to install a new drum. (See <i>Replacing the drum unit (DR-350)</i> on page 6-22.)</p>

Examples of poor print quality	Recommendation
 <p>Black toner marks across the page</p>	<p>Make sure that you use paper that meets our specifications. (See <i>About paper</i> on page 1-8.)</p> <p>If you use label sheets for laser printers, the glue from the sheets may sometimes stick to the OPC drum surface. Clean the drum unit. (See <i>Cleaning the drum unit</i> on page 6-12.)</p> <p>Do not use paper that has clips or staples because they will scratch the surface of the drum.</p> <p>If the unpacked drum unit is in direct sunlight or room light, the unit may be damaged.</p> <p>The drum unit may be damaged. Put in a new drum unit. (See <i>Replacing the drum unit (DR-350)</i> on page 6-22.)</p>
 <p>White lines across the page</p>	<p>Make sure that you use paper that meets our specifications. A rough surfaced paper or thick print media can cause the problem. (See <i>About paper</i> on page 1-8.)</p> <p>Make sure that you choose the appropriate media type in the printer driver or in the DCP's Paper Type menu setting. (See <i>Basic tab</i> in the Software User's Guide on the CD-ROM and <i>Setting the Paper Type</i> on page 2-1 in this User's Guide.)</p> <p>The problem may disappear by itself. Try printing multiple pages to clear this problem, especially if the DCP has not been used for a long time.</p> <p>The drum unit may be damaged. Put in a new drum unit. (See <i>Replacing the drum unit (DR-350)</i> on page 6-22.)</p>
 <p>Lines across the page</p>	<p>Clean the inside of the DCP and the primary corona wire in the drum unit. (See <i>Cleaning the corona wire</i> on page 6-19.)</p> <p>The drum unit may be damaged. Put in a new drum unit. (See <i>Replacing the drum unit (DR-350)</i> on page 6-22.)</p>
 <p>Black lines down the page Printed pages have toner stains down the page.</p>	<p>Clean the primary corona wire of the drum unit. (See <i>Replacing the drum unit (DR-350)</i> on page 6-22.)</p> <p>Make sure the primary corona wire is at the home position (▲).</p> <p>The drum unit may be damaged. Install a new drum unit. (See <i>Replacing the drum unit (DR-350)</i> on page 6-22.)</p> <p>The toner cartridge may be damaged. Put in a new toner cartridge. (See <i>Replacing the toner cartridge (TN-350)</i> on page 6-19.) Make sure that a torn piece of paper is not inside the DCP covering the laser scanner window.</p> <p>The fixing unit may be smudged. Call Brother Customer Service at 1-800-284-4329 (in USA) or 1-877-BROTHER (in Canada).</p>
 <p>White lines down the page</p>	<p>You may clear the problem by wiping the laser scanner window with a soft cloth. (See <i>Cleaning the laser scanner window</i> on page 6-17.)</p> <p>The toner cartridge may be damaged. Put in a new toner cartridge. (See <i>Replacing the toner cartridge (TN-350)</i> on page 6-19.)</p>
 <p>Page skewed</p>	<p>Make sure the paper or other print media is loaded properly in the paper tray and that the guides are not too tight or too loose against the paper stack.</p> <p>Set the paper guides correctly.</p> <p>If you are using the manual feed slot, see <i>To load paper or other media in the manual feed slot</i> on page 1-11.</p> <p>The paper tray may be too full.</p> <p>Check the paper type and quality. (See <i>About paper</i> on page 1-8.)</p>

Examples of poor print quality	Recommendation
 <p>Curl or wave</p>	<p>Check the paper type and quality. High temperatures and high humidity will cause paper to curl.</p> <p>If you don't use the DCP very often, the paper may have been in the paper tray too long. Turn over the stack of paper in the paper tray. Also, fan the paper stack and then rotate the paper 180° in the paper tray.</p>
 <p>Wrinkles or creases</p>	<p>Make sure that paper is loaded properly.</p> <p>Check the paper type and quality. (See <i>About paper</i> on page 1-8.)</p> <p>Turn over the stack of paper in the tray or rotate the paper 180° in the input tray.</p>

Packing and shipping the DCP

When you transport the DCP, use the packing materials that came with your DCP. If you do not pack the DCP properly, you could void your warranty. The DCP should be adequately insured with the carrier.

- 1 Turn off the DCP's power switch.
- 2 Unplug the DCP from the AC power outlet.
- 3 Unplug the cable from the DCP.
- 4 Open the front cover.
- 5 Remove the drum unit and toner cartridge assembly. Leave the toner cartridge installed in the drum unit.
- 6 Place the drum unit and toner cartridge assembly into the plastic bag and seal the bag.
- 7 Close the front cover.

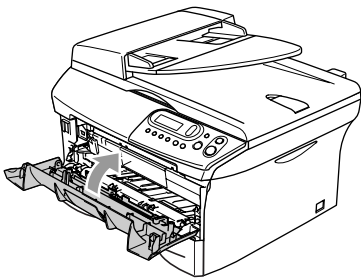

- 8 Wrap the DCP in the plastic bag and place it in the original carton with the original packing material.
- 9 Pack the drum unit and toner cartridge assembly, AC cord and printed materials in the original carton as shown below:

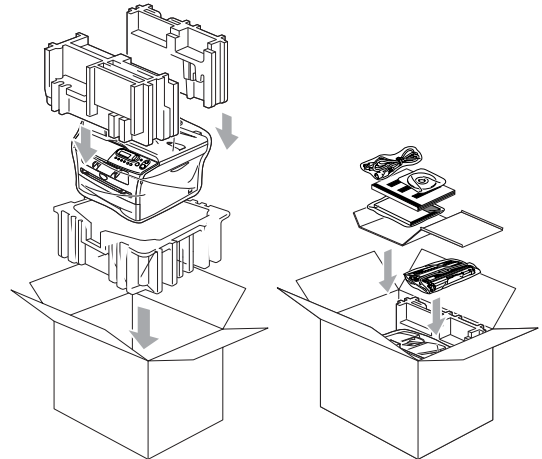

Note

If you are returning your DCP to Brother as part of the Exchange Service, pack only the DCP. Keep all separate parts and printed materials to use with your "Exchange" DCP.

- 10 Close the carton and tape it shut.

Routine maintenance

! CAUTION

The drum unit contains toner, so handle it carefully. If toner scatters and your hands or clothes get dirty, immediately wipe or wash it off with cold water.

Cleaning the outside of the DCP

! CAUTION

- Use neutral detergents. Cleaning with volatile liquids such as thinner or benzene will damage the outside surface of the DCP.
- Do not use cleaning materials that contain ammonia.
- Do not use isopropyl alcohol to remove dirt from the control panel. It may crack the panel.

- 1 Pull the paper tray completely out of the DCP.

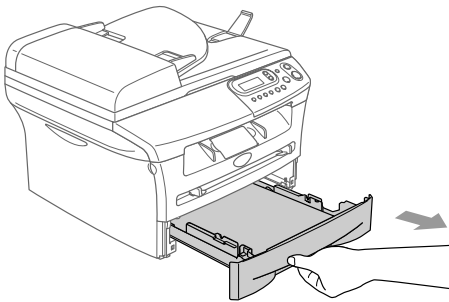

- 2 Wipe the outside of the DCP with a soft cloth to remove dust.

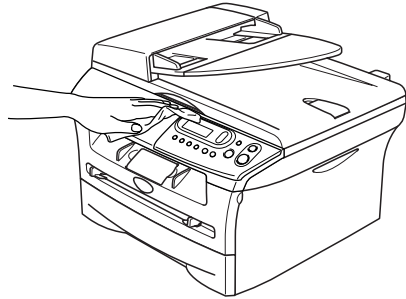

- 3 Remove anything that is stuck inside the paper tray.

- 4 Wipe the inside of the paper tray with a soft cloth to remove dust.

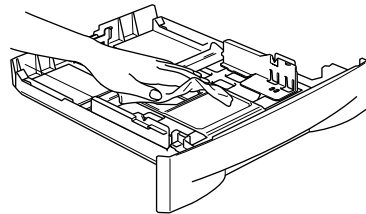

- 5 Re-load the paper and put the paper tray in the DCP.

Cleaning the scanner glass

Turn off the DCP's power switch and lift the document cover. Clean the scanner glass and white plastic with isopropyl alcohol on a soft lint-free cloth.

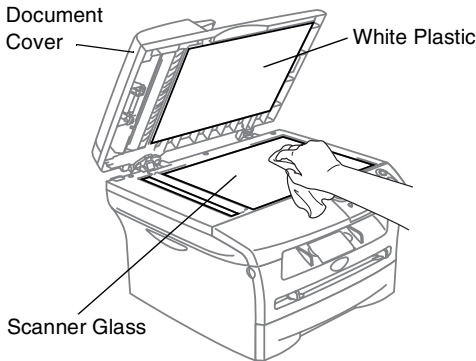

In the ADF unit, clean the white plastic bar and the scanner glass strip under it with isopropyl alcohol on a lint-free cloth.

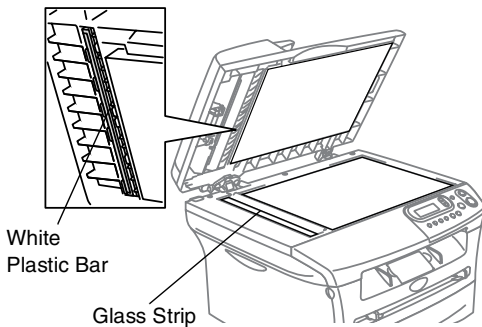

Cleaning the laser scanner window

! CAUTION

- Do *not* use isopropyl alcohol to clean the laser scanner window.
- Do *not* touch the laser scanner window with your fingers.

- 1 Before you clean the inside of the DCP, turn off the DCP's power switch. Unplug the telephone line cord first, and then unplug the power cord from the AC power outlet.
- 2 Open the front cover and pull out the drum unit and toner cartridge assembly.

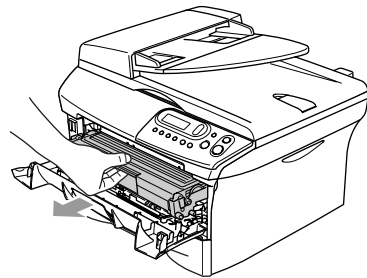

! WARNING

Just after you have used the DCP, some internal parts of the machine are extremely **HOT!** When you open the front cover of the DCP, never touch the shaded parts shown in the diagram below.

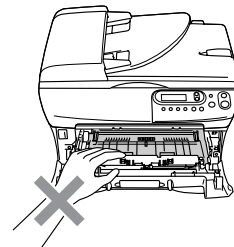

! CAUTION

To prevent damage to the DCP from static electricity, do not touch the electrodes shown below.

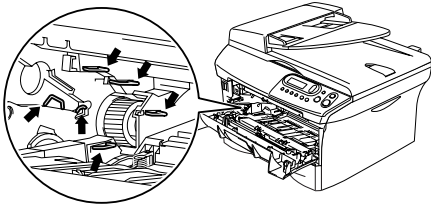

- 3 Gently clean the laser scanner window by wiping it with a clean soft, dry, lint-free cloth. Do not use isopropyl alcohol.

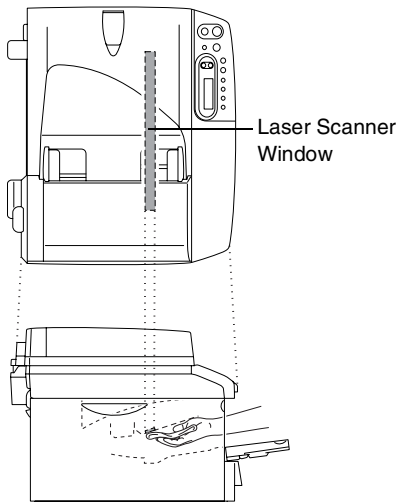

- 4 Put the drum unit and toner cartridge assembly back into the DCP.

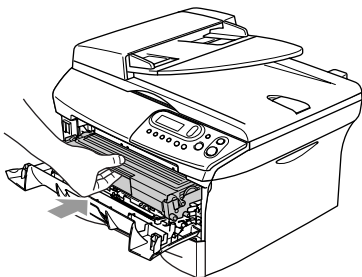

- 5 Close the front cover.

- 6 Plug the DCP's power cord back into the AC power outlet first, and then plug in the telephone line cord.
Turn on the DCP's power switch.

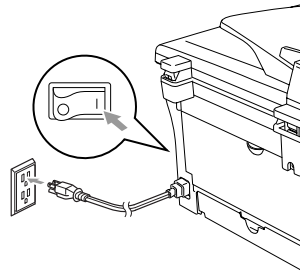

Cleaning the corona wire

We recommend placing the drum unit and toner cartridge assembly on a cloth or large disposable paper to avoid spilling and scattering toner.

- 1 Open the front cover and pull out the drum unit and toner cartridge assembly.

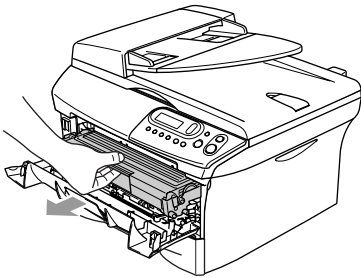

- 2 Clean the primary corona wire inside the drum unit by gently sliding the blue tab from right to left several times.

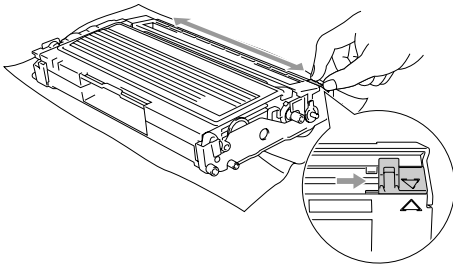

- 3 Return the blue tab and snap it into the Home position (▼).

! CAUTION

If you do not return the blue tab to the Home position (▼), your printed pages may have vertical black stripes on them.

- 4 Reinstall the drum unit and toner cartridge assembly in the DCP.
- 5 Close the front cover.

Replacing the toner cartridge (TN-350)

The toner cartridge can print *up to* 2,500 pages. When the toner cartridge is running low, the LCD shows **Toner Low**. Actual page count will vary depending on your average type of document (i.e., standard letter, detailed graphics).



Note

It is a good idea to keep a new toner cartridge ready for use when you see the **Toner Low** warning.

Discard the used toner cartridge according to local regulations, keeping it separate from domestic waste. Be sure to seal the toner cartridge tightly so toner powder does not spill out of the cartridge. If you have questions, call your local waste disposal office.

We recommend that you clean the DCP and drum unit when you replace the toner cartridge. (See *Cleaning the laser scanner window* on page 6-17 and *Cleaning the corona wire* on page 6-19.)

How to replace the toner cartridge

! WARNING

Just after you use the DCP, some internal parts of the machine will be extremely **HOT!** Never touch the shaded parts shown in the illustration.

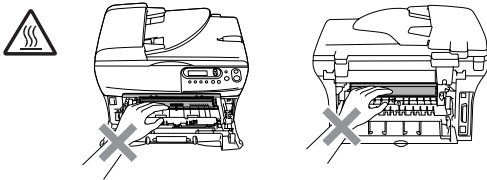

- 1 Open the front cover and pull out the drum unit and toner cartridge assembly.

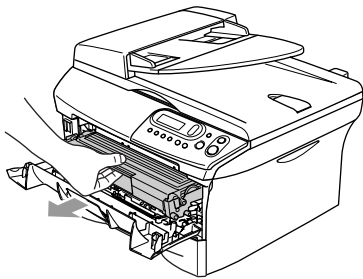

! CAUTION

To prevent damage to the DCP from static electricity, do not touch the electrodes shown below.

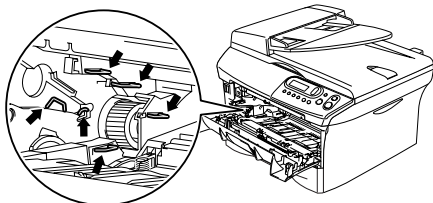

- 2 Hold down the lock lever on the left and pull the toner cartridge out of the drum unit.

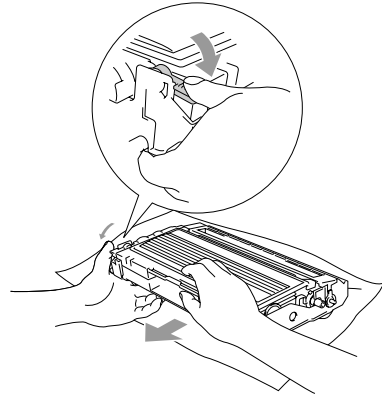

! CAUTION

- Place the drum unit on a drop cloth or large piece of disposable paper to avoid spilling and scattering the toner.
- Handle the toner cartridge carefully. If toner scatters on your hands or clothes, immediately wipe it off or wash it with cold water.

- 3 Unpack the new toner cartridge. Place the used toner cartridge into the aluminum bag and discard it according to local regulations.

! CAUTION

- Brother strongly recommends that you do not refill the toner cartridge provided with your DCP. We also strongly recommend that you continue to use only Genuine Brother Brand replacement toner cartridges (**TN-350**). Using or attempting to use potentially incompatible toner and/or toner cartridges in your DCP may cause damage to the machine itself and/or it may result in unsatisfactory print quality. Our warranty coverage does not apply to any problem that was caused by the use of unauthorized third party toner and toner cartridges. To protect your investment and guarantee your print quality please continue to replace consumed toner cartridges with only Genuine Brother Branded Supplies.
- Wait to unpack the toner cartridge until immediately before you install it in the DCP. If a toner cartridge is left unpacked for a long period of time, the toner life is shortened.

! CAUTION

Do not touch the shaded parts shown in the illustrations to prevent any degradation to the print quality.

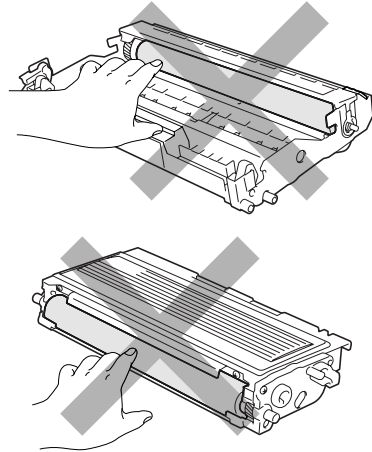

- 4 Gently rock the toner cartridge from side to side five or six times to distribute the toner evenly inside the cartridge.

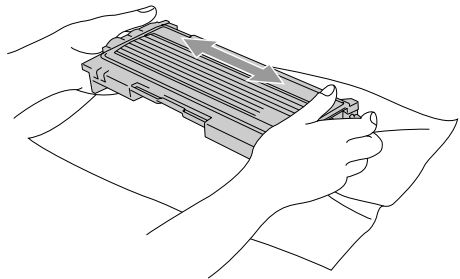

- 5 Remove the protective cover.

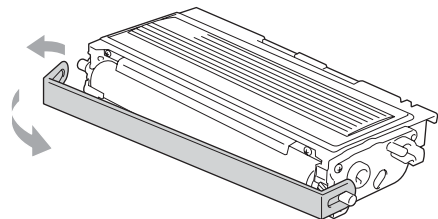

- 6 Insert the new toner cartridge in the drum unit until it clicks into place. If you put it in properly, the lock lever will lift automatically.

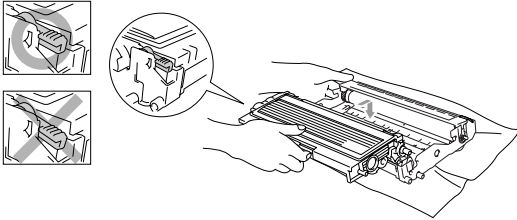

- 7 Clean the primary corona wire inside the drum unit by gently sliding the blue tab from right to left several times. Return the blue tab to the Home position (▼) before reinstalling the drum unit and toner cartridge assembly.

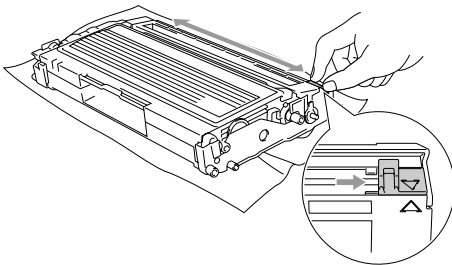

- 8 Install the drum unit and toner cartridge assembly into the DCP.
- 9 Close the front cover.

Replacing the drum unit (DR-350)

The DCP uses a drum unit to create print images on paper. If the LCD shows *Change Drum Soon*, the drum unit is near the end of its life and it is time to buy a new one.

Even if the LCD shows *Change Drum Soon*, you may be able to continue printing without having to replace the drum unit for a while. However, if there is a noticeable deterioration in the output print quality (even before *Change Drum Soon* appears), then the drum unit should be replaced. You should clean the DCP when you replace the drum unit. (See *Cleaning the laser scanner window* on page 6-17.)

! CAUTION

When removing the drum unit, handle it carefully because it contains toner. If toner scatters and your hands or clothes get dirty, immediately wipe or wash it off with cold water.

Note

The drum unit is a consumable item, and it is necessary to replace it periodically. There are many factors that determine the actual drum life, such as temperature, humidity, type of paper and how much toner you use for the number of pages per print job. The estimated drum life is *up to* 12,000 pages. The actual number of pages your drum will print may be significantly less than these estimates. Because we have no control over the many factors that determine the actual drum life, we cannot guarantee a minimum number of pages that will be printed by your drum.

! WARNING

Just after you have used the DCP, some internal parts of the machine are extremely **HOT!** So please be careful.

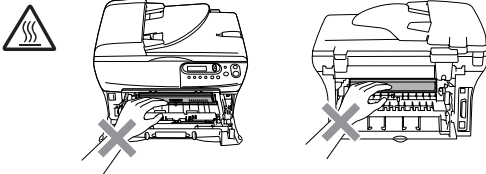

- 1 Open the front cover and pull out the drum unit and toner cartridge assembly.

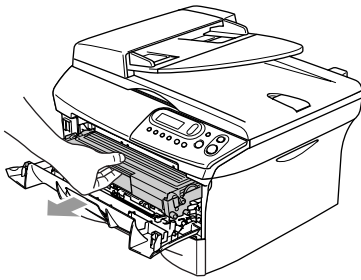

! CAUTION

To prevent damage to the printer from static electricity, do not touch the electrodes shown below.

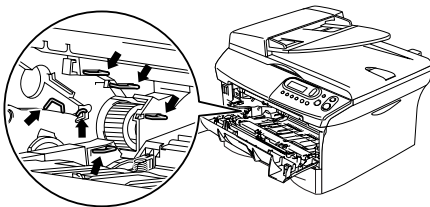

- 2 Hold down the lock lever on the left and pull the toner cartridge out of the drum unit.

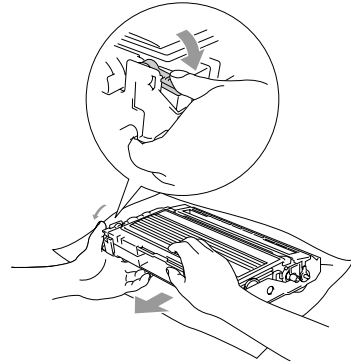

Note

Discard the used drum unit according to local regulations, keeping it separate from domestic waste. Be sure to seal the drum unit tightly so toner powder does not spill out of the unit. If you have questions, call your local waste disposal office.

! CAUTION

Wait to unpack the new drum unit until immediately before installing it. Place the old drum unit into the plastic bag.

- 3 Reinstall the toner cartridge into the new drum unit. If you put it in properly, the lock lever will lift automatically.

- 4 Install the drum unit and toner cartridge assembly in the DCP.

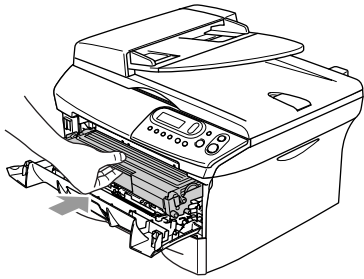

- 5 Press **Options**.

Replace Drum?
▲ Yes ▼ No

To confirm you are installing a new drum, press ▲.

- 6 When the LCD shows *Accepted*, close the front cover.

! CAUTION

If toner scatters and your hands or clothes get dirty, immediately wipe or wash it off with cold water.

Machine Information

Checking the Serial Number

You can view the DCP's serial number on the LCD.

- 1 Press **Menu** and ▲ or ▼ to select 3.Machine Info.

Press **Set**.

- 2 Press ▲ or ▼ to select 1.Serial No.

Machine Info.
1.Serial No.

Press **Set**.

- 3 Press **Stop/Exit**.

Checking the Page Counters

You can view the DCP's page counters for copies, printer pages, lists and a summary total.

- 1 Press **Menu** and ▲ or ▼ to select 3.Machine Info.

Press **Set**.

- 2 Press ▲ or ▼ to select 2.Page Counter.

Machine Info.
2.Page Counter

Press **Set**.

- 3 Press ▲ or ▼ to select Total, List, Print or Copy.

Press **Set**.

```
Page Counter
Total:      XXXXX
```

```
Page Counter
List:      XXXXX
```

```
Page Counter
Print:     XXXXX
```

```
Page Counter
Copy:     XXXXX
```

- 4 Press **Stop/Exit**.

Checking the Drum Life

You can view the DCP's drum life on the LCD.

- 1 Press **Menu** and ▲ or ▼ to select 3.Machine Info.

Press **Set**.

- 2 Press ▲ or ▼ to select 3.Drum Life.

```
Machine Info.
3.Drum Life
```

Press **Set**.

- 3 Press **Stop/Exit**.



Note

The drum life check will be accurate only if you have reset the drum counter when you installed a *new* drum unit. It will not be accurate if you have reset the drum counter during the life of a *used* drum.

A

Appendix

On-screen programming







Your DCP is designed to be easy to use with LCD on-screen programming. User-friendly programming helps you take full advantage of all the menu selections your DCP has to offer.

Since your programming is done on the LCD, we have created step-by-step on-screen instructions to help you program your DCP. All you need to do is follow the instructions as they guide you through the menu selections and programming options.

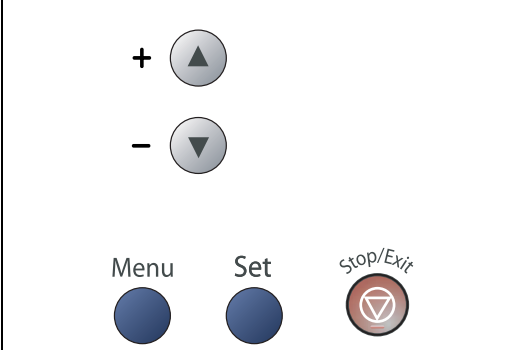

Menu table

The Menu table that begins on page A-3 will help you understand the menu selections and options that are found in the DCP's programs. Once you become familiar with programming, you can use the Menu table as a quick reference when you want to change your settings.

Menu Mode

	
 Menu	Access the menu
+  - 	Scroll through the current menu level
Set 	Accept an option Go to the next menu level
 stop/Exit	Exit the menu

You can access the menu mode by pressing **Menu**.

When you enter the menu, press  or  to scroll through the Main Menu.

Select   & Set
1.General Setup

Select   & Set
2.Copy

⋮

for Machine Information.

Select   & Set
3.Machine Info.

You can scroll more quickly through each menu level by pressing the arrow for the direction you want: ▲ or ▼.

Select an option by pressing **Set** when that option appears on the LCD.

The LCD will then show the next menu level.

Press ▲ or ▼ to scroll to your next menu selection.

Press **Set**.

When you finish setting an option, the LCD shows *Accepted*.

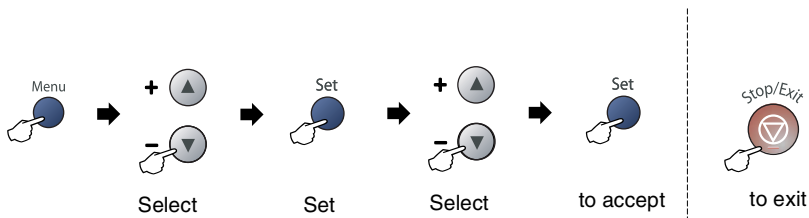

Main Menu	Submenu	Menu Selections	Options	Descriptions	Page	
1. General Setup	1. Paper Type	—	Thin Plain Thick Thicker Transparency Recycled Paper	Sets the type of paper in the paper tray.	2-1	
	2. Paper Size	—	A4 Letter Legal Executive A5 A6 B5 B6	Sets the size of the paper in the paper tray.	2-1	
	3. Beeper	—	High Med Low Off	Adjusts the volume level of the beeper.	2-2	
	4. Ecology	1. Toner Save	—	On Off	Increases the life of the toner cartridge.	2-2
		2. Sleep Time	—	(0-99) 05 Min	Conserves power.	2-3
	5. LCD Contrast	—	Light Dark	Adjusts the contrast of the LCD.	2-3	
	6. User Settings	—	—	—	You can print a list of your settings.	2-3
0. Local Language (Canada only)	—	—	Depending on your country	Allows you to change the LCD Language to English or French.	See Quick Setup Guide	
2. Copy	1. Quality	—	Text Auto Photo	Selects the Copy resolution for your type of document.	3-7	
	2. Contrast	—	▼ -□□□□■+ ▲ ▼ -□□□■□+ ▲ ▼ -□□■□□+ ▲ ▼ -□■□□□+ ▲ ▼ -■□□□□+ ▲	Adjusts the contrast for copies.	3-8	

 **Note**

The factory settings are shown in Bold.

Main Menu	Submenu	Menu Selections	Options	Descriptions	Page
3. Machine Info.	1. Serial No.	—	—	Lets you check the serial number of your DCP.	6-24
	2. Page Counter	—	Total Copy Print List	Lets you check the number of pages the DCP has printed during its life.	6-24
	3. Drum Life	—	—	You can check the percentage of drum life that remains available.	6-25

**Note**

The factory settings are shown in Bold.

Product description

General

Memory Capacity	16 MB
Automatic Document Feeder (ADF)	Up to 35 pages
Paper Tray	250 Sheets (20 lb (80 g/m ²))
Printer Type	Laser
Print Method	Electrophotography by semiconductor laser beam scanning
LCD (Liquid Crystal Display)	16 characters × 2 lines
Power Source	100 - 120V AC 50/60Hz
Power Consumption	Copying: Average 460 W Sleep: Average 10 W Standby: Average 75 W

Dimensions

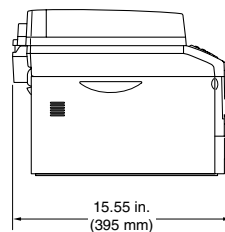
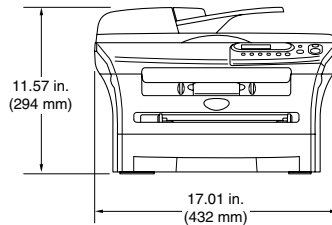

Weight	Without Drum/Toner Unit: 20.81 lb (9.45 kg)
Noise	Operating: 53 dB A or less Standby: 30 dB A or less
Temperature	Operating: 50°F - 90.5°F (10 - 32.5°C) Storage: 32°F - 104°F (0 - 40°C)
Humidity	Operating: 20 to 80% (without condensation) Storage: 10 to 90% (without condensation)

Print media

Paper Input

Paper Tray

- Paper type:
Plain paper, Recycled paper or Transparencies²
- Paper size:
A4, Letter, Legal¹, Executive, A5, A6, B5 and B6
For more details, see *About paper* on page 1-8.
- Paper Weight:
16 - 28 lb (60 -105 g/m²)
- Maximum paper tray capacity:
Up to 250 sheets of 20 lb (80 g/m²) plain paper or
up to 10 transparencies

Manual Feed Slot

- Paper type:
Plain paper, Recycled paper, Transparencies², Envelopes, Bond
paper or Labels²
- Paper size:
Width: 2.75 - 8.5 in. (69.9 - 215.9 mm)
Length: 4.56 - 16 in. (116 - 406.4 mm)
For more details, see *About paper* on page 1-8.
- Paper Weight:
16 - 43 lb (60 -161 g/m²)
- Maximum paper tray capacity: One sheet at a time

Paper Output

Up to 100 sheets of Letter size plain paper (Face down print delivery to the output paper tray)

¹ Legal size paper cannot be stacked on the output paper tray.

² For transparency or label, we recommend removing printed pages from the output paper tray immediately after they exit the DCP to avoid the possibility of smudging.

Copy

Color/Monochrome	Monochrome
Document Size	ADF Width: 5.8 to 8.5 in. (147.3 mm to 215.9 mm) ADF Height: 5.8 to 14 in. (147.3 mm to 356 mm) Scanner Glass Width: Max. 8.5 in. (215.9 mm) Scanner Glass Height: Max. 11.7 in. (297 mm)
Multiple Copies	Stacks or Sorts up to 99 pages
Reduce/Enlarge	25% to 400% (in increments of 1%)
Resolution	600 x 300 dpi

Scanner

Color/Monochrome	Yes
TWAIN Compliant	Yes (Windows® 98/98SE/Me/2000 Professional/XP/ Windows NT® Workstation Version 4.0) Mac OS® 9.1 - 9.2/Mac OS® X 10.2.4 or greater
WIA Compliant	Yes (Windows® XP)
Color Depth	24 bit color
Resolution	Up to 9600 x 9600 dpi (interpolated)* Up to 600 x 2400 dpi (optical) <small>* Maximum 1200 x 1200 dpi scanning with Windows® XP (resolution up to 9600 x 9600 dpi can be selected by using the Brother scanner utility)</small>
Document Size	ADF Width: 5.8 to 8.5 in. (147.3 to 215.9 mm) ADF Height: 5.8 to 14 in. (147.3 to 356 mm) Scanner Glass Width: Max. 8.5 in. (215.9 mm) Scanner Glass Height: Max. 11.7 in. (297 mm)
Scanning Width	8.2 in. (215.9 mm)
Gray Scale	256 levels



Note

Mac OS® X scanning is supported in Mac OS® X 10.2.4 or greater.

Printer

Printer Driver	Windows® 98/98SE/Me/2000 Professional/XP/ Windows NT® Workstation Version 4.0 driver supporting Brother Native Compression mode and bi-directional capability Apple® Macintosh® QuickDraw® Driver For Mac OS® 9.1 - 9.2/Mac OS® X 10.2.4 or greater
Resolution	HQ1200 (Max. 2400 x 600 dots per inch (dpi))
Print Quality	Normal printing mode Economy printing mode (save toner usage)
Print Speed	up to 20 pages/minute (Letter size) <small>* Based on Brother standard pattern. Does not include the time it takes to feed the paper.</small>
First Print	Less than 10 seconds

Interfaces

Interface	Recommended Cable
Parallel	A bi-directional shielded parallel cable that is IEEE 1284 compliant and no longer than 2.0 m.
USB	A USB 2.0 interface cable that is not longer than 6 feet (2.0 m).

(Cables are not included.)



Note

Your DCP has a USB 2.0 full-speed interface. This interface is compatible with USB 2.0 Hi-Speed; however, the maximum data transfer rate will be 12 Mbits/s. The DCP can also be connected to a computer that has a USB 1.1 interface.

Please make sure you use a USB 2.0 interface cable that is no longer than 6 feet (2.0 m).

Computer requirements

Minimum System Requirements						
Computer Platform & Operating System Version		Processor Minimum Speed	Minimum RAM	Recommended RAM	Available Hard Disk Space	
					for Drivers	for Applications
Windows® ¹ Operating System	98, 98SE	Pentium® II or equivalent	32 MB	64 MB	90 MB	130 MB
	Me		64 MB	128 MB		
	NT® Workstation 4.0				128 MB	256 MB
	2000 Professional		XP ²			
Apple® Macintosh® Operating System	Mac OS® 9.1 - 9.2 (Printing and Scanning ³ Only)	All base models meet minimum Requirements		64 MB	64 MB	80 MB
	Mac OS® X 10.2.4 or greater		128 MB	160 MB		

NOTE: All registered trademarks referenced herein are the property of their respective companies.

For the latest drivers, go to the Brother Solutions Center at <http://solutions.brother.com/>

- ¹ Microsoft® Internet Explorer 5 or greater.
- ² Maximum 1200 x 1200 dpi scanning with Windows® XP. (Resolutions up to 9600 x 9600 dpi can be selected using the Brother Utility.)
- ³ Dedicated "Scan" key supported in Mac® Operating Systems Mac OS® X 10.2.4 or greater.

Consumable items

Toner Cartridge Life (TN-350)

Starter Toner Cartridge: Up to 1,500 pages*
 Standard Toner Cartridge: Up to 2,500 pages* +
 * When printing letter or A4 size paper at 5% print coverage
 + Requires additional purchase



Note

Toner life expectancy will vary depending upon the type of average print job.

Drum Unit Life Expectancy (DR-350)

Up to 12,000 pages



Note

There are many factors that determine the actual drum life, such as temperature, humidity, type of paper, toner you use and number of pages per print job.

Optional External Wireless Print/Scan Server (NC-2200w)

NC-2200w External Wireless Print/Scan Server (Optional)

Connecting the optional External Wireless Print/Scan Server (NC-2200w) to the USB port of your DCP will allow you to print and scan over a wireless network.

Network types

IEEE 802.11b wireless LAN

Support for

Windows® 98/98SE/Me/2000/XP
 Mac OS® X 10.2.4 or greater

Protocols

TCP/IP
 ARP, RARP, BOOTP, DHCP, APIPA (Auto IP), WINS/NetBIOS, DNS,
 LPR/LPD, Port9100, SMB Print, IPP, RawPort, mDNS, TELNET,
 SNMP, HTTP



Note

You can assign the **Scan** key to only one networked computer.

Optional External Print Server (NC-2100p)

NC-2100p External Print Server (Optional)	Connecting the optional External Print Server (NC-2100p) to the Parallel port of your DCP will allow you to print over a wired Ethernet network.
Support for Protocols	Windows® 98/98SE/Me/NT 4.0/2000/XP TCP/IP (LPR/LPD), IPP, FTP, HTTP, TELNET, Port 9100, SMTP, POP3, TFTP, SNMP, DHCP, BOOTP, RARP, NetBEUI

A

- Accessories and suppliesii
- ADF (automatic document feeder) 1-6
- ADF cover 6-3
- Apple® Macintosh®
 - See Software User's Guide on the CD-ROM.

B

- Brother
 - accessories and suppliesii
 - Brother numbers i
 - Customer Service i
 - FAQs (frequently asked questions) i
 - fax back systemii
 - product support i
 - warrantiesiii, iv, vi

C

- Cleaning
 - corona wire 6-19
 - drum unit 6-12
 - laser scanner window 6-17
 - scanner glass 6-17
- Consumable items S-6
- Control panel overview 1-5
- ControlCenter2.0
 - See Software User's Guide on the CD-ROM.
- Copy
 - contrast 3-3
 - default settings
 - contrast 3-8
 - quality 3-7
 - Enlarge/Reduce key 3-2
 - multiple copies 3-1
 - Number of Copies key 3-1
 - Options key 3-4
 - Page Layout 3-5, 3-7
 - single copy 3-1
 - sort 3-5
 - temporary settings 3-2

D

- Drum unit
 - cleaning6-12, 6-19
 - replacing6-22

E

- Error messages on LCD6-1
 - No Paper Fed6-2
 - Out of Memory3-8, 6-2
 - Unable to Init.6-2
 - Unable to Print6-2
 - Unable to Scan6-2

G

- Gray scale S-3

J

- Jams
 - document 6-3
 - paper 6-3

M

- Macintosh®
 - See Software User's Guide on the CD-ROM.
- Maintenance, routine 6-16
- Menu table A-1, A-3

P

- Paper 1-8, S-2
 - size 2-1
 - size of document 1-6
 - type 2-1
- PaperPort®
 - See Software User's Guide on the CD-ROM.
- Print
 - difficulties 6-8
 - drivers S-4

from PC	
See Software User's Guide on the CD-ROM.	
paper jams	6-4
printable area	3-1
quality (improving)	6-11
resolution	S-4
specifications	S-4
Programming your DCP	A-1
menu table	A-1, A-3

Q

Quality	
copy	3-5
print	6-11

R

Resolution	
copy	S-3
print	S-4
scan	S-3

S

Safety instructions	vii, 5-3
Scanner glass (using)	1-7
Scanning	
See Software User's Guide on the CD-ROM.	
Shipping the DCP	6-15
Sleep Time	2-3

T

Temporary copy settings	3-2
Toner cartridge	
replacing	6-19, 6-20
Toner Save	2-2
Troubleshooting	6-1
document jam	6-3
error messages on LCD	6-1
if you are having difficulty with	
copy quality	6-8
paper handling	6-10
print quality	6-10
printing	6-8
scanning	6-9
paper jam	6-4

U

User Settings	2-3
---------------------	-----

V

Volume (beeper)	2-2
-----------------------	-----

W

Warranties	
Canada	vi
Notice-Disclaimer	iii
USA	iv
Windows®	
See Software User's Guide on the CD-ROM.	
World Wide Web	i

Brother International Corporation
100 Somerset Corporate Boulevard
P.O. Box 6911
Bridgewater, NJ 08807-0911 USA

Brother International Corporation (Canada) Ltd.
1 rue Hôtel de Ville,
Dollard-des-Ormeaux, QC, Canada H9B 3H6



Visit us on the World Wide Web
<http://www.brother.com>

These machines are made for use in the USA and Canada only. We cannot recommend using them overseas because the power requirements of your Digital Copier/Printer may not be compatible with the power available in foreign countries. **Using USA or Canada models overseas is at your own risk and may void your warranty.**

USA

Free Manuals Download Website

<http://myh66.com>

<http://usermanuals.us>

<http://www.somanuals.com>

<http://www.4manuals.cc>

<http://www.manual-lib.com>

<http://www.404manual.com>

<http://www.luxmanual.com>

<http://aubethermostatmanual.com>

Golf course search by state

<http://golfingnear.com>

Email search by domain

<http://emailbydomain.com>

Auto manuals search

<http://auto.somanuals.com>

TV manuals search

<http://tv.somanuals.com>