



# InstaFAX FAX2100M/2200M

OWNER'S MANUAL

**brother**®



# Your Brother Fax Reference Section

## SECTION II

- **The control panel keys**

A description of the control panel is shown on page II-3-1.

## SECTION III

- **Loading paper**

Paper loading is described on page III-5-1.

- **Connecting your fax to the telephone line.**

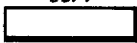

The method for connecting the machine to a telephone line is described on page III-7-1.

- **Making a copy**



Step	Symbol	Operation	Display
1		Set the document face down in the feeder.	FAX : ENTER FAX NO. COPY : PRESS COPY KEY
2		Press COPY.	COPYING P.01

## SECTION IV





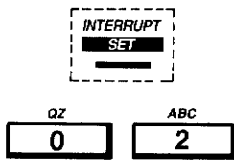

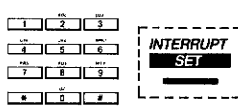
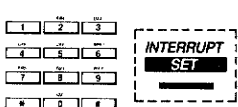
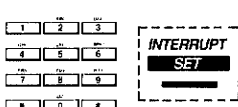
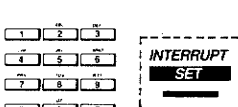
- **Setting the date and time**

Step	Symbol	Operation	Display
1		Make sure there is no document in the feeder.	06/01/1992 00:00 FAX/COPY : SET DOC.
2		Press FUNCTION, then "2".	2.REGISTRATION PRESS SET KEY

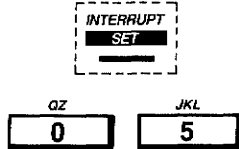



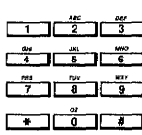

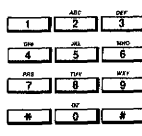
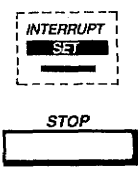

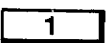

Your Brother Fax Reference Section

Step	Symbol	Operation	Display
3		Press SET, then "0" followed by "2".	<div style="border: 1px solid black; padding: 5px; text-align: center;">                     02.DATE-TIME PRESS SET KEY                 </div>
4		Press SET.	<div style="border: 1px solid black; padding: 5px; text-align: center;">                     YEAR : <u>XX</u> INPUT / PRESS SET TO END                 </div>
5		Enter the last two digits of current year, then SET.	<div style="border: 1px solid black; padding: 5px; text-align: center;">                     MONTH : <u>XX</u> INPUT / PRESS SET TO END                 </div>
6		Enter the current month as a 2-digit number, then SET.	<div style="border: 1px solid black; padding: 5px; text-align: center;">                     DAY : <u>XX</u> INPUT / PRESS SET TO END                 </div>
7		Enter the day as a 2-digit number, then SET.	<div style="border: 1px solid black; padding: 5px; text-align: center;">                     TIME : <u>XX</u>:<u>XX</u> INPUT / PRESS SET TO END                 </div>
8		Enter the time, then SET using 24 Hour System.	

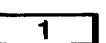
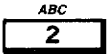
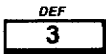

• Registering your name and number

Step	Symbol	Operation	Display
1		Press FUNCTION, then "2".	2.REGISTRATION PRESS SET KEY
2		Press SET, then "0" followed by "5".	05.STATION ID PRESS SET KEY
3		Press SET.	FAX: _ INPUT / PRESS SET TO END
4		Use the number keys to enter your fax number.	FAX: 0528115981_ INPUT / PRESS SET TO END
5		Press SET.	TEL: _ INPUT / PRESS SET TO END
6		Use the number keys to enter your telephone number.	TEL: 0528242554_ INPUT / PRESS SET TO END
7		Press SET.	NAME: _ INPUT / PRESS SET TO END
8		Use the number keys to enter the name you wish to appear on the faxes.	NAME: BROTHER_ INPUT / PRESS SET TO END
9		Press SET. Then press STOP key.	06/01/1992 12:00 FAX/COPY : SET DOC.

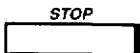

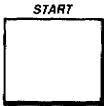

• Registering one-touch numbers

Step	Symbol	Operation	Display
1	 	Press FUNCTION, then 1.	1. ONE-TOUCH / SPEED DIAL PRESS SET KEY
2	 	Press SET, then 1.	1. ONE-TOUCH DIAL PRESS SET KEY
3		Press SET.	ONE-TOUCH DIAL SELECT ONE-TOUCH KEY
4		Select the one-touch number to be registered. (e.g. press 5.)	*05:_ INPUT / PRESS SET TO END
5		Use the number keys to enter the telephone or fax number.	*05:3087831735 INPUT / PRESS SET TO END
6		Press SET.	NAME:_ INPUT / PRESS SET TO END
7		Use the number keys to enter the name of the destination.	*05:BROTHER MIZUHO_ INPUT / PRESS SET TO END
8	  ,  or 	Press SET, then "1", "2" or "3".	CURRENT : FAX 1.FAX 2.TEL 3.OFF
9		Press SET.	ONE-TOUCH DIAL SELECT ONE-TOUCH KEY
10		Press STOP to end registration.	06/01/1992 12:00 FAX/COPY : SET DOC.

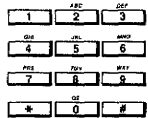

• Sending a one-touch fax (Automatic Transmission – CNG Tone Sent)

Step	Symbol	Operation	Display
1		Set the document face down in the feeder.	FAX : ENTER FAX NO. COPY : PRESS COPY KEY
2		Press the one-touch number key (e.g. 5).	BROTHER MIZUHO PRESS START KEY
3		Press START.	BROTHER MIZUHO SENDING

• Registering speed dial numbers

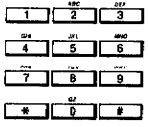
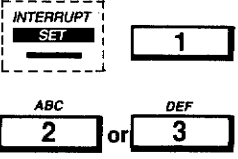

Step	Symbol	Operation	Display
1		Press FUNCTION, then "1".	1.ONE-TOUCH / SPEED DIAL PRESS SET KEY
2		Press SET, then "2".	2.SPEED DIAL PRESS SET KEY
3		Press SET .	SPEED DIAL SELECT NO. #_
4		Enter the two digit speed dial number to be registered (e.g. 10).	SPEED DIAL SELECT NO. #10
5		Use the number keys to enter the telephone or fax number.	#10:3087831735_ INPUT / PRESS SET TO END
6		Press SET.	NAME:_ INPUT / PRESS SET TO END

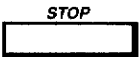
Your Brother Fax Reference Section



Step	Symbol	Operation	Display
7		Use the number keys to enter the name of the destination.	<div style="border: 1px solid black; padding: 5px;"> NAME:U.K. OFFICE_  INPUT / PRESS SET TO END </div>
8		Press SET, then "1", "2" or "3".	<div style="border: 1px solid black; padding: 5px;"> CURRENT : FAX  1.FAX 2.TEL 3.OFF </div>
9		Press SET.	<div style="border: 1px solid black; padding: 5px;"> SPEED DIAL  SELECT NO. #_ </div>
10		Press STOP to end registration.	<div style="border: 1px solid black; padding: 5px;"> 06/01/1992 12:00  FAX/COPY : SET DOC. </div>



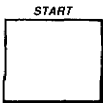

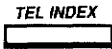

• Sending speed dial faxes (Automatic Transmission – CNG Tone Sent)

Step	Symbol	Operation	Display
1		Set the document face down in the feeder.	FAX : ENTER FAX NO. COPY : PRESS COPY KEY
2		Press the SPD.DIAL key.	# ENTER SPEED NO.
3		Use the number keys to enter the two digit speed dial combination (e.g. 10).	U.K. OFFICE PRESS START KEY
4		Press START.	U.K. OFFICE SENDING

• Sending telephone index faxes (Automatic Transmission – CNG Tone Sent)

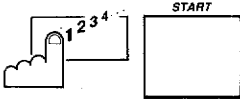

Step	Symbol	Operation	Display
1		Set the document face down in the feeder.	FAX : ENTER FAX NO. COPY : PRESS COPY KEY
2		Press the TEL.INDEX key.	TEL.INDEX ENTER CHARACTER
3		Press the appropriate letter key and (←/→) cursor keys to call up the name you want.	NINJ OFFICE PRESS ←→ OR START KEY
4		Press START.	NJ OFFICE SFNDING

• Sending a fax with a super COVERPAGE

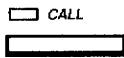
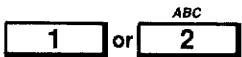

Step	Symbol	Operation	Display
1		Set the document face down in the feeder.	FAX : ENTER FAX NO. COPY : PRESS COPY KEY
2		Press COVERPAGE.	SELECT COMMENT (1-6) 2.PLEASE CALL
3		Press a number key (1-6) to select a comment (e.g. 2).	COVERPAGE 2.PLEASE CALL
4		Select "1" to show the total number of pages, or "2" to off.	TOTAL NO. OF PAGES 1.ON 2.OFF
5		Use the number keys to enter the total number of pages to be sent.	TOTAL PAGES : 12 ENTER TOTAL NO. OF PAGES
6		Enter the fax number. Press START.	308 783 1735 SENDING COVERPAGE

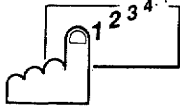
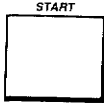
• Sending a fax with call reservation



Step	Symbol	Operation	Display
1		Set the document face down in the feeder.	FAX : ENTER FAX NO. COPY : PRESS COPY KEY
2		Press CALL.	CALL BACK MSG. 1.ON 2.OFF
3		Press "1" or "2".	ENTER FAX NO.

Step	Symbol	Operation	Display
4		Enter the fax number of the destination.	NJ OFFICE PRESS START KEY
5		Press START.	NJ OFFICE SENDING
6		After the transmission, the unit at the other end will ring.	CALLING
7		If the other party answers, your machine will ring. Pick up the handset and talk. If not, Call Back message will be sent.	CALL PICKUP

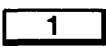
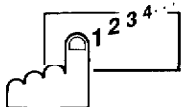
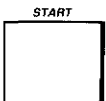
• Standard polling

Step	Symbol	Operation	Display
1		Make sure there is no document in the feeder.	06/01/1992 14:00 FAX/COPY : SET DOC.
2		Press POLLING.	SELECT NO. 1. STANDARD 2. SECURE
3		Press 1.	POLL ENTER FAX NO.
4		Enter the fax number of the machine to be polled.	308 783 1735 PRESS START KEY
5		Press START.	308 783 1735 RECEIVING

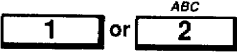
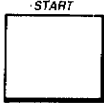

• **Setting a document to be polled**

Step	Symbol	Operation	Display
1		Set the document face down in the feeder.	FAX : ENTER FAX NO. COPY : PRESS COPY KEY
2		Press POLLING.	SELECT NO. 1.STANDARD 2.SECURE
3		Press "1" or "2".	POLL PRESS START KEY -OR- POLL ENTER FAX NO.
4		Press START.	06/01/1992 13:00 WAITING -OR- POLL WAITING

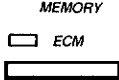
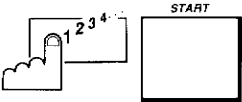

• **Sending a fax from memory**

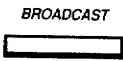
Step	Symbol	Operation	Display
1		Set the document face down in the feeder.	FAX : ENTER FAX NO. COPY : PRESS COPY KEY
2		Press MEMORY/ECM.	ENTER FAX NO. 100%
3		Enter the destination fax number, then press START.	MEMORY 98%







• Sending a broadcast fax

Step	Symbol	Operation	Display
1		Set the document face down in the feeder.	FAX : ENTER FAX NO. COPY : PRESS COPY KEY
2		Press BROADCAST.	BROADCAST ENTER FAX NO. 100%
3		Use a one-touch, speed, or group key to enter the number of the destination machines.	*01#10G03 DUTCH OFFICES
4		Press START.	NJ OFFICE SENDING

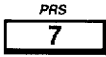

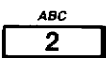
• Printing out confidential information

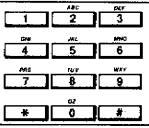

Step	Symbol	Operation	Display
1		Make sure there is no document in the feeder.	06/01/1992 12:35 FAX/COPY : SET DOC.
2		Press MAIL.	CONF. MESSAGE INFO. PRESS START KEY
3		Press START.	CONF. MESSAGE INFO. PRINTING

• **Printing out confidential message**



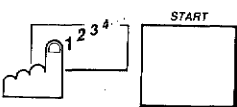
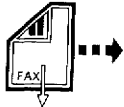

Step	Symbol	Operation	Display
1	 	Press FUNCTION, then "7".	7.CONFIDENTIAL MAIL BOX PRESS SET KEY
2	 	Press SET, then "2".	2.CONF. PRINT OUT PRESS SET KEY
3		Press SET.	RETRIEVAL ID : XXXX ENTER CODE NO.
4		Enter the retrieval ID code.	RETRIEVAL ID : 6349 PRESS SET KEY
5		Press SET.	CONF. MESSAGE PRINTING

• **Interrupting a transmission**

Step	Symbol	Operation	Display
1		Press INTERRUPT.	INTERRUPT TO RESET PRESS INTERRUPT - OR - INTERRUPT REMOVE DOCUMENT
2		Remove the document.	INTERRUPT SET DOCUMENT(S)
3		Set the document, you need to send, face down in the feeder.	INTERRUPT TO RESET PRESS INTERRUPT - OR - INTERRUPT ENTER FAX NO.

Step	Symbol	Operation	Display
4		Enter a fax number, then START.	NJ OFFICE SENDING
5		The document has been sent.	INTERRUPT SET DOCUMENT(S)
6		Replace the original document.	INTERRUPT TO RESET PRESS INTERRUPT OR— INTERRUPT ENTER FAX NO.
7		Press INTERRUPT.	06/01/1992 12:00 FAX/COPY : SET DOC.



• Canceling a transmission

Step	Symbol	Operation	Display
1		Press FUNCTION, then "9".	9.CANCEL TRANSMISSION PRESS SET KEY
2		Press SET.	SELECT NO. 1.HEAD OFFICE 21:00 —OR— SELECT NO. 2.341 1411 REDIAL
3		Select the number of any operation, you wish to cancel.	HEAD OFFICE 21:00 CANCEL ? 1.YES 2.NO
4		Enter "1" or "2".	

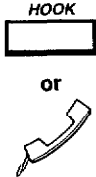
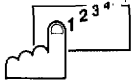
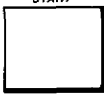
• Sending a fax (manual transmission)

Step	Symbol	Operation	Display
1		Set the document face down in the feeder.	FAX : ENTER FAX NO. COPY : PRESS COPY KEY
2		Press HOOK or pick up the handset.	FAX ENTER FAX NO.
3		Dial the number of the destination.	03875497 ENTER FAX NO.
4		When you hear the fax tone, press the START key. (Hang up after this if you are using the handset.)	03875497 SENDING

• Manual reception of faxes

Step	Symbol	Operation	Display
1		Answer the phone as usual when it rings.	TELEPHONE/FAX
2		Press START after you hear a fax tone. Reception will begin.	RECEIVING
3		Hang up the handset.	RECEIVING



# Contents

---

<b>I. Preliminary information</b> .....	I-1
GLOSSARY .....	I-1
SYMBOLS USED IN THIS MANUAL .....	I-3
IMPORTANT SAFETY INSTRUCTIONS .....	I-4
STANDARD TELEPHONE AND FCC NOTICES .....	I-6
<b>II. Introduction</b> .....	II-1-1
1. INTRODUCTION .....	II-1-1
2. FEATURES .....	II-1-1
3. THE CONTROL PANEL KEYS .....	II-3-1
4. FUNCTIONS .....	II-4-1
<b>III. Setting up</b> .....	III-1-1
1. SELECTING A LOCATION FOR YOUR FAX MACHINE .....	III-1-1
2. UNPACKING THE MACHINE .....	III-2-1
3. ASSEMBLING THE HANDSET .....	III-3-1
4. INSTALLING THE WIRE EXTENSIONS .....	III-4-1
5. LOADING PAPER .....	III-5-1
6. CONNECTING YOUR FAX TO THE POWER OUTLET .....	III-6-1
7. CONNECTING TO A TELEPHONE LINE .....	III-7-1
Jacks .....	III-7-1
Multi Line Connections (PBXs) .....	III-7-1
Connecting to a private branch exchange .....	III-7-2
8. MAKING A TRIAL COPY .....	III-8-1
9. ADDITIONAL SET-UP OPTIONS .....	III-9-1
Connecting to an external telephone .....	III-9-1
<b>IV. Basic use</b> .....	IV-1-1
1. CONFIGURING THE MACHINE .....	IV-1-1
Setting the date and time .....	IV-1-1
Registering your name and number .....	IV-1-2
Entering information using the keys .....	IV-1-4
Selecting tone or pulse dialing .....	IV-1-6
Setting the auto answer switch .....	IV-1-7
FAX/TEL switch .....	IV-1-7
Setting F/T ringing period .....	IV-1-9
Setting the ring delay .....	IV-1-10
Turning auto redial on and off .....	IV-1-10
Turning the beeper on and off .....	IV-1-11
Turning the transmission verification report on and off .....	IV-1-12
Activity report .....	IV-1-13
2. SENDING A FAX .....	IV-2-1
Automatic transmission .....	IV-2-1
Manual transmission .....	IV-2-2
Points to Remember When Sending a Fax .....	IV-2-2

Loading multiple pages for transmitting or copying .....	IV-2-3
Current Setting for sending a fax .....	IV-2-3
Redialing .....	IV-2-5
3. RECEIVING A FAX .....	IV-3-1
Automatic reception .....	IV-3-1
Manual reception .....	IV-3-1
Reception with FAX/TEL switching .....	IV-3-1
Reception by Enhanced Remote Activation .....	IV-3-2
Remote activation .....	IV-3-2
Reception into memory .....	IV-3-2
Registering F/T & Remote ID .....	IV-3-3
4. USING ONE-TOUCH NUMBERS .....	IV-4-1
Registering one-touch numbers .....	IV-4-1
Registering one-touch numbers as a group key .....	IV-4-3
Sending one-touch faxes .....	IV-4-4
Printing a list of one-touch numbers .....	IV-4-4
Changing or Erasing one-touch names and numbers .....	IV-4-6
5. USING SPEED DIAL NUMBERS .....	IV-5-1
Registering speed dial numbers .....	IV-5-1
Sending speed dial faxes .....	IV-5-2
Printing a list of speed dial numbers .....	IV-5-2
Changing or Erasing speed dial names and numbers .....	IV-5-3
6. CHAIN DIALING .....	IV-6-1
Setting chain dialing .....	IV-6-1
7. USING THE TELEPHONE INDEX .....	IV-7-1
Looking up a number .....	IV-7-1
Sending a fax .....	IV-7-1
Printing out the telephone index .....	IV-7-2
8. USING THE UNIT AS A TELEPHONE .....	IV-8-1
Manual dialing .....	IV-8-1
One-touch dialing .....	IV-8-1
Speed dialing .....	IV-8-1
Using the telephone index .....	IV-8-1
Using keys with the telephone .....	IV-8-2
Using an external telephone .....	IV-8-2
Using an external telephone answering device .....	IV-8-2
<b>V. Advanced use .....</b>	<b>V-1-1</b>
1. RESOLUTION .....	V-1-1
Single resolution transmission .....	V-1-1
Multiple resolution transmission .....	V-1-2
The resolution of in-coming documents .....	V-1-3
Copier resolution .....	V-1-3

2. SETTING THE CONTRAST .....	V-2-1
3. SMOOTHING (ENHANCED IMAGE RESOLUTION) .....	V-3-1
4. USING THE SUPER COVERPAGE FACILITY .....	V-4-1
Sending a fax with a super COVERPAGE .....	V-4-1
Printing out a super COVERPAGE .....	V-4-2
Entering a comment .....	V-4-3
5. CALL RESERVATION AND THE CALL BACK MESSAGE .....	V-5-1
Sending a fax with Call Reservation .....	V-5-1
Printing out a Call Back Message .....	V-5-2
6. TIMER TRANSMISSION (DELAYED TRANSMISSION) .....	V-6-1
Sending a fax with Timer .....	V-6-1
Initial timer .....	V-6-3
7. THE PASSWORD .....	V-7-1
Sending a FAX with password .....	V-7-1
Setting the fax receiving password .....	V-7-2
Turning password protection on and off .....	V-7-3
8. POLLING .....	V-8-1
What is polling? .....	V-8-1
Standard polling .....	V-8-2
Secure polling .....	V-8-2
Timer (Delayed) polling .....	V-8-3
Turn-around polling .....	V-8-5
Sequential polling .....	V-8-6
Setting a document to be polled .....	V-8-7
9. SENDING FAXES FROM MEMORY .....	V-9-1
Sending a fax from memory .....	V-9-1
Printing out a "Memory used list" .....	V-9-2
10. SENDING FAXES WITH THE ECM FEATURE .....	V-10-1
11. BROADCASTING .....	V-11-1
Sending a broadcast fax .....	V-11-1
12. RELAY BROADCASTING .....	V-12-1
Sending a relay broadcast request .....	V-12-1
Using your machine as the relay unit .....	V-12-2
Registration of relay ID .....	V-12-2
13. CONFIDENTIAL MAILBOXES .....	V-13-1
Registering a confidential mailbox .....	V-13-1
Changing the mail box ID .....	V-13-3
Printing out confidential information .....	V-13-4
Printing out a confidential message .....	V-13-5
Transmitting to a mail box .....	V-13-6
Retrieving confidential messages .....	V-13-7
14. LOGO REGISTRATION .....	V-14-1
15. VARIOUS TYPES OF TRANSMISSIONS .....	V-15-1

16. INTERRUPTING A TRANSMISSION .....	V-16-1
17. CANCELLING A TRANSMISSION .....	V-17-1
18. OPTIONAL KITS .....	V-18-1
19. PRINTING OUT REPORTS AND LISTS .....	V-19-1
All-dial list .....	V-19-1
Configuration list .....	V-19-2
Power failure report .....	V-19-4
<b>VI. Troubleshooting .....</b>	<b>VI-1</b>
Receiving .....	VI-1
Sending .....	VI-2
Telephone .....	VI-3
Copying .....	VI-3
Others .....	VI-4
Error messages .....	VI-5
<b>VII. Cleaning .....</b>	<b>VII-1</b>
Cleaning the printing area .....	VII-2
Cleaning the scanner .....	VII-3
<b>VIII. Specifications .....</b>	<b>VIII-1</b>

# I. Preliminary information

---

## GLOSSARY

This glossary is a reference to help you understand terms used in this manual which may be unfamiliar.

<b>ADF</b>	Automatic Document Feeder - this allows the insertion of up to 30 originals for transmission or copying.
<b>Broadcasting</b>	This function permits the transmission of a fax to several different stations in a single operation.
<b>Chain dialing</b>	An option which allows you to use two one-touch or speed dial numbers for an automatic transmission. (for example, when you are using telephone credit card.)
<b>Confidential mailbox</b>	This feature is used for sending and receiving documents that should be seen only by those who know the retrieval ID number. The InstaFAX2100M/2200M has three different mailboxes.
<b>Convenience copier</b>	A copier used to make occasional, temporary reproductions of documents.
<b>ECM</b>	The Error Correction Mode, which is a means of checking the integrity of a fax transmission.
<b>F/T ringing time</b>	This is the time (10, 20, or 30 seconds) set for extra ringing of the fax machine's telephone when receiving manual transmissions and/or telephone calls for the purpose of conversations.
<b>Fax password</b>	A security code that permits transmission to the fax units using the same code.
<b>Fax receiving password</b>	This password is used to prevent the reception of unwanted fax transmissions.
<b>Fine resolution</b>	Fax transmission mode used for detailed images. (203 x 196 lines/inch)
<b>Gray scale</b>	Shades of gray (16 levels for InstaFAX2100M, 32/16 levels for InstaFAX2200M ) used to provide faithful reproduction of photographic images.
<b>One-touch dialing</b>	A feature which lets you dial a number by pressing just one key.
<b>PBX</b>	Private Branch Exchange, a computerized telephone switching system (usually found in large organizations) which accepts calls from the outside and transfers them to various extensions inside the organization. It is also used to route calls from the inside to destinations outside the organization.

## GLOSSARY

---

**Photo resolution**

A mode used by the fax machine to transmit highly detailed camera images. (203 x 196 lines/inch).

**Polling**











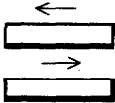
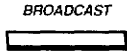

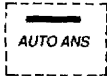



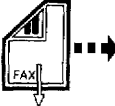

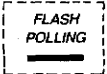
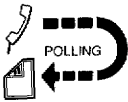

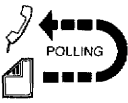

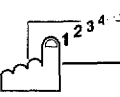
A feature used by fax machines to request documents from other fax machines. The unit has the capacity to poll (send requests for document transmission) and to be polled by (receive requests for document transmission) other machines.

**Timer transmission  
(Delayed transmission )**

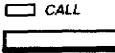
A feature which permits a document to be sent automatically to its destination at a time when the sender is not in the office and/or wants to take advantage of less expensive telephone rates. InstaFAX2100M/2200M has 3-timer transmissions.

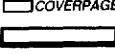
## SYMBOLS USED IN THIS MANUAL

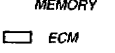
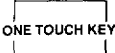
The symbols used in this manual are intended to make it easier for you to see the steps involved in a particular unit operation.

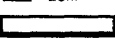
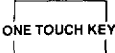
 : Handset up	 : Cursor keys	 : Broadcast key
 : Set the document face down in feeder	 : TEL-INDEX key	 : Manual/Auto answer key
 : Make sure there is no other document in feeder	 : Shift key (only for InstaFAX2200M)	 : Timer key
 : A fax is sent	 : Copy key	 : Flash/Polling key
 : A machine is polling	 : Stop key	 : Chain/Password key
 : A machine is being polled	 : Start key	 : Mail/Clear key
 : Enter fax number	 : Resolution key (FINE/PHOTO/S.FINE) with LED	 : Interrupt/Set key
 : Hook key	 : Call key	 : Function key
 : Hold key	 : COVERPAGE key	 : Number keys
 : Pause/Redial key	 : Memory/ECM key	 : One-touch key
 : Speed dial key	 : Memory/ECM key	 : One-touch key

## IMPORTANT SAFETY INSTRUCTIONS

1. Read all of these instructions.
2. Save them for later reference.
3. Follow all warnings and instructions marked on the product.
4. Unplug this product from the wall outlet before cleaning. Do not use liquid or aerosol cleaners. Use a damp cloth for cleaning.
5. Do not use this product near water.
6. Do not place this product on an unstable cart, stand, or table. The product may fall, causing serious damage to the product.
7. Slots and openings in the cabinet and the back or bottom are provided for ventilation; to ensure reliable operation of the product and to protect it from overheating, these openings must not be blocked or covered. The openings should never be blocked by placing the product on a bed, sofa, rug, or other similar surface. This product should never be placed near or over a radiator or heat register. This product should not be placed in a built-in installation unless proper ventilation is provided.
8. This products should be operated from the type of power source indicated on the marking label. If you are not sure of the type of power available, consult your dealer or local power company.
9. This product is equipped with a 3-wire grounding type plug, a plug having a third (grounding) pin. This plug will only fit into a grounding-type power outlet. This is a safety feature. If you are unable to insert the plug into the outlet, contact your electrician to replace your obsolete outlet. Do not defeat the purpose of the grounding-type plug.
10. Do not allow anything to rest on the power cord. Do not locate this product where persons will walk on the cord.
11. If an extension cord is used with this product, make sure that the total of the ampere ratings on the products plugged into the extension cord do not exceed the extension cord ampere rating. Also, make sure that the total of all products plugged into the wall outlet does not exceed 15 amperes (U.S.A. only).
12. Never push objects of any kind into this product through cabinet slots as they may touch dangerous voltage points or short out parts that could result in a risk of fire or electric shock. Never spill liquid of any kind on the product.
13. Do not attempt to service this product yourself, as opening or removing covers may expose you to dangerous voltage points or other risks. Refer all servicing to service personnel.



14. Unplug this product from the wall outlet and refer servicing to qualified service personnel under the following conditions:
- A. When the power cord or plug is damaged or frayed.
  - B. If liquid has been spilled into the product.
  - C. If the product has been exposed to rain or water.
  - D. If the product does not operate normally when the operating instructions are followed. Adjust only those controls that are covered by the operating instructions since improper adjustment of other controls may result in damage and will often require extensive work by a qualified technician to restore the product to normal operation.
  - E. If the product has been dropped or the cabinet has been damaged.
  - F. If the product exhibits a distinct change in performance, indicating a need for service.

<b>STANDARD TELEPHONE AND FCC NOTICES</b>
---

These notices are in effect on models sold and used in America.

**This equipment is hearing-aid compatible.**

**When programming emergency numbers and/or making test calls to emergency numbers:**

- Remain on the line and briefly explain to the dispatcher the reason for the call before hanging up.
- Perform such activities in the off-peak hours, such as early morning or late evening.

This equipment complies with Part 68 of the FCC Rules. On the rear panel of this equipment is a label that contains, among other information, the FCC Registration Number and Ringer Equivalence Number (REN) for this equipment. You must, upon request, provide this information to your telephone company.

You may safely connect this equipment to the telephone network by means of the standard modular jack, USOC RJ11C.

The REN is useful to determine the quantity of devices you may connect to your telephone line and still have those devices ring when your telephone number is called. In most, but not all areas, the sum of the RENs of all devices connected to one line should not exceed five (5). To be certain of the number of devices you may connect to your line, as determined by the REN, you should contact your local telephone company to determine the maximum REN for your calling area.

If your InstaFAX2100M/2200M causes harm to the telephone network, the telephone company may discontinue your service temporarily. If possible, they will notify you in advance. But if advanced notice is not practical, you will be notified as soon as possible. You will be informed of your right to file a complaint with the FCC.

Your telephone company may make changes in its facilities, equipment, operations or procedures that could affect the proper functioning of your equipment. If they do, you will be notified in advance to give you an opportunity to maintain uninterrupted telephone service.

If you experience trouble with InstaFAX2100M/2200M, please contact the manufacturer's authorized service agency for information on obtaining service or repair. The telephone company may ask that you disconnect this equipment from the network until the problem has been corrected or until you are sure that the equipment is not malfunctioning.

If you are not able to solve a problem with your fax machine, contact your Brother service at 1-800-284-4FAX. (U.S.A. only).

**Warning**

For protection against the risk of electrical shock, always disconnect all cables from the wall outlet before servicing, modifying or installing the equipment.

This equipment may not be used on coin service provided by the telephone company nor connected to party lines.

This equipment has been tested and found to comply with the limits for a Class B digital device, pursuant to Part 15 of the FCC Rules. These limits are designed to provide reasonable protection against harmful interference in a residential installation. This equipment generates, uses, and can radiate radio frequency energy and, if not installed and used in accordance with the instructions, may cause harmful interference to radio communications. However, there is no guarantee that interference will not occur in a particular installation. If this equipment does cause harmful interference to radio or television reception, which can be determined by turning the equipment off and on, the user is encouraged to try to correct the interference by one or more of the following measures:

- Re-orient or relocate the receiving antenna.
- Increase the separation between the equipment and receiver.
- Connect the equipment into an outlet on a circuit different from that to which the receiver is connected.
- Consult the dealer or an experienced radio/TV technician for help.

**Brother cannot accept any financial or other responsibilities that may be the result of your use of this information, including direct, indirect, special or consequential damages. There are no warranties extended or granted by this document.**

The serial number may be found on the label affixed to the back of the unit. For your convenience, note the number below and retain this owner's manual to serve as a permanent record of your purchase, in the event of a theft or fire, or for future reference.

MODEL NO. InstaFAX2100M/2200M SERIAL NO. \_\_\_\_\_

NAME OF DEALER \_\_\_\_\_

DATE OF PURCHASE \_\_\_\_\_



# II. Introduction

---

## 1. INTRODUCTION

This is a modern desktop facsimile unit which can be used for sending and receiving faxes via the public telephone lines. In addition to standard transmission and reception, the unit has a range of functions which facilitate fax transmission and reception and will help keep your business operating efficiently.

This owner's manual has been included with your fax machine to help you make use of the functions provided.

## 2. FEATURES

Your fax machine has many useful features. These include:

- High speed transmission (9600 b.p.s).
- A 48-character LCD screen and helpful prompts. When you have to make a selection, all the available choices are automatically briefly displayed on the screen scrolling.
- Many dedicated function keys.
- Anti curl system, which stretches out the curls of recording roll paper (effective 1 inch/3 cm core).
- Auto Document Feeder (ADF), which allows you leave unattended faxes for transmission. You can set up to 30 documents in the ADF.
- A Tel-Index function, which is a built-in name and number directory list facility.
- The polling function, with which you can request transmission of faxes from other stations. Polling can also be protected by a security code.
- Various reports to confirm that your document has successfully been sent to its destination. (For example, transmission verification reports, etc....)
- A delayed transmission feature which lets you send faxes when telephone rates are low.
- A password security function to prevent "junk" faxes, and to avoid the sending of faxes to the wrong party.
- Four resolution levels (standard/fine/super fine/photo) to provide superior quality document transmission.
- Character smoothing on in-coming fax transmissions.
- A super COVERPAGE feature enabling you to send information describing your fax transmission to the receiving party.
- The facility for interrupting and then resuming an operation.
- Copier capability.
- FAX/TEL switch, which allows you to use one telephone line to both Fax and Telephone.

## II-2. FEATURES

---

- Three confidential mailboxes for storing confidential messages.
- Reception into memory, which allows you to receive fax messages even if your machine runs out of paper.
- A broadcasting function, which lets you send one fax to several different fax units in one operation.
- The P.P.I (Plain Paper Interface) allows you print a transmission on plain paper (optional).
- Logo registration function, with which you can add your own logo to the super COVERPAGE and the Call Back Message.

### – only for InstaFAX2100M –

- Memory capacity for storing up to approximately 15 pages. (Brother standard chart).
- You can increase your machine's memory size up to 768 KB (optional.).

### – only for InstaFAX2200M –

- Memory capacity for storing up to approximately 30 pages. (Brother Standard Chart).
- You can increase your machine's memory size up to 1MB (optional).
- Ultra-high speed transmission (14400 b.p.s)
- Super Gray Scale ..... Allows text to appear on the same document with a photo with no loss of text clarity. Also prevents patterns from forming in the photo image reproduction.

3. THE CONTROL PANEL KEYS



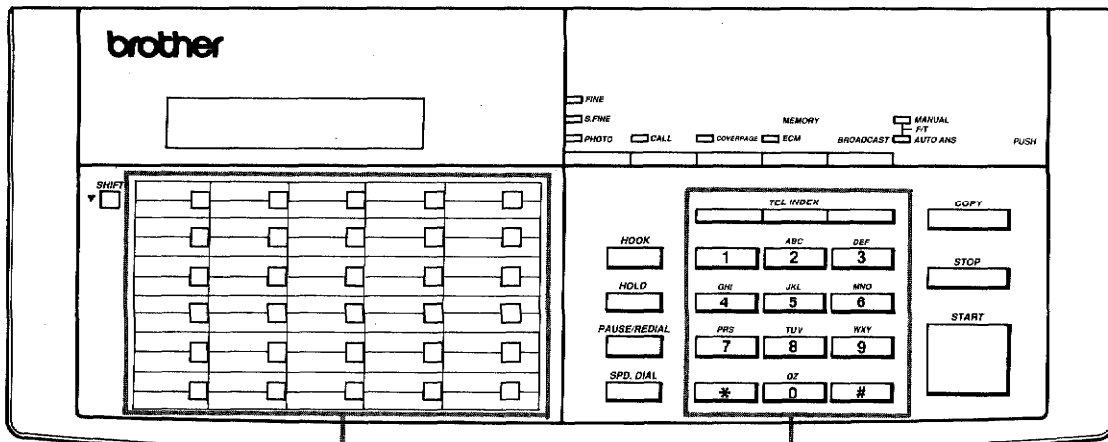
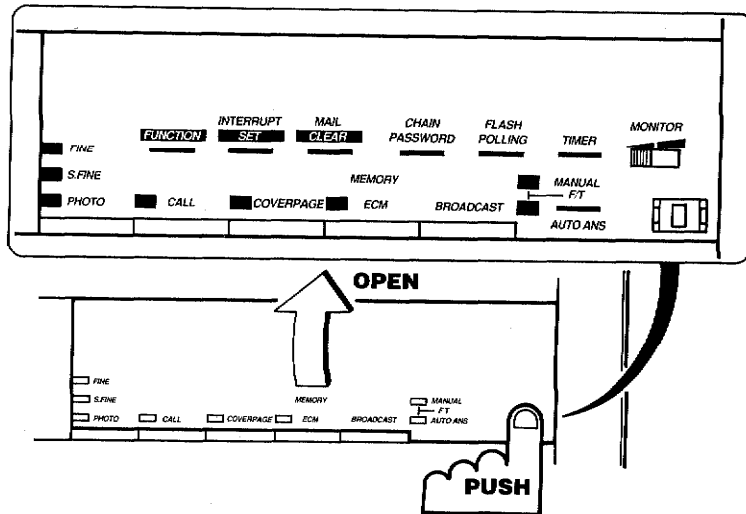







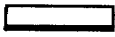

II. Introduction



One-touch keys

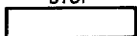









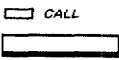
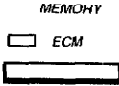

Number keys

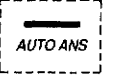
## II-3. THE CONTROL PANEL KEYS

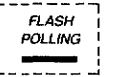
Key	Explanation
<p><b>TEL INDEX</b></p> 	Used when dialing to select a number stored in the unit memory. (This cannot be used for broadcasting or sequential polling.)
<p><b>PAUSE/REDIAL</b></p> 	Used to redial the number dialed most recently. This key is also used to insert a delay during manual dialing or when registering a one-touch or speed dialing number. (Only one pause can be entered in each number to be dialed.)
<p><b>HOLD</b></p> 	Used to put an in-coming call on hold. (Pressing this key a second time will cancel the hold status.)
<p><b>SPD. DIAL</b></p> 	Used to select a previously registered speed dial number by pressing the appropriate two-digit combination. (This key must be pressed prior to entering the two-digit speed dialing combination you wish to contact.)
	Used to enter any FAX/TEL number during manual dialing, and for entering a number when making registrations settings, and when searching through the Telephone Index. These keys are also used to enter names--each key corresponds to 2 or 3 letters of the alphabet. The "1", " * " and "#" keys can be used for entering special characters, punctuation marks, and symbols. (Pressing the "#" key is used to change to "tone" while in "pulse" setting.)
	Used to move the cursor left or right when typing in names and numbers or settings. Also used to scroll forwards or backwards through the Telephone Index. In function menu, used to scroll forwards by pressing (→) cursor key.
	Used to select the resolution level before pressing the START key or the COPY key. (Either S.FINE or PHOTO can be selected when making copies.) When no lights are lit unit is in Standard Mode.
<p><b>COPY</b></p> 	Used to start copying operations.
<p><b>STOP</b></p> 	Used to stop the transmission, to cancel all current settings, and to cancel any function setting operations underway. After this key has been pressed, the LCD returns to the original display. (This key cannot be used to stop reception of documents or phone calls.)
<p><b>START</b></p> 	Used to start a fax transmission and to print out lists and reports.
<p><b>BROADCAST</b></p> 	Used to send a fax transmission to several destinations or to poll several stations. (This key cannot be used for turn-around polling.)
<p><b>COVERPAGE</b></p> 	Used to send a super COVERPAGE with your fax transmission.

Continued on next page



Key	Explanation
	Used to enable the Call Reservation feature.
	Used to read a document into the machine's memory. You can also use this key to select the ECM (Error Correction Mode).
	Used to confirm a function setting, or to interrupt a transmission operation.
	Used to restore existing function settings, and to delete numbers or letters during the registration of one-touch and speed dialing numbers, etc. Pressing this key with the cursor located at the beginning of a one-touch or speed dialing number will clear the number which has been registered. This key is also used to obtain information and data from the confidential mailboxes available.
	Used to enable various functions in the machine.
	Used to select the fax reception mode from among the following options--Auto Answer reception mode, manual reception mode, or the FAX/TEL mode. The LED will light to indicate the current status.
	Used to set a time for a delayed transmission or delayed polling.
	Used to poll (or to be polled by) a remote unit for a document. This key is also used to transfer an in-coming call to another extension.
	Used to send a fax with a password. This key is also used for chain dialing when registering FAX/TEL numbers for one-touch or speed dialing.
	Used to dial phone numbers that you have previously registered.
	Used to access an extra series of fax or phone numbers for any of the one touch keys. (For example, shift key + "00" will dial the number "30".)
	Used to dial telephone or fax number without lifting the handset.
	Used to control speaker monitor volume. (high and low)
	Ring volume control of handset. (High, middle, or low) This control is on the left side of the handset base.

## 4. FUNCTIONS

Pressing the **FUNCTION** key will bring the primary function menu items up on the LCD one at a time. The unit will scroll through all of the first level items automatically. The (→) cursor key can be used to scroll through this list of items quickly.

First level function items are as follows:

1. ONE-TOUCH/SPEED DIAL
2. REGISTRATION
3. ACTIVITY REPORT
4. LISTS AND REPORTS
5. USER OPTIONS
6. CURRENT SETTINGS
7. CONFIDENTIAL MAIL BOX
8. RELAY BROADCAST
9. CANCEL TRANSMISSION

Select the function you want to use by pressing the relevant number key. Your selection will appear on the LCD. After you have confirmed your choice, press the **SET** key.

After the **SET** key has been pressed, secondary items for the function you have selected will appear on the LCD. The procedure for choosing a secondary item is the same as that for selecting a primary function. These menu items and brief explanations are provided below.

### 1. ONE-TOUCH/SPEED DIAL

Number	Menu	Explanation	Ref.
1	ONE-TOUCH DIAL	Registering/Changing/Erasing one-touch dial	IV-4-1
2	SPEED DIAL	Registering/Changing/Erasing speed dial	IV-5-1

## 2. REGISTRATION

Number	Menu	Explanation	Ref.
01	COVERPAGE COMMENT	Registering/Changing/Erasing coveragepage user comment for super COVERPAGE	V-4-3
02	DATE-TIME	Setting/Changing date and time for the unit's clock	IV-1-1
03	INITIAL TIMER	Setting/Changing initial timer	V-6-3
04	F/T & REMOTE ID	Setting/Changing fax/tel and remote activation ID	IV-3-3
05	STATION ID	Setting/Changing machine ID	IV-1-2
06	RECEIVE PASSWORD	Setting/Changing password for the unit	V-7-2
07	RELAY ID	Setting/Changing ID for relay broadcasting	V-12-2
08	CONFIDENTIAL	Registering/Changing confidential mail box (Name, retrieval ID, and conf. ID)	V-13-1
09	GROUPING	Registering/Changing group dialing	IV-4-3
10	ACTIVITY REPORT INTERVAL	Setting Activity report printout interval	IV-1-14
11	NOT USED		
12	LOGO	Registering Logo	V-14-1

- Be sure to use two digits numbers when entering the numbers shown above. (EX. For "01 COVERPAGE COMMENT", press the "0" key followed by the "1" key.)

## 3. ACTIVITY REPORT

## 4. LISTS AND REPORTS

Number	Menu	Explanation	Ref.
1	ALL DIAL	Printing out both one-touch and speed dial list at once	V-19-1
2	ONE-TOUCH DIAL	Printing out one-touch dial list	IV-4-4
3	SPEED DIAL	Printing out speed dial list	IV-5-2
4	TEL-INDEX	Printing out telephone index list	IV-7-2
5	COVERPAGE	Printing out super COVERPAGE format	V-4-2
6	CALL BACK MSG	Printing out Call Back Message format	V-5-2
7	USER OPTIONS	Printing out user options list	V-19-2
8	MEMORY STATUS	Printing out memory status list	V-9-2

## II-4. FUNCTIONS

---

### 5. USER OPTIONS

Number	Menu	Explanation	Ref.
01	RING DELAY	Setting/Changing ring delay shorter (1 ring/longer (4 rings)	IV-1-10
02	TONE/PULSE	Setting/Changing tone or pulse for telephone line	IV-1-6
03	AUTO REDIAL	Setting/Changing auto redial on or off	IV-1-10
04	XMT VERIFICATION REPORT	Setting/Changing transmission verification report on or off	IV-1-12
05	F/T RING TIME	Setting/Changing the period of pseudo-ring back tone	IV-1-9
06	BEEPER	Setting/Changing the beeper on or off	IV-1-11
07	PASSWORD PROTECTION	Setting password protection on or off	V-7-2
08	SMOOTHING	Setting smoothing on or off	V-3-1
09	NOT USED		
10	LOGO	Setting Logo on or off	V-14-1
11	P.P.I OUTPUT	Setting P.P.I. output mode	V-18-1
12	P.P.I. Reduction	Setting P.P.I. reduction mode	V-18-1

- Be sure to use two digits numbers when entering the numbers shown above. (EX. For "01 RING DELAY", press the "0" key followed by the "1" key.)

### 6. CURRENT SETTINGS

Number	Menu	Explanation	Ref.
1	CONTRAST	Setting current contrast to super light or auto mode	V-2-1
2	RESOLUTION	Setting resolution (Standard/Fine/Super fine/Photo) for each pages up to 30 pages	V-1-2

## 7. CONFIDENTIAL MAIL BOX

Number	Menu	Explanation	Ref.
1	CONF. TRANSMIT	Sending confidential mail to another Brother machine	V-13-5
2	CONF. PRINT OUT	Printing out confidential mail from the memory	V-13-4
3	REMOTE RETRIEVAL	Retrieving (polling) confidential mail which is in another Brother machine	V-13-6

## 8. RELAY BROADCAST

Requesting the set up of a relay broadcast with a distant relay terminal. (Ref. V-12-1)

## 9. CANCEL TRANSMISSION

Used to cancel transmission or polling operations which have already been programmed. (Ref. V-17-1)

1  
2  
3  
4  
5  
6  
7  
8  
9  
10  
11  
12  
13  
14  
15  
16  
17  
18  
19  
20  
21  
22  
23  
24  
25  
26  
27  
28  
29  
30  
31  
32  
33  
34  
35  
36  
37  
38  
39  
40  
41  
42  
43  
44  
45  
46  
47  
48  
49  
50  
51  
52  
53  
54  
55  
56  
57  
58  
59  
60  
61  
62  
63  
64  
65  
66  
67  
68  
69  
70  
71  
72  
73  
74  
75  
76  
77  
78  
79  
80  
81  
82  
83  
84  
85  
86  
87  
88  
89  
90  
91  
92  
93  
94  
95  
96  
97  
98  
99  
100

# III. Setting up

---

## 1. SELECTING A LOCATION FOR YOUR FAX MACHINE

The following points should be kept in mind when selecting a place to set up your fax machine.

- Place the fax machine on a flat, stable surface such as a desk or stand.
- Select a place where the machine will not be subjected to bumping or excessive vibration.
- Do not set it up in a high-traffic area.
- Locate the unit near a telephone wall jack and a standard grounded outlet.
- Avoid setting up the machine near heaters, air conditioners, water, chemicals or refrigerators.
- Avoid direct sunlight, excessive heat, moisture, or dust.
- Do not connect the unit to electrical outlets controlled by wall switches or automatic timers. Disruption of power can wipe out information in the unit's memory.
- Do not connect the unit to electrical outlets on the same circuit as large appliances and other equipment that might disturb the power supply.
- Avoid interference sources, such as loudspeakers or the base units of cordless telephones.
- Be sure to disconnect the handset when moving the unit.

## 2. UNPACKING THE MACHINE

Unpack the unit and accessories from the box. Check that you have all the items shown in the illustration below.

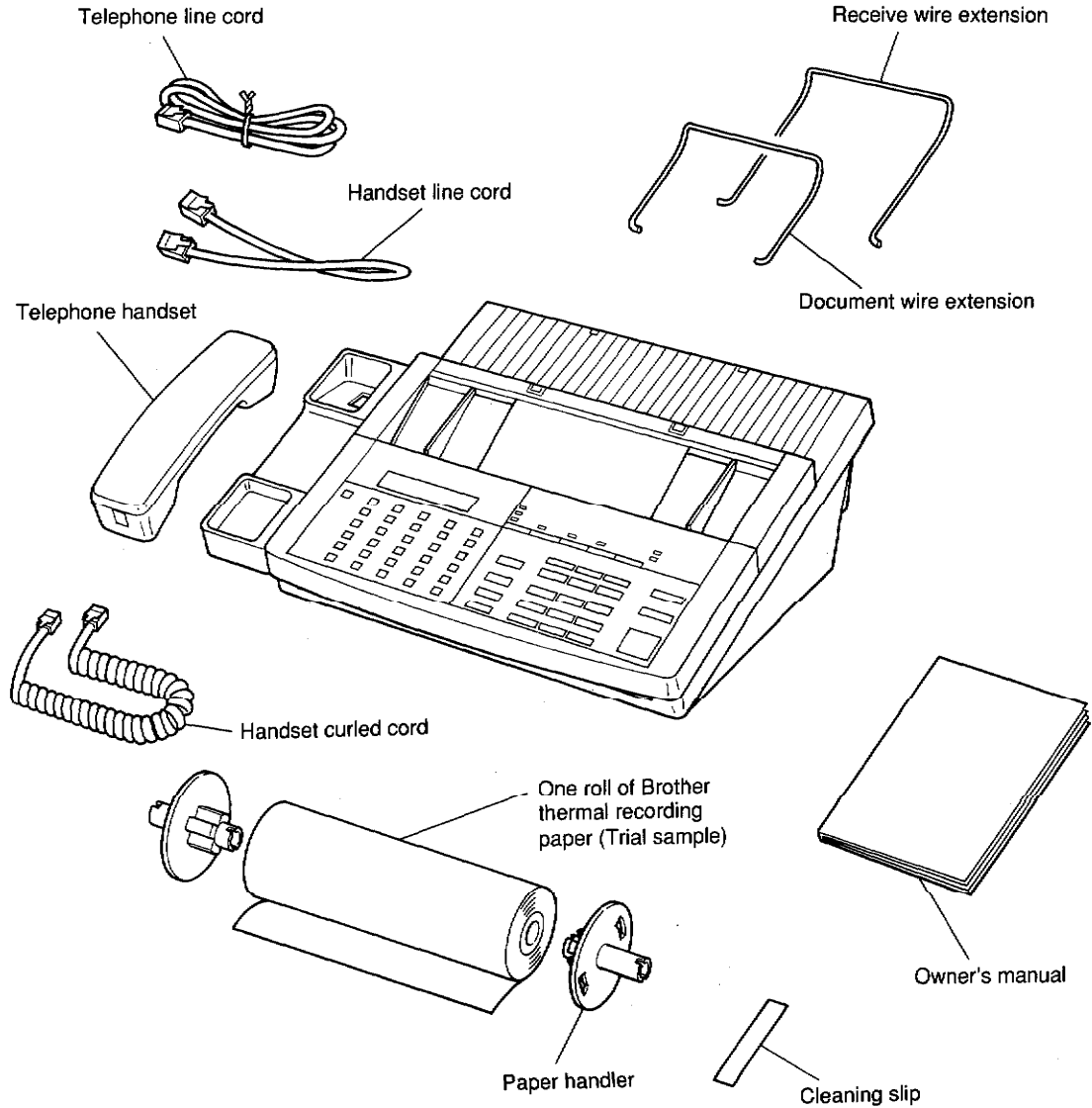



### 3. CONNECTING THE HANDSET

- 1) Insert the handset line cord into the base of the handset as shown. Listen for the click which will indicate that the plug is securely in position.

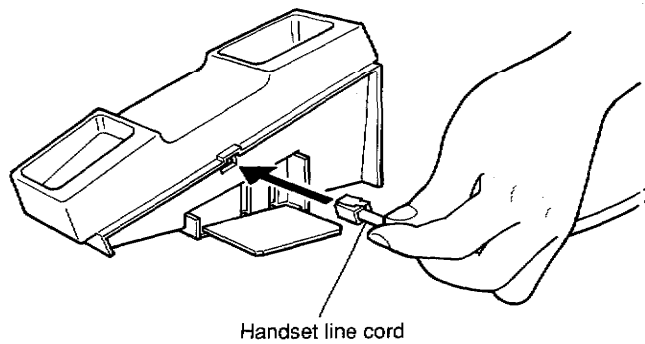

- 2) Draw the handset line cord through the gap provided to prevent the cord from being pinched between the base and the fax unit. Set the fax unit on its side, so the slot for sliding the handset base into position is accessible. Insert the handset into the slot provided. Insert until the handset base is fixed in position.

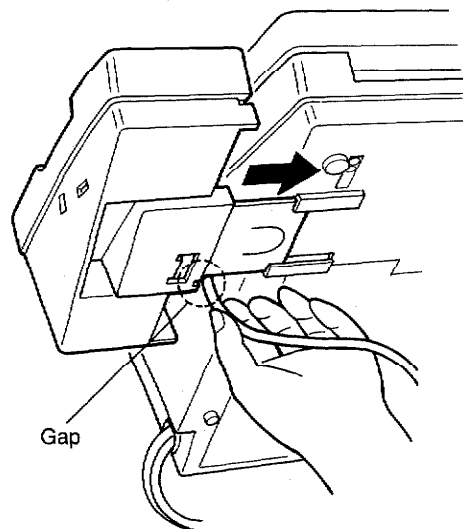

### III-3. ASSEMBLING THE HANDSET

---

- 3) Insert the remaining end of the handset line cord into the "HANDSET BASE" socket located at the rear of the machine. Again, listen for the click when inserting the plug into the socket.

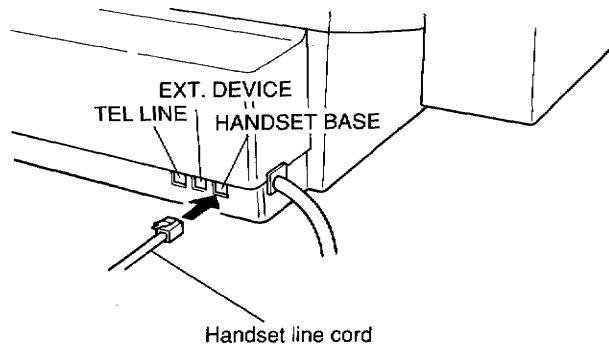

- 4) Insert the curled cord into the base of the handset as illustrated.

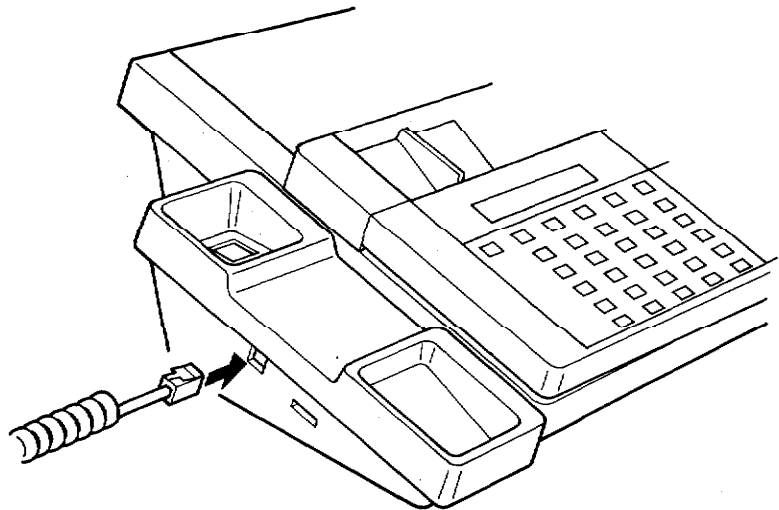

---

### III-3. ASSEMBLING THE HANDSET

- 5) Insert the other end of the curled cord into the handset itself. A click will sound when the plug is in position.

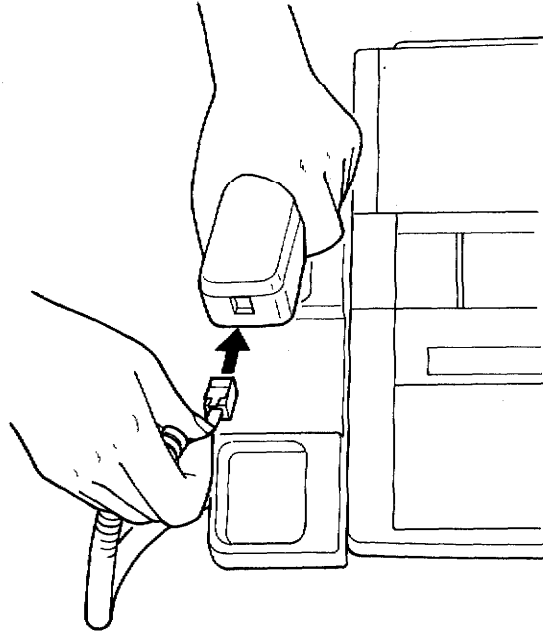

III. Setting up

## 4. INSTALLING THE WIRE EXTENSIONS

- 1) Pinch the ends of the receive wire extension together slightly and insert the prongs into the holes provided at the rear of the machine as shown in the illustration.
- 2) Pull the ends of the document wire extension apart slightly and insert them into the holes provided on the machine as shown in the illustration.

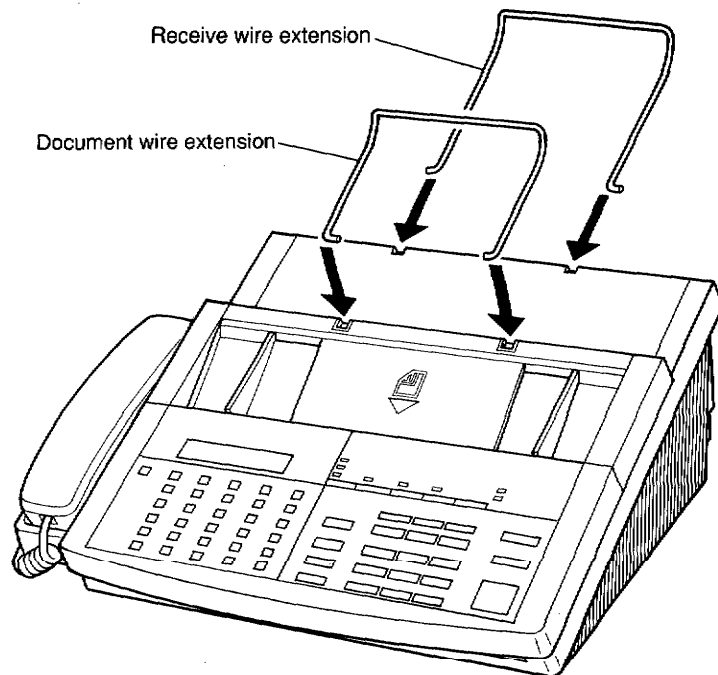

- *Install the wire extensions with the curved parts of the wire extension pointing upward.*

## 5. LOADING PAPER

- 1) Grasp both ends of the tray for inserting original documents and lift up to open the machine as shown in the illustration.

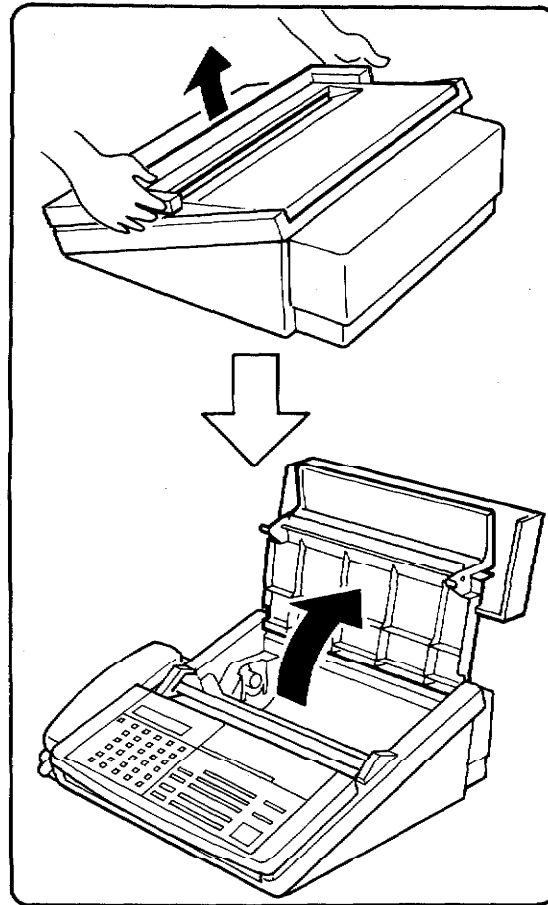

### III-5. LOADING PAPER

---

- 2) Insert the plastic paper handlers into the ends of the tube holding the paper. (When replacing an empty paper roll, be sure not to lose track of these paper handlers, as they are necessary for fitting the roll into place in the machine.)

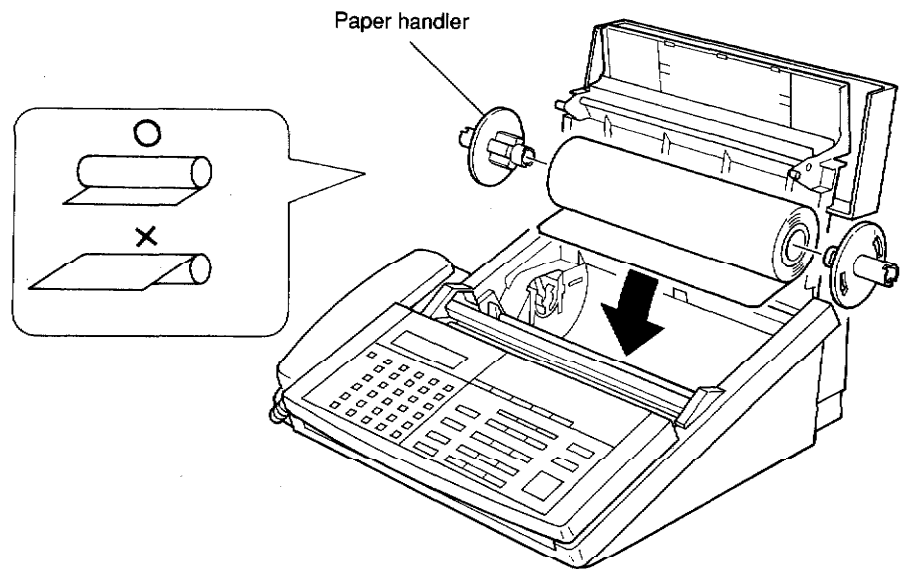

- 3) Load the roll of paper into the machine, inserting the paper handlers so they fit firmly into the sockets provided, as shown in the illustration. Check to be sure the paper is coming off the roll correctly, from the bottom, not from the top of the roll.

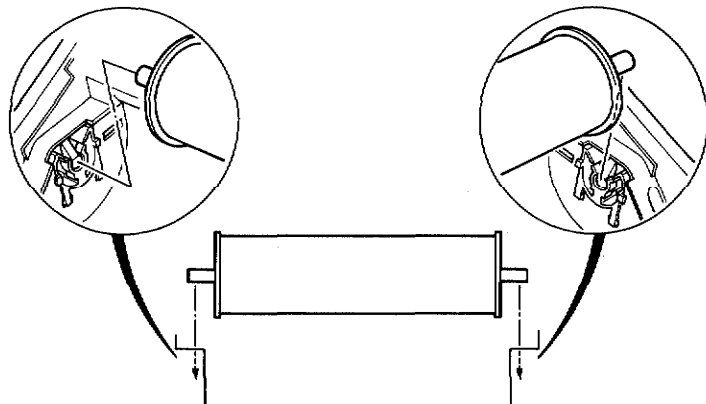

- 4) Pull the paper evenly away from the roll, and insert it between the metal guide and the plastic ribs located below the metal guide. Check the paper as it leads from the roll into the guide to be sure there is not too much tension nor too much slack in the paper.

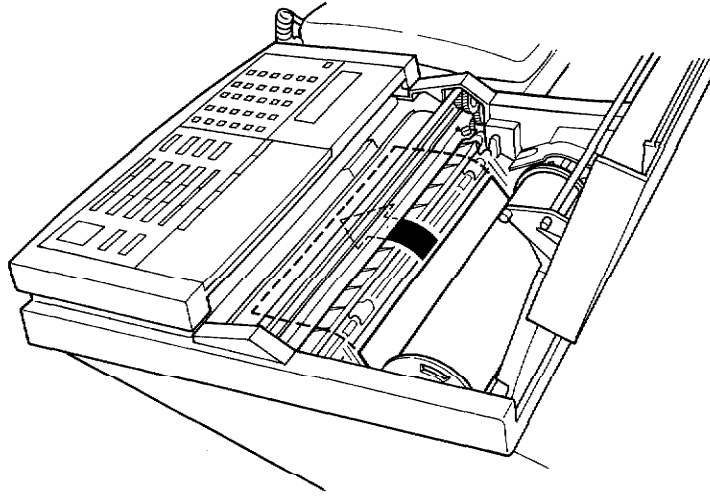

III. Setting up

- 5) Close the cover.

**Note:**

*Be sure not to mistakenly push the release levers for the cover down into the lower position. These release levers must be in the upper position (as shown in the illustration provided) or the machine will not close properly.*

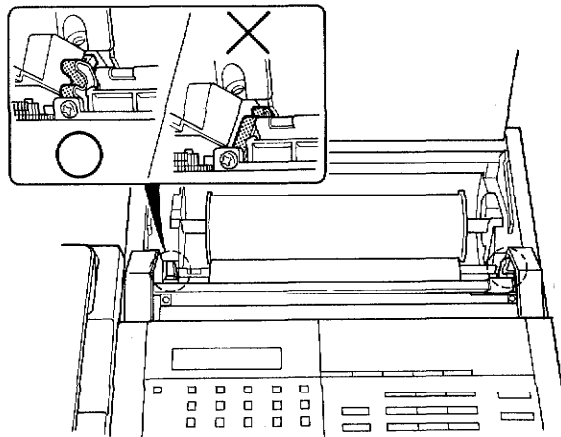

**Note:**

*If you have inserted the plug into the power supply before you have loaded the machine with paper, an alarm will sound and a CHECK RECORDING PAPER message will appear on the screen.*

**Note:**

- *Use 1" core thermal Roll paper.  
(You may experience some difficulty if you try to use paper of less than 1" core.)*



## 6. CONNECTING YOUR FAX TO THE POWER OUTLET

### **Important**

The machine must always be connected to the power outlet before you connect it to a telephone line.

Similarly, when moving the unit, the telephone line connection should be removed before unplugging the power cord. This is because the machine relies on the ground from the plug to protect you from any hazardous electrical conditions occurring on the telephone network.

This machine can be plugged into any standard grounded power outlet. Make sure the socket is grounded and that it is not on the same line as any large appliances or office machines such as refrigerators or photocopiers. The power requirements for this fax machine can be found in the *Specifications* section on page VIII-1-1.

There is no ON/OFF switch. When the machine is plugged in, the date/time display appears on the LCD. You can set the correct time and date on this display by following the instructions on page IV-1-1 in the section *Configuring the machine*.

- *When the machine is plugged in, the recording paper will be fed through the automatically.*

## 7. CONNECTING TO A TELEPHONE LINE

If you plan to use a single telephone line connection follow the instructions below. This is straightforward if your telephone receiver is connected using modular telephone jacks.

- 1) Plug one end of the telephone line cord into the back of the fax machine. Use the TEL LINE socket located farthest to the left.
- 2) Plug the other end of the cord into the telephone wall jack socket. Make sure this end clicks into place.

### Jacks

If you have the older 4-prong telephone wall jack, you must use a modular 4-prong adapter (USOC RJA1X). Plug the adapter into the wall jack and then plug the telephone cord into the adapter, as shown in the illustration below.

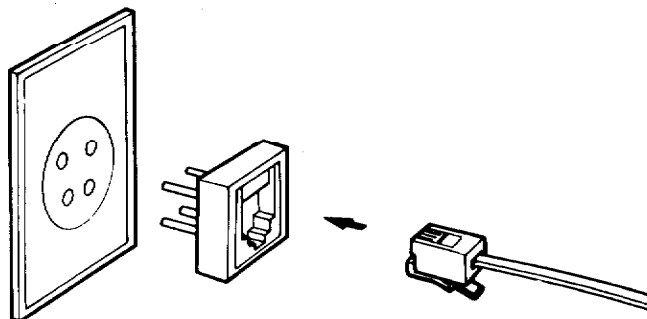

### Multi Line Connections (PBXs)

Most offices use a central telephone system. While it is often relatively simple to connect the machine to a key system or a PBX (private branch exchange), we suggest that you contact the company which installed your telephone system and ask them to connect the fax machine for you.

It is advisable to have a separate line for the fax machine. You can then leave the machine in AUTO ANSWER mode to receive faxes at any time of the day or night.

If the fax machine is to be connected to a multi-line system, ask your installer to connect the unit to the last line on the system. This will prevent the unit from being activated each time a telephone call is received.

- *If you have call waiting, ring master, or any other custom calling feature on your telephone line it may create a problem in the operation of your fax unit.*
- *As with most fax units this machine must be connected to a two wire system. If your line has more than two wires proper connection of the fax machine can not be made.*

**Connecting to a private branch exchange**

The following points should be kept in mind if you are installing the machine to work with a private branch exchange (PBX).

- 1) It is not guaranteed that the unit will operate correctly under all circumstances with approved PBXs. Any cases of difficulty should be reported first to the company that installed your telephone system.
- 2) If all incoming calls will be answered by a switchboard operator, it is recommended that the AUTO ANSWER function be set to be manual. (see page IV-1-7) All incoming calls should initially be regarded as telephone calls.
- 3) The unit may be used with either the pulse or tone dialing telephone types.

## 8. MAKING A TRIAL COPY

Now that your fax machine is ready for use, it is a good idea to test it by making a copy.

You can copy any document up to 8.5 inches/216 mm (A4 size) wide. Follow the instructions below.



- 1) Set the document face down into the feeder. Adjust the guides located on either side of the document if it is less than 8.5 inches wide.
- 2) The following display appears on the LCD screen.

```
FAX : ENTER FAX NO.  
COPY : PRESS COPY KEY
```

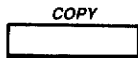

- 3) Press the COPY key. The fax machine draws the original through and prints a copy.

The default setting for making copies is SUPER FINE. To change this setting when copying photographs, press the RESOLUTION key to light "PHOTO" LED, then press the COPY key.

**Note:**

- When the copy has been printed, the automatic paper cutter will cut the page from the paper roll.
- The machine cannot read text or images closer than 1/8" from any edge of the document.
- Do not pull on the paper while copying is in progress. This may ruin the copied image.

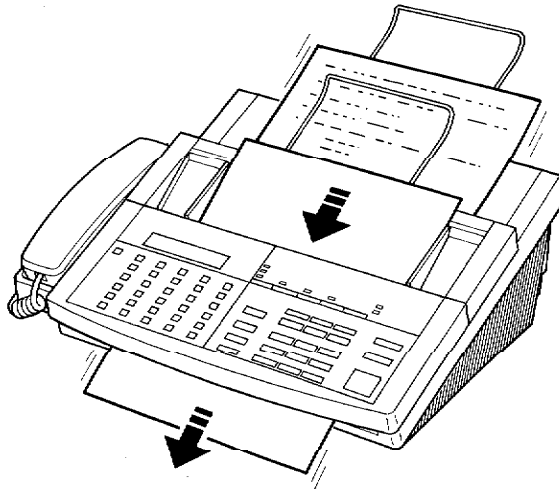

## 9. ADDITIONAL SET-UP OPTIONS

### Connecting to an external telephone

Connect an external telephone to the "EXT. DEVICE" jack as shown.

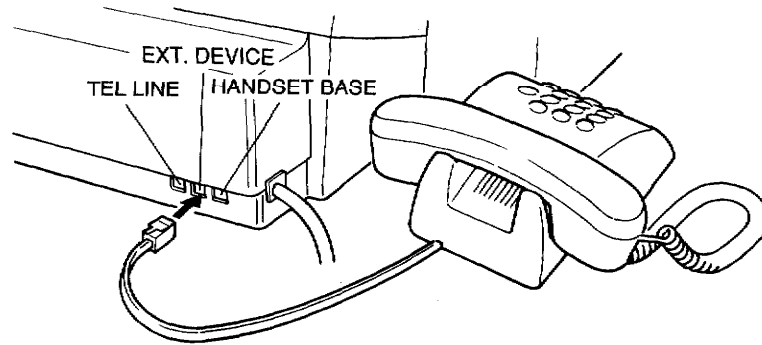

You can remotely activate the machine using your external telephone. This is described in the sub-section "*Reception by Enhanced Remote Activation*" (see page IV-3-2).

You can also connect a TAD to the Ext. Device plug instead of a telephone.



# IV. Basic uses

This chapter describes the most common operations that you will perform with your fax machine, such as sending and receiving faxes, and using the one-touch, speed dial, and Telephone Index dial facilities that allow you to recall and dial regularly used fax numbers.

## 1. CONFIGURING THE MACHINE



When you first plug in the power cord to the outlet the following text should appear on the LCD screen:

(Make sure there is no document in the feeder.)

WARMING UP  
PLEASE WAIT

06/01/1992 00:00  
FAX/COPY : SET DOC.

### Setting the date and time

Carry out the procedure described below to set the correct date and time for the machine.

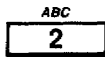

- 1) Press the **FUNCTION** key. Then press the **2** key on the number keys.

2. REGISTRATION  
PRESS SET KEY

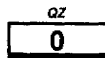

- 2) Press the **SET** key. Then press the **0** key followed by the **2** key.

02. DATE-TIME  
PRESS SET KEY

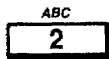

- 3) Press the **SET** key.

YEAR : XX  
INPUT / PRESS SET TO END

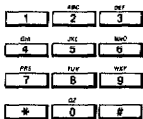

- 4) Enter the last two digits of the current year (for example enter 1992 as "92") using the number keys and then press the **SET** key.

MONTH : XX  
INPUT / PRESS SET TO END



## IV-1. CONFIGURING THE MACHINE

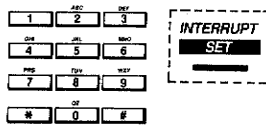

- 5) Enter the current month as a 2-digit number (for example enter July as "07") using the number keys. When you have correctly set the month press the SET key.

DAY : XX  
INPUT / PRESS SET TO END

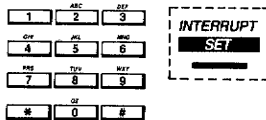

- 6) Enter the day, also as a 2-digit number (for example enter 1<sup>st</sup> as "01") in the same way as you entered the year and month. When you have correctly set the day press the SET key.

TIME : XX:XX  
INPUT / PRESS SET TO END

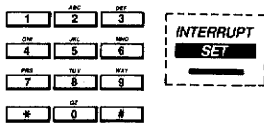

- 7) Now enter the current time in hours and minutes using the number keys. When you have correctly set the time press the SET key. The date and time that you have just set are briefly displayed and then the screen starts scrolling through the registrations' menu.

- *When setting the time*

*Remember that the machine uses the 24 hour clock*

- *If the power is cut off*

*Should the power outlet for the unit be cut off, the date and time setting will be backed up for one hour. After one hour, the date and time setting will be cleared and you will have to register it again.*

### Registering your name and number

To store your name and fax number in the machine so that they will be automatically printed (along with the page number) at the top of each page of every document that you send, proceed as follows:



- 1) Press the FUNCTION key.

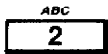

- 2) Then press the 2 key on the number keys.

2. REGISTRATION  
PRESS SET KEY

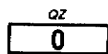

- 3) Press the SET key. Then press the 0 key followed by the 5 key.

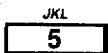

05. STATION ID  
PRESS SET KEY





4) Press the SET key.

FAX: \_  
INPUT / PRESS SET TO END



5) Enter your fax number (which can be up to 20 digits long) using the number keys. The procedure for entering numbers is described in detail in the section *Entering information using the keys* in this chapter.



6) Press the SET key when you have entered the fax number correctly.

If you wish to input a "+" (INTERNATIONAL DIALING CODE PREFIX) at the first position, press the "Chain" key and continue to enter the number, using the correct international dialing code, and omitting any "ZERO" at the beginning of the national area dialing code.

TEL: \_  
INPUT / PRESS SET TO END



7) Now enter your telephone number (which can be up to 20 digits long) using the number keys.



8) Press the SET key when you have entered the telephone number correctly.

NAME: \_  
INPUT / PRESS SET TO END

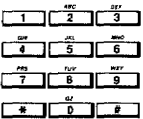

9) Enter the name you wish to appear on the faxes that you send using the number keys. The name can be up to 20 characters long including spaces. The procedure for entering names is described in detail in the section *Entering information using the keys* in this chapter.



10) Press the SET key when you have entered your name.

- The telephone number is only used for the Call Back Message, or super COVERPAGE.
- If you do not enter a fax number you cannot enter anything else.
- You cannot enter a "-" using the PAUSE key when registering your fax and telephone number. Use the (←/→) cursor key instead to enter a space. It will be printed as "-", but not be displayed.

## IV-1. CONFIGURING THE MACHINE

### Entering information using the keys

The way in which you enter numbers and names into the machine's memory is the same in all cases.

#### Entering numbers

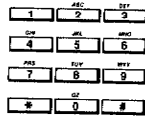

To enter a number into the machine, simply type in the number using the number keys. A horizontal cursor marks the place where the next digit you enter will be. Every time that you enter a digit, the cursor is moved one place to the right. You can also move the cursor left or right using the (←/→) cursor keys.

Press the CLEAR key to delete the number indicated by the cursor position, and all numbers to the right of the cursor.

To modify an existing digit, use the (←/→) cursor keys to move the cursor to the position you want to modify, and input a new digit over the old one.

- You cannot insert a space into a number that has been input. You must re-enter it with the space included.
- If you do not press any key for one minute, or if you press the STOP key, any changes you have made are disregarded and the original number is retained.

#### Entering names

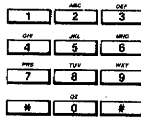

To enter names, use the keys on the number keys and (←/→) cursor keys.

Either two or three letters are assigned to each key on the number keys. Also, although they are not marked, some special characters, punctuation marks and symbols are assigned to the keys "1" key, "\*" key, and "#" key.

"1"key ..... Ä Ë Ö Ü Æ Ø Å Ñ 1  
 "2"key ..... A B C 2  
 "3"key ..... D E F 3  
 "4"key ..... G H I 4  
 "5"key ..... J K L 5  
 "6"key ..... M N O 6  
 "7"key ..... P R S 7  
 "8"key ..... T U V 8  
 "9"key ..... W X Y 9  
 "0"key ..... Q Z 0  
 "\*" ..... (space)! " # \$ % & ' ( ) \* + , - . /  
 "#"key ..... : ; < = > ? @ [ ] ^ \_

To enter any character press the appropriate key until the character appears.

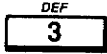

- 1) For example, to enter the name "Fred!", press the 3 key three times.

```
NAME: E
INPUT / PRESS SET TO END
```

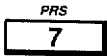

- 2) Press the 7 key twice.

```
NAME: FR
INPUT / PRESS SET TO END
```

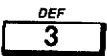

- 3) Press the 3 key twice.

```
NAME: FRE
INPUT / PRESS SET TO END
```

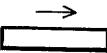

- 4) Press the (→) cursor key once to move the cursor to right.

*- To enter successive characters which are assigned to the same key, you must use the cursor key to move the cursor to the right.*

```
NAME: FRE_
INPUT / PRESS SET TO END
```

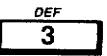

- 5) Press the 3 key once.

```
NAME: FRED
INPUT / PRESS SET TO END
```

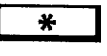

- 6) Press the \* key twice.

*- When you press the 1 key, \* key, or # key, the lower line of the screen shows the characters assigned to that key. Press the key n times to use the n<sup>th</sup> character in the row.*

```
NAME: FRED!
MARK- _!"#$%&'()*+,-./
```



- 7) Press the SET key.

## IV-1. CONFIGURING THE MACHINE

---

### Note:

- You can only overwrite characters. Insertions cannot be made.
- You can overwrite with a space by pressing the \* key once.
- If you want to change a character, use the (←/→) cursor keys to move the cursor underneath the character and enter a new character.
- Press the CLEAR key to delete the character indicated by the cursor position, and all characters to the right of the cursor.

### Selecting tone or pulse dialing

There are two different dial types, and you must select the type of signal suitable for your telephone line.

The default setting is "Tone".



- 1) Press the FUNCTION key. Then press the 5 key on the number keys.

5.USER OPTIONS  
PRESS SET KEY



- 2) Press the SET key. Then press the 0 key followed by the 2 key.

02.TONE-PULSE  
PRESS SET KEY

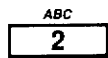

- 3) Press the SET key.

CURRENT : TONE  
1. TONE 2. PULSE

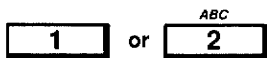

- 4) Press the 1 key for tone dialing, the 2 key for pulse dialing.

TONE-PULSE : PULSE  
PRESS SET KEY



- 5) Press the SET key to confirm your selection.

**Setting the auto answer switch**

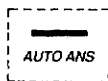

You can select answering mode for fax reception – your choice are automatically, manually, or FAX/TEL auto switching.

You can set the unit to answer in-coming calls automatically by turning on the auto answer feature. To do this, press the **AUTO ANS.** key to light the **AUTO ANS** LED.



If you want all calls to be answered manually, press the **AUTO ANS** key to light the **MANUAL** LED.



If you want to select FAX/TEL, Auto changing switch, press the **AUTO ANS.** key, and light both the **AUTO ANS.** and **MANUAL** LEDs.

*The initial setting is "Auto Ans."*

**FAX/TEL switch**

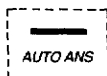

The unit is equipped with a switching feature that can distinguish between telephone calls and fax transmissions. Improving communications when the machine is used on a single telephone line. To activate this function on your machine, press the **AUTO ANS** key until both LEDs are lit the **AUTO ANS** and **MANUAL** LEDs.

If the other party is sending an automatic transmission, the unit detects the CNG tone and enters fax reception mode automatically.

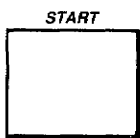

If the other party is sending a manual transmission or telephone call the unit rings for a specified period (10 or 20 or 30 seconds which you can select as the F/T ringing time). Within the F/T ringing time, if you pick up the handset, you can talk with the other party. When the other party wants to send a manual transmission, press the **START** key and you will receive the document. If you cannot pick up the handset within the F/T ringing time, the unit will enter FAX reception mode automatically. So you can receive a document by manual transmission even if you are away from the machine.

Also, if you have given your F/T & Remote ID number to the other party they can always send a manual transmission and put your machine into FAX reception mode by entering the ID number (only using a tone dial unit). (see F/T & remote ID)

## IV-1. CONFIGURING THE MACHINE

The following flow chart illustrates the situations which may arise in the operation of the FAX/TEL switch on the unit.

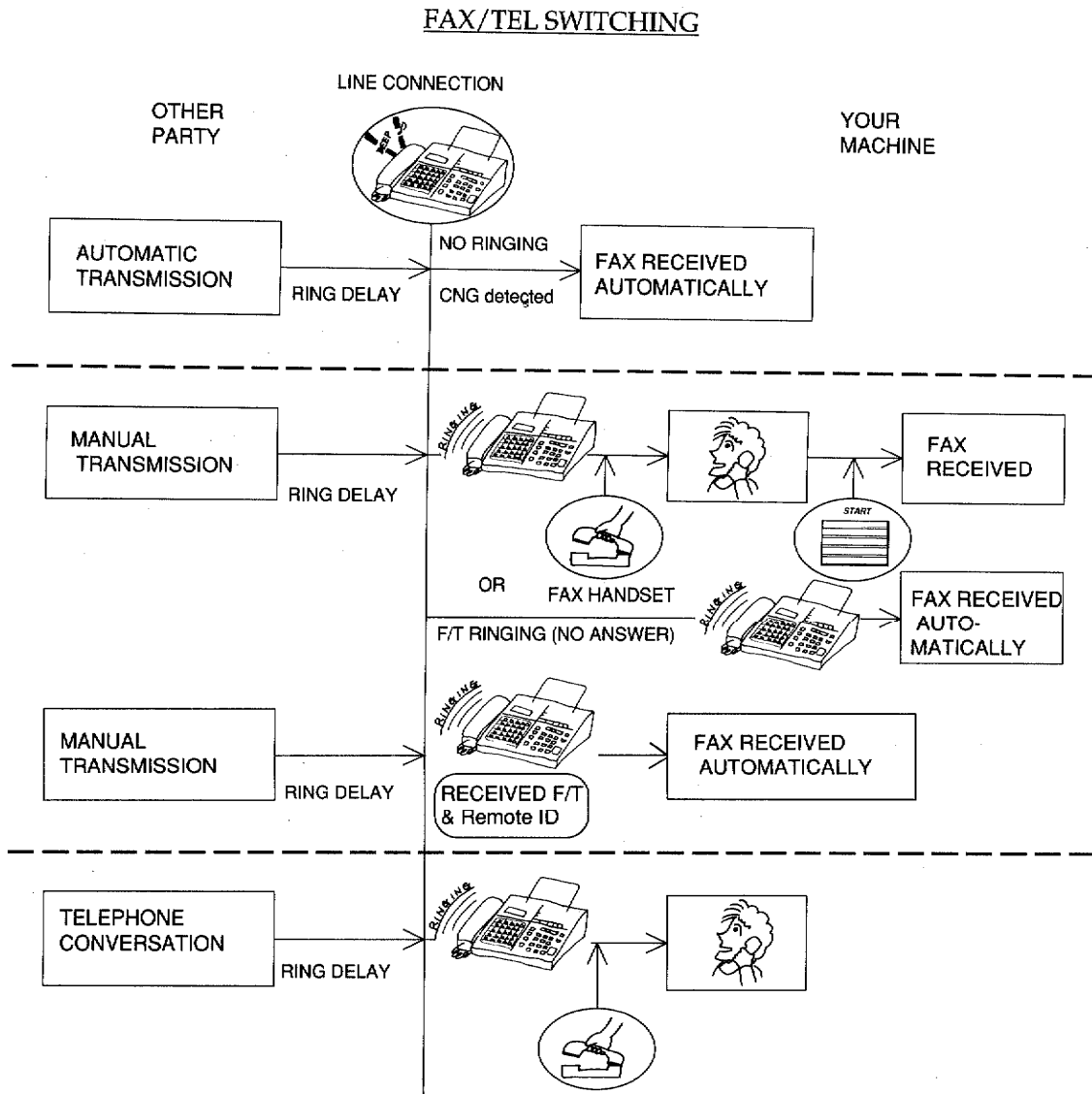

**RING DELAY :** This refers to the number of rings before the phone line is connected in response to a telephone call or fax transmission. You have the option of setting this to either 1 or 4 rings.

**F/T RINGING :** After the line is connected, the machine begins to ring a second time, for a selectable period of 10, 20 or 30 seconds. This additional ringing period provides you with extra time to pick up the telephone for a phone conversation or to receive the manual transmission of a fax. During this period, the other party can hear "pseudo-ring" back tone.

- The cost of the transmission (borne by the sending party) will be calculated from the point in time at which the beep signals that the line connection has been made.
- After beep signal, there is no sound for about 4 seconds to detect a CNG which is sent by other party, until the line is disconnected.

**Setting the F/T ringing period**

You can select the F/T Ringing period by following the procedure below.

- The initial setting is 30 seconds.

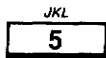

- 1) Press the FUNCTION key. Then press the 5 key.

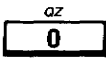
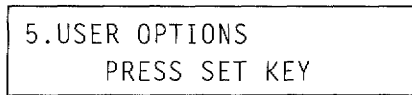

- 2) Press the SET key. Then press the 0 key followed by the 5 key.

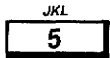
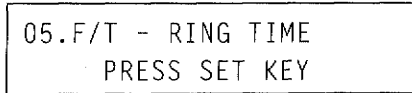

- 3) Press the SET key.

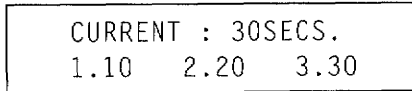

- 4) Press the 1 key to select 10 seconds, the 2 key for 20 seconds, or the 3 key for 30 seconds.

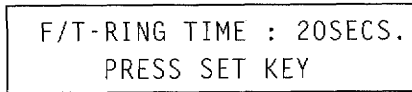
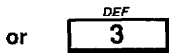

- 5) Press the SET key to confirm your selection.

IV. Basic uses

## IV-1. CONFIGURING THE MACHINE

### Setting the ring delay

You can select the number of times the telephone will ring before the machine will switch to reception mode.:

- *The initial setting is Longer.*

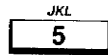

- 1) Press the FUNCTION key. Then, press the 5 key on the number keys.

5.USER OPTIONS  
PRESS SET KEY

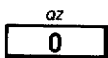

- 2) Press the SET key. Then, press the 0 key followed by the 1 key.

01.RING DELAY  
PRESS SET KEY

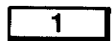

- 3) Press the SET key.

CURRENT : LONGER  
1.SHORTER 2.LONGER

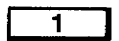

or

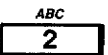

- 4) Press the 1 key for a shorter ring delay (1 ring), the 2 key for a longer ring delay (4 rings).

RING DELAY : SHORTER  
PRESS SET KEY



- 5) Press the SET key to confirm your selection.

### Turning auto redial on and off

If you are sending a fax automatically (see *Sending a fax* in this chapter) you can set up the machine to redial the number automatically if the destination number is engaged. The unit will redial the last used number up to 3 times at 5-minute intervals.

- *The initial setting is "ON".*

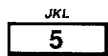

- 1) Press the FUNCTION key. Then press the 5 key on the number keys.

5.USER OPTIONS  
PRESS SET KEY



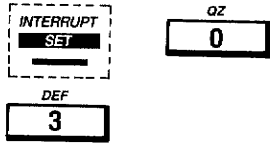

2) Press the SET key then the 0 key followed by the 3 key.

03.AUTO REDIAL  
PRESS SET KEY



3) Press the SET key.

CURRENT : ON  
1.ON 2.OFF

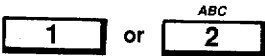

4) Press the 1 key to turn auto-redialing on, the 2 key to turn auto-redialing off.

AUTO REDIAL : OFF  
PRESS SET KEY



5) Press the SET key to confirm your selection.

**Note:**

- Even if auto-redial is "ON", it cannot be used to send an automatic transmission when the interrupt function has been used.
- Auto redial cannot be used for manual transmission.

**Turning the beeper on and off**

The unit has a beeper which sounds to indicate operating errors and when keys have been pressed. You may decide that you would rather operate the machine without this facility. To turn the beeper on or off proceed as follows.

- The initial setting is "ON".



1) Press the FUNCTION key. Then, press the 5 key on the number keys.

5.USER OPTIONS  
PRESS SET KEY

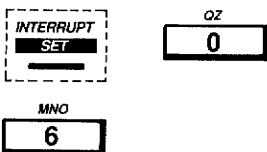

2) Press the SET key. Then press the 0 key followed by the 6 key.

06.BEEPER  
PRESS SET KEY

## IV-1. CONFIGURING THE MACHINE



3) Press the SET key.

CURRENT: ON  
1.ON 2.OFF

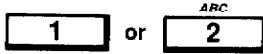

4) Press the 1 key to turn the beeper on, the 2 key to turn the beeper off.

BEEPER : OFF  
PRESS SET KEY



5) Press the SET key to confirm your selection.

### Turning the transmission verification report on and off

You can establish the success or failure of a fax transmission by printing out the transmission verification report. This report is automatically printed for each transmission if you turn the transmission verification feature on. If you do not want this report generated you can disable the function.

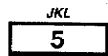

1) To turn this function on or off, press the FUNCTION key followed by the 5 key. Press SET key. Then press the 0 key followed by the 4 key.



04.XMT VERIFICATION  
PRESS SET KEY



2) Press the SET key.

CURRENT : OFF  
1.ON 2.OFF

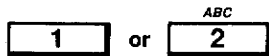

3) Press the 1 key to turn transmit verification on, or the 2 key to turn it off.

XMT VERIFICATION : ON  
PRESS SET KEY



4) Press the SET key.

- The initial setting is "OFF".
- When the transmission error occurred, this report is always printed out.

TRANSMISSION VERIFICATION REPORT																											
		TIME : 06/01/1992 14:18																									
		NAME : BROTHER																									
		FAX : 052-811-5981																									
		TEL : 052-824-2554																									
<table border="1" style="width: 100%; border-collapse: collapse;"> <tr> <td style="width: 40%;">DATE, TIME</td> <td colspan="3">06/01 14:16</td> </tr> <tr> <td>FAX NO./NAME</td> <td colspan="3">HEAD QTR.</td> </tr> <tr> <td>DURATION</td> <td colspan="3">00:01:33</td> </tr> <tr> <td>PAGE (S)</td> <td>01</td> <td>COVERPAGE</td> <td>CALL BACK MSG</td> </tr> <tr> <td>RESULT</td> <td colspan="3">OK</td> </tr> <tr> <td>MODE</td> <td colspan="3">FINE</td> </tr> </table>				DATE, TIME	06/01 14:16			FAX NO./NAME	HEAD QTR.			DURATION	00:01:33			PAGE (S)	01	COVERPAGE	CALL BACK MSG	RESULT	OK			MODE	FINE		
DATE, TIME	06/01 14:16																										
FAX NO./NAME	HEAD QTR.																										
DURATION	00:01:33																										
PAGE (S)	01	COVERPAGE	CALL BACK MSG																								
RESULT	OK																										
MODE	FINE																										

- Coverage and Callback Message does not count as part of Page Count.

### Activity report

An activity report lists the last fifty most recent activities, that is, transmissions that the machine has sent or received. The report shows the date, time, fax number or name of the other machine, transmission duration, the number of pages sent or received, whether the transmission was successful and the transmission type.

Activity reports are printed out automatically for each time interval which you register using the following procedure.



1) Press the FUNCTION key. Then press the 2 key.

2.REGISTRATION  
PRESS SET KEY



2) Press the SET key. Then press the 1 key followed by the 0 key.

10.ACTIVITY INTERVAL  
PRESS SET KEY

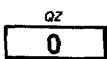

3) Press the SET key.

BASIS TIME : 00:00  
INPUT / PRESS SET TO END



4) Enter the basis time. This is the start of the time interval for which the machine will print out the activity report. When you have entered the time press the SET key.

IV-1. CONFIGURING THE MACHINE

INTERVAL SELECT NO.  
1.OFF 2.1H 3.2H 4.4H

INTERVAL SELECT NO.  
5.8H 6.12H 7.24H

5) Select the interval and press the appropriate key (1-7).

INTERVAL - 12H  
PRESS SET KEY



6) Press the SET key to confirm your setting.

- If you want to look at an activity report before the end of the time interval, print it out manually as follows.



1) To print out an activity report manually press the FUNCTION key followed by the 3 key.



3.ACTIVITY REPORT PRINT  
PRESS START KEY



2) Press the START key. The report is now printed.

ACTIVITY REPORT  
PRINTING

3) The screen returns to its normal display message.

ACTIVITY REPORT

TIME : 06/01/1992 16:00  
NAME : BROTHER  
FAX : 052-811-5981  
TEL : 052-824-2554

DATE	TIME	FAX NO./NAME	DURATION	PAGE(S)	RESULT	COMMENT
12/15	10:00	BROTHER BOSTON NL OFFICE	01:10:30	20 CV CA	OK	TX
12/16	15:55		48	01	OK	TX

CV : COVERPAGE      CA : CALL BACK MSG  
POL : POLLING      RET : RETRIEVAL

**2. SENDING A FAX**

There are two methods of sending a fax transmission - automatic and manual.

**Automatic transmission**

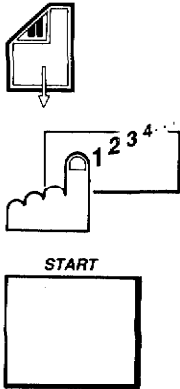

FAX : ENTER FAX NO.  
COPY : PRESS COPY KEY

To transmit a document automatically, set the document face down in the document feeder. The following screen appears:

Dial the fax number of the destination using one-touch, speed dial, Telephone Index, or manual dialing. Then, press the START key. The document is read through the machine automatically.

On successful completion of transmission, the machine will beep. If the transmission verification is "ON", then you will get a report at the end of each transmission.

If the telephone connection was not successful, and auto redial was set to "on", the machine will try to send again automatically. (See page IV-1-10.) If the auto redial was set to "off", the transmission will fail.

If the transmission was not successful then, the unit will print out a Transmission Verification Report (error) automatically. If the distant end is busy or there is no response the LCD will read either "NO RESPONSE OR BUSY", and the unit will print out a transmission verification Report (busy) automatically.

**Note:** CNG Tone is sent in Automatic Transmission.

TRANSMISSION VERIFICATION REPORT

TIME : 06/01/1992 14:18  
 NAME : BROTHER  
 FAX : 052-811-5981  
 TEL : 052-824-2554

DATE, TIME	06/01 14:16
FAX NO./NAME	HEAD QTR.
DURATION	00:01:33
PAGE (S)	01 COVERPAGE CALL BACK MSG.
RESULT	ERROR
MODE	FINE

IV. Basic Uses

## IV-2. SENDING A FAX

### Manual transmission

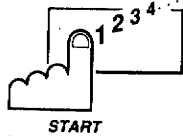
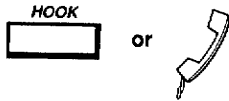

To transmit a document manually, set the document face down in the document feeder. The following screen appears:

FAX : ENTER FAX NO.  
COPY : PRESS COPY KEY

Either press the HOOK key or pick up the handset. Now dial the number of the destination using one-touch, speed, Telephone Index, or manual dialing. When you hear the answering fax tone press the START key and, if necessary, hang up the handset.

The document is drawn through the machine automatically.

Upon successful completion of the transmission the machine will beep.

- *Auto Redial is not effective for manual transmission.*
- *Only the following current settings are effective for manual transmission:*

- *Resolution*
- *super COVERPAGE*
- *Call Reservation*

- *In case of dialing by Telephone Index, before pressing HOOK key or picking up the handset, you should select the number from the Telephone Index. (see page IV-8-1)*

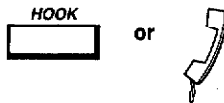

### Points to Remember When Sending a Fax

Bear in mind the following points whenever you send a fax.

- Adjusted the guides located on either side of the document, if it is less than 8.5 inches / 216 mm wide. (Min. width 5.8 inches / 148 mm.)
- Do not send documents on any of the following types of paper:
  - Thick paper
  - Very thin paper, such as tissue or tracing paper
  - Wet, wrinkled, torn, curled, or slick paper
  - Thick photographic or coated paper
  - Paper with tape or staples, or with metal or textiles attached

If you must send a document on any of these types of paper, copy them first with a photocopy machine and then use the copies to send your faxes. (Do not make your copies on this convenience copier, as the paper restrictions for the fax function apply to the copier as well.)

- The range of optimum thicknesses for sheets used in the ADF is  $2.8 \times 10^{-3}$ –  $3.9 \times 10^{-3}$  inches (0.07 – 0.10 mm) and the range for weight is  $0.07 \times 10^{-3}$ –  $0.114 \times 10^{-3}$  lbs/inch<sup>2</sup> (52 – 80g/m<sup>2</sup>). If you are using only one sheet of paper, the thickness of the paper should be between  $2.8 \times 10^{-3}$ –  $3.9 \times 10^{-3}$  inches (0.07 – 0.12 mm) and the weight, between  $0.114 \times 10^{-3}$  –  $0.182 \times 10^{-3}$  lbs/inch<sup>2</sup> (80 – 128g/m<sup>2</sup>).
- If the receiving fax machine is not set to AUTO ANSWER, someone may answer the telephone. If this happens, ask the other party to start fax reception by pressing their START key. (Remember you must use the handset to speak to the other party, as the unit does not have speaker phone.) Press the START key and then hang up after you hear the fax tone.
- If a document stops during feeding, press the STOP key to remove it. If the jammed paper is not ejected after pressing the STOP key, open the cover and remove the document.
- Remember that the fax machine cannot read text or images closer than 1/8" from any edge of a document when copying or sending a fax.
- Do not load more than 30 documents into the feeder at one time.
- Be sure to remove all paper clips before sending your document.
- Send glossy paper one page at a time.
- Do not attempt to transmit paper of differing sizes or thickness in one transmission.

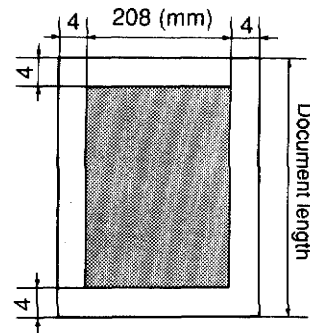

The maximum document width to be input is 8.5" (216mm). The maximum width of the printed (or scanned) area is 8.2" (208mm). The maximum document length is 35.4" (900mm), the minimum is 3.9" (100mm).

**Loading multiple pages for transmitting or copying**

If the document you are about to transmit or copy is more than one page, fan the sheets of paper and insert them face down, so that the first page is at the bottom and will be fed first.



**Current setting for sending a fax**

In order to make the clearest, most effective fax transmissions possible, the following current settings have been provided for your use. They are described in greater detail in the unit shown in parenthesis.

IV. Basic Uses

## IV-2. SENDING A FAX

---

These current settings should be made after setting the document face down in the document feeder (if needed), but before entering the fax number.

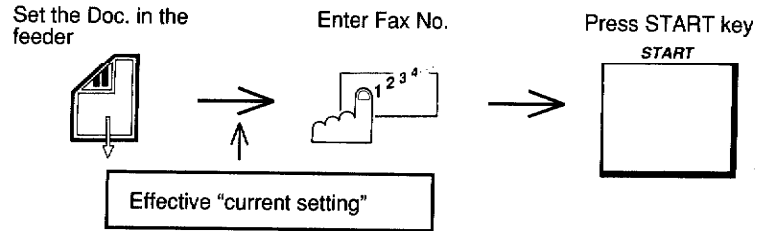

- **Resolution:** This can be changed from standard to fine (for newsprint and drawings), super fine (for highly detailed drawings), photo (for sending pictures), by pressing the resolution key. (See page V-1-1)
- **Contrast:** This can be changed automatically. If you want to send a super-light document, you can select "super light" mode manually. (see page V-2-1)
- **super COVERPAGE:** This exclusive Brother feature lets you send an extra sheet which includes your name and fax number as well as those of the destination. In addition, a message such as an "urgent!", "confidential", or your own message can be included with this information. (See page V-4-1)
- **Timer:** This option allows you to set a time at which you want your documents to be sent. This means it is possible to send a document when you are not in the office (e.g. at night when telephone rates are low). (See page V-6-1)
- **Polling:** Fax units can use this function to request documents from other units. Several sub-options are also available to let you make the most effective use of this feature. (See page V-8-1)
- **Password:** This security function lets you send and receive faxes in a closed network, and prevents reception of junk faxes. (See page V-7-1)
- **Call Reservation:** This allows telephone conversation with the other party after sending message. (See page V-5-1)
- **Relay Broadcasting:** This allows documents to be sent to a central machine (a Brother machine with memory) for storage and relay transmission to other local machines. You can save the expense of numerous long-distance calls. (See page V-12-1)
- **Confidential mailbox:** This allows you to send a document which will be stored in the receiving unit's memory until the receiving party inputs an access code. (See page V-13-1)



- **Broadcasting:** This feature can be used to send the same document to several different locations in a single operation. (See page V-11-1)
- **Memory :** This allows you to send document(s) from memory. (see page V-9-1)
- **ECM:** This is error correction mode which checks the integrity of a fax transmission while it is in progress and takes corrective action. (see page V-10-1)

## Redialing

If the number that you have dialed is engaged you can redial it without having to re-enter the number. There are two different ways of doing this, depending on whether you are using manual or automatic transmission.

### ***Automatic redialing***

Automatic redialing can only be used for faxes that were sent using automatic transmissions - not for telephone calls. You can turn automatic redialing on or off (see page IV-1-10).

When using automatic transmission to send a fax, if the destination number is engaged, the machine will automatically redial the number up to three (3) times at five (5) minutes intervals.

- *Before using automatic redialing, you can send a different fax message or make a copy of a document using the "Interrupt" feature.*

*(See page V-16-1.)*

- *To cancel automatic redialing, press STOP key.*

## IV-2. SENDING A FAX

---

### **Manual redialing**

If you are manually sending a fax or using the unit as a telephone and you obtain a busy signal, carry out the following procedure.

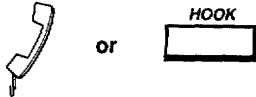

1) Replace the handset or press the HOOK key.

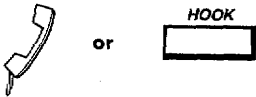

2) Pick up the handset or press the HOOK key.



3) When you hear the dialing tone press the REDIAL key. The machine now redials the number it dialed last.

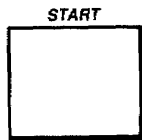

4) If you are sending a fax, press the START key when you hear the answering fax tone. If you are making a telephone call, simply proceed when the called party answers.

### 3. RECEIVING A FAX

Fax reception can be either manual or automatic. You will probably want to receive faxes automatically, as this is the more straightforward method. However, if you are using a single telephone line for both telephone and fax reception you will have several options. You can either use the unit in manual reception and monitor all in-coming calls, or you can use the FAX/TEL switch and let the machine decide if the call is a fax message or not.

#### Automatic reception

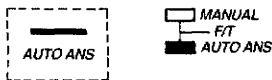

To receive faxes automatically set the AUTO ANS function to ON (the AUTO ANS LED is lit), (see page IV-1-7). There is no need for any further intervention - the machine will answer all calls automatically at any time. Having successfully received a fax the machine beeps once.

#### Manual reception

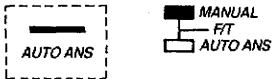

To receive faxes manually set the AUTO ANS function to OFF (the MANUAL LED is lit), (see page IV-1-7). The procedure for receiving a fax is as follows:

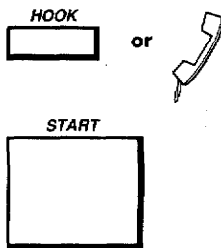

- 1) When the telephone rings either pick up the handset or press the HOOK key.
- 2) If you hear a fax tone press the START key.
- 3) Replace the handset if necessary.

Having successfully received a fax the machine will beep once.

#### Reception with FAX/TEL switching

There are two types of reception with FAX/TEL switching as described in the *configuration* section (see page IV-1-7) at the start of this chapter.

- 1) Automatic transmission from the other party.
  - 2) Manual transmission from the other party.
- *Pick up the handset while the machine is ringing. Follow the same procedure as for manual reception. If you do not pick up the handset, the machine will be changed to automatic reception mode after the specified ringing time. (Refer to the section on the FAX/TEL switch elsewhere in this chapter.)*

**Reception by Enhanced Remote Activation** Faxes can be received through the use of an external telephone or an extension telephone.

**Remote activation**

You can activate the fax machine from a remote telephone. This is useful if you are using the machine on an extension of a key telephone system.

Remote activation allows you to receive a call on a telephone which is either connected from the fax unit, or is parallel connected to your telephone line (extension telephone), but is not located near the fax unit. If an in-coming call is a fax transmission, simply press F/T & REMOTEID of the external/extension telephone (tone-type) to enable reception of the fax.

**Note:**

- *If you accidentally pick up your extension or external telephone by mistake when you are transmitting or receiving a FAX, there might be some slight distortion on the document.*
- *If you are using an extension or external telephone, be sure to use "\*"and/or"# for the F/T & Remote ID. (This will help you avoid operation errors.)*

**Reception into memory** If the unit has run out of paper it will automatically store any fax transmissions it receives in its memory. Also, if it runs out of paper midway through receiving a transmission, it will store the part of the document that it is unable to print. The following message appears on the LCD display:

CHECK RECORDING PAPER

Load the machine with paper and the unit will print any stored documents or parts of documents.

No data is lost provided you do not turn off the machine prior to printing out the stored documents.

## Registering F/T & Remote ID

Use the following procedure to register an F/T & Remote ID.

The initial setting is " \*\*"

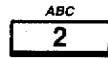

- 1) Press the FUNCTION key. Then press the 2 key on the number keys.

2. REGISTRATION  
PRESS SET KEY

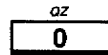

- 2) Press the SET key. Then press the 0 key followed by the 4 key.

04. F/T & REMOTE ID  
PRESS SET KEY



- 3) Press the SET key.

F/T & REMOTE ID : \*\*  
INPUT / PRESS SET TO END

Enter your chosen F/T & REMOTE ID number. When you have entered it correctly, press the SET key.

- When you connect the external telephone to a TAD (telephone answering device), the "F/T & REMOTE ID" you enter must be different from the TAD operation ID.
- If you are making use of an extension or external telephone, be sure to use the "\*" and/or " #" symbols. This will help prevent the fax unit from being turned on (accidentally into reception mode) when you are dialing.

## 4. USING ONE-TOUCH NUMBERS

If you regularly send faxes to the same destinations, it is useful to be able to dial these numbers without having to input them in every time using the number keys. A one-touch key enables you to send a fax (or make a telephone call) to a particular destination without having to enter the number every time - you simply press the relevant one-touch key and the machine automatically dials the number you require. The InstaFAX2200M can store up to sixty (60) fax or telephone numbers as one-touch numbers. The InstaFAX2100M can store up to thirty (30) fax or telephone numbers as one-touch numbers.

There are thirty one-touch keys, numbered 00 (30) to 29 (59), and a shift key which enables you to store different two destinations numbers under each one-touch key. (This applies only to the InstaFAX2200M.)

(For example, to dial the number stored as one-touch numbered 13, press the one-touch 13 key in the InstaFAX2100M/2200M. To dial the number stored as one-touch number 39 hold down the SHIFT key and press the one-touch 09 key in the InstaFAX2200M.)

### Registering one-touch numbers

To store a fax or telephone number as a one-touch number proceed as follows.



1

- 1) Press the FUNCTION key. Then, press the 1 key on the number keys.

1.ONE-TOUCH / SPEED DIAL  
PRESS SET KEY



1

- 2) Press the SET key. Then press the 1 key.

1.ONE-TOUCH DIAL  
PRESS SET KEY



- 3) Press the SET key.

ONE-TOUCH DIAL  
SELECT ONE-TOUCH KEY

ONE TOUCH KEY

- 4) Now press one of the one-touch keys, or hold down the SHIFT key and press a one-touch key. Pressing a key on its own permits you to register one of the numbers 00 to 29. On the InstaFAX2200M, holding down the SHIFT key allows you to register the numbers 30 to 59. The display changes to show the one-touch key number.

\*05:\_  
INPUT / PRESS SET TO END

"\*" means one-touch

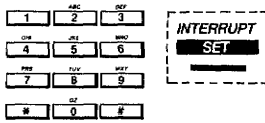

- 5) Enter the number (which can have up to 20 digits). When you have entered the fax or telephone number, press the SET key.

NAME:\_  
INPUT / PRESS SET TO END

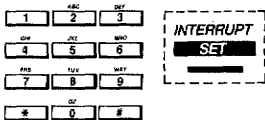

- 6) Enter the name (up to 24 characters) in the way described in the section entitled *Entering information using the keys*. Press the SET key when you have finished.

CURRENT : FAX  
1.FAX 2.TEL 3.OFF

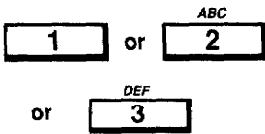

- 7) Press the 1 key for Fax, the 2 key for Telephone, or the 3 key for off. This selection is only used for the dial list. Selecting "off" is used for group keys (see page IV-4-3.), or chain dialing keys (see page IV-6-1).

CURRENT : FAX  
PRESS SET KEY

- 8) Press the SET key to confirm the setting.

ONE-TOUCH DIAL  
SELECT ONE-TOUCH KEY



STOP

- 9) You can either continue and register another one-touch dial number, or end registration by pressing STOP.

IV. Basic uses

#### IV-4. USING ONE-TOUCH NUMBERS

**Registering one-touch numbers as a group key** You can also store many destinations under a single one-touch key as a group. This feature is very useful for the broadcast transmission function (see page V-11-1), sequential polling function (see page V-8-5), and relay broadcasting function. (see page V-12-1)

##### Defining and storing a group

To define and store a group of destinations use the following procedure.



1) Press the FUNCTION key. Then press the 2 key.

2. REGISTRATION  
PRESS SET KEY

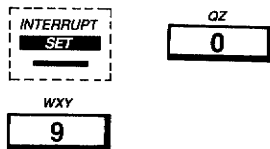

2) Press the SET key. Then press the 0 key followed by the 9 key.

09. GROUPING  
PRESS SET KEY



3) Press the SET key.

GROUPING  
SELECT GROUP KEY



4) Press the one-touch key to which you wish to assign the group that you are defining. If you have previously assigned one-touch or group to this key, you are asked whether you want to change or not. (If you have already assigned groups to six one-touch keys the unit will keep and display a message informing you that no new groups can be registered.)

NEW GROUP  
ENTER GROUP NO.

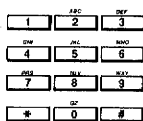

5) You can assign up to six groups numbered 1 to 6. Press the group number, using number keys.

GROUP 01  
PRESS SET KEY



6) Press the SET key.

G01: \_  
INPUT / PRESS SET TO END



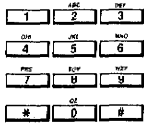

- 7) Enter the members of your new group using already registered speed dial numbers and one-touch keys (you can include up to 129 stations in one group for 2100M and 159 stations in one group for 2200M). The name of each destination is shown as you enter it on the lower line. The one-touch or speed dial numbers that you have entered are shown on the upper line. After each entry the cursor key must be pressed to lock in that entry.

- A one-touch number will be represented by a " \* " in front of the one-touch location number. Speed dialing numbers are represented by a "# " in front of the speed dial location number.

G01:#02#04 \*07  
FRENCH OFFICES



- 8) Press the SET key to confirm your group selection.

NAME: \_  
INPUT / PRESS SET TO END



- 9) Enter a name for the new group using the number keys (within 24 characters).

NAME: EUROPEAN OFFICES\_  
INPUT / PRESS SET TO END



- 10) Press the SET key.

### Sending one-touch faxes

To send a fax to a destination whose number is stored under a one-touch key simply follow the steps for sending a fax, either manually or automatically, and instead of dialing the number with the keys just press the relevant one-touch key (or hold down the shift key and press the one-touch key). The stored fax number is dialed automatically. To begin transmission just press the START key.

### Printing a list of one-touch numbers

To print out a directory listing of the names and numbers stored as one-touch dial numbers.

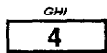

- 1) Press the FUNCTION key. Then press the 4 key on the number keys.

4.LISTS AND REPORTS  
PRESS SET KEY

IV. Basic uses

#### IV-4. USING ONE-TOUCH NUMBERS

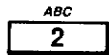

2) Press the SET key, then press the 2 key.

2.ONE-TOUCH DIAL  
PRESS START KEY



3) Press the START key to print out a list of the one-touch names and numbers. The screen displays a message informing you that it is printing out the list of one-touch dial numbers.

LIST - ONE-TOUCH DIAL  
PRINTING



4) Press the CLEAR key to return to the functions menu.

ONE-TOUCH DIAL LIST				
TIME : 06/01/1992 18:40				
NAME : BROTHER				
FAX : 052-811-5981				
TEL : 052-824-2554				
NUMBER	FAX/TEL NUMBER		DESTINATION	GROUP
*00	20182858815	FAX	HEAD QTR	
*01	9083568880	FAX	NJ OFFICE	G1
*02	31489787788	FAX	FIANCE DEPT	
*03	1467823	FAX	DESIGN DEPT	
*04	71498709892	FAX	LA OFFICE	G1
*05	0117361236	TEL	UK OFFICE	G1
*06	0899067856	TEL	PARIS OFFICE	G1
*07	6753452	TEL	ABC COMPANY	
.				
.				
.				

**Changing or Erasing one-touch names and numbers**

You can change or erase one-touch dial names and numbers by the following step.

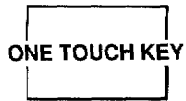

- 1) Select the one-touch dial option from the functions menu and press the relevant one-touch key.

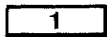
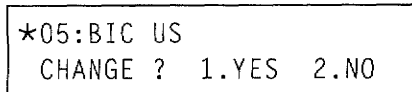

- 2) Press the 1 key. To alter a one-touch dial name and number, enter the new number and name as described in the sections *Entering information using the keys*. To delete a one-touch dial name & number, position the cursor at the extreme left end of the number and press the CLEAR key.



IV. Basic uses

## 5. USING SPEED DIAL NUMBERS

In addition to one-touch numbers you can also store another hundred fax or telephone numbers that you can access using two-number combinations - these are known as speed dial numbers. To dial one of these numbers you simply press the SPD. DIAL key followed by the appropriate two-digit speed dial numbers, and the machine dials the number you require. Speed dial numbers are numbered 00 to 99 (Even if the first digit is 0 you must type it when accessing the number - you cannot just type the SPD. DIAL key + the 1 key to call up the speed dial number 01.)

### Registering speed dial numbers

To store a fax number as a speed dial number proceed as follows.



1

- 1) Press the FUNCTION key. Then press the 1 key.

1. ONE-TOUCH / SPEED DIAL  
PRESS SET KEY



ABC  
2

- 2) Press the SET key, then press the 2 key.

2. SPEED DIAL  
PRESS SET KEY



- 3) Press the SET key.

SPEED DIAL  
SELECT NO. # \_

("#" means "speed")



- 4) Now enter the two-digit speed dial number you want to set.

#10: \_  
INPUT / PRESS SET TO END

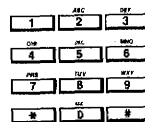

- 5) Enter number (which can have up to 20 digits).

When you have entered the number, press the SET key.

NAME: \_  
INPUT / PRESS SET TO END

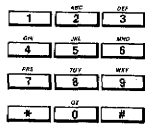

- 6) Enter the name (which can have up to 15 characters) in the way described in the section entitled *Entering information using the keys*. Press the **SET** key when you have finished.

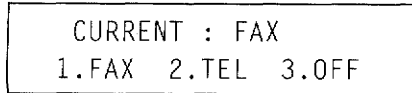

- 7) Press the 1 key for Fax, the 2 key for Telephone, or the 3 key for off. This selection is only used for the dial list. Selecting "off" is used for group keys (see page IV-4-3) or chain keys (see page IV-6-1).

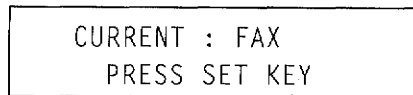
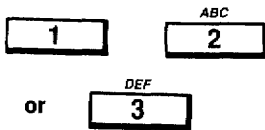

- 8) Press the **SET** key to confirm your choice. The screen again shows:

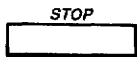
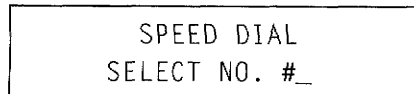

- 9) You can either continue and register another speed dial number, or end registration by pressing the **STOP** key.

### Sending speed dial faxes

To send a fax to a destination whose number is stored under a speed dial key simply follow the steps for sending a fax, either manually or automatically, and instead of dialing the number with the keys just press the **SPD. DIAL** key followed by the appropriate two digit speed dial code. The stored fax number is dialed automatically. To begin transmission just press the **START** key.

### Printing a list of speed dial numbers

To print out a directory listing of the names and numbers stored as speed dial numbers.



- 1) Press the **FUNCTION** key. Then press the 4 key.

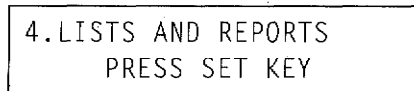

- 2) Press the **SET** key, then press the 3 key.



## IV-5. USING SPEED DIAL NUMBERS

START



- 3) Press the **START** key to print out a list of the speed dial names and numbers. The screen reverts to the LIST menu.

LIST - SPEED DIAL  
PRINTING



- 4) Press the **CLEAR** key to return to the functions menu.

SPEED DIAL LIST

TIME : 06/01/1992 18:40  
NAME : BROTHER  
FAX : 052-811-5981  
TEL : 052-824-2554

NUMBER	FAX/TEL NUMBER		DESTINATION	GROUP
#00	1-2018285881	FAX	AUSTRALIA OFFICE	G1
#01	20135640856	FAX	D.D.LTD.	
#02	001-3-3148978778	FAX	GERMAN OFFICE	G1
#03	12358769	TEL	W.CAMPANY	
#04	5892786	TEL	M.CAMPANY	
#05				

### Changing or Erasing speed dial names and numbers

You can change or erase speed dial names and numbers by following these steps.

Select the speed dial option from the functions menu.

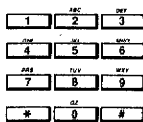

- 1) Press the relevant two digit speed dial code.

#05: BROTHER  
CHANGE ? 1.YES 2.NO

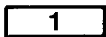

- 2) Press the 1 key. To alter a speed dial name and number, enter the new number and name as described in the sections *Entering information using the keys*. To delete a speed dial name & number, position the cursor at the extreme left end of the number and press the **CLEAR** key.

IV-5. USING SPEED DIAL NUMBERS

ACTIVITY REPORT

TIME : 06/01/1991 16:00

NAME : BROTHER

FAX : 052-811-5981

TEL : 052-824-2554

DATE	TIME	FAX NO. /NAME	DURATION	PAGE(S)	RESULT	COMMENT
12/15	10:00	BROTHER BOSTON	10:30	20 CV CA	OK	TX
12/15	10:12	NJ OFFICE	1:30	1	OK	TX
12/15	10:15	FIANCE DEPT.	3:45	5	ERROR	TX 24 33
12/15	10:20	BIE MANCHESTER	11:33	17 CV	OK	TX POL
12/15	10:33	DHL JAPAN	30	1	OK	TX
12/15	11:47	001-12018663756	1:20	3	OK	RX POL
12/15	13:06	LA OFFICE	5:54	7	OK	TX
12/15	13:20	LA OFFICE	4:07	5	OK	TX
12/15	14:37	HEAD QUARTER	1:05	2	ERROR	TX 24 12
12/15	15:02	FINANCE CENTER	1:06	2	OK	TX
12/15	15:20	DISIGN DEPT.	45	1	OK	TX RET
12/15	15:31	033542765	1:05	1	ERROR	RX RET 19 87
12/15	15:40	AUSTRALIA OFFICE	57	1	OK	TX
12/15	15:55	TOKYO OFFICE	58	0 CV	ERROR	TX
12/16	10:41	FINANCE CENTER	46	2	OK	TX ECM
12/16	11:18	OSAKA OFFICE	1:12	2	CANCEL	TX
12/16	12:09	33-1-3876543	51	1	OK	RX ECM
12/16	14:05	HEAD QUARTER	8:23	10	OK	TX
12/16	14:22	8765432	2:35	3	OK	RX
12/16	15:59	ABC COMPANY	48	1	OK	TX

CV : COVERPAGE      CA : CALL BACK MSG  
 POL : POLLING      RET : RETRIEVAL

IV. Basic uses

## 6. CHAIN DIALING

In addition to the one-touch and speed dialing functions available on the unit, a further convenient option called "chain dialing" can be used with either of the quick dialing functions.

When you send an automatic-transmission, the machine allows you to use a single one-touch dial or speed dial number. However, if you register a one-touch or speed dial as a "chain dialing" number, the machine allows you to use two different one-touch or speed dial numbers (a chain dial number followed by a one-touch, speed dial number or manual dialing (within 20 numbers)).

When dialing overseas fax or telephone numbers, there may be situations in which a company can offer you better rates than the telephone company you normally use. Chain dialing lets you choose the telephone company whose line charge is lower if you register the access code to a second telephone company as a chain dial number. This is also important when using a telephone credit card.

Instructions on how to use this option are provided below.

### Setting chain dialing



When you register a one-touch or speed dial number, simply press the CHAIN key before entering the number.

(@mark appears on the screen. @means "chain dialing.")

\*05:@  
INPUT / PRESS SET TO END

After that, the procedure is the same as for one-touch or speed dial numbers.

- *You can register numbers with up to 19 digits.*
- *You cannot send a transmission using chain dialing only. A one-touch, speed dialing number, or manual dialing (within 20 numbers) number must also be used.*

### Sending using chain

Press the first key registered as chain dial then press second key that you wish to chain. Then press START.



## 7. USING THE TELEPHONE INDEX

All the names and numbers that you register as one-touch dial or speed dial numbers are stored in an alphabetical directory list. You can search through this list to find whether a particular person's or company's number is recorded and automatically dial any listed telephone or fax number.

### Looking up a number

TEL INDEX

To look up a number in the directory press the TEL-INDEX key. You are prompted to enter the initial letter of the name you are looking up. Use the keys on the number to enter a letter in the same way as entering a name, for example press the 2 key once to enter A, twice for B or three times for C. The LCD screen shows the first name stored under the letter you have entered.

H| HEAD QTR.  
PRESS ← → OR STOP KEY

To look through the names stored under the selected letter, use the right cursor key. Each time you press the key the next name in the alphabetical list is shown. To go through the list in the opposite direction (that is, from Z to A) use the left cursor key. To choose a different initial letter use the appropriate letter key.

- Names are sorted as follows:

- ① A-Z (alphabet)
- ② Special characters (Ä Ë Ö Ü Æ ø Å Ñ)
- ③ Numbers (0-9)
- ④ Punctuation marks and Symbols

- If you did not enter a name for one-touch or speed dial number, the fax/telephone number is used as the name, and "number" appears on the LCD.

### Sending a fax

TEL INDEX

START

To send an automatic fax to a number recalled from the Telephone Index simply set your document face down in the automatic document feeder, press the TEL-INDEX key, use the appropriate letter key and (← / →) cursor keys, if necessary, to display the name and number you require and then press the START key.

## IV-7. USING THE TELEPHONE INDEX

---

In case of manual transmission, before pressing HOOK key or picking up the handset, you should press TEL-INDEX key and look up the dial, and confirm it by pressing TEL-INDEX key again. After that press HOOK key or pick up the handset, and press TEL-INDEX key again.

### Printing out the telephone index

To print out a directory listing of all the names and numbers stored in the telephone index.

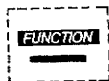

- 1) Press the **FUNCTION** key. Then press the **4** key on the number keys.

4. LISTS AND REPORTS  
PRESS SET KEY

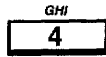

- 2) Press the **SET** key, then press the **4** key.

4. TEL. INDEX  
PRESS START KEY

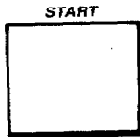

- 3) Press the **START** key to print out the directory.

LIST - TEL. INDEX  
PRINTING

IV-7. USING THE TELEPHONE INDEX

TELEPHONE INDEX LIST

TIME : 06/01/1992 18:45

NAME : BROTHER

FAX : 052-811-5981

TEL : 052-824-2554

DESTINATION	NUMBER	FAX/TEL NUMBER		GROUP
ABC COMPANY	*07	6753452	TEL	
ALL OFFICES	*19	*** GROUP 1 ***		
AUSTRALIA OFFICE	#00	1-2018285881	FAX	G1
DESIGN DEPT	*03	1467823	FAX	
D.D.LTD.	#01	20135640856	FAX	
FIANCE DEPT	*02	31489787788	FAX	
GERMAN OFFICE	#02	001-3-3148978778	FAX	G1
HEAD QTR	*00	20182858815	FAX	
LA OFFICE	*04	71498709892	FAX	G1
M.COMPANY	#04	5892786	TEL	
NJ OFFICE	*01	9083568880	FAX	G1
PARIS OFFICE	*06	0899067856	TEL	G1
UK OFFICE	*05	0117361236	TEL	G1
W.COMPANY	#03	12358769	TEL	

C:CHAIN

IV. Basic uses

## 8. USING THE UNIT AS A TELEPHONE

As well as sending fax transmissions, this fax machine can also be used to make telephone calls. You can either dial numbers manually or use one-touch dialing, speed dialing or the telephone index.

### Manual dialing

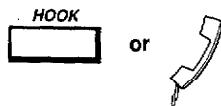

Pick up the handset and dial the telephone number normally using the number keys.

Alternatively, press the HOOK key to enable dialing and then dial the telephone number using the number keys. When the receiving party answers, pick up the handset and proceed with your call.

### One-touch dialing

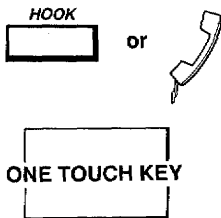

You can use any of the one-touch telephone numbers that you have registered. Simply pick up the handset (or press the HOOK key), and press the appropriate one-touch key. On the InstaFAX2200M you need to hold down the SHIFT key for numbers 30 through 59.

If you use the HOOK key, pick up the handset when your call is answered.

### Speed dialing

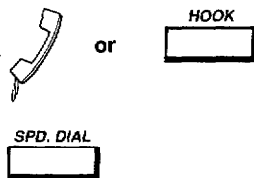

You can also make use of the speed dial feature. Simply pick up the handset (or press the HOOK key), press the SPD. DIAL key and type the appropriate 2 digit speed dial number.

If you used the HOOK key, pick up the handset when your call is answered.

### Using the telephone index

To dial a telephone number from the telephone index, first press the TEL-INDEX key and enter the initial letter of the name you are searching for. Use the cursor keys to search forwards and backwards through the directory. When the name you are searching for is displayed on the LCD, press the TEL-INDEX key, pick up the handset (or press the HOOK key) and then press the TEL-INDEX key again. The unit will then dial the displayed number.

If you used the HOOK key, pick up the handset when your call is answered.

**Using keys with the telephone**

- PAUSE key- Use this key to put a pause between numbers. (You cannot use the PAUSE key continuously.)
- HOLD key- Use this key to put a telephone call on hold.
- Flash key- Use this key to transfer a call and put it on hold.
- # key- Use this key to switch the dialing type to "tone", in case it had previously been set to "pulse".

**Using an external telephone**

You can use the fax machine with an external telephone or with an external TAD (telephone answering device). Connect the external telephone as described in the "ADDITIONAL SET UP OPTIONS" (see page III-9-1).

**Using an external telephone answering device**

Connect your external telephone answering device (TAD) to the EXT. DEVICE jack as shown in the illustration below.

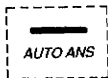
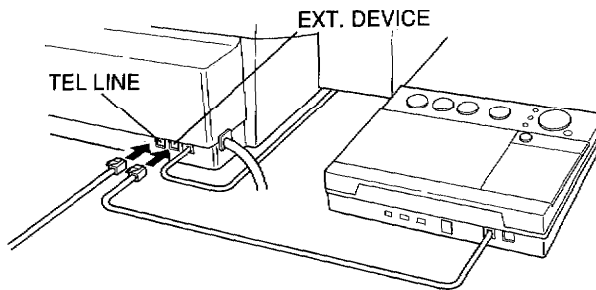

Set the Auto Ans. switch to "Manual" (so that only the "Manual" LED is lit).

The external TAD is now ready for use.

The unit will enter the document reception mode automatically when another party tries to send a fax transmission with a CNG tone to your machine. CNG is generated by most Group 3 FAX machines.

If the sending party (using a tone type unit) presses your F/T & REMOTE ID code, fax reception is switched to the main unit.

- If the ICM section of your external TAD is full, the TAD will not answer the telephone. As a result the unit cannot receive the transmission.

IV. Basic uses

#### *IV-8. USING THE UNIT AS A TELEPHONE*

---

- If your external TAD has a paging function, the unit may prevent the paging function from working.
- Some fax machines may not be able to signal your fax machine to switch on automatically during a transmitting. To cover this possibility we recommend that you record a message on your TAD requesting the sending party to enter the F/T & Remote ID code key on his unit before transmission.

A sample message; "Our answering machine is connected to a fax unit at present, so if you would like to send a fax, please press the XX (your F/T & REMOTE ID) by tone signal and send your fax after you hear the FAX tone. If you would like to leave a message, please do so after this message. Thank you."

# V. Advanced uses

## 1. RESOLUTION

There are four different resolution settings available—STANDARD, FINE, SUPER FINE, and PHOTO. Note that the photo mode on the InstaFAX2200M is always in super gray scale. The standard resolution is adequate for sending ordinary text documents. Fine resolution is intended for the transmission of graphic images and documents that have small print. SUPER FINE is for use with finely-detailed graphic images such as complex line drawings and similar artwork. PHOTO resolution mode is specifically designed for the transmission of photographic images. The photo mode in the InstaFAX2200M (super gray scale) improves upon the normal photo mode by allowing the transmission of text on the same document with a photo without any loss of text clarity. It also prevents patterns from forming in the photo image. Whichever mode you use, the quality of the printed document's at the distant location will not be adversely affected.

You can select a resolution setting in two ways. Firstly, you can press the RESOLUTION key on the key panel prior to sending your document and light the LED corresponding to the resolution mode you want to select. Your document is then transmitted using the same resolution mode you have selected. Secondly, you can use the CURRENT SETTING function to select a resolution setting for each page of a document individually. Both setting methods will be effective for one transmission only. If the receiving fax machine cannot print at the resolution that you specified, transmission will take place at a lesser resolution. (The resolution LEDs change to show you which resolution is being used to print the current document or page that you are sending is being printed.)

- *"Super Fine" resolution can only be used between Brother machines.*
- *If no LED is lit, the unit is in standard resolution.*

### Single resolution transmission

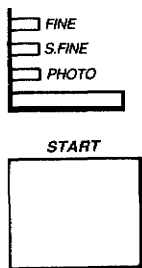

Place your document in the document feeder and dial the number as you do for an ordinary fax transmission. Before pressing the START key select a resolution by pressing the RESOLUTION key. Press once for FINE mode, twice for SUPERFINE and three times for PHOTO mode. Pressing the RESOLUTION key fourth time returns the machine to the standard resolution mode. There are three LED lights positioned next to the RESOLUTION key to indicate the current resolution setting. If all three are not lit, the unit will transmit at the standard resolution. For each of the other three resolution modes, the appropriate light comes on when the mode has been selected.

When you have selected the resolution mode press the START key. Your document will be sent at the specified resolution.

**Multiple resolution transmission**

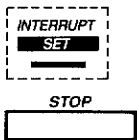
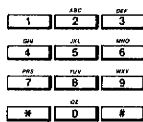
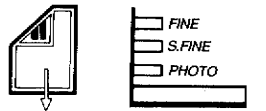

After transmission has been completed the unit reverts to standard resolution mode. The three resolution LEDs are not lit.

If your fax transmission document runs to several pages, some with graphics, some with text and others with photographic images, you can specify a resolution mode for each individual page.

1) Set the document in the feeder. Use the **RESOLUTION** key to set the resolution you require for the first page of your document.

2) Press the **FUNCTION** key followed by the **6** key.

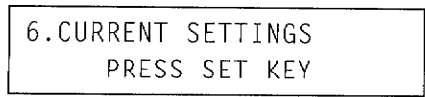

3) Press the **SET** key, then the **2** key.



4) Press the **SET** key. The screen display now alternates between the following two messages, prompting you to specify a resolution for page 2 of your document.

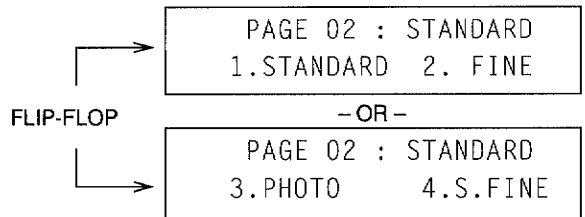

5) Enter the number corresponding to the resolution you wish to set for page 2.



6) Press the **SET** key to confirm your choice. The display now prompts you to select a resolution for page 3. Specify your choice in the same way. The display continues to prompt you for resolution settings for successive pages up to a maximum of 30. When you have selected settings for all the pages in your transmission press the **STOP** key.

- The super **COVERPAGE** and **Call Back Messages** are not counted when determining the page number for scanning resolution.



FAX : ENTER FAX NO.  
 COPY : PRESS COPY KEY

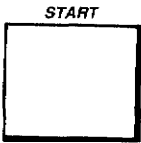
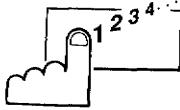

- Any pages for which you did not set a resolution will be transmitted at the same resolution as the last page for which you did set a resolution.

- 6) Select the fax number in the usual way and press the START key. Your document is sent at the specified resolutions.

After transmission has been completed the unit reverts to standard resolution mode. The three resolution LEDs are not lit.

**The resolution of in-coming documents**

The resolution of fax transmissions that you receive depends entirely on the capabilities of the fax machine from which the document was transmitted and the settings selected by the person sending it. Your fax machine can receive and print documents in three modes, STANDARD, FINE and SUPERFINE. The mode being used to print the document (or the current page) is indicated by the LED lights.

The photo LED is not lit when receiving document in photo mode.

**Copier resolution**

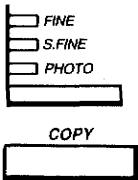

You can use the convenience copier in SUPERFINE or PHOTO modes. However, you can only use a single mode for each copy operation. Pages of a document that are to be copied at a resolution different to that of the rest of the document must be loaded and copied separately.

Set the document in the feeder. Select a mode by pressing the resolution key, and then press the COPY key. If you make a copy without having first selected a resolution, the machine will automatically copy using "SUPER FINE" mode. The SUPER FINE LED will come on to show that this mode is being used.

After you have made your copy the unit reverts to the standard resolution mode. The three LEDs are not lit.

V. Advanced Uses

## 2. SETTING THE CONTRAST

The unit has an "Auto-Contrast" feature, so you do not have to select the contrast setting before sending. However, if you want to send a very light document, set the contrast to "SUPER LIGHT" manually.



1) To select the "SUPER LIGHT" contrast mode, first set your document in the feeder.

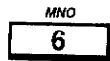

2) Press the FUNCTION key followed by the 6 key. The following message appears.

6. CURRENT SETTINGS  
PRESS SET KEY

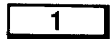

3) Press the SET key followed by the 1 key.

1. CONTRAST  
PRESS SET KEY



4) Press the SET key. The current contrast setting is displayed.

CURRENT : AUTO  
1. AUTO 2. SUPER LIGHT

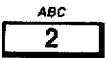

5) Press the 2 key to select SUPER LIGHT mode.

CONTRAST : SUPER LIGHT  
PRESS SET KEY

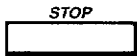

6) Press the SET key to confirm your selection. Then press the STOP key.

7) Now you can send your transmission or make your copy.

- *This setting is only effective for one transmission or copy operation.*

### 3. SMOOTHING (ENHANCED IMAGE RESOLUTION)

The fax machine has the capability to smooth the outlines of text characters on the faxes that you receive. This is a useful feature as it allows you to enhance the presentation quality of text documents that are sent to you without having to rely on the sender to alter the resolution setting on his machine.

There are two possible smoothing settings - ON or OFF. Select OFF to prevent the fax machine from performing any smoothing, and select ON to activate smoothing.

The procedure for turning smoothing ON or OFF is shown below.



- 1) Press the **FUNCTION** key. Press the **5** key on the number keys.

5.USER OPTIONS  
PRESS SET KEY

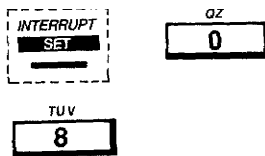

- 2) Press the **SET** key. Press the **0** key followed by the **8** key.

08.SMOOTHING  
PRESS SET KEY



- 3) Press the **SET** key.

CURRENT : ON  
1.ON 2.OFF

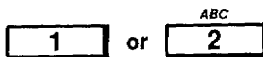

- 4) Press **1** to select the smoothing mode, and press **2** to turn the smoothing function off.

SMOOTHING : OFF  
PRESS SET KEY

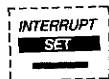

- 5) Press the **SET** key to confirm your selection.

The smoothing setting will remain in effect until you change it.

- *The initial setting is "ON".*
- *Smoothing is a receive function and will not increase time on reception.*

## 4. USING THE SUPER COVERPAGE FACILITY

When you send a fax it is often useful to send an accompanying cover sheet at the same time. This sheet is known as the super COVERPAGE and tells the person receiving the fax your name, fax number and telephone number. These are the name and numbers that you will have registered in the machine as part of the configuration process. If you have not registered your name, fax number and telephone number (Station ID), you cannot send the super COVERPAGE.

You can also choose to show on the super COVERPAGE the number of pages you are faxing.

You can include an optional comment on the super COVERPAGE. You can select one of five comments, three that are preset and two original messages which you can create yourself. You can also choose no comment.

### Sending a fax with a super COVERPAGE



The steps for sending a fax transmission with a super COVERPAGE are as follows.

- 1) Set the document face down in the feeder.

FAX : ENTER FAX NO.  
COPY : PRESS COPY KEY

- 2) Press the COVERPAGE key on the panel. The screen prompts you to select one of the five available comments or select to send the fax without a comment. Comments 5 and 6 are the comments that you have registered yourself.

SELECT COMMENT (1-6)  
2.PLEASE CALL

The six available comments are ;

1. (comment off)
2. PLEASE CALL
3. URGENT !
4. CONFIDENTIAL
5. (your original comment)
6. (your original comment)

as for 5 and 6, you can register your original comment as described "Entering information using keys".

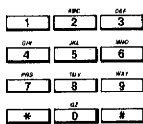

- 3) Make your selection by pressing the appropriate number key from 1 to 6. The screen briefly displays the option you have chosen.

V-4. USING THE SUPER COVERPAGE FACILITY

COVERPAGE  
3.URGENT !

- 4) Now the screen displays a message asking you whether you want to show on the super COVERPAGE the number of pages that you are sending.

TOTAL NO. OF PAGES  
1.ON 2.OFF

1 or 2

- 5) Press the 1 key if you do, and the 2 key if you do not. If you press 1 you are then prompted to enter the number of pages that you are faxing.

TOTAL PAGES : 00  
ENTER TOTAL NO. OF PAGES

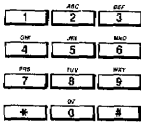

- 6) Enter the number of pages as a two digit number (that is, if you are sending five pages enter "05") using the number keys. The number of pages you enter is briefly shown.

TOTAL PAGES: 05

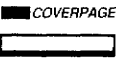

- 7) The screen display reverts, and the COVERPAGE LED is lit.

ENTER FAX NO.

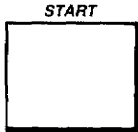
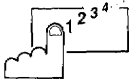

- 8) Now enter the fax number, by using the one-touch key, speed dial, manual dial or the Telephone Index, and press the START key.

NJ OFFICE  
SENDING COVERPAGE

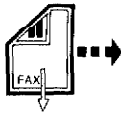

When the super COVERPAGE has been sent, the machine then sends the document.

Printing out a super COVERPAGE

You can print out a sample of the super COVERPAGE as follows.



GHI  
4

- 1) Press the FUNCTION key, then press the 4 key.

4.LISTS AND REPORTS  
PRESS SET KEY



JKL  
5

- 2) Press the SET key, then press the 5 key.

5.COVERPAGE  
PRESS SET KEY



- 3) Press the SET key, then choose the comment you require and press the START key.

V. Advanced Uses

V-4. USING THE SUPER COVERPAGE FACILITY

- The destination of sample super COVERPAGE is taken from one-touch dial number "00".

If you have nothing programmed in that one-touch, the destination area will be left blank. Also, the total pages will always be "00".

```

==== COVER PAGE ====

TO:      NJ OFFICE
FAX:     908-356-8880

FROM:    BROTHER
FAX:     052-811-5981
TEL:     052-824-2554

          00 PAGE[S] TO FOLLOW
COMMENT:  URGENT !
    
```

**Entering a comment**

To register your original comment for inclusion on the super COVERPAGE, use the following procedure.



1) Press the FUNCTION key followed by the 2 key.

```

2.REGISTRATION
PRESS SET KEY
    
```

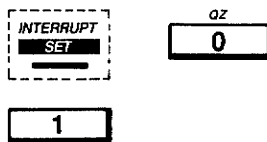

2) Press the SET key. Now press the 0 key followed by the 1 key.

```

01.COVERPAGE COMMENT
PRESS SET KEY
    
```

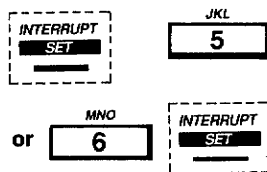

3) Press the SET key. Press 5 or 6, depending on which of the two comments you wish to register, then press the SET key again.

```

5._
INPUT / PRESS SET TO END
    
```

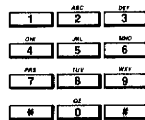

4) Enter your comment (which can be up to 27 characters) using the keys on the number keys as described in the section "Entering information using the keys".

```

5.ORDER CONFIRMATION_
INPUT / PRESS SET TO END
    
```



5) When you have correctly entered your comment, press the SET key.

## 5. CALL RESERVATION AND THE CALL BACK MESSAGE

The purpose of this feature is to alert the party receiving your fax transmission that you want to speak to them on completion of the transmission. When your document has been printed at the receiving station the receiving fax machine will ring as if it were receiving a telephone call. If the receiving party is present and picks up the handset your fax machine will also ring. Then you can pick up the handset and talk with the person to whom you have just sent a fax.

The steps for sending a fax transmission with Call Reservation are as follows:

### Sending a fax with Call Reservation

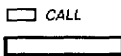

- 1) Set the document face down in the feeder.

FAX : ENTER FAX NO.  
COPY : PRESS COPY KEY

- 2) Press the CALL key.

CALL BACK MSG.  
1.ON 2.OFF

The Call Back Message is a text message that will be printed at the receiving station if the receiving party does not answer. The message requests the receiver to call you.

*- If you have not registered your telephone number at station ID (see page IV-1-2), you cannot send "Call Back Message".*

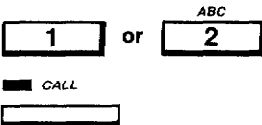

- 3) Press the 1 key if you want a Call Back Message to appear, or the 2 key if you do not. The CALL LED is lit.

ENTER FAX NO.

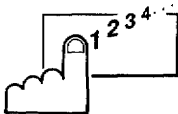

- 4) Select the destination fax number, either by entering it using one-touch dial, speed dial, Telephone Index, or manual dial.

NJ OFFICE  
PRESS START KEY

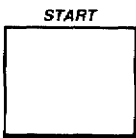

- 5) Press the START key. The machine now transmits automatically.

When the document has been transmitted, the unit at the receiving station rings. The message on the screen changes to show:

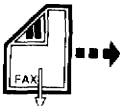

## V-5. CALL RESERVATION AND THE CALL BACK MESSAGE

---

NJ OFFICE  
CALLING

- 6) If the receiving party answers, your unit will also ring.

NJ OFFICE  
CALL PICKUP

- 7) You can now pick up the handset and talk.  
If the receiving party does not answer and you have previously selected Call Back Message "ON", the Call Back Message will be printed at the receiving station instead.

If an error occurs during the transmission of the fax itself the call reservation function will not operate.

- *There are certain types of fax machine which will not respond to the Call Reservation function.*
- *When auto redialing, Call Reservation will be cancelled. But if you select Call Back Message "on", the unit will send a Call Back Message after sending the document.*
- *You can print out an example of the Call Back Message*
- *You cannot use Call Reservation with either the timer, polling, or the broadcast function.*
- *If you set Call Reservation "on" then set up a Timer (delayed) transmission, the Call Reservation will be cancelled.*

### Printing out a Call Back message

You can print out a sample Call Back Message as follows.



GHI  
4

- 1) Press the FUNCTION key, then press the 4 key.

4.LIST AND REPORTS  
PRESS SET KEY



MNO  
6

- 2) Press the SET key. Then press the 6 key for a "Call Back Message".

6.CALL BACK MSG.  
PRESS START KEY



- 3) Press the START key.

- *The destination for the sample Call Back Message is taken from one-touch number "00". If this number is not programmed, the destination area will be blank.*



V-5. CALL RESERVATION AND THE CALL BACK MESSAGE

---

=== CALL BACK MESSAGE ==

TO: NJ OFFICE  
FAX: 908-356-8880

FROM: BROTHER

PLEASE CALL AT [TEL] 052-824-2554

[FAX] 052-811-5981

V. Advanced  
USPS

## 6. TIMER TRANSMISSION (DELAYED TRANSMISSION)

If you wish to defer the sending of a document (for example, to take advantage of cheaper telephone rates) you can use the Timer delayed transmission facility. Simply place your fax document in the document feeder and set the time at which you want the fax to be sent. The unit will automatically send the fax at the time you have set.

### Sending a fax with Timer

The steps involved in sending a delayed fax transmission are as follows:



- 1) Set the document face down in the document feeder.

FAX : ENTER FAX NO.  
COPY : PRESS COPY KEY



- 2) Press the TIMER key.

TIMER  
SET TIMER : 00:00

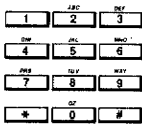

- 3) Use the number keys to enter the time (between 00:00 to 23:59) within the next 24 hours at which you wish to send the fax transmission. When you have entered the 4 digits, the following screen appears after 2 seconds.

23:30  
ENTER FAX NO.

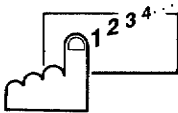

- 4) Now enter the fax number of the destination, using a one-touch key, a speed dial number, a number from the Telephone Index, or dialing manually.

BROTHER  
PRESS START KEY



- 5) Now press the START key. You can now leave your fax machine as it is and it will send your fax to the specified destination at the appointed time. After transmission has successfully been completed, a "Delayed Sending Report" will be printed out automatically.

- Up to three timer transmission can be preset (for as many as 129 stations on the InstaFAX2100M and 159 stations on the InstaFAX2200M.)

V-6. TIMER TRANSMISSION (DELAYED TRANSMISSION)

DELAYED SENDING REPORT

TIME : 06/01/1992 14:30  
NAME : BROTHER  
FAX : 052-811-5981  
TEL : 052-824-2554

DATE, TIME	06/01 14:29
FAX NO./NAME	NJ OFFICE
DURATION	00:00:42
PAGE (S)	02
RESULT	OK
MODE	FINE

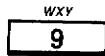

- Your machine can still receive fax transmissions while waiting to send.
- To cancel timer transmission, press the FUNCTION key, the 9 key, and then press the SET key to enable the "Cancel Transmission" function.
- If you want to use the unit for another operation without disturbing your Timer (delayed) transmission settings, press the "Interrupt" key to carry out another operation. (see page V-16-1)
- If you want to use the unit for another feature without disturbing your Timer (delayed) transmission settings, press the "Memory" key, and store the document into the memory. (This can be done up to 3 times.)

V. Advanced  
uses

**Initial Timer**

If you want to send a Timer (delayed) transmission every day at a fixed time, you can use the "Initial Timer" function. The time that has been set appears when you press the "Timer" key. (Initial setting is 00:00).

You need only register the initial timer once - you do not need to re-enter the time every day. Then each day just press the TIMER key and the SET key.

To register the initial time proceed as follows.

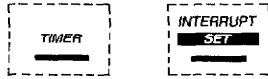

2. REGISTRATION  
PRESS SET KEY

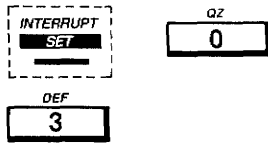

1) Press the FUNCTION key, then press the 2 key.

2) Press the SET key, then press the 0 key followed by the 3 key.

03. INITIAL TIMER  
PRESS SET KEY



3) Press the SET key.

CURRENT : 00:00  
CHANGE ? 1.YES 2.NO

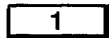

4) Press the 1 key.

INITIAL TIMER : 00:00  
INPUT / PRESS SET TO END

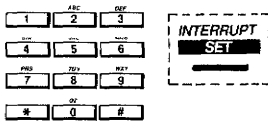

5) Enter the time you require and press the SET key.

## 7. THE PASSWORD

The fax password function is provided for use in a closed network of fax machines. It can also be used to help you prevent reception of the "junk faxes" that can interfere with your daily operations. It can also prevent the transmission of faxes to the wrong parties.

Passwords should not be used casually. If you have activated the password function, only people who have Brother (or compatible) fax machines and have set the correct password code on their own machine can exchange faxes with your unit.

To remedy this you can enable the PASSWORD PLUS feature, whereby the unit accepts transmissions without passwords from anybody whose number is listed as a one-touch number. (The unit detects the last four digits of the number whether it is same or not.) People whose numbers have not been registered as a one-touch number in your machine must still use the password.

### Sending a fax with password

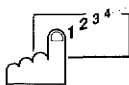
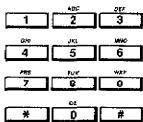

To send a fax with a password, carry out the procedure described below. Before this procedure, please re-check the other party's password code.

- 1) Set the document face down in the feeder.

```
FAX : ENTER FAX NO.
COPY : PRESS COPY KEY
```

- 2) Press the PASSWORD key.

```
PASSWORD : 0000
ENTER CODE NO.
```

- 3) Enter the 4-digit password code. This must be the same code as the other side's receiving password.

```
PASSWORD : 1234
ENTER CODE NO.
```

- 4) When you have entered the 4-digit code, the display will briefly change. (Wait for 2 seconds)

```
PASSWORD
ENTER FAX NO.
```

- 5) Enter the fax number using the number keys, a one-touch key, speed dial number, or Telephone Index. Now press START key.

- When the other side sets their receiving password to "off", you can not send a fax with a password, even if the password code is the same as the party's receiving password.
- You cannot use passwords with the following types of transmission.
  - Polling (excluding turn – around polling)
  - Confidential transmission
  - Relay broadcast request
  - Remote retrieval of a confidential message
  - Manual transmission

### Setting the fax receiving password

To set the fax receiving password, use the following procedure. Your machine's receiving password is used by the other party when transmitting.

1) Press the FUNCTION key.



2) Press the 2 key.

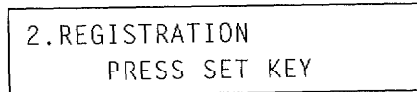
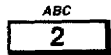

3) Press the SET key.



4) Press the 0 key followed by the 6 key.

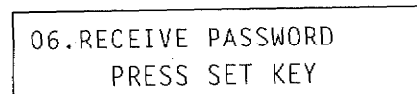
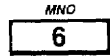
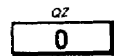

5) Press the SET key.

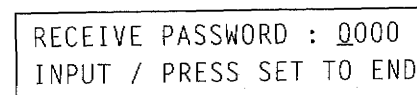

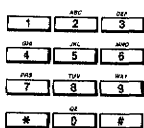

6) Enter a four-digit password number using the number keys.

RECEIVE PASSWORD : 1234  
INPUT / PRESS SET TO END

7) Press the SET key to confirm your password setting .

- The initial setting is "0000".
- This procedure merely sets the receiving password. It does not enable password mode. To turn your machine's password "ON" follow the procedure below.

**Turning password protection on and off**

To turn password protection on or off, or to enable the PASSWORD PLUS function, proceed as follows.



1) Press the FUNCTION key. Press the 5 key on the number keys.

5.USER OPTIONS  
PRESS SET KEY

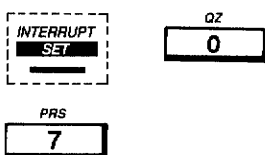

2) Press the SET key. Press the 0 key followed by the 7 key.

07.RECEIVE PASSWORD  
PRESS SET KEY



3) Press the SET key.

CURRENT : OFF  
1.ON 2.PLUS 3.OFF

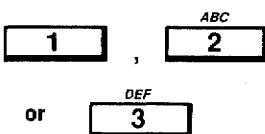

4) Press the 1 key to turn password protection on, press the 2 key to turn password plus protection on, or press the 3 key to turn password protection off.

RECEIVE PASSWORD : ON  
PRESS SET KEY



5) Press the SET key to confirm your selection.

- The initial setting is "off".

## 8. POLLING

### What is Polling?

Polling is a feature which lets fax machines call other machines to request a fax transmission. The unit can receive a request for transmission of a document (making you the called side) or it can request a document from another unit (which makes you the calling side). The InstaFAX2100M/2200M permits you the option of polling one other unit or several different units. It can be operated using either standard or security polling functions.

Polling is among the most advanced features on the machine. While the concept may be new to some users, the operation is always basically the same: one fax machine calls another to request a document. The table below shows the various polling operations which can be carried out by the machine.

- **Standard Polling**      Sends a request to have a document sent from another fax unit.
- **Secure Polling**      Makes use of a coded security feature when requesting a document.
- **Timer (delayed) Polling**      Sends a request at a specified time for the transmission of a fax from another machine.
- **Turnaround Polling**      Used for "two-way" polling, this lets you send a document, then request a document from another fax unit.
- **Sequential Polling**      Used to request documents from several different fax units in a single operation.

Remember that the calling side bears the expense of a fax transmission when polling is done.

#### STANDARD POLLING

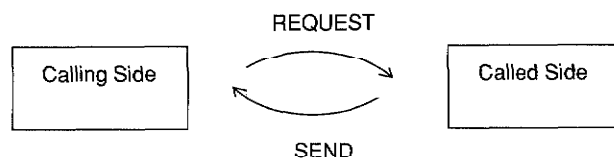

- *There are some types of fax machine which cannot poll or be polled.*
- *Secure polling can only take place between Brother fax machines.*
- *The password function cannot be used with polling, but this function can be used for turn-around polling.*
- *To cancel a polling operation use the 'cancel transmission' feature.*



**Standard polling**

To poll for a document that is not confidential (and so is not protected with a secure code) proceed as follows.



- 1) Make sure there is no document in the feeder.

06/01/1992 14:00  
FAX/COPY : SET DOC.

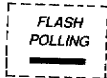

- 2) Press the POLLING key.

SELECT NO.  
1. STANDARD 2. SECURE



- 3) Press the 1 key.

POLL  
ENTER FAX NO.

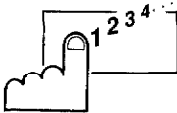

- 4) Enter the fax number of the machine you are polling. You can enter the number using the number keys, one-touch, speed dial or a Telephone Index.

BROTHER MIZUHO  
PRESS START KEY

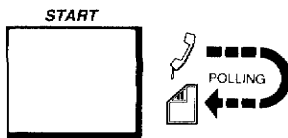

- 5) Press the START key. The machine contacts the called side and requests a document.

- *When the called side sets the document with a secure code, you cannot poll the document.*

**Secure polling**

To poll for a confidential document that is protected with a security code, the procedure is as follows.



- 1) Make sure there is no document in the feeder.

06/01/1992 14:00  
FAX/COPY : SET DOC.

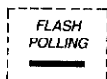

- 2) Press the POLLING key.

SELECT NO.  
1. STANDARD 2. SECURE

V-8. POLLING

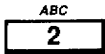

3) Press the 2 key.

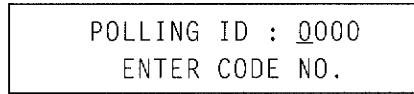

4) Enter the polling ID - this four-digit secure code that should be the same as the secure code used by the called side.

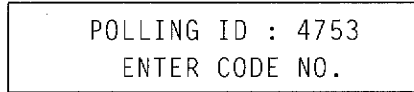

5) When you have entered the four digit code, the screen will briefly change. (Wait 2 seconds)

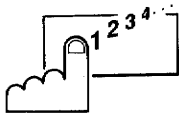
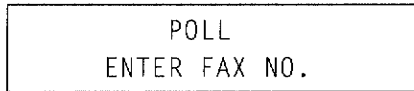

6) Enter the fax number of the machine you are polling. You can enter the number using the number keys or you can use manual dialing, a one-touch, speed dial or Telephone Index.

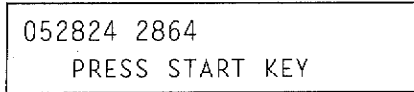

7) Press the START key.

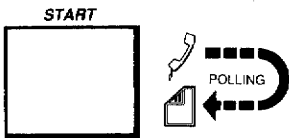

The machine contacts the called side and requests the document.

- *When the secure code does not match with that used by the called side, the document cannot be polled.*
- *The called side's machine should be a Brother machine.*

**Timer (delayed) polling**

Follow the steps described below to set up a timer (delayed) polling operation.



1) Make sure there is no document in the feeder.

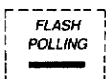
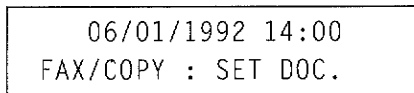

2) Press the POLLING key.

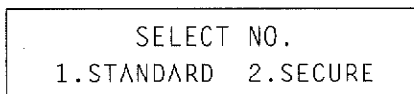

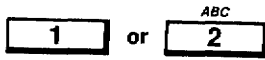

- 3) Press the 1 key if the document for which you are polling is not protected by a secure polling ID code. If it is protected, press the 2 key and enter the polling ID code, as explained in the previous section.

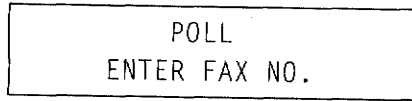

- 4) Press the **TIMER** key and use the number keys to enter the time at which you want polling to take place.

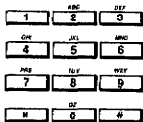
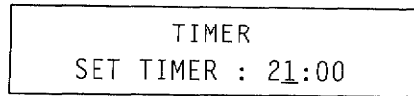

- 5) When you have entered the time (as a 4 digit number), the screen will change briefly.

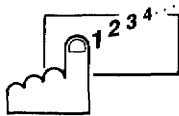
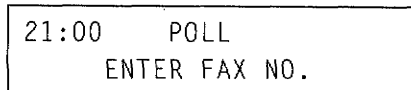

- 6) Enter the fax number of the machine you are polling, either by keying it in using the number keys, a one-touch, speed dial or Telephone Index.

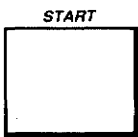
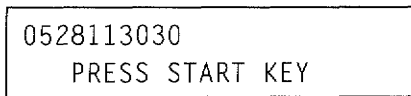

- 7) Press the **START** key. The initial display is restored and the machine can now be used for other tasks

At the time that you specified, your machine will poll for a document from the station whose number you entered.

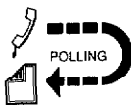

- Only one delayed polling operation can be preset.

V. Advanced Uses

**Turn-around polling**

The following procedure is used to send a fax and poll for a document on the same phone connection.

- 1) Set the document in the feeder.



FAX : ENTER FAX NO.  
COPY : PRESS COPY KEY

- 2) Press the POLLING key.



SELECT NO.  
1. STANDARD 2. SECURE

- 3) Press the 1 key if the document for which you are polling is not protected by a secure polling ID code. If it is protected, press the 2 key and enter the polling ID code, as explained in the section *Secure polling*.

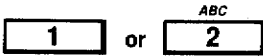

FLIP-FLOP

POLL  
PRESS START KEY

- OR -

POLL  
ENTER FAX NO.

- 4) Enter the fax number of the machine you are polling. You can either key in the number using the number keys, a one-touch, speed dial or Telephone Index.

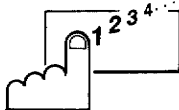

BROTHER MIZUHO  
PRESS START KEY

- 5) Press the START key. Your document is transmitted first.

After your document has been transmitted, your machine polls for a document from the called side.

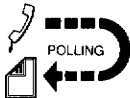
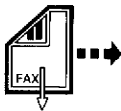
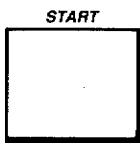

## Sequential Polling

Used to request documents from several different fax units in a single operation.

In the same way that you can send a fax to several destinations in one operation, you can also poll several other stations, requesting fax transmissions. This is known as sequential polling.

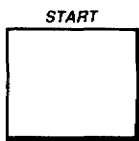
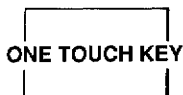
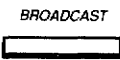
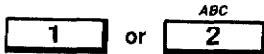

- 1) Make sure there is no document in the feeder.

```
06/01/1992 14:00
FAX/COPY : SET DOC.
```

- 2) Press the **POLLING** key.

```
SELECT NO.
1.STANDARD 2.SECURE
```

- 3) Press the 1 key if the document for which you are polling is not protected by a secure polling ID code. If it is protected, press the 2 key and enter the polling ID code, as explained in the section *Secure polling*.

```
POLL
ENTER FAX NO.
```

- 4) Press the **BROADCAST** key and then specify the destination fax machines which you wish to poll using one-touch, speed, or group keys.

```
*14#25G01
US GROUP
```

- 5) Press the **START** key.

Your machine polls each number or group member in turn for a document. After all the polling operations are finished, the "Sequential Polling Report" will be printed out automatically.

V. Advanced uses

V-8. POLLING

SEQUENTIAL POLLING REPORT						
<p style="text-align: right;">TIME : 06/01/1992 16:21            NAME : BROTHER            FAX : 052-811-5981            TEL : 052-824-2554</p>						
DATE	TIME	FAX NO./NAME	DURATION	PAGE(S)	RESULT	COMMENT
06/01	16:18	FIANCE DEPT	20	01	OK	
06/01	16:19	DESIGN DEPT	20	01	OK	
06/01	16:20	LA OFFICE	16	00	ERROR	A0 11
06/01	16:28	AUSTRALIA OFFCE	00	00	BUSY	

**Setting a document to be polled.**

The steps for setting a document to be polled are shown below.



- 1) Set the document face down in the feeder.

FAX : ENTER FAX NO.  
COPY : PRESS COPY KEY

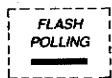

- 2) Press the POLLING key:

SELECT NO.  
1.STANDARD 2.SECURE

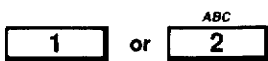

- 3) Press the 1 key to choose standard polling or press the 2 key and enter the 4 digits secure code.

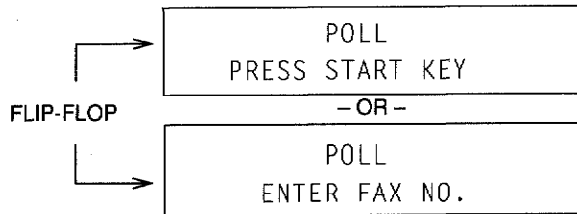

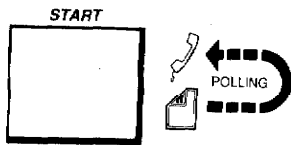

- 4) Press the **START** key. The machine waits for a call from the calling side.  
After a document has been polled, "Polled Report" will be printed out.

POLLED REPORT											
	TIME : 06/01/1992 14:23										
	NAME : BROTHER										
	FAX : 052-811-5981										
	TEL : 052-824-2554										
<table border="1"> <tr> <td>DATE, TIME</td> <td>06/01 14:22</td> </tr> <tr> <td>DURATION</td> <td>00:00:32</td> </tr> <tr> <td>PAGE (S)</td> <td>01</td> </tr> <tr> <td>RESULT</td> <td>OK</td> </tr> <tr> <td>MODE</td> <td>FINE</td> </tr> </table>		DATE, TIME	06/01 14:22	DURATION	00:00:32	PAGE (S)	01	RESULT	OK	MODE	FINE
DATE, TIME	06/01 14:22										
DURATION	00:00:32										
PAGE (S)	01										
RESULT	OK										
MODE	FINE										

- If you select "Secure", the calling side fax machine must be another Brother fax. The calling side must also use the same "secure" code.
- Simply press the **MEMORY** key before pressing the **START** key in order to store a polled document in the machine's memory. Please note that the document will remain in the memory after the calling side has polled for it. This is useful if several stations will poll for same document.
- To delete the document from the memory, press the **Function** key and then press the 9 key "Cancel Transmission".

## 9. SENDING FAXES FROM MEMORY

### Sending a fax from memory

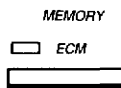

To save time when transmitting a fax you can first store the document in the memory and then transmit it from the machine's memory.

- 1) Set the document face down in the feeder.

FAX : ENTER FAX NO.  
COPY : PRESS COPY KEY

- 2) Press the **MEMORY/ECM** key once. You are prompted to enter the fax number of the destination. The display also informs you what percentage of memory is left for storing your transmission.

If you want to transmit with ECM, press **Memory/ECM** Key three times. (The ECM LED is lit and the percentage of memory remaining is shown on the LCD.)

ENTER FAX NO. 100%

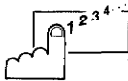

- 3) Enter the destination fax number using the number keys, a one-touch, a speed dial, or a Telephone Index. Press the **START** key. The document is now scanned into memory.

MEMORY 98%

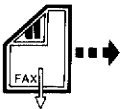

- 4) When all documents have been stored, the unit sends the document from memory automatically.

- You can store up to 15 pages of documents in the FAX2100M, and up to 30 pages of documents in the FAX2200M (Brother standard chart) into memory, but this may vary, depending on the contents of the documents.
- When the memory is full, you can select to either send the stored data out of the memory, or to cancel the transmission.
- If the memory becomes full while the first page of a document is being scanned into memory, the message "MEMORY FULL PRESS STOP KEY" appears on the screen. Press STOP key and cancel the transmission.



**Printing out a  
"Memory used list"**

To view the 'Memory used' list press the FUNCTION key followed by the 4 key on the number keys. Then press the SET key. The screen scrolls through the LIST menu. Now press the 8 key on the number keys (or the CLEAR key if you want to return to the FUNCTIONS menu press). Press the START key to print out the 'Memory used' list (if you do not press any key for one minute, or if you press the STOP key the screen reverts to the normal display). The printout shows details of the following:

**Mailboxes**

The percentage of memory consumed by the confidential mailboxes and the names of the owners.

**Timer**

The percentage of memory consumed by any delayed transmission that has been set up, the destination (if it is a broadcast transmission the word "BROADCAST" appears), the time at which it is due to be sent and whether it is to be sent in ECM mode.

**Polling**

The percentage of memory consumed by any polled operation that has been set up and whether the polling is to use ECM mode.

**Redialing**

The percentage of memory consumed by the 'last number redial' facility, the number itself and, in the event of redialing, whether the transmission is to use ECM mode.

**ECM**

The percentage of memory consumed by the ECM function.

**Free space**

The percentage of memory that is unused.

If you press the STOP key while the 'Memory used' list is being printed, the printout is aborted and the screen returns to the normal display.

V-9. SENDING FAXES FROM MEMORY

---

MEMORY USED LIST

TIME : 06/01/1992 18:23  
NAME : BROTHER  
FAX : 052-811-5981  
TEL : 052-824-2554

CONF.MAIL BOX	: JOHN SMITH	06%
	: MARY	06%
TIMER	<ECM> : 18:00 HEAD QTR	04%
	: 13:15 0528242864	04%
	<ECM> : 23:45 <BROADCAST>	04%
POLLING WAITING	<ECM>	04%
REDIAL WAITING	: UK OFFICE	06%
ECM		24%
FREE		42%

## 10. SENDING FAXES WITH THE ECM FEATURE

Error correction mode (ECM) is a means for checking the integrity of a fax transmission while it is in progress. ECM transmissions are only possible between two machines which both have the ECM feature. Also, the feature requires a certain amount of memory in order to function.

To send a document in ECM mode set the document in the paper feed.

FAX : ENTER FAX NO.  
COPY : PRESS COPY KEY

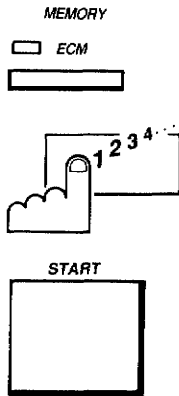

Press the MEMORY/ECM key to light the ECM LED and dial the number of the destination. You can dial using the number keys or use one-touch dialing, speed dialing or the Telephone Index.

Finally, press the START key to send the fax. As the document is sent, the transmitting and receiving machines will constantly check the transmission. If an error occurs, the erroneous part of the transmission is automatically ignored and the relevant data retransmitted. The ECM LED remains on during transmission to indicate that the fax is being sent in ECM mode.

If there is not enough machine memory available for ECM to work properly, or if the receiving fax machine does not have the ECM feature, the document is sent normally, that is, without any error correction. In these two cases the ECM LED does not remain on during the transmission - this indicates that the fax is not being transmitted in ECM mode.

- *Since the units are constantly checking the data and may have to retransmit some of the lines, there maybe a slight increase in transmission time.*

## 11. BROADCASTING

A broadcast transmission is a transmission that you send to several different destinations with a single operation. You simply set your document face down in the document feeder, press the BROADCAST key, specify the destinations and then send the fax just like any normal transmission.

### Sending a broadcast fax



- 1) Set the document face down in the feeder.

FAX : ENTER FAX NO.  
 COPY : PRESS COPY KEY

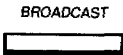

- 2) Press the BROADCAST key.

BROADCAST  
 ENTER FAX NO. 100%



- 3) Now specify the destinations, to a maximum of 20 destinations, that you wish to broadcast to using group keys, one-touch keys, or speed dial keys. (You cannot dial numbers using the number keys or the Telephone Index).



The name of each destination or group appears on the lower line of the screen as you enter it. The one-touch numbers, speed dial numbers or group numbers that you have selected appear on the upper line. Press cursor key to lock in each selection.

\*01#10G03  
 DUTCH OFFICES

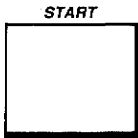

- 4) When you have finished entering the destinations press the START key. The fax is scanned into the machine's memory automatically and then transmitted to each destination in turn.

MEMORY 100%

- *Transmission is not possible if the memory is nearly full.*
- *It is convenient to register stations to which you frequently send broadcast faxes as a group . (See Defining and storing a group).*

- You can specify up to 20 numbers as destinations for a single broadcast fax. A group counts as a single destination. Including all group members, you can transmit a broadcast fax up to 159 stations for FAX2200M and 129 stations for 2100M.
- After the broadcast key has been pressed, the only operation which can be performed is setting the fax number.

After finished all transmission, a "Broadcast Report" will be printed out automatically.

<div style="border: 1px solid black; display: inline-block; padding: 5px;">BROADCAST REPORT</div>									
TIME : 06/01/1992 15:16 NAME : BROTHER FAX : 052-811-5981 TEL : 052-824-2554									
<table border="1" style="width: 100%; border-collapse: collapse;"> <tr> <td style="width: 50%;">PAGE(S)</td> <td style="width: 20%;">01</td> <td style="width: 30%;">COVERPAGE</td> </tr> </table>							PAGE(S)	01	COVERPAGE
PAGE(S)	01	COVERPAGE							
DATE	TIME	FAX NO./NAME	DURATION	PAGE(S)	RESULT	COMMENT			
06/01	15:12	FIANCE DEPT	45	01 CV	OK				
06/01	15:13	DESIGN DEPT	45	01 CV	OK				
06/01	15:15	LA OFFICE	51	00 CV	ERROR	20 01			
06/01	15:16	AUSTRALIA OFFCE	06	00	CANCEL				
CV : COVERPAGE      CA : CALL BACK MSG POL : POLLING      RET : RETRIEVAL									

V. Advanced uses

## 12. RELAY BROADCASTING

You can send a broadcast fax transmission via another Brother fax machine. The purpose of this feature is to enable you to reduce costs by faxing several distant stations via a single station which is closer to the destinations. This is particularly useful for broadcasting overseas.

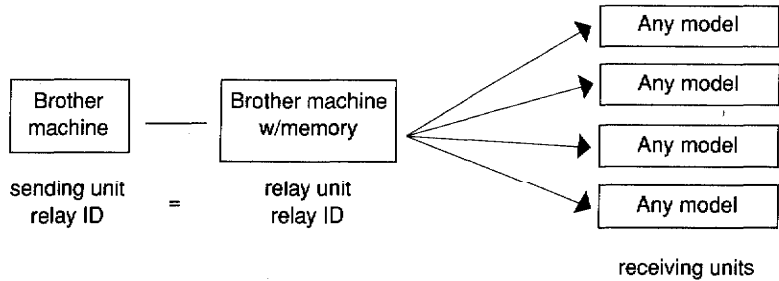

Relay broadcasting is available under the following conditions:

- The same relay ID must be used by both the sending unit and relay unit.
- The destination group on your machine and that used by the relay unit must be identical (that is, have the same members). Otherwise the relay unit may send the document to a station for which the document was not intended.
- The memory in the relay unit must not become full during the transmission operation.

### Sending a relay broadcast request

To send a relay broadcast fax the procedure is as follows.

- 1) Set your document face down in the document feeder.



FAX : ENTER FAX NO.  
COPY : PRESS COPY KEY

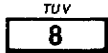

- 2) Press the **FUNCTION** key followed by the **8** key.

8.RELAY BROADCAST  
PRESS SET KEY

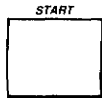
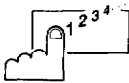
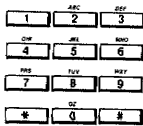
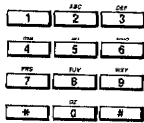

3) Press the SET key.

RELAY ID : XXXX  
ENTER CODE NO.

4) Enter a four-digit ID number, then press the SET key.

RELAY BROADCAST  
ENTER GROUP NO.

5) Now enter the number of the group which you want the relay terminal to broadcast to. You must enter the group as a two-digit number using the number keys. (Do not use the group's one-touch dial key.)

GROUP 01  
PRESS SET KEY

6) When you have entered the group number correctly, press the SET key.

RELAY BROADCAST  
ENTER FAX NO.

7) Now enter the fax number of the relay terminal. You can either enter the number manually from the number keys or use a one-touch, speed dial or Telephone Index. Then press the START key.

**Using Your Machine as the Relay Unit**

Your machine can be used as a relay unit for sending broadcast transmissions to several other destinations. As this is an automatic operation, simply leave your machine in the Auto Ans. mode, and the unit will dial and send the fax to the numbers included in the group specified at the point of origin.

When your machine is used as the relay unit during relay broadcasting, a Relay Broadcast Report will appear at your unit (not at the original sending unit, which receives an activity report) to show the results of the relay transmissions after all transmission attempts have been completed.

**Registration of relay ID**

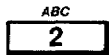

1) Press the FUNCTION key. Then press the 2 key.

2. REGISTRATION  
PRESS SET KEY

V. Advanced uses





# 13. CONFIDENTIAL MAILBOXES

You can allocate three confidential mailboxes to individuals or groups of individuals, so that each individual or group can receive private messages. These are not printed out when they are received but are stored in the memory. Only the person or people who know the mailbox retrieval ID number can print out these transmissions. A single mailbox can store several transmissions. Messages remain in the mailbox until you print them out or until the machine is turned off. Both fax units must be Brother machines.

## Registering a confidential mailbox

A mailbox must have assigned to it a confidential identification ID number, a retrieval ID and a name. To transmit to a mailbox the person sending the transmission must quote the confidential ID number. To retrieve a document from his mailbox the owner must enter the retrieval ID. The name is used for the "Confidential Message Information" which informs the owner that a confidential message is waiting for him.

To set up a confidential mailbox the procedure is as follows.

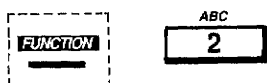

1) Press the **FUNCTION** key. Press the **2** key.

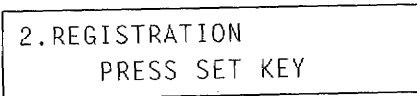

2) Press the **SET** key.



3) Press the **0** key followed by the **8** key.

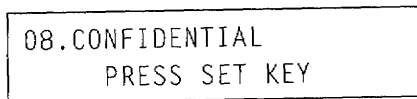

4) Press the **SET** key.

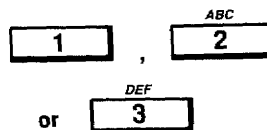
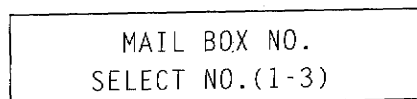

5) Select the number of the mailbox (1 - 3) that you want to set up.

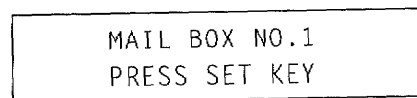

V. Advanced uses



6) Press the SET key.

RETRIEVAL ID : XXXX  
INPUT / PRESS SET TO END

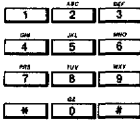

7) Enter a four-digit retrieval ID number using the number keys.

RETRIEVAL ID : 4572  
INPUT / PRESS SET TO END



8) Press the SET key to confirm your setting.

CONF. ID : 0000  
INPUT / PRESS SET TO END



9) Now enter a four-digit confidential mailbox ID number using the number keys.

CONF. ID : 8423  
INPUT / PRESS SET TO END



10) Press the SET key to confirm your setting.

NAME:             
INPUT / PRESS SET TO END



11) Enter the name you wish to assign to your mailbox using the number keys. The name can be up to twenty characters long. Press the SET key to confirm your setting.



- *If the memory is full, it cannot receive confidential messages.*
- *When you are setting up the confidential mailbox, be sure to write the name and IDs down, and keep the information somewhere safe.*
- *You must enter different codes for each of the three mail boxes. If a code number has already been used for another mail box ID, the machine will reject the code number and you must use another one.*

**Changing the mail box ID**

If you want to change the mailbox name or ID, carry out the following procedure.



1) Press the FUNCTION key. Then press the 2 key.

2.REGISTRATION  
PRESS SET KEY

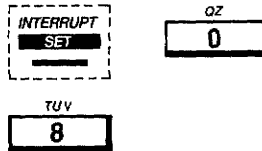

2) Press the SET key. Then press the 0 key followed by the 8 key.

08.CONFIDENTIAL  
PRESS SET KEY



3) Press the SET key.

MAIL BOX NO.  
SELECT NO.(1-3)

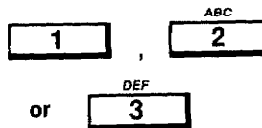

4) Enter the mail box number which you want to change.

MAIL BOX NO.1  
PRESS SET KEY



5) Press the SET key.

RETRIEVAL ID  
CHANGE ? 1.YES 2.NO



6) Press the 1 key to change.

RETRIEVAL ID : XXXX  
ENTER CODE NO.

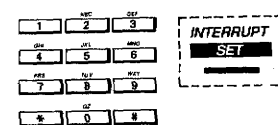

7) Enter the retrieval ID of the mail box which is to be registered then press SET Key. (This is to prevent interference with the mailbox by other people.)

8) Current retrieval ID number will appear on the display.

RETRIEVAL ID : 4572  
INPUT / PRESS SET TO END

V. Advanced uses

## V-13. CONFIDENTIAL MAILBOXES

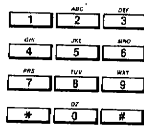

- 9) Enter a new number (or press **SET** if you do not wish to change retrieval ID).

RETRIEVAL ID : 8224  
INPUT / PRESS SET TO END



- 10) Press **SET**. The current confidential mailbox ID number will appear on the display.

CONF. ID : 8423  
INPUT / PRESS SET TO END



- 11) Enter a new number (or press **SET** if you do not wish to change conf. ID).

CONF. ID : 5996  
INPUT / PRESS SET TO END

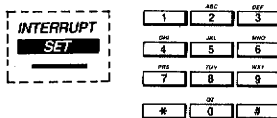

- 12) Press **SET**. Enter a new name (or press **SET** if you do not wish to change name) with using the number keys. When finished, press **SET**.

NAME : BROTHER  
INPUT / PRESS SET TO END

### Printing out confidential information



To check whether the machine has received a confidential message or not, you can print out a report on Confidential Message Information currently stored in the unit.

- 1) Make sure there is no document in the feeder.
- 2) Press **MAIL** key.

CONF. MESSAGE INFO.  
PRESS START KEY

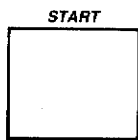

- 3) Press **START** key.

If you are the owner of a mail box and there is a message in it for you, the unit will print out a sheet alerting you that a message has been received.

CONFIDENTIAL MESSAGE INFORMATION

TIME : 06/01/1992 18:34  
NAME : BROTHER  
FAX : 052-811-5981  
TEL : 052-824-2554

\* PLEASE PASS THIS MESSAGE TO FOLLOWING PERSON

TO: JOHN SMITH

A CONFIDENTIAL MESSAGE HAS BEEN RECEIVED FOR YOU.  
PLEASE PRINT IT OUT FROM MEMORY.THANK YOU.

*You can also get this information from a "Memory Used List" (see page V-9-2).*

### Printing out a confidential message

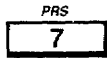

- 1) To retrieve your message, press the **FUNCTION** key followed by the 7 key.

7. CONFIDENTIAL MAIL BOX  
PRESS SET KEY



- 2) Press the **SET** key.

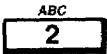

- 3) Press the **2** key.

2. CONF. PRINT OUT  
PRESS SET KEY



- 4) Press the **SET** key.

RETRIEVAL ID : XXXX  
ENTER CODE NO.

V. Advanced uses

## V-13. CONFIDENTIAL MAILBOXES

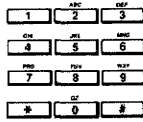

- 5) Enter the retrieval ID code for your mailbox.

RETRIEVAL ID : 6349  
PRESS SET KEY

- 6) When you have entered the number press the SET key. The confidential message is printed out for you.

CONF. MESSAGE  
PRINTING

After printing the screen reverts to displaying the normal message.

- *If you specify an incorrect retrieval ID, the confidential message will not be printed out. Also, after three attempts to make an entry have failed, the screen will return to the Function menu.*
- *Messages remain in a mailbox until printed out or until the machine is turned off.*

### Transmitting to a mailbox

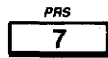

- 1) Set the document face down in the feeder, and press the FUNCTION key. Press the 7 key.

7. CONFIDENTIAL MAIL BOX  
PRESS SET KEY



- 2) Press the SET key.

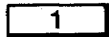

- 3) Press the 1 key.

1. CONF. TRANSMIT  
PRESS SET KEY



- 4) Press the SET key.

CONF. ID : XXXX  
ENTER CODE NO.

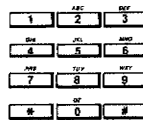

- 5) Enter the ID code for the mailbox on the destination machine to which you want to transmit your document.

CONF. ID : 6535  
PRESS SET KEY

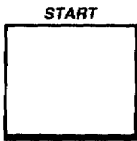
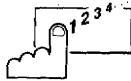

6) When you have entered the number press the SET key. Enter the fax number of the destination to which you are sending and press START.

- *If the confidential mail box ID does not match the confidential ID of the party to whom you wish to transmit, you can not send a confidential message.*

### Retrieving confidential messages

If you are the owner of a mailbox but you are away from the machine at a different office, you can still retrieve messages from your mailbox and print them out using another InstaFAX2200M or InstaFAX2100M (or certain other models of Brother fax machine).

Use the following procedure to remotely retrieve a confidential message using a InstaFAX2200M or InstaFAX2100M.

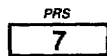

1) Press the FUNCTION key followed by the 7 key.

7.CONFIDENTIAL MAIL BOX  
PRESS SET KEY



2) Press the SET key.

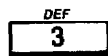

3) Press the 3 key.

3.REMOTE RETRIEVAL  
PRESS SET KEY



4) Press the SET key.

RETRIEVAL ID : XXXX  
ENTER CODE NO.



5) Enter the retrieval ID code for your mailbox.

RETRIEVAL ID : 6349  
PRESS SET KEY

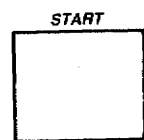
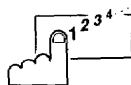

6) When you have entered the number correctly press the SET key. Now dial the fax number of your own machine, the one on which your mailbox resides, and press the START key.

V. Advanced Uses

V-13. CONFIDENTIAL MAILBOXES

---

The transmission that was waiting for you in your mailbox will now be printed out for you, at the station where you are now.

A retrieval report will be printed out at the machine on which your mailbox resides.

RETRIEVAL REPORT

TIME : 06/01/1992 13:44

NAME : BROTHER

FAX : 052-811-5981

TEL : 052-824-2554

DATE, TIME	06/01 13:42
DURATION	00:01:58
PAGE(S)	05
RESULT	OK
MODE	FINE



# 14. LOGO REGISTRATION

You can register your original logo for inclusion on the COVERPAGE, CALL BACK MESSAGE and on all reports and lists.

First of all, you should prepare a logo sheet with the following format.

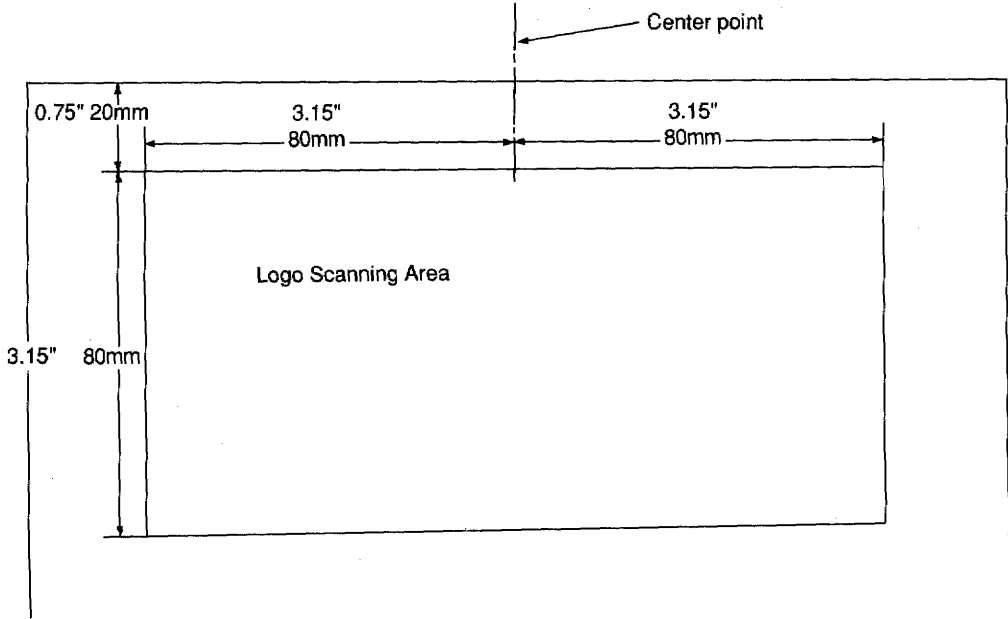

- 1) In the logo scanning area, you should place your logo.
- 2) Place the logo sheet face down in the feeder.

V. Advanced Uses

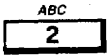

- 3) Press the FUNCTION key, then press the 2 key.



- 4) Press the SET key. Now press the 1 key followed by the 2 key.

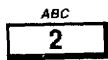

- 5) Press the SET key.



## V-14. LOGO REGISTRATION

---

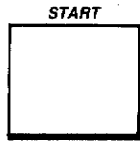

6) Now press the START key. The machine scans the logo sheet.



7) Having scanned the logo, the machine now prints it out.



### Example

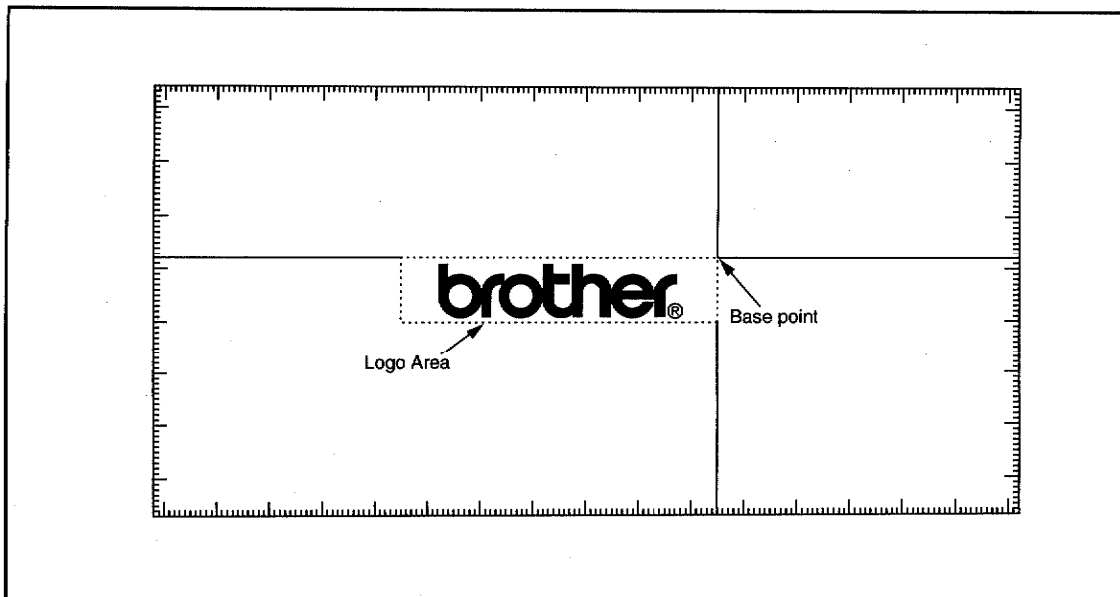

#### Note:

*On the print out you will get your logo, the logo area, and a scale with graduated steps. You must now move the logo area until it completely encompasses your logo.*

*If your logo is larger than the logo area, the logo area can be made slightly larger to a maximum of 1.5" in height and 3.15" in width. (See instructions following.)*

Example of move

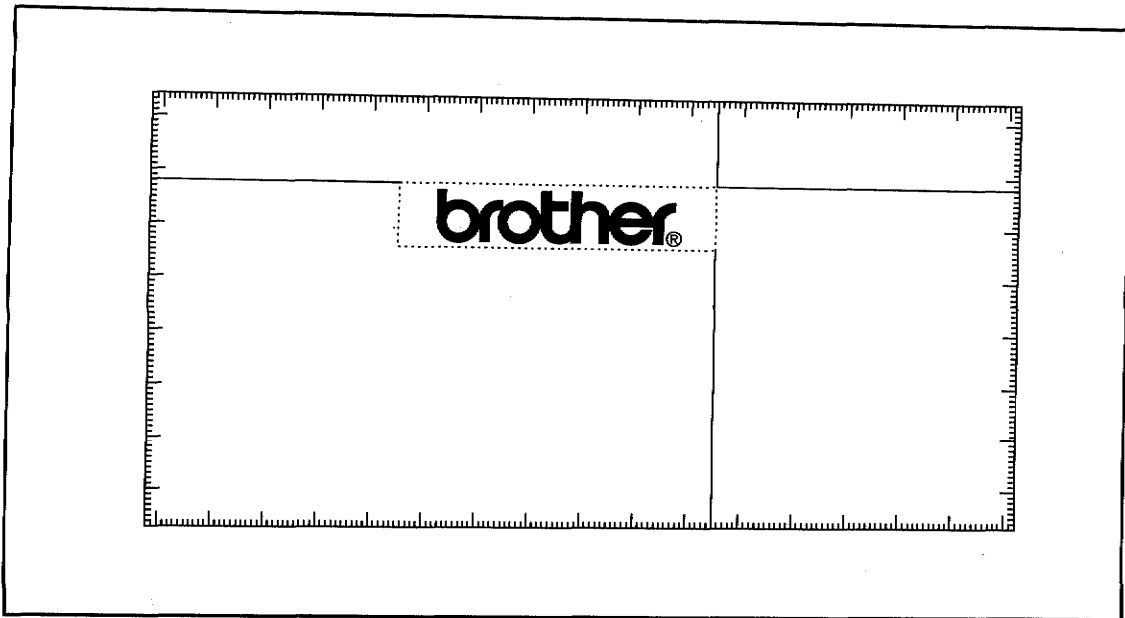

LOGO AREA  
1.FIX 2.MOVE



- 1) Press the 1 key when your logo is positioned in the Area, or the 2 key if you need to move the logo area. If you press the 1 key, the logo is registered in the machine. If you press the 2 key, the screen changes as follows.

MOVE LEFT RIGHT 00STEPS  
SET DIRECTION



- 2) Select the horizontal direction "Left" or "Right" using (←/→) cursor key, then press the SET key.



MOVE RIGHT 99STEPS  
INPUT NUMBER OF STEPS

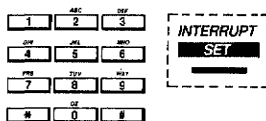

- 3) Enter the distance to be moved by counting the number of steps on the graduated scale. Use the number keypad to enter the steps.

If you do not want to alter the logo area's horizontal position, there is no need to enter a number. Press the SET key.

MOVE UP DOWN 00STEPS  
SET DIRECTION

V. Advanced uses

V-14. LOGO REGISTRATION

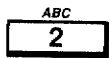
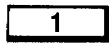

- 4) Select the vertical direction "UP" or "DOWN" using the (←/→) keys, then press the SET key.

```
MOVE      DOWN  00STEPS
INPUT NUMBER OF STEPS
```

- 5) Enter the distance to be moved by counting the number of steps on the graduated scale. Use the number keypad to enter the steps. If you do not want to alter the logo area's vertical position, there is no need to enter a number. Press the SET key.

```
MOVE      DOWN  99STEPS
INPUT NUMBER OF STEPS
```

```
ENLARGE LOGO AREA ?
1.YES  2.NO
```

- 6) If you select the 1 key to enlarge the logo area then you should go to the section below. If you select the 2 key for no enlargement then you will print out the logo again. (go to step 9)

```
ENLARGE  WIDTH  00STEPS
INPUT NUMBER OF STEPS
```

- 7) Enter the number of steps that you need to enlarge the width of the logo area, so it will cover your logo. If you do not want to enlarge, do not enter any number. Press the SET key.

```
ENLARGE  HEIGHT  00STEPS
INPUT NUMBER OF STEPS
```

- 8) Enter the number of steps that you need to enlarge the height of the logo area, so it will cover your logo. If you do not want to enlarge, do not enter any numbers. Press the SET key.

```
LOGO AREA
PRINTING
```

- 9) Again the machine prints out the logo and again asks you whether you want to move the logo area.

```
LOGO AREA
1.FIX  2.MOVE
```



- 10) If you are satisfied with the logo's position, press the 1 key. If you want to move it again, press the 2 key and repeat the process above. If you press the 1 key, the screen changes as follows.

LOGO  
REGISTERING

- 11) The logo is registered in the machine's memory and then printed out.

LOGO  
PRINTING

### Sample



### Note:

- *Enabling or disabling the logo*  
When you have registered a logo, the machine automatically puts it on the COVERPAGE, Call Back Message and on all reports and lists.  
If you do not want it to appear, you can turn the function off as follows. Press the FUNCTION key and the 5 key to display the "User switch" menu options. Now press the SET key followed by the 0 key and the 9 key. Press the 1 key if you want the logo to appear, the 2 key if you do not. Press the SET key to confirm your selection.
- *Some types of logo cannot be scanned into the machine. At that time, you should try to reduce your logo by photocopying and try this procedure again.*
- *When there is not enough memory capacity to register a logo, the screen displays as "MEMORY FULL", and you can not register the logo.*  
*In this case, you should print out "Memory used list" and erase unnecessary registrations.*

## 15. VARIOUS TYPES OF TRANSMISSION

As described in "Advanced Uses", this unit has many useful dedicated keys. Various types of transmissions can be carried out by pressing these keys in combination.

A Summary of "Advanced uses" is provided bellow.

- The following dedicated keys are available for all transmissions.



- The following key is not available for delayed and broadcasting transmission operation.



- The following key is not available for polling with no document and retrieval.



- The following keys are available for the various types of transmissions listed below.

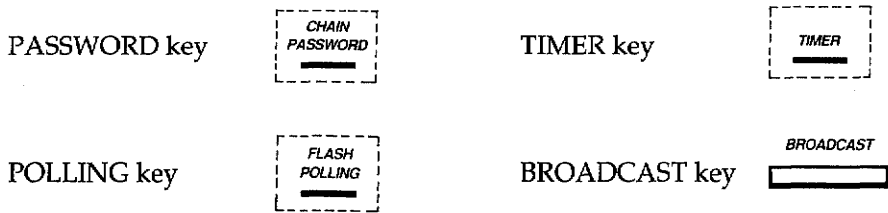

(1) Timer (delayed) transmission with password

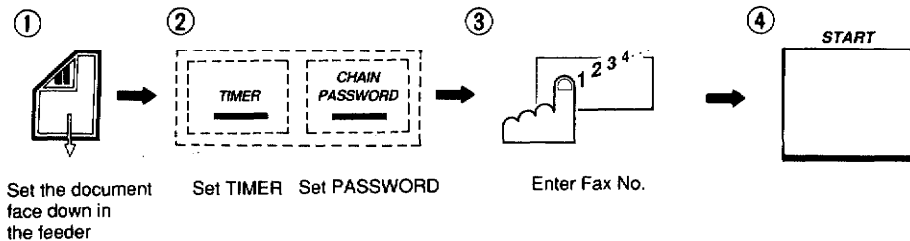

(2) Timer (delayed) polling

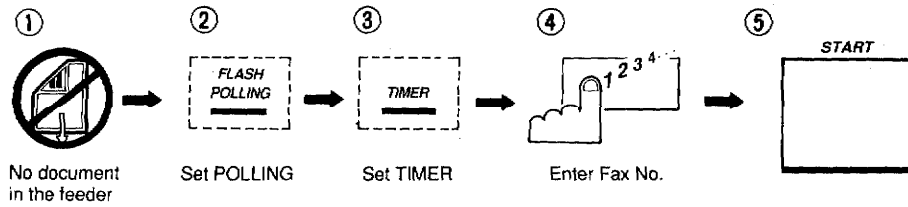

(3) Turn around polling with password

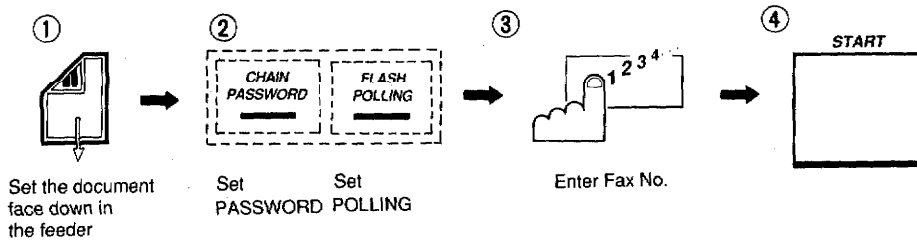

(4) Timer (delayed) turn around polling with password

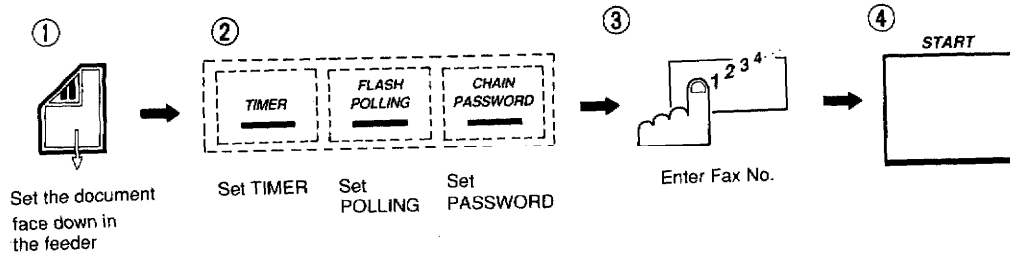

(5) Timer (delayed) broadcasting transmission

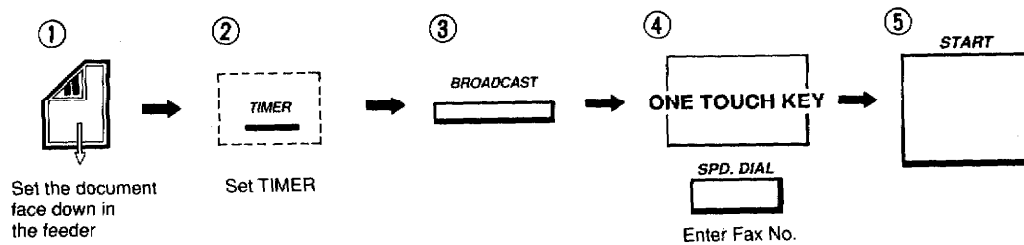

V. Advanced  
USES

(6) Sequential polling

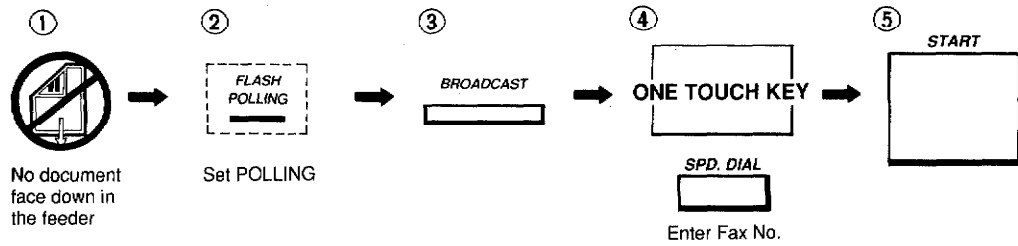

(7) Broadcasting transmission with password

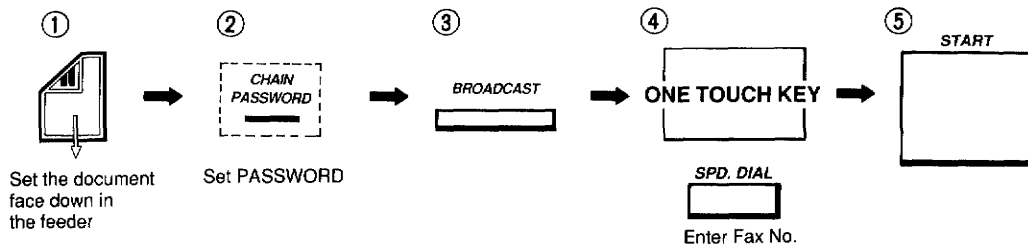

(8) Timer (delayed) broadcasting transmission with password

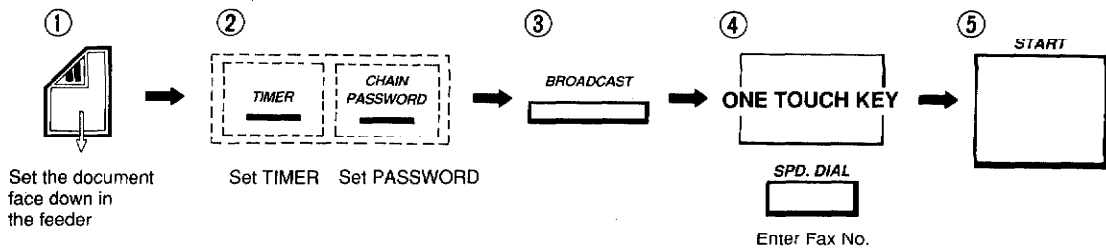

(9) Timer (delayed) sequential polling

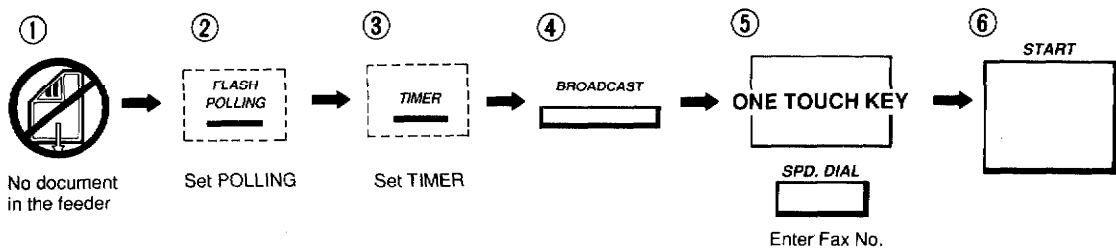



# 16. INTERRUPTING A TRANSMISSION

If you need to send a document immediately but the machine is set up to perform an operation, (for example a delayed transmission or waiting polled operation without memory). You can interrupt the current activity and then resume it when you have sent your urgent fax.



1) Press the INTERRUPT key.

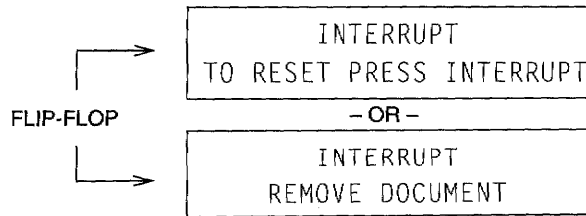

2) Remove the document.

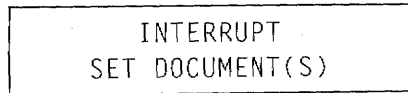

3) Set the document that you need to send quickly face down in the feeder.

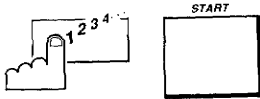
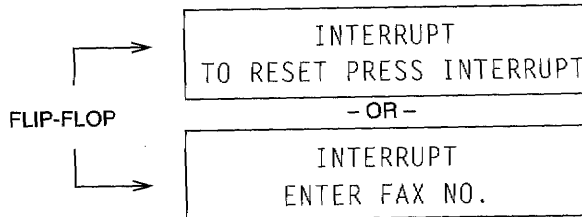

4) Enter a fax number. Then press the START key. The machine will send the document.

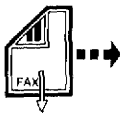

5) When transmission has been completed the following message is displayed.

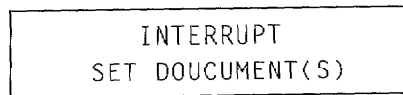

6) Replace the original document.

V. Advanced Uses

## V-16. INTERRUPTING A TRANSMISSION

---

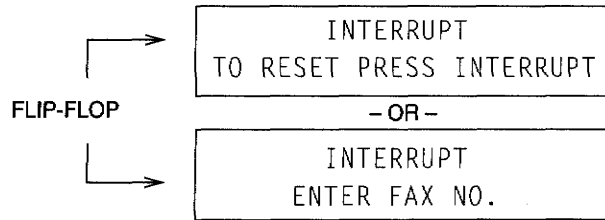

7) Press the **INTERRUPT** key again. The machine returns to the waiting mode.

- *You can repeat the interrupt operation as often as you like.*
- *You can use the resolution setting and super COVERPAGE. Other current settings can not be used for the interrupt transmission.*
- *Even if auto redial is "ON", it cannot be used for an interrupt transmission.*

# 17. CANCELLING A TRANSMISSION

You may wish to cancel a particular activity that is in progress or that is due to take place at a specified time. An example of this would be a delayed transmission operation.

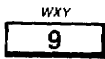

1) To do this press the **FUNCTION** key. Press the **9** key on the number keys.

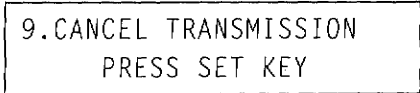

2) Press the **SET** key. The screen now displays the various transmission activities that are currently in progress or will take place in the future.

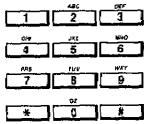
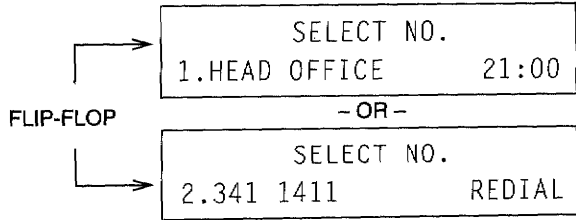

3) Select number of operation that you wish to cancel.

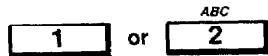
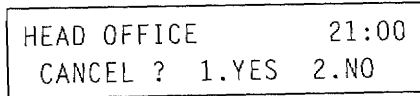

4) Enter the **1** key to confirm cancellation or the **2** key to reinstate the transmission activity.

The meaning of the different LCD indications is as follows.

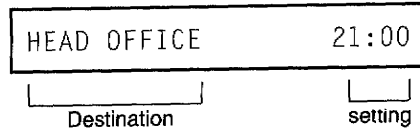

- Destination Name ..... Means Destination Name
- Number .... Means Destination Number
- Broadcast .. Means broadcast transmission

V. Advanced uses

V-17. CANCELLING A TRANSMISSION

---

Setting 00:00 .....Means "Timer" transmission time. If using the "Timer", the current setting will appear "00:00 (setting time)"  
POLL.....Means "Polling" not "Timer".  
RET.....Means "Retrieval"  
REDIAL .....Means "Redial" without "Timer", "Polling" or "Retrieval".  
POLLED .....Means "Polled"

If the broadcast transmission is cancelled, a "broadcasting report" will be printed out.

## 18. OPTIONAL KITS

You can expand further your fax machine with the following optional kits.

- **Expandable Memory.**

You can expand the machine's memory by 256KB or 512KB bringing the memory capacity up to 512KB or 768KB in the FAX-2100M, and up to 768KB or 1MB in the FAX-2200M.

- **Transmission document tray (CT-91)**

An additional tray is available for catching the transmitted documents.

- **P.P.I.**

The P.P.I (Plain Paper Interface) kit allows you to receive a transmission and print it out on plain paper by connecting your machine and your Brother "V-series" laserprinter.

When you connect the FAX machine to the laserprinter, the printer selects FAX RECEIVE mode automatically. From then on the printer automatically selects the right mode according to whether it is receiving a fax transmission, data from a computer or copy function.

- **Paper-6895**

Brother "Therma PLUS" (164' x 8 1/2")

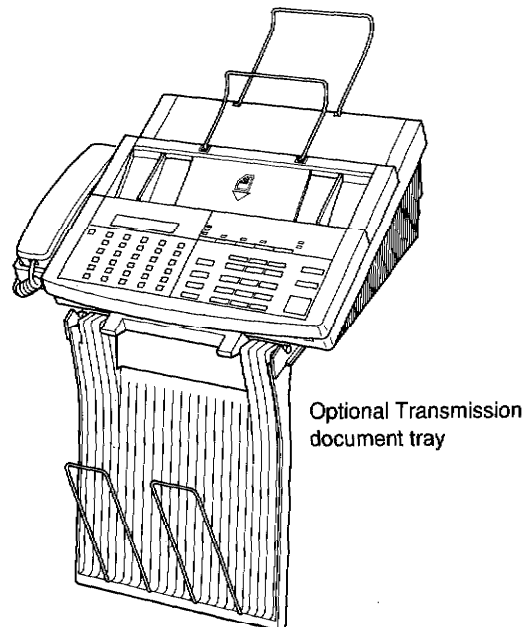

For detailed information, please contact your dealer or the store where you bought this machine.

V-18-1

## 19. PRINTING OUT REPORTS AND LISTS

The unit allows you to print out the following lists and reports.

- All dial lists (Print out one-touch dial and speed dial at once.)
- One-touch dial list (see IV-4-4)
- Speed dial list (see IV-5-2)
- Telephone Index list (see IV-7-2)
- super COVERPAGE format (see V-4-2)
- Call Back Message format (see V-5-2)
- System Configuration list (see V-19-2)
- Memory used list (see V-9-2)
- Transmission verification report (see IV-1-12)

### Other reports

The following reports are printed out automatically for your information. (You cannot print them out manually.)

- Transmission Verification Report (ERROR) (see IV-2-1)
- Power failure report (see V-19-4)
- Polled report (see V-8-7)
- Broadcast report (see V-11-2)
- Delayed sending report (see V-6-2)
- Relay broadcast report (see V-12-3)
- Sequential polling report (see V-8-6)
- Retrieval report (see V-14-7)

### All-dial list

An all-dial list is a printout both of "one-touch dial list" and "speed dial list" at once.



1) Press the FUNCTION key. Then press the 4 key.

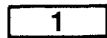
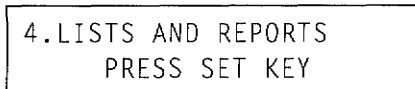

2) Press the SET key and then the 1 key.

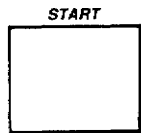

3) Press the START key. Both one-touch dial list and speed dial list are printed out.

### Configuration list

A configuration list is a printout showing all the user switch settings and registration into the machine.

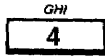

- 1) To print out a configuration list press the **FUNCTION** key. Press the 4 key.

4. LISTS AND REPORTS  
PRESS SET KEY

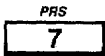

- 2) Press the **SET** key followed by the 7 key.

7. USER OPTIONS  
PRESS START KEY

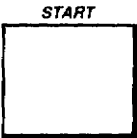

- 3) Press the **START** key.

(See next page for the sample of this list)

SYSTEM CONFIGURATION LIST

TIME : 06/01/1992 18:11

NAME : BROTHER

FAX : 052-811-5981

TEL : 052-824-2554

\*\*\*USER OPTIONS\*\*\*

1.	RING DELAY	: SHORTER
2.	TONE/PULSE	: TONE
3.	AUTO REDIAL	: ON
4.	XMT VERIFICATION (OK) REPORT	: ON
5.	FAX/TEL RING TIME	: 10 SECS.
6.	BEEPER	: ON
7.	RECEIVE PASSWORD	: OFF
8.	SMOOTHING	: OFF
10.	LOGO	: ON
11.	P.P.I. OUTPUT	: OFF
12.	P.P.I. REDUCTION	: AUTO

\*\*PARAMETER\*\*

1.	COVER PAGE COMMENT	
	5	: ORDER COFIRMATION
	6	: NOT USED
2.	INITIAL TIME	: 19:00
3.	FAX/TEL SWITCH ID	
	FAX REMOTE ACTIVATION ID	: *#
4.	RTI/TTI	
	NAME	: BROTHER
	FAX	: 052-811-5981
	TEL	: 052-824-2554
5.	RECEIVE PASSWORD	: 1234
6.	RELAY ID	: 3456
7.	CONFIDENTIAL MAIL ID	
	BOX 1	: JOHN SMITH
	BOX 2	: MARY
	BOX 3	: NOT USED
8.	ACTIVITY REPORT INTERVAL	
	BASE TIME	: 00:00
	INTERVAL	: 12H



**Power Failure Report**

If the power failure has occurred, or you unplug the unit, a "Power Failure Report" will be printed out automatically, and you will know what memory has been lost.

POWER FAILURE REPORT

TIME : 06/01/1992 11:10

NAME : BROTHER

FAX : 052-811-5981

TEL : 052-824-2554

THE ELECTRICITY FAILED.

THE FOLLOWING DATA WAS LOST

ACTIVITY REPORT

TRANSMISSION MEMORY

RECEPTION MEMORY

Downloaded from [www.somanuals.com](http://www.somanuals.com) on 11/11/2014 10:11:11 AM

# VI. Troubleshooting

This section provides possible solutions to the problems you may encounter in the use of this machine.

## -If There Are Image Quality Problems-

If you are having trouble with the image quality of faxes you send or receive, make a test copy of the document. If the copy is of good quality, the problem is not with your fax machine, but in the phone lines or in the fax machine on the other end of the line.

If the image of the copy you make is poor, clean the interior of the unit. (See page VII-2 for a description of how to do this.)

If you are not able to solve a problem with your fax machine, contact Brother service personnel at 1-800-284-4FAX. (U.S.A. Only).

## RECEIVING

SYMPTOM	POSSIBLE CAUSE	ACTION	Ref.
Manual reception doesn't work	<ul style="list-style-type: none"> <li>• Document left in feeder</li> <li>• Cover not closed properly</li> <li>• No recording paper</li> <li>• Paper jammed in the recording section</li> </ul>	<ul style="list-style-type: none"> <li>• Remove the document</li> <li>• Push cover closed until you hear a click</li> <li>• Load new paper roll</li> <li>• Remove the jammed paper</li> </ul>	III-5-1 VI-5
Recording paper is jammed	<ul style="list-style-type: none"> <li>• Recording paper is set incorrectly</li> <li>• Paper jammed in the recording section</li> </ul>	<ul style="list-style-type: none"> <li>• Reload paper roll correctly</li> <li>• Remove the jammed paper</li> </ul>	III-5-1 VI-5
Received copies are blank	<ul style="list-style-type: none"> <li>• Recording paper roll has been inserted upside down</li> <li>• Documents were not sent correctly</li> </ul>	<ul style="list-style-type: none"> <li>• Reload the paper roll correctly</li> <li>• Contact the sender</li> </ul>	III-5-1
Telephone rings continuously	<ul style="list-style-type: none"> <li>• No recording paper</li> <li>• Auto Answer is OFF</li> <li>• Cover not closed properly</li> <li>• Paper jammed in the recording section</li> </ul>	<ul style="list-style-type: none"> <li>• Load new paper roll</li> <li>• Turn Auto Answer to ON</li> <li>• Push cover closed until you hear a click</li> <li>• Remove the jammed paper</li> </ul>	III-5-1 IV-1-7  VI-5
Image quality is not good	<ul style="list-style-type: none"> <li>• Wrong type of recording paper is used</li> <li>• Printing head is dirty</li> <li>• Sender's resolution or contrast setting may need adjustment</li> </ul>	<ul style="list-style-type: none"> <li>• Replace with Brother thermal printing paper</li> <li>• Clean the printing head</li> <li>• Contact the sender</li> </ul>	VII-2
Polling reception does not work	<ul style="list-style-type: none"> <li>• Sender has not set up to perform polling</li> <li>• Polling security codes do not match</li> <li>• Sender is not using a Brother series machine</li> </ul>	<ul style="list-style-type: none"> <li>• Contact the sender to be sure he has set up for polling</li> <li>• Contact the sender to confirm the code being used</li> <li>• Contact the sender to confirm the machine being used</li> </ul>	

SENDING

**SENDING**

SYMPTOM	POSSIBLE CAUSE	ACTION	Ref.
Document jam	<ul style="list-style-type: none"> <li>• Jam in the scanning section</li> </ul>	<ul style="list-style-type: none"> <li>• Open the panel cover and remove the jammed paper. Close the cover (and listen for the click).</li> </ul>	
Document not feeding properly	<ul style="list-style-type: none"> <li>• Cover not closed securely</li> <li>• Document is too thick or thin, too small, wet, wrinkled, curled or torn</li> <li>• Document guide not adjusted to document size</li> <li>• More than 30 pages of documents in the feeder</li> </ul>	<ul style="list-style-type: none"> <li>• Push the panel cover closed until you hear a click</li> <li>• Use a photocopier to make a copy, then send the copy</li> <li>• Adjust the document guide to fit the document size</li> <li>• Set only 30 pages of the document in the feeder at one time</li> </ul>	
Documents are impossible to feed	<ul style="list-style-type: none"> <li>• Documents have been inserted in the position for recording paper output</li> </ul>	<ul style="list-style-type: none"> <li>• Insert the documents into the transmission document wire extension</li> </ul>	III-8-1
Password transmission error	<ul style="list-style-type: none"> <li>• Password function on receiving end is OFF</li> <li>• Passwords do not match</li> <li>• Receiving unit has no password function</li> <li>• Receiving unit is not a Brother series machine</li> </ul>	<ul style="list-style-type: none"> <li>• Contact the receiver</li> <li>• Contact the receiver to confirm the code being used</li> <li>• Contact the receiver</li> <li>• Contact the receiver to confirm the machine being used</li> </ul>	
Image quality of document is poor	<ul style="list-style-type: none"> <li>• Problem with receiving unit</li> <li>• Scanning head is dirty</li> <li>• Scanning head is bad</li> </ul>	<ul style="list-style-type: none"> <li>• Use your fax unit to make a test copy (If this is passable, the problem is at the other end.)</li> <li>• Clean the scanning head</li> <li>• Call your Brother service center</li> </ul>	III-8-1 VII-3
Documents sent are received blank	<ul style="list-style-type: none"> <li>• Document is face up in the feeder</li> </ul>	<ul style="list-style-type: none"> <li>• Set the document face down in the feeder and send it again</li> </ul>	
Auto transmission is not working	<ul style="list-style-type: none"> <li>• The wrong (a non-fax) number was dialed</li> <li>• Polled, or transmission or redialing with a document in the feeder is being carried out</li> </ul>	<ul style="list-style-type: none"> <li>• Double check the fax number you have registered in the machine</li> <li>• Use the interrupt function</li> </ul>	V-16-1
Delayed sending does not work	<ul style="list-style-type: none"> <li>• The HOOK key has been pressed or the handset was picked up</li> <li>• Polled, transmission, or redialing with a document in the feeder is being carried out</li> <li>• The maximum number (three) of delayed transmissions have been set up</li> </ul>	<ul style="list-style-type: none"> <li>• Refer to the instructions and begin again</li> <li>• Use the interrupt function</li> <li>• Wait until the delayed transmissions already set have been carried out</li> </ul>	V-16-1

## TELEPHONE

SYMPTOM	POSSIBLE CAUSE	ACTION	Ref.
One-touch and speed dialing don't work	<ul style="list-style-type: none"> <li>• Power cord is disconnected</li> <li>• Numbers have been registered incorrectly</li> <li>• Your telephone has been set to the wrong PULSE/TONE setting</li> <li>• Numbers have been registered as group dial or chain dial keys</li> </ul>	<ul style="list-style-type: none"> <li>• Plug the cord into the power outlet</li> <li>• Check and (if necessary) correct the registration</li> <li>• Check and (if necessary) correct the PULSE/TONE setting</li> <li>• Check and (if necessary) correct the registration</li> </ul>	III-6-1
No sound is produced when you press HOOK	<ul style="list-style-type: none"> <li>• The power cord is disconnected</li> <li>• The monitor switch is set low</li> <li>• The telephone line is not connected</li> </ul>	<ul style="list-style-type: none"> <li>• Plug the cord into the power outlet</li> <li>• Turn the monitor switch high.</li> <li>• Connect the fax unit to the telephone line</li> </ul>	III-6-1 II-3-4 III-7-1

## COPYING

SYMPTOM	POSSIBLE CAUSE	ACTION	Ref.
Nothing comes out of the slot	<ul style="list-style-type: none"> <li>• The paper roll is not inserted properly</li> <li>• Recording paper jam</li> <li>• Cover not closed properly</li> </ul>	<ul style="list-style-type: none"> <li>• Reload the paper correctly</li> <li>• Open the recording cover and remove the jammed paper. Make sure the paper is loaded correctly</li> <li>• Push the cover closed until you hear a click</li> </ul>	III-5-1 VI-5
No image appears on the paper	<ul style="list-style-type: none"> <li>• The paper roll is loaded upside down</li> <li>• The document is upside down in the feeder</li> </ul>	<ul style="list-style-type: none"> <li>• Reload the paper correctly and make another copy</li> <li>• Load the document in the feeder face down and make another copy</li> </ul>	III-5-1
Print quality of the copy is poor	<ul style="list-style-type: none"> <li>• The wrong recording paper is being used</li> </ul>	<ul style="list-style-type: none"> <li>• Use Brother thermal recording paper</li> </ul>	

*OTHERS*

---

<b>OTHERS</b>
---------------

<b>SYMPTOM</b>	<b>POSSIBLE CAUSE</b>	<b>ACTION</b>	<b>Ref.</b>
Cover cannot be closed properly	<ul style="list-style-type: none"><li>• Release levers have fallen into lower position</li></ul>	<ul style="list-style-type: none"><li>• Pull up both release levers and close the cover again</li></ul>	VI-6

## ERROR MESSAGES

An error message is displayed on the LCD when a malfunction occurs or when an operation has been done incorrectly. When some of the error messages described below appear on the screen, an alarm will sound continuously for 4 seconds.

### <MACHINE ERRORS>

#### CHECK RECORDING PAPER

If the unit detects the end of the roll of the recording paper, this display will appear to inform you that the unit is out of paper. This message may also appear if the paper has not been loaded properly.

#### DOCUMENT JAM PRESS STOP KEY

This indicates a document paper jam inside the machine or the feeder. Open the panel cover to remove the jammed document. When the jam has been corrected, close the cover. If this does not correct the error, contact your Brother service center and inform them of the situation.

#### RECORDING PAPER JAM

This indicates a recording paper jam inside the machine. Open the recording cover to pull the jammed paper out of the recording paper guide, as shown in the illustration below. When the jam has been corrected, cut the edge of the recording paper with a pair of scissors, and reset it properly in the guide. Then close the cover of the machine.

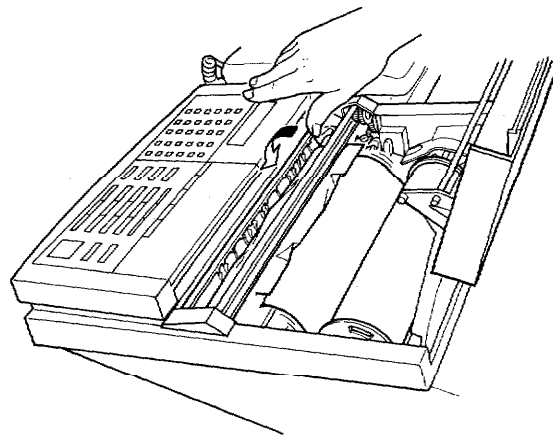

## ERROR MESSAGES

---

### CUTTER JAM

This indicates that the cutter is not at the home position because a recording paper jam is obstructing the movement of the cutter inside the machine. First, unplug the machine. Then open the cover to remove the jammed paper. (Use caution when handling the paper, as the cutter is quite sharp.) After the paper jam has been corrected, reset the paper roll in position, and close the cover. Finally, plug in the machine again. The cutter will return to the home position automatically.

### PRINTER ERROR PRESS STOP KEY

This may indicate overheating due to a problem with the printing head. Let the unit cool down for one hour or more. If this does not correct the error, contact your Brother service center and inform them of the situation.

### RECORDING COVER OPEN

The cover has not been closed properly. Check the position of the release levers on both sides inside the unit, and return them to the upper position, as shown in the illustration below. Then close the cover.

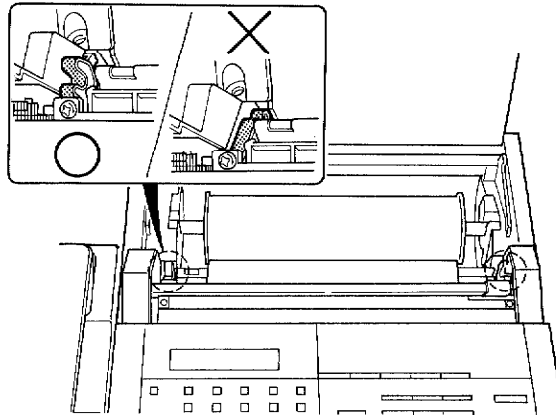

### RECEIVING INTERFERENCE

This may indicate some error related to the recording paper, a lack of receiving memory, at manual reception. Hang up the handset when manual reception. Information about correcting the situation will then appear on the LCD. This error message may also appear during polling or retrieval from a confidential mailbox.

### PRINTING INTERFERENCE

This may indicate an error related to the recording paper. Press the STOP key or remove the document, and information about the situation will appear on the LCD.

### MACHINE ERROR XX PRESS STOP KEY

This may indicate overheating due to overuse. Let the unit cool down for one hour or more. If this does not correct the error, contact your Brother service center and inform them of the situation.



If the error message on the LCD reads "MACHINE ERROR EA", this may indicate that document was removed from the feeder while transmission was still taking place.

<COMMUNICATION ERRORS>

NO RESPONSE OR BUSY

When you are making a transmission, this message indicates that either the other party is busy or that no response has been received. If you have turned the Auto Redial function ON (see page IV-1-10), the machine will automatically try the number again after a few minutes. If you have selected to turn the Auto Redial function OFF, this transmission will be unsuccessful and transmission verification report (busy) will be printed out.

NO CONNECTABILITY

When you are the receiving party, this message will indicate that certain functions—password, and the confidential mailbox and relay broadcasting—cannot be enabled because the sending party's machine is not a Brother machine.

ID MISMATCH

This may indicate that the incorrect ID number (for password, password plus, and secure polling, and the confidential mailbox, confidential mailbox retrieval, or relay broadcast request) was used when the sender made his transmission. Contact the sender to verify that your ID codes match up correctly. A transmission verification report (error) will be printed out.

This may also occur if you have entered the wrong ID code when attempting to print out a confidential message from the memory. Double check the ID and try the operation again.

LINE DISCONNECTED

This message may indicate that either the sending or the receiving party has interrupted the fax transmission (or reception) operation. If you are the sender, this may also indicate a missed telephone line connection due to an ID mismatch or the receiving party being unprepared for polling, and so on. In such circumstances, check with the receiving party to learn what is happening at the other end of the line.

COMM ERROR XX YY

This message indicates that some communication error has taken place. "XX YY" represents the error codes used to provide more detailed information about the error. Refer to the list shown below.

## ERROR MESSAGES

---

### Error Codes

- 40 06 — This indicates that a unit which has not been set up for polling has been polled by another unit.
- 40 11 — This indicates that the unit has attempted relay broadcasting, but for an unregistered group number.
- 40 13 — This indicates that the machine has been set up for secure polling, but the polling request has come from a unit which is not a Brother machine.
- 20 01, 20 08, A0 01 — Try the operation again.

If any error code other than those listed here appears on the LCD, contact your Brother service center and inform them of the situation.

### <OTHER ERRORS – BOTH MODELS>

NOT REGISTERED

This message indicates that you have attempted to reach a one-touch or speed dialing number that has not yet been registered. (See page IV-4-1 and IV-5-1.)

INVALID OPERATION  
NO NUMBER REGISTERED

This message indicates that no one-touch or speed dialing numbers have been registered when the TEL-INDEX key is pressed or the TEL-INDEX list has been called up.

NOT REGISTERED  
STATION ID

This indicates that you have attempted to use the super COVERPAGE function before registering your station ID. Register the station ID (see page IV-1-2) first, and then try the operation again.

NO DOCUMENT IN FEEDER  
SET DOCUMENT(S)

This indicates that no document(s) has been set into the document feeder, when you have tried to select contrast change or multiple resolution setting, or confidential transmission

INVALID OPERATION  
CHECK YOUR NUMBER

This indicates that you have pressed a Group key (a one-touch number registered as a group key) before pressing the BROADCAST key.

– OR –

MEMORY FULL  
PRESS STOP TO AVOID

No more data can be stored in the memory. Press the STOP key to erase the entire memory, or press the START key to send the stored data out of the memory.

It is also possible to create more space in the unit's memory by printing out some confidential documents or documents that have been received into memory. In addition, more space can be made available by sending documents that have been stored into memory. A Memory Used Report (see page V-9-2) will inform you as to how much memory in the machine is available.

MEMORY FULL  
PRESS STOP KEY

This message indicates that the memory is full, and cannot accept any more data. Press the STOP key to cancel your current transmission.

MEMORY FULL

This indicates that you cannot do broadcast transmission because of memory full.

TOO MANY STATIONS FOR  
BROADCAST REQUEST(S)

This indicates that you have attempted broadcasting to more than the total maximum number of stations (129) on InstaFAX2100M and (159) on InstaFAX2200M.

GROUP 01  
THE NUMBER REGISTERED

This indicates that the group number you selected has already been used.

ALL GROUP KEYS IN USE  
NO MORE NO. CAN BE REGIST

This indicates that all group numbers have already been registered.



## **VII. Cleaning**

---

To ensure a long and useful life for your machine, regular cleaning is essential. For best results clean the scanning and printing areas of your machine every time you use up a roll of recording paper. The following points should be borne in mind.

- 1) **To avoid the risk of an electric shock, unplug the machine before cleaning.**
- 2) **Do not use water or organic solvents of any kind (thinners, for example) to clean the machine.**
- 3) **Use a slightly damp cloth to wipe any dirt off the surface of the machine.**

To clean the working parts of the machine follow the steps described below.

## CLEANING THE PRINTING AREA

First, unplug the machine. Open the unit, and remove the roll of recording paper from inside the machine.

When cleaning the printing head, use the cleaning slip provided with the machine. Wet one end of the paper slip with isopropyl alcohol, and insert it under the guide until it will enter no further. Then continue across the unit as shown in the illustration, inserting the paper so the entire head is cleaned with the alcohol. (Either side and both ends of the paper slip can be used for cleaning the printing area.)

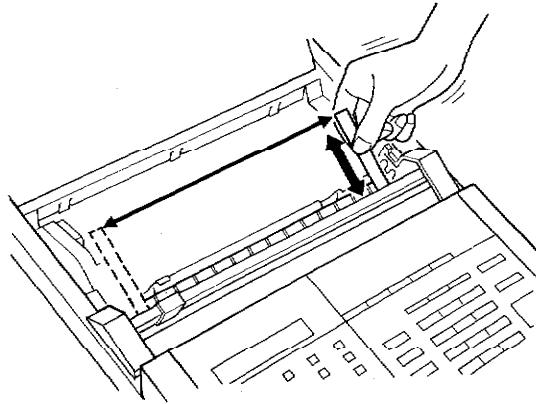

## CLEANING THE SCANNER

Lift up on the front cover of the unit to open the machine.

Carefully remove any dirt from the clear glass cover of the scanner using a soft cloth soaked in alcohol. Do not use organic solvents such as thinners, or petrol.

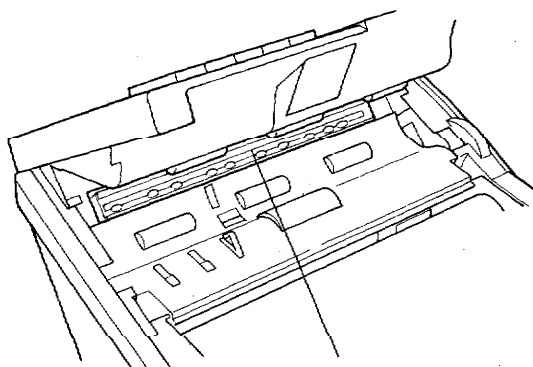
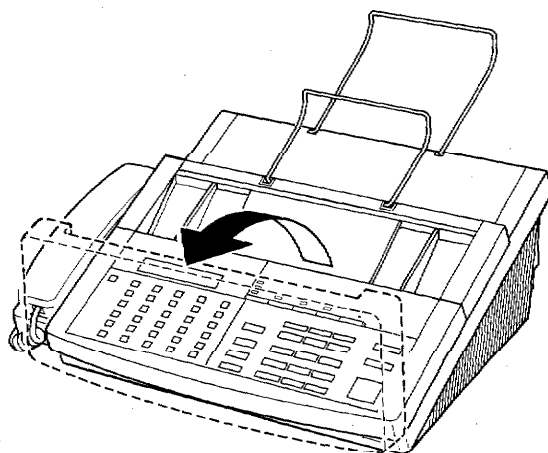

Scanner

Downloaded from [www.somanuals.com](http://www.somanuals.com) on 11/11/2014



## VIII. Specifications

---

<b>Type</b>	Desktop facsimile transceiver
<b>Compatibility</b>	CCITT Group 3
<b>Coding system</b>	Modified Huffman (MH), Modified Read (MR) and Modified Modified Read(MMR)
<b>Modulation</b>	CCITT V.27 ter and a V.29 modem (9600bps) CCITT V.17 and a V.33 modem (14400bps only for InstaFAX2200M)
<b>Document input size</b>	8.5" (max) / 5.8" (min)
<b>Scanning/Printing width</b>	8.2"/208mm
<b>Paper roll size</b>	8.5" x 328'/216mm x 100m
<b>Scanner type</b>	Contact Image Sensor (CIS)
<b>Printer type</b>	Line Thermal
<b>Gray scale</b>	16/Max. 32 on the InstaFAX2200M
<b>Paper Cutter</b>	Automatic
<b>LCD</b>	24 digits x 2 lines
<b>Polling types</b>	Standard/Security/Turnaround/Sequential
<b>Broadcasting</b>	Sequential/Relay
<b>Contrast control</b>	AUTO/Super Light
<b>Resolution</b>	<ul style="list-style-type: none"><li>• Standard (203 x 98 lines/inch)</li><li>• Fine (203 x 196 lines/inch)</li><li>• Super Fine (203 x 392 lines/inch)</li><li>• Photo (203 x 196 lines/inch)</li></ul>
<b>One-touch dial</b>	60 stations (InstaFAX2200M) 30 stations (InstaFAX2100M)
<b>Speed dial</b>	100 stations
<b>Total station memories</b>	160 (InstaFAX2200M) 130 (InstaFAX2100M)
<b>Memory</b>	512KB, expandable 768KB or 1MB. (InstaFAX2200M) 256KB, expandable 512KB or 768KB. (InstaFAX2100M)
<b>Automatic redial</b>	3 times (5 minute intervals)
<b>Speaker type</b>	Monitor
<b>Auto answer (# of rings)</b>	Shorter(1 ring)/Longer(4 rings)
<b>Communications source</b>	Public switched telephone network (or compatible approved PBX)
<b>Operating environment</b>	41 - 95°F
<b>Power source</b>	120 VAC, 60Hz
<b>Power consumption</b>	Stand-by: under 15 watts Peak:under 150 watts
<b>Dimensions</b>	16.0" x 15.0" x 5.7"/407 mm x 380 mm x 145 mm
<b>Weight</b>	14.3lbs/6.5 kg

Specifications are subject to change for improvement without prior notice.





**brother**®

UF0677001  
Printed in Japan

## Free Manuals Download Website

<http://myh66.com>

<http://usermanuals.us>

<http://www.somanuals.com>

<http://www.4manuals.cc>

<http://www.manual-lib.com>

<http://www.404manual.com>

<http://www.luxmanual.com>

<http://aubethermostatmanual.com>

Golf course search by state

<http://golfingnear.com>

Email search by domain

<http://emailbydomain.com>

Auto manuals search

<http://auto.somanuals.com>

TV manuals search

<http://tv.somanuals.com>