

**TRXI-22A, TRXI-24A, TRXI-42A,
AND TRXI-44A ACTIVE
TOKEN RING INTELLIGENT HUB**

USER'S GUIDE

CABLETRON
SYSTEMS

The Complete Networking Solution™

CABLETRON SYSTEMS, P. O. Box 5005, Rochester, NH 03867-0505

NOTICE

Cabletron Systems reserves the right to make changes in specifications and other information contained in this document without prior notice. The reader should in all cases consult Cabletron Systems to determine whether any such changes have been made.

The hardware, firmware, or software described in this manual is subject to change without notice.

IN NO EVENT SHALL CABLETRON SYSTEMS BE LIABLE FOR ANY INCIDENTAL, INDIRECT, SPECIAL, OR CONSEQUENTIAL DAMAGES WHATSOEVER (INCLUDING BUT NOT LIMITED TO LOST PROFITS) ARISING OUT OF OR RELATED TO THIS MANUAL OR THE INFORMATION CONTAINED IN IT, EVEN IF CABLETRON SYSTEMS HAS BEEN ADVISED OF, KNOWN, OR SHOULD HAVE KNOWN, THE POSSIBILITY OF SUCH DAMAGES.

© Copyright May 1994 by:
Cabletron Systems, Inc.
P.O. Box 5005, Rochester, NH 03867-0505

All Rights Reserved
Printed in the United States of America

Order Number: 9031079 May 94

TRXI-22A, TRXI-24A, TRXI-42A, TRXI-44A, and TPIM are trademarks of Cabletron Systems, Inc.

SPECTRUM, LANVIEW, and Remote LANVIEW are registered trademarks of Cabletron Systems, Inc.

IBM is a registered trademark of International Business Machines Corporation.

DEC, VT200, and VT300 are trademarks of Digital Equipment Corporation.

CompuServe is a trademark of CompuServe, Inc.

Printed On  Recycled Paper

NOTICE

FCC NOTICE

This device complies with Part 15 of the FCC rules. Operation is subject to the following two conditions: (1) this device may not cause harmful interference, and (2) this device must accept any interference received, including interference that may cause undesired operation.

NOTE: This equipment has been tested and found to comply with the limits for a Class A digital device, pursuant to Part 15 of the FCC rules. These limits are designed to provide reasonable protection against harmful interference when the equipment is operated in a commercial environment. This equipment uses, generates, and can radiate radio frequency energy and if not installed in accordance with the operator's manual, may cause harmful interference to radio communications. Operation of this equipment in a residential area is likely to cause interference in which case the user will be required to correct the interference at his own expense.

WARNING: Changes or modifications made to this device which are not expressly approved by the party responsible for compliance could void the user's authority to operate the equipment.

DOC NOTICE

This digital apparatus does not exceed the Class A limits for radio noise emissions from digital apparatus set out in the Radio Interference Regulations of the Canadian Department of Communications.

Le présent appareil numérique n'émet pas de bruits radioélectriques dépassant les limites applicables aux appareils numériques de la class A prescrites dans le Règlement sur le brouillage radioélectrique édicté par le ministère des Communications du Canada.

CABLETRON SYSTEMS, INC. PROGRAM LICENSE AGREEMENT

IMPORTANT: Before utilizing this product, carefully read this License Agreement.

This document is an agreement between you, the end user, and Cabletron Systems, Inc. ("Cabletron") that sets forth your rights and obligations with respect to the Cabletron software program (the "Program") contained in this package. The Program may be contained in firmware, chips or other media. BY UTILIZING THE ENCLOSED PRODUCT, YOU ARE AGREEING TO BECOME BOUND BY THE TERMS OF THIS AGREEMENT, WHICH INCLUDES THE LICENSE AND THE LIMITATION OF WARRANTY AND DISCLAIMER OF LIABILITY. IF YOU DO NOT AGREE TO THE TERMS OF THIS AGREEMENT, PROMPTLY RETURN THE UNUSED PRODUCT TO THE PLACE OF PURCHASE FOR A FULL REFUND.

CABLETRON SOFTWARE PROGRAM LICENSE

1. **LICENSE.** You have the right to use only the one (1) copy of the Program provided in this package subject to the terms and conditions of this License Agreement.

You may not copy, reproduce or transmit any part of the Program except as permitted by the Copyright Act of the United States or as authorized in writing by Cabletron.

2. **OTHER RESTRICTIONS.** You may not reverse engineer, decompile, or disassemble the Program.
3. **APPLICABLE LAW.** This License Agreement shall be interpreted and governed under the laws and in the state and federal courts of New Hampshire. You accept the personal jurisdiction and venue of the New Hampshire courts.

EXCLUSION OF WARRANTY AND DISCLAIMER OF LIABILITY

1. **EXCLUSION OF WARRANTY.** Except as may be specifically provided by Cabletron in writing, Cabletron makes no warranty, expressed or implied, concerning the Program (including Its documentation and media).

CABLETRON DISCLAIMS ALL WARRANTIES, OTHER THAN THOSE SUPPLIED TO YOU BY CABLETRON IN WRITING, EITHER EXPRESS OR IMPLIED, INCLUDING BUT NOT LIMITED TO IMPLIED WARRANTIES OF MERCHANTABILITY AND FITNESS FOR A PARTICULAR PURPOSE, WITH RESPECT TO THE PROGRAM, THE ACCOMPANYING WRITTEN MATERIALS, AND ANY ACCOMPANYING HARDWARE.

2. **NO LIABILITY FOR CONSEQUENTIAL DAMAGES.** IN NO EVENT SHALL CABLETRON OR ITS SUPPLIERS BE LIABLE FOR ANY DAMAGES WHATSOEVER (INCLUDING, WITHOUT LIMITATION, DAMAGES FOR LOSS OF BUSINESS, PROFITS, BUSINESS INTERRUPTION, LOSS OF BUSINESS INFORMATION, SPECIAL, INCIDENTAL, CONSEQUENTIAL, OR RELIANCE DAMAGES, OR OTHER LOSS) ARISING OUT OF THE USE OR INABILITY TO USE THIS CABLETRON PRODUCT, EVEN IF CABLETRON HAS BEEN ADVISED OF THE POSSIBILITY OF SUCH DAMAGES. BECAUSE SOME STATES DO NOT ALLOW THE EXCLUSION OR LIMITATION OF LIABILITY FOR CONSEQUENTIAL OR INCIDENTAL DAMAGES, OR ON THE DURATION OR LIMITATION OF IMPLIED WARRANTIES IN SOME INSTANCES THE ABOVE LIMITATIONS AND EXCLUSIONS MAY NOT APPLY TO YOU.

UNITED STATES GOVERNMENT RESTRICTED RIGHTS

The enclosed product (a) was developed solely at private expense; (b) contains "restricted computer software" submitted with restricted rights in accordance with Section 52.227-19 (a) through (d) of the Commercial Computer Software - Restricted Rights Clause and its successors, and (c) in all respects is proprietary data belonging to Cabletron and/or its suppliers.

For Department of Defense units, the product is licensed with "Restricted Rights" as defined in the DoD Supplement to the Federal Acquisition Regulations, Section 52.227-7013 (c) (1) (ii) and its successors, and use, duplication, disclosure by the Government is subject to restrictions as set forth in subparagraph (c) (1) (ii) of the Rights in Technical Data and Computer Software clause at 252.227-7013. Cabletron Systems, Inc., 35 Industrial Way, Rochester, New Hampshire 03867

TABLE OF CONTENTS

CHAPTER 1 INTRODUCTION

1.1	USING THIS MANUAL	1-1
1.2	GETTING HELP	1-2
1.3	TRXI ACTIVE CONCENTRATOR OVERVIEW.....	1-2
1.4	TRXI FEATURES	1-3
1.5	REMOTE NETWORK MANAGEMENT CAPABILITIES	1-6
1.6	RECOMMENDED READING.....	1-6

CHAPTER 2 REQUIREMENTS/SPECIFICATIONS

2.1	CABLE SPECIFICATIONS.....	2-1
2.1.1	UTP Cable Specifications for the TRXI-22A/24A Lobe Ports and TPIM-T2	2-2
2.1.2	STP Cable Specifications For The TRXI-42A/44A Lobe Ports and TPIM-T1/T4.....	2-4
2.1.3	Mixed Cable Types	2-6
2.1.4	Multimode Fiber Optic Cable Specifications for the TPIM-F2.....	2-7
2.1.5	Single Mode Fiber Optic Cable Specifications for the TPIM-F3.....	2-8
2.2	CABLE RECOMMENDATIONS/TROUBLESHOOTING.....	2-9
2.3	COM 1/COM 2 PORT SPECIFICATIONS.....	2-11
2.4	TPIM SPECIFICATIONS.....	2-12
2.5	GENERAL SPECIFICATIONS.....	2-17

CHAPTER 3 INSTALLATION

3.1	UNPACKING THE TRXI	3-1
3.2	ATTACHING THE STRAIN RELIEF BRACKET	3-1
3.3	INSTALLING THE TRXI.....	3-2
3.3.1	Rack Mounting the TRXI.....	3-3
3.3.2	Wall Mounting the TRXI	3-4
3.3.3	Free-Standing Installation	3-5
3.4	SETTING THE RING SPEED SWITCH.....	3-6
3.5	SETTING THE NVRAM SWITCH	3-7
3.6	CONNECTING THE TRXI TO THE POWER SOURCE.....	3-8
3.7	CONNECTING THE NETWORK LOBE PORT CABLING	3-8
3.8	INSTALLING THE TPIM RI/RO MODULES.....	3-11

CONTENTS

3.8.1	Setting the TPIM's Phantom Switch and RI/RO Switch	3-12
3.8.2	Installing a TPIM to the TRXI.....	3-13
3.8.3	Connecting a Twisted Pair Segment to the TPIM-T1	3-14
3.8.4	Connecting a Twisted Pair Segment to the TPIM-T2 or TPIM-T4.....	3-15
3.8.5	Connecting a Fiber Optic Link Segment to the TPIM-F2 or TPIM-F3.....	3-16
3.9	FINISHING THE INSTALLATION.....	3-18

CHAPTER 4 TESTING AND TROUBLESHOOTING

4.1	CHECKING THE INSTALLATION.....	4-1
4.2	USING LANVIEW LEDs	4-2
4.3	USING THE LCD DISPLAY	4-3
4.3.1	Static System Messages	4-4
4.3.2	Alarm Messages.....	4-5
4.3.3	Unsaved Initialization Messages.....	4-6
4.3.4	Saved System Messages.....	4-7

CHAPTER 5 LOCAL MANAGEMENT

5.1	MANAGEMENT TERMINAL REQUIREMENTS	5-2
5.1.1	Attaching the Management Terminal.....	5-2
5.1.2	Setting the Management Terminal Setup Parameters.....	5-3
5.1.3	Modem Cable Configuration and Setup	5-4
5.2	ACCESSING LOCAL MANAGEMENT	5-5
5.3	USING LOCAL MANAGEMENT.....	5-6
5.3.1	The System Level Screen	5-8
5.3.2	The SNMP Community Names Screen	5-13
5.3.3	The SNMP Traps Screen.....	5-15
5.3.4	The Ring Security Screen.....	5-17
5.3.5	The Device Statistics Screen.....	5-22
5.3.6	The Chassis Status View Screen	5-28
5.3.7	The Component Status View Screen	5-30
5.3.8	The SNMP Tools Screen.....	5-31

CHAPTER 1

INTRODUCTION

Welcome to the Cabletron Systems **TRXI-22A, TRXI-24A, TRXI-42A, and TRXI-44A Active Token Ring Intelligent Hub User's Guide**. This manual provides installation instructions, network requirements, and reference information for the TRXI Active stand-alone concentrator. You should have an understanding of Token Ring (IEEE 802.5) type data communications networks and their physical layer components before installing the TRXI.

***Note:** This manual uses the term TRXI to describe the TRXI -22A, 24A, 42A, and 44A unless otherwise specified.*

1.1 USING THIS MANUAL

The following summary provides information about each chapter in this manual. Read through the summary to familiarize yourself with this manual's organization and content.

Chapter 1, **Introduction**, outlines the contents of this manual and describes features of the TRXI. It also lists recommended reading for implementing a Token Ring network.

Chapter 2, **Requirements/Specifications**, describes cabling requirements, network guidelines, and TRXI operating specifications.

Chapter 3, **Installation**, contains instructions for installing your TRXI and connecting it to the network using the various media types. This chapter includes instructions for setting the Ring Speed Switch, setting the NVRAM Switch, installing the TPIMs, and setting the TPIM Phantom Switch.

Chapter 4, **Testing and Troubleshooting**, contains procedures for testing the TRXI after installation, a description of the LANVIEW® LEDs, and explains the front panel LCD display.

Chapter 5, **Local Management**, describes how to access Local Management. It also describes each of the Local Management screens and the available commands.

INTRODUCTION

1.2 GETTING HELP

If you need additional support related to the Cabletron Systems TRXI, or if you have any questions, comments, or suggestions concerning this manual, contact Cabletron Systems Technical Support:

By phone (603) 332-9400
Monday-Friday; 8am - 8pm EST
By CompuServe® GO CTRON from any ! prompt
By Internet mail support@ctrn.com

1.3 TRXI ACTIVE CONCENTRATOR OVERVIEW

The TRXI stand-alone concentrator provides 12 or 24 RJ45 active Trunk Coupling Units (TCUs) for Shielded Twisted Pair (STP) or Unshielded Twisted Pair (UTP) network lobe connections. The TRXI-22A, 24A, 42A, and 44A are functionally identical with the exception of the TCU lobe ports. Cabletron offers the following TRXI configurations:

- **TRXI-22A**, twelve active RJ45 TCU lobe ports that support category 3, 4, and 5 UTP cabling.
- **TRXI-24A**, twenty-four active RJ45 TCU lobe ports that support category 3, 4, and 5 UTP cabling.
- **TRXI-42A**, twelve active RJ45 TCU lobe ports that support IBM Type 1, 2, 6, and 9 STP cabling.
- **TRXI-44A**, twenty-four active RJ45 TCU lobe ports that support IBM Type 1, 2, 6, and 9 STP cabling.

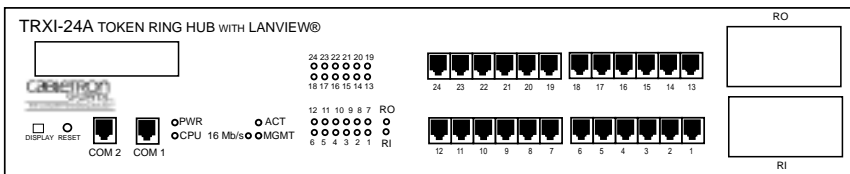

Figure 1-1. The TRXI-24A

You can upgrade the TRXI-22A and TRXI-42A to twenty-four ports using a twelve port upgrade kit available from Cabletron Systems (Cabletron Part Number TRXI-24A-UGKIT or TRXI-44A-UGKIT).

The TRXI provides two additional ports for Ring In and Ring Out (RI/RO) connections. These ports support Cabletron's Token Ring Port Interface Modules (TPIMs). TPIMs provide full repeater functionality. They are not included with the TRXI, but can be ordered separately from Cabletron. Table 1-1 lists each TPIM.

1.4 TRXI FEATURES

Active TCU Ports

The active TCU ports regenerate, reshape and filter the incoming signal permitting UTP lobe cable lengths of up to **100 meters** and STP lobe cable lengths up to **150 meters** at 16 Mbps ring speed.

Cable Signal Polarity

Differential Manchester encoding is utilized for each of the concentrator module TCU ports. This permits passing data regardless of receive link polarity.

***Note:** If a reversed polarity condition is discovered, the segment should be removed from the network and wired correctly (according to the connector wiring shown in Chapter 2, Requirements / Specifications). This will avoid the potential for future compatibility problems.*

Speed Fault Protection

If a station attempts to insert into the ring at a ring speed (4 or 16 Mbps) different from what is set on the TRXI, that port is automatically bypassed to prevent the ring from beaconing. The Lobe Port Status LED blinks indicating the port with the speed fault is bypassed.

Local Management

Local Management provides the tools to manage the TRXI and all of its attached segments. You access Local Management by connecting a Digital Equipment Corporation VT™ 320 series terminal or a PC using VT320 emulation software to the TRXI's COM 1 port.

INTRODUCTION

Token Ring Port Interface Modules

TPIMs are optional features that let you expand your trunk connections using different media types. TPIMs have embedded repeaters and retime all data. Cabletron offers a variety of TPIMs for trunk Ring In or Ring Out connections. Table 1-2 lists each TPIM.

Table 1-1. TPIMs

TPIM	Media Type	Connector
TPIM-T1	Shielded Twisted Pair	DB9
TPIM-T2	Unshielded Twisted Pair	RJ45
TPIM-T4	Shielded Twisted Pair	RJ45
TPIM-F2	Multimode Fiber Optic	ST
TPIM-F3	Single mode Fiber Optic	ST

Ring Speed Switch

The Ring Speed Switch lets you select ring speeds of either 4 Mbps or 16 Mbps. The factory default setting is 16 Mbps.

Flash EEPROMs

The TRXI uses Flash EEPROMs that allow you to download new and updated firmware using Cabletron System's Remote LANVIEW/Windows, version 2.3 or later or any device using BOOTP or TFTP protocols.

LANVIEW LEDs

Cabletron Systems' LANVIEW LED Status Monitoring and Diagnostics System is a convenient troubleshooting tool that helps you diagnose power failures, RI/RO status, cable faults, ring speed, link problems, and network activity.

Cabletron's Distributed LAN Monitor

Cabletron Systems' Distributed LAN Monitor (DLM) is a software option for the TRXI. DLM provides a method for locally polling and monitoring devices on a local area network to minimize network management traffic on an enterprise, campus, or wide area network.

RMON MIB Support

The TRXI supports the RMON MIB RFC 1271/1513 Token Ring Extensions shown in Table 1-2.

Table 1-2. RMON MIB RFC 1271/1513 Support

Group	Subgroup	Section
Statistics rmon 1	Token Ring ML Stats Table	statistics 2
History rmon 2	History Control Table	history 1
	Token Ring ML History Table	history 3
Alarm rmon 3	Alarm Table	alarm 1
Event rmon 9	Event Table	event 1
	Log Table	event 2
Token Ring rmon 10	Ring Station Control Table	token ring 1
	Ring Station Table	token ring 2
	Ring Station Order Table	token ring 3
	Ring Station Config Control Table	token ring 4
	Ring Station Config Table	token ring 5

COM Port Applications

The front panel COM 1 port is configured to support Local Management applications. Future capabilities for TRXI's serial ports include an SNMP proxy for Uninterruptible Power Supplies (UPS), the Serial Line Internet Protocol (SLIP), and Modem.

LCD and Reset Button

The LCD provides status information about the TRXI such as power up diagnostics, revision levels, serial numbers, and error alerts. The TRXI also has a Reset Button to initialize the processor. Both the LCD and the Reset Button are located on the front panel of the TRXI.

INTRODUCTION

1.5 REMOTE NETWORK MANAGEMENT CAPABILITIES

You can control and manage the TRXI using any Simple Network Management Protocol (SNMP) software. Cabletron Systems offers the following remote management packages:

- Cabletron Systems SPECTRUM®
- Cabletron Systems Remote LANVIEW®/Windows™
- Cabletron Systems Remote SPECTRUM® Portable Management Applications

The TRXI remote network management capabilities provide the necessary management tools for the TRXI to operate at its full capacity. Your ability to set up parameters with network management ensures optimal performance of the TRXI.

1.6 RECOMMENDED READING

The following publications are recommended if more information is required on implementing a token ring network.

Local Area Networks, Token Ring Access Method, IEEE Standard 802.5 (1989)

Commercial Building Wiring Standard, EIA Standard Proposal No. 1907-B (if approved, to be published as **EIA/TIA-568**)

LAN Troubleshooting Handbook, Mark Miller (1989, M&T Publishing)

CHAPTER 2

REQUIREMENTS/SPECIFICATIONS

This chapter describes cabling requirements, power requirements, and operating specifications for the TRXI. Be sure that you read this chapter before you install the TRXI. Your network must meet the requirements and conditions specified in this chapter to obtain satisfactory performance from this equipment. Failure to follow these guidelines could result in poor network performance.

2.1 CABLE SPECIFICATIONS

The basic concept of a token ring is a set of Trunk Coupling Units (TCUs) connected by trunk cabling. You can extend the trunk cabling by installing TPIMs into the TRXI's RI/RO ports. TPIMs have embedded repeaters and provide trunk connections for UTP, STP, Multimode Fiber, and Single Mode Fiber cabling.

You attach stations to the TCU lobe ports with lobe cabling. Figure 2-1 shows the various ports and cables.

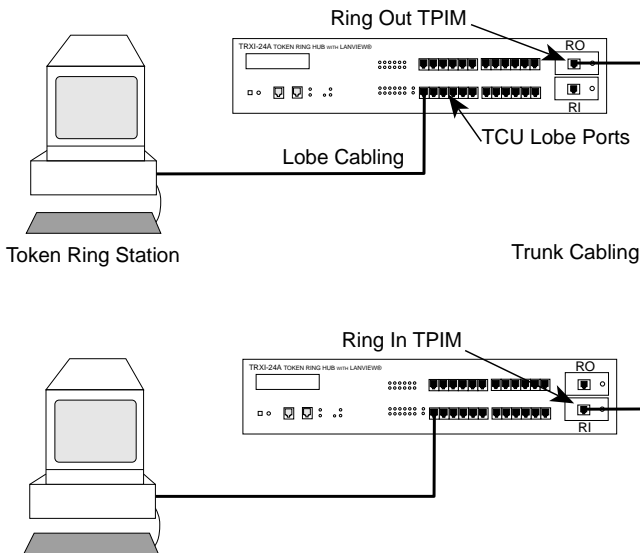

Figure 2-1. TRXI Ports/Cables

REQUIREMENTS/SPECIFICATIONS

2.1.1 UTP Cable Specifications for the TRXI-22A/24A Lobe Ports and TPIM-T2

The TRXI-22A and TRXI-24A lobe ports and the TPIM-T2 support voice grade Unshielded Twisted Pair (UTP) cable, as described in EIA/TIA TSB 568, and IBM Type 3 cable.

UTP consists of four pairs of 24 AWG solid wire for data or voice communication and is typically used to wire cable runs within the walls of buildings. In some installations, existing UTP building wiring can be used for token ring cabling. UTP cable must conform to the limits shown in Table 2-1.

Warning: *DO NOT connect UTP cabling to any non-token ring network conductors (telephone, etc.) or ground. If in doubt, test wiring before using. Telephone Battery and Ringing voltages, used in UTP telephone circuits, could present a shock hazard and can damage token ring equipment when connected to token ring cabling.*

The increased popularity and cost advantages of UTP cable have driven refinements to UTP cable design. As a result, better grades of UTP cable, known as supergrade or level 4, are available that exhibit improved transmission characteristics. These improved grades of UTP can often be used to permit operation at 16 Mbps on longer lobe cables.

Attenuation and Impedance

The values listed in Table 2-1 include the maximum attenuation of the cables, connectors, patch panels, and reflection losses due to impedance mismatches in the segment.

Table 2-1. UTP Voice Grade and Category 3 Specifications

Frequency	Impedance	Attenuation
1 MHz	100Ω ±15%	<26 dB/km (8 dB/1000 ft)
4 MHz	100Ω ±15%	<56 dB/km (16 dB/1000 ft)
10 MHz	100Ω ±15%	<98 dB/km (30 dB/1000 ft)
16 MHz	100Ω ±15%	<131 dB/km (40 dB/1000 ft)

Maximum Lobe Lengths

The lobe length is the physical length of the cable connecting a station to its TCU port at the TRXI. Table 2-2 shows the maximum lobe length, according to ring speed. The cable lengths listed in Table 2-2 are total lengths made up of UTP cable only.

Table 2-2. UTP Maximum Lobe Lengths

UTP Cable Type	Maximum Lobe Length	
	4 Mbps	16 Mbps
Category 3	200 meters (656 feet)	100 meters (328 feet)
Category 4	200 meters (656 feet)	100 meters (328 feet)
Category 5	250 meters (820 feet)	120 meters (394 feet)

Type 3 Media Filters

To connect a UTP lobe segment from a TRXI-22A or TRXI-24A to a station supporting STP cabling, you need a Type 3 Media Filter. Cabletron Systems offers the following Type 3 Media Filters:

- **TRMF**, RJ45 (UTP) connector to 10-inch DB9 (STP) cable with LANVIEW
- **TRMF-2**, RJ45 (UTP) connector to DB9 (STP) connector

Maximum Number of Stations

When you use UTP lobe cabling anywhere on the ring, the number of stations is limited to **150 stations** at ring speeds of either 4 or 16 Mbps.

REQUIREMENTS/SPECIFICATIONS

2.1.2 STP Cable Specifications For The TRXI-42A/44A Lobe Ports and TPIM-T1/T4

The TRXI-42A and TRXI-44A lobe ports support IBM Type 1, 2, 6, and 9 STP cabling as described below:

- **IBM Type 1** - Two STP lengths of 22 AWG solid wire for data. Used for the longest cable runs within the walls of buildings.
- **IBM Type 2** - Similar to Type 1 data cable, but having four additional UTP lengths of 22 AWG solid wire carried outside of the shield casing. Typically used for voice communication and often used to wire cable runs within the walls of buildings.
- **IBM Type 6** - Two STP lengths of 26 AWG stranded wire for data. This type is used in patch panels or to connect devices to/from wall jacks. Attenuation for Type 6 cable is 3/2 x Type 1 cable (66 m of Type 6 = 100 meters of Type 1).
- **IBM Type 9** - Similar to Type 1, but uses 26 AWG solid wire. Attenuation for Type 9 cable is 3/2 x Type 1 cable (66 m of Type 9 = 100 meters of Type 1).

Attenuation and Impedance

The attenuation values shown in Table 2-3 include the attenuation of the cables, connectors, patch panels, and reflection losses due to impedance mismatches in the segment.

Table 2-3. STP Cable Specifications

Frequency	Impedance	Attenuation
Types 1 & 2 4 MHz 16 MHz	150Ω ± 15% 150Ω ± 15%	<22 dB/km (6.7 db/1000 ft.) <45 dB/km (13.7 db/1000 ft.)
Types 6 & 9 4 MHz 16 MHz	150Ω ± 15% 150Ω ± 15%	<33 dB/km (10 db/1000 ft.) <66 dB/km (20 db/1000 ft.)

Maximum Lobe Lengths

The lobe length is the physical length of the cable connecting a station to its TCU port at the TRXI. Table 2-4 shows the maximum lobe length, according to ring speed. The cable lengths listed in Table 2-4 are total lengths made up of STP cable only.

Table 2-4. STP Maximum Lobe Lengths

STP Cable Type	Ring Speed	
	4 Mbps	16 Mbps
IBM Types 1 & 2	300 meters (984 feet)	150 meters (492 feet)
IBM Types 6 & 9 (only for station to wall jack and patch panels)	30 meters (99 feet)	30 meters (99 feet)

Maximum Trunk Lengths

The maximum trunk cable length between the TRXI and another active device is equal to the maximum drive distance as shown in Table 2-5. When the neighboring token ring device is a passive device, the combined length of twice the longest trunk cable plus the longest lobe cable attached to the passive ring segment cannot exceed the Maximum Drive Distance.

Table 2-5. STP Maximum Drive Distance

STP Cable Type	Ring Speed	
	4 Mbps	16 Mbps
IBM Types 1 & 2	770 meters (2525 feet)	346 meters (1138 feet)
IBM Types 6 & 9	513 meters (1683 feet)	230 meters (755 feet)

Maximum Number of Stations

When you use STP lobe cabling everywhere on the ring, the TRXI can support up to **250 stations** at ring speeds of either 4 or 16 Mbps.

REQUIREMENTS/SPECIFICATIONS

2.1.3 Mixed Cable Types

If you mix cable types in your installation, you must compensate for the different cable attenuations. Type 6 and Type 9 cables can be run for only 2/3 the distance of Type 1. This means:

$$10 \text{ meters (Type 1)} \approx 6.6 \text{ meters (Types 6, 9)}$$

Example: Maximum Length for Mixed Cabling Installation

- 16 Mbps ring speed and 130 stations.
- The building has 60 meters of Type 1 cable in the wall.
- How much Type 6 cable is available to connect the repeater TCU port to the patch panel and the station to the local wall jack?
- Type 6 can only go 2/3 the distance of Type 1.

Solution:

100 meters = maximum cable length if only Type 1 cable is used

$$[60 \text{ meters of Type 1}] + [40 \text{ meters of Type 1}] = \text{max. length}$$

$$[60 \text{ meters of Type 1}] + [(.66) \times (40 \text{ meters}) \text{ of Type 6}] = \text{max. length}$$

26.4 meters of Type 6 (for patch panel and wall jack connections)

2.1.4 Multimode Fiber Optic Cable Specifications for the TPIM-F2

Table 2-6 shows Multimode Fiber Optic Cable specifications for the TPIM-F2.

Table 2-6. Multimode Fiber Optic Cable Specifications

Cable Type	Attenuation	Maximum Drive Distance
50/125 μm	13.0 dB or less	The maximum allowable fiber optic cable length is 2 km (2187.2 yards). However, IEEE 802.5 specifications allow for a maximum of 1 km (1093.6 yards).
62.5/125 μm	16.0 dB or less	
100/140 μm	19.0 dB or less	

Maximum Trunk Lengths

The maximum trunk cable length between the TRXI and another active device is equal to the maximum drive distance as shown in Table 2-6. When the neighboring token ring device is a passive device, the combined length of twice the longest trunk cable plus the longest lobe cable attached to the passive ring segment cannot exceed the Maximum Drive Distance Trunk Length.

Attenuation

The fiber optic cable must be tested with a fiber optic attenuation test set that is adjusted for an 850 nm wavelength. This test verifies that the signal loss in a cable is within an acceptable level. Table 2-6 shows the attenuation for each Multimode cable type.

Fiber Optic Budget

When determining the maximum fiber optic cable length, the fiber optic budget delay should be calculated and taken into consideration before fiber optic cable runs are incorporated in any network design. Fiber optic budget is the combination of the optical loss due to the fiber optic cable, in-line splices, and fiber optic connectors.

REQUIREMENTS/SPECIFICATIONS

2.1.5 Single Mode Fiber Optic Cable Specifications for the TPIM-F3

Table 2-7 shows Single Mode Fiber Optic Cable specifications for the TPIM-F3.

Table 2-7. Single Mode Fiber Optic Cable Specifications

Cable Type	Attenuation	Maximum Drive Distance
8/125-12/125 μm	10.0 dB or less	The max. allowable fiber optic cable length is 2 km (2187.2 yards). However, IEEE 802.5 specs allow for a max. of 1 km (1093.6 yards).

Maximum Trunk Lengths

The maximum trunk cable length between the TRXI and another active device is equal to the Maximum Drive Distance as shown in Table 2-7. When the neighboring token ring device is a passive device, the combined length of twice the longest trunk cable plus the longest lobe cable attached to the passive ring segment cannot exceed the Maximum Drive Distance Trunk Length.

Attenuation

The fiber optic cable must be tested with a fiber optic attenuation test set that is adjusted for a 1300 nm wavelength. This test verifies that the signal loss in a cable is within an acceptable level of 10 dB or less for any given single mode fiber optic link.

Fiber Optic Budget

Fiber optic budget is the combination of the optical loss due to the fiber optic cable, in-line splices, and fiber optic connectors. When determining the maximum fiber optic cable length, the fiber optic budget (total loss of 10.0 dB or less between stations) and total network propagation delay should be calculated and considered before fiber optic cable runs are incorporated in any network design.

2.2 CABLE RECOMMENDATIONS/TROUBLESHOOTING

The following sections describe common cable problems and recommendations for correcting them.

Crosstalk

Crosstalk is interference caused by signal coupling between the different cable pairs contained within a multi-pair cable bundle. Multi-pair cables should not be used for UTP lobe cabling. UTP lobe cabling should be dedicated to carrying token ring traffic. Avoid mixing token ring signals with other applications (voice, etc.) within the same cable.

Noise

Noise can be caused by either crosstalk or externally induced impulses. If noise induced errors are suspected, it may be necessary to reroute cabling away from potential noise sources (motors, switching equipment, fluorescent lighting, high amperage equipment), or to ensure that the electrical wiring in the area is properly wired and grounded.

Temperature

The attenuation of PVC insulated cable varies significantly with temperature. Plenum-rated cables are strongly recommended at temperatures greater than 40°C to ensure that cable attenuation remains within specification. Check the cable manufacturer's specifications.

In addition to complying with the preceding cable specifications, the following recommendations should be followed to minimize errors and help to obtain optimum performance from your network:

- UTP cabling should be free of splices, stubs or bridged taps.
- No more than two punch-down blocks between TCU ports and wall outlets.
- Metal troughs, ducts, etc. carrying token ring signals should be properly grounded.

REQUIREMENTS/SPECIFICATIONS

- Token ring signals should not be routed through copper cables that exit a building or which are adjacent to cables either exiting a building or exposed to lightning strikes and power surges.
- UTP cables that contain token ring signals should not be simultaneously used for applications which may impress high voltages (greater than 5 volts) with sharp rise or fall times, since the noise coupling from such signals could directly cause errors on the token ring network.
- For single telecommunications closet rings, lobe lengths should not exceed 100 meters or 22 to 24 AWG wire from the attaching device and the TCU port.
- When possible, use dedicated UTP cable for token ring signals.

2.3 COM 1/COM 2 PORT SPECIFICATIONS

The RJ45 COM 1 and COM 2 ports support Console, Modem, UPS, and SLIP applications. A description of each COM port application is listed below:

Note: *Console is the only COM port application available at this time. Modem, UPS, and SLIP applications will be available in future TRXI releases.*

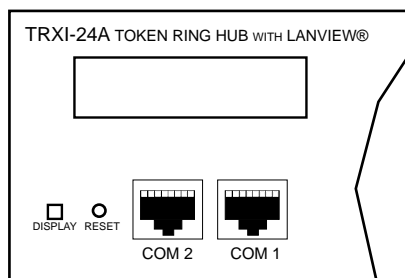

Figure 2-2. COM 1/COM 2 Ports

Console

The COM 1 port, as default, supports access to a Local Management Console. The console supports a Digital Equipment Corporation VT 320™ terminal or PC emulation of the VT 320 terminal.

Modem

Both the COM 1 and COM 2 ports support access to Local Management using a modem.

UPS

The COM 2 port supports an Uninterruptible Power Supply (American Power Conversion only).

SLIP

The COM 1 and COM 2 ports support the Serial Line Internet Protocol.

REQUIREMENTS/SPECIFICATIONS

2.4 TPIM SPECIFICATIONS

TPIMs provide Ring In/Ring Out (RI/RO) connections that let you extend your network using a variety of media. Each TPIM has an embedded repeater that retimes all data.

The LNK (Link) LED on each TPIM provides the following information:

- Green - RI or RO active
- Red (TPIM-T1/T2/T4 only) - No Link (Autowrapped)
- Off - No Link (Wrapped or Disabled)

The following sections describe each TPIM.

TPIM-T1

The TPIM-T1 is a female DB9 connector that supports STP cabling. Figure 2-3 shows TPIM-T1 pinouts for Ring Out and Ring In applications.

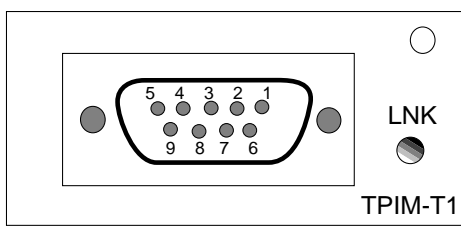

RING OUT	RING IN
1. Transmit +	1. Receive +
2. Ground	2. Ground
3. +5V at 250 mA	3. +5V at 250 mA
4. Ground	4. Ground
5. Receive -	5. Transmit -
6. Transmit -	6. Receive -
7. Ground	7. Ground
8. Ground	8. Ground
9. Receive +	9. Transmit +

Figure 2-3. TPIM-T1 Pinouts

TPIM-T2

The TPIM-T2 is an RJ45 connector that supports UTP cabling. Figure 2-4 shows pinouts for Ring Out and Ring In applications.

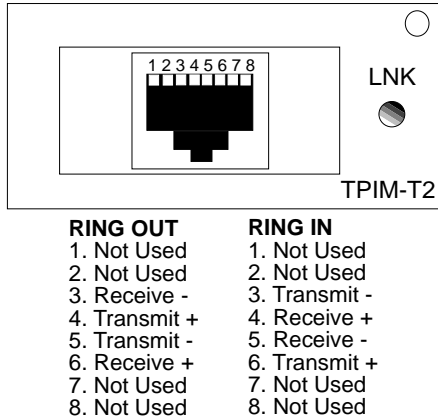

Figure 2-4. TPIM-T2 Pinouts

TPIM-T4

The TPIM-T4 is an RJ45 connector that supports STP cabling. Figure 2-5 shows pinouts for Ring Out and Ring In applications.

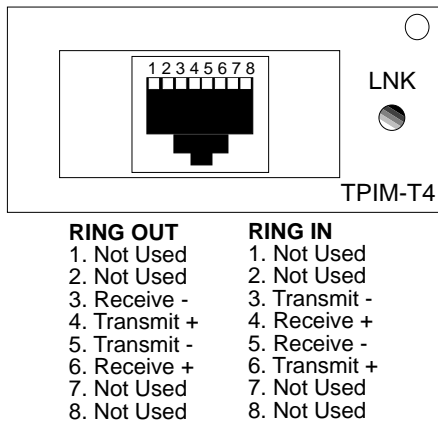

Figure 2-5. TPIM-T4 Pinouts

REQUIREMENTS/SPECIFICATIONS

TPIM-F2

The TPIM-F2 shown in Figure 2-6 is an ST connector that supports Multimode fiber Optic cabling.

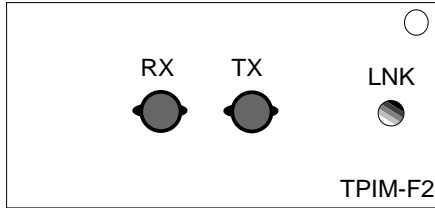

Figure 2-6. The TPIM-F2

Note: The transmitter power levels and receive sensitivity levels given are Peak Power Levels after optical overshoot. A Peak Power Meter must be used to correctly compare the values given to those measured on any particular port. If Power Levels are being measured with an Average Power Meter, then 3 dBm must be added to the measurement to correctly compare those measured values to the values listed (i.e. -30.5 dBm peak=-33.5 dBm average).

Parameter	Typical Value	Worst Case	Worst Case Budget	Typical Budget
Receive Sensitivity:	-30.5 dBm	-28.0 dBm	—	—
Peak Input Power:	-7.6 dBm	-8.2 dBm	—	—
<u>Transmitter Power</u>				
50/125 μm fiber:	-13.0 dBm	-15.0 dBm	13.0 dB	17.5 dB
62.5/125 μm fiber:	-10.0 dBm	-12.0 dBm	16.0 dB	20.5 dB
100/140 μm fiber:	-7.0 dBm	-9.0 dBm	19.0 dB	23.5 dB
Error Rate:	Better than 10^{-10}			

TPIM-F3

The TPIM-F3 shown in Figure 2-7 is an ST connector that supports Single Mode fiber Optic cabling.

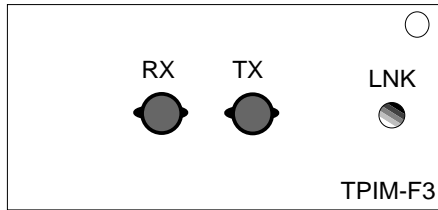
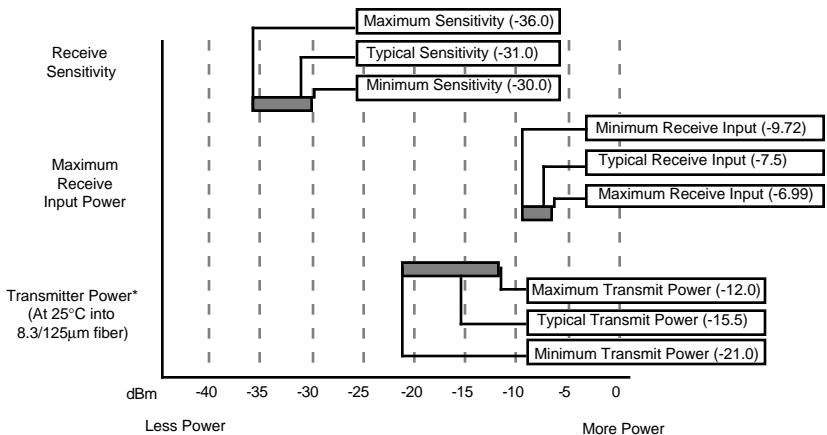

Figure 2-7. The TPIM-F3

Note: Transmitter Power decreases as temperatures rise and increases as temperatures fall. Use the Output Power Coefficient to calculate increased or decreased power output for your operating environment. For example, the typical power output at 25°C is -16.4 dBm. For a 4°C temperature increase, multiply the typical coefficient (-0.15 dBm) by four and add the result to typical output power ($4 \times -0.15 \text{ dBm} + -16.4 = -17.0$).



* Transmit Power Coefficient	Typical Power	Minimum Power	Maximum Power
	-0.15dBm/°C	-0.12 dBm/°C	-0.18 dBm/°C

REQUIREMENTS/SPECIFICATIONS

Parameter	Typical	Minimum	Maximum
Transmitter Peak Wave Length	1300 nm	1270 nm	1330 nm
Spectral Width	60 nm	-	100 nm
Rise Time/ Fall Time	3.0 nsec 2.5 nsec	2.7 nsec 2.2 nsec	5.0 nsec 5.0 nsec
Duty Cycle	50.1%	49.6%	50.7%
Bit Error Rate:	Better than 10^{-10}		

Note: *The transmitter power levels given above are Peak Power Levels after optical overshoot. You must use a Peak Power Meter to correctly compare the values given above to those measured on any particular port. If you are measuring power levels with an Average Power Meter, add 3 dBm to the average power measurement to correctly compare the average power values measured to the values listed above (i.e., -33.5 dBm average + 3 dB = -30.5 dBm peak).*

REQUIREMENTS/SPECIFICATIONS

2.5 GENERAL SPECIFICATIONS

The operating specifications for the TRXI are described in this section. Cabletron Systems reserves the right to change these specifications at any time without notice.

Data Buffer Memory (RAM):	4 MB (Upgradeable)
Internal Processor:	Intel 80C960CA at 16 MHz
Controller:	Texas Instruments TMS380
Static RAM:	128 KB with battery back-up
EPROM:	128 KB
FLASH MEMORY:	2 MB (Upgradeable)

POWER SUPPLY REQUIREMENTS

Note: The TRXI has a universal power supply. This unit allows you to use an input power from 85 to 264 VAC, 47-63 Hz.

The power supply has two outputs of +5 volts and +12 volts. The maximum output power is 125 watts and the minimum efficiency is 65% under all conditions of line at full load. The minimum and maximum load current from each output is shown below.

Output	Min. Load	Max. Load	Max Power
+5 Volts	1.00 Amps	15 Amps	75 Watts
+12 Volts	0.15 Amps	4 Amps	48 Watts

ENVIRONMENTAL REQUIREMENTS

Operating Temperature:	+5° to +50°C
Non-operating Temperature:	-30° to +90°C
Operating Humidity:	5 to 95% (non-condensing)

REQUIREMENTS/SPECIFICATIONS

SAFETY

This unit meets the safety requirements of UL 1950, CSA C22.2 No. 950 and EN 60950; the EMI requirements of FCC Class A and EN 55022 Class A; and the EMC requirements of EN 50082-1.

Warning: *It is the responsibility of the person who sells the system to which the TRXI will be a part to ensure that the total system meets allowed limits of conducted and radiated emissions.*

PHYSICAL

Dimensions: 2.8H x 17.0W x 13.5D inches
 (7.2H x 43.6W x 34.6D cm)

Weight:

Unit: 7.95 pounds
Shipping: 11.95 pounds

SERVICE

MTBF >944,197 hours projected

MTTR <0.5 hour

CHAPTER 3

INSTALLATION

This chapter outlines the procedure for installing a TRXI and connecting it to a network. Be sure that your network meets the guidelines and requirements outlined in Chapter 2, **Requirements/Specifications**, before installing the TRXI.

3.1 UNPACKING THE TRXI

Unpack the TRXI as follows:

- Remove the TRXI from the shipping box.
- Slide the two foam end caps off the TRXI.
- Remove the TRXI from the protective plastic bag and set it aside to prevent damage.
- Visually inspect the TRXI. If there are any signs of damage, contact Cabletron Systems Technical Support immediately.

3.2 ATTACHING THE STRAIN RELIEF BRACKET

Attach the strain relief bracket to the front of the TRXI as follows:

1. Locate the strain relief bracket and four 8-32 x 3/8" screws from the TRXI installation kit.

Caution: *Use of longer screws may cause damage to the unit or electrical shock.*

INSTALLATION

2. Attach the strain relief bracket to the bottom of the TRXI as shown in Figure 3-1.

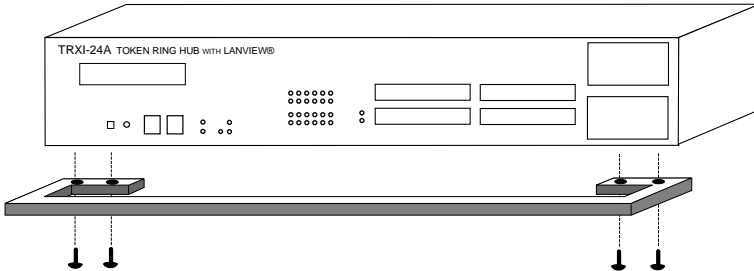

Figure 3-1. Attaching the Strain Relief

3.3 INSTALLING THE TRXI

The TRXI can be rack mounted, wall mounted, or placed on any horizontal surface. Select one of the following subsections and perform the steps that are applicable for your installation. If you decide not to install the TRXI in a 19-inch rack, the following requirements must be met when selecting a location.

Note: Be sure that the location selected is within reach of the network cabling.

- An unrestricted free surface area at least 21 inches wide, 18 inches deep and 6 inches high is needed.
- A single phase 85 to 264 Vac, 15A, grounded power receptacle must be located within 7 feet of the site.
- If a shelving unit is to be used, it must be able to support 30 pounds of static weight.
- The temperature for the selected location must be maintained between 5° and 50°C, and less than 10°C per hour temperature change.

3.3.1 Rack Mounting the TRXI

Refer to Figure 3-2 and perform these steps to install the TRXI in a 19-inch rack.

1. Remove four cover screws (two from each side) located along the front edges of each side of the TRXI.
2. Using the four cover screws removed in step 1, attach the rack mounting brackets to each end of the TRXI.

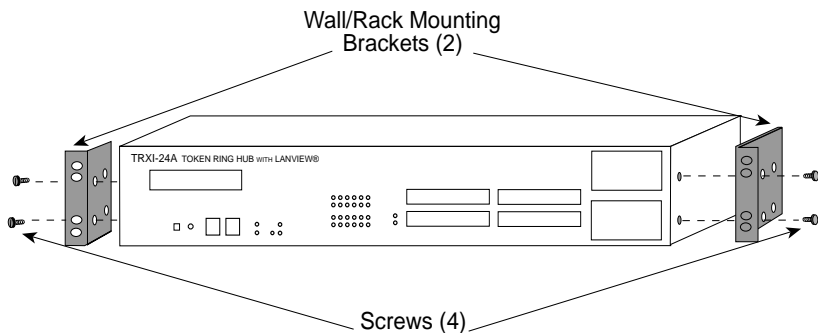

Figure 3-2. Rack Mount Brackets Installation

3. With the mounting brackets installed, position the TRXI between the vertical frame members of the 19-inch rack and fasten it securely with the mounting screws (see Figure 3-3).

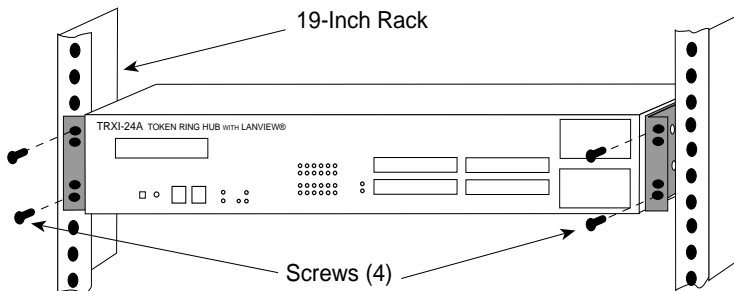

Figure 3-3. Installing the TRXI in the Rack

INSTALLATION

3.3.2 Wall Mounting the TRXI

When you wall mount the TRXI, the cable connections must face down. Perform the following steps to wall-mount the TRXI.

Note: 1/4-inch Molly screw anchors for wall mounting are not included with the TRXI.

1. Use the supplied screws to attach the wall mounting brackets to the bottom of the TRXI as shown in Figure 3-4. There are two brackets, one for each side.

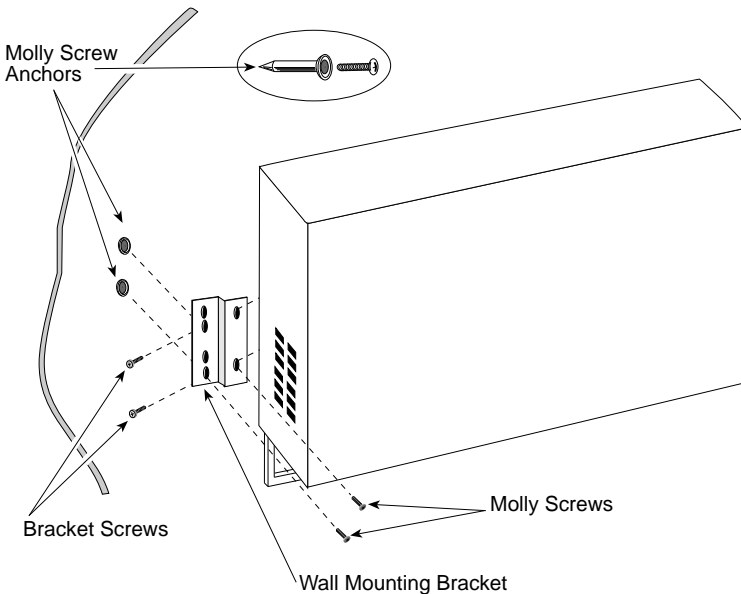

Figure 3-4. Wall Mounting the TRXI

2. Select the wall location for the TRXI within 7 feet of a power outlet.

Warning: There is a potential **SHOCK HAZARD** if there is electrical wiring within the wall that interferes with drilling for pilot holes. Select a wall location where drilling pilot holes for the Molly screws will not come in contact with electrical wiring in the wall.

3. You will need a pencil for this step. With the wall mounting brackets attached to the TRXI, position the TRXI against the wall where it will be permanently mounted with the network port facing down. Using a pencil, mark the wall location for the four pilot holes.
4. Set the TRXI aside and carefully drill four 1/4" pilot holes, one for each of the Molly screw anchors and insert the four Molly screw anchors into the holes just drilled.
5. Tighten each of the anchor screws until the anchor expands holding the anchor firmly in the wall, then remove the screws completely.
6. Position the TRXI on the wall over the anchors and reinstall the four anchor screws to attach the TRXI to the wall, as shown in Figure 3-4. Tighten the four anchor screws.

3.3.3 Free-Standing Installation

For a free-standing shelf or tabletop installation, locate the TRXI within 7 feet of its power source and with an unrestricted free surface area 21 inches wide, 18 inches deep and 6 inches high, as shown in Figure 3-5.

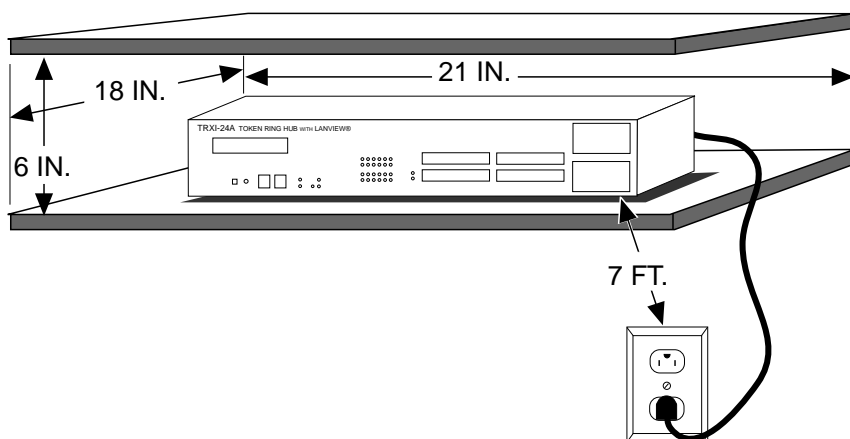

Figure 3-5. Free-Standing Installation

INSTALLATION

3.4 SETTING THE RING SPEED SWITCH

This section explains how to change the TRXI's ring speed from the factory default setting of 16 Mbps to 4 Mbps. To change the ring speed, you need to set the switch located inside the TRXI as shown in Figure 3-6. You can access the switch through the air vent with a small screwdriver.

To change the ring speed:

1. Turn off the TRXI.
2. Place a small screwdriver through the TRXI's air vent to access the Ring Speed Switch.
3. Use the screwdriver to slide the switch to the desired setting as shown in Figure 3-6.
4. Turn on the TRXI.
5. Check that the Ring Speed LED indicates the correct setting.

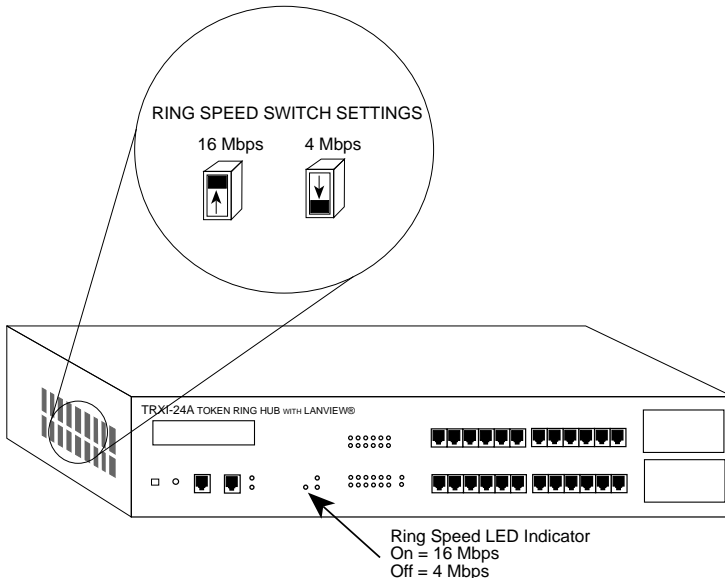

Figure 3-6. The Ring Speed Switch

3.5 SETTING THE NVRAM SWITCH

Figure 3-7 shows the location of the NVRAM Reset Switch. The TRXI uses NVRAM (Non-Volatile Random Access Memory) to store user entered parameters such as IP address and device name. The NVRAM Reset Switch restores these parameters to the factory defaults.

You do not have to remove the chassis cover to access the NVRAM switch.

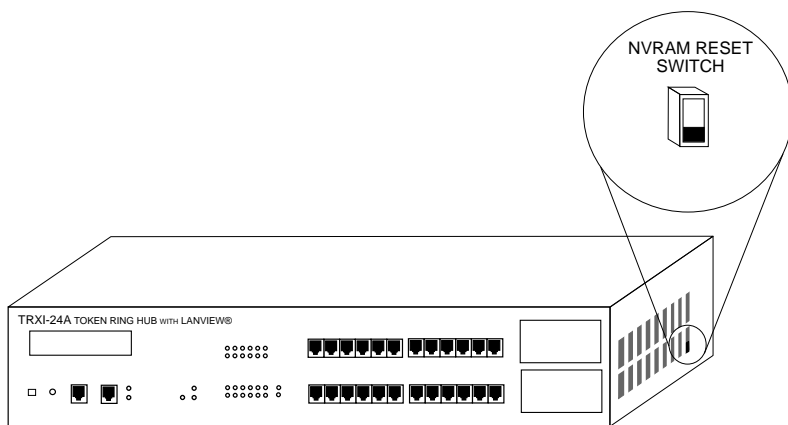

Figure 3-7. NVRAM Reset Switch

To restore TRXI parameters to the factory defaults:

1. Change the state of this switch (i.e., move the switch from one position to another).
2. Press the TRXI's Reset button.

You can now use the factory default settings or re-enter your own parameters. The TRXI stores these parameters in NVRAM during normal operation and during power down, and they remain there until you change the switch again.

Caution: Do not change the state of the NVRAM switch unless you intend to reset the TRXI user parameters to the factory default settings.

INSTALLATION

3.6 CONNECTING THE TRXI TO THE POWER SOURCE

Note: The TRXI has a universal power supply. This allows you to connect the TRXI to power sources from 85 Vac to 264 Vac, 47-63 Hz.

To connect the TRXI to the power source, plug the power cord into a grounded wall outlet. Turn on the power switch at the back panel of the TRXI. Verify that the **PWR** LED is lit, indicating that the TRXI is receiving power. After the TRXI runs a self test, the **CPU** LED blinks green indicating normal operation. If the LED remains red, the processor is faulty.

3.7 CONNECTING THE NETWORK LOBE PORT CABLING

The TRXI-22A/24A network lobe ports consist of unshielded RJ45 connectors that support UTP cabling. To connect a UTP segment from the TRXI to a station supporting STP cabling, you need a Type 3 Media Filter available from Cabletron Systems (TRMF, TRMF-2).

The TRXI-42A/44A network lobe ports consist of shielded RJ45 connectors that support STP cabling. Shielded patch cables that adapt a shielded RJ45 to a data connector (MIC) are available from Cabletron Systems (PN 9372057-8). These adapter/patch cables let you connect to an existing patch panel equipped with data connectors. Figure 3-8 shows the TRXI's network lobe port pinouts.

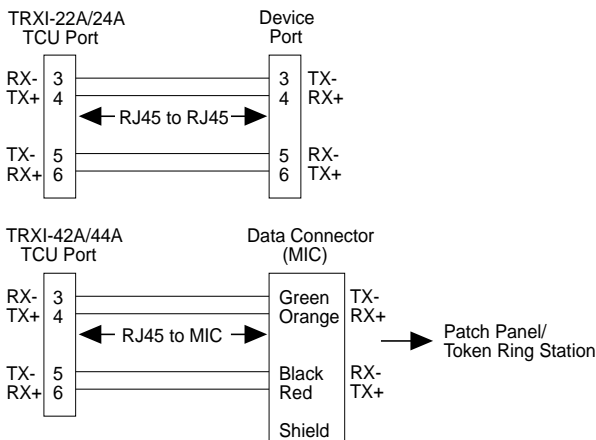

Figure 3-8. Network Lobe Port Pinouts

Figure 3-9 illustrates possible configurations for both the TRXI-24A and TRXI-44A.

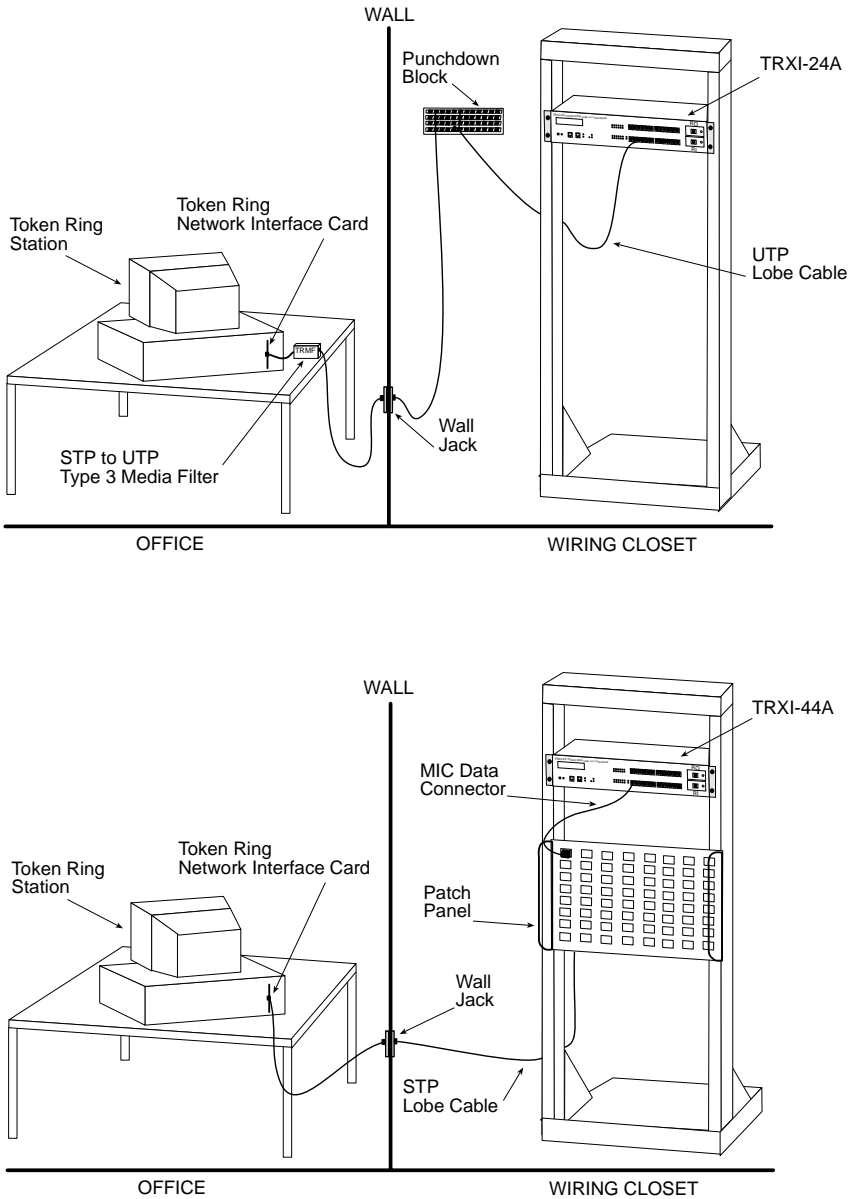

Figure 3-9. Configuration Examples for TRXI-24A and TRXI-44A

INSTALLATION

To attach a UTP or STP lobe segment to a TRXI network port:

1. Insert the RJ45 connector from each twisted pair segment into the desired RJ45 network lobe port number on the TRXI as shown in Figure 3-10.

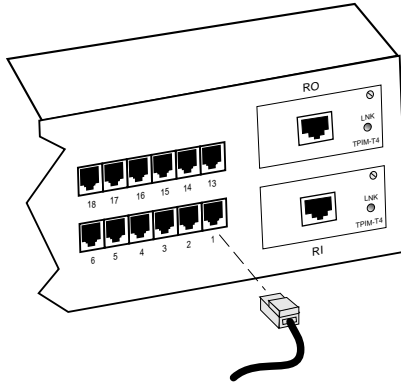

Figure 3-10. TRXI Network Ports

2. The associated Port Status LED will light green when the station boots up. If the LED is not lit, perform each of the following steps until it is:
 - a. Check that the device at the other end of the twisted pair segment is on and the network interface driver is initialized.
 - b. Verify that the RJ45 connector on the twisted pair segment has the proper pinouts.
 - c. Check the cable for continuity.
 - d. Check that the twisted pair connection meets dB loss and cable specifications outlined in Chapter 2.
 - e. Check Local Management to ensure the port is enabled.

If a link still has not been established, contact Cabletron Systems Technical Support.

3.8 INSTALLING THE TPIM RI/RO MODULES

TPIMs provide RI/RO trunk port connections that support various media for trunk cabling. You can attach different media types at the Ring-In port and Ring-Out port. For example, you can insert a TPIM-T1 as the Ring-In port and a TPIM-T4 as the Ring-Out port.

The following sections explain how to set the Phantom Switch, set the RI/RO Switch, install the TPIM to the TRXI, and attach segments to the TPIM.

Prior to connecting trunk cabling to the TPIMs, check the connectors for proper pinouts. Table 3-1 provides a cross-reference of pinouts for TPIMs used for Ring-In or Ring-Out applications.

Table 3-1. Pinout Cross-Reference for TPIMs

Signal	TPIM-T2/T4 (RJ45)	TPIM-T2/T4 (RJ45)	TPIM-T1 (DB9)	TPIM-T1 (DB9)
	Ring-In	Ring-Out	Ring-In	Ring-Out
TX+	6	4	9	1
TX-	3	5	5	6
RX+	4	6	1	9
RX-	5	3	6	5

INSTALLATION

3.8.1 Setting the TPIM's Phantom Switch and RI/RO Switch

Before you install a TPIM, set the Phantom Switch to the appropriate setting. This switch enables the port to “autowrap” if a trunk cable fails or is removed. Figure 3-11 shows the location of the Phantom Switch. If you attach a Cabletron hub to the TPIM, leave the switch at the factory default setting of 1. If you attach a Non-Cabletron device to the TPIM, use the 0 setting.

Ensure that the Ring-In/Ring-Out Switch is in the factory default RI/RO position. The TRXI does not support the Station (S) setting at this time.

Note: If the switch locations on your TPIM do not match the locations illustrated in Figure 3-11, refer to the TPIM Reference Card included with the TPIM. The TPIM Reference Card outlines the current switch locations and settings. If you have any questions, call Cabletron Systems Technical Support.

Top View

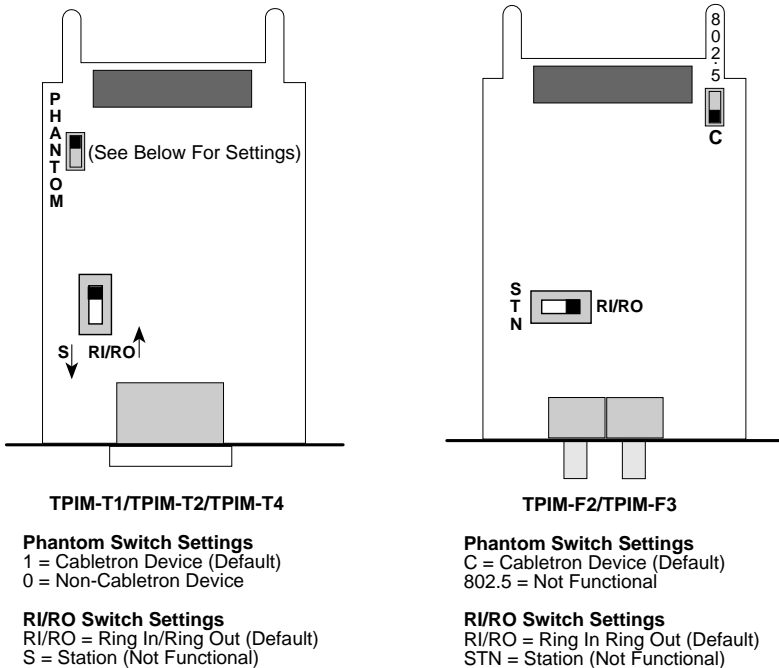

Figure 3-11. The Phantom and RI/RO Switches

3.8.2 Installing a TPIM to the TRXI

To install a TPIM, perform the following steps:

Caution: *Observe all static precautions while handling TPIMs.*

1. Remove the mounting screw from the faceplate of the RI/RO port on the TRXI.
2. If you are replacing a TPIM, remove the mounting screw and pull the TPIM straight out from the TRXI.
3. Slide the new TPIM into place as shown in Figure 3-12.
4. Ensure the connectors on the rear of the module and on the inside of the TRXI mate properly.
5. Reinstall the mounting screw.

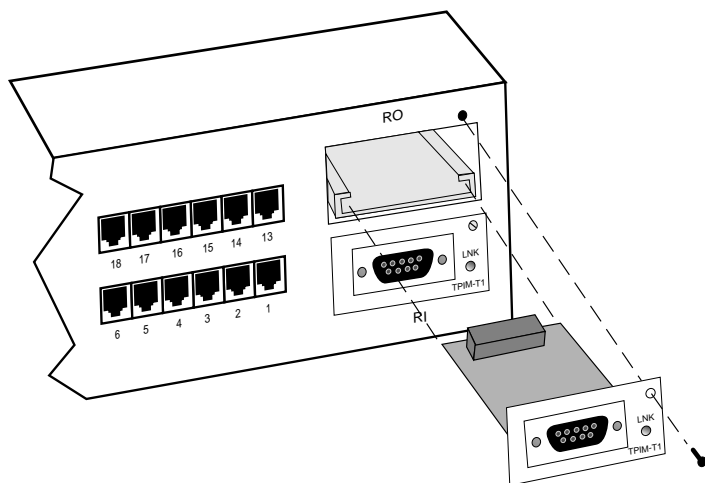

Figure 3-12. Installing a TPIM

INSTALLATION

3.8.3 Connecting a Twisted Pair Segment to the TPIM-T1

Before connecting a segment to the TPIM-T1, check each end of the segment to determine if the wires have been pinned properly.

To connect a TPIM-T1 to a Twisted Pair Segment:

1. Insert the DB9 connector on the segment into the DB9 port on the TPIM as shown in Figure 3-13.

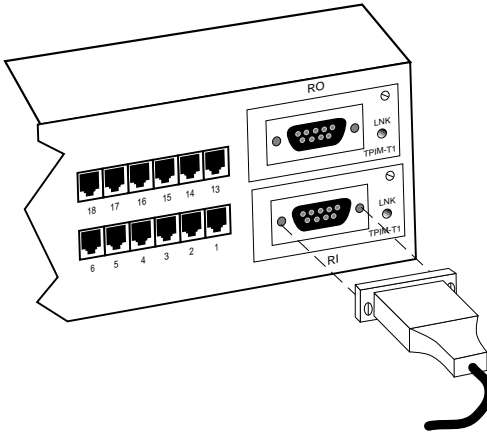

Figure 3-13. The TPIM-T1

2. Check that the **LNK** LED on the TPIM lights green. If the LED lights red or is not lit, perform each of the following steps until it is:
 - a. Check that the device at the other end of the segment is on.
 - b. Verify that the DB9 is pinned properly.
 - c. Check the cable for continuity.
 - d. Check that the twisted pair connection meets dB loss and cable specifications outlined in Chapter 2.
 - e. Check that the port is enabled through the Local Management.

If a link still has not been established, contact Cabletron Systems Technical Support.

3.8.4 Connecting a Twisted Pair Segment to the TPIM-T2 or TPIM-T4

The TPIM-T2 supports UTP cabling and the TPIM-T4 supports STP cabling. The method for connecting an RJ45 connector to an RJ45 port is the same for both UTP and STP cabling. Before connecting a segment to the TPIM-T2 /T4, check each end of the segment to ensure the wires are pinned properly. To connect a segment to a TPIM-T2/T4:

1. Insert the RJ45 connector on the twisted pair segment into the RJ45 port on the TPIM as shown in Figure 3-14.

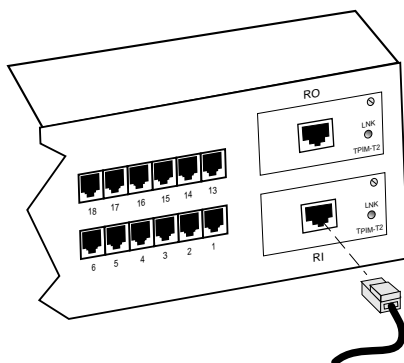

Figure 3-14. The TPIM-T2/T4

2. Check that the **LNK** LED on the TPIM lights green. If the LED lights red or is not lit, perform each of the following steps until it is:
 - a. Check that the device at the other end of the segment is on.
 - b. Verify that the RJ45 is pinned properly.
 - c. Check the cable for continuity.
 - d. Check that the twisted pair connection meets dB loss and cable specifications outlined in Chapter 2.
 - e. Check that the port is enabled through Local Management.

If a link still has not been established, contact Cabletron Systems Technical Support.

3.8.5 Connecting a Fiber Optic Link Segment to the TPIM-F2 or TPIM-F3

When connecting a fiber optic link segment to the TPIM-F2 or TPIM-F3 keep the following in mind:

- If you are connecting a fiber optic link segment with ST connectors to a TPIM-F2 with ST ports, keep in mind that ST connectors attach to ST ports much like BNC connectors attach to BNC ports. The connector is inserted into the port with the alignment key on the connector inserted into the alignment slot on the port. The connector is then turned to lock it down.
- The physical communication link consists of two strands of fiber optic cabling: the Transmit (TX) and the Receive (RX). The Transmit strand from the applicable port on the module will be connected to the Receive port of a fiber optic device at the other end of the segment. For example, TX of the applicable port on the module will go to RX of the other fiber optic device. The Receive strand of the applicable port on the module will be connected to the Transmit port of the fiber optic device. For example, RX of the applicable port on the module will go to TX of the other fiber optic device.

It is recommended that you label the fiber optic cable to indicate which fiber is Receive and which is Transmit. When you buy fiber optic cable from Cabletron Systems, it is labeled so that: at one end of the cable, one fiber is labeled 1, and the other fiber is labeled 2. This pattern is repeated at the other end of the cable. If you did not purchase your cable from Cabletron Systems, be sure you have labeled your cable in the manner described above.

Caution: Do not touch the ends of the fiber optic strands, and do not let the ends come in contact with dust, dirt, or other contaminants. Contamination of the ends can cause problems in data transmissions. If the ends become contaminated, clean them with alcohol using a soft, clean, lint free cloth.

To connect a fiber optic link segment to the TPIM-F2 or TPIM-F3:

1. Remove the protective plastic covers from the fiber optic ports on the applicable port on the module and from the ends of the connectors on each fiber strand.
2. Attach the fiber labeled 1 to the applicable receive port, labeled **RX**, on the module as shown in Figure 3-15.

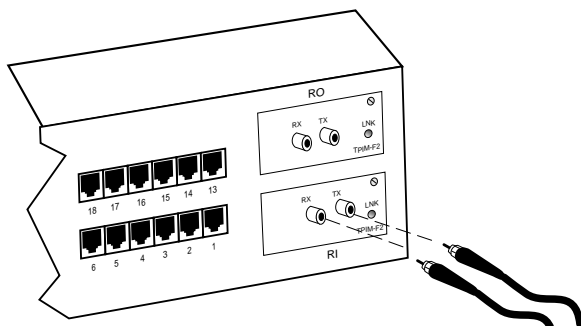

Figure 3-15. The TPIM-F2/F3

3. Attach the fiber labeled 2 to the applicable transmit port labeled **TX**, on the module.
4. At the other end of the fiber optic cable, attach the fiber labeled 1 to the transmit port of the device.
5. Attach the fiber labeled 2 to the receive port.
6. Check that the **LNK** LED on the TPIM lights green. If the LED does not light, perform each of the following steps until it is:
 - a. Check that the power is turned on for the device at the other end of the link.
 - b. Verify that the fiber strands are properly “crossed-over” between the applicable port on the module and the fiber optic device at the other end of the fiber optic link segment.

INSTALLATION

- c. Verify that the fiber connection meets the dB loss specifications outlined in Fiber Optic Network Requirements.
- d. Check that the port is enabled through TRXI Local Management.

If a link still has not been established, contact Cabletron Systems Technical Support.

3.9 FINISHING THE INSTALLATION

The TRXI is now ready for operation. Before placing the network into service, test the installation thoroughly, making sure that all stations are able to be addressed and that the TRXI and all stations are indicating normal operation. Ensure that the networking software is configured properly to match the installed network. If you encounter errors or abnormal operation, proceed to Chapter 4, **Testing and Troubleshooting**.

CHAPTER 4

TESTING AND TROUBLESHOOTING

This chapter contains procedures for testing the TRXI after you connect it to the network. It also describes LANVIEW and explains how to use the LCD to troubleshoot physical layer network problems.

4.1 CHECKING THE INSTALLATION

Perform the following to check the installation of the TRXI:

1. Trace the ring path through the network to be sure that there are no breaks in the ring and that it is free from logical design errors.
 - a. Check each cable connection.
 - b. Verify the pinouts for every connection.
 - c. Check the cable conductors for continuity. Cable testers are available for this task.
 - d. Check that cable connections at patch panels and wall plates are secure.
2. Check the network ring speed:
 - a. Check the Ring Speed LED. Ensure the ring speed matches the station and cable specifications mentioned in Chapter 2.
 - b. Be sure that all devices in the ring network are set to the same ring speed. Check all stations in the network.
3. Ensure that the maximum cable length for **EACH** station and the maximum number of stations are not exceeded.

When you complete each of these checks successfully, the TRXI is ready for normal operation. If problems occur, contact Cabletron Systems Technical Support.

TESTING AND TROUBLESHOOTING

4.2 USING LANVIEW LEDs

LANVIEW is Cabletron Systems' built-in visual diagnostic and status monitoring system. Using LANVIEW, your network troubleshooting personnel can quickly scan the LANVIEW LEDs to observe network status or diagnose network problems, and determine which node or segment is faulty. Figure 4-1 describes each of the front panel LANVIEW LEDs.

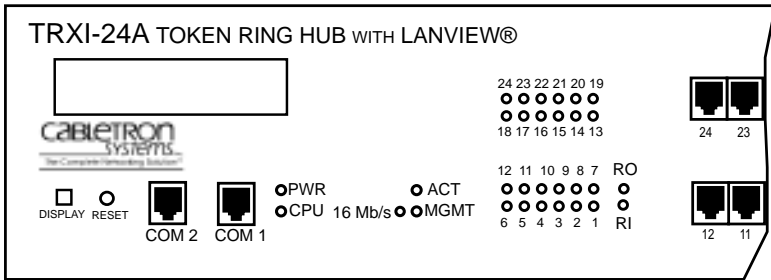

LED NAME	LED COLOR	DEFINITION
Lobe Port Status (Ports 1-24)	Off Green (Solid) Green (Blinking)	Port Enable-No Link or Port Disable-No Link Port Enable-Link Port Disable-Link or Ring Speed Fault
RI/RO (Ring In/Ring Out)	Green (Solid) Red (Solid)	TPIM Inserted TPIM Not Inserted
PWR (Power)	Off Green (Solid)	No Power Power
16 Mb/s (Ring Speed)	Yellow (Solid) Off	16 Mbps Ring Speed 4 Mbps Ring Speed
ACT (Network Activity)	Green (Flashing) Red (Flashing) Off	Good Frames Beacon Frames No Activity
MGMT (Network Management)	Green (Solid) Red (Solid)	Management Agent Inserted Management Agent Not Inserted
CPU (Central Processing Unit)	Off Green (Flashing) Green (Blinking) Red (Solid)	CPU In Boot Process CPU Initializing CPU Functioning CPU Not Functioning

Note: "Flashing" indicates an irregular LED pulse.
"Blinking" indicates a steady LED pulse.

Figure 4-1. LANVIEW LEDs

4.3 USING THE LCD DISPLAY

The TRXI is equipped with an LCD as shown in Figure 4-2. The LCD is a diagnostic tool that lets you view important status information about the TRXI such as:

- Power up diagnostics
- Revision levels
- Hardware MAC address
- IP address
- Error alerts.

The LCD presents four types of messages: Static System Messages, Saved Alarm Messages, Unsaved Initialization Messages, and Saved System Messages. The following sections describe each message.

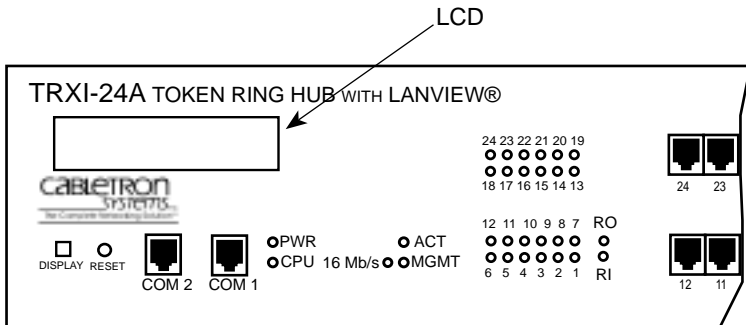

Figure 4-2. LCD Display

TESTING AND TROUBLESHOOTING

4.3.1 Static System Messages

These messages display TRXI configuration information. To view the Static System Messages, momentarily press the Display button located below the LCD window. Press the Display button to scroll through each message. If you do not press the Display button within ten seconds, the display defaults back to the product name.

<u>Displayed Message</u>	<u>Comments</u>
IP Address xxx.xxx.xxx.xxx	Displays the current IP address. This may be changed through Local Management.
MAC Address 0000B8xxxxxx	Displays the Hardware or MAC address.
RAM Image Rev. xx.xx.xx	Displays the revision number of the Flash EEPROM.
Boot PROM Rev. xx.xx.xx	Displays the revision number of the internal Boot PROM.
Flash Programmed xx Times	Displays the number of times the the Flash EEPROM has been programmed
COM 1 Baud Rate xxxxxx	Displays the current baud rate of the COM 1 port.
COM 1 Function xxxxxx	Displays the current function (Console, Modem, UPS, or SLIP) of the COM 1 port.
COM 2 Baud Rate xxxxxx	Displays the current baud rate of the COM 2 port.
COM 2 Function xxxxxx	Display the current function (-N/A-, Console, Modem, UPS, or SLIP) of the COM 2 port.

4.3.2 Alarm Messages

Alarm messages pertain to events that occur within the TRXI. Press the Display button and hold for five seconds to access the Alarm Messages queue. You can scroll through each message by pressing the Display button. If you do not press the Display button for ten seconds, the LCD defaults to the product name.

<u>Displayed Messages</u>	<u>Comments</u>
No Messages in Queue	No alarm messages in queue. This is the Alarm Messages default setting.
Port xxxxxx Disabled	Network port or TPIM turned off via Local or Remote Management.
Port xxxxxx Enabled	Network port or TPIM turned on via Local or Remote Management.
Port xx Violation	Indicates unauthorized access attempt at network lobe ports.
Ring Beaconsing	Indicates a station is attempting to recover from a hardware problem on the ring.
Beacon Recovered	Indicates the ring has recovered from a beaconsing situation.
Beacon Recv Port xx Removed	Indicates that a station has been removed from the ring as a result of the beacon recovery process.
Ring Port xx Faulted	Indicates a TPIM RI or RO has Autowrapped.
Fault Recovery Oscillation	Indicates that the network has been in and out of a beaconsing state several times.

TESTING AND TROUBLESHOOTING

4.3.3 Unsaved Initialization Messages

These are power-up messages that appear on the LCD as the event occurs but are not saved in a buffer for future recall. If **Failure or Error Messages** appear, call Cabletron Technical Support.

Failure or Error Messages

Cabletron Ctrl. Reg. Err.	Cabletron BBRAM Failure
Cabletron SDRAM Failure	Cabletron Modem SCC Error
Cabletron Bit Swap Failure	Cabletron Console SCC Error
Cabletron LDRAM Failure	Cabletron 82C54 Failure
Cabletron Eagle Failure	

Normal Unsaved Initialization Messages

Cabletron Hardware Init	Cabletron Boot From Flash	Cabletron Eagle Test
Cabletron BOOTP Discovery	Cabletron RARP Req. State	Cabletron Bit Swap Test
Cabletron TFTP Req. State	Cabletron TFTP in Progress	
Cabletron TFTP Complete	Cabletron Erasing Flash	
Cabletron Writing Flash	Cabletron Flash Programmed	
Cabletron Test in Progress	Cabletron Programming LRAM	
Cabletron Boot Complete	Cabletron TRXI-xx Cabletron	

4.3.4 Saved System Messages

Saved System Message are device related start-up or boot strap messages, BOOTP/TFTP host, or start-up error messages. To access the Saved System Messages queue, you must first enter the Saved Alarm Messages queue. While in the Alarm Messages queue, press the Display button and hold for five seconds. You can scroll through each message by pressing the Display button. If you do not press the Display button for ten seconds, the LCD defaults to the product name.

Displayed Message

TFTP Host

xxx.xxx.xxx.xxx

TFTP File

XXXXXXXXXXXXXXXXXX

Last TFTP Host

xxx.xxx.xxx.xxx

Last TFTP File

XXXXXXXXXXXXXXXXXX

BootP Host

xxx.xxx.xxx.xxx

CHAPTER 5

LOCAL MANAGEMENT

This chapter explains how to set up a management terminal to access the TRXI's Local Management. It also explains the Local Management screens and instructions for using them.

Local Management provides the tools to manage the TRXI and all of its attached segments. You can change factory defaults, enable/disable ports, and use the advanced features of Local Management to:

- control access to your token ring network using the Ring Security feature
- assign an IP address and subnet mask
- set interface parameters for both serial ports, Local Management (Console), Serial Line Internet Protocol (SLIP), Uninterruptible Power Supply proxy (UPS), or Modem
- control password access to the TRXI through the community names established in the Community Names Table
- designate which Network Management Workstations receive trap alarms from the device
- navigate through the Management Information Base (MIB) and manage the objects within it from a remote location. Given the appropriate security level, the MIB is accessible from the TRXI through the SNMP Tools screen.

LOCAL MANAGEMENT

5.1 MANAGEMENT TERMINAL REQUIREMENTS

To access TRXI Local Management, you need either:

- a Digital Equipment Corporation VT series terminal
- a VT type terminal running emulation programs for the Digital Equipment Corporation VT series
- an IBM or compatible PC running a VT series emulation software package.

5.1.1 Attaching the Management Terminal

Cabletron supplies an RJ45 Cable Kit with the TRXI. This kit includes a UTP console cable with RJ45 connectors on each end. It also provides adapters for DB9 or DB25 connections. Refer to the RJ45 Cable Kit Instruction Sheet for adapter pinouts and additional instructions.

To attach the management terminal to the TRXI's COM 1 port:

1. Attach the male RJ45 connector to the COM 1 port of the TRXI as shown in Figure 5-1.
2. Attach the female end (25-pin or 9-pin, as applicable) to the COM port on the terminal.

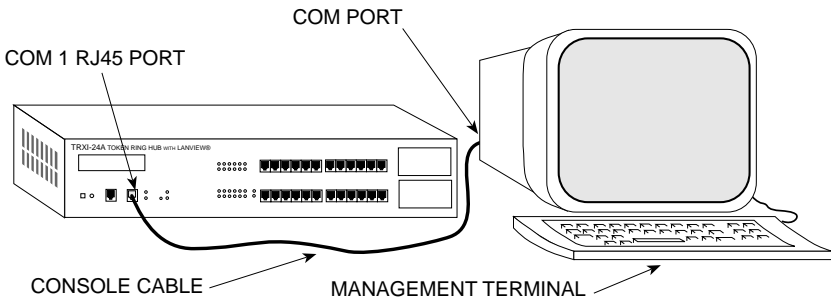

Figure 5-1. Management Terminal Connection

5.1.2 Setting the Management Terminal Setup Parameters

Table 5-1 lists the setup parameters for the local management terminal. If you have a Digital Equipment Corporation VT terminal, press **F3** to access the Setup Directory. If you have a PC emulation of the Digital Equipment VT terminal, refer to your equipment user manual for setup parameters.

Table 5-1. VT Terminal Setup Parameters

MENU	FUNCTION	SELECTION
Display Setup:	Columns	80 Columns
	Controls	Interpret Controls
	Auto Wrap	No Auto Wrap
	Test Cursor	Cursor
General Setup:	Mode	7 Bit Control
	Cursor Keys	Normal Cursor Keys
Communications Setup:	Transmit	Transmit = 9600
	Receive	Receive = Transmit
	XOFF	any option
	Bits, Parity	8 Bits, No Parity
	Stop Bit	1 Stop Bit
	Local Echo	No Local Echo
	Port	DEC-423, Data Leads Only
	Transmit	any option
	Auto Answerback	No Auto Answerback
Keyboard Setup:	Auto Repeat	any option
	Keyclick	any option
	Margin Bell	Margin Bell
	Warning Bell	Warning Bell
	Auto Answerback	No Auto Answerback

LOCAL MANAGEMENT

5.1.3 Modem Cable Configuration and Setup

To access Local Management from a modem, use an RS-232 cable available from Cabletron Systems. This cable connects the modem to the TRXI COM 2 port. Figure 5-2 shows the pinout for a cable with an RJ45 connector at the TRXI end of the cable.

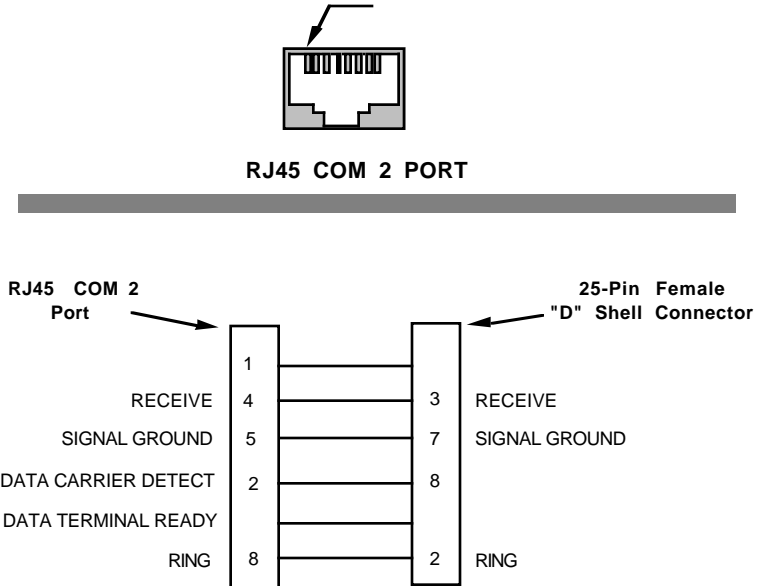

Figure 5-2. Modem Cable Pinouts

To access Local Management, proceed as follows:

1. Turn the modem on. The modem must be set for Auto Answer and Data Carrier Detect must be active. Refer to your modem's user manual for operating instructions.
2. Call the modem. The TRXI Password screen appears when you establish a connection.

5.2 ACCESSING LOCAL MANAGEMENT

With your terminal properly configured and the correct physical cable connections in place, you can access Local Management.

To access Local Management:

1. Turn the terminal on. The TRXI Password screen shown in Figure 5-3 appears.

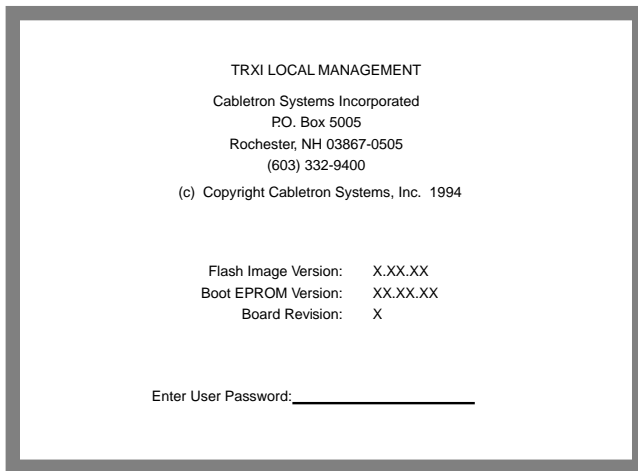

Figure 5-3. TRXI Password Screen

2. Enter your **Password**. (The factory default password is the **Return** key.)

Note: Your password is one of the community names specified in the Community Name Table. Access to certain Local Management capabilities depends on the degree of access accorded that community name. See Section 5.3.2 for more information about community names.

3. If your password is valid, the Main Menu screen shown in Figure 5-4 appears. If your password is not valid, the cursor returns to the beginning of the password field.

LOCAL MANAGEMENT

5.3 USING LOCAL MANAGEMENT

TRXI Local Management consists of three menu screens:

- the Main Menu screen
- the Device Setup screen
- and the Device Status screen.

Menu screens list TRXI Local Management options. Figure 5-4 shows the menu screens and each Local Management option. The following sections explain how to select and use each of the Local Management options.

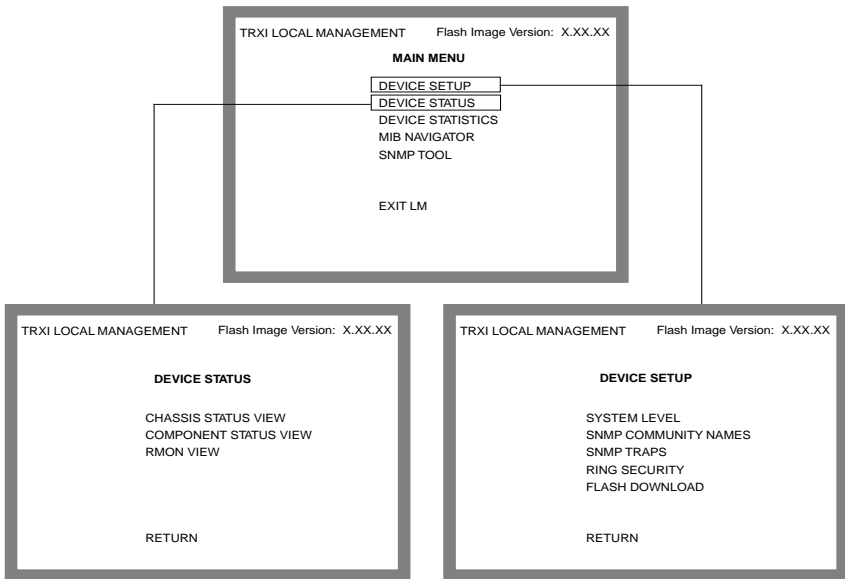

Figure 5-4. Local Management Menu Screen

Selecting a Menu Option

To select a menu option:

1. Use the arrow keys to highlight a menu option.
2. Press **Return**. The selected screen appears.

Exiting a Local Management Screen

To exit a Local Management screen:

1. Use the arrow keys to highlight the RETURN command at the bottom of the screen.
2. Press **Return**. Local Management returns to the associated Menu screen.

Exiting Your Local Management Session

To exit your Local Management session:

1. Use the arrow keys to highlight the RETURN command at the bottom of the screen.
2. Repeat Step 1 until you arrive at the Main Menu screen.
3. Use the arrow keys to highlight the EXIT LM command at the bottom of the Main Menu screen.
4. Press **Return**. The Password screen appears.

LOCAL MANAGEMENT

5.3.1 The System Level Screen

The System Level screen lets you view TRXI information such as COM port status and MAC address. You can also use the System Level screen to set the IP Address, Subnet Mask, and System Date/System Time. Figure 5-5 shows the System Level screen.

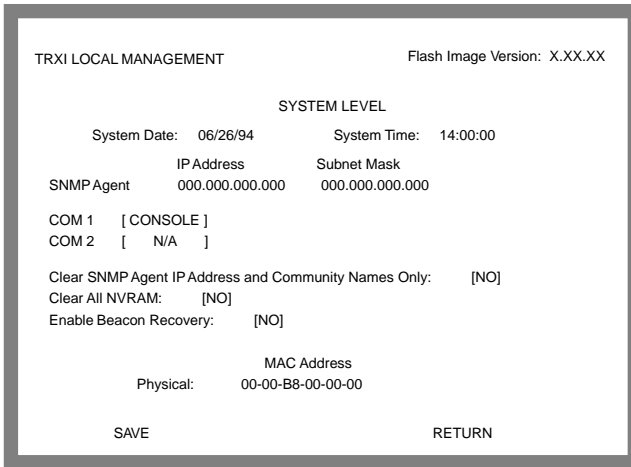

Figure 5-5. System Level Screen

The following sections provide a brief explanation of each field on the System Level screen and instructions for using them.

System Date

Displays the current date.

System Time

Displays the current time.

IP Address

Displays the IP Address of the SNMP agent.

Subnet Mask

Displays the Subnet Mask of the SNMP agent.

COM 1 Application

Displays the port's application as either Console, SLIP, UPS, or Modem.

COM 2 Application

Displays the port's application as either Console, SLIP, UPS, Modem, or N/A.

Clear All NVRAM

Clears all battery backed up memory.

Clear SNMP agent IP Address and Community Names Only

Clears battery backed up memory of IP Address and Community Names.

Enable Beacon Recovery

Enables Beacon Recovery.

MAC Address

Displays the physical hardware address.

Setting the System Date

To set the System date:

1. Use the arrow keys to highlight the **System Date** field.
2. Enter the date into the field in a MM/DD/YY format.
3. Press **Return**. If the format not valid, the message "INVALID DATE" appears. Re-enter the date using the correct format.
4. If the format is correct, use the arrow keys to highlight the **SAVE** command at the bottom of the screen.
5. Press **Return**. The "SAVED" message appears on the screen indicating that your changes have been saved to memory.

LOCAL MANAGEMENT

Setting the System Time

To set the system time:

1. Use the arrow keys to highlight the **System Time** field.
2. Enter the time into the field in a HH:MM:SS format.
3. Press **Return**. If the format is not valid, the message “INVALID TIME” appears. Re-enter the time using the correct format.
4. If the format is correct, use the arrow keys to highlight the SAVE command at the bottom of the screen.
5. Press **Return**. The “SAVED” message appears on the screen indicating that your changes have been saved to memory.

Setting the IP Address

To set the IP Address:

1. Use the arrow keys to highlight the **IP Address** field.
2. Enter the IP Address into the field. The format for this entry is XXX.XXX.XXX.XXX, with values of XXX ranging from 0-255.
3. Press **Return**. If the format is not valid, the message “INVALID IP FORMAT” appears. Re-enter the IP Address using the correct format.
4. If the IP Address is correct, use the arrow keys to highlight the SAVE command at the bottom of the screen.
5. Press **Return**. The “SAVED” message appears on the screen indicating that your changes have been saved to memory.

Setting the Subnet Mask

Note: Consult your Network Administrator prior to setting the Subnet Mask.

The Subnet Mask defines how your TRXI treats SNMP Trap IP destination addresses in its Community Names table.

- Set the Subnet Mask when workstations in the Community Names table reside on a different subnet (i.e., across a gateway or router), and you want these workstations to receive traps.
- Use the Subnet Mask factory default setting of 0.0.0.0 when all trap designated workstations are on the TRXI subnet.

To set the Subnet Mask:

1. Use the arrow keys to highlight the **Subnet Mask** field.
2. Press **Return** to clear the field.
3. Enter the Subnet Mask into the field. The format for this entry is XXX.XXX.XXX.XXX, with values of XXX ranging from 0-255.
4. Press **Return**. If the format is not valid, the “INVALID IP FORMAT” message appears. Re-enter the Subnet Mask using the correct format.
5. If the format is correct, use the arrow keys to highlight the SAVE command at the bottom of the screen.
6. Press **Return**. The “SAVED” message appears on the screen indicating that your changes have been saved to memory.

Setting the Clear SNMP Agent IP Address and Community Names Only Field

To set this field:

1. Use the arrow keys to highlight the Clear SNMP Agent IP Address and Community Names Only field.
2. Press **Return** to toggle from Yes to No.

LOCAL MANAGEMENT

3. Select **Yes** to Clear SNMP Agent IP Address and Community Names Only or **No** to escape the field.
4. Use the arrow keys to highlight the **SAVE** command.
5. Press **Return**. The “**SAVED**” message appears on the screen indicating that your changes have been saved to memory.

Setting the Clear All NVRAM Field

To set the Clear All NVRAM field:

1. Use the arrow keys to highlight the **Clear All NVRAM** field.
2. Press **Return** to toggle from **Yes** to **No**.
3. Select **Yes** to clear NVRAM or **No** to escape the field.
4. Use the arrow keys to highlight the **SAVE** command.
5. Press **Return**. The “**SAVED**” message appears on the screen indicating that your changes have been saved to memory.

Setting the Enable Beacon Recovery Field

To set the Enable Beacon Recovery field:

1. Use the arrow keys to highlight the **Enable Beacon Recovery** field.
2. Press **Return** to toggle from **Yes** to **No**.
3. Select **Yes** to enable Beacon Recovery or **No** to escape the field.
4. Use the arrow keys to highlight the **SAVE** command.
5. Press **Return**. The “**SAVED**” message appears on the screen indicating that your changes have been saved to memory.

5.3.2 The SNMP Community Names Screen

The SNMP Community Names screen lets you set community names. Community names serve two purposes; they act as passwords to Local Management and they are agents of security control to your TRXI. You control TRXI access by establishing up to three levels of security authorization (Read Only, Read-Write, and Super-User). Only a user with Super-User access can change the device IP address and the community names.

Caution: *Community Names are passwords to Local Management. Remember your Community Name.*

Local Management passwords accorded Read-Only and Read-Write access privileges are not allowed editing capabilities to some fields. In this case, the message "AUTHORIZATION PROHIBITS ACCESS" appears. Figure 5-6 shows the SNMP Community Names screen.

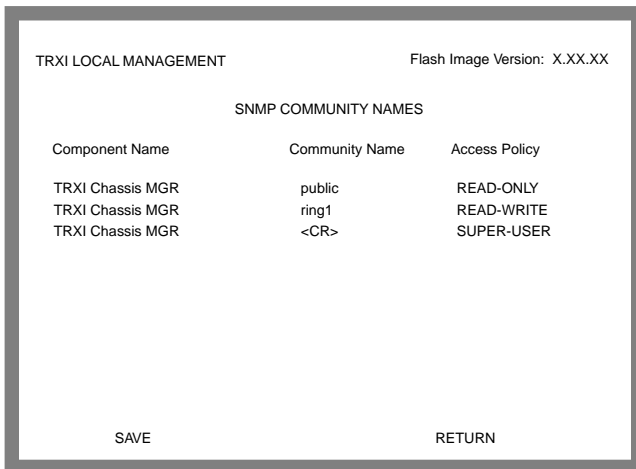

Figure 5-6. SNMP Community Names Screen

LOCAL MANAGEMENT

The following sections provide a brief explanation of each field on the SNMP Community Names screen and instructions for using them.

Component Name

Displays the component name as TRXI Chassis Manager.

Community Name

Displays the Community Name or “password” to Local Management.

Access

Displays the access level accorded to each community name. The following list defines each access code:

- | | |
|------------|---------------------------------------------------------------------------------------------------------------------------------------------------------------------|
| Read-Only | This allows read-only access to Local Management, but excludes access to security protected fields of the upper levels of authorization (Read-Write or Super-User). |
| Read-Write | This allows you to read and write to Local Management fields, excluding IP Address, Subnet Mask, and Community Names and Ring Security. |
| Super-User | This allows read-write access to all modifiable parameters including Community Names, IP Addresses, Traps, Ring Security, and SNMP objects. |

Editing the Community Name Field

To edit the Community Name field:

1. Use the arrow keys to highlight the **Community Name** field.
2. Enter the password, up to 26 characters in length, into the field. If you press **Return** without entering a password, the field defaults to Public.
3. Use the arrow keys to highlight the SAVE command at the bottom of the screen.
4. Press **Return**. The “SAVED” message appears indicating that your changes have been saved to memory.

5.3.3 The SNMP Traps Screen

The SNMP Traps screen lets you designate which management workstations receive trap messages. Figure 5-7 shows the SNMP Traps screen.

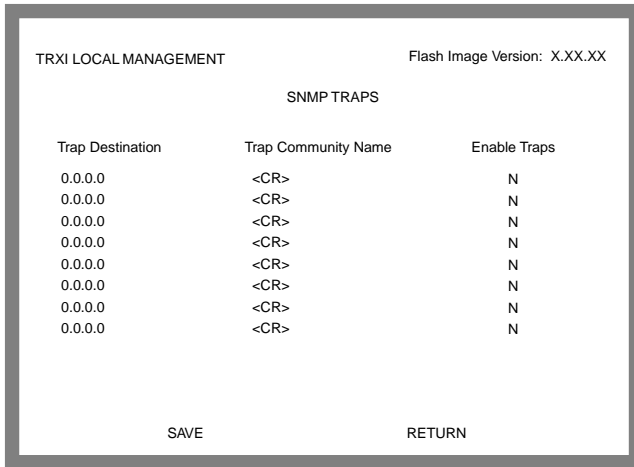

Figure 5-7. SNMP Traps Screen

The following sections provide a brief explanation of each field on the SNMP Traps screen and instructions for using them.

Trap Destination

Indicates the IP Address of the workstation that will receive trap alarms from the TRXI.

Trap Community Name

Displays the user-defined name of the SNMP Compliant Network Management Workstations to receive trap alarms from the TRXI.

Enable Traps

Enables the transmission of SNMP trap messages.

Setting SNMP Traps

To set SNMP traps:

1. Use the arrow keys to highlight the **Trap Destination** field.
2. Enter the IP address of the device that will receive trap alarms from the TRXI, then press **Return**. The format for this entry is XXX.XXX.XXX.XXX, with the value of XXX ranging from 0 to 255.
3. Use the arrow keys to highlight the **Trap Community Name** field.
4. Enter the community name of the device, then press **Return**. If you press **Return** without entering a community name, the field defaults to <CR>.
5. Use the arrow keys to highlight the **Enable Traps** field.
6. Enter **Y** (yes) to send alarms from the TRXI to the workstation, or **N** (no) to prevent alarms from being sent.
7. Use the arrow keys to highlight the **SAVE** command at the bottom of the screen.
8. Press **Return**. The "SAVED" message appears indicating that your changes have been saved to memory.

5.3.4 The Ring Security Screen

The Ring Security screen lets you control access to your token ring network. Figure 5-8 shows the Ring Security screen. When you enable ring security, the TRXI stores the MAC address of each station on the token ring network in a secure database or “allowed list.” Only stations on the allowed list can enter the ring. The TRXI can store up to 250 station MAC addresses on the allowed list. The TRXI retains the allowed list in its battery-backed Non-Volatile Random Access Memory (NVRAM). If you power up or reset the TRXI, NVRAM retains the allowed list and automatically re-enables ring security.

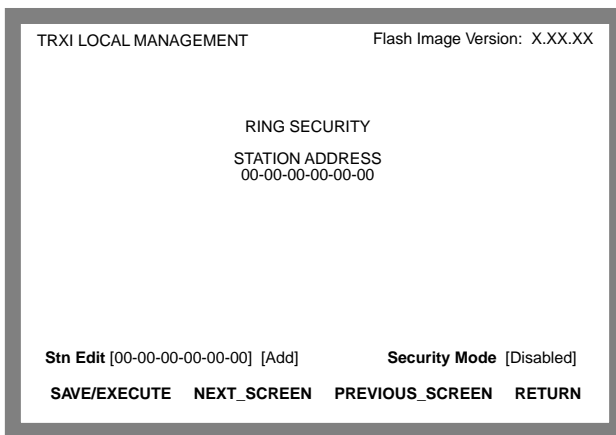

Figure 5-8. Ring Security Screen

You can append the allowed list by temporarily disabling ring security, then re-enabling it using the Alarms Only feature. The TRXI acts as the Ring Security Monitor for the ring and provides security for the entire ring.

Note: You should enable the Ring Security feature on only **one** TRXI per token ring.

You can select two modes of ring security; Alarm Only and Alarm/Remove. In the Alarm Only mode, new stations can enter the ring, but a “station added” trap/alarm notifies the Network Management Station (NMS) of the event.

LOCAL MANAGEMENT

The trap/alarm includes the new station's MAC address so that you can decide if the new station should be allowed to remain on the ring.

If you select the Alarm/Remove mode, ring security sends a "Remove MAC Frame Command" to new stations attempting to enter the ring, and a trap/alarm to the NMS informing it of the action taken. If the Remove MAC Frame Command fails to remove the new station after three attempts, ring security sends a trap/alarm to the NMS informing it that "the station could not be removed."

The following section provides a brief explanation of each field and command on the Ring Security screen and instructions for using them.

***Note:** Before you begin, you must set up the TRXI's SNMP Traps screen to designate which Network Management Stations receive trap/alarms (refer to the SNMP Traps screen section). This ensures that trap/alarms generated by ring security arrive at the appropriate destination.*

Station Address

This field lists the MAC address of each station on the ring security allowed list. This field can list up to 250 MAC addresses on 22 local management screens.

Stn Edit

The Station Edit command lets you add or delete stations from the allowed list. Use the Stn Edit command for single entry edits to the allowed list (refer to the Alarm Only security mode definition for information about adding multiple users).

Security Mode

This command lets you set the Security Mode for the ring. Security Modes determine the level of ring security. You can select the following Security Modes:

- **Disabled** - This is the factory default setting. Use this option to temporarily disable ring security so that new stations can enter the ring.
- **Alarm Only** - In this mode, ring security allows new stations to enter the ring. When a station enters the ring, ring security sends a "station added" trap/alarm to the Network Management Station.

The “station added” trap message includes the new station’s MAC address so that you can decide if the new station should be allowed on the ring.

To add multiple users to the ring, temporarily disable ring security using the Disable mode, then select the Alarm Only mode to re-enable ring security. Ring Security stores the MAC address of each station on the ring to the allowed list. This saves you from entering MAC addresses one at a time using the Stn Edit command. Refer to “Building the Allowed List” for instructions.

- **Alarm/Remove** - This is the highest level of ring security. When in the Alarm/Remove mode, ring security sends a “Remove MAC Frame Command” to new stations attempting to enter the ring, and a trap/alarm to the NMS informing it of the action taken. The “Remove MAC Frame Command” tries to automatically remove the station from the ring. If it cannot remove the station from the ring after three attempts, it sends a trap/alarm to the NMS informing it that “the station could not be removed.”

SAVE/EXECUTE

This command saves all security mode changes to the TRXI’s NVRAM. You must use the SAVE/EXECUTE command for your changes to take effect.

NEXT_SCREEN

Use this command to scroll to the next screen of the allowed database.

PREVIOUS_SCREEN

Use this command to scroll back to the previous screen of the allowed database list.

RETURN

Use this command to exit the Ring Security screen and return to the Device Setup screen.

LOCAL MANAGEMENT

Building the Allowed List

***Note:** You must set the Security Mode field to **Disabled** before you build the allowed list.*

To build the allowed list:

1. Use the arrow keys to highlight the Security Mode field.
2. Press **Return** to toggle selections (Disabled, Alarm Only, Remove/Alarm). Select the **Alarm Only** option.
3. Use the arrow keys to highlight the SAVE/EXECUTE command.
4. Press **Return**. The TRXI enables ring security and generates the allowed list. The "SECURITY MODE CHANGED" message appears at the top of the screen.
5. To view the allowed list, you must refresh the Ring Security screen by exiting, then re-entering the screen.

Adding Stations to the Station Address Allowed List

To add stations one at a time to the Station Address allowed list:

1. Use the arrow keys to highlight the Stn Edit field.
2. Press **Return** to clear the field.
3. Enter the MAC address of the station you want to add in XX-XX-XX-XX-XX-XX format. To delete characters use the **Backspace** key.
4. Use the arrow keys to highlight the Add/Del field.
5. Press **Return** to toggle selections. Select the **Add** option.
6. Use the arrow keys to highlight the SAVE/EXECUTE command.
7. Press **Return**. The station's MAC address appears on the screen.

Deleting Stations from the Station Address Allowed List

To delete stations from the Station Address allowed list:

1. Use the arrow keys to highlight the Stn Edit field.
2. Press **Return** to clear the field.
3. Enter the MAC address of the station you want to delete in XX-XX-XX-XX-XX-XX format. To delete characters, use the **Backspace** key.
4. Use the arrow keys to highlight the Add/Del field.
5. Press **Return** to toggle selections. Select the **Del** option.
6. Use the arrow keys to highlight the SAVE/EXECUTE command.
7. Press **Return**. The station's MAC address is deleted.

***Note:** You must set ring security to the Alarm/Remove mode to effectively delete a station from the allowed list and keep it off the ring. If you delete a station from the allowed list while in the Alarm Only mode, the station can re-enter the ring and its Mac address will reappear in the allowed list.*

Changing the Ring Security Mode

To change the Security Mode:

1. Use the arrow keys to highlight the Security Mode field.
2. Press **Return** to toggle selections (Disabled, Alarm Only, Remove/Alarm). Select the desired option.
3. Use the arrow keys to highlight the SAVE/EXECUTE command, then Press **Return**. The TRXI enables the selected mode of ring security.

5.3.5 The Device Statistics Screen

The Device Statistics screen lets you view ring information, isolating errors, and non-isolating errors. Figure 5-9 shows the Device Statistics screen.

```
TRXI LOCAL MANAGEMENT                               Flash Image Version: X.XX.XX
                DEVICE STATISTICS (TOTAL)

INTERFACE: 1

    Frames Received: 0
    KBytes Received: 0
    Errors Received: 0
    Beacon States: 0
    Ring Purges: 0
    Active Monitor Changes: 0

ISOLATING ERRORS
    Line Errors: 0
    Burst Errors: 0
    AC Errors: 0
    Abort Transmit Errors: 0
    Internal Errors: 0

RING INFORMATION
    Active Monitor Addr: 00-00-00-00-00-00
    Ring Status: Normal
    Ring Number: 0
    Stations on Ring: 1
    Ports Enabled: 24
    Ring Speed (Mb/s): 16

NON-ISOLATING ERRORS
    Lost Frame Errors: 0
    Frame Copied Errors: 0
    Rcvr Congestion Errors: 0
    Token Errors: 0
    Frequency Errors: 0

ACCUMULATE  DELTA  REFRESH99sec  RETURN
```

Figure 5-9. Device Statistics Screen

The following section provides a brief explanation of each field on the Device Statistics screen and instructions for using them.

Device Statistics

Displays the Device Statistics counter mode. The counter mode lets you determine how you want the Device Statistics screen to gather statistics. You can choose the following methods:

- **Accumulate:** Initiates a new statistic count.
- **Delta:** Total of statistics beginning from the last screen refresh.
- **Total:** Total of statistics beginning from the last power-up.

Interface

Displays the network interface. This field is always 1.

Frames Received

Displays the total frames detected on the ring since the TRXI was last powered on or reset.

KBytes Received

Displays the kilobyte sum of all frames detected on the TRXI since it was last powered up or reset.

Errors Received

Displays the total Isolating and Non-Isolating Errors detected by the TRXI.

Beacon States

Displays the total beacon states detected by the TRXI. Stations transmit beacons when they detect bit streaming or signal loss on the ring.

Ring Purges

Displays the total ring purge frames transmitted by the active monitor.

Active Monitor Changes

Displays the number of times a different station has been active monitor.

ISOLATING ERRORS

Isolating Errors are “soft” ring errors that report the domain of a fault (that is, you can isolate the fault’s region to the transmitting adapter, the receiving adapter, and the components - cabling and wiring concentrators - between the two).

Line Errors

Displays the total line errors detected by the TRXI. Line Errors are corrupted frames that are detected by a node. This type of error normally occurs when stations enter and leave the ring.

This error can also indicate a problem with the receiver of the reporting node, or the transmitter of its Nearest Active Upstream Neighbor (NAUN), or the cabling and hub hardware between them.

Burst Errors

Displays the total burst errors detected by the TRXI. Burst Errors are the absence of clocking signals at a node's receiver. This error normally occurs when stations enter or leave the ring with the absence of phantom current.

This error can also indicate a problem with the receiver of the reporting node, or the transmitter of its NAUN, or the cabling and hub hardware between them.

AC Errors

Displays the total Address Recognized/Frame Copied errors. This indicates that the reporting NAUN is faulty. The node cannot set the address recognized indicator and/or frame copied indicator bits in the frame which it has copied. This leaves the downstream node with an incorrect NAUN address.

Abort Transmit Errors

Displays the total abort delimiter frames transmitted by a station. This indicates that either the reporting node has detected an error on itself, or there is an error with its NAUN, or the cabling and wiring hubs between them.

Internal Errors

Displays the total internal errors detected by the adapter's hardware and/or firmware. These errors cause the adapter to remove itself from the ring and indicates a problem with the adapter hardware or firmware (possibly an inoperable chipset, timers, or counters).

RING INFORMATION

Ring Information provides ring status information.

Active Monitor Addr

Displays the MAC address of the active monitor. The active monitor initiates recovery procedures from various error situations.

Ring Status

This field lists the current status of the ring being monitored by the TRXI. TRXI displays the following ring status conditions:

- **Unknown**, Indicates the state of the ring cannot be detected by the management station.
- **Closed**, Indicates that the management station is not inserted into the ring and therefore cannot determine the ring state.
- **Normal**, Indicates the ring is running with no problems, and tokens are being detected by the management station.
- **Purge**, Indicates that the active monitor has issued a ring purge command. Communications will be restored when a new token is released.
- **Contention**, Indicates that the ring has entered into the active monitor contention process to determine a new active monitor for the ring.
- **Beaconing**, Indicates that the management station has detected a beacon frame.
- **Lobe Fail**, Indicates that a station failed the lobe self-test when it attempted to insert into the ring.

Ring Number

Displays the number of rings on the network.

Stations on a Ring

Displays the number of stations inserted into the ring.

Ports Enabled

Displays the number of network lobe ports enabled.

Ring Speed

Displays the ring speed of the TRXI as either 4 Mb/s or 16 Mb/s.

NON-ISOLATING ERRORS

Non-Isolating Errors are “soft error” conditions that could have been caused by any station on the ring. Their fault domain cannot be detected.

Lost Frame Errors

Displays the total number of Lost Frame Errors. These errors occur when the adapter fails to receive the end of the frame it has just transmitted. The frame was lost somewhere on the ring but there is no way to pinpoint where. This can be caused by stations entering or leaving the ring.

Frame Copied Errors

Displays the total number of Frame Copied Errors. These errors occur when a station finds a frame with its address as the destination, but finds the address recognized indicator bits not set to zero. This indicates a possible duplicate address.

Rcvr Congestion Errors

Displays the total number of Rcvr Congestion Errors. This indicates a station is receiving/repeating a frame and recognizes a frame addressed to it, but has no buffer space available for the frame.

Token Errors

Displays the total number of Token Errors. Token Errors occur when an active monitor does not see a token circulating on the ring before its TVX (Timer, Valid Transmission) time expires (e.g. a lost frame error has occurred), or sees a recirculating frame or token. The active monitor is responsible for purging the ring and issuing a new token.

Frequency Errors

Displays the total number of frequency errors. This indicates that the frequency of the incoming signal deviates excessively from the adapter's onboard crystal oscillator. It could indicate an error in this node's oscillator, the active monitor, or any node in between. When the node detects a frequency error, it enters the monitor contention process.

Total

Displays a running total of statistics beginning from the TRXI's last power-on.

Accumulate

Initiates a new statistic count. The TRXI begins totaling statistics after you select accumulate.

Delta

Displays the total statistics beginning at the last screen Refresh.

Refresh99sec

Displays the time interval between screen counter updates. You can choose refresh intervals in increments of 3 seconds, with the maximum interval being 99 seconds.

Selecting the Device Statistics Counter Mode

To select the Device Statistics counter mode:

1. Use the arrow keys to highlight Accumulate, Total, or Delta at the bottom of the screen. The current setting appears in the Device Statistics field at the top of the screen. Only the unused counter modes appear at the bottom of the screen.
2. Press the **Return** key. The selected counter mode appears at the top of the screen.

Setting the Refresh Field

To set the Refresh field:

1. Use the arrow keys to highlight the REFRESH99sec field at the bottom of the screen.
2. Press the **Shift** and + keys to increment the time interval or the - key to decrease the time interval.
3. Press the **Return** key to save your changes.

LOCAL MANAGEMENT

5.3.6 The Chassis Status View Screen

The Chassis Status View screen displays the status of ports 1-24, the Ring In port, and the Ring Out port. You can also use this screen to enable the TRXI ports. Figure 5-10 shows the Chassis Status View Screen.

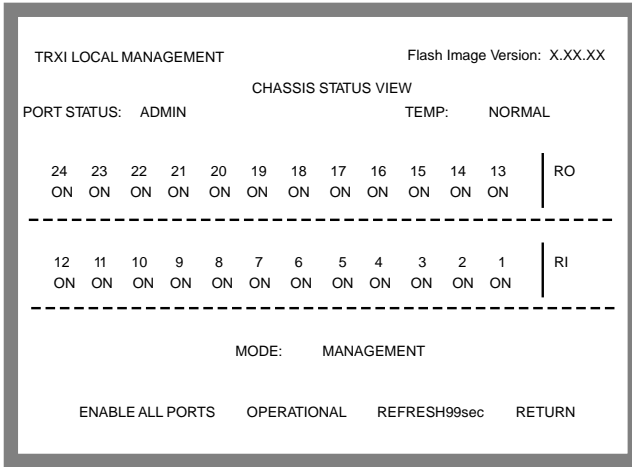

Figure 5-10. Chassis Status View Screen

The following sections provide a brief explanation of each field and instructions for using them.

Port Status

Displays the port status as Administrative or Operational.

Temp

Displays the hub temperature as Normal, Warm, or Hot.

Mode

Displays the current status view as Operational or Administrative.

Enable All Ports

Enables all TRXI ports.

Operational

Selects the status view mode as Operational or Administrative.

Refresh99sec

Displays the time interval between screen counter updates. You can choose refresh intervals in increments of 3 seconds, with the maximum interval being 99 seconds.

Return

Returns the screen to the Device Status screen.

Setting the Enable All Ports Option

To set the Enable All Ports option:

1. Use the arrow keys to highlight Enable All Ports.
2. Press **Return** to Enable all the TRXI ports.

Setting the Operational/Administrative Mode Option

To set the Operational/Administrative Mode option:

1. Use the arrow keys to highlight Operational or Administrative.
2. Press **Return** to select Operational or Administrative. The selected mode appears in the Mode field.

Setting the Refresh Field

To set the Refresh field:

1. Use the arrow keys to highlight the REFRESH99sec field at the bottom of the screen.
2. Press the **Shift** and + keys to increment the time interval or the - key to decrease the time interval.
3. Press the **Return** key to save your changes.

LOCAL MANAGEMENT

5.3.7 The Component Status View Screen

The Component Status View screen is a view only screen that displays the functions operating in the TRXI.

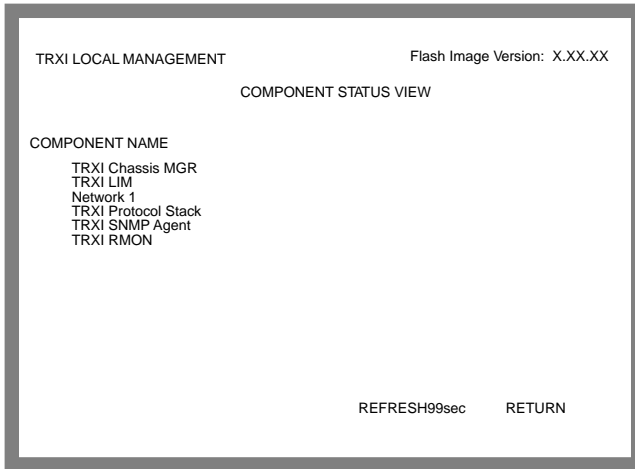

Figure 5-11. Component Status View Screen

Setting the Refresh Field

To set the Refresh field:

1. Use the arrow keys to highlight the REFRESH99sec field at the bottom of the screen.
2. Press the **Shift** and + keys to increment the time interval or the - key to decrease the time interval.
3. Press the **Return** key to save your changes.

5.3.8 The SNMP Tools Screen

This section describes specific commands and features within the SNMP Tools screen. This screen allows you to access management information bases (MIBs), and varies according to your level of security access.

The following descriptions outline the super-user management capabilities. From SNMP Tools you can:

- review specifics about object identifiers (OIDs)
- edit configurable OIDs
- view OIDs sequentially from the originally requested OID.

To access the SNMP Tools Screen from the Features Selection Screen, use the arrow keys to highlight the **SNMP Tool Support** option, then press the **Return** key. The SNMP Tools Screen, Figure 5-12, appears.

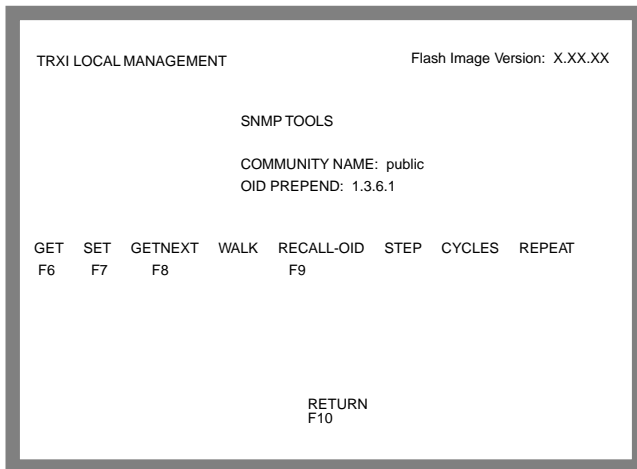

Figure 5-12. SNMP Tools Screen

The following describes the SNMP Tools Screen fields and commands.

LOCAL MANAGEMENT

SNMP Community Name

Identifies the community name MIB access level password.

OID Prepend

Specifies the number prefix common to all object identifiers (OIDs) found in a MIB. The prefix '1.3.6.1' is the default. You can modify this field to suit your needs.

GET

Allows you to retrieve MIB objects, one at a time, using SNMP protocol.

SET

Lets you edit modifiable MIB objects, using SNMP protocol.

GETNEXT

Displays the next OID in the MIB tree by getting the next SNMP OID from a remote agent.

WALK

Scrolls you through the MIB, leaf by leaf, from a user-specified object identifier. Leaves are objects, or instances of objects. After initializing a walk you see the following categories for each entry:

- Specified OID — identifies the number tag for that OID.
- Size — gives the number of bytes required to store the object.
- Data Type — gives the object's variable type (e.g., int=integer).
- Data Value — displays what the object identifier represents.

RECALL-OID

Recalls from memory the last OID used since powering up the board or re-entering the SNMP Tools screen.

STEP

Displays the MIB, step by step, with specific OID details.

CYCLES

Allows you to specify the number of **GET NEXT** requests to walk through and how much time elapses between each request.

REPEAT

Repeats the Get command, allowing you to monitor any changes to a specific OID.

The Security Access Level

Each MIB component that the TRXI supports (e.g., RMON, DLM, etc.) has its own “password” for each possible level of access (ranging from Basic Read-Only to Super-User).

***Note:** A complete list of Super-User Community Names (also called Community Strings) resides in the Cabletron proprietary chassis MIB. The MIB group `chCompName` provides the names of the MIB components. The MIB group `chCompSUCommStr` provides individual MIB component Community Names/Strings.*

The component information corresponds numerically – by last digit. In other words, each instance (i.e., OID element) in the `chCompName` group indicates its match in the `chCompSUCommStr` group.

In order to access a specific MIB’s components, you must set the appropriate MIB password in the COMMUNITY NAME field.

***Note:** The default Super-User password (public) allows you to access all MIB components. To change the SNMP Tools screen COMMUNITY NAME field, you must have Super-User access to Local Management.*

To set the SNMP Tools screen COMMUNITY NAME:

1. Use the arrow keys to highlight the field to the right of **COMMUNITY NAME**.
2. Enter the Community Name necessary for Super-User access for any specific MIB (e.g., `channelA` for Repeater Rev. 4 MIB).
3. Press the **Return** key. The Community Name changes.

Getting and Setting OIDs

To get an OID:

1. Highlight **GET**, using the arrow keys.
2. Press the **Return** key. “<GET> OID (= | F9)” appears.

LOCAL MANAGEMENT

3. Enter an OID either by:

- using the keyboard to enter the OID.

Shortcut: Save yourself some keystrokes by typing the OID minus the OID's prepend (i.e., given an OID prepend of 1.3.6.1, you enter 2.1.1.4.0, and the Local Management gets the MIB II sysContact OID 1.3.6.1.2.1.1.4.0).

- pressing **F9** to recall an OID already entered, and using the keyboard to modify the recalled OID as necessary.
 - entering an '=' and the OID suffix (e.g., if you enter =2.1.1.4.0, the OID = 1.3.6.1.2.1.1.4.0). This allows you to digress and not use the prepend.
4. Press the **Return** key. If there is no instance of that OID, the TRXI displays "MIB_NO_INSTANCE." Otherwise, the TRXI displays that OID's data type, length, and value.

To get the next OID:

1. Highlight **GETNEXT**, using the arrow keys.
2. Press the **Return** key. "<GETNEXT> OID (= | F9)" appears.
3. Enter the **OID**.
4. Press the **Return** key. If that OID does not exist, the TRXI displays "MIB_NO_INSTANCE". Otherwise the TRXI displays that OID's data type, length, and value.

Shortcut: If you have previously entered an OID, press **F9** to recall that entry. You can use the arrow keys to modify the recalled OID, or if you have not previously entered the OID, type the OID minus the OID's prepend.

To set an OID [information in brackets provides an example]:

1. Highlight **SET**, using the arrow keys.
2. Press the **Return** key. "<SET> OID (= | F9)" appears.

3. Enter an **OID**. [1.3.6.1.2.1.1.4.0]
4. Press the **Return** key. If that OID does not exist, the TRXI displays “MIB_NO_INSTANCE”. Otherwise the TRXI displays:

{INteger String Null Oid IP address Counter Gauge Timeticks
OPaque}

“DATA TYPE (name):”.

Shortcut: If you have previously entered an OID, press **F9** to recall that entry. You can use the arrow keys to modify the recalled OID, or if you have not previously entered the OID, save yourself some keystrokes by typing the OID minus the OID’s prepend.

5. Enter the OID’s **Data Type**. [The sysContact **Data Type** is String.]

Note: When setting a String, SNMP tools requests the kind of data you plan to enter — HEX or ASCII. [In this example choose ASCII.]

6. Press the **Return** key. The TRXI displays “SNMP OID DATA.”
7. Enter the **Data**, or value of the OID. [Type in a sysContact. This OID allows for a String of up to 12 characters.]
8. Press the **Return** key. If the TRXI accepts the entry, it displays “<SET> OPERATION CODE: XXXX <OK>”; otherwise, an error message appears.

Scrolling Through Mib OIDs

Viewing several object identifiers at one time allows you to quickly scan a MIB for the information that you need. The SNMP Tools screen provides several scroll options:

- Walk — scrolls through OIDs sequentially, from the initial OID.
- Cycle — allows you to specify how many GetNext commands to cycle through for one OID.
- Step — pages through the MIB, one OID at a time.

LOCAL MANAGEMENT

To walk through the MIB:

1. Highlight **WALK**, using the arrow keys.
2. Press the **Return** key. "<INITIAL> OID (= | F9)" appears.
3. Enter the OID.
4. Press the **Return** key. Local Management begins walking through the sublayers of the MIB available from the specified OID. Each OID in the list displays the specified OID, its size, its data type, and the data value.
5. Press any key to stop the walk, or wait for "***MIB WALK COMPLETED***" to appear on the screen.

To cycle through:

1. Highlight **CYCLES**, using the arrow keys.
2. Press the **Return** key. "ENTER CYCLE COUNT:" appears.
3. Enter the number of OID cycles that you want to scroll through.
4. Press the **Return** key. "ENTER CYCLE DELAY:" appears.
5. Enter the delay that you want (in seconds) between get next requests.
6. Press the **Return** key. "<INITIAL> OID (= | F9)" appears.
7. Enter the OID.
8. Press the **Return** key.

To step through:

1. Highlight **GETNEXT**, using the arrow keys.
2. Press the **Return** key. "<GETNEXT> OID (= | F9)" appears.
3. Enter the OID (only the suffix is necessary).

4. Press the **Return** key. The initial OID details, including its size, data type, and data value, appear.
5. Highlight **STEP**, using the arrow keys.
6. Press the **Return** key to page through the MIB to the next OID.

Free Manuals Download Website

<http://myh66.com>

<http://usermanuals.us>

<http://www.somanuals.com>

<http://www.4manuals.cc>

<http://www.manual-lib.com>

<http://www.404manual.com>

<http://www.luxmanual.com>

<http://aubethermostatmanual.com>

Golf course search by state

<http://golfingnear.com>

Email search by domain

<http://emailbydomain.com>

Auto manuals search

<http://auto.somanuals.com>

TV manuals search

<http://tv.somanuals.com>