

Topaz
CD5/CD10

 *Cambridge Audio*
Your music + our passion

Contents

Introduction	2
Important safety instructions	3
Limited warranty.....	4
Rear panel connections.....	5
Front panel controls.....	5
Remote control	6
Operating instructions	7
Technical specifications.....	8
Troubleshooting.....	9

Introduction

Thank you for purchasing this Cambridge Audio Topaz CD5/10 CD player. We are confident that you will enjoy many years of listening pleasure from it. Like all Cambridge Audio products, the CD5/10 adheres to three core principles – stunning performance, ease of use and incredible value.

Developed as part of our on-going research and development regime, including extensive listening tests, we have developed many subtle tweaks and improvements to our circuits, components and layouts in the pursuit of our passion for sound quality.

For the critical Digital to Analogue converter stage, the CD5 features a WM8725 DAC from Wolfson Microelectronics. The CD10 features an even higher specification WM8761 DAC and also supports S/PDIF digital output. We have also employed double-sided surface-mount to remove wire links and shorten all signal paths.

Both models support normal PCM playback from redbook CDs (CDDA) plus playback of both MP3 and WMA files.

The CD5/10 also incorporate our new casework design with a thicker braced front panel, more rigid wrap-over lid assembly and dual-layer damped feet, all of which contribute to better control of resonance.

Your CD player can only be as good as the system it is connected to. Please do not compromise on your amplifier, speakers or cabling.

Naturally, we particularly recommend amplification from the Cambridge Audio Azur range, which has been designed to the same exacting standards as our CD players. Your dealer can also supply excellent quality Cambridge Audio interconnects to ensure your system realises its full potential.

Thank you for taking the time to read this manual; we recommend you keep it for future reference.



Matthew Bramble
Cambridge Audio Technical Director
and the Topaz design team

Make sure you register your purchase.

Visit: www.cambridge-audio.com/sts

By registering, you'll be the first to know about:

- Future product releases
- Software upgrades
- News, events and exclusive offers plus competitions!

This guide is designed to make installing and using this product as easy as possible. Information in this document has been carefully checked for accuracy at the time of printing; however, Cambridge Audio's policy is one of continuous improvement, therefore design and specifications are subject to change without prior notice.

This document contains proprietary information protected by copyright. All rights are reserved. No part of this manual may be reproduced by any mechanical, electronic or other means, in any form, without prior written permission of the manufacturer. All trademarks and registered trademarks are the property of their respective owners.

© Copyright Cambridge Audio Ltd 2009

Important safety instructions

For your own safety please read the following important safety instructions carefully before attempting to connect this unit to the mains power supply. They will also enable you to get the best performance from and prolong the life of the unit:

1. Read these instructions.
2. Keep these instructions.
3. Heed all warnings.
4. Follow all instructions.
5. Do not use this apparatus near water.
6. Clean only with a dry cloth.
7. Do not block any ventilation openings. Install in accordance with the manufacturer's instructions.
8. Do not install near any heat sources such as radiators, heat registers, stoves, or other apparatus (including amplifiers) that produce heat.
9. Do not defeat the safety purpose of the polarized or grounding-type plug. A polarized plug has two blades with one wider than the other. A grounding-type plug has two blades and a third grounding prong. The wide blade or the third prong are provided for your safety. If the provided plug does not fit into your outlet, consult an electrician for replacement of the obsolete outlet.
10. Protect the power cord from being walked on or pinched, particularly at plugs, convenience receptacles and the point where they exit from the apparatus.
11. Only use attachments/accessories specified by the manufacturer.
12. Use with only the cart, stand, tripod, bracket, or table specified by the manufacturer, or sold with the apparatus. When a cart is used, use caution when moving the cart/apparatus combination to avoid injury from tip-over. 
13. Unplug this apparatus during lightning storms or when unused for long periods of time.
14. Refer all servicing to qualified service personnel. Servicing is required when the apparatus has been damaged in any way, such as the power-supply cord or plug having been damaged, liquid has been spilled or objects have fallen into the apparatus, the apparatus has been exposed to rain or moisture, does not operate normally, or has been dropped.

WARNING

- To reduce the risk of fire or electric shock, do not expose this unit to rain or moisture.
- Batteries (battery pack or batteries installed) shall not be exposed to excessive heat such as sunshine, fire or the like.

The unit must be installed in a manner that makes disconnection of the mains plug from the mains socket outlet (or appliance connector from the rear of the unit) possible. Where the mains plug is used as the disconnect device, the disconnect device shall remain readily operable. Only use the mains cord supplied with this unit.

Please ensure there is ample ventilation (at least 10cm clearance all round). Do not put any objects on top of this unit. Do not situate it on a rug or other soft surface and do not obstruct any air inlets or outlet grilles. Do not cover the ventilation grilles with items such as newspapers, tablecloths, curtains, etc.

This unit must not be used near water or exposed to dripping or splashing water or other liquids. No objects filled with liquid, such as vases, shall be placed on the unit.



The lightning flash with the arrowhead symbol within an equilateral triangle is intended to alert the user to the presence of un-insulated 'dangerous voltage' within the product's enclosure that may be of sufficient magnitude to constitute a risk of electric shock to persons.

The exclamation point within an equilateral triangle is intended to alert the user to the presence of important operating and maintenance instructions in the service literature relevant to this appliance.



The symbol on this product indicates that it is of CLASS II (double insulated) construction.



WEEE symbol

The crossed-out wheeled bin is the European Union symbol for indicating separate collection for electrical and electronic equipment. This product contains electrical and electronic equipment which should be reused, recycled or recovered and should not be disposed of with unsorted regular waste. Please return the unit or contact the authorised dealer from whom you purchased this product for more information.



CE mark

This product complies with European Low Voltage (2006/95/EC), Electromagnetic Compatibility (2004/108/EC) and Environmentally-friendly design of Energy-using Products (2005/32/EC) Directives when used and installed according to this instruction manual. For continued compliance only Cambridge Audio accessories should be used with this product and servicing must be referred to qualified service personnel.



C-Tick mark

This product meets the Australian Communications Authority's Radio communications and EMC requirements.



Ross Test Stamp

This product meets Russian electronic safety approvals.

FCC regulations

NOTE: THE MANUFACTURER IS NOT RESPONSIBLE FOR ANY RADIO OR TV INTERFERENCE CAUSED BY UNAUTHORIZED MODIFICATIONS TO THIS EQUIPMENT. SUCH MODIFICATIONS COULD VOID THE USER AUTHORITY TO OPERATE THE EQUIPMENT.



This equipment has been tested and found to comply with the limits for a Class B digital device, pursuant to Part 15 of the FCC Rules. These limits are designed to provide reasonable protection against harmful interference in a residential installation. This equipment generates, uses and can radiate radio frequency energy and, if not installed and used in accordance with the instructions, may cause harmful interference to radio communications. However, there is no guarantee that interference will not occur in a particular installation.

If this equipment does cause harmful interference to radio or television reception, which can be determined by turning the equipment off and on, the user is encouraged to try to correct the interference by one or more of the following measures:

- Re-orient or relocate the receiving antenna.
- Increase the separation between the equipment and receiver.
- Connect the equipment into an outlet on a circuit different from that to which the receiver is connected.
- Consult the dealer or an experienced radio/TV technician for help.

Ventilation

IMPORTANT - The unit will become hot when in use. Do not stack multiple units on top of each other. Do not place in an enclosed area such as a bookcase or in a cabinet without sufficient ventilation.

Ensure that small objects do not fall through any ventilation grille. If this happens, switch off immediately, disconnect from the mains supply and contact your dealer for advice.

Positioning

Choose the installation location carefully. Avoid placing it in direct sunlight or close to a source of heat. No naked flame sources, such as lighted candles, should be placed on the unit. Also avoid locations subject to vibration and excessive dust, cold or moisture. The unit can be used in a moderate climate.

This unit must be installed on a sturdy, level surface. Do not place in a sealed area such as a bookcase or in a cabinet. Do not place the unit on an unstable surface or shelf. The unit may fall, causing serious injury to a child or adult as well as serious damage to the product. Do not place other equipment on top of the unit.

Due to stray magnetic fields turntables or CRT TVs should not be located nearby due to possible interference.

Electronic audio components have a running in period of around a week (if used several hours per day). This will allow the new components to settle down, the sonic properties will improve over this time.

Power sources

The unit should be operated only from the type of power source indicated on the marking label. If you are not sure of the type of power-supply to your home, consult your product dealer or local power company.

To turn the unit off, switch off at the front panel. If you do not intend to use this unit for a long period of time, unplug it from the mains socket.

Overloading

Do not overload wall outlets or extension cord as this can result in a risk of fire or electric shock. Overloaded AC outlets, extension cords, frayed power cords, damaged or cracked wire insulation, and broken plugs are dangerous. They may result in a shock or fire hazard.

Be sure to insert each power cord securely. To prevent hum and noise, do not bundle the interconnect leads with the power cord or speaker leads.

Cleaning

To clean the unit, wipe its case with a dry, lint-free cloth. Do not use any cleaning fluids containing alcohol, ammonia or abrasives. Do not spray an aerosol at or near the unit.

Battery disposal

Please dispose of any discharged batteries according to local environmental/electronic waste disposal guidelines.

Loudspeakers

Before making any connections to loudspeakers, make sure all power is turned off and only use suitable interconnects.

Servicing

These units are not user serviceable, never attempt to repair, disassemble or reconstruct the unit if there seems to be a problem. A serious electric shock could result if this precautionary measure is ignored. In the event of a problem or failure, please contact your dealer.

Limited warranty

Cambridge Audio warrants this product to be free from defects in materials and workmanship (subject to the terms set forth below). Cambridge Audio will repair or replace (at Cambridge Audio's option) this product or any defective parts in this product. Warranty periods may vary from country to country. If in doubt consult your dealer and ensure that you retain proof of purchase.

To obtain warranty service, please contact the Cambridge Audio authorised dealer from which you purchased this product. If your dealer is not equipped to perform the repair of your Cambridge Audio product, it can be returned by your dealer to Cambridge Audio or an authorised Cambridge Audio service agent. You will need to ship this product in either its original packaging or packaging affording an equal degree of protection.

Proof of purchase in the form of a bill of sale or receipted invoice, which is evidence that this product is within the warranty period, must be presented to obtain warranty service.

This Warranty is invalid if (a) the factory-applied serial number has been altered or removed from this product or (b) this product was not purchased from a Cambridge Audio authorised dealer. You may call Cambridge Audio or your local country Cambridge Audio distributor to confirm that you have an unaltered serial number and/or you purchased from a Cambridge Audio authorised dealer.

This Warranty does not cover cosmetic damage or damage due to acts of God, accident, misuse, abuse, negligence, commercial use, or modification of, or to any part of, the product. This Warranty does not cover damage due to improper operation, maintenance or installation, or attempted repair by anyone other than Cambridge Audio or a Cambridge Audio dealer, or authorised service agent which is authorised to do Cambridge Audio warranty work. Any unauthorised repairs will void this Warranty. This Warranty does not cover products sold AS IS or WITH ALL FAULTS.

REPAIRS OR REPLACEMENTS AS PROVIDED UNDER THIS WARRANTY ARE THE EXCLUSIVE REMEDY OF THE CONSUMER. CAMBRIDGE AUDIO SHALL NOT BE LIABLE FOR ANY INCIDENTAL OR CONSEQUENTIAL DAMAGES FOR BREACH OF ANY EXPRESS OR IMPLIED WARRANTY IN THIS PRODUCT. EXCEPT TO THE EXTENT PROHIBITED BY LAW, THIS WARRANTY IS EXCLUSIVE AND IN LIEU OF ALL OTHER EXPRESS AND IMPLIED WARRANTIES WHATSOEVER INCLUDING, BUT NOT LIMITED TO, THE WARRANTY OF MERCHANTABILITY AND FITNESS FOR A PRACTICAL PURPOSE.

Some countries and US states do not allow the exclusion or limitation of incidental or consequential damages or implied warranties so the above exclusions may not apply to you. This Warranty gives you specific legal rights, and you may have other statutory rights, which vary from state to state or country to country.

For any service, in or out of warranty, please contact your dealer.

Plug Fitting Instructions (UK Only)

The cord supplied with this appliance is factory fitted with a UK mains plug fitted with a 5 amp fuse inside. If it is necessary to change the fuse, it is important that a 5 amp one is used. If the plug needs to be changed because it is not suitable for your socket, or becomes damaged, it should be cut off and an appropriate plug fitted following the wiring instructions below. The plug must then be disposed of safely, as insertion into a mains socket is likely to cause an electrical hazard. Should it be necessary to fit a 3-pin BS mains plug to the power cord the wires should be fitted as shown in this diagram. The colours of the wires in the mains lead of this appliance may not correspond with the coloured markings identifying the terminals in your plug. Connect them as follows:

The wire which is coloured BLUE must be connected to the terminal which is marked with the letter 'N' or coloured BLACK.

The wire which is coloured BROWN must be connected to the terminal which is marked with the letter 'L' or coloured RED.

The wire which is coloured GREEN/YELLOW must be connected to the terminal which is marked with the letter 'E' or coloured GREEN.

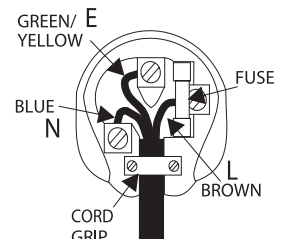

If a 13 amp (BS 1363) plug is used, a 5 amp fuse must be fitted, or if any other type of plug is used a 5 amp fuse must be fitted, either in the plug or adaptor, or on the distribution board.

Rear panel connections

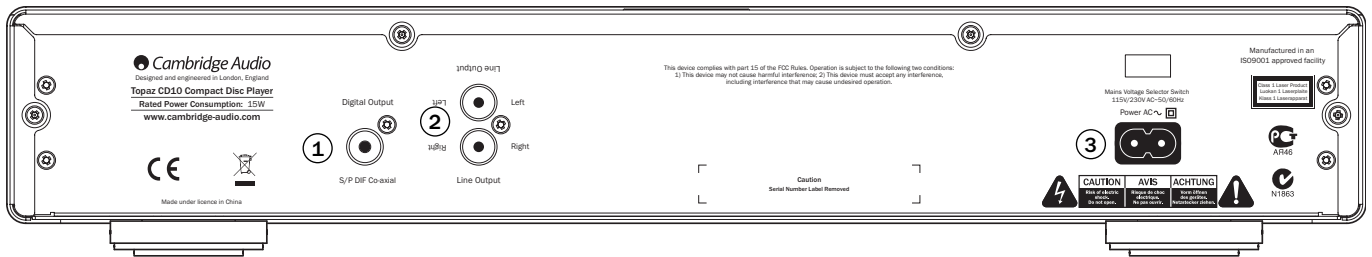

① S/P DIF co-axial digital output (CD10 only)

For input to a separate DAC, such as Cambridge Audio DacMagic*, or digital recording machine. To obtain best results, use a high quality 75ohm digital RCA interconnect cable (not one designed for normal audio use).

* For more information, see the DacMagic page on the Cambridge Audio website: www.cambridgeaudio.com/products.php

② Line Output

Use good quality interconnect cables from these sockets to any line level input on your amplifier. For best results and matched performance, we recommend connection to a Cambridge Audio amplifier.

③ AC power socket

Once you have completed all connections to the amplifier, plug the AC power cable into an appropriate mains socket and turn the unit on. Your compact disc player is now ready for use.

Front Panel controls

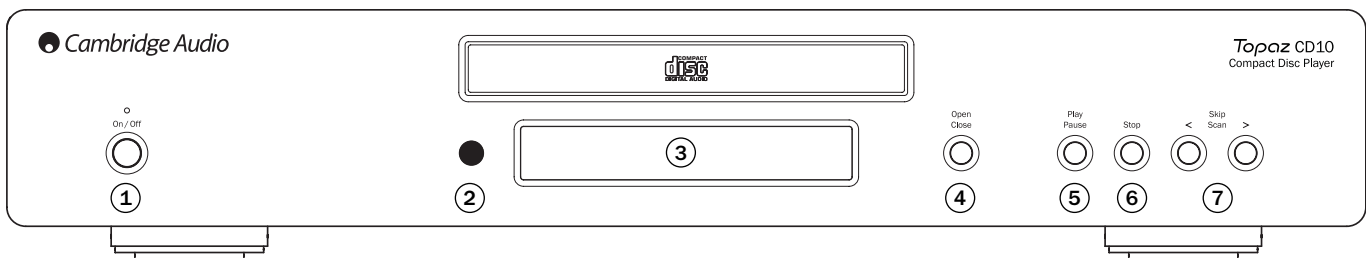

① On/Off

Switches the unit on and off.

② Infrared sensor

Receives IR commands from the supplied remote control. An unobstructed line of sight between the remote control and the sensor is required.

③ Display

Alpha-numeric characters which display playback information. On inserting a disc, the CD player will take a few seconds to read the Table of Contents (TOC) information from the disc. The display will then show the number of tracks on the CD and the total length of the CD.

④ Open/Close

Allows you to open and close the disc tray. After placing a CD in the tray, press Open/Close to close the tray.

⑤ Play/Pause

Plays the disc and pauses play.

⑥ Stop

Stops the CD playing.

⑦ Skip/Scan

Enables you to skip between and search within tracks. Press briefly to skip a track. Press and hold to scan through a track.

Remote control

The Topaz CD5 and CD10 are supplied with a remote control that operates the unit. In addition, the Blue coloured buttons can operate a matching Topaz AM10 amplifier or SR10 stereo receiver.

Always use a CR2025 Lithium coin cell.

Open/Close

Opens and closes the disc tray.

Numerical track select

Press the number of the desired track. The track will then play automatically from the start of the track.

Prog

Allows you to program a unique sequence of up to 20 tracks. Refer to 'Operating Instructions' section of this manual for more information.

Prog Clear

Clears a programmed sequence. See later section of this manual.

Pause/ Stop/ Play

Press the relevant button to pause, stop or play the CD.

Skip

Right Skip – Press to skip forward by one track on the CD.

Left Skip – Press to skip backward by one track on the CD.

Scan

Press and hold to scan within the selected track. Press the right button to fast forward, the left button to rewind.

Random, Repeat, Remain

Read the 'Operating Instructions' section of this manual for information on the functions of these buttons.

AM10/SR10 (Blue coloured icons)

To operate the Topaz AM10 or SR10 unit only.



Adjust the volume on a SR10/AM10.



Changes source on a SR10/AM10.



Mutes the output of a SR10/AM10.

Note: These controls work on the Topaz SR10/AM10 only and are not compatible with Cambridge Audio Azur amplifiers/receivers or units from other manufacturers.

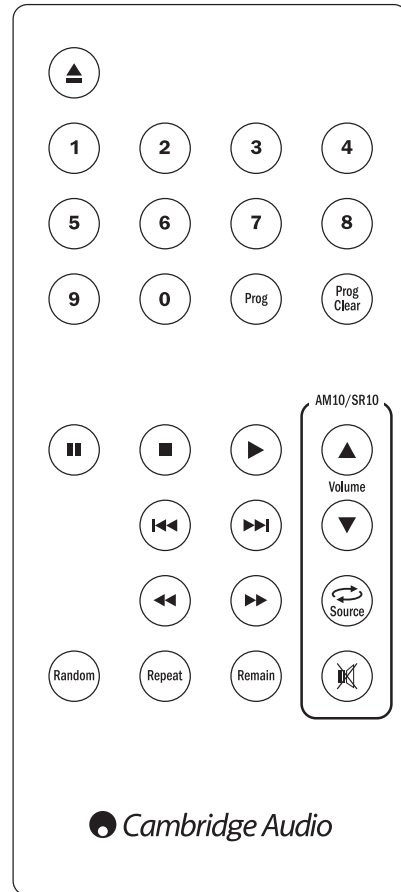

Operating instructions

Loading and unloading discs

1. Press the Open/Close button.
2. When the disc tray has opened fully, place a disc carefully in the tray with the label side facing up.
3. To close the disc tray, press the Open/Close button again. When the tray, with a correctly loaded disc, is fully closed the CD player will read the disc and display the content information.
4. The disc tray can be opened at any time by pressing the Open/Close button. Only remove the disc after the tray has fully opened.

Note:

- Do not put anything except a compact disc into the tray. Foreign objects may damage the mechanism.
- Do not force the tray by hand during the opening and closing operations.
- To avoid dirt and dust entering the mechanism, keep the disc tray closed.
- If the compact disc is badly scratched or too dirty, the player may not be able to read it or play it.
- Never load more than one disc into the disc tray at any time.

Normal disc play



This unit has been designed to play compact discs, recordable CDs (CD-R) and re-writable CDs (CD-RW) bearing the identification logo shown here. No other discs can be used. The CD-R/CD-RW discs should contain properly recorded TOC (Table of Contents) information so that they can be played back. This unit can play only the discs recorded in the CDDA format designed for music reproduction or those containing MP3 or WMA files. Do not attempt to play a disc on this unit containing other data, such as a data CD-ROM for PCs.

1. Switch on your amplifier and set its input selector to the correct position. Adjust the volume control to a minimum.
2. Press the Open/Close button to open the disc tray and load a disc.
3. Press the Open/Close button again to close the tray. The CD player will read the disc.
4. To begin playback, press the ▶ button.
5. When the last track has finished playing, the display will return to Table of Contents (TOC).
6. To stop the disc at any point, press the ■ button. Pressing the II button while the disc is playing will pause the disc. Playback can be resumed by pressing ▶ button.

Locating a specific track during playback

1. A single short press of the ►► button will take you to the beginning of the next track on the CD. Repeat as necessary.
2. A single short press of the ◀◀ button will take you to the beginning of the previous track.

Locating a specific track when playback is stopped

1. A single short press of the ◀◀ ►► buttons will skip between tracks.
2. Press ▶ to start playback from the selected track.

Repeating discs and tracks

1. Ensure that the disc is loaded.
2. To repeat a specific track, press the Repeat button on the remote. 'RPT ONE' will appear on the display. Press ▶ and the selected track will now repeat until the function is turned off. Alternatively, press the Repeat button, select the chosen track using the numerical buttons on the remote control and press ▶.

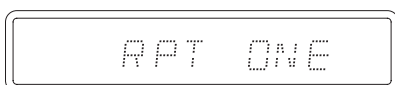

3. Press the Repeat button twice on the remote control. 'RPT ALL' will appear on the display. Press ▶. The whole disc will now be repeated until the function is turned off.

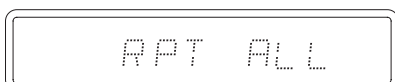

4. To turn the Repeat function off, press the Repeat button either before or during playback until 'RPT OFF' appear on the display.

Playing tracks in random order

1. Ensure that a disc is loaded.
2. Press the Random button on the remote control. 'RAN ON' will appear on the display.



3. Press ▶. The CD player will now play the entire disc in random order. It is also possible to press the Random button during playback to listen to tracks in random order.
4. Press the Random button to exit. The disc will continue playing to the end in the correct order.

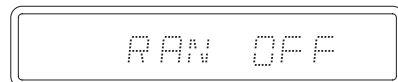

5. Press the ■ button at any time to stop the disc.

Note: Selecting 'Random' mode when 'RPT ONE' has been selected will automatically cancel 'RPT ONE' mode.

Using the Remain function

1. Ensure that the disc is playing.
2. Press the Remain button on the remote control once to display the time remaining for the track playing.
3. Pressing the Remain button the second time will show the total remaining disc time.
4. Press the Remain button again either before or during playback to return to normal play mode.

Programming disc play

It is possible to program the CD5/CD10 to play back in any order only the tracks you wish to listen to.

1. Ensure that a disc is loaded. The display should show the TOC data.
2. Press the Prog button on the remote control. The Program set-up will appear on the display.

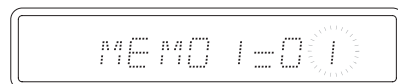

3. Use the ◀◀ ►► buttons or enter the track number that you want to program as your first track.
4. Press the Prog button on the remote. The desired track is now programmed. The program number automatically increases by one for the next entry.

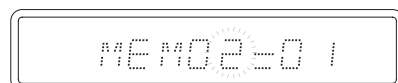

5. Repeat steps three and four until all your desired tracks are entered. A maximum of 20 tracks can be programmed.
6. Press the ▶ button to begin programmed playback.
7. Press the Prog Clear button on the remote to clear all programmed tracks.

Technical specifications

CD5

D/A Converter	Wolfson Microelectronics WM8725
Filter	2-pole Butterworth filter
Frequency response (+/-0.4dB)	20Hz - 20kHz
THD @ 1Khz 0dBfs	<0.006%
THD @ 1Khz -10dBfs	<0.015%
S/N ratio, A weighted	>93dB
Crosstalk @1kHz	<-95dB
Crosstalk @20kHz	<-95dB
Output impedance	<50ohms
Maximum power consumption	15W
Dimensions	75 x 430 x 305mm (3.0 x 16.9 x 12.2")
Weight	4.3kg (9.5lbs)

CD10

D/A Converter	Wolfson Microelectronics WM8761
Filter	2-pole Butterworth filter
Frequency response (+/-0.4dB)	20Hz - 20kHz
THD @ 1Khz 0BFs	<0.006%
THD @ 1Khz -10dBfs	<0.01%
S/N ratio, A weighted	>95dB
Crosstalk @1kHz	<-98dB
Crosstalk @20kHz	<-95dB
Output impedance	<50ohms
Maximum power consumption	15W
Dimensions	85 x 430 x 305mm (3.0 x 16.9 x 12.2")
Weight	4.3kg (9.5lbs)

Troubleshooting

There is no power

Ensure the AC power cord is connected securely.

Ensure the plug is fully inserted into the wall socket and is switched on.

Check the unit is switched on at the rear panel.

Check fuse in the mains plug or adaptor.

The player will not read the disc

Check the disc is not loaded upside down.

Check that the disc is not too scratched or dirty.

There is no sound

Ensure that the amplifier is set correctly.

Check that the interconnects are inserted correctly.

The disc is skipping

Check that the disc is not too scratched or dirty.

Ensure the player is on a firm surface and not subject to vibrations.

There is a hum coming from the speaker

Ensure that all cable connections are secure.

The remote handset will not function

Check that the batteries have not expired.

Ensure that nothing is blocking the remote sensor.

In the event that the above solutions do not remedy your problem, please consult our frequently asked questions (FAQ) section on our website: www.cambridge-audio.com/sts/faqs

You can also use this facility to post a question to our Technical Support team.

For all servicing, in or out of warranty, please contact your dealer.

Cambridge Audio is a brand of Audio Partnership Plc
Registered Office: Gallery Court, Hankey Place,
London, SE1 4BB, United Kingdom
Registered in England No. 2953313

www.cambridge-audio.com

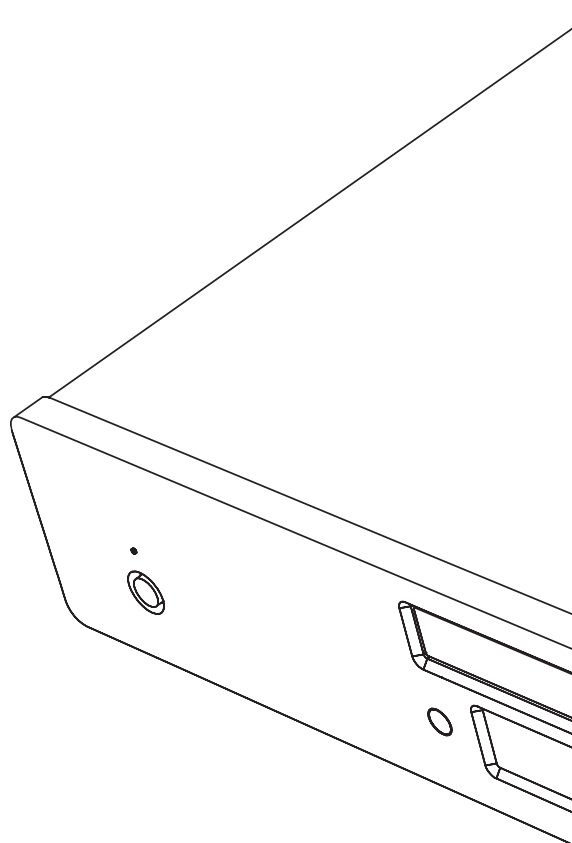

© 2009 Cambridge Audio Ltd

AP25831/1

Free Manuals Download Website

<http://myh66.com>

<http://usermanuals.us>

<http://www.somanuals.com>

<http://www.4manuals.cc>

<http://www.manual-lib.com>

<http://www.404manual.com>

<http://www.luxmanual.com>

<http://aubethermostatmanual.com>

Golf course search by state

<http://golfingnear.com>

Email search by domain

<http://emailbydomain.com>

Auto manuals search

<http://auto.somanuals.com>

TV manuals search

<http://tv.somanuals.com>