

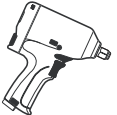



# HL410189 Compressor and Accessory Kit

## HL410189 Compresseur et Trousse d'Accessoires

### HL410189 Compresor y Juego de Accesorios

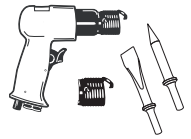
**TOOL & ACCESSORY KIT INCLUDES ● LA TROUSSE D'OUTILS ET D'ACCESSOIRES COMPREND ● EL KIT DE HERRAMIENTAS Y ACCESORIOS INCLUYE**

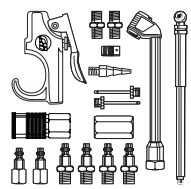
<b>Tools and Accessories Included</b>	<b>Outils et accessoires inclus</b>	<b>Herramientas y Accesorios Incluidos</b>	<b>For Replacement Order Pour commande des pièces de rechange Para pedidos de repuestos</b>
 Impact Wrench	Clés à Choc	Pistola de Impacto	TLX10200XX
 3/8 in. Air Ratchet	Rochet Pneumatique de 9,5 mm (3/8 po)	Trinquete Neumático de 9,5 mm (3/8 in.)	TLX10100AV
 1 5/8 in. Air Chisel (1) Tapered Punch Chisel Bit (1) Flat Chisel Bit (1) Spring Retainer	4,12 cm (1 5/8 in.) Ciseau Pneumatique (1) Foret de Poinçon (1) Foret de burin plat (1) Retenue de ressort	4,12 (1 5/8 in.) Cíncel Neumático (1) Punta de Troquel (1) Punta de cíncel plana (1) Retenedor de resorte	TLX10301XX
 50 ft. x 3/8 in. PVC Air Hose	Tuyau à air de PVC - 15,24 m (50 pi.) x 9,5 mm (3/8 po.)	Manguera de aire PVC de 15,24 m (50 ft.) x 9,5 mm (3/8 in.)	XX282600AV
 Tire Inflation Gun	Pistolet de gonflage de pneu	Pistola para inflar llantas	MP600100XX
 Inflation Accessories: blow gun, safety nozzle, female industrial coupler, (4) male plugs, (2) female plug, (2) male hex nipple, female hex connector, (2) inflation needles, tapered inflation nozzle, dual foot air chuck tire gauge	Accessoires de gonflage : soufflette, embout de sécurité, raccord femelle industrielle, (4) prises mâles, (2) prises femelle, (2) mâle mamelon hex, femelle hex raccord, (2) aiguilles de gonflage, embout effilé de gonflage, mandrin pneumatique double au pied mandrin pneumatique	Accesorios de inflado: pistola de aire, boquilla de seguridad, acople hembra industrial, (4) empalmes macho, (2) empalmes hembra, (2) macho niple hexagonal, hembra hexagonal conector, (2) agujas de inflado, boquilla de inflado cónica, boquilla dual de pie para neumáticos manómetro para neumáticos	XX284700AV

**COMPRESSOR KIT INCLUDES ● LA TROUSSE DU COMPRESSEUR COMPREND ● EL KIT DEL COMPRESOR INCLUYE**

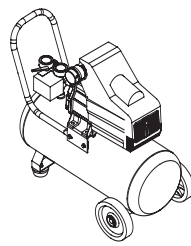
 1.3 Running HP / 8 Gallon Air Compressor	Compresseur d'air de 1,3 HP de marche / 3,8 litres (8 gallons)	Compresor de aire de 1,3 HP potencia de servicio / 3,8 litros (8 galones)	HL410100AV
Wheel Kit: (2) Wheels, (2) Axle bolts, (2) Hex Nuts, and (2) lock washers	Trousse de roues : (2) roues, (2) boulons d'essieu, (2) écrous hexagonaux et (2) rondelles de blocage	Juego de ruedas: (2) Ruedas, (2) Pernos de eje, (2) Tuercas hexagonales, y (2) arandelas de seguridad	HL021200AV
Handle	Manche	Mango	HL019700AV
Handle Screw Kit: (4) Bolts, (4) Washers, and (4) Hex Nuts	Trousse de vis de poignée : (4) boulons, (4) rondelles et (4) écrous hexagonaux	Juego de tornillos del mango: (4) Pernos, (4) Arandelas, y (4) Tuercas hexagonales	HL021100AV
Filter	Filtre	Filtro	HL018200AV



**APPLY THREAD TAPE TO THREADED CONNECTIONS TO HELP ELIMINATE AIR LEAKS**  
**APPLIQUER DU RUBAN FILETÉ AUX RACCORDS FILETÉS POUR AIDER À ÉLIMINER LES FUITES D'AIR/APLIQUE**  
**CINTA PARA ROSCAS A LAS CONEXIONES ROSCADAS PARA AYUDAR A ELIMINAR PÉRDIDAS DE AIRE**



**OIL: FOR USE WITH CHISEL, IMPACT WRENCH AND NAILER/STAPLER. REFER TO OWNERS MANUAL FOR PROPER USE.**  
**HUILE : À UTILISER AVEC UN BURIN, UNE CLÉ À CHOC ET LES CLoueUSE/AGRAFEUSE. SE REPORTER AU MANUEL DU PROPRIÉTAIRE POUR UNE BONNE UTILISATION DU PRODUIT.**  
**ACEITE: PARA USAR CON CINCELES, LLAVES DE IMPACTO Y CLAVADORAS/AGRAPADORAS. PARA EL USO APROPIADO REFIERESE AL MANUAL DEL USUARIO.**

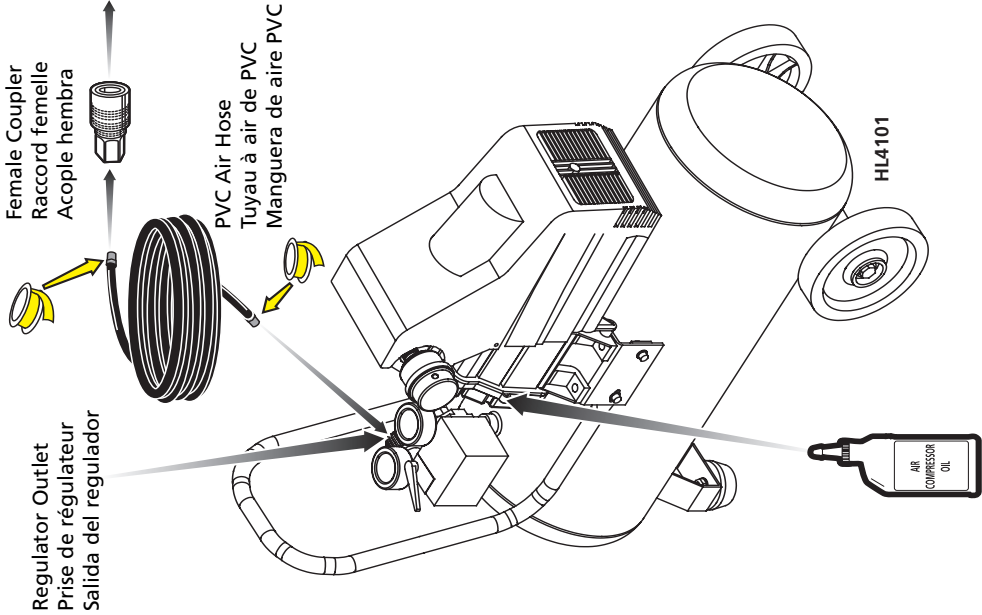
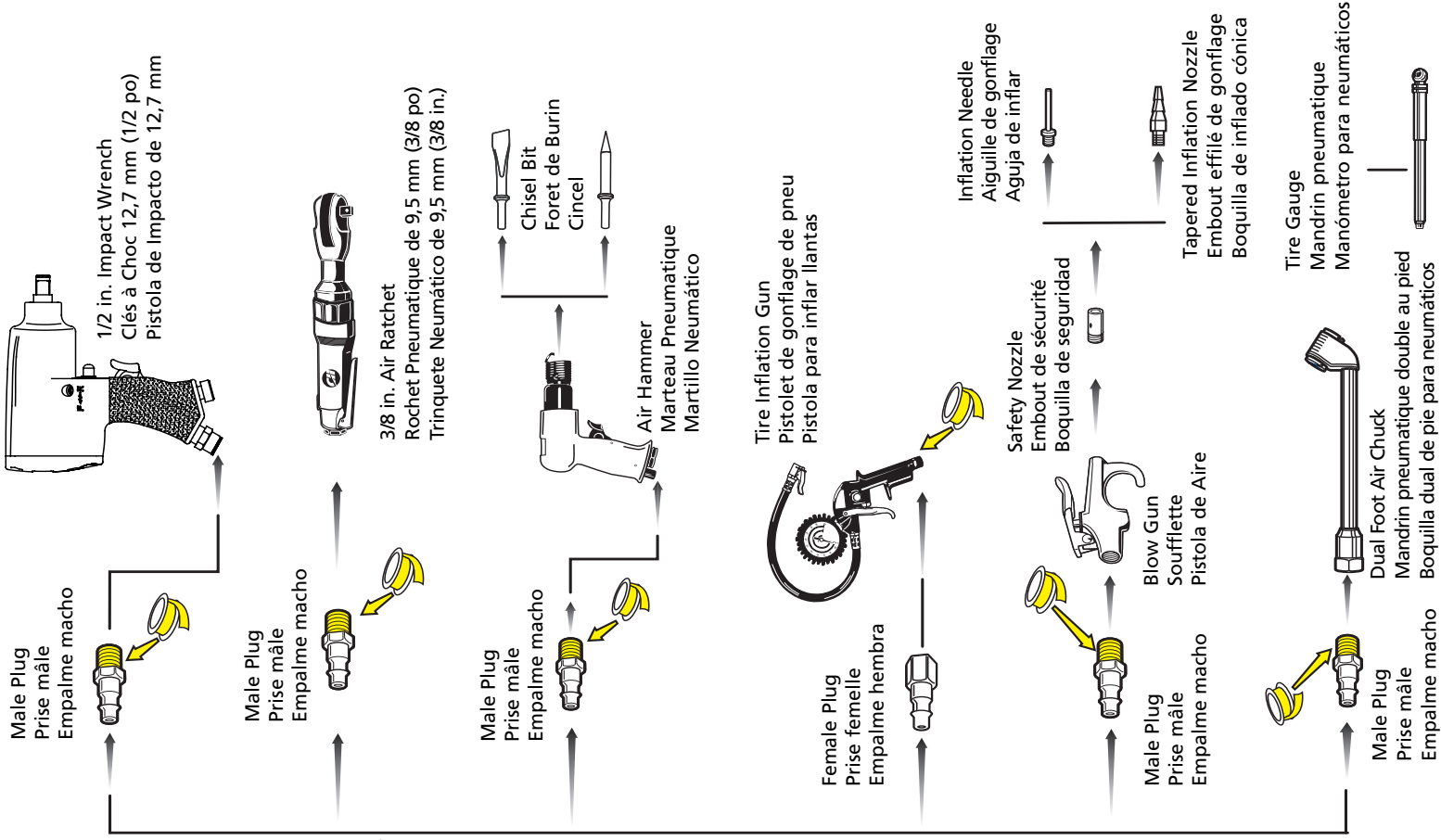

**Oil: For use in compressor pump**  
**Huile : A utiliser dans la pompe du compresseur**  
**Aceite: Para usar en la bomba del compresor**

**Used to check tire pressure**  
**Utiliser pour vérifier la pression du pneu**  
**Se usa para comprobar la presión del neumático**

## Free Manuals Download Website

<http://myh66.com>

<http://usermanuals.us>

<http://www.somanuals.com>

<http://www.4manuals.cc>

<http://www.manual-lib.com>

<http://www.404manual.com>

<http://www.luxmanual.com>

<http://aubethermostatmanual.com>

Golf course search by state

<http://golfingnear.com>

Email search by domain

<http://emailbydomain.com>

Auto manuals search

<http://auto.somanuals.com>

TV manuals search

<http://tv.somanuals.com>