

# ***IP Router***

## ***MENU-DRIVEN USER INTERFACE***

### ***USER MANUAL***

---

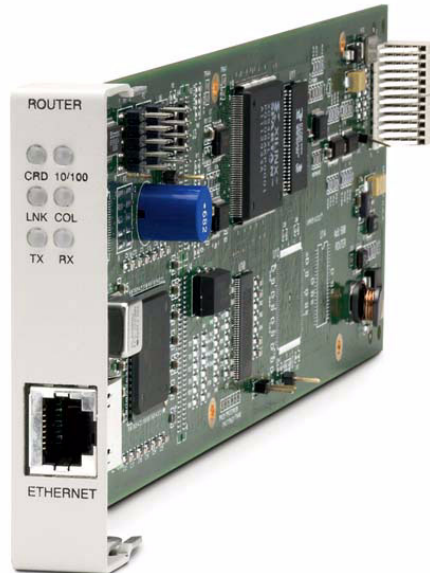

Part Number: 770-0015 AM

Product Release: 1.8

May 2004

---

Copyright 2004 Carrier Access Corporation. All rights reserved.

The information presented in this manual is subject to change without notice and does not represent a commitment on the part of Carrier Access Corporation. The hardware and software described herein are furnished under a license or non-disclosure agreement. The hardware, software, and manual may be used or copied only in accordance with the terms of this agreement. It is against the law to reproduce, transmit, transcribe, store in a retrieval system, or translate into any medium - electronic, mechanical, magnetic, optical, chemical, manual, or otherwise - any part of this manual or software supplied with the IP Router Service card for any purpose other than the purchaser's personal use without the express written permission of Carrier Access Corporation.

The Carrier Access logo, *solve for x*, and Adit are registered trademarks of Carrier Access Corporation. All other brand or product names are trademarks or registration trademarks of their respective companies or organizations.

Contact Information:

Carrier Access Corporation  
5395 Pearl Parkway  
Boulder, CO 80301-2490  
Corporate Phone: (800) 495-5455  
Fax: (303) 443-5908  
[www.carrieraccess.com](http://www.carrieraccess.com)

Customer Support Direct: (800) 786-9929  
E-mail: [tech-support@carrieraccess.com](mailto:tech-support@carrieraccess.com)

**Supporting Software Version:**

Adit 600 Release 8.0  
IP Router Release 1.8

# PREFACE

---

## ***Warranty***

Carrier Access warrants to BUYER that Products are free from substantial defect in material and workmanship under normal use given proper installation and maintenance for period of five (5) years from the date of shipment by Carrier Access. This warranty shall not apply to Products that have been either resold or transferred from BUYER's customer to any other party. Any such transfer shall void the above warranty.

BUYER will promptly notify Carrier Access of any defect in the Product. Carrier Access or its agent will have the right to inspect the Product or workmanship on BUYER's premises or BUYER's customer's premises. Carrier Access has the option to: (a) repair, replace, or service at its factory or on the premises the Product or workmanship found to be defective; or (b) credit BUYER for the PRODUCT in accordance with Carrier Access's depreciation policy. Refurbished material may be used to repair or replace the Product. Products returned to Carrier Access for repair, replacement, or service will be shipped prepaid by BUYER.

## ***Limitation of Warranty & Limitation of Remedies***

Correction of defects by repair, replacement, or service will be at Carrier Access's option and constitute fulfillment of all obligations to BUYER for breach of warranty.

Carrier Access assumes no warranty liability with respect to defects in the Product caused by:

- a. modification, repair, installation, operation, or maintenance of the Product by anyone other than Carrier Access or its agent, except as described in Carrier Access's documentation; or
- b. the negligent or other improper use of the Product; or
- c. handling or transportation after title of the Product passes to BUYER.

Other manufacturer's equipment purchased by Carrier Access and resold to BUYER will be limited to that manufacturer's warranty. Carrier Access assumes no warranty liability for other manufacturer's equipment furnished by BUYER.

BUYER understands and agrees as follows: THE WARRANTIES IN THIS AGREEMENT REPLACE ALL OTHER WARRANTIES, EXPRESSED OR IMPLIED, AND ALL OTHER

## ***Preface***

### ***Warranty***

---

OBLIGATIONS OR LIABILITIES OF CARRIER ACCESS, INCLUDING ANY WARRANTIES OF MERCHANTABILITY AND FITNESS FOR A PARTICULAR PURPOSE. ALL OTHER WARRANTIES ARE DISCLAIMED AND EXCLUDED BY CARRIER ACCESS.

THE REMEDIES CONTAINED IN THIS AGREEMENT WILL BE THE SOLE AND EXCLUSIVE REMEDIES WHETHER IN CONTRACT, TORT, OR OTHERWISE, AND CARRIER ACCESS WILL NOT BE LIABLE FOR INJURIES OR DAMAGES TO PERSONS OR PROPERTY RESULTING FROM ANY CAUSE WHATSOEVER, WITH THE EXCEPTION OF INJURIES OR DAMAGES CAUSED BY THE GROSS NEGLIGENCE OF CARRIER ACCESS.

THIS LIMITATION APPLIES TO ALL SERVICES, SOFTWARE, AND PRODUCTS DURING AND AFTER THE WARRANTY PERIOD. IN NO EVENT WILL CARRIER ACCESS BE LIABLE FOR ANY SPECIAL, INCIDENTAL, OR CONSEQUENTIAL DAMAGES OR COMMERCIAL LOSSES EVEN IF CARRIER ACCESS HAS BEEN ADVISED THEREOF.

No agent, Distributor, or representative is authorized to make any warranties on behalf of Carrier Access or to assume for Carrier Access any other liability in connection with any of Carrier Access's Products, software, or services.

## ***Warranty Product Returns***

Before returning any equipment to Carrier Access Corporation, first contact the distributor or dealer from which you purchased the product.

A Return Material Authorization (RMA) number is required for all equipment returned to Carrier Access Corporation. Call Carrier Access Corporation Customer Support at (800) 786-9929 or (303) 442-5455 for RMA number, repair/warranty information and shipping instructions. Be prepared to provide the following information:

- Carrier Access Corporation serial number(s) from the system chassis or circuit card(s)
- Name of distributor or dealer from which you purchased the product
- Description of defect

# TABLE OF CONTENTS

---

## ***Preface***

Warranty . . . . .	iii
Limitation of Warranty & Limitation of Remedies . . . . .	iii
Warranty Product Returns . . . . .	iv

## ***1 Introduction***

Overview . . . . .	1-2
Installation . . . . .	1-2
Install a Router Card . . . . .	1-2
Maneuvering in the System . . . . .	1-2
Fields . . . . .	1-3
Scroll Field . . . . .	1-3
Select Field . . . . .	1-3
Edit Field . . . . .	1-3
Help Bar . . . . .	1-4
Connecting to the Router . . . . .	1-5
Establish a Telnet Session . . . . .	1-5
Set a New Password . . . . .	1-6

## **2 Management Window**

Management Overview .....	2-2
System Time/Login .....	2-3
System Date and Time .....	2-4
Auto-Logout Timer .....	2-5
View Password .....	2-5
Config Password .....	2-5
Admin Password .....	2-5
Enhanced Security .....	2-6
Upload/Download .....	2-8
To Setup the Router for Uploads/Downloads .....	2-8
Upload/Download Setup Menu Fields .....	2-10
Load Defaults .....	2-12
Software Images .....	2-13
Choices .....	2-14

## **3 Profile Directory: Router Card Profile**

Overview .....	3-2
Configuration .....	3-2
RIP Mode Receive .....	3-3
RIP Mode Send .....	3-3
Trunk .....	3-4
Security .....	3-7
SNMP .....	3-10
DNS Proxy .....	3-14
Spanning Tree Protocol .....	3-16
Network Time Protocol .....	3-18
SysLog .....	3-20
DNS Resolver .....	3-22

## 4 Profile Directory: Local Profile

LAN (Local) Profile Setup .....	4-3
To Setup a Local Profile: .....	4-5
LAN IP: .....	4-8
LAN IPX: .....	4-8
Setup < > .....	4-9
Link Speed .....	4-9
Static Networks .....	4-10
To Setup Static Networks .....	4-12
Static Addresses .....	4-16
Filters .....	4-19
Defining Custom Filters .....	4-22
Defining Protocol Filters .....	4-23
Defining Address Filters .....	4-24
Advertise Network/Server .....	4-25
IPX Server Advertising .....	4-28
DHCP Server/BOOTP Relay .....	4-30
LAN Collision Threshold .....	4-34
Spanning Tree .....	4-37
Secondary IP Address .....	4-40
Link Speed .....	4-42

## 5 Profile Directory: Remote Profile

Remote (WAN) Profile .....	5-4
Transmission Options .....	5-6
Security/Options .....	5-12
Static/VPN Networks .....	5-15
VPN - > .....	5-21
Static NAT Addresses .....	5-22
NAT Bypass Subnets .....	5-24
Static Addresses .....	5-26
Firewall Filters .....	5-29
Filter Network/Server .....	5-35
Spanning Tree .....	5-40
Trunk Port .....	5-43

## **6 Basic Configuration**

Overview .....	6-2
Start Basic Configuration .....	6-2
Router Identification .....	6-4
Routing Protocol/Security .....	6-5
WAN Interface Connections .....	6-7
Remote Unit Profile .....	6-9
SNMP Configuration .....	6-12
Setup Complete .....	6-13

## **7 Verification Window**

Ping Utility .....	7-2
Trace Route .....	7-6
Port Monitor .....	7-9

## **8 Statistics Window**

Run-Time .....	8-2
----------------	-----

## **9 System Reports Window**

Events .....	9-2
To View the Event Log: .....	9-2
Alarms .....	9-4
Networks/Servers .....	9-6
Address Tables .....	9-9

## **10 Exit Window**

Logout .....	10-2
Reinitialize .....	10-3



## **11 Router Configuration**

Basic Setup .....	11-2
PPP Internet Connection and Public IP Address Routing.....	11-3
Frame Relay Internet Connection and Public IP Address Routing.....	11-4
Internet Connection using PPP, NAT/PAT and Firewall Filters .....	11-5
Internet Connection using NAT and Static NAT Addresses.....	11-7
Back-to-Back with PPP.....	11-9
Back-to-Back with Frame Relay.....	11-11

## **A User Events**

User Events .....	A-2
Authenticate Events.....	A-3
Triggered Events .....	A-4
Alarms.....	A-5

## **B Protocol Types**

Protocol Number in Firewall Filters .....	B-2
Ethernet Protocol Types .....	B-7

## **C Troubleshooting**

Communication Related Issues.....	C-2
Excessive Triggered Update Events on the Events screen .....	C-2
LAN Related Issues.....	C-2
Unable to add data filters, advertise networks or create static route entries.....	C-2
Unable to access the Local (LAN) Router unit via Telnet.....	C-4
Unable to access a remote unit via Telnet .....	C-4
Diagnostics and Performance Tools .....	C-5
Verification .....	C-6
Statistics .....	C-6
System Reports .....	C-7

## ***Table of Contents***

---

Alarms .....	C-8
Identify Alarm.....	C-8
Clear Alarm.....	C-10

## ***Glossary***

## ***Index***

# CHAPTER 1

---

## *Introduction*

### **In this Chapter**

- Overview
- Installation
- Maneuvering in the System
- Fields
- Help Bar
- Connecting to the Router

## **Overview**

This manual covers the Router menu-driven user interface only, all other information for the Router can be found in the Adit 600 User Manual.

The Router can be configured using CLI via telnet or through the Router Menu-driven Software.

## **Installation**

The IP Router card can be installed into any of the service card slots (1-6) of the Adit 600 chassis. This card is hot-swappable, therefore the card can be removed and replaced without bringing down the system or with or without power to the unit.

### **Install a Router Card**

1. Slide the Router card into a service card slot of the chassis.
2. Press firmly into slot to engage, until card is seated completely.
3. Card has completed bootup when a solid Red CRD light (an LED) is displayed.

## **Maneuvering in the System**

[**TAB**] moves from one field to the next.

Keyboard arrows move to the next field in the direction of the arrow.

[ ] Items in brackets are scrollable options. With the **Spacebar** the operator can move through the selections.

[**ENTER**] displays the window for the selected feature or to enter a alphanumeric value.

[**ESC**] Exit and return to previous window or to the Main Menu.

**Help Bar** - is displayed along the bottom of the window and lists options for the selected feature.

The Router software contains three different field types that may be used in entering information: scroll, select and edit.

## **Fields**

### **Scroll Field**

A field enclosed in angle brackets is a scrollable option field. While the field is selected use the following keystrokes:

[SPACEBAR] will scroll forward through the options

[ENTER] will open the option's window or accept the entered value.

**Example: Terminal: <vt100>**

### **Select Field**

A field followed by -> is a selectable field, which causes an action to be performed, highlight the field and press [ENTER] to perform the action, for example, to enter the Trunk Port Setup screen.

**Example: SETUP <Trunk> ->**

Some selectable fields, such as Main Menu options, are also a scrollable option field. For example, <Events>->. Press the [SPACEBAR] to select the desired option and then press [ENTER] to perform the action.

### **Edit Field**

A field value enclosed in parentheses ( ) may be modified by entering an alphanumeric character.

**Example: SYSTEM NAME: (Adit)**

You will note that many editable fields are displayed with a default value. To change this value, highlight the field and type over the existing entry or press [DELETE] and then enter new value. Note: these fields are case sensitive. To enter this value press [ENTER].

## Introduction

### Help Bar

---

## Help Bar

The IP Router provides field specific help that is displayed at the bottom of the window. The help text will indicate if the field is scrollable or editable and provide a brief description of the field. If it is a selectable field, it will state what to do to invoke the action to be performed.

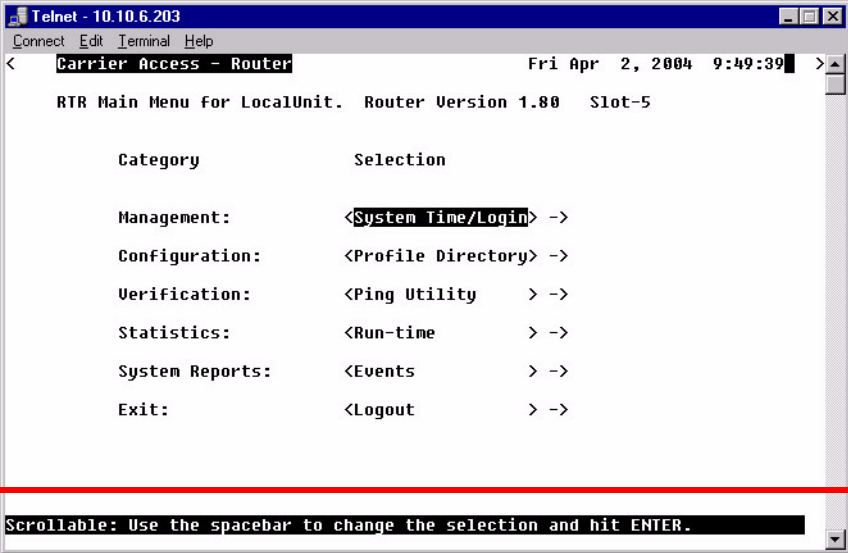

The screenshot shows a Telnet session with a terminal window titled "Telnet - 10.10.6.203". The window contains a menu for "Carrier Access - Router" with the following options:

Category	Selection
Management:	<System Time/Login> ->
Configuration:	<Profile Directory> ->
Verification:	<Ping Utility > ->
Statistics:	<Run-time > ->
System Reports:	<Events > ->
Exit:	<Logout > ->

At the bottom of the window, a red box highlights a help bar with the text: "Scrollable: Use the spacebar to change the selection and hit ENTER."

## Connecting to the Router

### Establish a Telnet Session

1. Use the **telnet {rtr\_card-addr}** CLI command to connect to the Router card. The following example is when the router is located in slot 5.

```
> telnet 5
Connected.
      Escape character is '^'.
Attempting Carrier Access QTSR connection...
QTSR [Sat Apr 10, 2004 10:51:23] (<CR> to login)
```

2. Select **[ENTER]** or **<CR>** to log in.

```
Password >
```

3. Enter default password (**admin**) and press **[ENTER]**.

```
Password >*****
Select a terminal type...
(<space> or <back-space> to toggle, <CR> to accept)

Terminal: <VT100>
```

4. Select Terminal Type: scroll through options with the **[SPACEBAR]** and then **[ENTER]** to select. Recommended **<generic>**.

```
Terminal: <generic>
```

## Set a New Password

If you have logged in with a default password, for security reasons the password should be changed, the system directs the user to do so.

```
> telnet 3
Connected.
      Escape character is '^]'.
Attempting Carrier Access QTSR connection...
QTSR [Wed Apr 10, 2004 5:51:21] (<CR> to login)
Password >*****
Select a terminal type...
(<space> or <back-space> to toggle, <CR> to accept)

Terminal: <generic>
You have logged in with a default password.
For security reasons the password should be changed.
Complete the change request and record your new password
for future use.

Password Change Request

(Valid QTSR passwords are from 5 to 15 alpha-numeric
characters)

      NEW Password >*****
      RETYPE Password >*****
```

After a successful login, the system prompts the user to change the password from the default.

1. Type in New Password, and press **[ENTER]**
2. Retype in New Password, and press **[ENTER]**



# CHAPTER 2

---

## *Management Window*

### **In this Chapter**

- Management Overview
- System Time/Login
- Upload/Download
- Load Defaults
- Software Images

## **Management Overview**

The **Management Menu** contains the system components of the IP Router software. This section is used to define security parameters, factory default settings, as well as providing software loading and configuration settings for the Router

Management Menu options allow the user to:

- Establish the system security features
- Install and backup system software
- Backup and install configuration settings
- Default system parameters to factory settings

---

**NOTE:** Two simultaneous sessions are allowed to access the Router software. For example, one local and one remote (one must be accessing with the VIEW level).

---

## **System Time/Login**

1. Select **Management <System Time/Login>** from the Main Menu, and select **[ENTER]**.

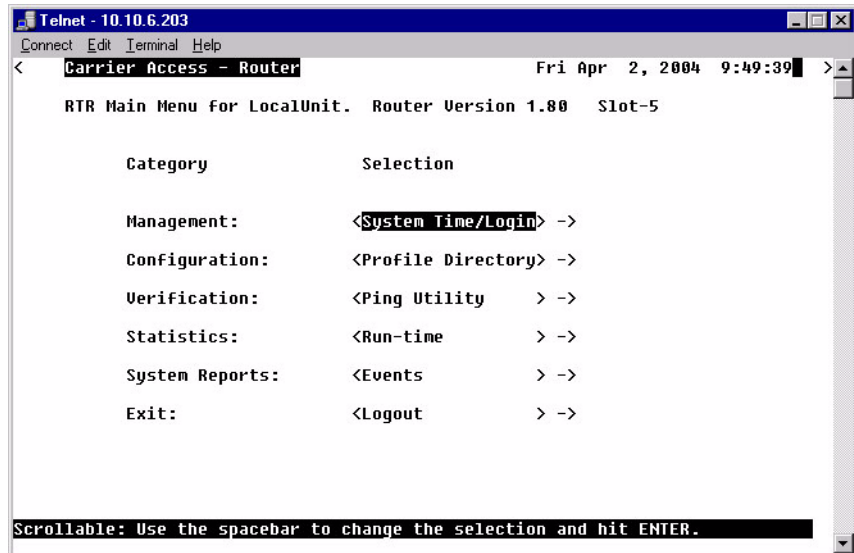

```
Telnet - 10.10.6.203
Connect Edit Terminal Help
Carrier Access - Router          Fri Apr  2, 2004  9:49:39
RTR Main Menu for LocalUnit. Router Version 1.80 Slot-5

Category           Selection

Management:       <System Time/Login> ->
Configuration:    <Profile Directory> ->
Verification:     <Ping Utility   > ->
Statistics:       <Run-time       > ->
System Reports:   <Events         > ->
Exit:            <Logout        > ->

Scrollable: Use the spacebar to change the selection and hit ENTER.
```

## Management Window

### System Time/Login

---

This screen provides the basic system and security options for the Router card.

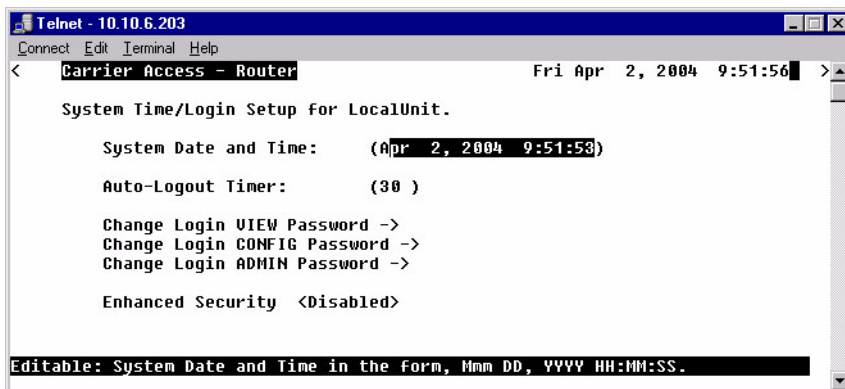

The IP Router is equipped with three password levels and an enhanced security password.

**Level 1 VIEW** allows the user to view only, no changes are allowed.

**Level 2 CONFIG** allows the user to view and change all screens.

**Level 3 ADMIN** allows the user to view and change all screens, terminate users, as well as change all three passwords.

The **Enhanced Security** option provides an additional level of security for the network administrator.

## System Date and Time

The time and date values are used for reporting purposes. Enter the date in the following format: Mmm DD, YYYY. Immediately follow the date with the desired time entry. The appropriate time format is HH:MM:SS (hour:minute:second). Press [TAB] to proceed to the next field.

## ***Auto-Logout Timer***

This field defines the minutes of inactivity before the current session is terminated. The default time is 30 minutes. Type the desired auto-logout time (between 1-255).

---

**NOTE:** Any changes that have not been saved will be lost when the timer is activated.

---

## ***View Password***

Users assigned to this level may view only, no changes are allowed. The default **VIEW** password is "**public**". This field must be unique from the **CONFIG** and **ADMIN** passwords. The field may be a 5-15 characters alphanumeric value.

## ***Config Password***

Users assigned to this level may view and change all screens. The default **CONFIG** password is "**config**". This entry must be unique from the **VIEW** and **ADMIN** passwords. The field may be a 5-15 character alphanumeric value.

## ***Admin Password***

Users assigned to this level may view and change all screens, as well as change all three password levels. The default **ADMIN** password is "**admin**". This entry must be unique from the **VIEW** and **CONFIG** passwords. The field value may be a 5-15 character alphanumeric value.

---

**NOTE:** If the default login passwords are not changed, the user will be prompted, at each login, to enter new passwords at the **CONFIG** and **ADMIN** levels.

---

### Enhanced Security

The **Enhanced Security** option provides another level of password security that restricts access to the Main Menu via Telnet or the Async port. It can be used by a Network Administrator to only allow those with the **Enhanced Security** password to make configuration changes. When enabled, this option hides the system login prompt until the appropriate password is entered.

1. Use the [SPACEBAR] to select **Enable** and [TAB] to enter this selection.
2. The **Change Enhanced Security Password ->** field will display. Select [ENTER] to change password. You will be requested to enter the password twice to confirm. Change Password of All Levels.

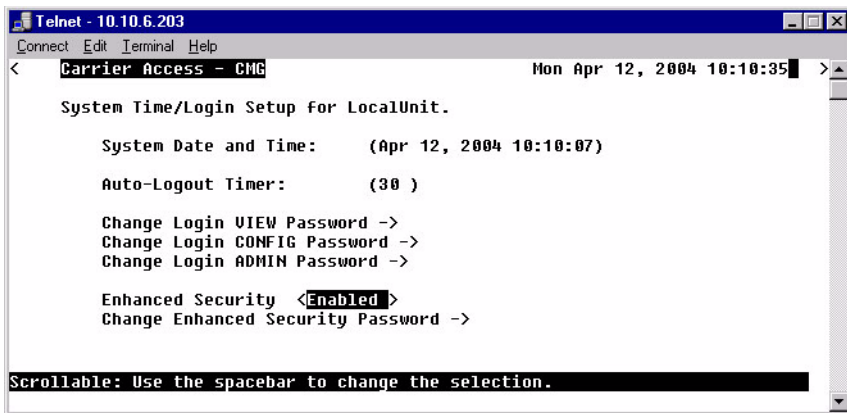

```
Telnet - 10.10.6.203
Connect Edit Terminal Help
< Carrier Access - CMG Mon Apr 12, 2004 10:10:35 >
System Time/Login Setup for LocalUnit.
System Date and Time: (Apr 12, 2004 10:10:07)
Auto-Logout Timer: (30 )
Change Login UIEW Password ->
Change Login CONFIG Password ->
Change Login ADMIN Password ->
Enhanced Security <Enabled>
Change Enhanced Security Password ->
Scrollable: Use the spacebar to change the selection.
```

**When Telneting into the Router with Enhanced Security enabled, the following will appear:**

```
> telnet 1
Connected.
Escape character is '^]'.
```

1. Type the Enhanced Security Password here.

---

**NOTE:** Note: there will be no effect to the screen here until the correct password is typed in. When the correct password is typed, no return or other keystroke is needed, the following will appear:

---

```
Password >
```

---

**WARNING!** IF ENHANCED SECURITY IS ENABLED, AND THE ADMINISTRATOR DOES NOT NOTE THE PASSWORD THERE IS NO WAY TO ACCESS THE ROUTER UNTIL YOU HAVE RESET THE ROUTER BACK TO IT'S DEFAULT SETTINGS, LOSING ALL CONFIGURATION SETTINGS. SEE *set [rtr\_card-addr] default*.

---

2. At this point the Router is requesting your Level 1, 2 or 3 User Password. Enter your password and select [ENTER] and continue as you would Telnet into the Router as normal.

```
Password >*****  
Select a terminal type...  
(<space> or <back-space> to toggle, <CR> to accept)  
  
Terminal: <generic>
```

# Upload/Download

**WARNING!** BEFORE LOADING A DOWN-LEVEL OF ROUTER CODE TO AN ADIT, SAVE THE CONFIGURATION TO A FILE. CONFIGURATION MAY BE RESET TO THE DEFAULT SETTING AND CURRENT CONFIGURATION LOST.

This window allows the network administrator management of devices and users authorized to perform:

- Installation of software
- Backup of software and configuration settings (via tftp)

The IP Router management enables a network administrator to perform a Router **Code Upload** from a central location via the LAN or WAN connection using TFTP. A **Code Download** can also be performed as a backup (binary image) of the software. **Config Upload** and **Config Download** can be performed remotely via TFTP to install and backup the IP Router's configuration to and from a binary file.

There is an additional option to upload code to the IP Router, with the CLI command `load {slot-number} tftp {ip-addr}{"file-name"}`

## To Setup the Router for Uploads/Downloads

1. Select **Management: <Upload/Download>** from the Main Menu, and **[ENTER]**.

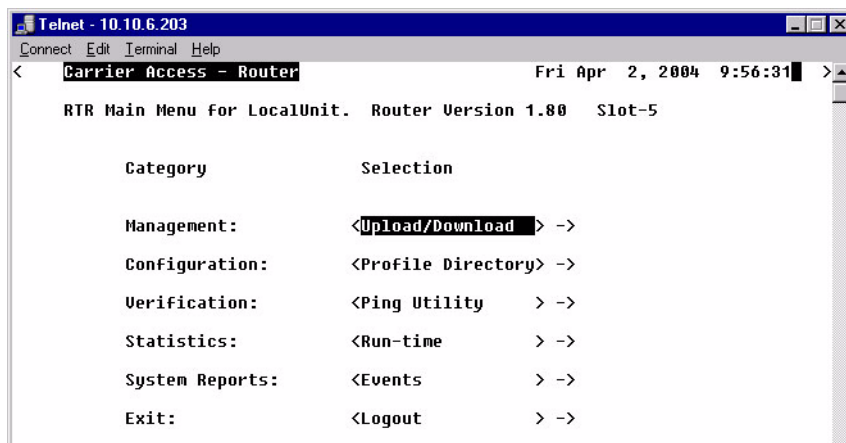



2. Select [CTRL A] to add a TFTP Upload/Download User.

**NOTE:** The IP Address 1. (\* ) will display. The \* denotes **any** IP Address on the defined **Client Site**. The user may define a specific IP Address for Uploads/Downloads, by replacing the \*, or by Adding another Upload/Download User.

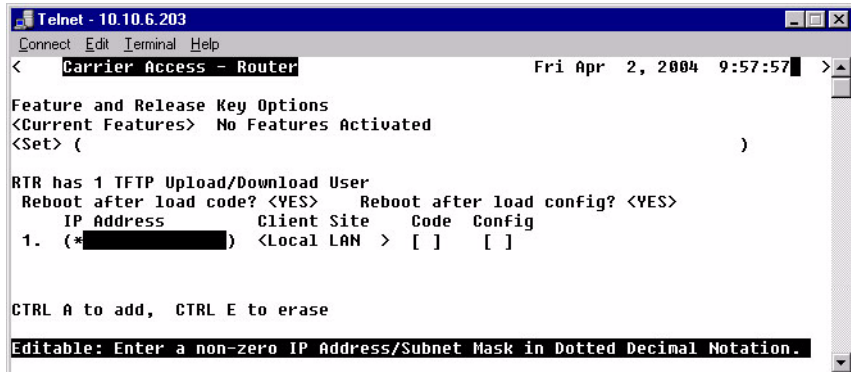

```
Telnet - 10.10.6.203
Connect Edit Terminal Help
< Carrier Access - Router                               Fri Apr 2, 2004 9:57:57 >
Feature and Release Key Options
<Current Features> No Features Activated
<Set> ( )

RTR has 1 TFTP Upload/Download User
Reboot after load code? <YES> Reboot after load config? <YES>
  IP Address      Client Site  Code  Config
  1. (*          ) <Local LAN > [ ]  [ ]

CTRL A to add, CTRL E to erase
Editable: Enter a non-zero IP Address/Subnet Mask in Dotted Decimal Notation.
```

3. Select the **Client Site**  
Selection is: <Local LAN> (default) or **RemoteUnits** that have been set up.
4. Press [ESC] to save your changes and return to the **Main Menu**. These changes will go into effect immediately.

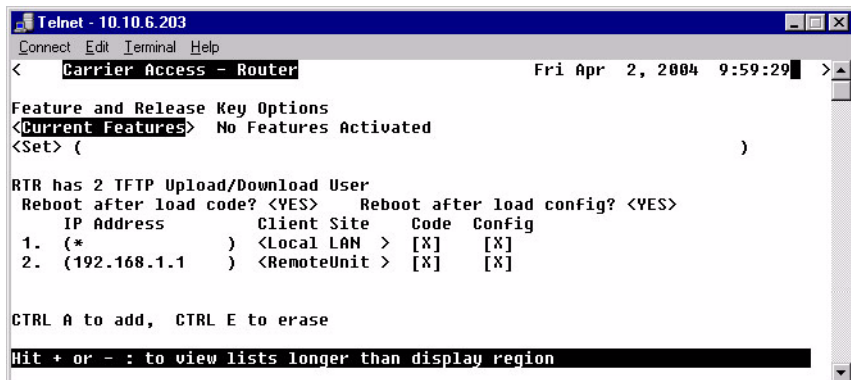

```
Telnet - 10.10.6.203
Connect Edit Terminal Help
< Carrier Access - Router                               Fri Apr 2, 2004 9:59:29 >
Feature and Release Key Options
<Current Features> No Features Activated
<Set> ( )

RTR has 2 TFTP Upload/Download User
Reboot after load code? <YES> Reboot after load config? <YES>
  IP Address      Client Site  Code  Config
  1. (*          ) <Local LAN > [X]  [X]
  2. (192.168.1.1) <RemoteUnit> [X]  [X]

CTRL A to add, CTRL E to erase
Hit + or - : to view lists longer than display region
```

## Upload/Download Setup Menu Fields

### Feature and Release Key Options

Options may be available to purchase, to upgrade the IP Router. Once this option is purchased, a key code will be given to enable the feature on this product. For more information please call Customer Service.

### Reboot After Load Code

Use this option to automatically reboot the IP Router after software is successfully installed. A software load verification verifies that the new software is good before the unit will accept it. If it is determined to be bad or damaged, the IP Router will reject it and continue to use the original software.

### Reboot After Load Config

Use this option to automatically reboot the IP Router after a configuration file is successfully installed.

### IP Address

The **IP Address** field is use to identify which device(s) will be allowed to perform config and/or code uploads and downloads. A "\*" in this field will allow all devices at the selected **Client Site** to perform Uploads/Downloads.

### Client Site

This field identifies the profile the Router will use to reach the **IP Address** entered in the previous field. If **<Local LAN>** is selected, it indicates the device can be reached via the LAN. If the device can be reached via a WAN connection, you should select one of the Remote (WAN) profiles.

### Code Upload/Download

Use this field option to enable **Code Upload/Download** and authorize the IP Address to perform a Code Upload and Code Download. When new software is installed on the Router, a software load verification checks and verifies that the new software is good before the unit will accept it. If it is determined to be bad or damaged, the IP Router will reject it and continue to use the original software. Acceptable binary file extensions are .mgm or .MGM.

### ***Config Upload/Download***

This option to enables **Config Upload/Download** and defines an **IP Address** to perform this function. **Config Upload** allows the device(s) in the IP Address field to transfer, or restore, a previously backed up configuration file to the IP Router via TFTP. **Config Download** defines an IP Address to save a backup copy of the IP Router's configuration settings to a file. Acceptable file extensions are “.cfg” or “.CFG”.

---

**NOTE:** Code and Config uploads will require a reboot of the unit before the changes take effect.

---

## Management Window

### Load Defaults

---

## Load Defaults

Use the Load Defaults option to reset the Router software to the factory defaults. This option will delete all configuration settings, including the passwords.

Use the [SPACEBAR] to choose <Yes> and press [ENTER]. If you have a Telnet connection to the unit, your session will be terminated.

1. Select **Management <Load Defaults>** from the Main Menu, and select [ENTER].

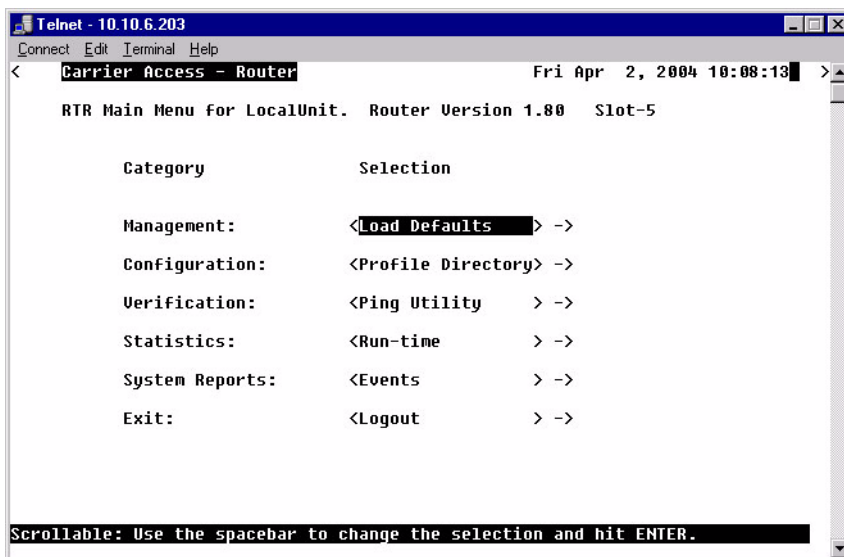

```
You are about to DELETE the CURRENT CONFIGURATION
and LOAD FACTORY DEFAULTS. Are You Sure? <NO >
```

2. A dialog box will display confirming that you want to load factory defaults.
3. Select <YES> with the [SPACEBAR] and select [ENTER].
4. Defaults will be loaded.

## Software Images

Use the Software Images option to switch the active with the backup application images stored in the Router.

1. Select **Management <Software Images>** from the Main Menu, and select **[Enter]**.

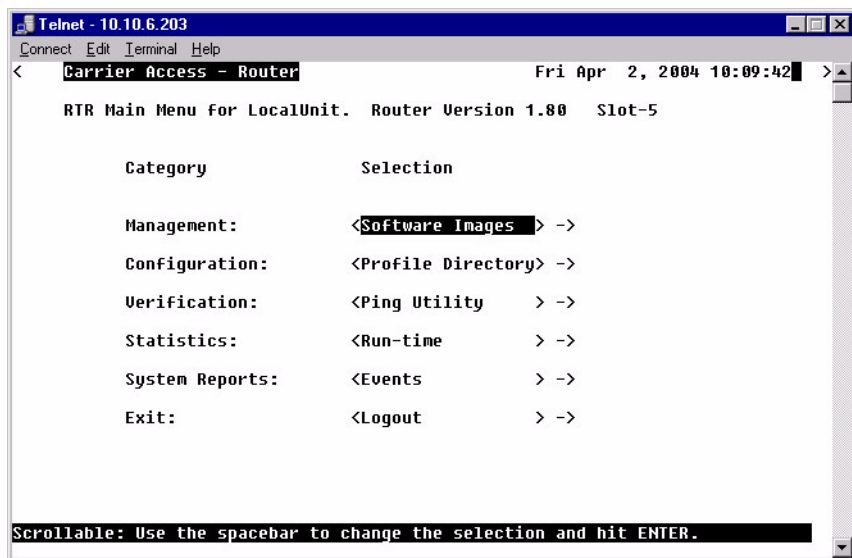

## Management Window

### Software Images

---

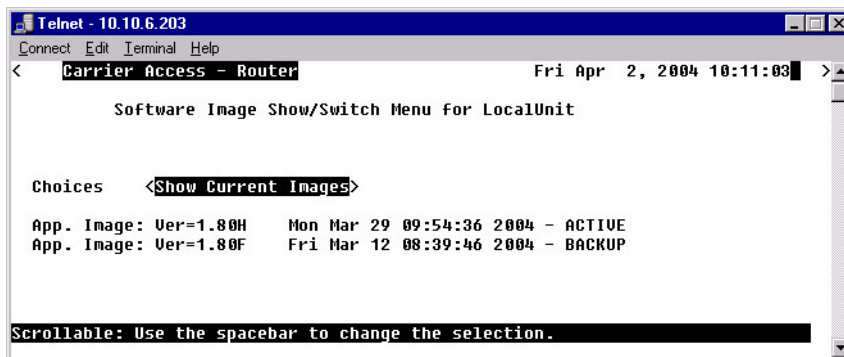

```
Telnet - 10.10.6.203
Connect Edit Terminal Help
Carrier Access - Router          Fri Apr 2, 2004 10:11:03
Software Image Show/Switch Menu for LocalUnit

Choices  <Show Current Images>

App. Image: Ver=1.80H   Mon Mar 29 09:54:36 2004 - ACTIVE
App. Image: Ver=1.80F   Fri Mar 12 08:39:46 2004 - BACKUP

Scrollable: Use the spacebar to change the selection.
```

### Choices

**Show Current Images** - will display the application images stored in the Router (shown above).

**Switch Appl. Images** - Switch the active with the backup application images stored in the router. Note: More than one software image must be loaded (7.0 or later) for an **active** and a **backup** image to display.

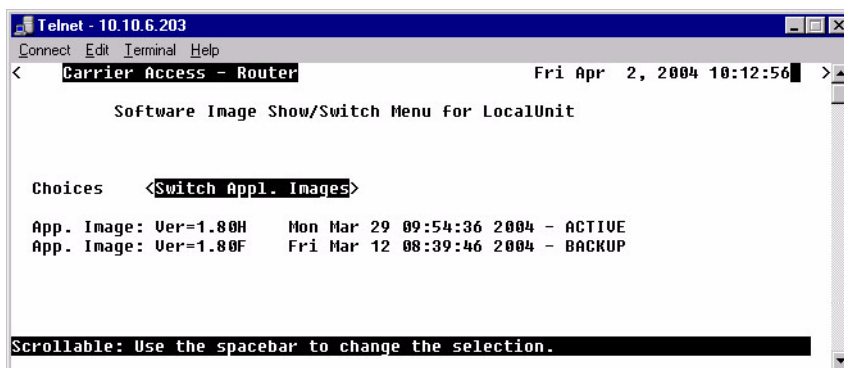

```
Telnet - 10.10.6.203
Connect Edit Terminal Help
Carrier Access - Router          Fri Apr 2, 2004 10:12:56
Software Image Show/Switch Menu for LocalUnit

Choices  <Switch Appl. Images>

App. Image: Ver=1.80H   Mon Mar 29 09:54:36 2004 - ACTIVE
App. Image: Ver=1.80F   Fri Mar 12 08:39:46 2004 - BACKUP

Scrollable: Use the spacebar to change the selection.
```

# CHAPTER 3

---

## ***Profile Directory: Router Card Profile***

### **In this Chapter**

- Overview
- Configuration
- RIP Mode Receive
- RIP Mode Send
- Trunk
- Security
- SNMP
- DNS Proxy
- Spanning Tree Protocol
- Network Time Protocol
- SysLog
- DNS Resolver

## Profile Directory: Router Card Profile

### Overview

---

## Overview

The Router Card Profile of the Profile Directory is used to review/configure the Network Time Protocol, DNS Proxy, DNS Resolver, RIP mode, Spanning Tree Protocol, Security, SNMP, Syslog and Trunk parameters.

## Configuration

1. Select **Configuration: <Profile Directory>** from the Main Menu, and select [ENTER].

### Main Menu

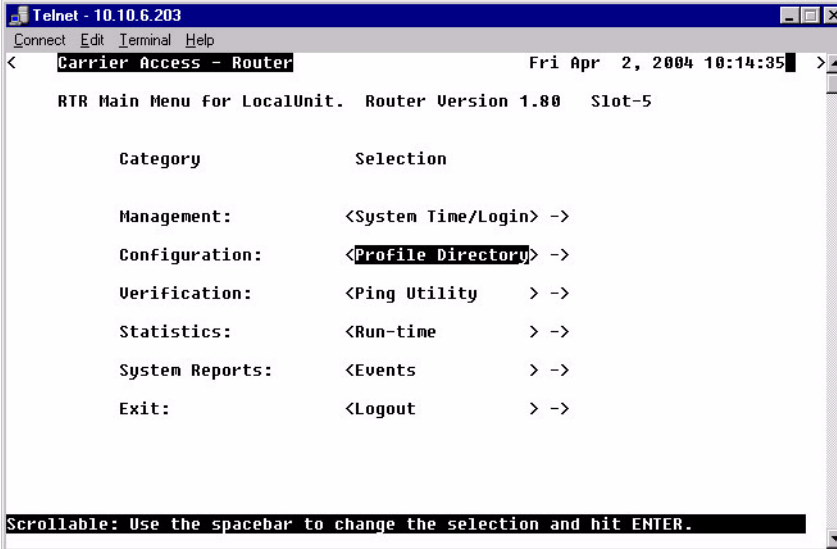

```
Telnet - 10.10.6.203
Connect Edit Terminal Help
< Carrier Access - Router                               Fri Apr 2, 2004 10:14:35 >
RTR Main Menu for LocalUnit. Router Version 1.80 Slot-5

      Category           Selection

Management:             <System Time/Login> ->
Configuration:          <Profile Directory> ->
Verification:           <Ping Utility   > ->
Statistics:              <Run-time       > ->
System Reports:         <Events         > ->
Exit:                   <Logout         > ->

Scrollable: Use the spacebar to change the selection and hit ENTER.
```



2. Select **Router CARD** <Setup -> and select [ENTER].

**Profile  
Directory  
Window**

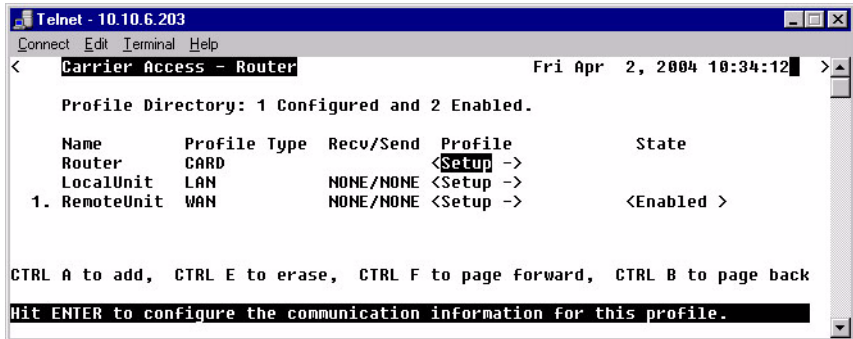

```
Telnet - 10.10.6.203
Connect Edit Terminal Help
< Carrier Access - Router Fri Apr 2, 2004 10:34:12 >
Profile Directory: 1 Configured and 2 Enabled.
Name      Profile Type  Recv/Send  Profile      State
Router    CARD          <Setup ->
LocalUnit LAN           NONE/NONE <Setup ->
1. RemoteUnit WAN       NONE/NONE <Setup -> <Enabled >

CTRL A to add, CTRL E to erase, CTRL F to page forward, CTRL B to page back
Hit ENTER to configure the communication information for this profile.
```

**Router  
Card  
Configuration  
Window**

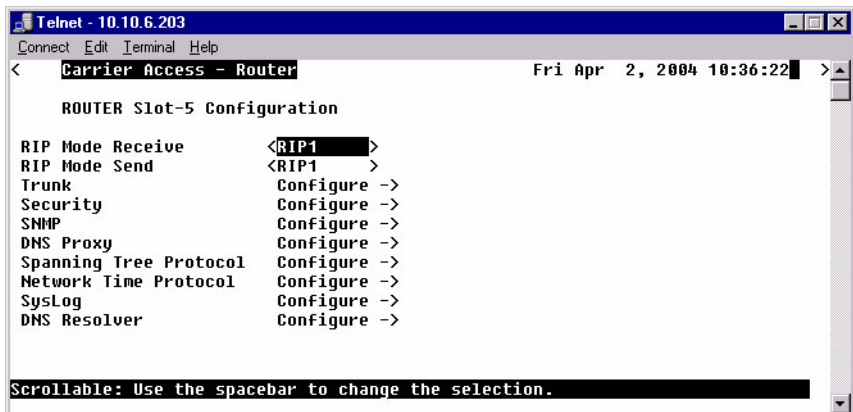

```
Telnet - 10.10.6.203
Connect Edit Terminal Help
< Carrier Access - Router Fri Apr 2, 2004 10:36:22 >
ROUTER Slot-5 Configuration
RIP Mode Receive <RIP1 >
RIP Mode Send <RIP1 >
Trunk Configure ->
Security Configure ->
SNMP Configure ->
DNS Proxy Configure ->
Spanning Tree Protocol Configure ->
Network Time Protocol Configure ->
SysLog Configure ->
DNS Resolver Configure ->

Scrollable: Use the spacebar to change the selection.
```

## ***RIP Mode Receive***

Selection is: <RIP1>, <RIP2>, or <RIP1/RIP2>.

## ***RIP Mode Send***

Selection is: <RIP1>, <RIP2>, or <RIP1/RIP2>.

## **Trunk**

This window is used to configure the Trunk setup for the Router. Although the Router is designed to connect remote sites over dedicated connections, the unit supports a number of different encapsulation protocols simultaneously, including Frame Relay and PPP. The Router provides the flexibility to allow the user to define which slots will be used for the selected WAN protocol.

1. Select **Trunk < Configure ->** and select [**ENTER**].

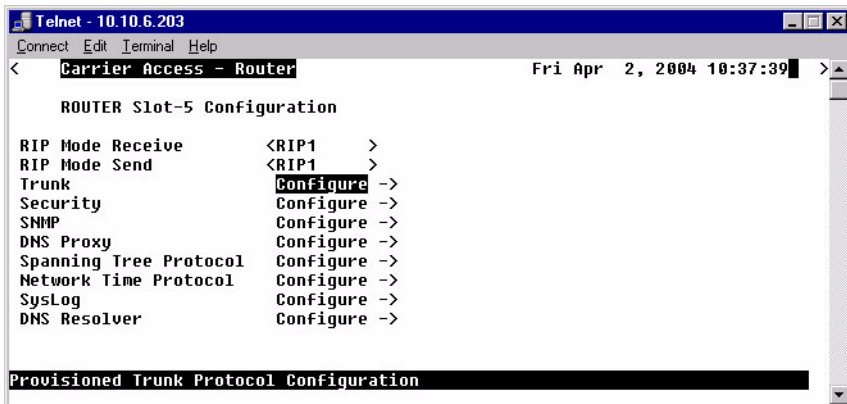

2. All WAN connections will display in this window. To select the WAN Connection Type, [**TAB**] to the Type on the specific WAN Link #, use the [**SPACEBAR**] to select the Type (PPP, MLPPP, PPP in Frame Relay or Frame Relay 1490) and select [**ENTER**]. For more information on this window, see Trunk Port Fields Definitions on the next page.

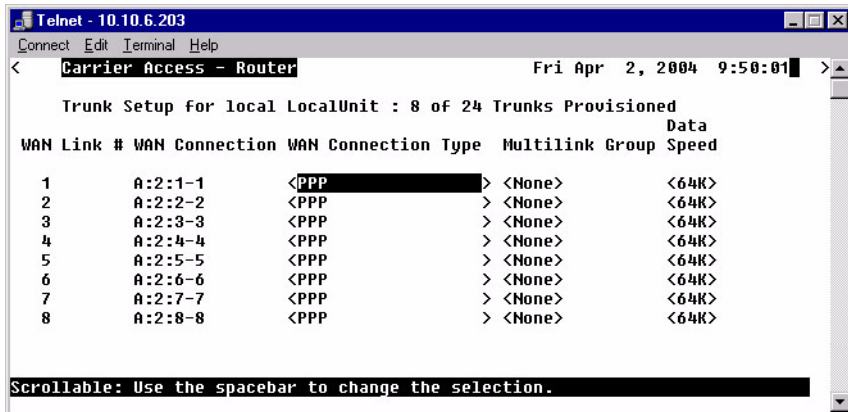

```

Telnet - 10.10.6.203
Connect Edit Terminal Help
< Carrier Access - Router                               Fri Apr 2, 2004 9:50:01 >
Trunk Setup for local LocalUnit : 8 of 24 Trunks Provisioned
WAN Link # WAN Connection WAN Connection Type Multilink Group Data Speed
1          A:2:1-1          <PPP          > <None>          <64K>
2          A:2:2-2          <PPP          > <None>          <64K>
3          A:2:3-3          <PPP          > <None>          <64K>
4          A:2:4-4          <PPP          > <None>          <64K>
5          A:2:5-5          <PPP          > <None>          <64K>
6          A:2:6-6          <PPP          > <None>          <64K>
7          A:2:7-7          <PPP          > <None>          <64K>
8          A:2:8-8          <PPP          > <None>          <64K>
Scrollable: Use the spacebar to change the selection.

```

## Trunk Setup Menu Fields

### WAN Link #

This field displays the WAN Link Number (1-24) for the WAN Connection and the WAN Connection Type information.

### WAN Connection

The WAN Connection displays the current connection of this WAN, in the form of {slot:port:channel}.

### WAN Connection Type

The value in this field determines the type of protocol encapsulation that will be used for the selected WAN.

#### PPP

**Point-to-Point Protocol.** Provides a standard means of encapsulating data packets sent over a single-channel WAN link. It is the standard WAN encapsulation protocol for the inter- operability of bridges and routers. Note: When a Multilink Group is selected, WAN Connection Type will display <MLPPP>

#### MLPPP

MultiLink PPP. When PPP is selected and a Multilink group is chosen the WAN Connection Type will display MLPPP.

#### PPP in Frame Relay

**Point-to-Point Protocol** encapsulated in Frame Relay.

## Profile Directory: Router Card Profile

### Trunk

### Frame Relay 1490

A packet-switching protocol for connecting devices on a WAN. Frame Relay networks in the U.S. support data transfer rates at T1 (1.544 Mbps) and T3 (45 Mbps) speeds. Frame Relay service is provided for customers who want connections at 56 Kbps to T1 speeds.

### PVC Management

Field	Description
<b>Disabled</b>	Disables PVC Management
<b>Annex D</b>	Frame Relay standard
	Poll Interval      Range is between 5-30
	Poll Counter        Range is between 1-255
<b>LMI</b>	Local Management Interface
	Poll Interval        Range is between 5-30
	Poll Counter        Range is between 1-255

### Multilink Group

Specifies a trunk as part of a multilink PPP group. Selection is: <None> or <1> through <24>. Available only when PPP connection type is selected. Note: When a Multilink Group is selected, WAN Connection Type will display <MLPPP>.

```
Telnet - 10.10.6.203
Connect Edit Terminal Help
Carrier Access - Router                               Fri Apr 2, 2004 9:51:40
Trunk Setup for local LocalUnit : 8 of 24 Trunks Provisioned
WAN Link # WAN Connection WAN Connection Type  Multilink Group  Data Speed
1          A:2:1-1          <PPP          > <None>          <64K>
2          A:2:2-2          <PPP          > <None>          <64K>
3          A:2:3-3          <PPP          > <None>          <64K>
4          A:2:4-4          <PPP in Frame Relay> > <None>          <64K>
5          A:2:5-5          <Frame Relay 1490 > > <None>          <64K>
6          A:2:6-6          <MLPPP        > <1  >          <56K>
7          A:2:7-7          <MLPPP        > <1  >          <56K>
8          A:2:8-8          <PPP          > <None>          <56K>

PVC Management: <LMI  >
Poll Interval:  (1)
Poll Counter:   (6 )

Editable: Please enter a value.
```

### Data Speed

The Data Speed will specify the data speed for each DS0 in the given trunk. Selection is: <56K> or <64K>. The default is 64K.

## Security

1. Select **Security < Configure ->** and select [ENTER].

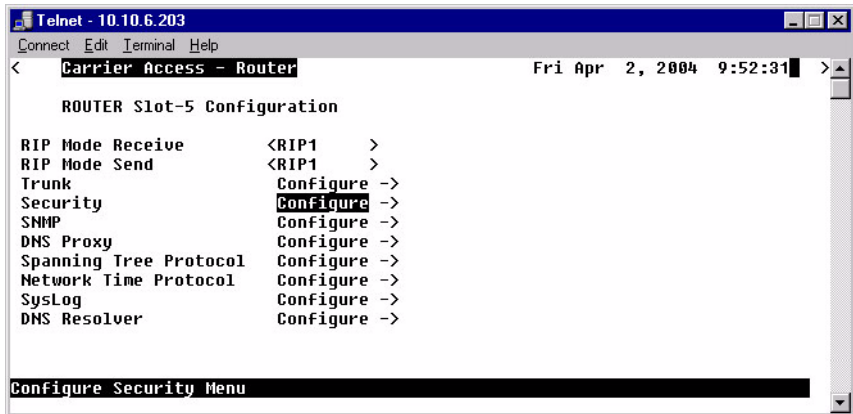

The fields on this screen may be used to define the authentication process for the Local Unit.

### Security Setup Window

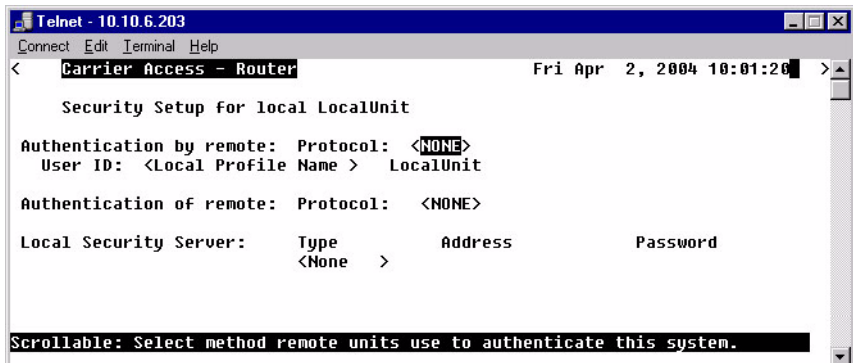

## Authentication by Remote

### Protocol: CHAP, PAP or NONE

Use this first field to identify the authentication protocol to be used by remote units when authenticating this unit.

<CHAP> Challenge Handshake Authentication Protocol

#### <CHAP> Secret

Select [ENTER] and a **NEW Password** dialog box will display. Enter a 1 - 15 character password and select [ENTER] and a **RETYPE Password** dialog box will display. Retype password and select [ENTER]. Password is now set.

<b>NEW Password:</b> *****
----------------------------

<b>RETYPE Password:</b> *****
-------------------------------

<PAP> Password Authentication Protocol

#### <PAP> Password

Same as above <CHAP> Secret.

<NONE > No authentication protocol. <NONE> is the default.

### User ID

Use this field to define the local unit's User ID. During the authentication process, the local unit will send a name or User ID, along with the authentication protocol's secret or password (see above). Use the [SPACEBAR] to scroll between <Local Profile Name> (the default value) and <Local Custom Name>. If set at <Local Profile Name>, the local unit will send the 11 character unit name which was defined on the Local (LAN) Profile screen. If this field is set to <Local Custom Name> you may define a 32 character maximum alphanumeric value to represent the User ID which is sent during the authentication process. Defining a custom User ID simply gives the end user more flexibility for this value.

To assign a custom User ID, set the **USER ID** field to <Local Custom Name> and press [TAB]. Up to ten (10) custom names may be configured.

## Authentication of Remote

### Protocol: CHAP, PAP or NONE

Use this field to identify the authentication protocol to be used by this IP Router when authenticating remote devices.

## Local Security Server

The router supports a configuration setting for each router card to determine how the router card logins are to be authenticated, as per one of the following choices: authenticate router logins from the router card local database (default), authenticate router logins by having the controller send a RADIUS access-request message to the controller's RADIUS servers, or authenticate router logins identically to controller logins. The last choice will cause the router logins to be authenticated either via RADIUS or the controller's database of users and passwords, as configured for the controller. This configuration is done with Controller CLI only (no menu support).

### Type

Use the [SPACEBAR] to choose the security authentication method that you are using.

<None> Use this setting if the Local unit will be used to authenticate remote devices. Please note that you may not use the <None> setting if the **Security Server** field for a remote device has been set to <External Server>

<RADIUS> Will set the server to use the RADIUS (Remote Authentication Dial-In Service) protocol. RADIUS is a client/server-based authentication software system.

<TACACS+> Will set the server to use the TACACS+ (Terminal Access Controller Access Control System) protocol. TACACS+ provides services of authentication, authorization and accounting independently.

### Address

Enter the IP Address of the local server that will be used during the authentication process. If <None> was selected in the <Type> field, this field will be disabled.

### Password

Enter the password of the local server that will be used during the authentication process. You must make sure that the password entered into the server is the same as the value entered here or the authentication process will fail. If <None> was selected in the <Type> field, this field will be disabled.

## **SNMP**

By defining specific IP Addresses, devices may be specified to manage the Local Unit via SNMP.

---

**NOTE:** The IP Router is compatible with the Standard MIB and MIB II.

---

1. Select **SNMP < Configure ->** and select [ENTER].

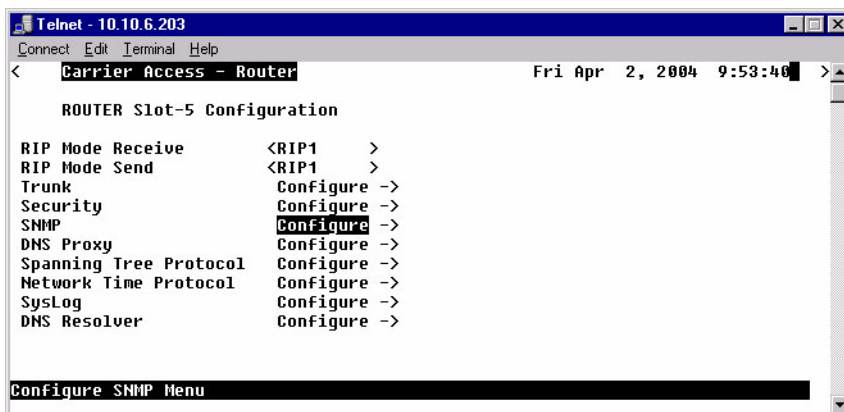

```
Telnet - 10.10.6.203
Connect Edit Terminal Help
< Carrier Access - Router Fri Apr 2, 2004 9:53:40 >
ROUTER Slot-5 Configuration
RIP Mode Receive <RIP1 >
RIP Mode Send <RIP1 >
Trunk Configure ->
Security Configure ->
SNMP Configure ->
DNS Proxy Configure ->
Spanning Tree Protocol Configure ->
Network Time Protocol Configure ->
SysLog Configure ->
DNS Resolver Configure ->
Configure SNMP Menu
```



Use the SNMP setup window to setup SNMP configurations.

**SNMP  
Setup  
Window**

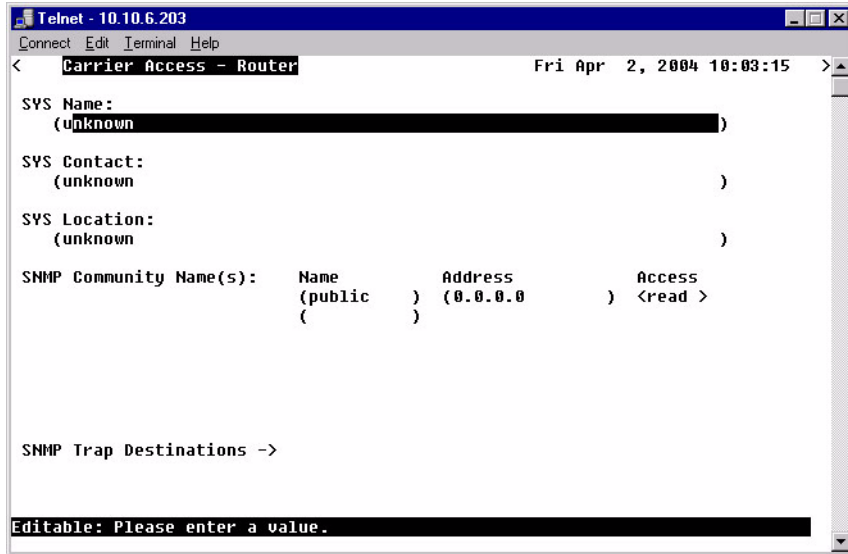

### **SYS Name**

Set the value of sysName. Value has a maximum of 64 ASCII characters.

### **SYS Contact**

Set the value of sysContact. Value has a maximum of 64 ASCII characters.

### **SYS Location**

Set the value of sysLocation. Value has a maximum of 64 ASCII characters.

### **SNMP Community Name(s)**

Use these fields to specify the community name, address and access privileges of devices needing to communicate with the Local (LAN) Unit through SNMP. If no IP Addresses is defined on this screen, any device may access the local unit using the IP Address assigned on the Local (LAN) Profile Setup screen, regardless of the specified community name. The values entered in these fields will be used by the SNMP program as verification of entry into the IP Router.

## Profile Directory: Router Card Profile

### SNMP

---

#### Name

Enter the community name(s) of the device to access the Local (LAN) Unit through SNMP. Community names entered into the SNMP program **MUST** match the values entered here or access for remote management will not be allowed. The default community name is **public**, new community names can have a maximum of 10 characters.

#### Address

Enter the corresponding IP Address of the device(s) that were entered in the **Name** field.

#### Access

<Read> device is allowed to view the settings, but cannot make any changes

<Write> device is allowed to make changes but not view settings

<Both> device is allowed to both read and write privileges

### SNMP Trap Destinations

SNMP  
Setup  
Window



```
Telnet - 10.10.6.203
Connect Edit Terminal Help
< Carrier Access - Router                               Fri Apr 2, 2004 10:03:52 >
SYS Name:
(unknown )
SYS Contact:
(unknown )
SYS Location:
(unknown )
SNMP Community Name(s):  Name      Address      Access
                        (public ) (0.0.0.0 ) <read >
                        (          )
SNMP Trap Destinations ->
Configure SNMP Traps
```

1. Select **SNMP Trap Destination - >** and select [ENTER].

This window defines the SNMP Trap Destinations to which the Router will report alarm information.

**SNMP  
Setup  
Window**

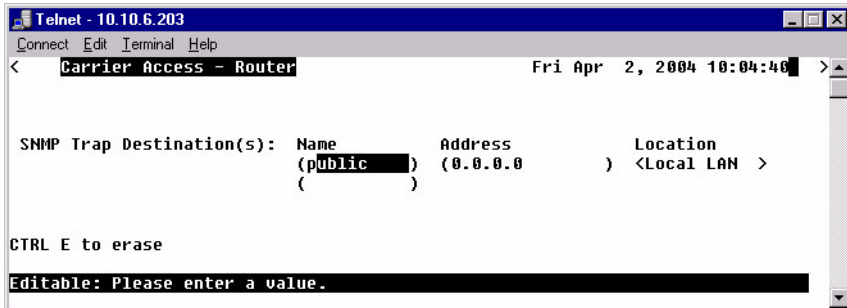

**Name**

Enter the community name(s) of the devices to which the Router will report. The default community name is **public**. To enter a new community name, highlight the field and type the desired value, with a maximum of 10 characters.

**Address**

Enter the corresponding IP Address of the device that was entered in the **Name** field.

**Location**

<Local LAN>, <RemoteUnit>

Available options are the <Local LAN> and all defined Remote (WAN) Units, defined in the Profile Directory (there can be up to 24).

## DNS Proxy

The DNS (Domain Name Server) Proxy specifies the IP address of DNS name servers to be used by the DHCP (Dynamic Host Configuration Protocol) clients.

1. Select **DNS Proxy < Configure ->** and select **[ENTER]**.

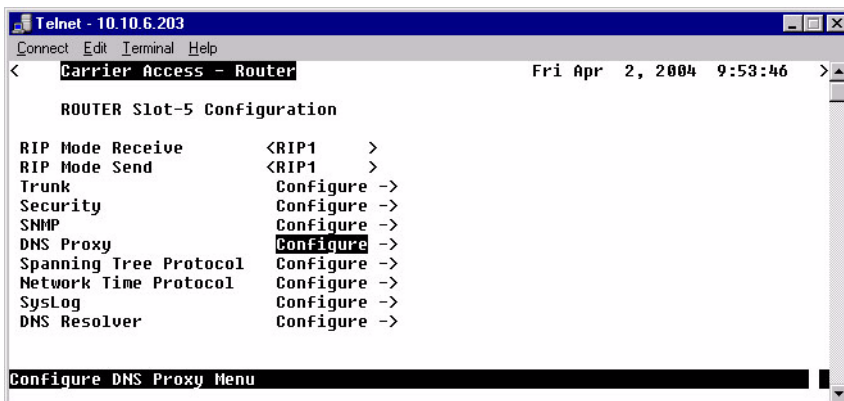

```
Telnet - 10.10.6.203
Connect Edit Terminal Help
< Carrier Access - Router                               Fri Apr 2, 2004 9:53:46 >
ROUTER Slot-5 Configuration
RIP Mode Receive      <RIP1   >
RIP Mode Send         <RIP1   >
Trunk                  Configure ->
Security               Configure ->
SNMP                   Configure ->
DNS Proxy              Configure ->
Spanning Tree Protocol Configure ->
Network Time Protocol Configure ->
SysLog                 Configure ->
DNS Resolver           Configure ->
Configure DNS Proxy Menu
```

2. Type **[CTRL A]** to Add a DNS Proxy.

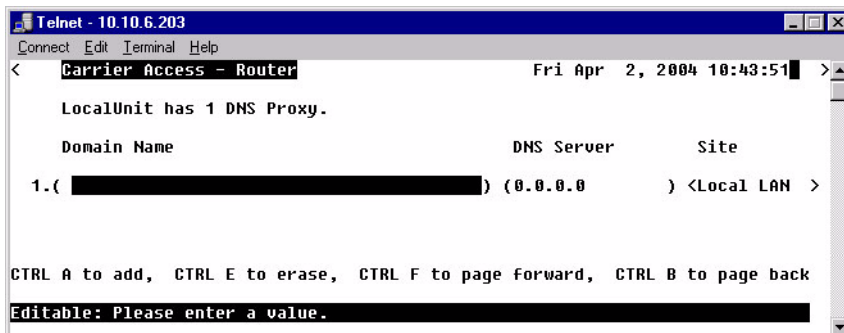

```
Telnet - 10.10.6.203
Connect Edit Terminal Help
< Carrier Access - Router                               Fri Apr 2, 2004 10:43:51 >
LocalUnit has 1 DNS Proxy.
Domain Name          DNS Server          Site
1.( [redacted] ) (0.0.0.0) <Local LAN >
CTRL A to add, CTRL E to erase, CTRL F to page forward, CTRL B to page back
Editable: Please enter a value.
```

3. Enter the appropriate data in the following fields.

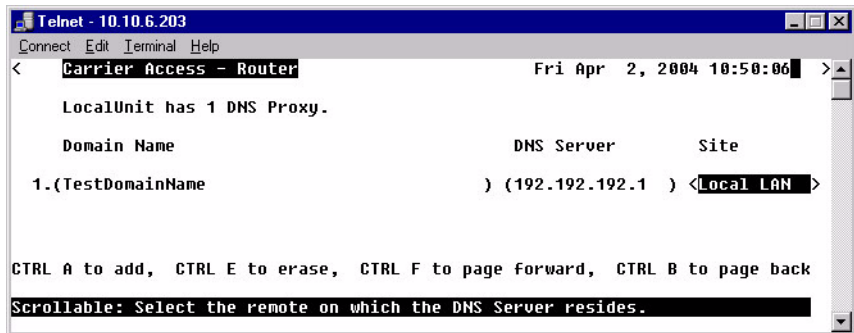

### **Domain Name**

Define a name for the Domain with up to 41 characters.

### **DNS Server**

Enter the IP Address for the DNS Server.

### **Site**

This field lists the Local LAN and all the RemoteUnit that have a profile created for them. Use the [SPACEBAR] to scroll through the list.

4. Select [ESC] and <YES> to exit the window and save changes.

## **Spanning Tree Protocol**

The Spanning Tree Protocol configures the global setup for using the Spanning Tree Algorithm as specified in the IEEE 802.1D specification.

1. Select **Spanning Tree Protocol < Configure ->** and select **[ENTER]**.

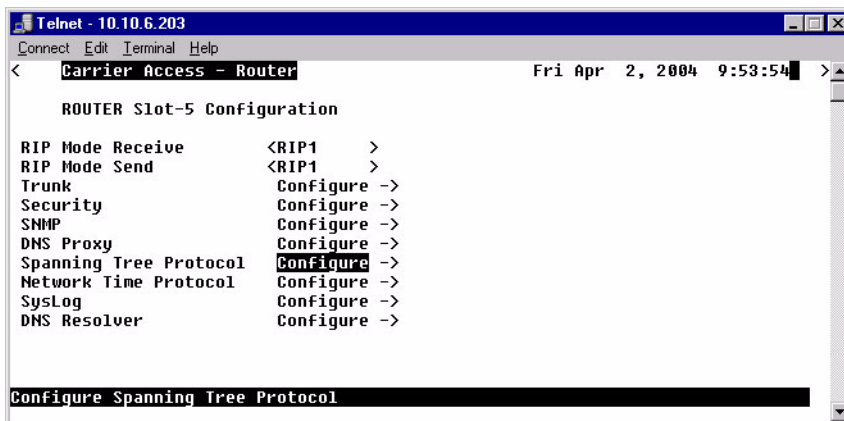

```
Telnet - 10.10.6.203
Connect Edit Terminal Help
< Carrier Access - Router Fri Apr 2, 2004 9:53:54 >
ROUTER Slot-5 Configuration
RIP Mode Receive <RIP1 >
RIP Mode Send <RIP1 >
Trunk Configure ->
Security Configure ->
SNMP Configure ->
DNS Proxy Configure ->
Spanning Tree Protocol Configure ->
Network Time Protocol Configure ->
SysLog Configure ->
DNS Resolver Configure ->
Configure Spanning Tree Protocol
```

2. To enable Spanning Tree, scroll **<Disabled>** to **<Enabled>**, with the **[SPACEBAR]**, select **[ENTER]**.

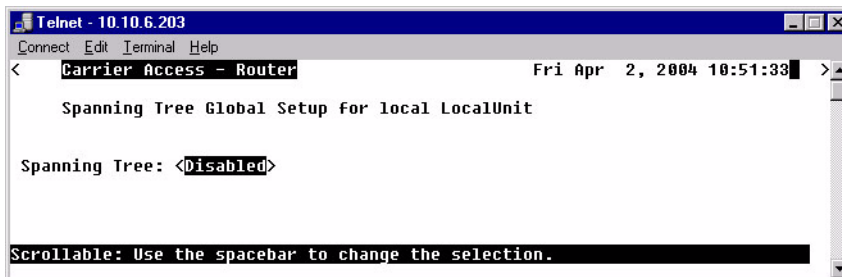

```
Telnet - 10.10.6.203
Connect Edit Terminal Help
< Carrier Access - Router Fri Apr 2, 2004 10:51:38 >
Spanning Tree Global Setup for local LocalUnit
Spanning Tree: <Disabled>
Scrollable: Use the spacebar to change the selection.
```

3. Enter the appropriate data in the following fields.

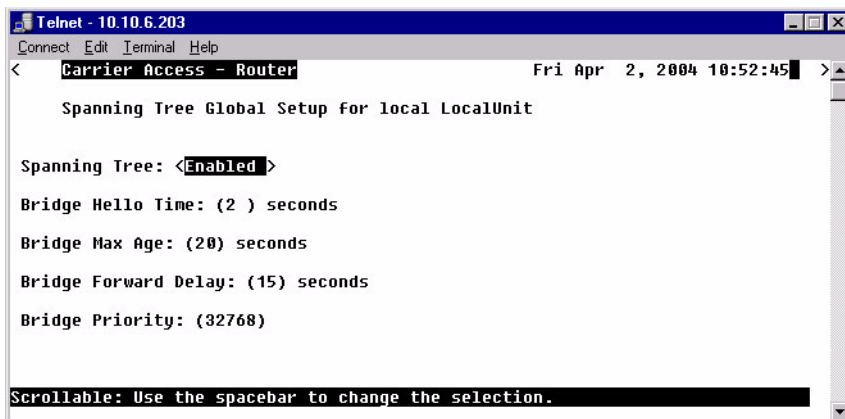

```
Telnet - 10.10.6.203
Connect Edit Terminal Help
< Carrier Access - Router Fri Apr 2, 2004 10:52:45 >
Spanning Tree Global Setup for local LocalUnit

Spanning Tree: <Enabled>
Bridge Hello Time: (2 ) seconds
Bridge Max Age: (20) seconds
Bridge Forward Delay: (15) seconds
Bridge Priority: (32768)

Scrollable: Use the spacebar to change the selection.
```

### **Bridge Hello Time**

The Bridge Hello Time specifies the time interval between transmissions of Topology Change Notification BPDUs towards the Root when the Bridge is attempting to notify the Designated Bridge on the LAN to which its Root Port is attached of a topology change. The value can range from 1 to 10 seconds, with a default of 2 seconds.

### **Bridge Max Age**

The Bridge Max Age value specifies the maximum age of received protocol information before it is discarded. The value can range from 6 to 40 seconds, with a default of 20 seconds.

### **Bridge Forward Delay**

The Bridge Forward Delay is the time spent by a Port in the Listening or Learning States before transitioning to the Learning or Forwarding State, respectively. The value can range from 4 to 30 seconds, with a default of 15 seconds.

### **Bridge Priority**

The Bridge Priority is the priority part of the bridge identifier. The value can range from 0 to 65535, with a default of 32768.

## **Network Time Protocol**

The Network Time Protocol is a protocol which sets the network to a common time system for Internet hosts, based off of GMT (Greenwich Mean Time).

1. Select **Network Time Protocol < Configure ->** and select [**ENTER**].

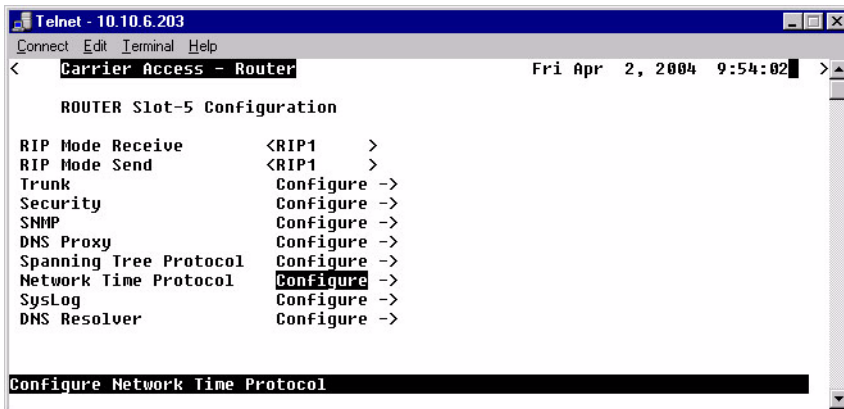

```
Telnet - 10.10.6.203
Connect Edit Terminal Help
< Carrier Access - Router                               Fri Apr 2, 2004 9:54:02 >
ROUTER Slot-5 Configuration
RIP Mode Receive      <RIP1  >
RIP Mode Send         <RIP1  >
Trunk                  Configure ->
Security               Configure ->
SNMP                   Configure ->
DNS Proxy              Configure ->
Spanning Tree Protocol Configure ->
Network Time Protocol Configure ->
SysLog                 Configure ->
DNS Resolver           Configure ->

Configure Network Time Protocol
```

2. To enable Network Time Protocol, scroll **<Disabled>** to **<Enabled>**, with the [**SPACEBAR**], select [**ENTER**].

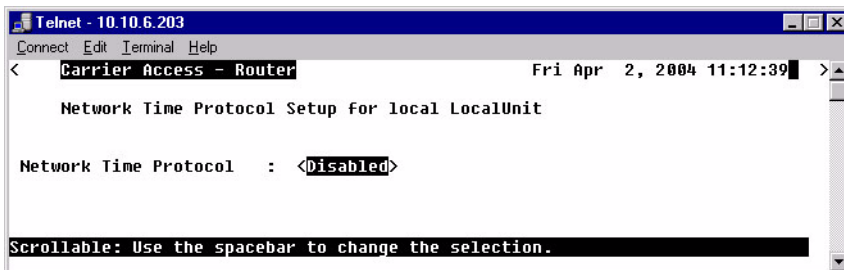

```
Telnet - 10.10.6.203
Connect Edit Terminal Help
< Carrier Access - Router                               Fri Apr 2, 2004 11:12:39 >
Network Time Protocol Setup for local LocalUnit

Network Time Protocol : <Disabled>

Scrollable: Use the spacebar to change the selection.
```



3. Enter the appropriate data in the following fields.

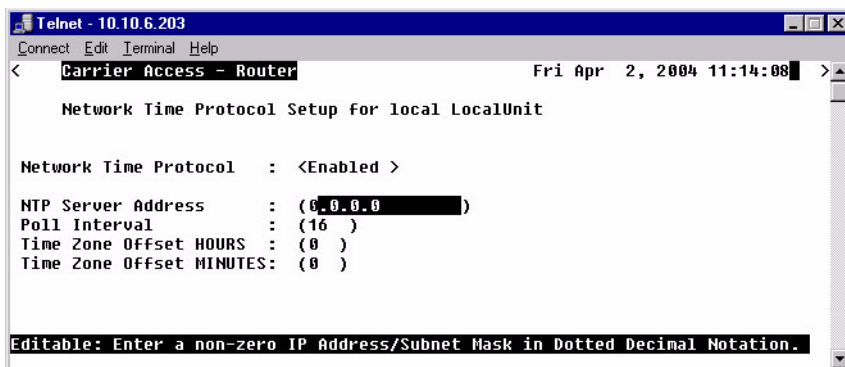

```
Telnet - 10.10.6.203
Connect Edit Terminal Help
< Carrier Access - Router          Fri Apr  2, 2004 11:14:08
Network Time Protocol Setup for local LocalUnit

Network Time Protocol   : <Enabled >
NTP Server Address      : (0.0.0.0)
Poll Interval           : (16 )
Time Zone Offset HOURS  : (0 )
Time Zone Offset MINUTES: (0 )

Editable: Enter a non-zero IP Address/Subnet Mask in Dotted Decimal Notation.
```

### **Network Time Protocol**

**<Disabled>** to disable Network Processing.

**<Enabled>** to enable Network Processing. The following items appear once enabled.

### **NTP Server Address**

The NTP Server Address specifies the IP address of the NTP server. Setting the NTP server value to 0.0.0.0 will cause the router to listen to and process NTP broadcasts.

### **Poll Interval**

The Poll Interval specifies the polling of the NTP server to a defined number of seconds. The range (in seconds) is from 16 to 1024 seconds, with a default of 16.

### **Time Zone Offset HOURS**

The hours Time Zone Offset is used to calculate gateway time from GMT (Greenwich Mean Time). Range is -12 to 12.

### **Time Zone Offset MINUTES**

The minutes Time Zone Offset is used to calculate gateway time from GMT (Greenwich Mean Time). Range is 0 to 60.

## SysLog

The Syslog client capability enables or disables sending alarm and event messages to an external Syslog server from the Router.

1. Select **SysLog Configure** -> and select [ENTER].

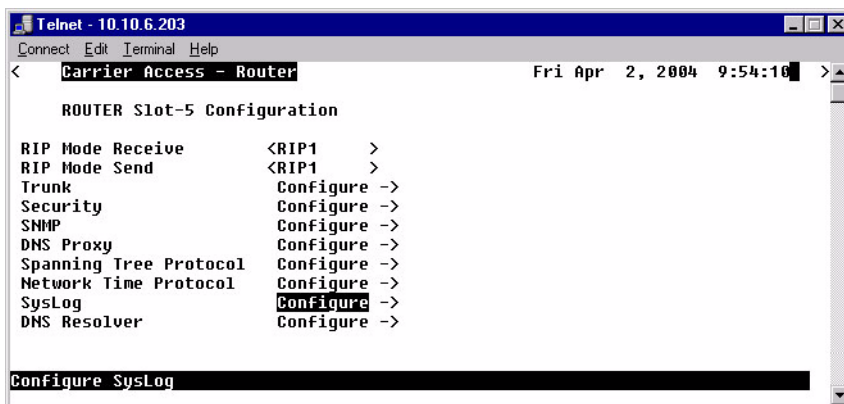

```
Telnet - 10.10.6.203
Connect Edit Terminal Help
< Carrier Access - Router                               Fri Apr 2, 2004 9:54:10 >

ROUTER Slot-5 Configuration

RIP Mode Receive      <RIP1   >
RIP Mode Send         <RIP1   >
Trunk                  Configure ->
Security               Configure ->
SNMP                   Configure ->
DNS Proxy              Configure ->
Spanning Tree Protocol Configure ->
Network Time Protocol Configure ->
SysLog                 Configure ->
DNS Resolver           Configure ->

Configure SysLog
```

2. To enable **SysLog** (System Log Message Service), scroll <Disabled> to <Enable>, with the [SPACEBAR], select [ENTER].

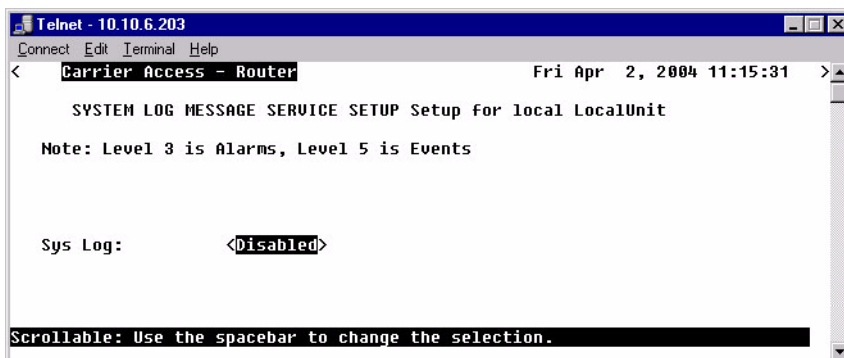

```
Telnet - 10.10.6.203
Connect Edit Terminal Help
< Carrier Access - Router                               Fri Apr 2, 2004 11:15:31 >

SYSTEM LOG MESSAGE SERVICE SETUP Setup for local LocalUnit

Note: Level 3 is Alarms, Level 5 is Events

Sys Log:          <Disabled>

Scrollable: Use the spacebar to change the selection.
```

3. Enter the appropriate data in the following fields.

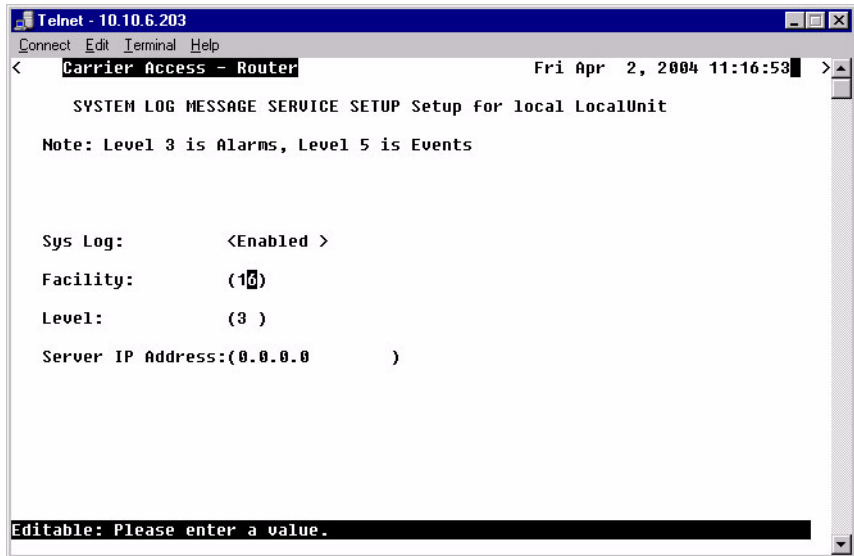

### **SysLog**

To enable the SysLog, use the [SPACEBAR] to scroll <Disabled> to <Enabled> and select [TAB] or [ENTER]. The window will now display the optional settings for Sys Log.

### **Facility**

The value can range from 0 to 23, with a default of 16.

### **Level**

The value can range from 0 to 7, with a default of 3. Level 3 is Alarms and level 5 is Events.

### **Server IP Address**

The server IP Address is a unique, dotted decimal notation entry that is used for data routing purposes. This IP address of the SysLog Server or the Host that has the SysLog Server software running.

## DNS Resolver

The DNS Resolver enables the use of the Domain Name Service (DNS) resolver to convert domain names to IP addresses.

1. Select **DNS Resolver Configure ->** and select [ENTER].

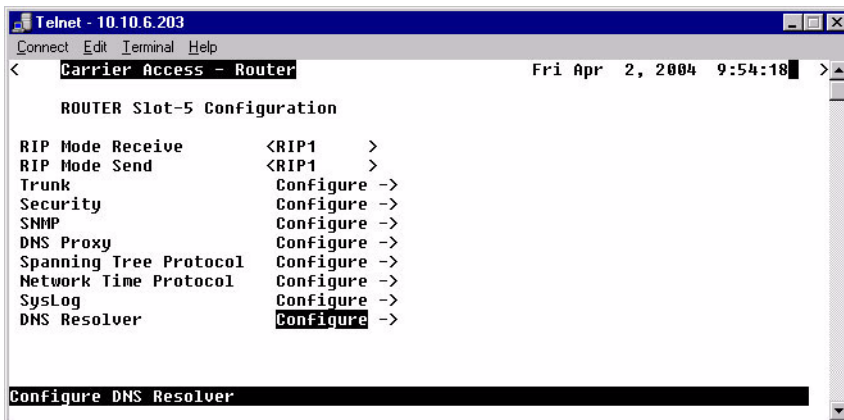

```
Telnet - 10.10.6.203
Connect Edit Terminal Help
< Carrier Access - Router Fri Apr 2, 2004 9:54:18 >
ROUTER Slot-5 Configuration
RIP Mode Receive <RIP1 >
RIP Mode Send <RIP1 >
Trunk Configure ->
Security Configure ->
SNMP Configure ->
DNS Proxy Configure ->
Spanning Tree Protocol Configure ->
Network Time Protocol Configure ->
SysLog Configure ->
DNS Resolver Configure ->
Configure DNS Resolver
```

2. To enable DNS Resolver, scroll <Disabled> to <Enable>, with the [SPACEBAR], select [ENTER].

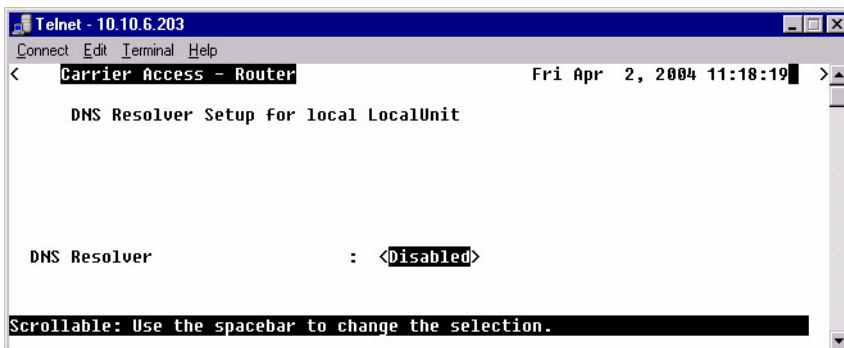

```
Telnet - 10.10.6.203
Connect Edit Terminal Help
< Carrier Access - Router Fri Apr 2, 2004 11:18:19 >
DNS Resolver Setup for local LocalUnit
DNS Resolver : <Disabled>
Scrollable: Use the spacebar to change the selection.
```

3. Enter the appropriate data in the following fields.

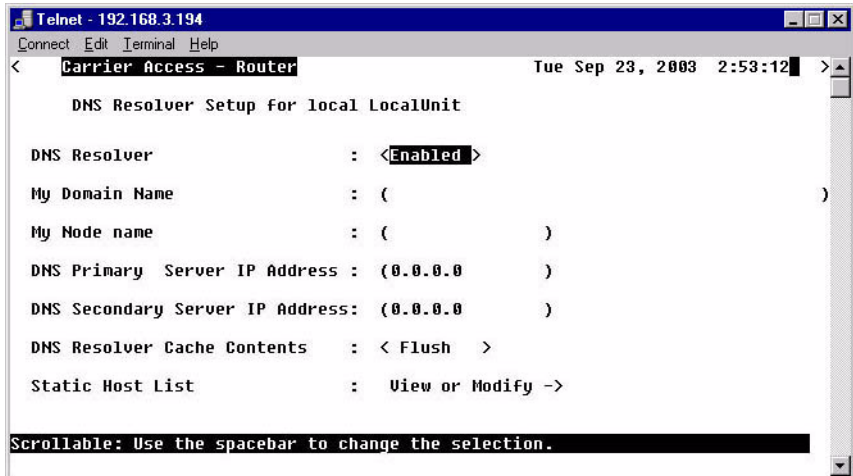

## ***DNS Resolver Setup Menu Fields***

### **DNS Resolver**

Disable/Enable use of DNS resolver to convert domain names to IP addresses.

### **My Domain Name**

Set the default domain that the DNS resolver will add to any name queries that are not fully qualified. Identifier of up to 43 characters.

### **My Node Name**

Set the CMG card's host name. Identifier of up to 15 characters.

### **DNS Primary Server IP Address**

Configure IP address of DNS server #1.

### **DNS Secondary Server IP Address**

Configure IP address of DNS server #2.

### **DNS Resolver Cache Contents**

<Flush> - will clear the cache contents

<Display> - will display the cache contents

## Profile Directory: Router Card Profile

### DNS Resolver

---

#### Static Host List: View or Modify - >

Select the **Static Host List: View or Modify - >** and press **[ENTER]**. If any changes were made the system will prompt you to save changes before leaving this window. Scroll the <No> to <Yes> to save.

Note: The following fields must be entered before the Static Host List window can be opened: My Domain Name, My Node Name and 1 DNS IP Address.

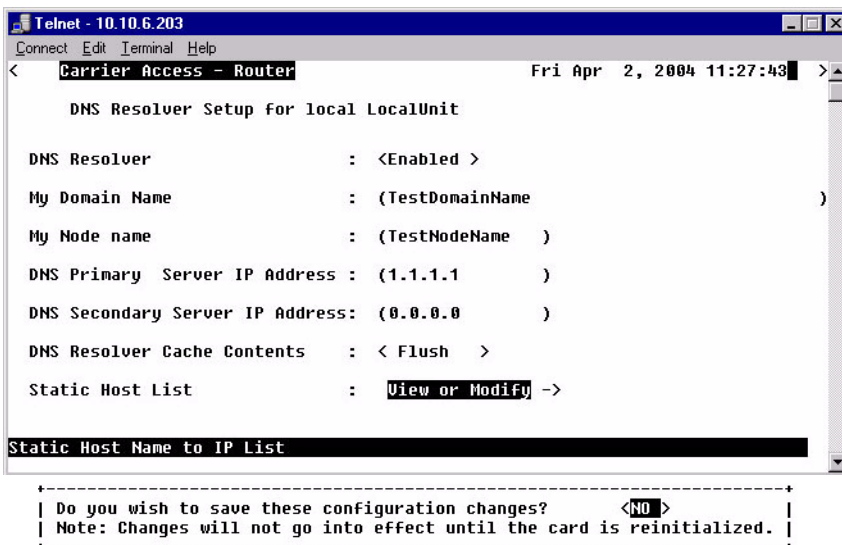

```
Telnet - 10.10.6.203
Connect Edit Terminal Help
< Carrier Access - Router Fri Apr 2, 2004 11:27:43 >
DNS Resolver Setup for local LocalUnit

DNS Resolver           : <Enabled >
My Domain Name         : (TestDomainName )
My Node name           : (TestNodeName )
DNS Primary Server IP Address : (1.1.1.1 )
DNS Secondary Server IP Address: (0.0.0.0 )
DNS Resolver Cache Contents : < Flush >
Static Host List       : View or Modify ->

Static Host Name to IP List

-----
| Do you wish to save these configuration changes?  <NO > |
| Note: Changes will not go into effect until the card is reinitialized. |
|-----
```

4. After the configuration is saved, the DNS Static Host window displays and a Static Host can be added or modified.

5. If any changes are made they must be saved when exiting the window.

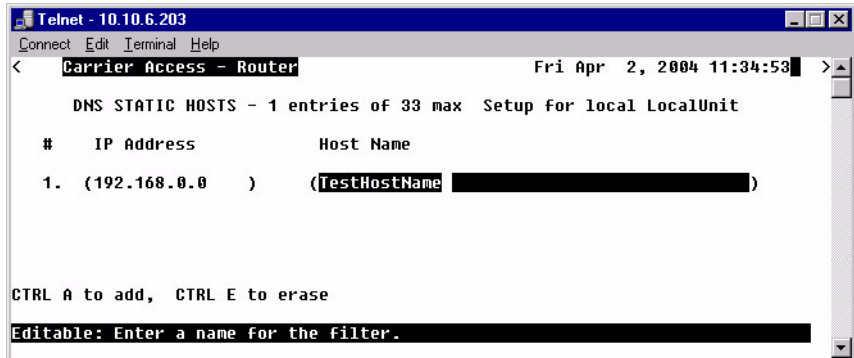

```
Telnet - 10.10.6.203
Connect Edit Terminal Help
Carrier Access - Router          Fri Apr 2, 2004 11:34:53
DNS STATIC HOSTS - 1 entries of 33 max Setup for local LocalUnit
#      IP Address      Host Name
1.    (192.168.0.0    ) (TestHostName )
CTRL A to add, CTRL E to erase
Editable: Enter a name for the filter.
```

### #

Number of Static Hosts set up. A maximum of 33 can be entered.

### IP Address

IP address of the static host.

### Host Name

Enter the filter name, with a maximum of 42 characters, no spaces or numbers.

## ***Profile Directory: Router Card Profile***

*DNS Resolver*

---



# CHAPTER 4

---

## ***Profile Directory: Local Profile***

### **In this Chapter**

- LAN (Local) Profile Setup
- Static Networks
- Static Addresses
- Filters
- Advertise Network/Server
- DHCP Server/BOOTP Relay
- LAN Collision Threshold
- Spanning Tree
- Secondary IP Address
- Link Speed

## Profile Directory: Local Profile

---

The Local (LAN) Profile Setup is found in **Configuration <Profile Directory>/LocalUnit LAN <Setup ->**.

### Main Menu

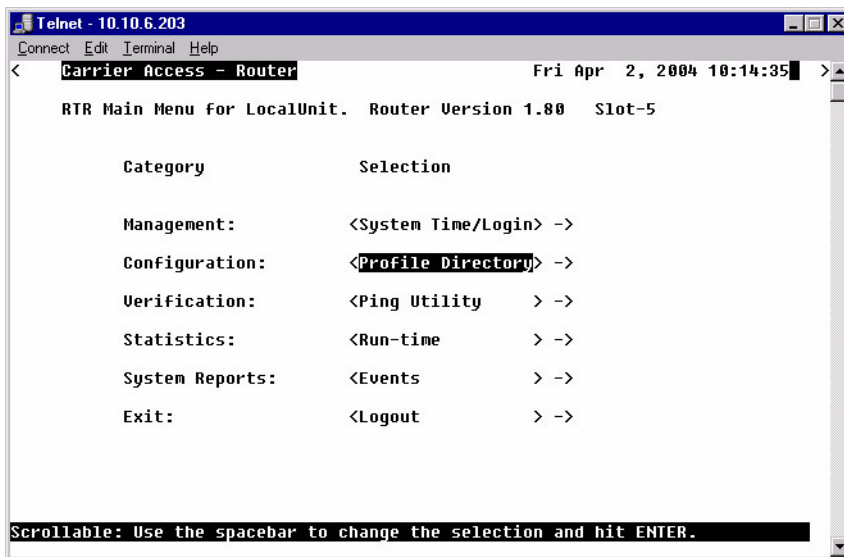

```
Telnet - 10.10.6.203
Connect Edit Terminal Help
< Carrier Access - Router Fri Apr 2, 2004 10:14:35 >
RTR Main Menu for LocalUnit. Router Version 1.80 Slot-5

Category          Selection
Management:      <System Time/Login> ->
Configuration:    <Profile Directory> ->
Verification:    <Ping Utility> > ->
Statistics:       <Run-time> > ->
System Reports:  <Events> > ->
Exit:            <Logout> > ->

Scrollable: Use the spacebar to change the selection and hit ENTER.
```

### Profile Directory window

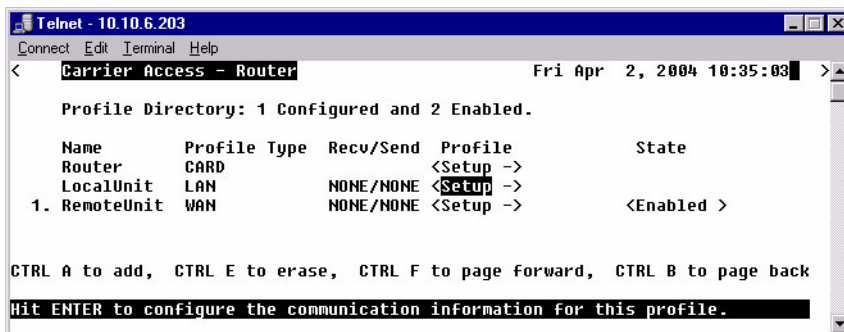

```
Telnet - 10.10.6.203
Connect Edit Terminal Help
< Carrier Access - Router Fri Apr 2, 2004 10:35:03 >
Profile Directory: 1 Configured and 2 Enabled.

Name      Profile Type  Recv/Send  Profile      State
Router    CARD          NONE/NONE  <Setup ->
LocalUnit LAN        NONE/NONE  <Setup ->
1. RemoteUnit WAN    NONE/NONE  <Setup -> <Enabled >

CTRL A to add, CTRL E to erase, CTRL F to page forward, CTRL B to page back
Hit ENTER to configure the communication information for this profile.
```

**Local  
Profile  
window**

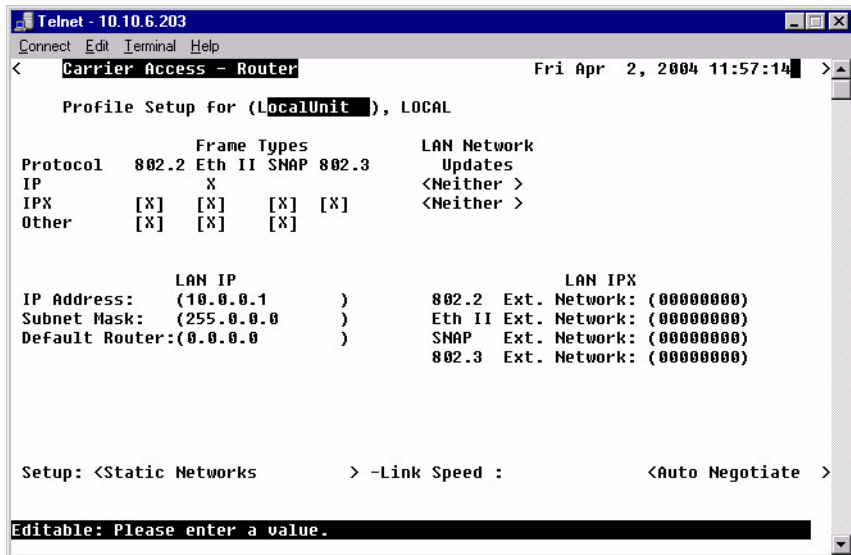

```
Telnet - 10.10.6.203
Connect Edit Terminal Help
< Carrier Access - Router Fri Apr 2, 2004 11:57:14 >

Profile Setup for (LocalUnit), LOCAL

          Frame Types
Protocol  802.2 Eth II SNAP 802.3   LAN Network
IP        X                               <Neither >
IPX      [X] [X] [X] [X]             <Neither >
Other    [X] [X] [X]

          LAN IP
IP Address: (10.0.0.1 )      802.2 Ext. Network: (00000000)
Subnet Mask: (255.0.0.0 )   Eth II Ext. Network: (00000000)
Default Router:(0.0.0.0 )   SNAP Ext. Network: (00000000)
                               802.3 Ext. Network: (00000000)

Setup: <Static Networks > -Link Speed : <Auto Negotiate >

Editable: Please enter a value.
```

## ***LAN (Local) Profile Setup***

The LAN Profile is the largest, most detailed portion of the Router software. The fields on this screen allow definition of how data transmission will occur on the Router LAN port. This includes defining the protocol(s) that it will use to send and receive data, defining security protocols, specifying which LAN servers and networks will be advertised to WAN units, and establishing specific data filtering options.

The LAN profile is used in conjunction with the WAN profiles. The WAN profiles identify which remote units the local unit can communicate with, as well as the data transmission requirements of each remote.

## ***Profile Directory: Local Profile***

### *LAN (Local) Profile Setup*

---

In addition to the fields on this screen, there are several other areas that directly relate to the communication abilities of the Router. You may use the fields at the bottom of this screen to access the following areas:

- Defining static addresses at the local unit
- Establishing static networks
- Establishing Remote (WAN) advertising
- Establishing DHCP Server/BOOTP Relay Agent parameters
- Defining data filters

The Router can accommodate a maximum of 500 filters, such as those created when establishing static routes or data filters. The following entries consume a filter:

- Configured address, custom and protocol filters
- Static IP networks and static IPX networks
- Enabling any learned items listed on the Advertise Network/Server screen or Filter Network/Server screen
- Static IP and MAC Addresses
- Firewall filters

In a large network, it is necessary to selectively use of each of these options so that the number of configured filters is within the maximum allowed.

The Local Profile is used to define the Local (LAN) port parameters for the unit at the present location.

## To Setup a Local Profile:

1. Select **Configuration: <Profile Directory>** from the **Main Menu**, and press **[ENTER]**.

**Local Profile window**

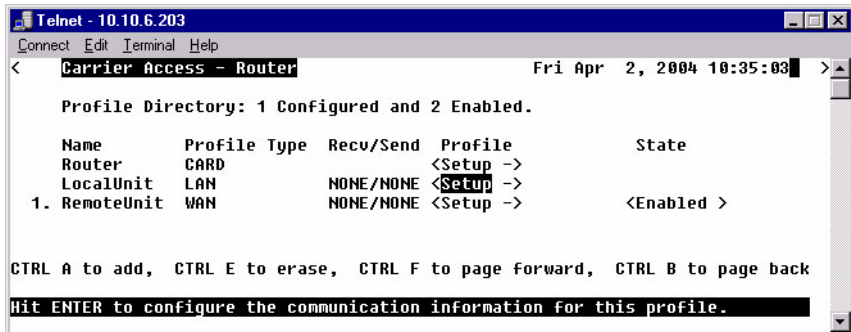

2. Select **LAN <Setup ->** and press **[ENTER]**.

**LAN Profile window**

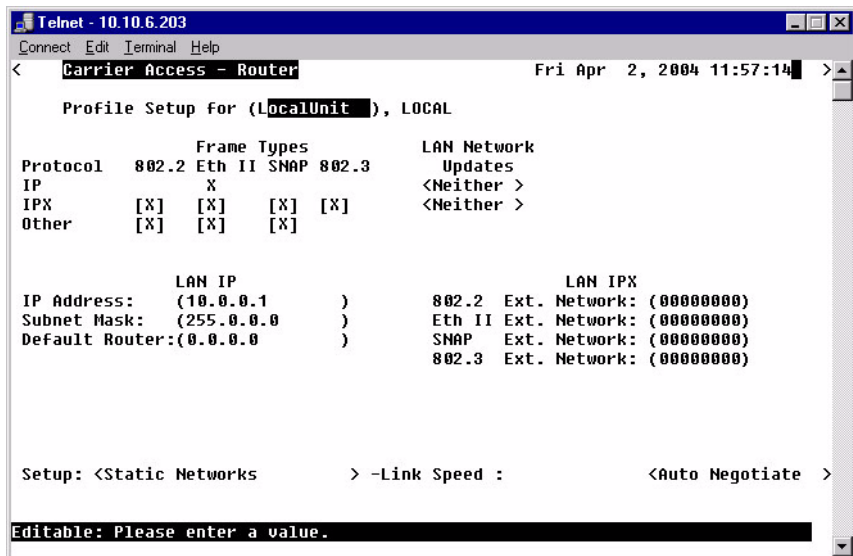

## **Local Profile Setup Menu Fields**

### **Profile Setup for (LocalUnit)**

The (LocalUnit) is the default name for this unit and will be used during the authentication process to ensure this unit's identity. This name can easily be changed by simply typing over the "LocalUnit" and saving when closing this window. This name can be up to 11 characters.

### **Protocol**

This column includes three protocol options, IP, IPX and Other. These protocols are used to define **Frame Types and LAN Network Updates** to be used by this IP Router.

### **Frame Types**

Define the frame type of the packets that are sent and received by the IP Router. If a packet is received formatted in a frame type that has not been enabled, the IP Router will not accept the data.

Note that multiple frame types may be supported simultaneously for IPX and Other protocols.

#### **802.2**

When selected (X) this IP router may send and receive packets that match the 802.2 format. The 802.2 format complies with IEEE specifications.

#### **Eth II**

When selected (X) this IP Router may send and receive packets that match the Ethernet II format. Note that the IP protocol commonly uses this format.

#### **SNAP**

When selected (X) this IP Router may send and receive packets that match the SNAP (Subnet Network Address Protocol) format.

#### **802.3**

When selected (X) this IP Router may send and receive packets that match Novell's X802.3 format.

### **LAN Network Updates**

Use the **LAN Network Updates** field to determine whether the Local (LAN) unit will learn, via **RIP** and **SAP** packets, which networks and services are attached to the local LAN, and whether Remote (WAN) networks and services will be advertised to the LAN. If this information is learned, it may be advertised to remote devices if advertising is established. Use the [SPACEBAR] to select from the following options: <Both>, <Neither>, <Send> and <Receive>.

When set to **<Both>**, the local Unit will accept the RIPs and SAPs from the LAN and the networks and services learned from the WAN will be broadcast to the LAN.

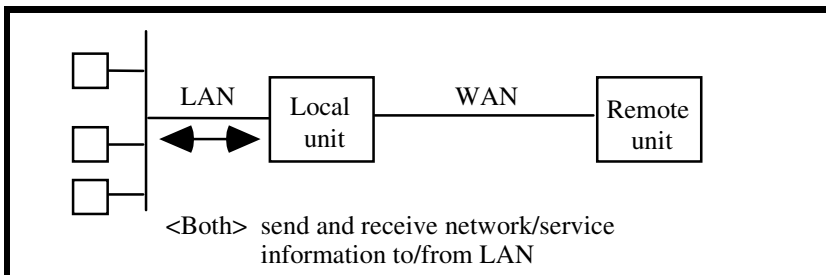

The **<Send>** value will enable the local Unit to send to the LAN information regarding the networks and services that it has learned from remote devices on the WAN. However, the unit will not accept RIPs and SAPs from the LAN.

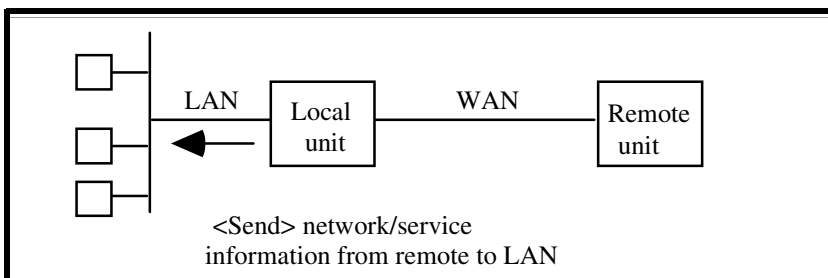

When this field value is set to **<Receive>**, the local Unit will monitor the RIPs and SAPs on the LAN, learn the available networks and services and then pass this information on to the appropriate remote units on the WAN. Network information from the WAN, however, will not be broadcast to the LAN.

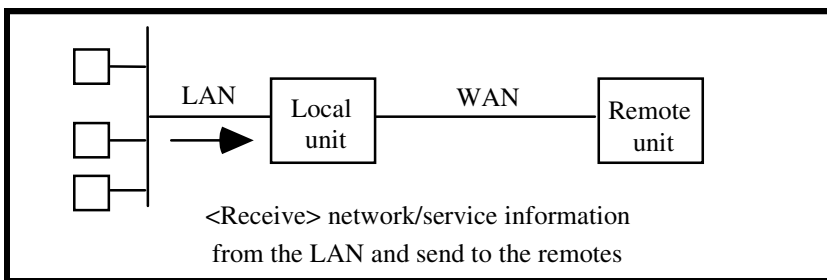

The **<Neither>** value will not allow the local Unit to send or receive information regarding networks and services on the LAN.

## **Profile Directory: Local Profile**

### **LAN (Local) Profile Setup**

---

## **LAN IP:**

### **IP Address**

This is the IP Address of this IP Router, used to uniquely identify the device on the internetwork. The default for this IP Address is 10.0.0.1

### **Subnet Mask**

A subnet mask determines which bits in the IP address are used to identify the network number. The default for the Subnet Mask is 255.0.0.0.

### **Default Router**

This is an optional entry depending on your network configuration. Use this field to identify a router that is physically connected to your LAN. If the IP Router receives a packet which contains a network that is not known, the packet will be sent to the router identified in this field.

If there are other routers and networks behind the **Default Router add Static Network IP information with the Default Router as the Default Gateway.**

If you are communicating with different network domains, you will need to enter the IP Address of your Router as the default router on each workstation or make sure that the local router will redirect to the Router when appropriate, so that they may use the Router to reach the remote site.

## **LAN IPX:**

These fields enable the Router to route IPX to Remote (WAN) networks, even if an IPX server does not exist on the local LAN. Typically, the Router will learn its external network number. However, if the local LAN does not have a server or if the **LAN NETWORK UPDATES** field (see above) is set to **<Neither>**, and you wish to route IPX to Remote (WAN) networks, the external network number must be defined using these fields.

If you are not using IPX on your LAN, these fields will not apply. Please note that these are all hexadecimal entries. For the following see you network administrator for the appropriate numbers. If the frame type is unsupported leave the field set to 0s.

### **802.2 Ext. Network**

Enter the corresponding IPX external network number.

### **Ethernet II Ext. Network**

Enter the corresponding IPX external network number.

### **SNAP**

Enter the corresponding IPX external network number.

### **802.3 Ext. Network**

Enter the corresponding IPX external network number.



## **Setup < >**

The **Setup** field accesses additional setup screens for the Local (LAN) profile. The screen that is accessed depends on the chosen option. Listed below are the available field options:

### **<Static Networks >**

Used to configure static network routes that can be reached locally. See *Static Networks on page 4-10*, for more information.

### **<Static Addresses >**

Configure static addresses for the local devices. See *Static Addresses on page 4-16*, for more information.

### **<Filters >**

Define data filters for this Router. See *Filters on page 4-19*, for more information.

### **<Advertise Networks/Server >**

Enables the unit to advertise all networks and services to all remote units, or to advertise to no remotes. See *Advertise Network/Server on page 4-25*, for more information.

### **<DHCP Server/BOOTP Relay >**

Establish the Router as a DHCP Server or BOOTP Relay Agent. See *DHCP Server/BOOTP Relay on page 4-30*, for more information.

### **<LAN Collision Threshold >**

Adjust the threshold at which excessive LAN collisions trigger an alarm. See *LAN Collision Threshold on page 4-34*, for more information.

### **<Spanning Tree>**

Configures the global setup for using the Spanning Tree Algorithm as specified in the IEEE 802.1D specification. See *Spanning Tree on page 4-37*, for more information.

### **<Secondary IP Address >**

Add a secondary IP address and subnet to the specified LAN interface. See *Secondary IP Address on page 4-40*, for more information.

## **Link Speed**

Sets the Ethernet PHY mode and speed for the Router.

Note: it is highly recommended that this setting be left at auto-negotiation. Connection of Ethernet devices with incompatible settings can lead to severe performance degradation and errors on a network. See *Link Speed on page 4-42*, for more information.

## Static Networks

Static networks allow fixed, or pre-determined routes, which increases the control over routing choices within your network. Although the Router is able to dynamically learn routing information through RIP packets, you may wish to disable this feature and manually enter fixed routes. (Disable Learning by choosing the **<Neither>** option in the LAN Network Updates field on the Local (LAN) Profile Setup screen.) Static routing may be preferred if:

- Routers within a network are not configured to advertise, thereby escaping the automatic learning capabilities of the Router
- Advertising is disabled so that access to certain networks may be restricted for security purposes or, to decrease traffic on the LAN and across the WAN
- You wish to keep routing tables small in order to increase LAN/WAN performance

Static routing may also be preferable when managing large networks. Often times it is easier to disable the learning mode and manually enter routes, rather than review each routing table entry and determine its advertising status.

As a static routing example, let's assume that we have three networks, A, B and C. Network B, is connected to Network C via a router, and to Network A via a remote Unit. Network B may not learn of Network A's existence if advertising was disabled on Router 1. Therefore, if you wish to establish an entry in the routing table indicating a route between Network B and Network C, you can define a static route on Network B.

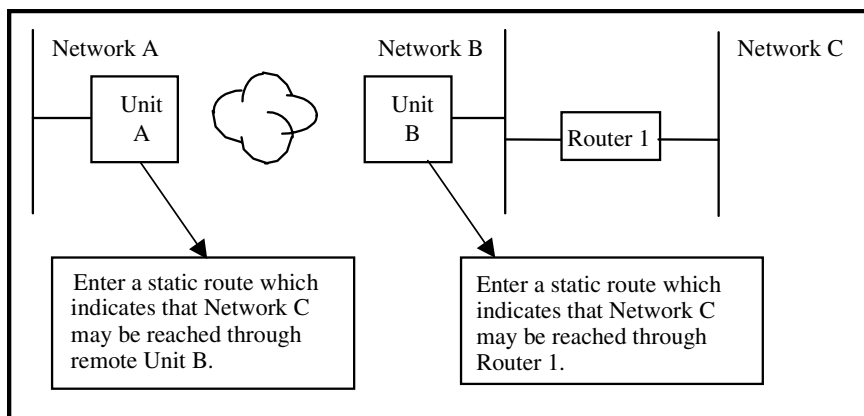

To continue with this example, if Network B is not configured to advertise Network C to Network A, then Network A will not dynamically learn of Network C's existence. If you wish to establish a route on Network A to Network C, you must define a static route on Network A that indicates that Network C may be accessed through remote Adit B.

To set up a static route, you must define the following routing information:

- The address of the network you wish to reach;
- How far away from the local LAN the network is located (in terms of metric measurement or hops, depending on the protocol)
- Whether the network can be reached on the local LAN (via the LAN port) or through a remote unit.

If you are using the local LAN, you will also need to define the address (either IP or MAC, depending on the protocol) of the first gateway (i.e. Adit or router) you will use to reach the network you are defining.

It is important to note that if the static network is reached via a remote unit, it must be defined by choosing the **SETUP <Static Networks>** option on the corresponding Remote (WAN) Profile Setup screen. Static networks that are reached via the local LAN must be defined by choosing the **SETUP <Static Networks>** option on the Local (LAN) Profile Setup screen.

---

**NOTE:** All static routes are considered filters and will be applied toward the maximum allowable number of 500 filters.

---

**IP Networks** - An Internet Protocol Network.

**IPX Networks** - Internet Packet Exchange Network. A Novell NetWare's native LAN communications protocol.

## Profile Directory: Local Profile

### Static Networks

---

## To Setup Static Networks

1. Select **Configuration <Profile Directory>** from the **Main menu**, and press **[ENTER]**.
2. Select **LAN <Setup ->** and press **[ENTER]**.

### Profile Directory window

```
Telnet - 10.10.6.203
Connect Edit Terminal Help
< Carrier Access - Router                               Fri Apr 2, 2004 10:35:03 >
Profile Directory: 1 Configured and 2 Enabled.

Name      Profile Type  Recv/Send  Profile      State
Router    CARD          <Setup ->
LocalUnit LAN          NONE/NONE  <Setup ->
1. RemoteUnit WAN      NONE/NONE  <Setup ->    <Enabled >

CTRL A to add, CTRL E to erase, CTRL F to page forward, CTRL B to page back
Hit ENTER to configure the communication information for this profile.
```

3. Select **Setup: <Static Networks >**. If the Secondary IP Address option is not displayed scroll to the selection with the [SPACEBAR], and press [ENTER].

Local  
Profile  
Window



```
Telnet - 10.10.6.203
Connect Edit Terminal Help
Carrier Access - Router          Fri Apr  2, 2004 12:00:21
Profile Setup for (LocalUnit ), LOCAL

Protocol  802.2 Eth II SNAP 802.3      LAN Network
IP         X                               Updates
IPX        [X] [X] [X] [X]             <Neither >
Other      [X] [X] [X]                 <Neither >

LAN IP
IP Address: (10.0.0.1 )
Subnet Mask: (255.0.0.0 )
Default Router:(0.0.0.0 )

LAN IPX
802.2 Ext. Network: (00000000)
Eth II Ext. Network: (00000000)
SNAP Ext. Network: (00000000)
802.3 Ext. Network: (00000000)

Setup: <Static Networks > -Link Speed : <Auto Negotiate >

Scrollable: Select the item to be set up and hit ENTER.
```

4. Select <IP Networks> or <Static IPX Networks>.

Static  
Networks  
Setup (IP)

```
Telnet - 10.10.6.203
Connect Edit Terminal Help
Carrier Access - Router          Fri Apr  2, 2004 12:01:22
LocalUnit has 1 Static IP Network.
Setup Static: <IP Networks >

Network      Subnet Mask      Metric      Next Gateway
1. (0.0.0.0 ) (0.0.0.0 ) (1 ) (0.0.0.0 )

CTRL A to add, CTRL E to erase, CTRL F to page forward, CTRL B to page back
Editable: Enter a non-zero IP Address/Subnet Mask in Dotted Decimal Notation.
```

## Profile Directory: Local Profile

### Static Networks

---

5. Press [CTRL A] to add a Static Network.

#### Static Networks Setup (IPX)

```
Telnet - 10.10.6.203
Connect Edit Terminal Help
< Carrier Access - Router Fri Apr 2, 2004 12:03:39 >
LocalUnit has 1 Static IPX Network.
Setup Static: <IPX Networks>
Network Hops Ticks Next IPX Router
1. (00000000) (1) (1) (00-00-00-00-00-00)
CTRL A to add, CTRL E to erase, CTRL F to page forward, CTRL B to page back
Editable: Please enter a value.
```

## Static Network Menu Fields

### Network

Enter the address of the destination network for the route that you are adding. Static networks reached via a remote Unit must be configured through the corresponding Remote (WAN) Profile Setup screen. Those configured through the Local (LAN) Profile Setup screen can be reached via the local LAN. If this is an IP network, enter the value in dotted decimal notation. If this is an IPX network, enter the appropriate value in hexadecimal notation.

### Subnet Mask

A subnet mask determines which bits in the IP address are used to identify the network number. It is also a method of extending the IP Network Address so that a site may use one network address for several different networks. This is accomplished by reassigning the portion of the IP Network Address that normally identifies a node, to further identify the physical network. This serves to lessen the number of available device numbers, while expanding the available number of physical networks.

### Metric

Enter a numeric value indicating the distance from your local network to the destination network. Originally this measured by the number of gateways between the two networks, the number may be modified, either higher or lower, to indicate a desired priority. To ensure a route is considered primary, the value in this **Metric** field must be less than that of a secondary route. This field is only used on IP networks. Valid entries range from 1 to 15. (Please note that a value of 1 usually indicates a direct network.)

## **Hops**

See **Metric**, above. When defining the number of hops in a given route, remember to increment the actual number by 1, since your locally attached unit is counted as "1". This field is only used on IPX networks. Valid entries range from 1 to 15.

## **Ticks**

Indicates the distance between two networks as measured in time increments (1/18th of a second). Only IPX Networks use this information. Like hops, ticks may be used to designate primary and secondary routes to the same network. Although both the hops and ticks values are considered when determining routing priority, for Novell networks, the tick value is considered first. To designate routing priority between two routes, manipulate the tick value so that the preferred route is given the lower value. This field value has a range of 1 to 15.

## **Next Gateway**

Enter the IP Address of the first gateway (Adit or router) that the data will use to reach the destination network. Referring back to Example 1, Network B would enter the IP Address of Router 1, since that is the first gateway on the route to Network C. This field is only used on IP Networks.

## **Next IPX Router**

Enter the MAC Address of the next gateway (Adit or router) on the route that the data will use to reach the destination network. Referring back to Example 1, Network B would enter the MAC Address of Router 1, since that is the next gateway on the route to Network C. This field is only used on IPX networks.

## Static Addresses

Use this screen to define static addresses that are based on the Ethernet MAC or IP Address of a specific device on the local LAN. Typically, the Router would learn of these devices by monitoring LAN/WAN packets. By defining a static address, you are telling the Router the location of the corresponding device before the Router learns where this device resides. Static addresses are typically used in a bridging situation.

Use the Local (LAN) Profile to define static addresses for devices that are located on the LAN. If you wish to establish static addresses for devices on remote LAN's, access this screen using the corresponding Remote Profile.

---

**NOTE:** Each static address filter will count toward the maximum number of 500 filters.

---

1. Select **Configuration <Profile Directory>** on the **Main menu**, and press **[ENTER]**.
2. Select **LAN <Setup ->** and press **[ENTER]**.

### Profile Directory Window

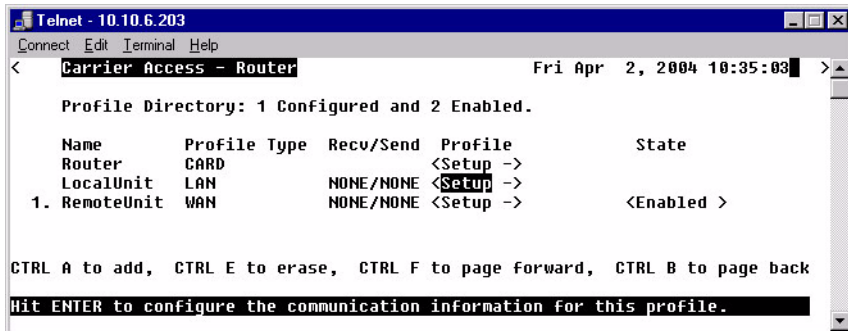

```
Telnet - 10.10.6.203
Connect Edit Terminal Help
< Carrier Access - Router                               Fri Apr 2, 2004 10:35:03 >
Profile Directory: 1 Configured and 2 Enabled.
Name      Profile Type  Recv/Send  Profile      State
Router    CARD          <Setup ->
LocalUnit LAN          NONE/NONE  <Setup ->
1. RemoteUnit WAN      NONE/NONE  <Setup ->
                                     <Enabled >

CTRL A to add, CTRL E to erase, CTRL F to page forward, CTRL B to page back
Hit ENTER to configure the communication information for this profile.
```



3. Select **Setup: <Static Addresses >**. If the Static Addresses option is not displayed scroll to the selection with the [SPACEBAR], and press [ENTER].

Local  
Profile  
Window



```
Telnet - 10.10.6.203
Connect Edit Terminal Help
Carrier Access - Router          Fri Apr 2, 2004 12:05:00
Profile Setup for (LocalUnit ), LOCAL

Protocol  802.2 Eth II SNAP 802.3  LAN Network
IP         X                               <Neither >
IPX       [X] [X] [X] [X]          <Neither >
Other     [X] [X] [X]

LAN IP
IP Address: (10.0.0.1 )
Subnet Mask: (255.0.0.0 )
Default Router:(0.0.0.0 )

LAN IPX
802.2 Ext. Network: (00000000)
Eth II Ext. Network: (00000000)
SNAP Ext. Network: (00000000)
802.3 Ext. Network: (00000000)

Setup: <Static Addresses > -Link Speed : <Auto Negotiate >

Scrollable: Select the item to be set up and hit ENTER.
```

4. Press [CTRL A] to add static addresses, as needed.

Static MAC  
Address  
Setup

```
Telnet - 10.10.6.203
Connect Edit Terminal Help
Carrier Access - Router          Fri Apr 2, 2004 12:07:00
LocalUnit has 1 Static MAC Address Record.

Setup Static: <MAC Address ->

Device Name  MAC Address
1. ( ) (00-00-00-00-00-00)

CTRL A to add, CTRL E to erase, CTRL F to page forward, CTRL B to page back
Editable: Enter a name for the filter.
```

#### Static IP Address Setup

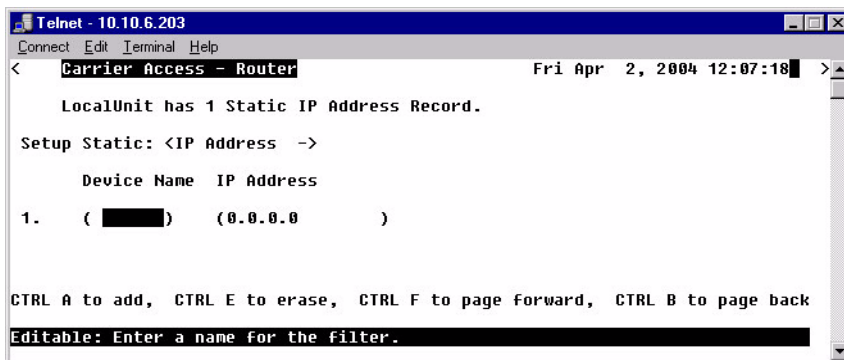

## Static IP Address Menu Fields

### Setup Static

Use the [SPACEBAR] to scroll between <IP Address > and <MAC Address >. The fields on this screen will vary depending on your choice.

#### IP Address

A unique, 32-bit identifier for a specific TCP/IP device on a network. The address is in dotted decimal form, xxx.xxx.xxx.xxx, where xxx = 1-255.

#### MAC Address

The address for a device as it is identified at the Media Access Control layer in the network structure.

#### Device Name

Use this field to identify the user-defined name of the LAN device that is associated with this static address. The maximum number of alphanumeric characters for this field is 7.

#### MAC Address

Enter the MAC Address of the desired device that can be reached via the local LAN. This field is only available if the **Setup Static** field is set to <MAC Address >.

#### IP Address

Enter the IP Address of the desired device. If the static address is configured through the Local (LAN) Profile Setup screen, the device can be reached via the local LAN. This field is only available if the **Setup Static** field is set to <IP Address>.

## Filters

Use this screen to review currently enabled data filters or to enable new filters. Data filters are used to determine whether data can be sent or received on the LAN/WAN based on a specific device, protocol type or defined data string. Data filters must be defined using the Custom, Protocol and Address Filter screens prior to being enabled on the current screen. *Filters will not be in effect until they are added to this screen.* Once enabled, they will adhere to the value set in the **Forward Mode** field.

1. Select **Configuration <Profile Directory>** on the **Main menu**, and press **[ENTER]**.
2. Select **LAN <Setup ->** and press **[ENTER]**.

### Profile Directory Window

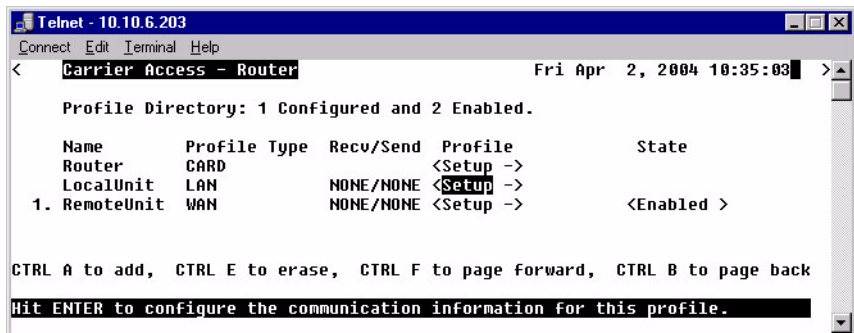

```
Telnet - 10.10.6.203
Connect Edit Terminal Help
< Carrier Access - Router                               Fri Apr  2, 2004 10:35:03 >
Profile Directory: 1 Configured and 2 Enabled.

Name      Profile Type  Recv/Send  Profile      State
Router    CARD          <Setup ->
LocalUnit LAN          NONE/NONE <Setup ->
1. RemoteUnit WAN      NONE/NONE <Setup -> <Enabled >

CTRL A to add, CTRL E to erase, CTRL F to page forward, CTRL B to page back
Hit ENTER to configure the communication information for this profile.
```

**NOTE:** Each Custom filter, even if it is not enabled, will count toward the maximum number of 500 filters.

## Profile Directory: Local Profile

### Filters

3. Select **Setup: <Filters >**. If the Filters option is not displayed scroll to the selection with the [SPACEBAR], and press [ENTER].

Local  
Profile  
Window

```
Telnet - 10.10.6.203
Connect Edit Terminal Help
< Carrier Access - Router Fri Apr 2, 2004 12:09:32 >
Profile Setup for (LocalUnit ), LOCAL

Protocol 802.2 Eth II SNAP 802.3 LAN Network
IP X Updates
IPX [X] [X] [X] [X] <Neither >
Other [X] [X] [X] <Neither >

LAN IP LAN IPX
IP Address: (10.0.0.1 ) 802.2 Ext. Network: (00000000)
Subnet Mask: (255.0.0.0 ) Eth II Ext. Network: (00000000)
Default Router:(0.0.0.0 ) SNAP Ext. Network: (00000000)
802.3 Ext. Network: (00000000)

Setup: <Filters > -Link Speed : <Auto Negotiate >
Scrollable: Select the item to be set up and hit ENTER.
```

4. Press [CTRL A] to enable filters that have been defined. See the following sections on Defining Custom, Protocol and Address Filters.

Enabled Filter  
Window

```
Telnet - 10.10.6.203
Connect Edit Terminal Help
< Carrier Access - Router Fri Apr 2, 2004 12:10:53 >
LocalUnit has 0 Enabled Filters.
Forward Mode: <ALL Frames NOT Matching Filters> Define Filter: <Custom > ->
Filter Type Source/Dest Filter Name

CTRL A to add, CTRL E to erase, CTRL F to page forward, CTRL B to page back
Scrollable: Select the port forwarding mode based upon the enabled filters.
```

## **Filters Menu Fields**

### **Forward Mode**

This field determines what data to pass/not to pass, based on this field value and the filters listed on the current window. There are two available values which determine how the Router will handle data to/from the LAN:

**<All Frames NOT Matching Filters>** any packets matching the filters listed will not be passed (i.e., pass all frames except those matching the enabled filters).

**<ONLY Frames Matching Filters>** enabled filters will have the PASS action. All packets matching the filters listed will be passed to/from the LAN. Any packets that do not match will be dropped (i.e., will not pass through the Router).

### **Define Filter**

Use this field to choose the appropriate filter type. The filter screens are used to define the actual filter prior to enabling (adding) it on the current window.

**<Custom>** see Defining Custom Filters on page 4-22

**<Protocol>** see Defining Protocol Filters on page 4-23

**<Address>** see Defining Address Filters on page 4-24

### **Filter Type**

This field value represents the type of filter **<Custom>**, **<Protocol>** or **<Address>**.

### **Source/Destination**

This field is active only with an Address Filter.

**<Source>** Filters by Source only.

**<Destination>** Filters by Destination only.

**<Both>** Filter by Source and Destination.

### **Filter Name**

This field displays the name the filter has been given.

## Defining Custom Filters

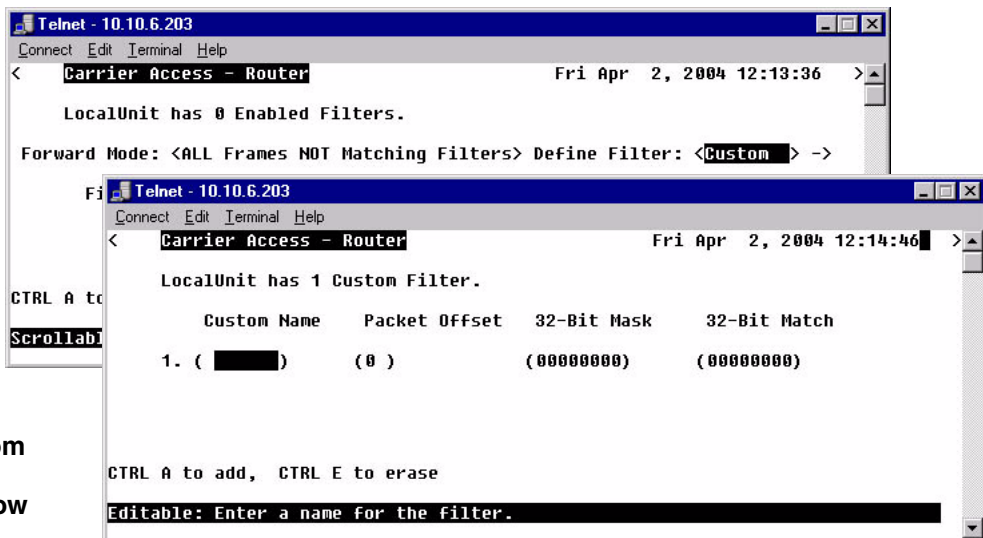

### Custom Filter Window

This screen defines filters that “search” for a matching string of characters within a packet. The defined character string can consist of up to 32 bits. The user must specify:

**Custom Name** - Filter name can be up to 7 characters.

**Packet Offset** - designates where in the packet to begin looking for a matching character string. Range is 0 to 60 bytes.

**32-Bit Mask** - indicates which bits are to be searched for a possible match. Within the mask, a **1** turns a bit ON, **0** is OFF. Only the bits that are turned on (set to 1) will be searched for the match.

**32-Bit Match** - specifies the character string that the system is searching for. When a match is located, the packet adheres to the **Forward Mode** field value.

To enable a filter return to the Enabled Filter Window ([ESC] from this window) and press [CTRL A], select filter type (Custom, Protocol or Address) filter will be added to the Enabled Filters window.

---

**NOTE:** Each filter, even if it is not enabled, will count toward the maximum number of 500 filters.

---

## Defining Protocol Filters

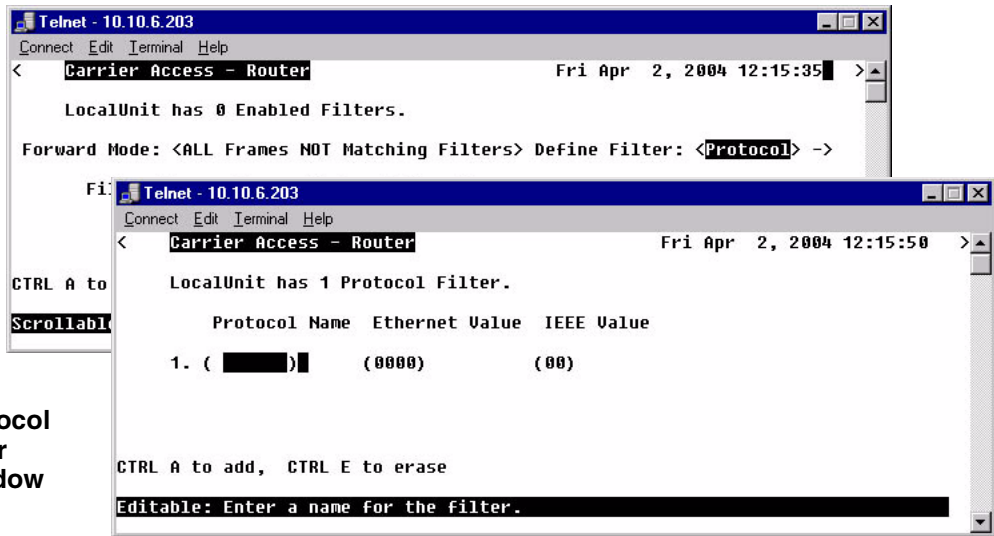

### Protocol Filter Window

Use this screen to define filters that are based on specific protocols being used by LAN devices. These filters, when enabled, provide security by restricting LAN/WAN access based on a specific protocol.

**Protocol Name** - Filter name can be up to 7 characters.

**Ethernet Value** - Enter the assigned Ethernet value for this protocol, see *Addendum B, Ethernet Protocol Types*.

**IEEE Value** - Enter assigned IEEE value for this protocol. The IEEE value is the same as the DSAP and SSAP values in a SNAP packet.

**NOTE:** Only identify either an Ethernet or IEEE value, but not both.

To enable a filter return to the Enabled Filter Window ([ESC] from this window) and press [CTRL A], select filter type (Custom, Protocol or Address) filter will be added to the Enabled Filters window.

**NOTE:** Each filter, even if it is not enabled, will count toward the maximum number of 500 filters.

## Defining Address Filters

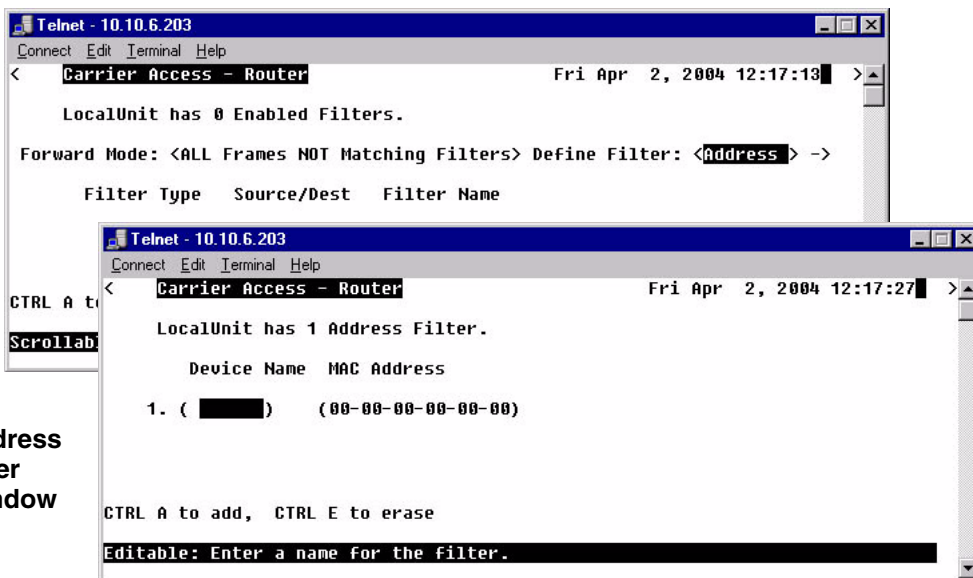

Address  
Filter  
Window

Use this window to define filters that are based on the Ethernet MAC Address of a specific device. When enabled, these filters provide security by restricting LAN/WAN access based on a device's MAC Address. Address filters are based on either source, destination or both source and destination MAC Addresses.

**Device Name** - Filter name can be up to 7 characters.

**MAC Address** - Enter the MAC Address of the LAN device that you are defining as a filter. The system will use the defined MAC Address and the value in the **Forward Mode** to determine whether the packet should be passed or received.

To enable a filter return to the Enabled Filter Window ([**ESC**] from this window) and press [**CTRL A**], select filter type (Custom, Protocol or Address) filter will be added to the Enabled Filters window.

---

**NOTE:** Each filter, even if it is not enabled, will count toward the maximum number of 500 filters.

---



## Advertise Network/Server

1. Select **Configuration <Profile Directory>** from the **Main menu**, press **[ENTER]**.
2. Select **LAN <Setup ->** and press **[ENTER]**.

Profile  
Directory  
Window

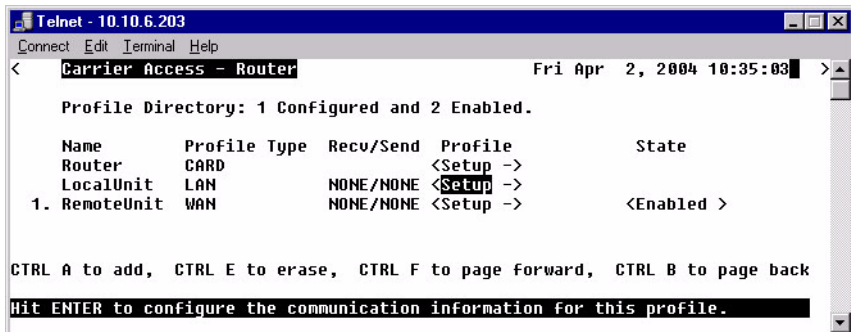

```
Telnet - 10.10.6.203
Connect Edit Terminal Help
< Carrier Access - Router Fri Apr 2, 2004 10:35:03 >

Profile Directory: 1 Configured and 2 Enabled.

Name      Profile Type  Recv/Send  Profile      State
Router    CARD          NONE/NONE  <Setup ->
LocalUnit LAN           NONE/NONE  <Setup ->
1. RemoteUnit WAN       NONE/NONE  <Setup ->  <Enabled >

CTRL A to add, CTRL E to erase, CTRL F to page forward, CTRL B to page back
Hit ENTER to configure the communication information for this profile.
```

3. Select **Setup: <Advertise Network/Server >**. If the Advertise Network/Server option is not displayed scroll to the selection with the **[SPACEBAR]**, and press **[ENTER]**.

Local  
Profile  
Window

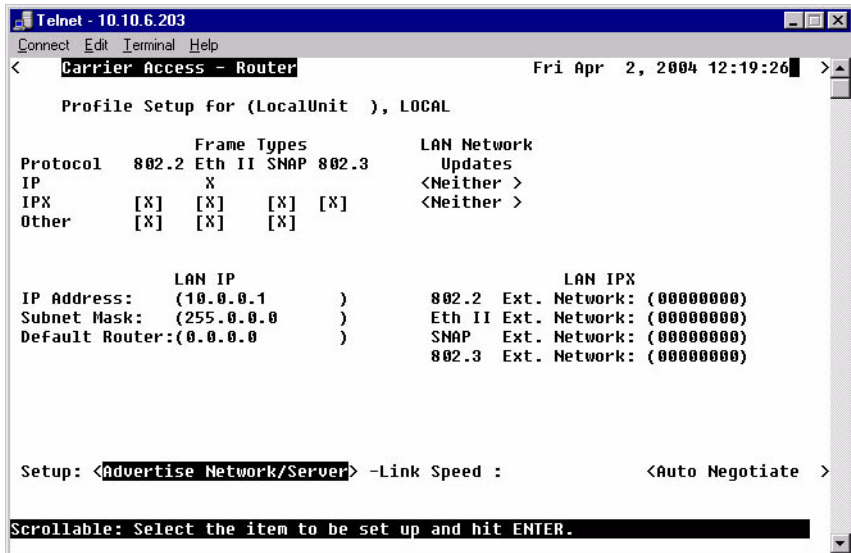

```
Telnet - 10.10.6.203
Connect Edit Terminal Help
< Carrier Access - Router Fri Apr 2, 2004 12:19:26 >

Profile Setup for (LocalUnit ), LOCAL

Protocol  802.2  Eth II  SNAP  802.3  LAN Network
IP        X      X      X      X      <Neither >
IPX      [X]   [X]   [X]   [X]   <Neither >
Other    [X]   [X]   [X]

LAN IP
IP Address: (10.0.0.1 )
Subnet Mask: (255.0.0.0 )
Default Router:(0.0.0.0 )

LAN IPX
802.2 Ext. Network: (00000000)
Eth II Ext. Network: (00000000)
SNAP Ext. Network: (00000000)
802.3 Ext. Network: (00000000)

Setup: <Advertise Network/Server > -Link Speed : <Auto Negotiate >

Scrollable: Select the item to be set up and hit ENTER.
```

## Profile Directory: Local Profile

### Advertise Network/Server

---

Use these windows to review networks that your unit has discovered through the LAN. By sending out IPX and IP RIP (Routing Information Protocol) and IPX SAP (Service Advertising Protocol) packets and monitoring RIP and SAP packets from other devices, your unit can learn about other networks. The system constantly monitors RIP packets to ensure that the status of the network has remained unchanged. Should a RIP packet indicate a change in status, the unit will update the data in the table and exchange the updated data with all remotes.

#### Advertise Network/Server Window

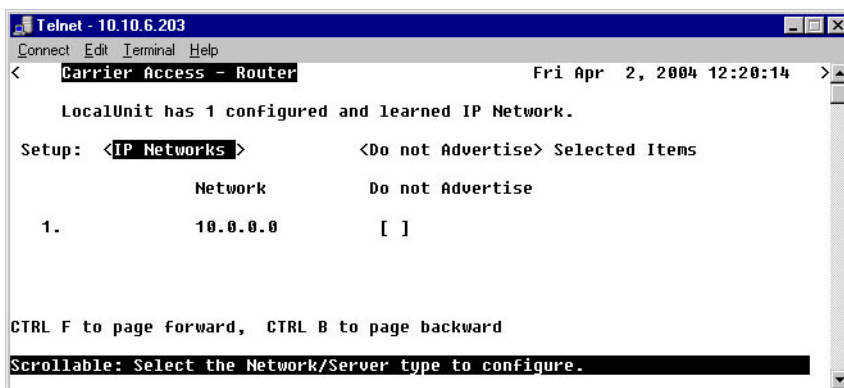

```
Telnet - 10.10.6.203
Connect Edit Terminal Help
< Carrier Access - Router                               Fri Apr 2, 2004 12:20:14 >
LocalUnit has 1 configured and learned IP Network.
Setup: <IP Networks>                                <Do not Advertise> Selected Items
      Network                                Do not Advertise
1.      10.0.0.0                                [ ]

CTRL F to page forward, CTRL B to page backward
Scrollable: Select the Network/Server type to configure.
```

Once the Local Unit has learned of a network, you may choose to have the Router advertise broadcast RIP packets on behalf of the actual network. Selecting which networks you wish your Local Unit to advertise provides added security by restricting what information is passed on to the remote.

For added control in network advertising, automatic learning may be turned off and, using the Static Network windows, manually enter the network routes to be advertised.

#### Disable Learning:

On the **LAN Profile setup window** set **LAN Network Updates** to **<Neither>**

On the **WAN Profile setup window** set **WAN Network Updates** to **<Never>**

The **Advertise Network/Server Window** can be used in two ways, depending on which **Selected Items** mode is chosen:

<**Do Not Advertise**> **Selected Items** mode causes the unit to not advertise the learned network to all remotes if you place an **X** next to the selected item.

<**Advertise**> **Selected Items** mode causes the unit to advertise the learned network to all remotes if you place an **X** next to the selected item.

---

**NOTE:** Since each network that contains an **X** next to it consumes a filter, choose an approach that consumes the least number of filters. With 15 learned networks of which 5 need to be advertised, it uses less filters to <**Advertise**> 5 networks than to select <**Do Not Advertise**> 10.

---

---

**NOTE:** Each selected network will be counted as a filter. A maximum of 500 filters can be defined on the Router.

---

## ***Advertise Network/Server Menu Fields***

### **Setup**

Use this field to identify which networks or server types you wish to review. Options are: <**IP Networks**>, <**IPX Servers**> and <**IPX Networks**>.

### **Selected Items**

<**Advertise**> With this option selected Networks will advertise to all remote units that are listed in your Profile Directory.

<**Do Not Advertise**> With this option selected Networks will not be advertised.

### **Network**

This field displays the network address of each network learned from the local LAN. If this route was added using one of the Static Network windows, “Static Fltr” will appear before the network address of this entry. If this is not a static route, and has been selected, “Config Fltr” will appear before the network address of this entry. Only static routes for the local unit will display on this window.

### IPX Server Advertising

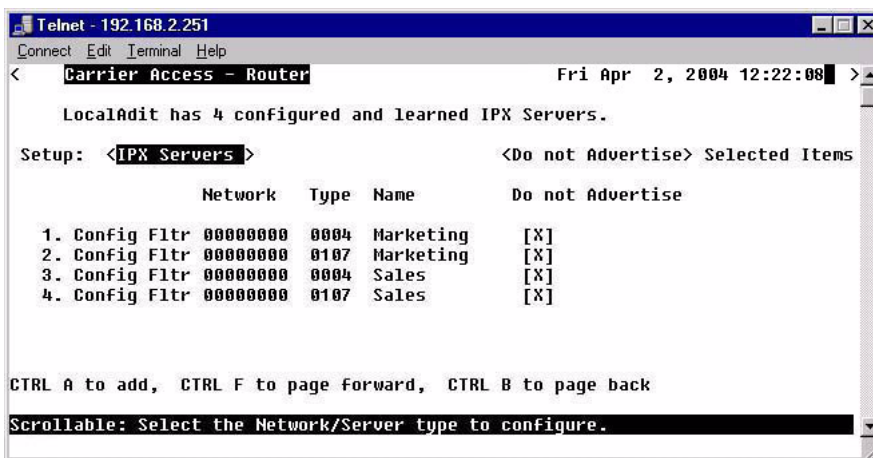

```
Telnet - 192.168.2.251
Connect Edit Terminal Help
< Carrier Access - Router                               Fri Apr 2, 2004 12:22:08 >
LocalAdit has 4 configured and learned IPX Servers.
Setup: <IPX Servers >                                <Do not Advertise> Selected Items
          Network  Type  Name          Do not Advertise
1. Config Fltr 00000000 0004 Marketing    [X]
2. Config Fltr 00000000 0107 Marketing    [X]
3. Config Fltr 00000000 0004 Sales      [X]
4. Config Fltr 00000000 0107 Sales      [X]
CTRL A to add, CTRL F to page forward, CTRL B to page back
Scrollable: Select the Network/Server type to configure.
```

Servers are learned and maintained by the Router in the same way as network tables, by sending out IPX SAP (Service Advertising Protocol) packets and monitoring SAP packets from other devices, the unit learns about other servers. Once a server has been discovered, the information is displayed on this window.

This window may be used in two ways, depending on which **Selected Items** mode is chosen: **<Do Not Advertise> Selected Items** or **<Advertise> Selected Items**. The **<Do Not Advertise>** mode causes the unit to not advertise the learned services. To advertise under this mode, remove the **X** next to the server to advertise. The **<Advertise>** mode causes the unit to advertise all learned services to all remotes. If a specific server under this mode is not to be advertised the **X** must be removed next to the listed server.

Since each server that contains an **X** next to it consumes a filter, you should choose the approach that consumes the least number of filters. For example, if a Router has learned 15 services of which you want to advertise only 5. It would consume fewer filters to set the **Selected Items** field to **<Advertise>** and place an **X** next to the 5 servers to, than to choose **<Do Not Advertise>** and place an **X** next to the 10 servers.

---

**NOTE:** Each selected server will be counted as a filter. A maximum of 500 filters can be defined on the Router.

---

### Network

This field displays the network address of each learned or configured server. If a server has been selected using the [X] key, “Config Fltr” will appear before the network address of this entry.

### Type

The TYPE field displays the Hex value assigned to each known server. When a server is added using [CTRL A], a Hex value must be defined. If you wish to learn certain services that match a particular server type, manually add an entry specifying the desired Hex value. This setting will enable the unit to learn all services that match the specified service type. This field may be used in conjunction with the NAME field, described below.

### Name

This field displays the first 11 characters of the name of each known server. If the server is manually added and a server name is not defined, all servers matching the added type will be learned and the first 11 characters of their names will be displayed. If the server name is defined when the server is manually added, then only servers matching both type and name will be learned.

### Selected Items

Use this field to determine whether your Router will advertise the information listed on this window to remote units. Valid field options include <Do Not Advertise> and <Advertise>. If <Advertise> is selected, checked items (with X) will advertise to all remote units in the Profile Directory. If <Do Not Advertise> is selected, checked items will not be advertised.

Use the [CTRL A] keys to manually configure a service. When manually configuring a service, the following prompt is displayed:

You must define a server type (see **TYPE** field, above), however the corresponding server name may be left blank. If a server name is not defined, all services of the specified type will be learned, regardless of the name.

If the server type and name are specified, only server types that match both values will be learned. Be aware that the NAME value is case and spacing sensitive.

Press [ESC] to save changes and return to the Local (LAN) Profile Setup window.

## DHCP Server/BOOTP Relay

Use the options on this window to enable the Router to act as either a DHCP server or BOOTP relay agent. Workstations with DHCP/BOOTP (Dynamic Host Configuration Protocol) client software will generate a broadcast message requesting an IP Address from a DHCP/BOOTP server. As a BOOTP relay agent, the Router will forward these requests to the appropriate server. When the server assigns the workstation an IP Address, the Router will then send this address back to the appropriate workstation. Using this method, the DHCP/BOOTP server can reside at a Remote (WAN) location and the Router can serve as an agent between requesting workstations and the server. As a DHCP server, the Router can assign up to 254 IP Addresses to DHCP clients on the local LAN. It will not assign to clients across the WAN.

1. Select **Configuration <Profile Directory>** from the **Main menu**, select [ENTER].
2. Select **LAN < Setup ->** and press [ENTER].

**Profile  
Directory  
Window**

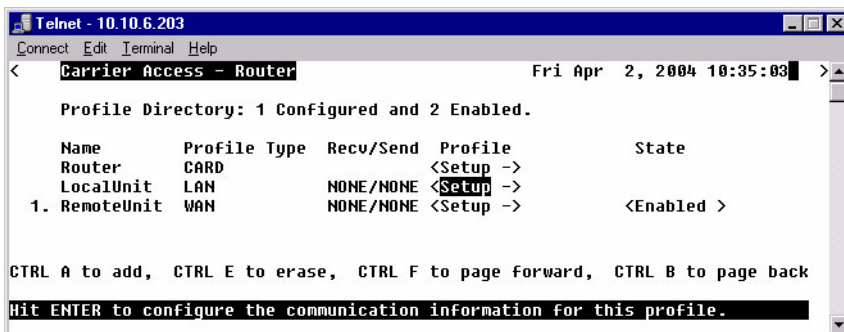

```
Telnet - 10.10.6.203
Connect Edit Terminal Help
< Carrier Access - Router                               Fri Apr 2, 2004 10:35:03 >
Profile Directory: 1 Configured and 2 Enabled.
Name      Profile Type  Recv/Send  Profile      State
Router    CARD          NONE/NONE  <Setup ->
LocalUnit LAN          NONE/NONE  <Setup ->
1. RemoteUnit WAN      NONE/NONE  <Setup ->  <Enabled >

CTRL A to add, CTRL E to erase, CTRL F to page forward, CTRL B to page back
Hit ENTER to configure the communication information for this profile.
```

3. Select **Setup: <DHCP Server/BOOTP Relay >** If not displayed scroll to the selection with the [SPACEBAR], and press [ENTER].

Local  
Profile  
Window



```
Telnet - 10.10.6.203
Connect Edit Terminal Help
< Carrier Access - Router Fri Apr 2, 2004 12:23:49 >
Profile Setup for (LocalUnit ), LOCAL

Protocol      Frame Types      LAN Network
802.2 Eth II SNAP 802.3
IP            X
IPX          [X] [X] [X] [X]
Other        [X] [X] [X]

Updates
<Neither >
<Neither >

LAN IP
IP Address:  (10.0.0.1 )
Subnet Mask: (255.0.0.0 )
Default Router:(0.0.0.0 )

LAN IPX
802.2 Ext. Network: (00000000)
Eth II Ext. Network: (00000000)
SNAP Ext. Network: (00000000)
802.3 Ext. Network: (00000000)

Setup: <DHCP Server/BOOTP Relay > -Link Speed : <Auto Negotiate >

Scrollable: Select the item to be set up and hit ENTER.
```

DHCP  
Server/  
BOOTP

```
Telnet - 10.10.6.203
Connect Edit Terminal Help
< Carrier Access - Router Fri Apr 2, 2004 12:24:41 >
DHCP Server/BOOTP Relay Agent Setup for local LocalUnit
DHCP Server: <Disabled> DHCP/BOOTP Relay Agent: <Disabled>

Scrollable: Select whether this feature should be enabled.
```

#### DHCP Server/ BOOTP

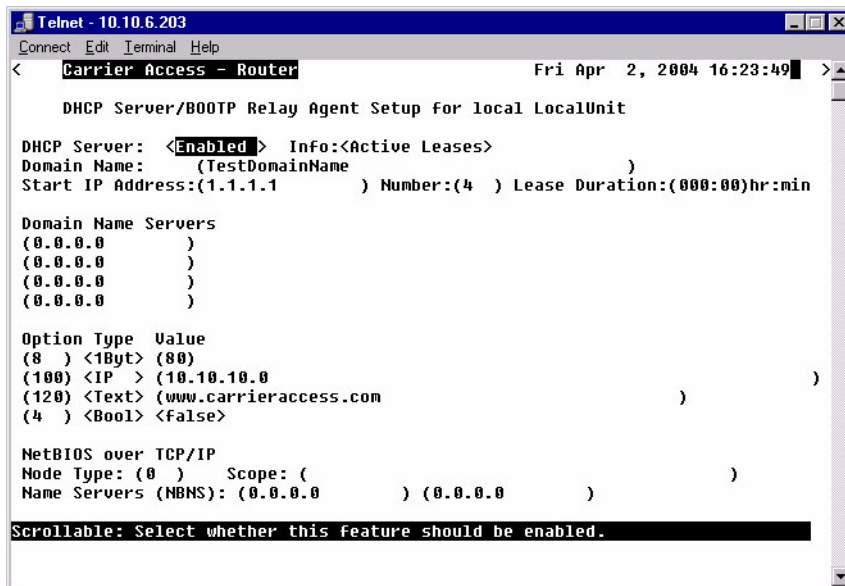

```
Telnet - 10.10.6.203
Connect Edit Terminal Help
< Carrier Access - Router Fri Apr 2, 2004 16:23:49 >

DHCP Server/BOOTP Relay Agent Setup for local LocalUnit

DHCP Server: <Enabled> Info:<Active Leases>
Domain Name: (TestDomainName )
Start IP Address:(1.1.1.1 ) Number:(4 ) Lease Duration:(000:00)hr:min

Domain Name Servers
(0.0.0.0 )
(0.0.0.0 )
(0.0.0.0 )
(0.0.0.0 )

Option Type Value
(8 ) <1Byt> (80)
(100) <IP > (10.10.10.0 )
(120) <Text> (www.carrieraccess.com )
(4 ) <Bool> <false>

NetBIOS over TCP/IP
Mode Type: (0 ) Scope: ( )
Name Servers (NBNS): (0.0.0.0 ) (0.0.0.0 )

Scrollable: Select whether this feature should be enabled.
```

## DHCP Server/BOOTP Relay Menu Fields

### DHCP Server

Use this field to enable this Router as a DHCP Server. Use the [SPACEBAR] to select <Enabled> or <Disabled>. The following fields are available when enabled.

### Info: Active Leases

Displays the Active Lease Information below.

### Domain Name

This option is used if the DHCP Server is enabled on the DHCP Server/BOOTP Relay screen. On a LAN network where the Router is the DHCP Server, the **Domain Name** will be assigned with IP addressing information to DHCP clients. This value is a maximum of 41 characters.

### Start IP Address

If the Router is specified to act as a DHCP server, enter the first valid IP Address the Router may assign to a DHCP client. This field acts in conjunction with the **Number** field.

### Number

Enter the number of IP Addresses that this Router may assign. This field acts in conjunction with the **Start IP Address** field by using a contiguous block of IP Addresses. Range is 1-254.



### **Lease Duration**

Enter the duration, in hours and minutes, that an IP Address assigned by the Router will remain valid. If this field is left at 000.00, the IP Address will remain valid indefinitely. Range is Hours = 1-999 Minutes = 1-59.

### **Domain Name Servers**

The **Domain Name Servers** option specifies the IP address of DNS name servers to be used by DHCP clients. Enter the IP address of up to 4 domain name servers.

### **Option Type Value**

These fields add the optional DHCP server attributes that will be advertised every time a DHCP client discovery is initiated. This provisioning takes effect immediately and can only be performed when the DHCP server is enabled. Once the option number is entered the other fields become active.

#### **Option**

Range is 1-254. Options tags are unique, duplicate numbers will be rejected. 0 = off  
Reserved numbers = 6, 15, 44, 46, 47, 50, 51, 53, 54 and 61. The operator will be notified when exiting this window, that a Reserved or Duplicate Option number has been used, and will direct you to modify the option number.

#### **Type**

**<Bool>** - Boolean uses <true> <false>

**<1Byt>** **<2Byte>** **<3Byte>** **<4Byte>** - sends a value in 1, 2, 3 or 4 bytes.

**<IP>** - IP Address in the form xxx.xxx.xxx.xxx, where xxx is a number from 0 to 255.

**<TEXT>** - String with a maximum of 50 characters, enclosed in quotes.

### **NetBIOS over TCP/IP**

#### **Node Type**

This option allows NetBIOS over TCP/IP clients, which are configurable to be configured as described in RFC 1001/1002. The value is specified as a single octet that identifies the client type (1=B-node, 2=P-node, 4=M-node, 8=H-node).

#### **Scope**

The Scope is a DHCP option that represents a grouping of computers on a subnet using the same NetBIOS name. This name has a maximum of 41 characters.

#### **Name Server (NBNS)**

This option specifies a list of RFC 1001/1002 NBNS name servers listed in order of preference. Enter the IP address of the NBNS servers.

## **LAN Collision Threshold**

Use the options on this window to define the sample interval for data collection of collisions, the Hi and Lo thresholds for raising and clearing Collision alarms. It will also display if there is a current alarm active and the number of collisions that have occurred during the defined sample interval.

1. Select **Configuration <Profile Directory>** from the **Main menu**, press **[ENTER]**.
2. Select **LAN < Setup ->** and press **[ENTER]**.

### **Profile Directory Window**

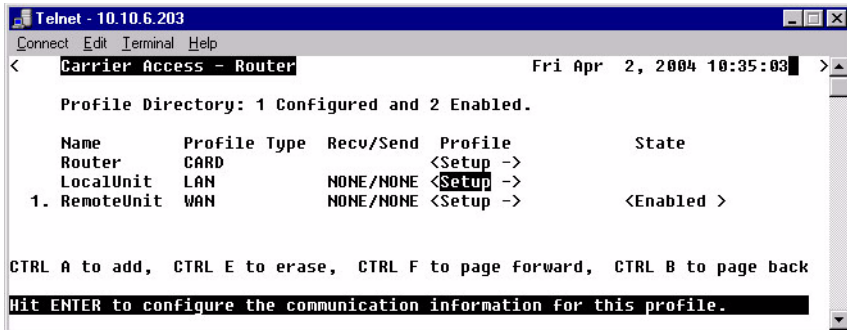

3. Select **Setup: <LAN Collision Threshold >** If the LAN Collision Threshold option is not displayed scroll to the selection with the [SPACEBAR], and press [ENTER].

Local  
Profile  
Window



```
Telnet - 10.10.6.203
Connect Edit Terminal Help
< Carrier Access - Router Fri Apr 2, 2004 16:49:55 >
Profile Setup for (LocalUnit ), LOCAL

Protocol      Frame Types      LAN Network
802.2 Eth II SNAP 802.3 Updates
IP            X                <Neither >
IPX          [X] [X] [X] [X] <Neither >
Other       [X] [X] [X]

LAN IP
IP Address:   (10.0.0.1 )
Subnet Mask: (255.0.0.0 )
Default Router:(0.0.0.0 )

LAN IPX
802.2 Ext. Network: (00000000)
Eth II Ext. Network: (00000000)
SNAP Ext. Network: (00000000)
802.3 Ext. Network: (00000000)

Setup: <LAN Collision Threshold > -Link Speed : <Auto Negotiate >

Scrollable: Select the item to be set up and hit ENTER.
```

LAN  
Collision  
Threshold  
Provisioning

```
Telnet - 10.10.6.203
Connect Edit Terminal Help
< Carrier Access - Router Fri Apr 2, 2004 16:51:47 >
LAN Collision Threshold Provisioning Setup for local LocalUnit

Lan: DWN Collisions: 0 Alarm: NO

Sample Interval: (10 )
Collision Hi Threshold: (5000 )
Collision Lo Threshold: (10 )

Collision Sample Interval 1-65535 seconds, 0 is Disable, Default is 10
```

## ***Profile Directory: Local Profile***

### ***LAN Collision Threshold***

---

#### **LAN**

Will indicate if the LAN is UP or Down (DWN).

#### **Collisions**

The number of collisions that have occurred during the defined sample interval.

#### **Alarm**

This field indicates if there is/is not an active collision alarm.

There is an alarm indicator on the front of the IP Router Card, labeled COL. If a collision alarm is active this LED will flash yellow.

#### **Sample Interval**

Use the Collision Sample Interval in second. (1-65536 seconds).

- Default is 10
- Disable is 0

#### **Collision Hi Threshold**

Use this field to set the number of collisions in Interval to raise an alarm. When the number of collisions rises above the defined number per interval, the alarm will be activated. The default is 500.

#### **Collision Lo Threshold**

Use this field to set the number of collisions in Interval to Clear Alarm. If the number of collisions drops below the defined number per interval, the alarm will clear. Default is 10.

## Spanning Tree

**NOTE:** This option does not display on the **Local LAN Profile Setup**, until Spanning Tree is enabled on the **Router CARD Profile**.

The Spanning Tree configures the setup for the Spanning Tree Algorithm.

### To Configure Spanning Tree:

1. Select **Configuration <Profile Directory>** from the **Main menu**, and press **[ENTER]**.
2. Select **LAN < Setup ->** and press **[ENTER]**.

### Profile Directory Window

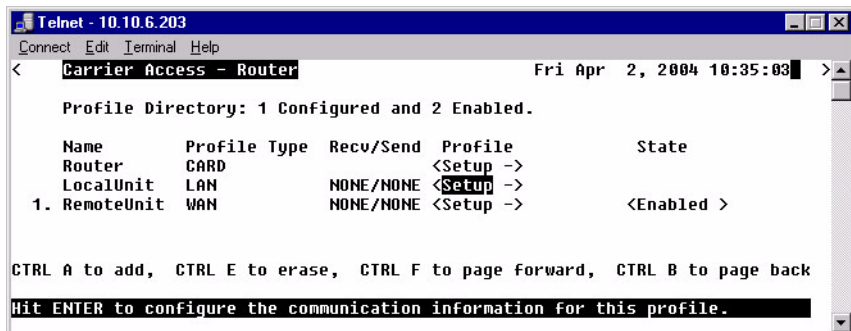

```
Telnet - 10.10.6.203
Connect Edit Terminal Help
< Carrier Access - Router Fri Apr 2, 2004 10:35:03 >
Profile Directory: 1 Configured and 2 Enabled.
Name      Profile Type  Recv/Send  Profile      State
Router    CARD          NONE/NONE  <Setup ->
LocalUnit LAN           NONE/NONE  <Setup ->
1. RemoteUnit WAN           NONE/NONE  <Setup ->  <Enabled >

CTRL A to add, CTRL E to erase, CTRL F to page forward, CTRL B to page back
Hit ENTER to configure the communication information for this profile.
```

## Profile Directory: Local Profile

### Spanning Tree

---

3. Select **Setup: <Spanning Tree >** and press [ENTER].

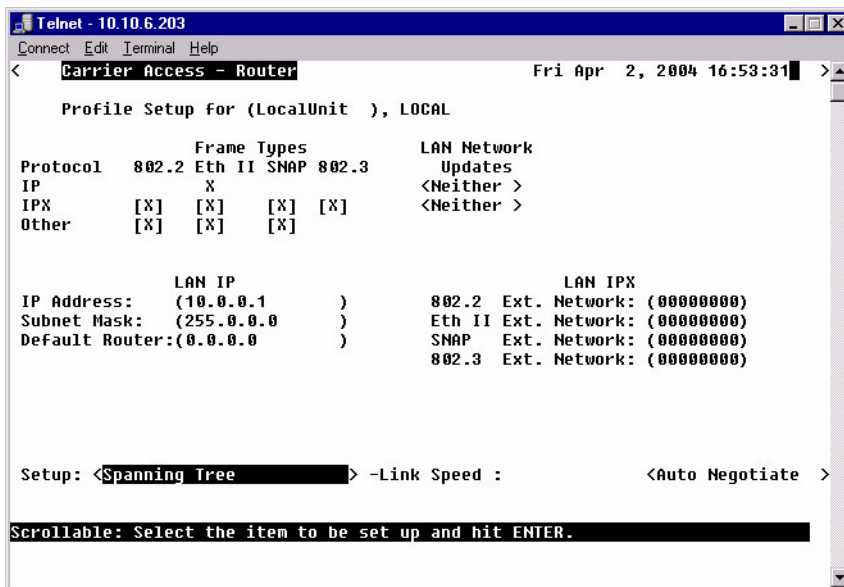

```
Telnet - 10.10.6.203
Connect Edit Terminal Help
< Carrier Access - Router Fri Apr 2, 2004 16:53:31 >
Profile Setup for (LocalUnit ), LOCAL

Protocol 802.2 Eth II SNAP 802.3 LAN Network
IP        X                               <Neither >
IPX       [X] [X] [X] [X]          <Neither >
Other     [X] [X] [X]

LAN IP                               LAN IPX
IP Address: (10.0.0.1 )             802.2 Ext. Network: (00000000)
Subnet Mask: (255.0.0.0 )          Eth II Ext. Network: (00000000)
Default Router:(0.0.0.0 )          SNAP Ext. Network: (00000000)
                                   802.3 Ext. Network: (00000000)

Setup: <Spanning Tree > -Link Speed : <Auto Negotiate >
Scrollable: Select the item to be set up and hit ENTER.
```

4. To enable **Spanning Tree**, scroll <Disabled> to <Enabled>, with the [SPACEBAR], press [ENTER].

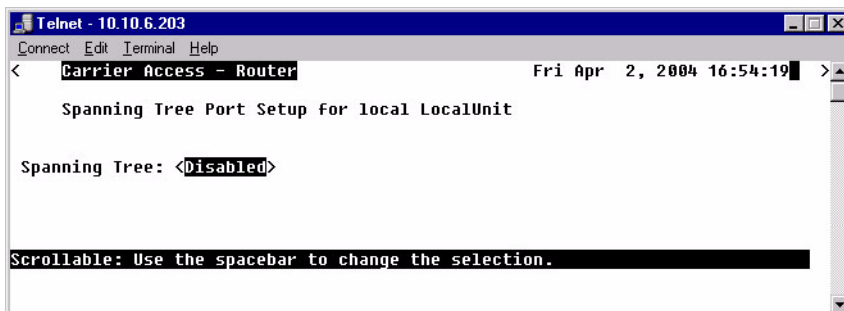

```
Telnet - 10.10.6.203
Connect Edit Terminal Help
< Carrier Access - Router Fri Apr 2, 2004 16:54:19 >
Spanning Tree Port Setup for local LocalUnit

Spanning Tree: <Disabled>

Scrollable: Use the spacebar to change the selection.
```

5. Enter the appropriate data in the following fields.

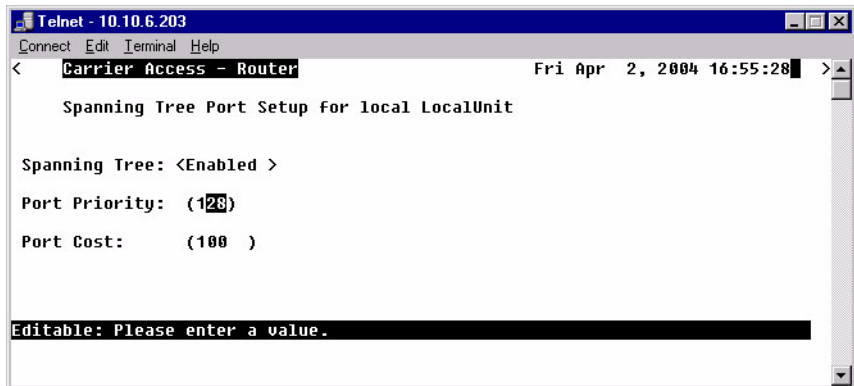

### **Port Priority**

The Port Priority value can range from 0 to 255, with a default of 128.

### **Port Cost**

The Port Priority value can range from 0 to 65535, with a default of 651.

## Profile Directory: Local Profile

### Secondary IP Address

---

## Secondary IP Address

This option will add a secondary IP address and subnet to the specified LAN interface. The router will then be capable of routing between the various subnets on the LAN interface or between any of the LAN subnets and any WAN subnet. A maximum of 8 secondary IP addresses can be added to the LAN interface.

### To Add a Secondary IP Address:

1. Select **Configuration <Profile Directory>** from the **Main menu**, and press **[ENTER]**.
2. Select **LAN < Setup ->** and press **[ENTER]**.

### Profile Directory Window

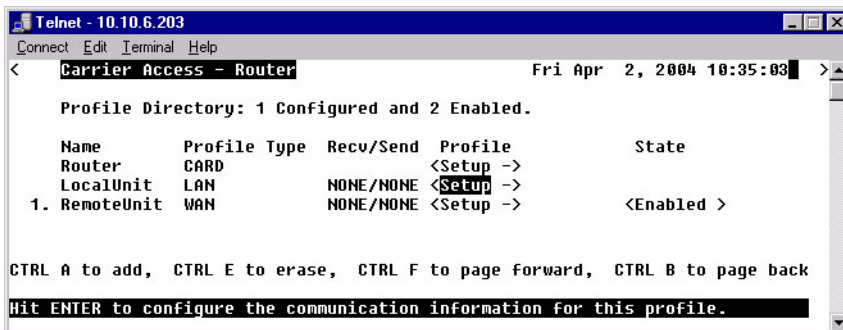

```
Telnet - 10.10.6.203
Connect Edit Terminal Help
< Carrier Access - Router                               Fri Apr 2, 2004 10:35:03 >
Profile Directory: 1 Configured and 2 Enabled.
Name      Profile Type  Recv/Send  Profile      State
Router    CARD          NONE/NONE  <Setup ->
LocalUnit LAN          NONE/NONE  <Setup ->
1. RemoteUnit WAN      NONE/NONE  <Setup ->  <Enabled >

CTRL A to add, CTRL E to erase, CTRL F to page forward, CTRL B to page back
Hit ENTER to configure the communication information for this profile.
```



3. Select **Setup: <Secondary IP Address>**, by scrolling through the options with the [SPACEBAR] and select [ENTER]. Select [CTRL A] to enter an IP Address.

Local  
Profile  
Window



```
Telnet - 10.10.6.203
Connect Edit Terminal Help
< Carrier Access - Router Fri Apr 2, 2004 16:56:43 >

Profile Setup for (LocalUnit ), LOCAL

          Frame Types
Protocol 802.2 Eth II SNAP 802.3
IP        X
IPX       [X] [X] [X] [X]
Other     [X] [X] [X]

LAN Network
Updates  <Neither >
Other    <Neither >

          LAN IP
IP Address: (10.0.0.1 )
Subnet Mask: (255.0.0.0 )
Default Router:(0.0.0.0 )

          LAN IPX
802.2 Ext. Network: (00000000)
Eth II Ext. Network: (00000000)
SNAP Ext. Network: (00000000)
802.3 Ext. Network: (00000000)

Setup: <Secondary IP Addresses > -Link Speed : <Auto Negotiate >

Scrollable: Select the item to be set up and hit ENTER.
```

```
Telnet - 10.10.6.203
Connect Edit Terminal Help
< Carrier Access - Router Fri Apr 2, 2004 16:57:48 >

Secondary IP Address Setup for local LocalUnit

IP Address      Subnet Mask
1. (0.0.0.0 ) (0.0.0.0 )

CTRL A to add, CTRL E to erase

Editable: Enter a non-zero IP Address/Subnet Mask in Dotted Decimal Notation.
```

### IP Address

The secondary IP Address, in the form xxx.xxx.xxx.xxx, where xxx is between 1 -255.

### Subnet Mask

The Subnet Mask to the corresponding Secondary IP address listed, in the form xxx.xxx.xxx.xxx, where xxx is between 1 -255.

## Link Speed

The Link Speed sets the Ethernet PHY mode and speed for the Router.

---

**NOTE:** It is highly recommended that this setting be left at auto-negotiation. Connection Ethernet devices with incompatible settings can lead to severe performance degradation and errors on a network.

---

### To Set the Link Speed:

1. Select **Configuration <Profile Directory>** from the **Main menu**, and press [ENTER].
2. Select **LAN <Setup ->** and press [ENTER].

### Profile Directory Window

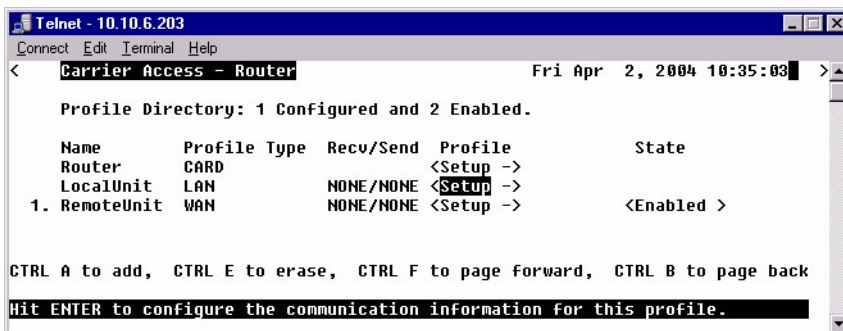

```
Telnet - 10.10.6.203
Connect Edit Terminal Help
< Carrier Access - Router                               Fri Apr  2, 2004 10:35:03 >
Profile Directory: 1 Configured and 2 Enabled.
Name      Profile Type  Recv/Send  Profile      State
Router    CARD          <Setup ->
LocalUnit LAN          NONE/NONE <Setup ->
1. RemoteUnit WAN      NONE/NONE <Setup -> <Enabled >

CTRL A to add, CTRL E to erase, CTRL F to page forward, CTRL B to page back
Hit ENTER to configure the communication information for this profile.
```

3. Select **Link Speed: <Auto Negotiate >** scroll to the selection with the [SPACEBAR], and press [ENTER].

Local  
Profile  
Window

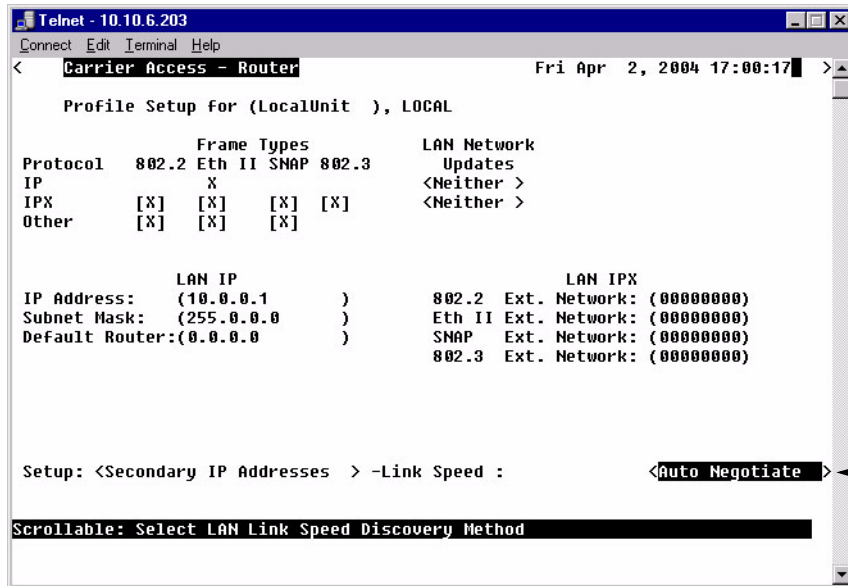

### Auto Negotiate

This selection is the default and is highly recommended to be left at this setting. The router and the device will negotiate common features and functions.

### 100T Full Duplex

The selection will force the Ethernet PHY to 100 MHz full-duplex on the Router.

### 100T Half Duplex

The selection will force the Ethernet PHY to 100 MHz half-duplex on the Router.

### 10T Full Duplex

The selection will force the Ethernet PHY to 10 MHz full-duplex on the Router.

### 10T Half Duplex

The selection will force the Ethernet PHY to 10 MHz half-duplex on the Router.

## ***Profile Directory: Local Profile***

*Link Speed*

---

# CHAPTER 5

---

## *Profile Directory:Remote Profile*

### **In this Chapter**

- Remote (WAN) Profile
- Security/Options
- Static/VPN Networks
- Static NAT Addresses
- NAT Bypass Subnets
- Static Addresses
- Firewall Filters
- Filter Network/Server
- Spanning Tree
- Trunk Port

## Profile Directory:Remote Profile

---

The Local (LAN) Profile Setup is found in **Configuration <Profile Directory>/LocalUnit LAN <Setup ->**.

Main Menu

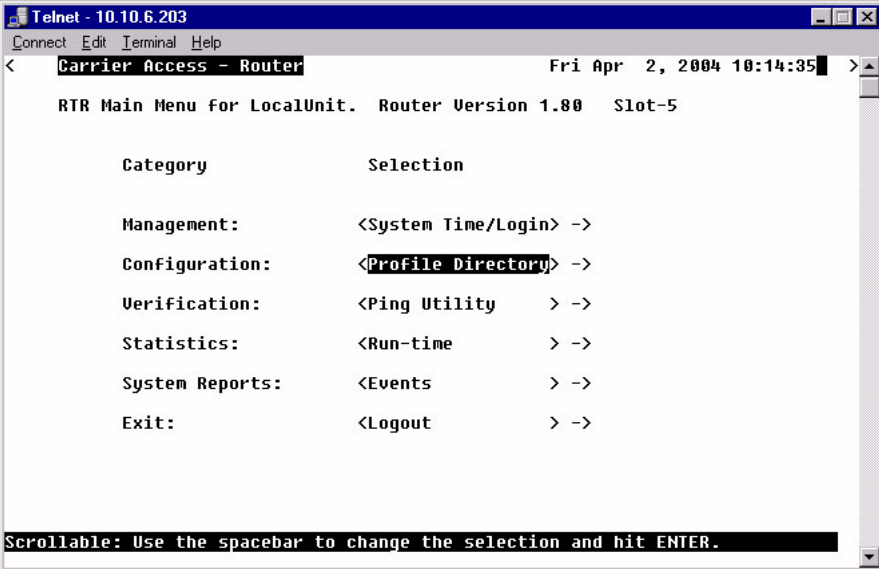

```
Telnet - 10.10.6.203
Connect Edit Terminal Help
< Carrier Access - Router                               Fri Apr 2, 2004 10:14:35 >
RTR Main Menu for LocalUnit. Router Version 1.80 Slot-5

      Category              Selection

Management:                <System Time/Login> ->
Configuration:             <Profile Directory> ->
Verification:              <Ping Utility   > ->
Statistics:                 <Run-time      > ->
System Reports:            <Events        > ->
Exit:                       <Logout        > ->

Scrollable: Use the spacebar to change the selection and hit ENTER.
```

Profile Directory window

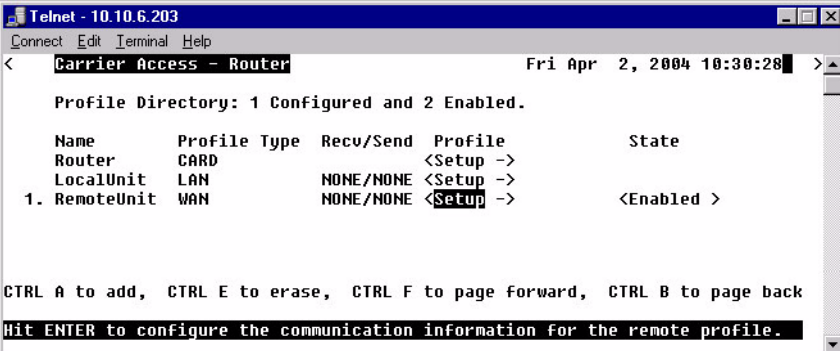

```
Telnet - 10.10.6.203
Connect Edit Terminal Help
< Carrier Access - Router                               Fri Apr 2, 2004 10:30:28 >
Profile Directory: 1 Configured and 2 Enabled.

Name      Profile Type  Recv/Send  Profile      State
Router    CARD          NONE/NONE <Setup ->
LocalUnit LAN          NONE/NONE <Setup ->
1. RemoteUnit WAN    NONE/NONE <Setup -> <Enabled >

CTRL A to add, CTRL E to erase, CTRL F to page forward, CTRL B to page back
Hit ENTER to configure the communication information for the remote profile.
```

Remote  
Profile  
window

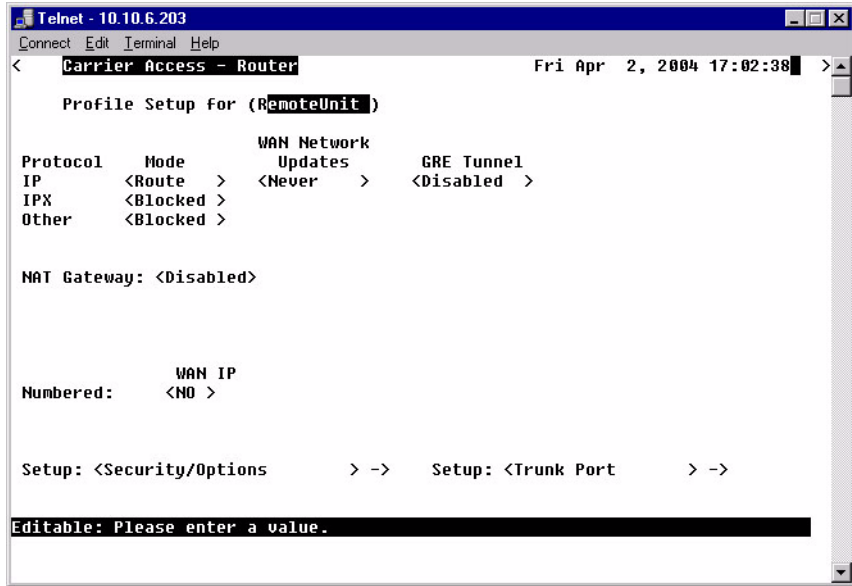

## Profile Directory:Remote Profile

### Remote (WAN) Profile

---

## Remote (WAN) Profile

The fields on the Remote (WAN) Profile Setup window allow you to define how and when data transmission will occur with a specific remote device. This includes defining the protocol(s) that it will use to send and receive data, defining security information, static networks and WAN lines. The Local Unit will depend on this information to determine communication guidelines with remote sites.

The Remote (WAN) profile can support up to 24 remote profiles.

The Remote (WAN) profile complements the Local (LAN) profile. The remote profiles identify which remote devices the local unit can communicate with by defining the data transmission requirements of each remote device. The local profile defines the local unit's transmission requirements and may appear as a remote profile in each remote unit's profile directory. It is important to understand that the information contained in the remote profile determines how the local and remote units establish communication.

1. Select **Configuration <Profile Directory>** from the **Main Menu**, press **[ENTER]**.
2. Select **WAN <Setup ->** on the **RemoteUnit** line and press **[ENTER]**.

### Profile Directory Window

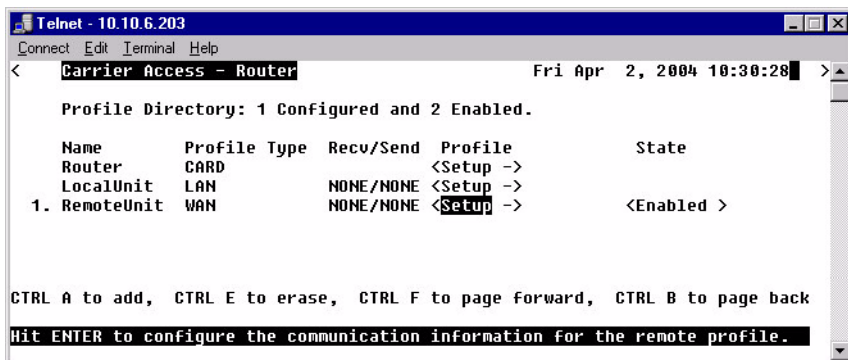

```
Telnet - 10.10.6.203
Connect Edit Terminal Help
< Carrier Access - Router                               Fri Apr 2, 2004 10:30:28 >
Profile Directory: 1 Configured and 2 Enabled.
Name      Profile Type  Recv/Send  Profile      State
Router    CARD          NONE/NONE  <Setup ->
LocalUnit LAN           NONE/NONE  <Setup ->
1. RemoteUnit WAN         NONE/NONE  <Setup ->  <Enabled >

CTRL A to add, CTRL E to erase, CTRL F to page forward, CTRL B to page back
Hit ENTER to configure the communication information for the remote profile.
```



The Remote Profile Window will change as options are selected. The graphic below displays the window as NAT Gateway is enabled.

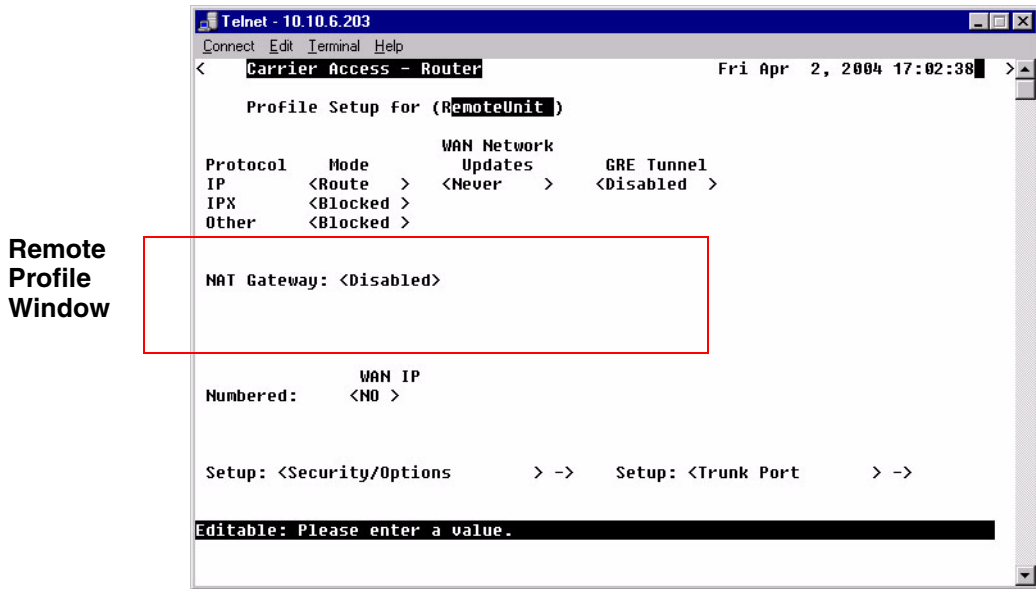

The following is just one example of how the above window in the box changes when different protocol options are selected.

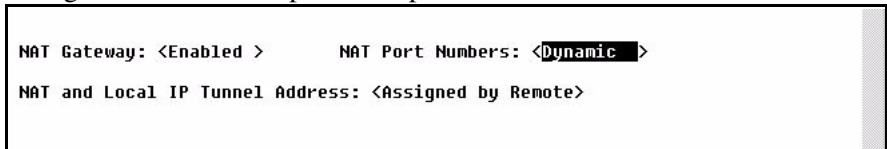

### **Profile Setup for (RemoteUnit)**

This is an 11 character maximum field to uniquely identify this remote device. This value identifies the remote system's name on the remote unit's Local (LAN) Profile Setup window. All remote devices will initially have the default name "RemoteUnit". To change the name of the remote device, simply type over the existing name.

This name will be used during the authentication process to ensure this unit's identity. Please note that the system is case and spacing sensitive.

## Profile Directory: Remote Profile

### Remote (WAN) Profile

---

## Transmission Options

The following section is always displayed on the Remote Profile setup window. By selecting options on this chart, other fields are displayed or removed.

Protocol	Mode	WAN Network Updates	GRE Tunnel
IP	<Route >	<Never >	<Disabled >
IPX	<Blocked >		
Other	<Blocked >		

### Protocol

This field displays three protocol options, **IP**, **IPX** and **Other**. Use the Mode, **WAN Network Updates**, and **GRE Tunnel** fields to determine how and if the listed protocols will be used. This screen will change dramatically as different modes are selected.

### Mode

This field works in conjunction with the Protocol field, above, and defines which protocol(s) the Unit will use to send and receive data when communicating with this remote device.

Protocol	Route	Blocked	Bridge	Optimize
IP	X	X	X	
IPX		X	X	X
Other		X	X	

**<Route>** - When used in conjunction with the **LAN Network Updates** (Local Profile window) and **WAN Network Updates** setting (below), the **<Route>** values enable the Unit to use Carrier Access' network optimization feature, which ensures that only necessary data is transmitted over the WAN connection. The Router will initiate IP and IPX learning mode. With each of these selections the Router will initiate learning mode to gain knowledge of local and remote networks and services. Once it knows of remote networks and services, it can advertise the information on the local LAN on behalf of the remote networks and servers.

**<Bridge>** - will not prompt the Router to initiate WAN bandwidth optimization. Note that the unit will not advertise servers and networks.

**<Blocked>** - if you do not wish to use the corresponding protocol.

**<Optimize>** - See **<Route>** above

## **WAN Network Updates**

Routing information updates across the WAN will occur based on this selection. This field is only available when IP (Protocol) is set to **<Route>** or when IPX (Protocol) is set to **<Optimize>**. This field should be set to **<Never>** if the **NAT Gateway** field, below, is set to **<Enabled>**.

**<Never>** To prohibit all routing information updates. When this is selected, static routes between the Router and the remote units must be configured.

**<Periodic>** Periodic updates across the WAN occur every 30 seconds for the IP protocol and every 60 seconds for IPX.

**<Triggered>** Triggered updates occur only when changes within the network are detected. This is the recommended setting.

## **GRE Tunnel**

Use this field to define IP Tunneling for GRE (Generic Route Encapsulation). If enabled, define the local and remote IP Tunnel Addresses, as well as the Secured GRE Tunneled Data. This field is only available if the IP protocol is set to **<Route>**.

**<All>** Tunnel all packets on this interface to the tunnel destination address.

**<By Network>** Tunnel packets based on their destination address by matching GRE network entries.

---

**NOTE:** If the IP protocol is set to **<By Network>**, establish the remote address in the Static Networks window.

---

**<Disabled>** Disable GRE tunneling.

## **Profile Directory:Remote Profile**

### **Remote (WAN) Profile**

---

#### **NAT Gateway**

Enable NAT Gateway for this Router to translate addresses from all of its local devices to a specific IP Address (typically assigned by an Internet Service Provider). This will allow the remote device to dynamically assign a single IP Address to the Router or to configure a specific IP Address, which in turn will be used by all devices on that network.

##### **<Enabled> with GRE Tunnel <Disabled>**

**NAT Port Numbers:** Port numbers are associated with applications that run on the workstation. The NAT Gateway may translate the socket, or combination of IP Address and TCP port number.

**<Dynamic>** IP Address and the port number will be translated.

**<Preserved>** NAT Gateway will only translate the IP Address. This should only be set to **<Preserved>** if an application you are using requires a specific port number.

**NAT Address:** Use this field to define the IP Address for the Local (LAN) tunneling or NAT Gateway device.

**<Assigned by Remote>**

**<Configured>** with Configured selected the following fields are displayed:

**Address:** Enter the Local IP Tunnel Address/Subnet Mask. If you are only GRE Tunneling, this will probably be your local IP Address in the Local Profile. If the address is dynamically assigned, the Router will receive an IP Address from this remote device.

**Number of NAT Addresses:** With a setting of NAT addresses to greater than 1 you a pool of public addresses is created from which the NAT translation will draw. Range is between 1-255.

##### **<Enabled> with GRE Tunnel <By Network>**

**NAT Port Numbers:** See definition on previous page.

**NAT and Local IP Tunnel Address:** Use this field to define the IP Address for the Local (LAN) tunneling or NAT Gateway device.

**<Configured>** See definition on previous page.

**<Assigned by Remote>**

## VPN Setup

### <Enabled> with GRE Tunnel <All>

IP Protocol VPN Setup - > window will display.

This field displays only when **GRE Tunnel** is set to <All>. To open the setup window select **IP Protocol VPN Setup - >** and select [ENTER]

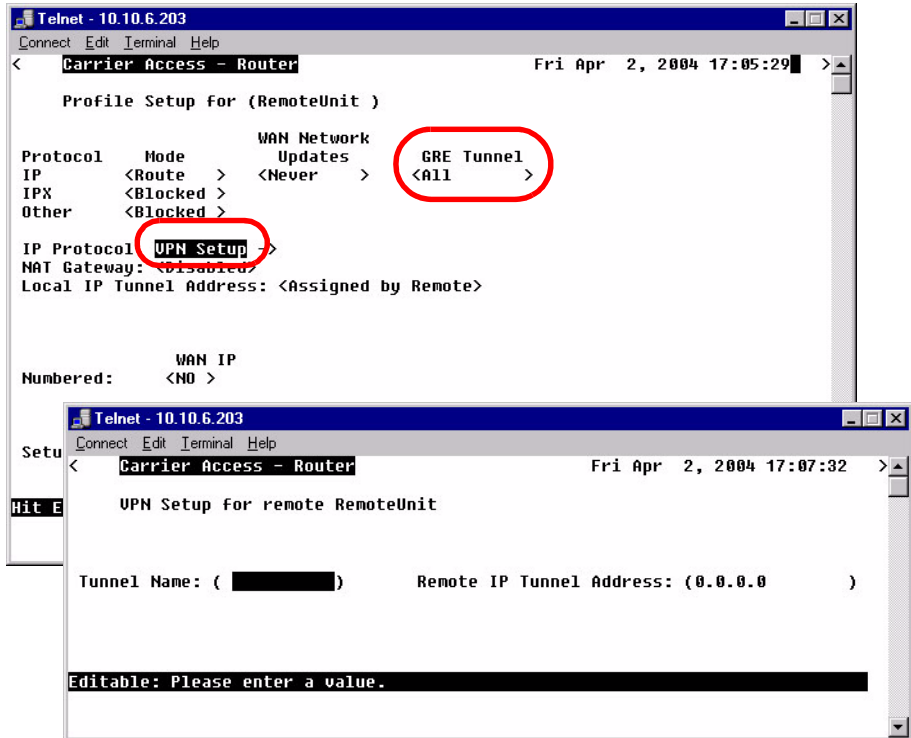

### Tunnel Name

Enter Tunnel name, up to 11 characters.

### Remote IP Tunnel Address

Enter IP Tunnel Address.

## Profile Directory:Remote Profile

### Remote (WAN) Profile

---

#### WAN IP

This field is used to enable the Router to assign an IP Address to the remote device that this remote profile is attached to.

##### Numbered

Designate if the local unit will have an IP Address assigned to the WAN when communicating with this remote unit. If the remote unit is an Adit, it is recommended that the WAN remain unnumbered, thus conserving IP Addresses. This field displays if the **IP Mode** field is set to **<Route>**.

**IP Address:** This address is used to uniquely identify the unit on the internetwork. Use this field to assign an IP Address to the WAN.

**Subnet Mask:** A subnet mask determines which bits in the IP address are used to identify the network number. It is also a method of extending the IP Network Address so that a site may use one network address for several different networks.

##### Default Router

Use this field to identify a router that is physically connected to your LAN. If the Router receives a packet destined to a network that is not known, the packet will be sent to the router identified in this field. This field is only displayed if the **IP Mode** field is set to **<Bridge>**.

#### Setup < > (bottom of the Remote main window)

The Setup field has the following options. Use the [SPACEBAR] to scroll through the selections.

##### <Security/Options >

Use this option to access the Remote (WAN) Security/Options Setup window. The fields on this window may be used to configure the remote security parameters and options such as compression. See *Security/Options on page 5-12*, for more information.

##### <Static/VPN Networks >

Use this option to access the Static/VPN Networks window. These windows can be used to configure static network routes for the remote device. See *Static/VPN Networks on page 5-15*, for more information.

##### <Static NAT Addresses >

Use this option to access the Static NAT Addresses window which allows the operator to configure static bi-directional NAT mappings between local server addresses and public addresses. See *Static NAT Addresses on page 5-22*, for more information.

**<NAT Bypass Subnets >**

Use this option to access the Static NAT Addresses window which allows the operator to configure static bi-directional NAT mappings between local server addresses and public addresses. See *Static NAT Addresses on page 5-22*, for more information.

**<Static Addresses >**

This option is used to access the Static Addresses window which allows the operator to configure static addresses for the remote unit. See *Static Addresses on page 5-26*, for more information.

**<Firewall Filters >**

This option is used to access the Firewall Rules screen which allows the operator to establish firewall filters for this remote unit. See *Firewall Filters on page 5-29*, for more information

**<Filter Network/Server >**

This option is used to access the Filter Network/Server screen which allows the operator to establish network and server filtering for this remote unit. See *Filter Network/Server on page 5-35*, for more information.

**<Spanning Tree>**

Configures the global setup for using the Spanning Tree Algorithm as specified in the IEEE 802.1D specification. See *Spanning Tree on page 5-40*, for more information. Note: IP Mode must be set to <Bridged> for this option to display in the scrolled list.

## Security/Options

The purpose of this window is to define security information and miscellaneous options pertaining to this Router. The security portion of this window allows the setup of password or secret (depending on the chosen security protocol) that this remote device will use during the authentication process. Also the setup of authentication on the LAN of the Local Unit or a specified security server.

Authentication is a security process whereby the transmitting and receiving devices determine which security protocol to use during data transmission, as well as establish confirmation identity. This authentication process must match between the receiving and transmitting devices prior to actual data transmission, if the process fails, the link is terminated. The protocol used by the remote unit to authenticate the local unit and vice versa is defined in the LAN Profile.

1. Select **Configuration <Profile Directory>** from the **Main Menu**, and press **[ENTER]**.
2. Select **WAN <Setup ->** on the **RemoteUnit** line and press **[ENTER]**.

### Profile Directory Window

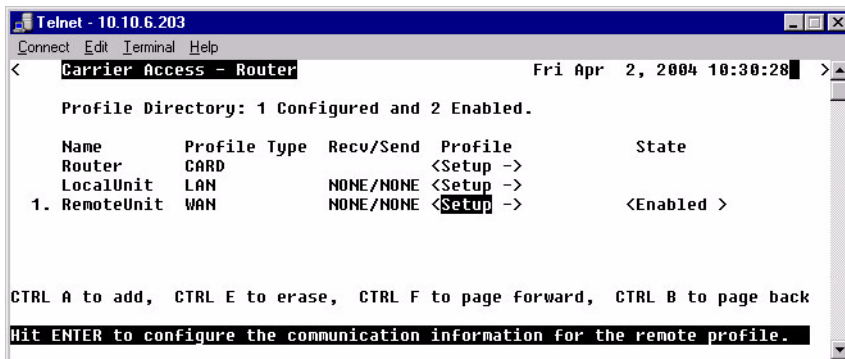



3. Tab down to **Setup:<Security/Options>** Scroll through the list of options with the [SPACEBAR] and select [ENTER].

**Remote Profile Window**



```
Telnet - 10.10.6.203
Connect Edit Terminal Help
< Carrier Access - Router Mon Apr 5, 2004 9:13:05 >
Profile Setup for (RemoteUnit )
Protocol Mode WAN Network Updates GRE Tunnel
IP <Route > <Never > <Disabled >
IPX <Blocked >
Other <Blocked >
NAT Gateway: <Disabled>
Numbered: WAN IP <NO >
Setup: <Security/Options > -> Setup: <Trunk Port > ->
Scrollable: Select the item to be set up and hit ENTER.
```

4. The following **Security/Options setup** window will display.

```
Telnet - 10.10.6.203
Connect Edit Terminal Help
< Carrier Access - Router Mon Apr 5, 2004 9:15:29 >
Security/Options Setup for remote RemoteUnit
Authentication by remote:
User ID: Local Profile Name LocalUnit
Authentication of remote: Protocol: NONE
User ID: <Remote Profile Name> RemoteUnit
Security Server: <Local >
Compression: <Disabled> Typical Data: <Easy to Compress>
Scrollable: Select User ID received from this remote unit.
```

## Security/Options Fields

### Authentication By Remote

#### User ID: Local Profile Name

This field displays the User ID of the Local Unit.

### Authentication of Remote

This fields defines the parameters the remote unit expects to receive from this local unit.

#### Protocol

This field displays the authentication protocol, if any, to be used by remote units when authenticating the local unit. The authentication protocol is defined on the Local (LAN) Security/SNMP window.

#### User ID

<**Remote Profile Name**> Displays the current Remote Profile name

<**Remote Custom Name**> User-defined name, up to 32 characters. This user ID is sent during the authentication process.

### Security Server

Displays the defined method as to where the remote device will be authenticated. This option is set in the **Router CARD Setup - > Security/SNMP** window.

### Compression

<**Enabled**> Will negotiate compression with a remote device.

<**Disabled**> If the remote device will not negotiate compression, leave this field as Disabled.

### Typical Data

This allows the data compression to be customized to the type of data on a given network.

<**Easy to Compress**>. If typical compression ratios are greater than 2/1, then this setting should achieve the best compression. This is the default.

<**Hard to Compress**> If compression ratios are less than 2/1.

## **Static/VPN Networks**

Static networks allow you to establish fixed, or pre-determined routes, which increases the control that you have over routing choices within your network. Although the Router is able to dynamically learn routing information through RIP packets, you may wish to disable this feature and manually enter fixed routes. Disable Learning by selecting the **<Never>** option in the **WAN Network Updates** field on the Remote (WAN) Profile Setup window. Static routing may be preferred if:

- Routers that are not configured to advertise, cannot utilize the automatic learning capabilities of the Router
- Advertising is disabled for security purposes
- Keeping routing tables small in order to increase LAN/WAN performance
- Advertising is disabled to decrease traffic on the LAN and across the WAN

Static routing may also be preferable when managing large networks. Often times it is easier to disable the learning mode and manually enter routes, rather than review each routing table entry and determine its advertising status.

As a static routing example, let's assume that we have three networks, A, B and C. Network B, is connected to Network C via a router, and to Network A via a Remote Unit. Network B may not learn of Network A's existence if advertising was disabled on Router 1. Therefore, if you wish to establish an entry in the routing table indicating a route between Network B and Network C, you can define a static route on Network B.

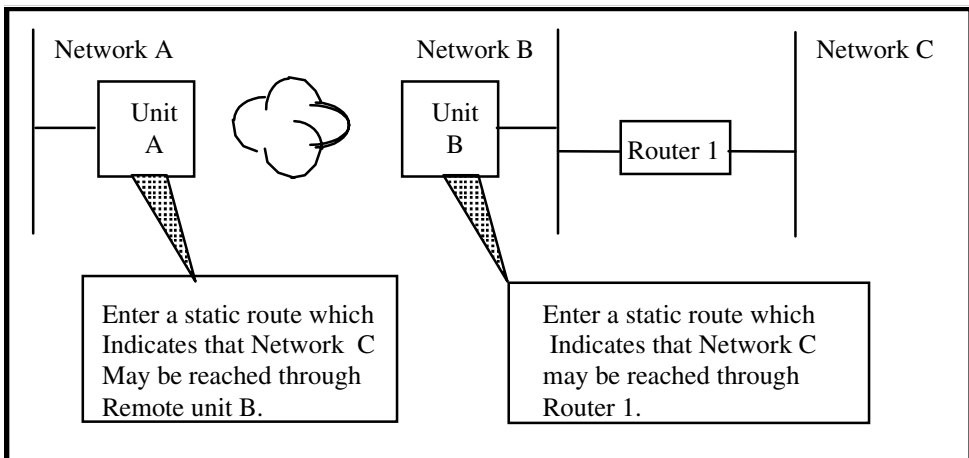

## ***Profile Directory:Remote Profile***

### *Static/VPN Networks*

---

To continue with this example, if Network B is not configured to advertise Network C to Network A, then Network A will not dynamically learn of Network C's existence. If you wish to establish a route on Network A to Network C, you must define a static route on Network A that indicates that Network C may be accessed through remote Adit B.

To set up a static route, you must define the following routing information:

- The address of the network you wish to reach;
- How far away from the local LAN the network is located (in terms of metric measurement or hops, depending on the protocol)
- Whether the network can be reached on the local LAN (via the LAN port) or through a remote Adit unit.

If you are using the local LAN, you will also need to define the address (either IP or MAC, depending on the protocol) of the first gateway (i.e. Adit or router) you will use to reach the network you are defining.

It is important to note that if the static network is reached via a Remote (WAN) Unit, it must be defined by choosing the **SETUP: <Static Networks>** option on the corresponding Remote (WAN) Profile Setup window. Static networks that are reached via the local LAN must be defined by choosing the **SETUP <Static Networks>** option on the Local (LAN) Profile Setup window.

---

**NOTE:** All static routes are considered filters and will be applied toward the maximum allowable number of 500 filters.

---

Depending on the GRE Tunnel field setting, the Static/VPN Networks window display fields are modified. The following displays two options.

### ***GRE Tunnel set to <All>***

1. Select **Configuration <Profile Directory>** from the **Main Menu**, and press [ENTER].
2. Select **WAN <Setup ->** on the **RemoteUnit** line and press [ENTER].
3. Set **GRE Tunnel** to **<All >**.
4. Select **Setup: <Static/VPN Networks>**, scroll with the [SPACEBAR] through the options and select [ENTER].

**Remote  
Profile  
Window**



```
Telnet - 10.10.6.203
Connect Edit Terminal Help
< Carrier Access - Router Mon Apr 5, 2004 10:57:56 >
Profile Setup for (RemoteUnit )
Protocol      Mode      WAN Network  GRE Tunnel
IP            <Route >  <Periodic > <All >
IPX          <Blocked >
Other        <Blocked >

IP Protocol  UPN Setup ->
NAT Gateway: <Disabled>
Local IP Tunnel Address: <Assigned by Remote>

WAN IP
Numbered:    <NO >

Setup: <Static/VPN Networks > ->   Setup: <Trunk Port > ->

Scrollable: Select the item to be set up and hit ENTER.
```

## Profile Directory:Remote Profile

### Static/VPN Networks

---

5. Press [CTRL A] to add a Static IP Network. Enter Network Address, Subnet Mask and Metric value. Note: this window displays additional fields depending on the field setting for GRE Tunnel (on the Remote Profile window).

#### Static/ VPN Networks Window

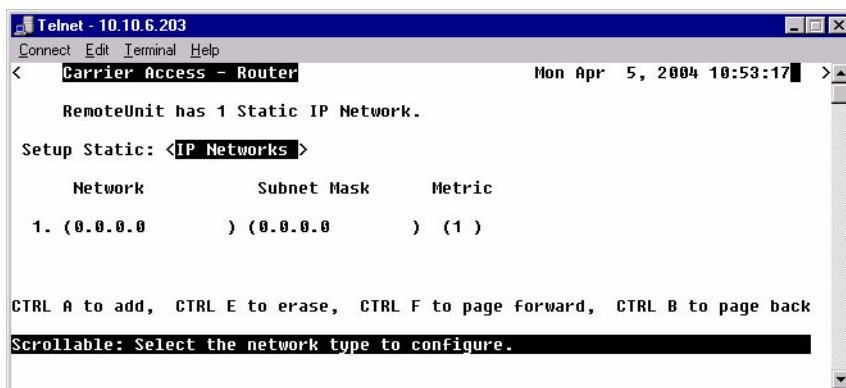

## Static/VPN Networks Fields

### Setup Static

<IP Networks> Enter the Subnet IP Address. Note: The host bits should all be zero.

<IPX Networks> Enter the Hexidecimal Address. Note: The host bits should all be zero.

### Network

Enter the Subnet IP Address. Note: The host bits should all be zero.

### Subnet Mask

Enter the Subnet Mask of the Network IP Address.

### Metric

Enter the distance, in hops, to the network. Value must be between 1-15.

### GRE Tunnel set to <By Network>

1. Select **Configuration <Profile Directory>** from the **Main Menu**, and press [ENTER].
2. Select **WAN <Setup ->** on the **RemoteUnit** line and press [ENTER].
3. Set **GRE Tunnel** to **<By Network >**.
4. Select **Setup: <Static/VPN Networks>**, scroll with the [SPACEBAR] to through the options and select [ENTER].

Remote  
Profile  
Window



```
Telnet - 10.10.6.203
Connect Edit Terminal Help
< Carrier Access - Router Mon Apr 5, 2004 11:10:27 >
Profile Setup for (RemoteUnit )
Protocol  Mode      WAN Network  GRE Tunnel
IP        <Route  >   <Periodic >  <By Network>
IPX       <Blocked>
Other     <Blocked>

NAT Gateway: <Disabled>
Local IP Tunnel Address: <Assigned by Remote>

Numbered:   WAN IP
            <NO  >

Setup: <Static/VPN Networks > ->   Setup: <Trunk Port   > ->
Scrollable: Select the item to be set up and hit ENTER.
```

## Profile Directory:Remote Profile

### Static/VPN Networks

---

5. Press [CTRL A] to add a Static IP Network. Enter Network Address, Subnet Mask and Metric value. Note: this window displays additional fields depending on the field setting for GRE Tunnel (on the Remote Profile window).

#### Static/ VPN Networks Window

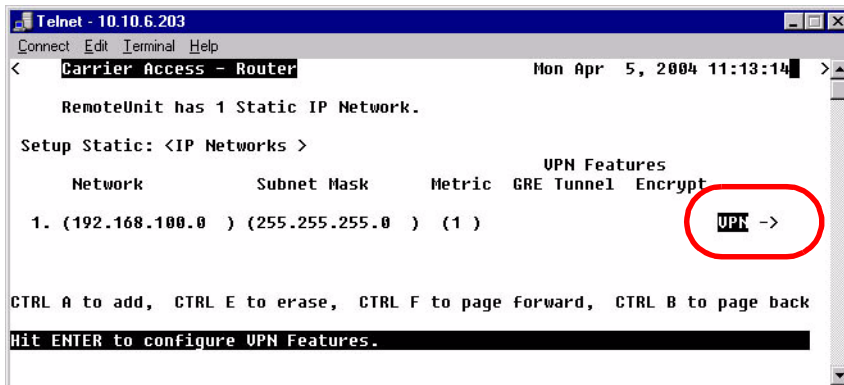

## Static/VPN Networks Fields

### Setup Static

<IP Networks> Enter the Subnet IP Address. Note: The host bits should all be zero.

<IPX Networks> Enter the Hexidecimal Address. Note: The host bits should all be zero.

### Network

Enter the Subnet IP Address. Note: The host bits should all be zero.

### Subnet Mask

Enter the Subnet Mask of the Network IP Address.

### Metric

Enter the distance, in hops, to the network. Value must be between 1-15.

### VPN Features

#### GRE Tunnel

Displays the Tunnel Name defined on the VPN setup window.

#### Encrypt

Not supported in this release.



## **VPN - >**

Opens the VPN Setup window.

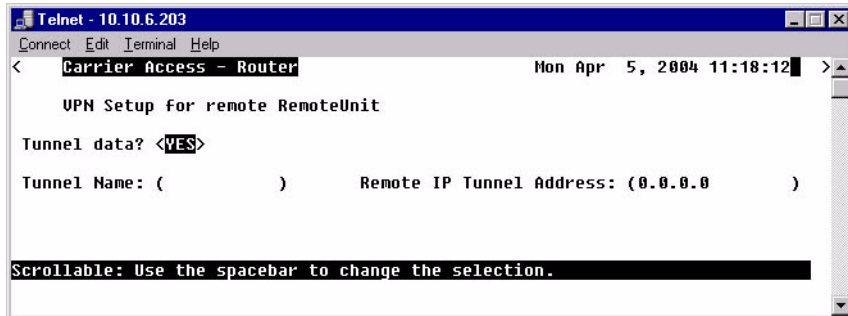

### **Tunnel Data ?**

<Yes> - Enables tunnel. Displays additional fields to setup.

<No> - Disables tunnel.

### **Tunnel Name**

Enter Tunnel name, up to 11 characters.

### **Remote IP Tunnel Address**

Enter the IP address of the far end of the tunnel, in the form xxx.xxx.xxx.xxx, where xxx is between 0-255.

## Static NAT Addresses

Use this window to configure Static Bi-directional NAT mappings between local server addresses and public addresses.

---

**NOTE:** Each static NAT address filter will count toward the maximum number of 500 filters.

---

1. Select **Configuration <Profile Directory>** from the **Main Menu** and press **[ENTER]**.
2. Select **WAN <Setup ->** on the **RemoteUnit** line and press **[ENTER]**.

### Profile Directory Window

```
Telnet - 10.10.6.203
Connect Edit Terminal Help
< Carrier Access - Router                               Fri Apr 2, 2004 18:30:28 >
Profile Directory: 1 Configured and 2 Enabled.

Name      Profile Type  Recv/Send  Profile      State
Router    CARD          NONE/NONE  <Setup ->
LocalUnit LAN          NONE/NONE  <Setup ->
1. RemoteUnit WAN      NONE/NONE  <Setup ->  <Enabled >

CTRL A to add, CTRL E to erase, CTRL F to page forward, CTRL B to page back
Hit ENTER to configure the communication information for the remote profile.
```

3. Select **Setup: <Static NAT Addresses>**, scroll through the list of options with the [SPACEBAR] if <Static NAT Addresses> is not displayed. Press [ENTER].

**Remote Profile Window**



```
Telnet - 10.10.6.203
Connect Edit Terminal Help
< Carrier Access - Router Mon Apr 5, 2004 12:09:33 >
Profile Setup for (RemoteUnit )
Protocol Mode WAN Network Updates GRE Tunnel
IP <Route > <Periodic > <By Network>
IPX <Blocked >
Other <Blocked >
NAT Gateway: <Disabled>
Local IP Tunnel Address: <Assigned by Remote>
Numbered: WAN IP <NO >
Setup: <Static NAT Addresses > -> Setup: <Trunk Port > ->
Scrollable: Select the item to be set up and hit ENTER.
```

4. Press [CTRL A] to add a Static NAT Address.

**Static Addresses Window**

```
Telnet - 10.10.6.203
Connect Edit Terminal Help
< Carrier Access - Router Mon Apr 5, 2004 12:12:01 >
RemoteUnit has 1 Static NAT Address List.
Local IP Address NAT IP Address
1. (0.0.0.0) (0.0.0.0)
CTRL A to add, CTRL E to erase
Editable: Enter a non-zero IP Address/Subnet Mask in Dotted Decimal Notation.
```

### **Local IP Address**

Enter the IP Address of the local device.

### **NAT IP Address**

Enter the NAT IP Address of the desired device.

## **NAT Bypass Subnets**

Use this window to define NAT Bypass Subnets which will create a list of source addresses that will not be subject to NAT translation when passing through a NAT enabled WAN interface.

1. Select **Configuration <Profile Directory>** from the **Main Menu**, and press **[ENTER]**.
2. Select **WAN <Setup ->** on the **RemoteUnit** line and press **[ENTER]**.

**Profile  
Directory  
Window**

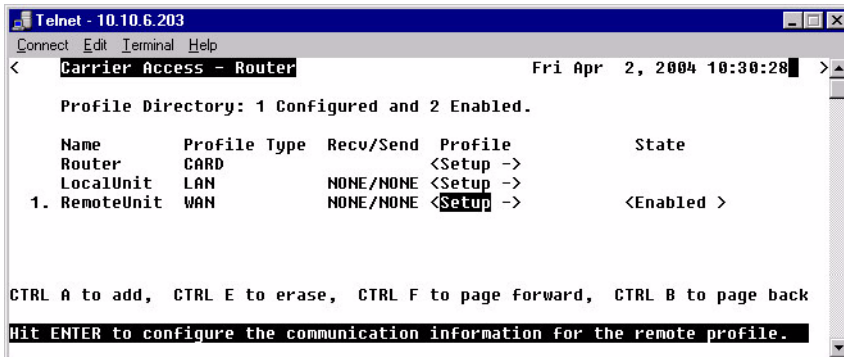

3. Select **Setup: <NAT Bypass Subnets >**, scroll through the list of options with the [SPACEBAR] if <Static Addresses> is not displayed. Press [ENTER].

NAT Bypass  
Subnets  
Window



```
Telnet - 10.10.6.203
Connect Edit Terminal Help
< Carrier Access - Router Mon Apr 5, 2004 12:15:10 >
Profile Setup for (RemoteUnit )
Protocol Mode WAN Network Updates GRE Tunnel
IP <Route > <Never > <All >
IPX <Blocked >
Other <Blocked >
NAT Gateway: <Disabled>
WAN IP
Numbered: <NO >
Setup: <Static NAT Addresses > -> Setup: <Trunk Port > ->
Scrollable: Select the item to be set up and hit ENTER.
```

4. Press [CTRL A] to add a NAT Bypass.

NAT Bypass  
Setup  
Window

```
Telnet - 10.10.6.203
Connect Edit Terminal Help
< Carrier Access - Router Mon Apr 5, 2004 12:18:07 >
RemoteUnit has 1 NAT ByPass Record.
Network Subnet Mask
1. (0.0.0.0 ) (0.0.0.0 )
CTRL A to add, CTRL E to erase
Editable: Enter a non-zero IP Address/Subnet Mask in Dotted Decimal Notation.
```

## Network

An IP address or host to bypass the NAT Translation, in the form of xxx.xxx.xxx.xxx, where xxx is between 0-255.

## Subnet Mask

Subnet mask of the Network IP address above, in the form of xxx.xxx.xxx.xxx, where xxx is between 0-255.

## **Static Addresses**

Use this screen to define static addresses that are based on the Ethernet MAC or IP Address of a specific device on the local LAN. Typically, the Router would learn of these devices by monitoring LAN/WAN packets. By defining a static address, you are telling the Router the location of the corresponding device before the Router learns where this device resides. Static addresses are typically used in a bridging situation.

Use the Local (LAN) Profile to define static addresses for devices that are located on the LAN. If you wish to establish static addresses for devices on remote LAN's, access this screen using the corresponding Remote (WAN) Profile.

---

**NOTE:** Each static address filter will count toward the maximum number of 500 filters.

---

1. Select **Configuration <Profile Directory>** from the **Main Menu**, and press **[ENTER]**.
2. Select **WAN <Setup ->** on the **RemoteUnit** line and press **[ENTER]**.

**Profile  
Directory  
Window**

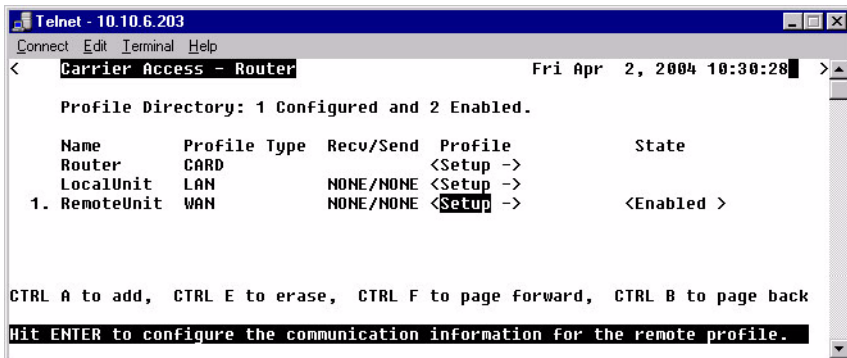

```
Telnet - 10.10.6.203
Connect Edit Terminal Help
< Carrier Access - Router                               Fri Apr 2, 2004 10:30:28 >
Profile Directory: 1 Configured and 2 Enabled.
Name      Profile Type  Recv/Send  Profile      State
Router    CARD          <Setup ->
LocalUnit LAN          NONE/NONE  <Setup ->
1. RemoteUnit WAN        NONE/NONE  <Setup ->  <Enabled >

CTRL A to add, CTRL E to erase, CTRL F to page forward, CTRL B to page back
Hit ENTER to configure the communication information for the remote profile.
```

3. Select **Setup: <Static Addresses >**, scroll through the list of options with the [SPACEBAR] if <Static Addresses> is not displayed. Press [ENTER].

Remote Profile Window



```
Telnet - 10.10.6.203
Connect Edit Terminal Help
< Carrier Access - Router Mon Apr 5, 2004 12:44:21 >

Profile Setup for (RemoteUnit )

Protocol Mode WAN Network Updates GRE Tunnel
IP <Route > <Never > <All >
IPX <Blocked >
Other <Blocked >

IP Protocol UPN Setup ->
NAT Gateway: <Disabled>
Local IP Tunnel Address: <Assigned by Remote>

Numbered: WAN IP <NO >

Setup: <Static Addresses > -> Setup: <Trunk Port > ->

Scrollable: Select the item to be set up and hit ENTER.
```

4. Select **Setup: <Static Addresses >**, scroll through the list of options with the [SPACEBAR] if <Static Addresses> is not displayed. Press [ENTER].

Static Addresses Window (MAC Address)

```
Telnet - 10.10.6.203
Connect Edit Terminal Help
< Carrier Access - Router Mon Apr 5, 2004 12:56:38 >

RemoteUnit has 1 Static MAC Address Record.

Setup Static: <MAC Address ->

Device Name MAC Address
1. ( ) (00-00-00-00-00-00)

CTRL A to add, CTRL E to erase, CTRL F to page forward, CTRL B to page back

Editable: Enter a name for the filter.
```

## Profile Directory:Remote Profile

### Static Addresses

---

#### Static Addresses Window (IP Address)

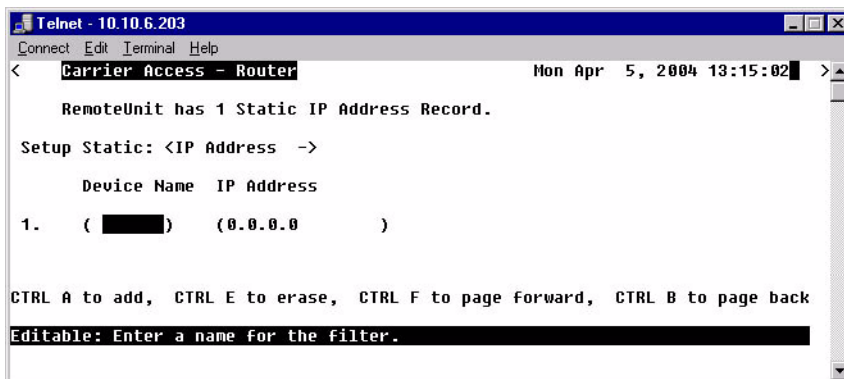

### Static Addresses Fields

#### Setup Static

<IP Address> - To setup a static IP address.

<MAC Address> - To setup a static MAC address.

#### Device Name

A user-defined name of the LAN device that is associated with this static address. Up to 7 characters is allowed for this field.

#### MAC Address

Enter the MAC Address of the desired device. If the static address is configured through the Local (LAN) Profile Setup screen, the device can be reached via the local LAN. If the static address is configured on a specific Remote (WAN) Profile screen, the device can be reached via that specific remote. This field is only available if the **Setup Static** field is set to <MAC Address>.

#### IP Address

Enter the IP Address of the desired device. If the static address is configured through the Local Profile Setup screen, the device can be reached via the local LAN. If the static address is configured on a specific Remote (WAN) Profile screen, the device can be reached via that specific remote. This field is only available if the **Setup Static** field is set to <IP Address>.



## Firewall Filters

A firewall is a method for keeping a network secure from intruders, by using filters to block the transmission of certain types of (service) traffic. Once created, firewalls are a security feature that allows only certain types of services to pass in and/or out of your LAN. Firewalls can be created on a per remote basis. Each filter consists of a set of drop/pass rules which are applied in the order in which they appear on the list — in other words, rule 1 is applied before rule 2 and so on. This set of rules constitutes a filter for a specific remote profile and will be applied to that profile's incoming or outgoing, or both traffic types (service flaws).

### Firewall Rules Window

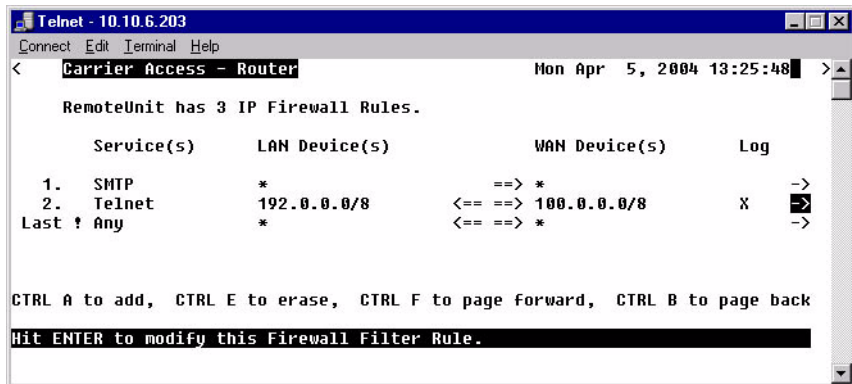

Fields	
#	Rule Number
!	Pass (no ! (blank) indicates Drop)
Services(s)	Lists current service defined
LAN Device(s)	Lists LAN defined for this rule (* indicates any)
==>	Outgoing
<==	Incoming
<== ==>	Outgoing and incoming
WAN Device(s)	Lists WAN defined for this rule (* indicates any)
Log	X = Logged in the Event or Alarm log

## Profile Directory:Remote Profile

### Firewall Filters

#### To Add a Firewall Filter:

**WARNING!** THE ADDITION OF THE FIRST FIREWALL RULE WILL AUTOMATICALLY SECURE THE UNIT AGAINST ACCESS VIA TELNET (UNLESS THE FIRST RULE EXPRESSLY PERMITS TELNET). TO ENSURE THE ABILITY TO TELNET INTO THE UNIT BY AT LEAST ONE REMOTE DEVICE, YOU MUST CREATE A RULE INDICATING WHICH DEVICE HAS TELNET ACCESS.

1. On the **Main Menu**, press [TAB] until **Configuration <Profile Directory>** is highlighted, and press [ENTER].
2. Select **WAN <Setup ->** on the **RemoteUnit** line and press [ENTER].

#### Profile Directory Window

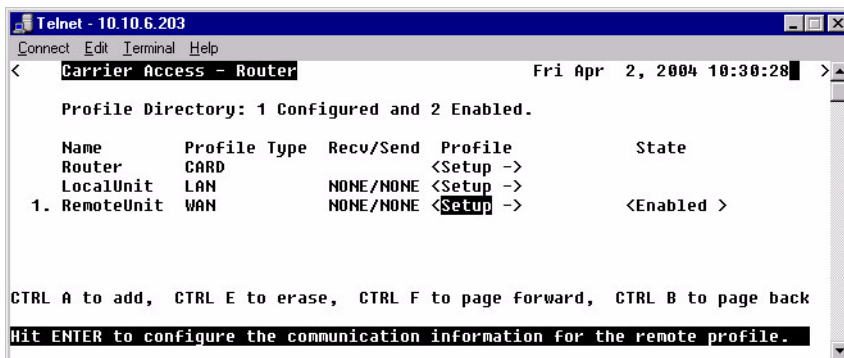

```
Telnet - 10.10.6.203
Connect Edit Terminal Help
< Carrier Access - Router                               Fri Apr 2, 2004 10:30:28 >
Profile Directory: 1 Configured and 2 Enabled.
Name      Profile Type  Recv/Send  Profile      State
Router    CARD          NONE/NONE  <Setup ->
LocalUnit LAN          NONE/NONE  <Setup ->
1. RemoteUnit WAN      NONE/NONE  <Setup ->  <Enabled >

CTRL A to add, CTRL E to erase, CTRL F to page forward, CTRL B to page back
Hit ENTER to configure the communication information for the remote profile.
```

3. Tab down to **Setup: <Firewall Filters>** scroll through the list of options with the [SPACEBAR] if <Firewall Filters> is not displayed. Press [ENTER].

**Remote Profile Window**



```

Telnet - 10.10.6.203
Connect Edit Terminal Help
< Carrier Access - Router Mon Apr 5, 2004 13:20:55 >

Profile Setup for (RemoteUnit )

Protocol      Mode      WAN Network Updates      GRE Tunnel
IP            <Route > <Never >    <All >
IPX          <Blocked >
Other        <Blocked >

IP Protocol UPN Setup ->
NAT Gateway: <Disabled>
Local IP Tunnel Address: <Assigned by Remote>

WAN IP
Numbered:    <NO >

Setup: <Firewall Filters > -> Setup: <Trunk Port > ->

Scrollable: Select the item to be set up and hit ENTER.
    
```

4. Press [CTRL A] to add an IP Firewall Rule.

**Firewall Filters Window**

```

Telnet - 10.10.6.203
Connect Edit Terminal Help
< Carrier Access - Router Mon Apr 5, 2004 13:25:48 >

RemoteUnit has 3 IP Firewall Rules.

Service(s)      LAN Device(s)      WAN Device(s)      Log
1. SMTP          *                   ==> *               ->
2. Telnet        192.0.0.0/8        <== ==> 100.0.0.0/8        X   <->
Last ? Any      *                   <== ==> *               ->

CTRL A to add, CTRL E to erase, CTRL F to page forward, CTRL B to page back
Hit ENTER to modify this Firewall Filter Rule.
    
```

5. Enter the parameters of the rule, press [ESC] to close the window and save the configuration. See *page 5-32* for a description of all fields for the Firewall Setup window.

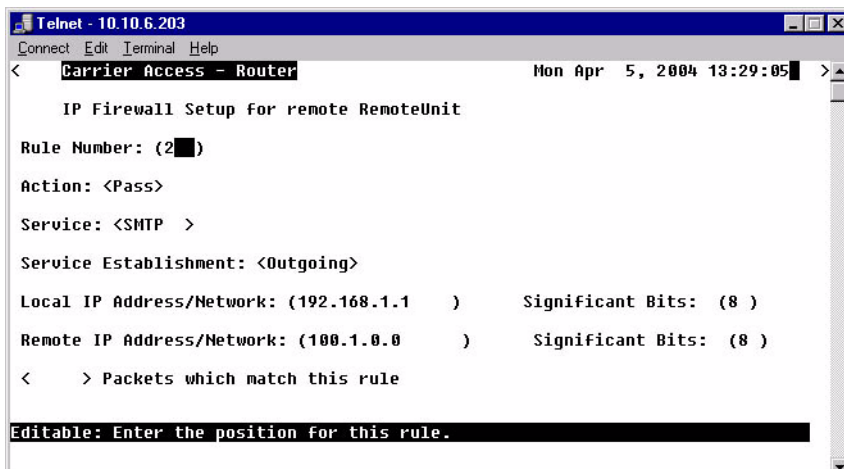

```
Telnet - 10.10.6.203
Connect Edit Terminal Help
< Carrier Access - Router Mon Apr 5, 2004 13:29:05 >
IP Firewall Setup for remote RemoteUnit
Rule Number: (2)
Action: <Pass>
Service: <SMTP >
Service Establishment: <Outgoing>
Local IP Address/Network: (192.168.1.1 ) Significant Bits: (8 )
Remote IP Address/Network: (100.1.0.0 ) Significant Bits: (8 )
< > Packets which match this rule
Editable: Enter the position for this rule.
```

## Firewall Filters Fields

### Rule Number

The rule number defines the order in which the rules are applied. Once there is two or more rules created, the rule number can be changed to put them in the desired order. The **Last!** rule displayed, is automatically set after the first rule is defined, and states that the Router should drop any service (incoming or outgoing) which has not been addressed in the proceeding rules.

### Action: (Pass/Drop)

This column indicates the service(s) that will **<Pass>** or **<Drop>** from the local network to the remote network and vice versa. On the Firewall Filters window the following indicated Pass/Drop:

! in this column = Drop                  Blank column = Pass

Typically, rules are established with the **Pass** action, since the last rule (which is automatically defined by the software) **Drops** all services not expressly permitted by the previous rule(s). For example, if you wish to deny all transmissions except Telnet, you would create a rule indicating that Telnet has the **Pass** action. The Router software would create the last rule that states the unit should **Drop** all other services.

Since any service that is not expressly permitted to pass will be prohibited, it is important that you thoroughly understand the security policies of your WAN before attempting to create a firewall. We suggest that only experienced Network Administrators create and maintain firewall filters. Incorrectly defined filters may compromise the security and functionality of your WAN.

## Service

This field displays the service that this particular rule affects. The most common services have been pre-defined however, there are a select few options where you may further define the service to be filtered.

Name	Description
Finger	Display information about users
FTP	File Transfer Protocol
Gopher	Document search and retrieval
HTTP	World Wide Web
ICMP	Internet Control Message
	Equal = number between 0-65535
	Range = Start Number (0-65535) End Number (0-65535)
NUM	IP protocol number to be specified, see <i>Protocol Number in Firewall Filters on page B-2</i> for a list of these Protocols and the assigned number.
	Protocol Number = number between 1-255
NNTP	Network News Transfer
Ping	ICMP echo request/reply
POP3	Post Office Protocol Version 3
SMTP	Simple Mail Transfer
SNMP	Simple Network Management Protocol
TCP	Transmission Control Protocol
	Equal = number between 0-65535
	Range = Start Number (0-65535) End Number (0-65535)
Telnet	User interface to remote unit
UDP	User Datagram Protocol
WAIS	Wide Area Information Services

## Service Establishment

Use this field to establish the transmission direction that will be affected by this rule.

- Incoming** All session establishments coming from the remote which match the value in the Service field, will adhere to the value in the Action field.
- Outgoing** All transmissions outbound from the LAN toward this remote which match the value in the Service field, will adhere to the value in the Action field.
- In/Out** Will affect both incoming and outgoing transmissions.

#### Local IP Address/Network

Enter the IP Address of the local device or network that this rule will affect. If you enter the address of a local device, this rule will affect only the session establishments of the local device and the destination address entered in the **Remote IP Address/Network** field, below. If this rule is to affect “any” local devices/networks, leave this field with an asterisk default symbol \*.

##### Significant Bits

Use this field to identify the number of bits, from left to right that will be used to match the IP Address field within the data packet with the value entered into the **Local IP Address/Network**. Range is between 1-32.

#### Remote IP Address/Network

Enter the IP Address of the remote device or network that this rule will affect. If you enter the address of a remote device, this rule will affect only the session establishments of the remote device and the device/network address entered in the **Local IP Address/Network** field, above. If this rule is to affect “any” remote devices/networks, leave this field at the default symbol \*.

##### Significant Bits

Use this field to identify the number of bits, from left to right, that will be used to match the IP Address field within the data packet with the value entered into the **Remote IP Address/Network**. Range is between 1 to 32.

#### < > Packets which match this rule

Use this field to indicate whether a rule match should trigger an Alarm or Log entry.

- |                |   |
|----------------|---|
| <b>(Blank)</b> | A transmission match will not trigger an Alarm or Events log entry. |
| <b>Alarm</b>   | A transmission match will trigger an Alarm entry.                   |
| <b>Log</b>     | A transmission match will trigger an Events log entry.              |

Log or Alarm entries may also be useful when a specific security issue is at stake. For example, if your security policy does not permit Telnetting, you may wish to keep track of all Telnet attempts. As a general rule, however, we do not recommend keeping a log of all rule matches since this may impact system performance and may cause an Event or Alarm screen overflow.

---

**NOTE:** When enabled, a single event/alarm will be logged for all TCP session initiations. An event/alarm will be logged for each packet for all UDP transfers. UDP traffic should typically not be allowed across a firewall.

---

**NOTE:** All firewall rules are considered filters and will be applied toward the maximum allowable number of 500 filters.

---

## Filter Network/Server

This screen allows you to filter the Remote (WAN) networks/servers in two ways, depending on which mode is selected. The **<Filter>** mode causes the unit to learn all networks/services on known networks, and then advertise these services to the LAN.

In the **<Learn>** mode the unit will disable or restrict learning of networks/services. Under this mode, services will only be learned if they are selected or added. For example, when you enter the current screen, all known networks/services will be displayed, since the **<Filter>** mode is the default mode. If you wish to restrict which services are learned you may change the **Selected Items** field to **<Learn>** and then enable only selected services displayed on the screen. Once you exit this screen and save the changes, only those services that you enabled and/or added will be learned and displayed.

Since the **<Filter>** mode learns all services, it may be most appropriate for smaller networks. The **<Learn>** mode however, may be best for larger networks since it allows you to restrict which types of services are learned.

1. Select **Configuration <Profile Directory>** from the **Main Menu**, and press **[ENTER]**.
2. Select **WAN <Setup ->** on the **RemoteUnit** line and press **[ENTER]**.

### Profile Directory Window

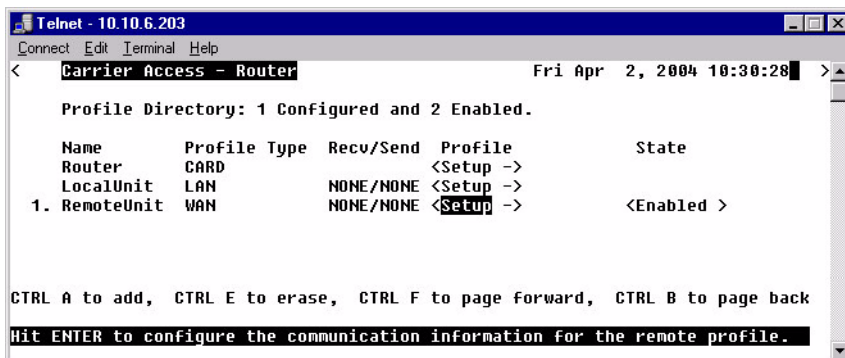

```
Telnet - 10.10.6.203
Connect Edit Terminal Help
< Carrier Access - Router                               Fri Apr 2, 2004 10:30:28
Profile Directory: 1 Configured and 2 Enabled.

Name      Profile Type  Recv/Send  Profile      State
Router    CARD          NONE/NONE  <Setup ->
LocalUnit LAN          NONE/NONE  <Setup ->
1. RemoteUnit WAN      NONE/NONE  <Setup ->  <Enabled >

CTRL A to add, CTRL E to erase, CTRL F to page forward, CTRL B to page back
Hit ENTER to configure the communication information for the remote profile.
```

## Profile Directory:Remote Profile

### Filter Network/Server

3. Tab down to **Setup: <Security/Options>** and scroll with the [SPACEBAR] to **<Filter Network/Server>**. Press [ENTER].

Remote  
Profile  
Window



```
Telnet - 10.10.6.203
Connect Edit Terminal Help
< Carrier Access - Router Mon Apr 5, 2004 13:33:56 >
Profile Setup for (RemoteUnit )

Protocol Mode WAN Network Updates GRE Tunnel
IP <Route > <Never > <All >
IPX <Blocked >
Other <Blocked >

IP Protocol UPN Setup ->
NAT Gateway: <Disabled>
Local IP Tunnel Address: <Assigned by Remote>

Numbered: WAN IP <NO >

Setup: <Filter Network/Server > -> Setup: <Trunk Port > ->

Scrollable: Select the item to be set up and hit ENTER.
```

4. Select with the [SPACEBAR] **<IP Networks>**, **<IPX Networks>** or **<IPX Servers>**. [TAB] to the **Selected Items** field.

Filter  
Network/  
Server

```
Telnet - 10.10.6.203
Connect Edit Terminal Help
< Carrier Access - Router Mon Apr 5, 2004 13:36:02 >
RemoteUnit has 1 configured and learned IP Network.

Setup: <IP Networks > <Filter> Selected Items
Network Filter
1. Static Fltr 192.168.100.0 [ ]

CTRL F to page forward, CTRL B to page backward
Scrollable: Select the Network/Server type to configure.
```



5. Select <Learn> or <Filter> and press [ENTER].

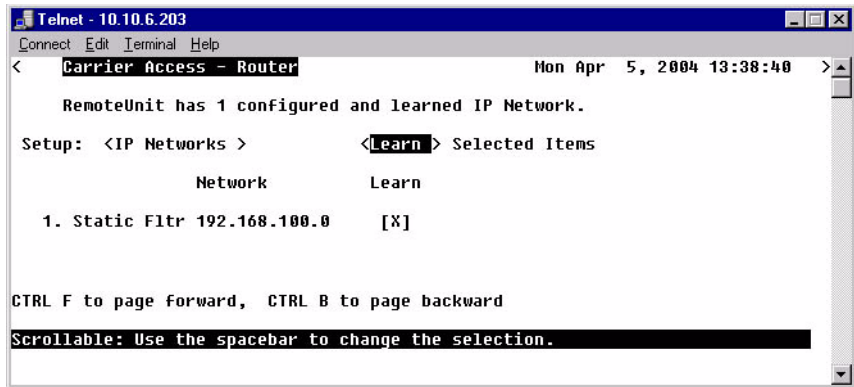

6. To Manually configure a service (with <IPX Servers> only), select [CTRL A] to add a Filter.

## Filter Network/Server Fields

### Setup

Use this field to identify which networks or server types you wish to review and filter.  
<IP Networks>, <IPX Networks> or <IPX Servers>

### Selected Items (Filter/Learn)

<Filter> (default) The Router will learn all networks/servers and advertise them to the LAN. This mode is particularly useful for small networks with few items to be learned/advertised. Customize the advertised networks/servers in one of two ways; <Learn> or [CTRL A]

<Learn> Under this mode, learning and advertising are disabled until a specific server type is selected from the displayed servers or is manually added. The <Learn> mode is much better suited for larger networks, as specifying which networks/servers you wish the Router to learn may consume less filters than specifying which networks/servers you **Do Not** want learned.

[CTRL A] keys to manually configure a service to be filtered or learned. When manually configuring a service, the following prompt is displayed. You *must* define a server type, however the corresponding server name may be left blank. If a server name is not defined, all services of the specified type will be learned, regardless of the name.

## Profile Directory:Remote Profile

### Filter Network/Server

---

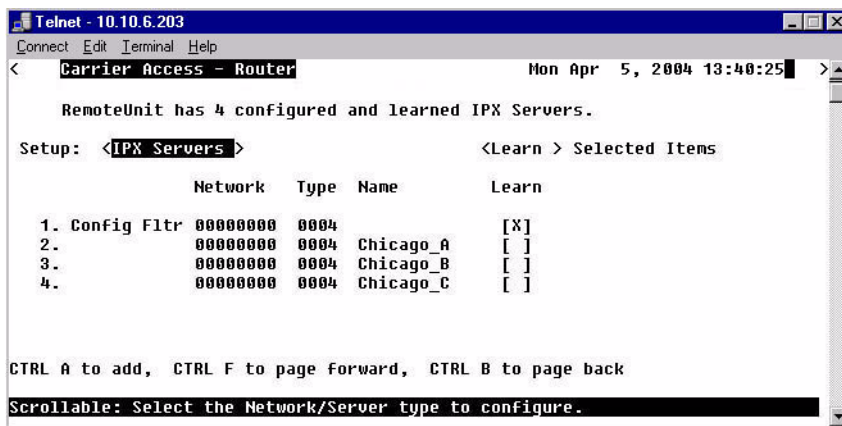

```
Telnet - 10.10.6.203
Connect Edit Terminal Help
< Carrier Access - Router Mon Apr 5, 2004 13:40:25 >
RemoteUnit has 4 configured and learned IPX Servers.
Setup: <IPX Servers> <Learn> Selected Items
      Network  Type  Name      Learn
1. Config Fltr 00000000 0004      [X]
2.              00000000 0004 Chicago_A [ ]
3.              00000000 0004 Chicago_B [ ]
4.              00000000 0004 Chicago_C [ ]
CTRL A to add, CTRL F to page forward, CTRL B to page back
Scrollable: Select the Network/Server type to configure.
```

---

**NOTE:** The server type 0004 was selected to be advertised to the LAN, therefore all 0004 type servers will be advertised and do not need to be individually selected (lines 2 through 4).

---

If the server type and name are specified, only servers that match both values will be learned or filtered. Be aware that the **Name** value is case and spacing sensitive.

### Network

This field displays the network address of each service/network learned from the remote unit. If this route was added using the **Static Network** screen, “Static Fltr” will appear before the network address of this entry.

### Type

This field is only available when the **Setup** field is set to <IPX Servers>. The **Type** field displays the Hex value assigned to each known server. When a service is added using [CTRL A], a Hex value must be defined. If you wish to learn or filter certain services that match a particular server type, manually add an entry specifying the desired Hex value. This setting will enable the unit to learn or filter all services that match the specified service type. This field may be used in conjunction with the **Name** field, described below. Range 1-FFFF.

## **Name**

This field displays the first 11 characters of the name of each known network/server. If a server is manually added and a server name is not defined, all servers matching the added type will be learned and the first 11 characters of their names will be displayed. If both the server name and type are defined when the server is manually added then only servers matching both criteria will be learned.

## **Filter [ ]**

This field will change depending on the value set in the **Selected Items** field. Use the **[SPACEBAR]** to place and **X** in this field to choose that the Router will **Filter** the chosen network or server.

## **Learn [ ]**

This field will change depending on the value set in the **Selected Items** field. Use the **[SPACEBAR]** to place and **X** in this field to choose that the Router will **Learn** the chosen network or server.

## Spanning Tree

**NOTE:** This option does not display on the **Remote WAN Profile Setup**, until the **Router CARD profile/Spanning Tree is enabled AND the Remote Profile is set to <Bridge>**.

The Spanning Tree configures the setup for the Spanning Tree Algorithm.

### To Configure Spanning Tree:

1. Select **Configuration <Profile Directory>** from the **Main Menu**, and press [ENTER].
2. Select **WAN <Setup ->** and press [ENTER].

### Profile Directory Window

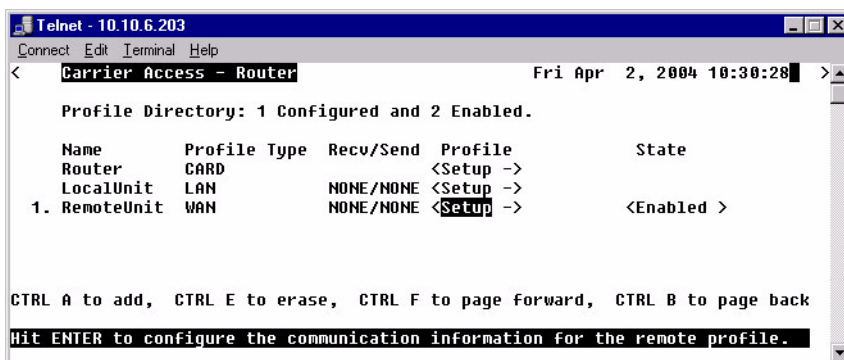

```
Telnet - 10.10.6.203
Connect Edit Terminal Help
< Carrier Access - Router                               Fri Apr 2, 2004 10:30:28 >
Profile Directory: 1 Configured and 2 Enabled.
Name      Profile Type  Recv/Send  Profile      State
Router    CARD          <Setup ->
LocalUnit LAN          NONE/NONE <Setup ->
1. RemoteUnit WAN      NONE/NONE <Setup -> <Enabled >

CTRL A to add, CTRL E to erase, CTRL F to page forward, CTRL B to page back
Hit ENTER to configure the communication information for the remote profile.
```

3. Select **Setup: <Spanning Tree >** and press [ENTER].

**NOTE:** Spanning Tree is only available in the Setup: Menu when the IP Protocol Mode is set to <Bridge>.

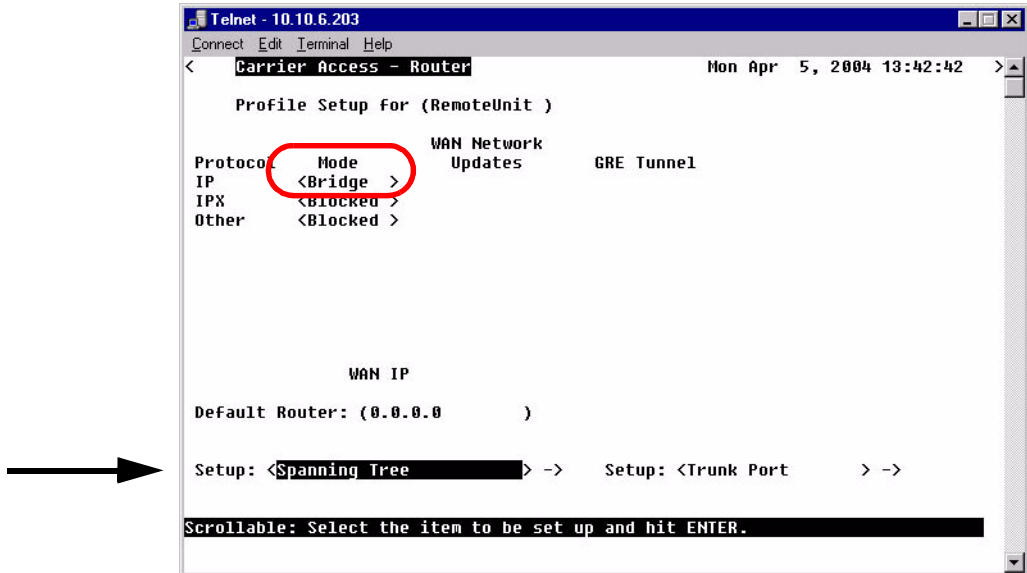

4. To enable **Spanning Tree**, scroll <Disabled> to <Enabled>, with the [SPACEBAR], press [ENTER].

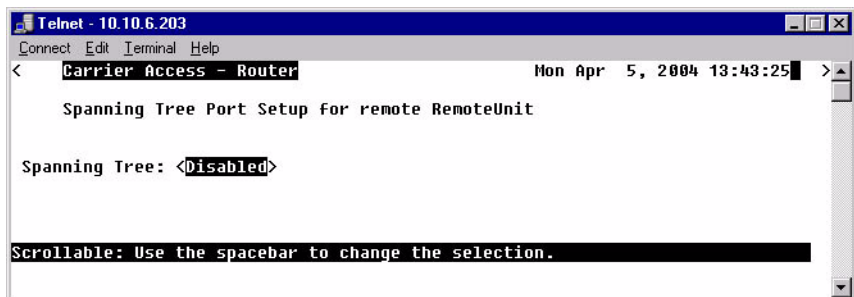

## Profile Directory:Remote Profile

### Spanning Tree

---

5. Enter the appropriate data in the following fields.

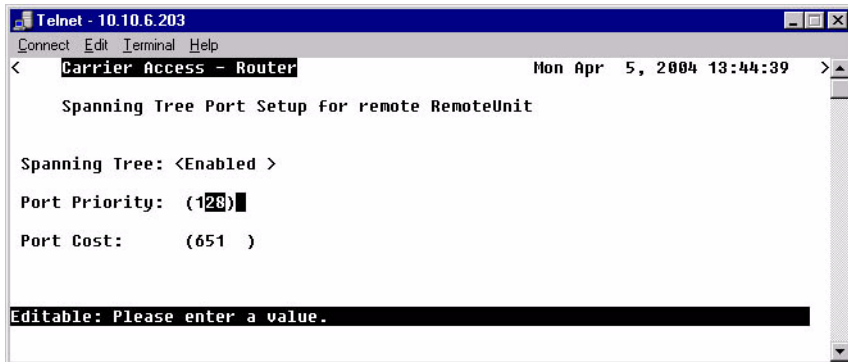

#### Port Priority

The Port Priority value can range from 0 to 255, with a default of 128.

#### Port Cost

The Port Priority value can range from 0 to 65535, with a default of 651.

## Trunk Port

Use this screen to define the Router Interface.

1. On the **Main Menu**, press [TAB] until **Configuration <Profile Directory>** is highlighted.
2. Select **WAN <Setup ->** on the RemoteUnit line and press [ENTER].

### Profile Directory Window

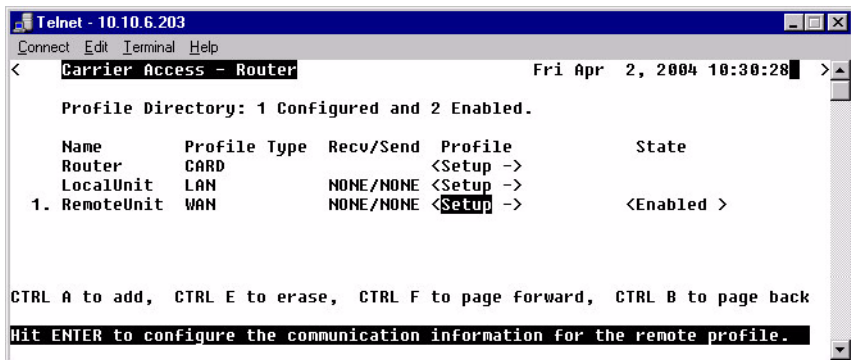

```
Telnet - 10.10.6.203
Connect Edit Terminal Help
< Carrier Access - Router                               Fri Apr  2, 2004 10:30:28 >
Profile Directory: 1 Configured and 2 Enabled.

Name      Profile Type  Recv/Send  Profile      State
Router    CARD          <Setup ->
LocalUnit LAN          NONE/NONE  <Setup ->
1. RemoteUnit WAN      NONE/NONE  <Setup ->  <Enabled >

CTRL A to add, CTRL E to erase, CTRL F to page forward, CTRL B to page back
Hit ENTER to configure the communication information for the remote profile.
```

## Profile Directory:Remote Profile

### Trunk Port

3. Select **Setup:<Trunk Port>** and press [ENTER].

#### Remote Profile Window

```
Telnet - 10.10.6.203
Connect Edit Terminal Help
< Carrier Access - Router Mon Apr 5, 2004 13:46:00 >
Profile Setup for (RemoteUnit)

Protocol      Mode      WAN Network Updates      GRE Tunnel
IP            <Route >  <Never >   <Disabled >
IPX          <Blocked >
Other        <Blocked >

NAT Gateway: <Disabled>

Numbered:     WAN IP
              <NO >

Setup: <Security/Options > -> Setup: <Trunk Port > ->
Scrollable: Select the item to be set up and hit ENTER.
```

4. Select the WAN Port Number by scrolling the <None> to the desired WAN.  
**Note: Only WANs that are setup will display here.**

#### WAN Port Setup Window

```
Telnet - 10.10.6.203
Connect Edit Terminal Help
< Carrier Access - Router Mon Apr 5, 2004 13:59:42 >
WAN Port Setup for remote RemoteUnit

Connection  WAN Connection Type  DLCI

Select WAN Port Number: <None>
Scrollable: Use the spacebar to change the selection.
```



5. Set DLCI value (range is 16 - 1022).

**WAN Port  
Setup  
Window**

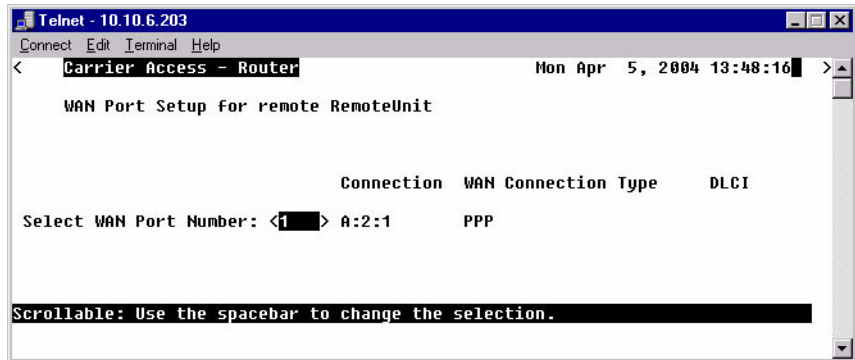

**Select WAN Port Number**

Scroll through the available WAN port selections.

**Connection**

Displays the connection for the selected WAN Port.

**WAN Connection Type**

Displays the WAN Connection Type for the selected WAN Port.

**DLCI**

Displays the DLCI for the selected WAN Port.

## ***Profile Directory:Remote Profile***

*Trunk Port*

---

# CHAPTER 6

---

## ***Basic Configuration***

### **In this Chapter**

- Overview
- Start Basic Configuration
- Router Identification
- Routing Protocol/Security
- WAN Interface Connections
- Remote Unit Profile
- SNMP Configuration
- Setup Complete

## Basic Configuration

### Overview

---

## Overview

The Basic Configuration is designed to walk the user through all the Basic Setup to operate the Router effectively. This feature can be used at any time, to initially setup the Router, or to change the configuration of the Router. As setup information is entered and the Enter button is selected, the next setup item will appear.

ESC will exit this setup program at any time.

ENTER will move to the next page or enter the information into the system.

## Start Basic Configuration

1. Select **Configuration: <Basic Config > ->** from the Router Main menu and press [ENTER].

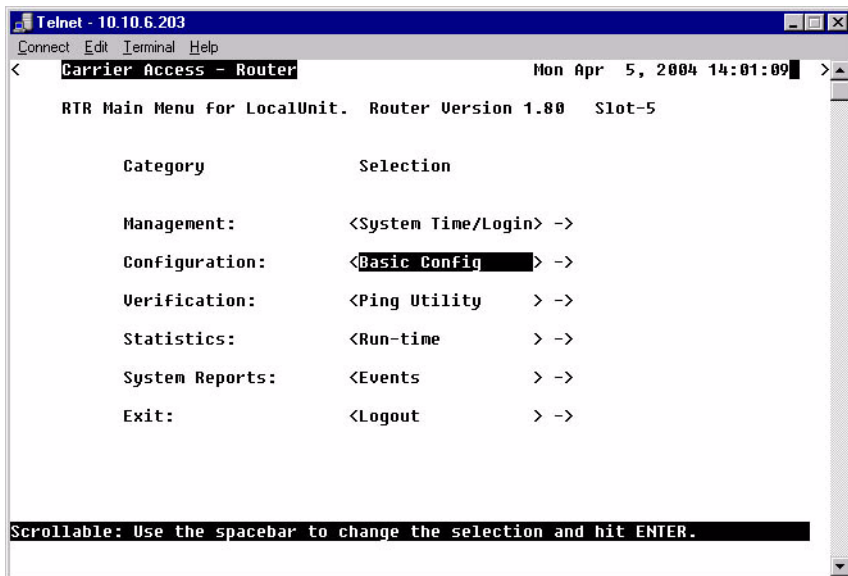

```
Telnet - 10.10.6.203
Connect Edit Terminal Help
< Carrier Access - Router Mon Apr 5, 2004 14:01:09 >
RTR Main Menu for LocalUnit. Router Version 1.00 Slot-5

Category Selection

Management: <System Time/Login> ->
Configuration: <Basic Config > ->
Verification: <Ping Utility > ->
Statistics: <Run-time > ->
System Reports: <Events > ->
Exit: <Logout > ->

Scrollable: Use the spacebar to change the selection and hit ENTER.
```

2. Select <Yes> to enter the setup program and press [ENTER].

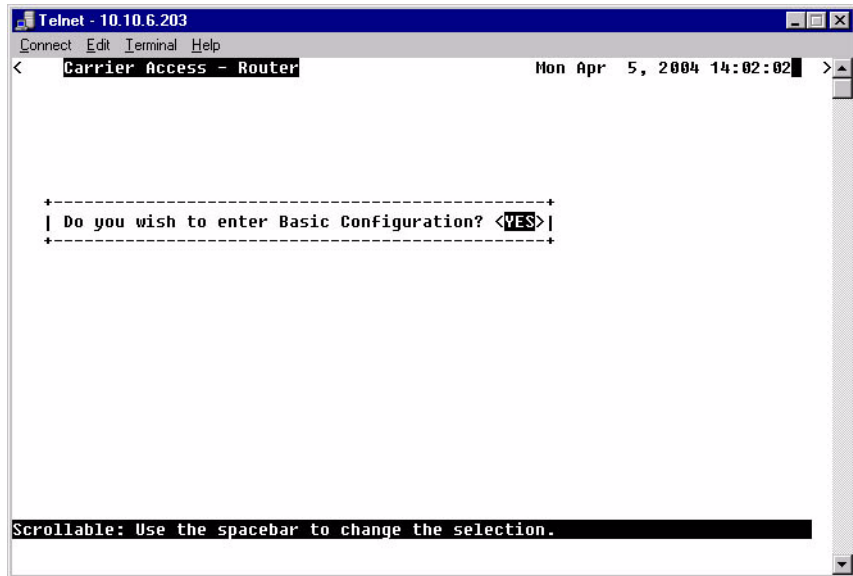

## Basic Configuration

### Router Identification

---

## Router Identification

---

**NOTE:** When this window is opened the items below in the box are not displayed. As you fill in information or accept the current (default) information (by hitting [ENTER]) the next line will display. This is the same process that you will find on all of the windows in the Guide.

---

```
Telnet - 10.10.6.203
Connect Edit Terminal Help
< Carrier Access - Router Mon Apr 5, 2004 14:03:59 >
-----
For help call Carrier Access Technical Support Page 1 of 7
Welcome to the Router Basic Configuration.
Please enter a name which will uniquely identify this Router in
your network. It is suggested that the name of your location be used.
Router Name: (LocalUnit )
Please enter the IP Address of this Router: (10.0.0.1 )
Please enter the Subnet Mask of this Router: (255.0.0.0 )
Please enter the Default Router of this Router: (0.0.0.0 )
-----
ENTER to go to next field, ESC to exit Basic Configuration
Editable: Enter a non-zero IP Address/Subnet Mask in Dotted Decimal Notation.
```

### Router Name: (LocalUnit )

Enter a unique name for the Local Unit. Name can be up to 11 characters.

### Router IP Address

Enter the IP Address of the Router.

### Router Subnet Mask

Enter the Subnet Mask of the above IP Address.

### Router Default Router

Enter a default Router IP Address.

## **Routing Protocol/Security**

```
Telnet - 10.10.6.203
Connect Edit Terminal Help
< Carrier Access - Router Mon Apr 5, 2004 14:06:12 >
-----
For help call Carrier Access Technical Support Page 2 of 7
Select direction(s) for LAN Network Updates: <Neither >
Select RIP mode to be received from remotes: <RIP1 >
Select RIP mode to send to remotes: <RIP1 >
Select the protocol remotes will
use to authenticate local LocalUnit: <CHAP>
Change the CHAP Secret LocalUnit will send? <NO >
Current Secret: public
Select the authentication User ID: <Local Profile Name >
Current User ID: LocalUnit
Select the protocol LocalUnit will
use to authenticate all remotes: <NONE>
-----
ENTER to go to next field, ESC to exit Basic Configuration
Scrollable: Select method this system will use to authenticate remote units.
```

### **Direction(s) for LAN Network Updates**

Selection is: < Both>, <Neither>, <Send>, <Receive>.

### **RIP mode to be received from remotes**

Selection is: <RIP1>, <RIP2>, <RIP1/RIP2>.

### **RIP mode to send to remotes**

Selection is: <RIP1>, <RIP2>, <RIP1/RIP2>.

### **Protocol remotes will use to authenticate local LocalUnit**

Selection is: <CHAP>, <PAP>, <NONE>.

#### **Change the CHAP Secret LocalUnit will send?**

Note: this field displays only with a selection on <CHAP>

Selection is: <YES>, <NO>. Below the current Secret Password is listed.

If <YES> is selected, the operator will be requested to enter in a new password, and retype this password to confirm.

### **Change the PAP Secret LocalUnit will send?**

Note: this field displays only with a selection on <PAP>.

Selection is: <YES>, <NO>. Below the current Secret Password is listed.

If <YES> is selected, the operator will be requested to enter in a new password, and retype this password to confirm.

### **Authentication User ID**

Selection is: <Local Profile Name>, <Local Custom Name>.

<Local Profile Name> Displays the current Local Profile name.

<Local Custom Name> With this selection you will be prompted to enter a Custom name. This name can be up to 32 characters long.

```

Select the authentication User ID:                <Local Custom Name >
Current User ID: ( ████████████████████████████ )

```

### **Protocol LocalUnit will use to authenticate all remotes**

Selection is: <CHAP>, <PAP>, <NONE>.



## WAN Interface Connections

This screen will display the Port Number and connection information of existing WANs. The window displays one WAN initially, as you set the connection type and then hit [ENTER] the next WAN will display.

Note: You are not allowed to back up to the previous WAN on the list. This screen will only hold 8 WANs on a page, additional pages are added as needed.

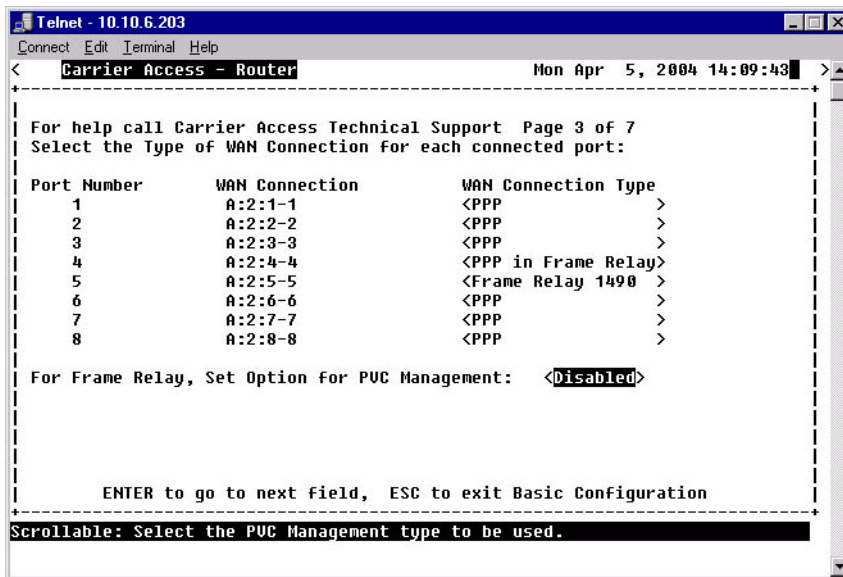

```
Telnet - 10.10.6.203
Connect Edit Terminal Help
Carrier Access - Router Mon Apr 5, 2004 14:09:43
-----
For help call Carrier Access Technical Support Page 3 of 7
Select the Type of WAN Connection for each connected port:

Port Number      WAN Connection      WAN Connection Type
  1              A:2:1-1             <PPP                >
  2              A:2:2-2             <PPP                >
  3              A:2:3-3             <PPP                >
  4              A:2:4-4             <PPP in Frame Relay>
  5              A:2:5-5             <Frame Relay 1490  >
  6              A:2:6-6             <PPP                >
  7              A:2:7-7             <PPP                >
  8              A:2:8-8             <PPP                >

For Frame Relay, Set Option for PUC Management: <Disabled>

ENTER to go to next field, ESC to exit Basic Configuration
-----
Scrollable: Select the PUC Management type to be used.
```

### Port Number

Displays the Port Number of the WAN (1-24).

### WAN Connection

Displays the connection {slot:port:channel} of each existing WAN.

### WAN Connection Type

Selection is: <PPP>, <Frame Relay 1490> and <PPP in Frame Relay>.

## Basic Configuration

### WAN Interface Connections

#### For Frame Relay, Set Option for PVC Management

Selection is: <Disabled>, <Annex D> and <LMI>.

##### Set Poll Interval

Range is between 5-30.

##### Set Poll Counter

Range is between 1-255.

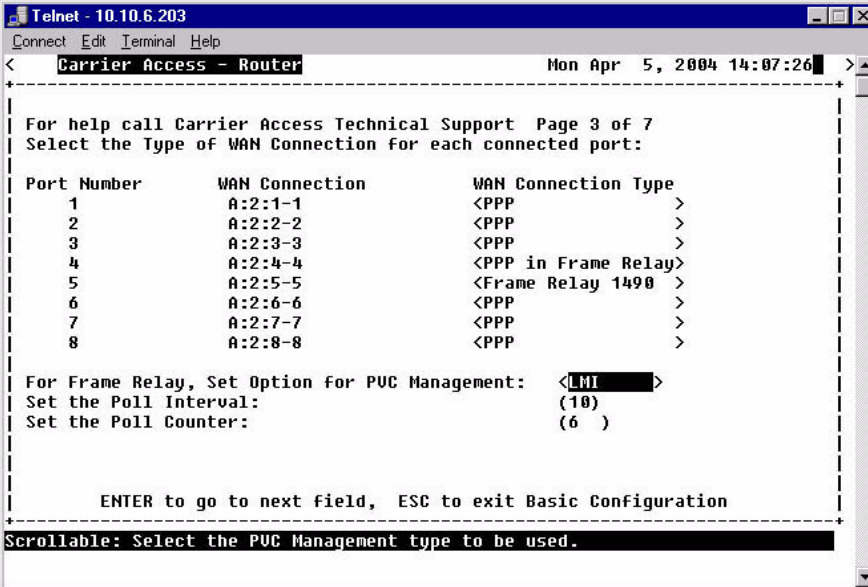

```
Telnet - 10.10.6.203
Connect Edit Terminal Help
< Carrier Access - Router Mon Apr 5, 2004 14:07:26 >
-----
| For help call Carrier Access Technical Support Page 3 of 7
| Select the Type of WAN Connection for each connected port:
|
| Port Number   WAN Connection   WAN Connection Type
| 1             A:2:1-1         <PPP                >
| 2             A:2:2-2         <PPP                >
| 3             A:2:3-3         <PPP                >
| 4             A:2:4-4         <PPP in Frame Relay>
| 5             A:2:5-5         <Frame Relay 1490  >
| 6             A:2:6-6         <PPP                >
| 7             A:2:7-7         <PPP                >
| 8             A:2:8-8         <PPP                >
|
| For Frame Relay, Set Option for PVC Management: <LMI >
| Set the Poll Interval: (10)
| Set the Poll Counter:  (6 )
|
| ENTER to go to next field, ESC to exit Basic Configuration
|-----
| Scrollable: Select the PVC Management type to be used.
|-----
```

```
Port Number   WAN Connection   WAN Connection Type
17            A:1:17-17       <PPP                >
18            A:1:18-18       <PPP                >
19            A:1:19-19       <Frame Relay 1490  >
20            A:1:20-20       <PPP                >
21            A:1:21-21       <PPP                >
22            A:1:22-22       <PPP                >
23            A:1:23-23       <PPP                >
24            A:1:24-24       <PPP                >

For Frame Relay, Set Option for PVC Management: <Annex D >
Set the Poll Interval: (10)
Set the Poll Counter:  (6 )
```

## **Remote Unit Profile**

A screen will ask you if you would like to Edit a Remote Unit Profile. Select <YES> and [ENTER]. The guide will walk through each Remote Profile that has been setup.

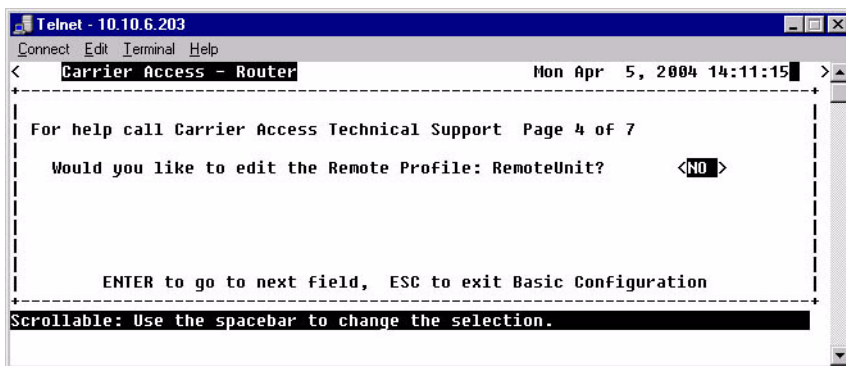

When exiting the last profile the guide will ask if you if you would like to add a Remote Profile.

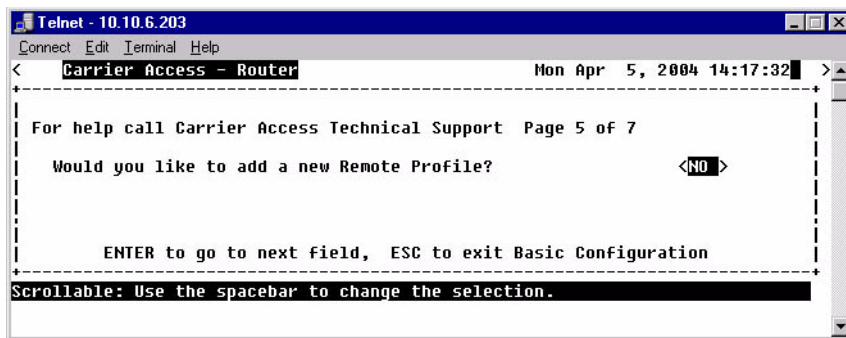

## Basic Configuration

### Remote Unit Profile

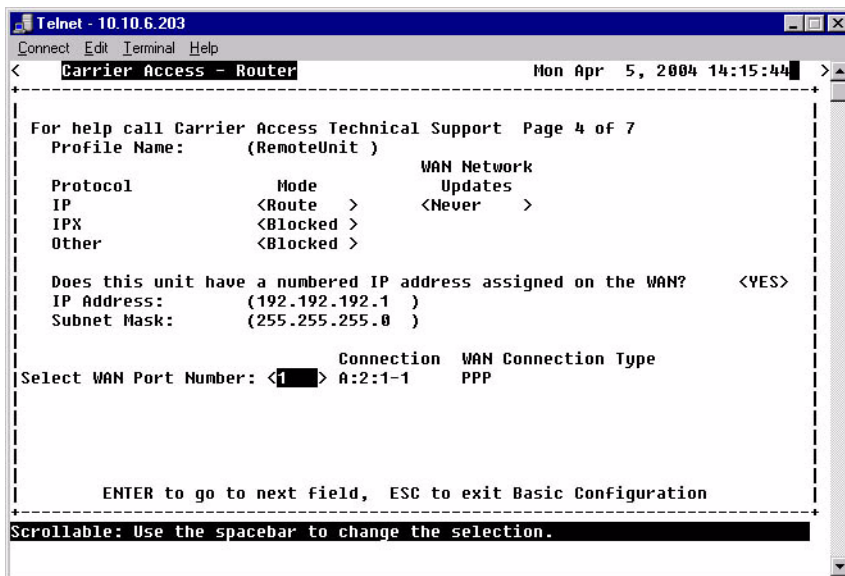

### Profile Name

Enter a unique name for this Remote Unit. Name can be up to 11 characters.

### Protocol

#### IP

Mode - <Route>, <Blocked> and <Bridge>.

WAN Network Updates - <Never>, <Periodic> and <Triggered>.

#### IPX

Mode - <Blocked>, <Bridge> and <Optimized>.

WAN Network Updates - <Never>, <Periodic>, <Triggered>.

#### Other

Mode - <Blocked>, <Bridge> and <Optimized>.

**Does this unit have a numbered IP address assigned on the WAN?**

Selection is: <Yes>, <No>. If <Yes> is selected IP Address and Subnet Mask below are listed.

**IP Address**

Enter the IP Address of the Remote Unit.

**Subnet Mask**

Enter the Subnet Mask of the above IP Address.

**Select WAN Port Number**

Selection is: <None>, <1> through <24> (all existing WAN ports are listed).

**Connection**

Displays the connection information for the selected WAN in the form {slot:port:channel}.

**WAN Connection Type**

Displays the WAN connection type (PPP, Frame Relay 1490 or PPP in Frame Relay).

**DLCI**

Enter the Data Link Connection Identifier. Range is between 16-1022.

Note: This field is not available with a WAN that has PPP set as it's connection type.

# SNMP Configuration

When you are finished adding additional Remote Profiles, select elect <NO> and [ENTER]. The guide will move onto the SNMP co.

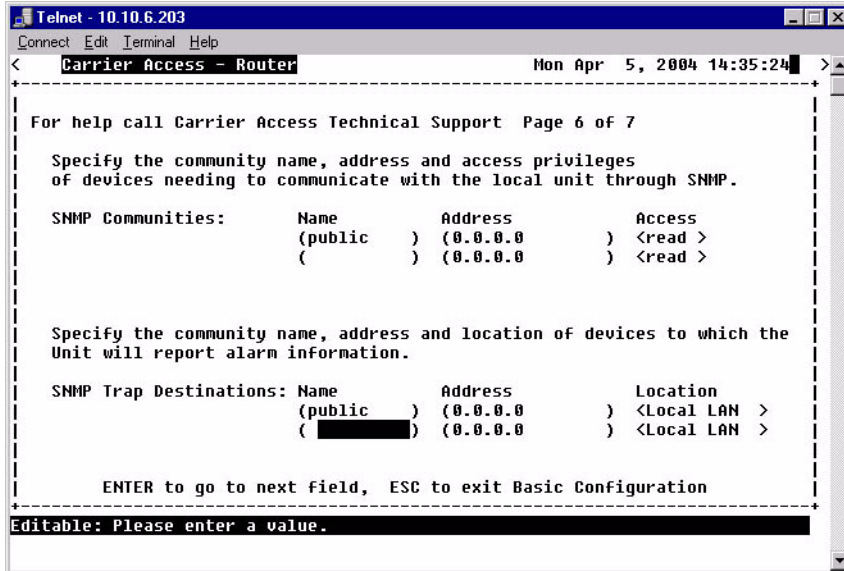

## SNMP Communities

**Name** - Enter a 10 character name.

**Address** - Enter an IP address (first line) Subnet Mask for second line.

**Access** - Selection is: <read>, <write>, <both>.

## SNMP Trap Destinations

**Name** - Enter a 10 character name.

**Address** - Enter an IP address (first line) Subnet Mask for second line.

**Location** - Selection is: <Local LAN>, will have a selection for each Remote Unit that a profile has been created for.

## **Setup Complete**

You have now completed the Basic Configuration. You may re-enter the Basic Configuration to make changes now or at any time.

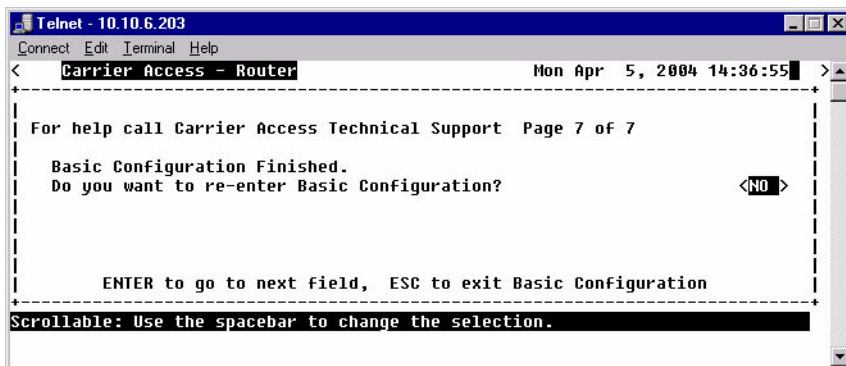

## ***Basic Configuration***

*Setup Complete*

---



# CHAPTER 7

---

## *Verification Window*

The Verification window is used to identify suspected communication problems between the Local (LAN) and Remote (WAN) devices.

### **In this Chapter**

- Ping Utility
- Trace Route
- Port Monitor

## Verification Window

### Ping Utility

---

## Ping Utility

Use this option to verify any communication problems between the Router and various devices connected to your LAN or at a Remote location. Problems are detected when a “ping” is sent to a device. If the device echoes back to the Router, then communications are operating normally. If no echo returns, then further investigation is needed. Devices must be running TCP/IP software in order for the ping to be successful.

A single ping may be used, where only one packet is sent to the device being tested, or a continuous ping to the device until you manually terminate the test. Continual pinging may help identify intermittent communication problems. Please note that when pinging a device on a remote LAN, it is not unusual for the first ping to fail.

---

**NOTE:** In order to perform LAN port testing, the selected frame type must be Ethernet II and the Router’s IP Address must be configured.

---

1. On the Main Menu, press [TAB] until **Ping Utility** is highlighted on the **Verification** option.

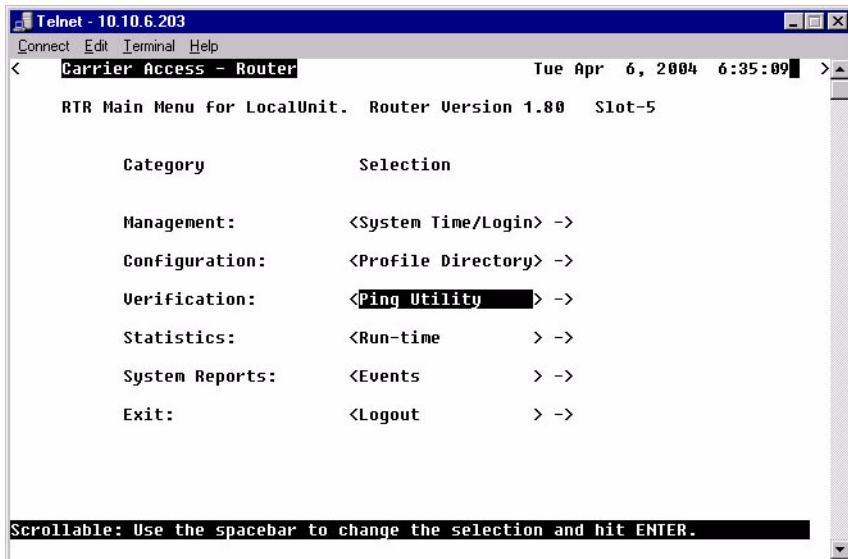

2. Press [ENTER]. The **Ping Utility** window will display.

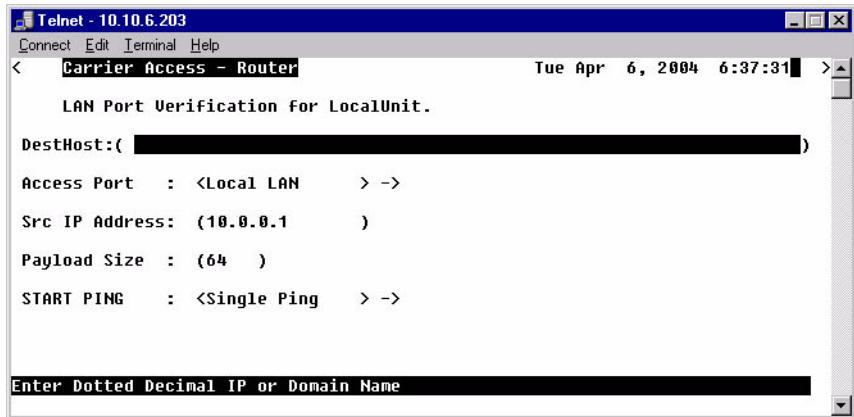

3. To initiate a Ping, select **START PING <Single Ping >**, scroll to **<Continuous Ping>** if desired and press [ENTER]. The Ping process will begin.

## ***LAN Port Tests Fields***

### **Dst Host**

Destination Host. The Destination Address of the host to be tested.

### **Access Port**

This is the local or remote profile of the network used during the test. The operator can scroll (with the [SPACEBAR]) through the selections of the **Access Port: <Local LAN>** to select the **Local LAN** or any of the defined **Remote Unit(s)**. All defined Remote Profiles will be in this selection.

### **Src IP Address**

Source IP Address. This is one of the multiple IP addresses assigned to the Ethernet LAN port and will override the IP address that will be used as the source IP address. Default is to use the IP address of the interface from which the ping is sent.

### **Payload Size**

This optional parameter sets the number of bytes to send in the ICMP echo request payload. Range is 0 to 8000, default is 56.

## Verification Window

### Ping Utility

---

#### START PING < >

##### <Single Ping >

Test for device failure.

The single ping test will send one ping, and display the results of the test.

##### <Continuous Ping >

Test for intermittent communication problems.

A continuous ping will send a ping until the test is manually terminated. Results of the continuous ping test are constantly updated, based on the result of each ping sent. Press [ESC] to terminate the test at any time.

Successful Single Ping	
Status	
IP Dst Address	: 100.1.0.26
IP Src Address	: 100.1.0.10
MAC Address	: 00-00_86_62_72_17
Response Time	: < 1ms
Last Result	: Host Responding

Unsuccessful Single Ping	
Status	
IP Dst Address	: 100.1.0.26
IP Src Address	: 100.1.0.10
MAC Address	:
Last Result	: Destination Unreachable

Successful Single Ping	
Status	
IP Dst Address	: 100.1.0.26
IP Src Address	: 100.1.0.10
MAC Address	: 00-00_86_62_72_17
Response Time	: < 1ms
Last Result	: Host Responding
Response Count: 19	Timeout Count: 0

Unsuccessful Single Ping	
Status	
IP Dst Address	: 100.1.0.26
IP Src Address	: 100.1.0.10
MAC Address	:
Last Result	: Destination Unreachable
Response Count: 19	Timeout Count: 0

#### Response Window Fields:

##### IP Address

Displays the IP Address entered on the setup window.

##### MAC Address

When a Single Ping is successful, the MAC Address is displayed. When the test has failed, the MAC Address field does not display, and a timeout result is displayed.

### **Result or Last Result**

Will indicate if the host is responding to the test. Result notices will be one of the following:

**Host Responding** - This is a successful test with a ping responding.

**Destination Unreachable** - This is an unsuccessful test. The Router is not able to talk to the IP Address.

**Timeout** - This is an unsuccessful test. There is no response within a reasonable amount of time.

### **Response Count**

During successful testing the Response Count field will display the number of times that the Router received an echo back from the device.

### **Timeout Count**

The Timeout Count will increment with each unsuccessful ping. During successful testing, the Timeout Count field will display a 0, which means that no communications errors have been encountered.

---

**NOTE:** A continuous ping test may be intermittently unsuccessful. This is an indication that a transmission error may occur with this device during actual data transmission.

---

## Verification Window

### Trace Route

---

## Trace Route

The Trace Route option is used to verify timely and reliable connections. The Trace Route utility determines the path a packet follows from source to destination.

1. On the Main Menu, press [TAB] until the **Ping Utility** is highlighted on the **Verification** option.
2. Press [SPACEBAR] to scroll to **Trace Route**.

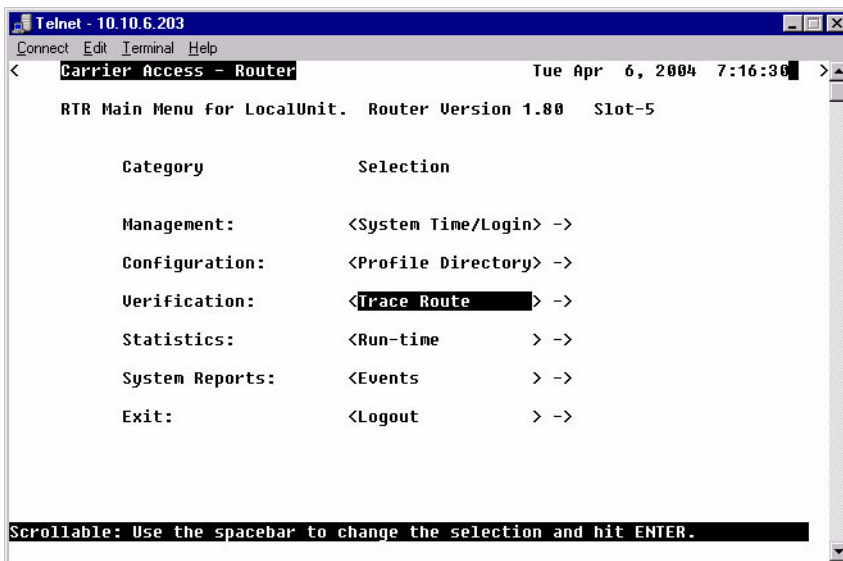

```
Telnet - 10.10.6.203
Connect Edit Terminal Help
< Carrier Access - Router Tue Apr 6, 2004 7:16:30 >
RTR Main Menu for LocalUnit. Router Version 1.80 Slot-5

Category Selection

Management: <System Time/Login> ->
Configuration: <Profile Directory> ->
Verification: <Trace Route> ->
Statistics: <Run-time> > ->
System Reports: <Events> > ->
Exit: <Logout> > ->

Scrollable: Use the spacebar to change the selection and hit ENTER.
```

3. Press [ENTER]. The Trace Route window will display.

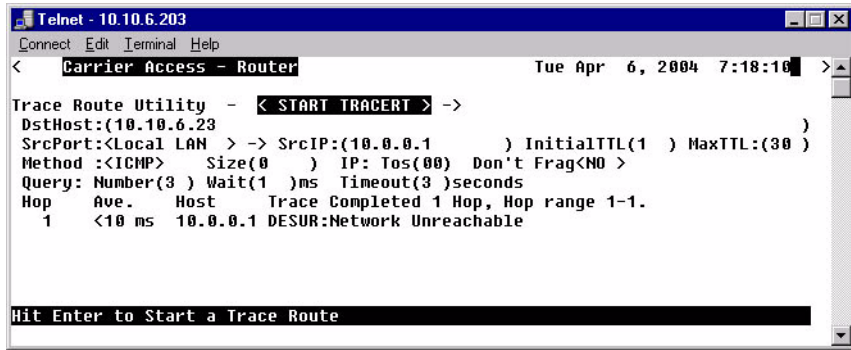

```
Telnet - 10.10.6.203
Connect Edit Terminal Help
< Carrier Access - Router Tue Apr 6, 2004 7:18:10 >
Trace Route Utility - < START TRACERT > ->
DstHost:(10.10.6.23 )
SrcPort:<Local LAN > -> SrcIP:(10.0.0.1 ) InitialTTL(1 ) MaxTTL:(30 )
Method :<ICMP> Size(0 ) IP: Tos(00) Don't Frag<N0 >
Query: Number(3 ) Wait(1 )ms Timeout(3 )seconds
Hop Ave. Host Trace Completed 1 Hop, Hop range 1-1.
1 <10 ms 10.0.0.1 DESUR:Network Unreachable

Hit Enter to Start a Trace Route
```

### Trace Route Utility - <START TRACERT> - >

After all parameters are entered, select <START TRACERT> and [ENTER] to start the trace.

#### DstHost

Enter an IP Address or, domain name to use for this query. IP Address must be in the form of xxx.xxx.xxx.xxx, where xxx is between 0-255.

#### Src Port

Scroll through the available options (Local LAN and Remote Units).

#### SrcIP Port

The source IP address from any of the routers numbered IP addresses. Default is the IP address of the router interface used to send the packets.

#### InitialTTL

This optional parameter defines the beginning of the range of hops to query. Range is 1 - 254 value, **Note: must be less than MaxTTL**. Default is 1.

#### MaxTTL

This optional parameter defines the end (or the maximum) of the range of hops to query. Range is 2 - 255 value, **Note: must be more than InitialTTL**. Default is 30.

## **Verification Window**

### **Trace Route**

---

#### **Method**

**<ICMP>** - Internet Control Message Protocol (ICMP) method of trace routing is the most widely used and has the best reliability. (Default).

**<UDP>** - User Datagram Protocol (UDP) method requires that all devices in the chain of the trace route support probes on the particular UDP port. This method is not recommended.

#### **Size**

Define Packet Size. Range 0 - 65500

#### **IP: Tos**

Sets the IP type of service. Range 0x00 - 0xFF Hex. Default is 0.

#### **Don't Frag**

Sets the "Don't Fragment" flag in the IP header. This can be used along with the size setting to determine the maximum payload size that can be sent between the router and the destination without fragmentation occurring, the path MTU.

#### **UDP Port**

Sets the UDP port to send to. Range is 1 - 65535, with a default of 33434. This setting only applies if the method is set to UDP.

#### **Query: Number**

Defines the number of probe packets sent to each hop along the route. Range is 1 - 10,. Default is 3.

#### **Wait**

Defines the wait time between queries. Range is 0 - 250 ms. Default is 1 ms.

#### **Timeout**

Defines the query timeout. Range is 1 - 60 seconds. Default is 3 seconds.



## Port Monitor

The Port Monitor option is a diagnostic tool that can be used to review the actual data being transmitted to, or received by the Local (LAN) unit. This can be especially useful in determining where a transmission failure is occurring.

When monitoring is started, a hex display of each transmission, may be viewed as it occurs. The number of packets that are displayed is determined by the value given at the **Number of bytes to display for each packet** prompt. When attempting to determine a transmission problem, it may be useful to print the hex displays for further analysis.

**NOTE:** The Port Monitor should only be used for installation verification and PPP negotiation verification. Under normal operation the Port Monitor should not be used as it will decrease performance.

1. On the Main Menu, press [TAB] until the **Ping Utility** is highlighted on the **Verification** option.
2. Press [SPACEBAR] to scroll to **Port Monitor**.

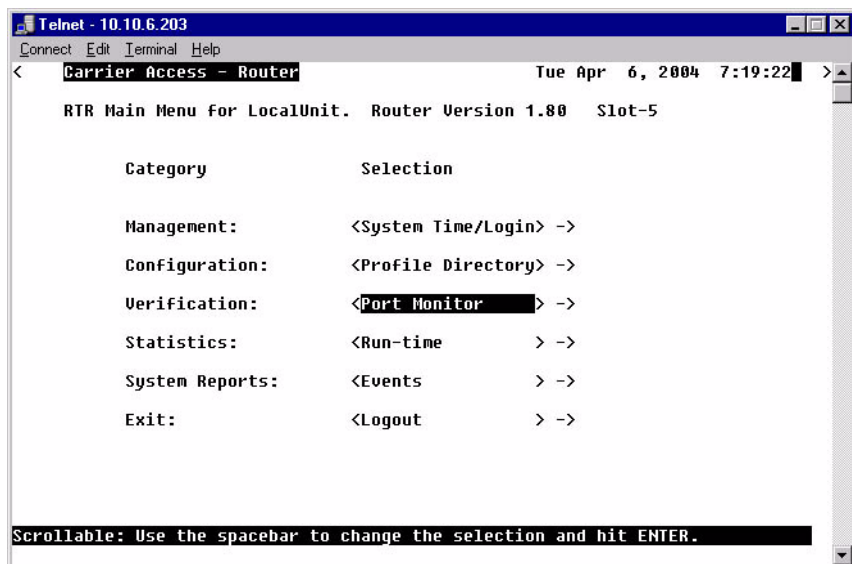

```
Telnet - 10.10.6.203
Connect Edit Terminal Help
Carrier Access - Router Tue Apr 6, 2004 7:19:22
RTR Main Menu for LocalUnit. Router Version 1.80 Slot-5

Category Selection

Management: <System Time/Login> ->
Configuration: <Profile Directory> ->
Verification: <Port Monitor> ->
Statistics: <Run-time> > ->
System Reports: <Events> > ->
Exit: <Logout> > ->

Scrollable: Use the spacebar to change the selection and hit ENTER.
```

## Verification Window

### Port Monitor

---

3. Press [ENTER]. The **Port Monitor window** will display.

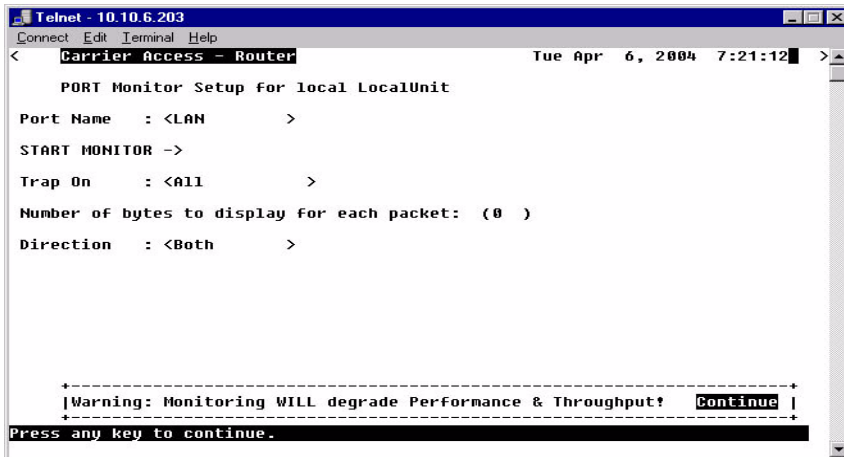

#### Port Name:

Select the Port Name, by scrolling through the list of (LAN Port, Remote Units) with the [SPACEBAR].

#### Start Monitor

Use this prompt to initiate the packet trace. Select START MONITOR -> and press [ENTER] to begin the trace. As the transmission occurs, the packet hex dump will be displayed on the screen.

If you wish, you may end the trace at any point. Press [ESC] to terminate.

#### Trap On

Use this field to define what traps to turn on. <All>, <ARP/RARP>, <ALL IP, <IP ADDR#>, <All UDP>, <UDP Port# >, <RIP>, <STP>, <IPX>, <ICMP>, <MGCP>, <RTP>, <BLOCK TCP>. Note: With <UDP Port#>, a port number (range: 0 - 65535) is entered. With <IP ADDR#> an IP Address is entered.

#### Number of bytes to display for each packet:

Use this field to enter the number of bytes to display for each packet. The range is 0-512.

#### Direction

Use this field to define the direction to trace. <Both>, <Transmit> or <Receive>.

The following an example of a WAN Monitor trace.

```
>>>Sending>>> Time= 2:55:31 msg-0001 WAN-WAN+2 14 octets (ESC to stop)
00: 00 01 03 08 00 75 95 01 01 00 03 02 67 66
FR DLCI-0 Bridged Eth

<<<Receiving<<< Time= 2:55:31 msg-0002 WAN-WAN+2 19 octets (ESC to stop)
00: 00 01 03 08 00 7D 95 01 01 00 03 02 67 67 07 03
10: 06 A0 82
FR DLCI-0 Bridged Eth

<<<Receiving<<< Time= 2:55:38 msg-0003 WAN-WAN+2 100 octets (ESC to stop)
00: 18 41 03 CC 45 00 00 60 E5 1F 00 00 7F 11 81 AA
10: 14 14 00 03 C0 A8 00 04 00 89 00 89 00 4C 48 0F
FR DLCI-100 IP
IP4-HDR: src=20.20.0.3 dst=192.168.0.4 ttl=127 len=20
UDP-HDR: Ports src=137 dst=137 len=76 cksum is=480F,cacl=0

>>>Sending>>> Time= 2:55:38 msg-0004 WAN-WAN+2 100 octets (ESC to stop)
00: 18 41 03 CC 45 00 00 60 E5 1F 00 00 7E 11 82 AA
10: 14 14 00 03 C0 A8 00 04 00 89 00 89 00 4C 48 0F
FR DLCI-100 IP
IP4-HDR: src=20.20.0.3 dst=192.168.0.4 ttl=126 len=20
UDP-HDR: Ports src=137 dst=137 len=76 cksum is=480F,cacl=0
```

## ***Verification Window***

*Port Monitor*

---

# CHAPTER 8

---

## ***Statistics Window***

The Statistics window is used to review data transmission information between the Local (LAN) unit and Remote (WAN) devices. This option allows you to review data transmission statistics to/from remote units. This data will help you to monitor the Router's connection/performance capabilities such as throughput, compression, and errors.

### **In this Chapter**

- Run-Time

## Run-Time

Use this screen to review the statistics regarding data transmission to and from remote units. All remote units that appear on the Profile Directory screen will be displayed here. If no data is currently being transmitted to a specific unit, the transmission fields will display 0's.

1. On the Main Menu, press [TAB] until the **Run-time** is highlighted on the **Statistics** option.

```
Telnet - 10.10.6.203
Connect Edit Terminal Help
< Carrier Access - Router Tue Apr 6, 2004 7:22:27 >
RTR Main Menu for LocalUnit. Router Version 1.80 Slot-5

Category          Selection

Management:      <System Time/Login> ->
Configuration:   <Profile Directory> ->
Verification:    <Ping Utility > ->
Statistics:      <Run-time> ->
System Reports:  <Events > ->
Exit:            <Logout > ->

Scrollable: Use the spacebar to change the selection and hit ENTER.
```

2. Press [ENTER]. The **Run-time Statistics** window will display.

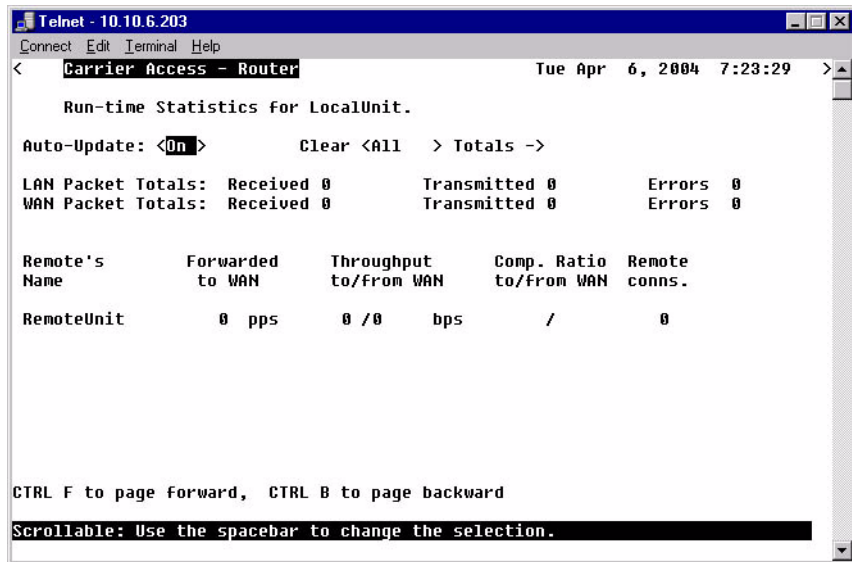

```
Telnet - 10.10.6.203
Connect Edit Terminal Help
< Carrier Access - Router Tue Apr 6, 2004 7:23:29 >

Run-time Statistics for LocalUnit.

Auto-Update: <On>          Clear <All > Totals ->

LAN Packet Totals: Received 0          Transmitted 0          Errors 0
WAN Packet Totals: Received 0          Transmitted 0          Errors 0

Remote's      Forwarded   Throughput   Comp. Ratio   Remote
Name          to WAN     to/from WAN to/from WAN  conns.

RemoteUnit    0 pps     0 / 0      bps          /           0

CTRL F to page forward, CTRL B to page backward
Scrollable: Use the spacebar to change the selection.
```

## Auto-Update

Use this field to select whether you wish to have this screen automatically updated with new transmission statistics while you are viewing the screen. **<On>** will update the screen every 2 seconds. **<Off>** will disable this feature.

## Clear < > Totals

Use this field to reset (clear) the total packets displayed in the following fields.

**<All>**

Will clear both the LAN and WAN Packet Totals.

**<LAN>**

Will clear only the LAN Packet Totals.

**<WAN>**

Will clear only the WAN Packet Totals.

### LAN Packet Totals

Use this field to review the number of LAN packets that the local unit has **Received**, **Transmitted**, and contained **Errors**. If **Auto-Update** is set to **<No>**, the LAN packet totals will not increment while the screen is displayed.

#### Received

This field will increment as packets are received from the LAN. For this total to update, **Auto-Update** must be **<On>**.

#### Transmitted

This field will increment as packets are transmitted by the Router to the LAN. These include packets received from the WAN as well as internally generated packets. For this total to update, **Auto-Update** must be **<On>**.

#### Errors

This field increments as packets are transmitted to, or received from the LAN in error. This includes RX CRC errors (partial frames, aborted frames and “bad frames”) and TX retry failures and RX carrier loss errors. This does not include bad packets that result from collisions. For this total to update, **Auto-Update** must be **<On>**.

**Note: There are WAN protocol packets sent to the telephone company switch, even when there are no active calls.**

### WAN Packet Totals

Use this field to review the number of WAN packets that the local unit has **Received**, **Transmitted**, and contained **Errors**. If **Auto-Update** is set to **<No>**, the WAN packet totals will not increment while the screen is displayed.

#### Received

This field increments as packets are received from the WAN. This includes packets from all remote sites. For this total to update, **Auto-Update** must be **<On>**.

#### Transmitted

This field increments as packets are received from the LAN and internally generated packets, such as network optimization packets, which have been transmitted to the WAN. For this total to update, **Auto-Update** must be **<On>**.

#### Errors

This field identifies packets that have been transmitted to, or received from the WAN in error. This includes RX CRC errors (partial frames, aborted frames, long frames and “bad frames”) as well as aborted TX frames. It is used to identify WAN communication problems prior to contacting the telephone company for further diagnosis. For this total to update, **Auto-Update** must be **<On>**.



### **Remote's Name**

This field reflects the names of all the Remote (WAN) profiles listed in the Profile Directory.

### **Forwarded to WAN**

This field represents the number of data packets per second (pps) that are being forwarded from the LAN to the respective remote units. Each screen update is a current snapshot of transmission activity.

### **Throughput to/from WAN**

This field value displays two numbers which represent the current bandwidth utilization in bits per second (bps) for each remote site listed. The **TO** number represents transmission utilization going from the LAN to the listed remote unit. The **FROM** number represents transmission utilization received from the listed remote unit.

### **Comp. Ratio to/from WAN**

Using advanced data compression algorithms, the Router constantly seeks to determine the best way to compress the data to be transmitted across the WAN. The values in this field represent how much the Router was able to compress the data. Since some data is more compressible than others, the compression ratio will reflect this.

### **Remote Conns.**

The numeric value in this field represents the number of connections currently active per Remote (WAN) site.

## ***Statistics Window***

*Run-Time*

---

# CHAPTER 9

---

## ***System Reports Window***

The System Reports menu presents data that may be useful in identifying WAN communication problems.

### **In this Chapter**

- Events
- Alarms
- Networks/Servers
- Address Tables

## Events

Displays the log of events for the IP Router.

### To View the Event Log:

1. On the Main Menu, press [TAB] until **Events** is highlighted on the **System Reports** option.

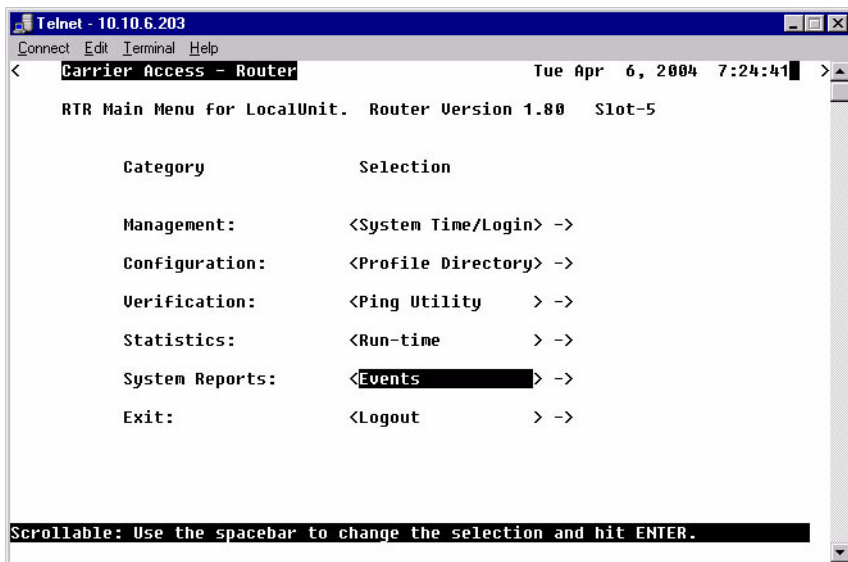

2. Press [ENTER]. The Event Log will display.

```
Telnet - 10.10.6.203
Connect Edit Terminal Help
< Carrier Access - Router Tue Apr 6, 2004 7:25:42 >
Event Log for LocalUnit. Auto-Update: <On>

Time          Message                                          Count
Apr 6 7:16:26.8 Login accepted at ADMIN level                1
Apr 6 7:07:24.6 ADMIN login terminated           1
Apr 6 7:07:24.6 Terminal inactivity, login terminated 1
Apr 6 6:34:18.6 Login accepted at ADMIN level                1
Apr 5 14:39:23.1 ADMIN login terminated           1
Apr 5 13:45:49.6 Export complete in 0.0 secs [45840 bps]    1
Apr 5 13:45:49.6 Export config.cfg to Controller          1
Apr 5 13:45:49.5 Send CFG Change Notice to Controller - PASS 1
Apr 5 12:17:45.7 Export complete in 0.0 secs [45280 bps]    1
Apr 5 12:17:45.6 Export CFG Sector REM FIXED CRC ERR!      1
Apr 5 12:17:45.6 Export config.cfg to Controller          1
Apr 5 12:17:45.6 Send CFG Change Notice to Controller - PASS 1
Apr 5 11:20:32.2 Export complete in 0.0 secs [45360 bps]    1
Apr 5 11:20:32.1 Export config.cfg to Controller          1
Apr 5 11:20:32.1 Send CFG Change Notice to Controller - PASS 1
Apr 5 11:17:46.1 Export complete in 0.0 secs [45360 bps]    1
Apr 5 11:17:46.0 Export config.cfg to Controller          1
More...
CTRL F to page forward, DOWN ARROW to scroll
```

## Auto-Update

<On> or <Off>.

## Time

The value in this column represents the date and time that the specific event occurred. Events are displayed in descending order with the most recent event displayed at the top of the screen.

## Message

This column displays the actual event that occurred on the Router. Use this field to trace the activities of your Router.

## Count

If the same event occurs consecutively, the value in the count column will display the number of times that the event occurred, although the message will display only once. Note that the time stamp reflects the date and time that the event first occurred.

## Alarms

This screen displays alarms that have occurred on your Router. When an alarm is triggered, the LED labeled **CRD** on the front of the Router will be RED and will remain until the alarm is cleared. Unlike the **System Events**, alarms will not increment the **Count** field each time they occur. Each alarm will be listed separately and the **Count** field will display a value of 1.

Alarm listings will also appear as flashing or bold text entries in the **User Event Log**. Please note that all alarms will generate SNMP traps.

The Alarm Log is cleared when the Router is reinitialized.

1. On the Main Menu, press [TAB] until the **Alarms** is highlighted on the **System Reports** option. Use the [SPACEBAR] to scroll to Alarms if it not displayed.

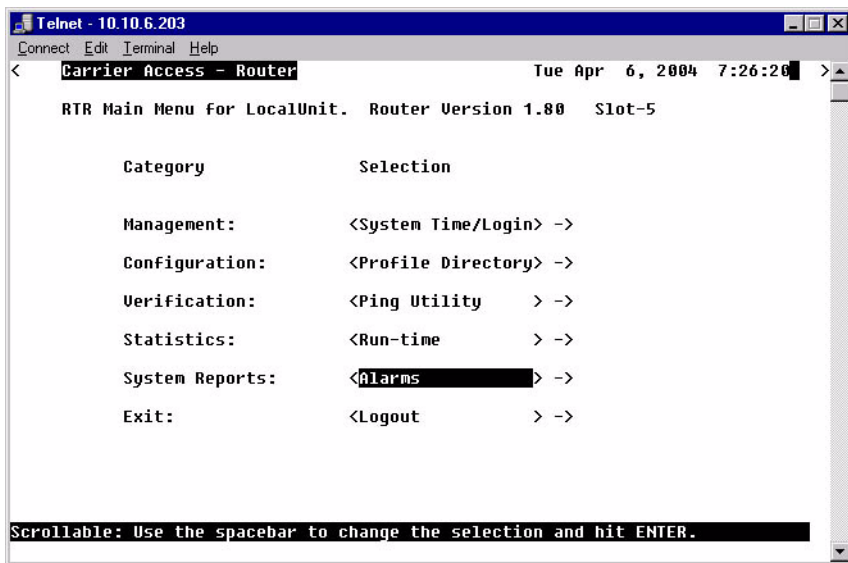

2. Press [ENTER]. The **Alarm Log** will display.

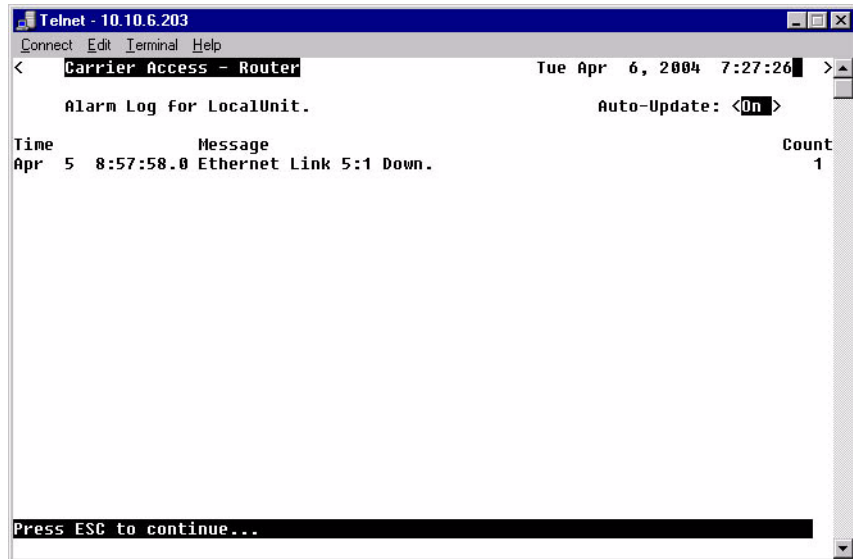

### **Auto-Update**

Use this field to have this screen automatically update with events while you are viewing the screen. <On> will update the screen every 5 seconds, <Off> will disable this feature.

### **Time**

Displays the date and time that the alarm occurred. Alarms are displayed in descending order with the most recent alarm first.

### **Message**

Displays the actual alarm that triggered the alarm on the Router.

### **Count**

Unlike the Event screen, the value in the count column will not increment each time that the alarm occurs. Note that the time stamp reflects the time that the alarm first occurred.

## System Reports Window

Networks/Servers

# Networks/Servers

Use this screen to review all of the networks and servers that your Local (LAN) Unit has learned on its Local LAN or from remote units, as well as static entries.

By sending out IPX and IP RIP (Routing Information Protocol) and IPX SAP (Service Advertising Protocol) packets and monitoring RIP and SAP packets from other devices, the Router will learn about other servers and networks. The Router will constantly monitor RIP and SAP packets to ensure that the status of the network or server has changed. Should a RIP or SAP packet indicate a change in status, the Router would update the data in the table and send the information to all enabled remotes to exchange the updated data. This screen will change depending on the values in the **Display** and **Learned From** fields.

1. On the Main Menu, [TAB] to the **System Reports** option.
2. Press [SPACEBAR] to scroll to **Networks/Servers**.

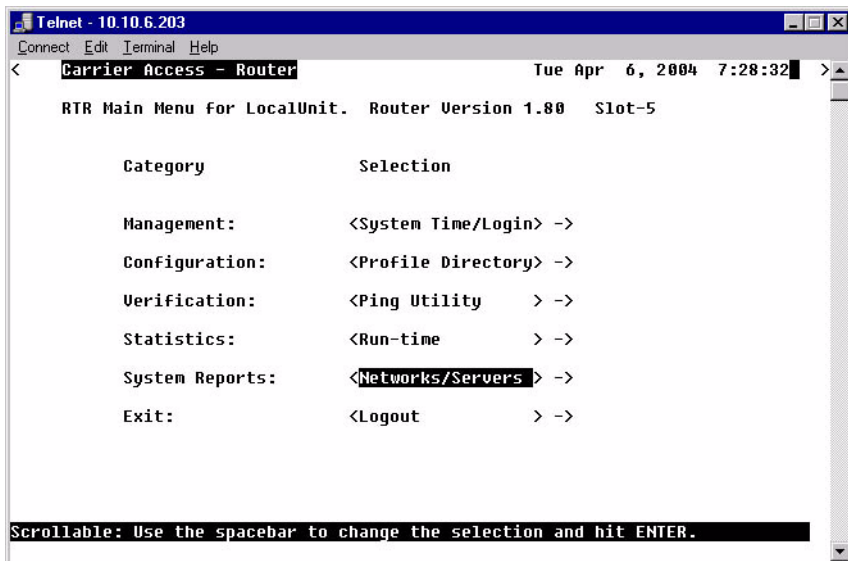



3. Press [ENTER]. The Networks/Servers listing will display.

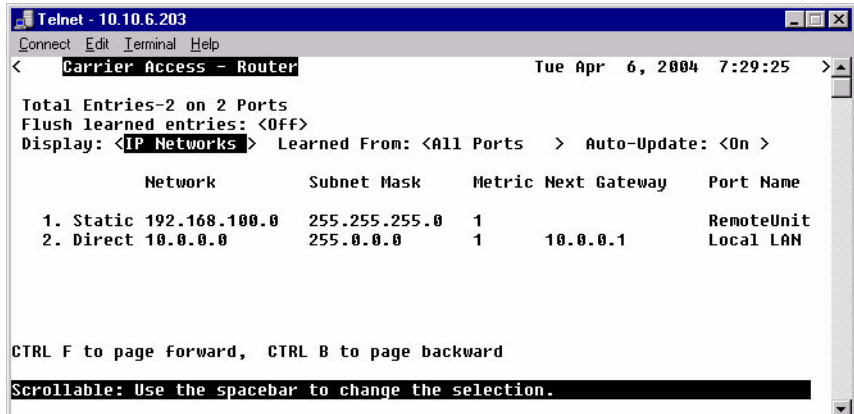

```
Telnet - 10.10.6.203
Connect Edit Terminal Help
< Carrier Access - Router Tue Apr 6, 2004 7:29:25 >
Total Entries-2 on 2 Ports
Flush learned entries: <Off>
Display: <IP Networks> Learned From: <All Ports > Auto-Update: <On >

      Network      Subnet Mask      Metric Next Gateway      Port Name
1. Static 192.168.100.0 255.255.255.0    1      10.0.0.1      RemoteUnit
2. Direct 10.0.0.0      255.0.0.0        1      10.0.0.1      Local LAN

CTRL F to page forward, CTRL B to page backward
Scrollable: Use the spacebar to change the selection.
```

## Display

Use this field to select whether you wish to view the table for <IP Networks>, <IPX Networks> or <IPX Servers>. Use the [SPACEBAR] to scroll through the options, the screen will update accordingly.

## Learned From

Will select what to learn from, the Local LAN or from any of the Remote sites listed in the Profile Directory. Use the [SPACEBAR] to scroll through the options, the screen will update accordingly.

## Auto-Update

Use this field to have this screen automatically update with events while you are viewing the screen. <On> will update the screen every 5 seconds.

## Network

This field displays the network IP address of each network known to the Router. If this route was added using one of the Static Network screens, **Static** will appear before the address of this entry. If this route was learned by the local unit, **Direct** will appear before the address.

## Type

This field displays the Hex value assigned to each known server. This field applies only to **IPX Servers**.

## ***System Reports Window***

### *Networks/Servers*

---

#### **Name**

This field displays the first 11 characters of the name of each known server. This field applies only to **IPX Servers**.

#### **Metric**

This field displays the numeric value (of hops) indicating the distance from your Local (LAN) network to the destination network. This field applies only to **IP Networks**.

#### **Next Gateway**

This field displays the MAC Address of the first gateway (Router) that the data will use to reach the destination network. This field is only used on **IP Networks**.

#### **Hops**

See **Metric**, above. This field is only used on **IPX Networks**.

#### **Ticks**

This field displays the distance between two networks as measured in time increments (1/18th of a second). This information is only used by **IPX Networks**. Like hops, ticks may be used to designate primary and secondary routes to the same network. Although both the hops and ticks values are considered when determining routing priority, for Novell networks, the tick value is considered first.

#### **Next IPX Router**

This field displays the MAC Address of the next gateway (Router) that the data will use to reach the destination network. This applies only to **IPX Networks**.

#### **Frame Type**

This field will display the chosen frame type of the packets that are sent and received by the Router. If a packet is received that is formatted in a frame type that has not been enabled, the Router will not accept the data. Note that multiple frame types may be supported simultaneously. This field applies only to **IPX Networks**.

## **Address Tables**

Use this screen to review the MAC Address and IP Address of the devices that are known by the Router. The Router will monitor traffic on the LAN/WAN and dynamically learn the MAC Address and/or IP Address of each device. This learning is a continuous process that occurs automatically as communication takes place on the LAN or across the WAN. The MAC Address and IP Address Tables, along with Network Tables are used to determine if and where the Router should send packets.

1. On the Main Menu, [TAB] to the **System Reports** option.
2. Press [SPACEBAR] to scroll to **Address Tables**.

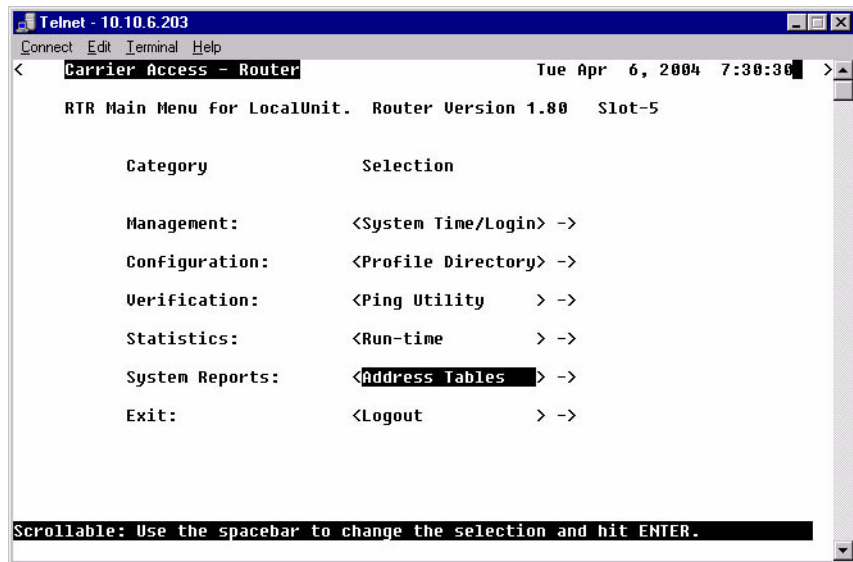

## System Reports Window

### Address Tables

---

- Press [ENTER]. The **Address Tables** window will display. These windows will change as different options are selected.

#### MAC Address

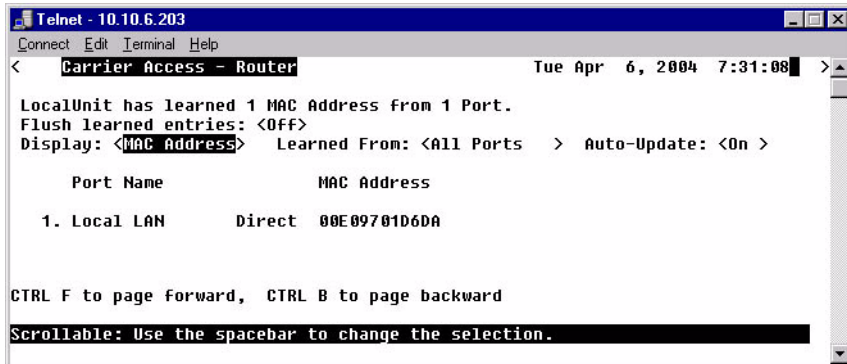

```
Telnet - 10.10.6.203
Connect Edit Terminal Help
< Carrier Access - Router Tue Apr 6, 2004 7:31:08 >
LocalUnit has learned 1 MAC Address from 1 Port.
Flush learned entries: <Off>
Display: <MAC Address> Learned From: <All Ports > Auto-Update: <On >

Port Name          MAC Address
1. Local LAN      Direct 00E09701D6DA

CTRL F to page forward, CTRL B to page backward
Scrollable: Use the spacebar to change the selection.
```

#### IP Address

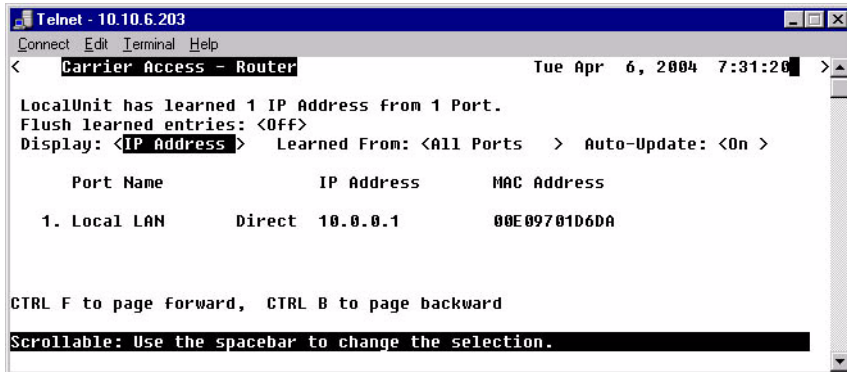

```
Telnet - 10.10.6.203
Connect Edit Terminal Help
< Carrier Access - Router Tue Apr 6, 2004 7:31:26 >
LocalUnit has learned 1 IP Address from 1 Port.
Flush learned entries: <Off>
Display: <IP Address> Learned From: <All Ports > Auto-Update: <On >

Port Name          IP Address      MAC Address
1. Local LAN      Direct 10.0.0.1      00E09701D6DA

CTRL F to page forward, CTRL B to page backward
Scrollable: Use the spacebar to change the selection.
```

### Flush Learned Entries

This field will eliminate all the learned entries from either the <MAC Address> table or the <IP Address> table when the field is changed from <Off> to <On>. Use the [SPACEBAR] to scroll to the selection.

### Display

Use this field to select to view the address table by <MAC Address> or <IP Address>. Use the [SPACEBAR] to select the appropriate view. The screen will update accordingly as you scroll between options. When the view by **IP Address** is selected, the table may also display the corresponding **MAC Address** for locally learned devices. Corresponding **MAC Addresses** are only displayed if the Router has encountered an ARP/RARP packet.

### **Learned From**

Will select to view devices learned from the LAN or from any remote units. This field will display either <All Ports>, <Local LAN> or each of the individual **Remotes** listed in the Profile Directory. The screen will update accordingly as you scroll between options.

### **Auto-Update**

Use this field to have this screen automatically update with events while you are viewing the screen. <On> will update the screen every 5 seconds.

### **Port Name**

Displays the information, listing by Port.

## ***System Reports Window***

### ***Address Tables***

---

# CHAPTER 10

---

## *Exit Window*

### **In this Chapter**

- Logout
- Reinitialize

## Logout

1. On the Main Menu, press [TAB] until the **Logout** is highlighted on the **Exit** option.

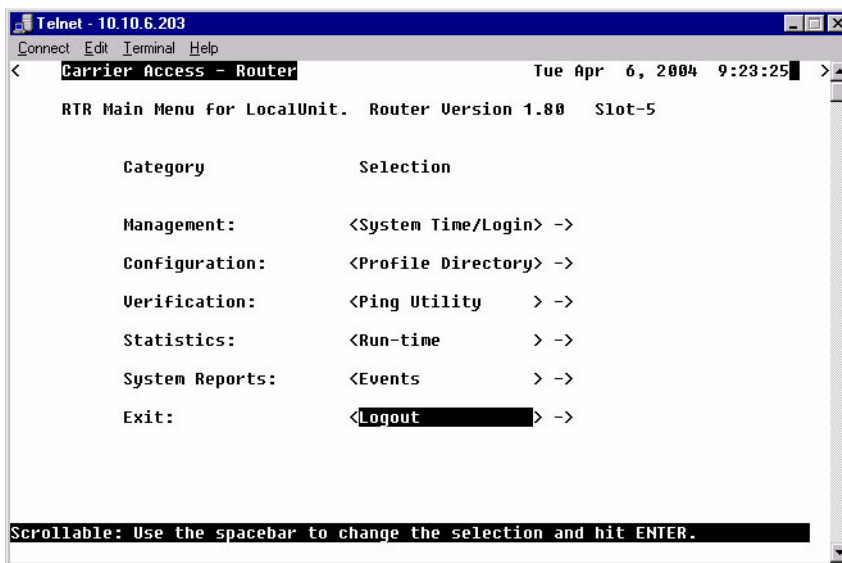

```
Telnet - 10.10.6.203
Connect Edit Terminal Help
< Carrier Access - Router Tue Apr 6, 2004 9:23:25 >
RTR Main Menu for LocalUnit. Router Version 1.80 Slot-5

Category          Selection

Management:      <System Time/Login> ->
Configuration:   <Profile Directory> ->
Verification:    <Ping Utility   > ->
Statistics:      <Run-time       > ->
System Reports:  <Events         > ->
Exit:            <Logout        > ->

Scrollable: Use the spacebar to change the selection and hit ENTER.
```

2. Press [ENTER]. The system will exit out of the Router Menu-Drive software and the following message is displayed.



```
Telnet - 192.168.3.194
Connect Edit Terminal Help

Session released on Mon Mar 3, 2003 13:26:16
Terminating Carrier Access Router connection . .
Connection closed by foreign host.

> █
```



## **Reinitialize**

Some changes that you make to the Management software will not take effect until the Router is reinitialized. Since this procedure is common to all functions within the software, the reinitialization procedure appears on the Main Menu.

1. On the Main Menu, press [TAB] until the **Logout** is highlighted on the **Exit** option.
2. Press [SPACEBAR] to scroll to **Reinitialize**.

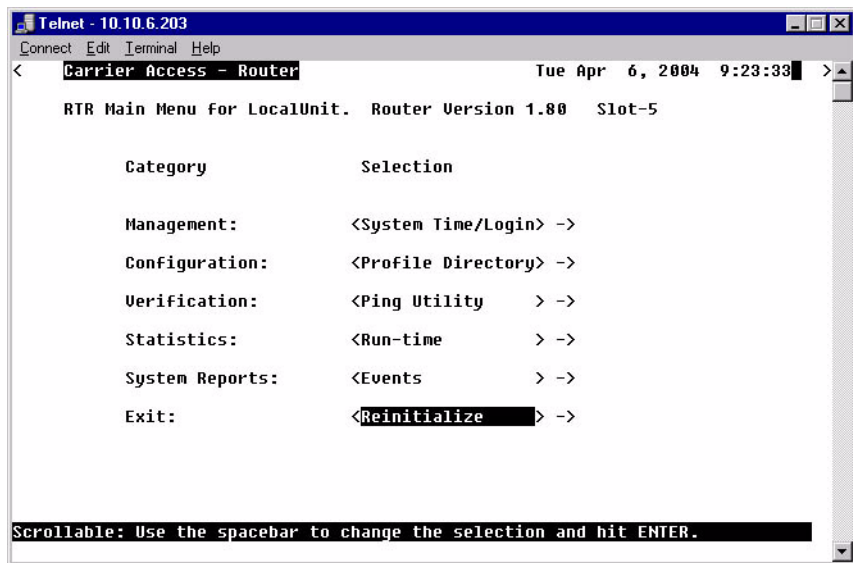

```
Telnet - 10.10.6.203
Connect Edit Terminal Help
< Carrier Access - Router Tue Apr 6, 2004 9:23:33 >
RTR Main Menu for LocalUnit. Router Version 1.80 Slot-5

Category Selection

Management: <System Time/Login> ->
Configuration: <Profile Directory> ->
Verification: <Ping Utility > ->
Statistics: <Run-time > ->
System Reports: <Events > ->
Exit: <Reinitialize > ->

Scrollable: Use the spacebar to change the selection and hit ENTER.
```

3. Press [ENTER]. The following message is displayed:

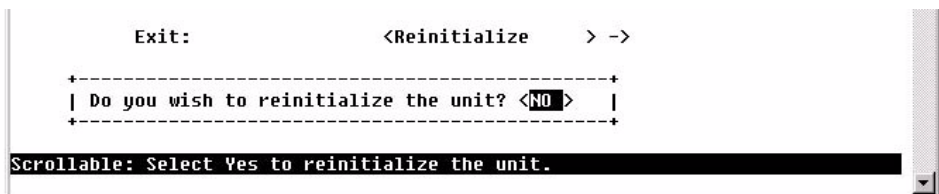

```
Exit: <Reinitialize > ->
+-----+
| Do you wish to reinitialize the unit? <NO > |
+-----+

Scrollable: Select Yes to reinitialize the unit.
```

## ***Exit Window***

### *Reinitialize*

---

4. Press [SPACEBAR] to scroll <NO> to <YES>, and press [ENTER].

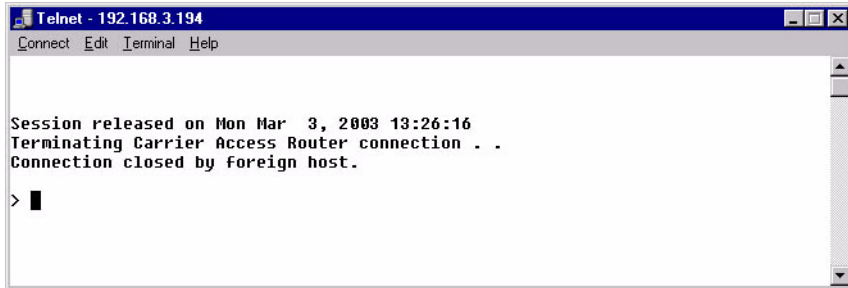

The screenshot shows a Telnet terminal window titled "Telnet - 192.168.3.194". The window has a menu bar with "Connect", "Edit", "Terminal", and "Help". The main text area displays the following message:

```
Session released on Mon Mar 3, 2003 13:26:16  
Terminating Carrier Access Router connection . .  
Connection closed by foreign host.  
> █
```

5. System will close the session and reboot.

# CHAPTER 11

---

## *Router Configuration*

### **In this Chapter**

- Basic Setup
- PPP Internet Connection and Public IP Address Routing
- Frame Relay Internet Connection and Public IP Address Routing
- Internet Connection using PPP, NAT/PAT and Firewall Filters
- Internet Connection using NAT and Static NAT Addresses
- PPP Internet Connection and Public IP Address Routing
- Back-to-Back with PPP
- Back-to-Back with Frame Relay

## Router Configuration

### Basic Setup

---

## Basic Setup

Command	Description
<code>set {ds0-addr} type data</code>	Confirm DS0 is set to type data. ds0-addr = {slot:port:channel} of DS0 Example: set a:1:1-24 type data
<code>connect {slot:port:trunk} {slot:port:channel}</code>	Cross-connect T1 to router card. Example: connect a:1:1-24 6:1:1 (router in slot 6)
<code>set {router-addr} proxy</code>	Disable/enable router proxy. router-addr = {slot:port} of router card. Example: set 6:1 disable.
<code>set {slot:port} up</code>	Set Router LAN as In-Service. Example: set 6:1 up
<code>telnet {router_card-addr}</code>	Telnet to Router card. router_card-addr = {slot} location of router card Example: telnet 6 (if earlier than 3.0 release {slot:port} must be used)
Local and Remote Profile Setup	
<code>reinitialize</code>	To enable any configuration changes, the card must be reinitialized.

## **PPP Internet Connection and Public IP Address Routing**

### **Router in Slot 1**

ISP Router that provides the Internet connection.

<b>Command</b>	<b>Description</b>
<code>set clock1 a:1</code>	Set primary master transmit clock source
<code>set 1 default</code>	Set Router to default settings
<code>disconnect a:1</code>	Disconnect all connections to the T1 on the Controller (slot a)
<code>disconnect 1</code>	Disconnect all connections to the router in slot 1
<code>set a:1:all type data</code>	Set the T1-1 of the Controller, Type to Data
<code>connect a:1:all 1:1:1</code>	Connect all of T1-1 to the Router that is in slot 1
<code>rename 1 "LocalUnit" "Boulder"</code>	Rename the Adit 600 from "LocalUnit" (default) to "Boulder" (LAN)
<code>rename 1 "RemoteUnit" "wan1"</code>	Rename WAN #1 from "RemoteUnit" (default) to "wan1"
<code>set 1:1 ip address 215.168.21.14 255.255.255.0</code>	Set the Ethernet IP address, in the conventional IP address format. (Router LAN)
<code>add 1 "wan1" static ip network 0.0.0.0 0.0.0.0 1</code>	Adds a static IP network (route) to the WAN interface
<code>set 1 "wan1" trunk 1</code>	Set the WAN interface named "wan1" to be mapped to trunk 1
<code>set 1:1:1 encapsulation ppp</code>	Set the encapsulation on trunk 1 to PPP
<code>reset 1</code>	Reboot the router, to enable all configurations set

## Router Configuration

### Frame Relay Internet Connection and Public IP Address Routing

---

# Frame Relay Internet Connection and Public IP Address Routing

## Router in Slot 1

ISP Router that provides the Internet connection.

Command	Description
set clock1 a:1	Set primary master transmit clock source
set 1 default	Set Router to default settings
disconnect a:1	Disconnect all connections to the T1 on the Controller (slot a)
disconnect 1	Disconnect all connections to the router in slot 1
set a:1:all type data	Set the T1-1 of the Controller, Type to Data
connect a:1:all 1:1:1	Connect all of T1-1 to the Router that is in slot 1
rename 1 "LocalUnit" "Boulder"	Rename the Adit 600 from "LocalUnit" (default) to "Boulder" (LAN)
rename 1 "RemoteUnit" "wan1"	Rename WAN #1 from "RemoteUnit" (default) to "wan1"
set 1:1 ip address 215.168.21.14 255.255.255.0	Set the Ethernet IP address, in the conventional IP address format. (Router LAN)
add 1 "wan1" static ip network 0.0.0.0 0.0.0.0 1	Adds a static IP network (route) to the WAN interface
set 1:1:1 encapsulation fr	Set the encapsulation on trunk 1 to Frame Relay
set 1 lmi annexd	Disable LMI to Annex D
set 1 "wan1" trunk 1	Set the WAN interface named "wan1" to be mapped to trunk 1
set 1 "wan1" dlci 101	Set the DLCI number
reset 1	Reboot the router, to enable all configurations set

# **Internet Connection using PPP, NAT/PAT and Firewall Filters**

## **Router in Slot 1**

ISP Router that provides the Internet connection. Router with NAT/PAT and Firewall Filters.

<b>Command</b>	<b>Description</b>
<code>set clock1 a:1</code>	Set primary master transmit clock source
<code>set 1 default</code>	Set Router to default settings
<code>disconnect a:1</code>	Disconnect all connections to the T1 on the Controller (slot a)
<code>disconnect 1</code>	Disconnect all connections to the router in slot 1
<code>set a:1:all type data</code>	Set the T1-1 of the Controller, Type to Data
<code>connect a:1:all 1:1:1</code>	Connect all of T1-1 to the Router that is in slot 1
<code>rename 1 "LocalUnit" "Boulder"</code>	Rename the Adit 600 from "LocalUnit" (default) to "Boulder" (LAN)
<code>rename 1 "RemoteUnit" "wan1"</code>	Rename WAN #1 from "RemoteUnit" (default) to "wan1"
<code>set 1:1 ip address 192.168.21.14 255.255.255.0</code>	Set the Ethernet IP address, in the conventional IP address format. (Router LAN)
<code>set 1 "wan1" nat enable</code>	Set the WAN interface named "wan1" enable NAT mapping
<code>set 1 "wan1" nat port dynamic</code>	Set the WAN interface named "wan1" to set NAT port mapping to be dynamic
<code>set 1 "wan1" nat address 216.174.44.2 1</code>	Set the WAN interface named "wan1" NAT address
<code>add 1 "wan1" static ip network 0.0.0.0 0.0.0.0 1</code>	Adds a static IP network (route) to the WAN interface

## Router Configuration

### Internet Connection using PPP, NAT/PAT and Firewall Filters

---

Command	Description
<pre>add 1 "wan1" firewall 1 pass incoming log telnet 192.168.21.14/32 xxx.xxx.xxx.xxx/32</pre>	Adds a Firewall rule to the WAN. Where xxx.xxx.xxx.xxx is the host's IP address at the far end that will be able to ping or Telnet to the router. 0.0.0.0/0 will allow any other host at the far end to ping and/or Telnet to the router.
<pre>add 1 "wan1" firewall 2 pass inout nolog ping 192.168.21.14/32 xxx.xxx.xxx.xxx/32</pre>	Adds a Firewall rule to the WAN. Where xxx.xxx.xxx.xxx is the host's IP address at the far end that will be able to ping or Telnet to the router. 0.0.0.0/0 will allow any other host at the far end to ping and/or Telnet to the router.
<pre>add 1 "wan1" firewall 3 pass inout nolog ping 0.0.0.0/0 0.0.0.0/0</pre>	Adds a Firewall rule to the WAN.
<pre>add 1 "wan1" firewall 4 pass inout nolog tcp 1-65535 0.0.0.0/0 0.0.0.0/0</pre>	Adds a Firewall rule to the WAN.
<pre>add 1 "wan1" firewall 5 pass inout nolog udp 1-65535 0.0.0.0/0 0.0.0.0/0</pre>	Adds a Firewall rule to the WAN.
<pre>set 1 "wan1" trunk 1</pre>	Set the WAN interface named "wan1" to be mapped to trunk 1
<pre>set 1:1:1 encapsulation ppp</pre>	Set the encapsulation on trunk 1 to PPP
<pre>reset 1</pre>	Reboot the router, to enable all configurations set



## **Internet Connection using NAT and Static NAT Addresses**

### **Router in Slot 1**

ISP Router that provides the Internet connection. Router with NAT and Static NAT addresses.

<b>Command</b>	<b>Description</b>
<code>set clock1 a:1</code>	Set primary master transmit clock source
<code>set 1 default</code>	Set Router to default settings
<code>disconnect a:1</code>	Disconnect all connections to the T1 on the Controller (slot a)
<code>disconnect 1</code>	Disconnect all connections to the router in slot 1
<code>set a:1:all type data</code>	Set the T1-1 of the Controller, Type to Data
<code>connect a:1:all 1:1:1</code>	Connect all of T1-1 to the Router that is in slot 1
<code>rename 1 "LocalUnit" "Boulder"</code>	Rename the Adit 600 from "LocalUnit" (default) to "Boulder" (LAN)
<code>rename 1 "RemoteUnit" "wan1"</code>	Rename WAN #1 from "RemoteUnit" (default) to "wan1"
<code>set ethernet ip address 192.168.21.15 255.255.255.0</code>	Set the Ethernet IP address and Subnet Mask, for the Adit 600
<code>set ip gateway 192.168.21.14</code>	Set the IP gateway (default route), for the Adit 600
<code>set 1:1 ip address 192.168.21.14 255.255.255.0</code>	Set the Ethernet IP address, in the conventional IP address format. (Router LAN)
<code>set 1 "wan1" nat enable</code>	Set the WAN interface named "wan1" enable NAT mapping
<code>set 1 "wan1" nat port dynamic</code>	Set the WAN interface named "wan1" to set NAT port mapping to be dynamic
<code>set 1 "wan1" nat address 216.174.44.2 1</code>	Set the WAN interface named "wan1" NAT address

## Router Configuration

### Internet Connection using NAT and Static NAT Addresses

---

Command	Description
<code>add 1 "wan1" static ip network 0.0.0.0 0.0.0.0 1</code>	Adds a static IP network (route) to the WAN interface
<code>add 1 "wan1" static nat address 192.168.21.14 216.174.44.232</code>	Add static NAT bi-directional mapping to wan1
<code>add 1 "wan1" static nat address 192.168.21.15 216.174.44.233</code>	Add static NAT bi-directional mapping to wan1
<code>add 1 "wan1" static nat address 192.168.21.16 216.174.44.234</code>	Add static NAT bi-directional mapping to wan1
<code>add 1 "wan1" static nat address 192.168.21.17 216.174.44.235</code>	Add static NAT bi-directional mapping to wan1
<code>set 1:1:1 encapsulation fr</code>	Set the encapsulation on trunk 1 to Frame Relay
<code>set 1 lmi annexd</code>	Disable LMI Annex D
<code>set 1 "wan1" trunk 1</code>	Set the WAN interface named "wan1" to be mapped to trunk 1
<code>set 1 "wan1" dlci 101</code>	Set the DLCI number
<code>reset 1</code>	Reboot the router, to enable all configurations set

216.174.44.232 is the static NAT address assigned to the router.

216.174.44.233 is the static NAT address assigned to the controller.

216.174.44.234 is the static NAT address for a server\*.

216.174.44.235 is the static NAT address for a host\*.

\*In the private network that can be reached from the outside world.

There can be up to 16 static NAT addresses, therefore the actual range can be 216.174.44.232 to 216.174.44.247. Only 4 were used in this example.

## Back-to-Back with PPP

The following configuration will set up two Routers back-to-back with PPP.

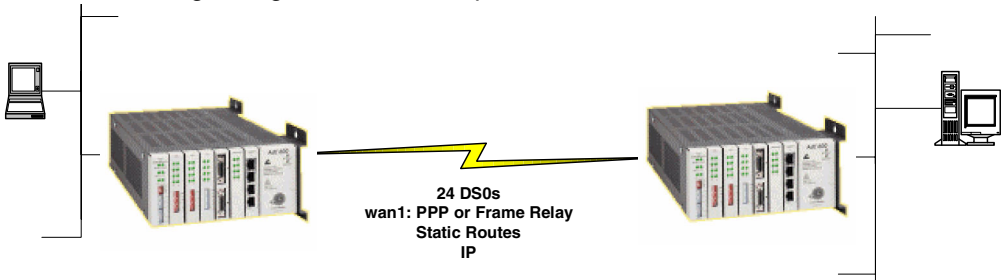

### Boulder Router in Slot 1

Command	Description
set 1 default	Set Router to default settings
disconnect a:1	Disconnect all connections to the T1 on the Controller (slot a)
disconnect 1	Disconnect all connections to the router in slot 1
set a:1:all type data	Set the T1-1 of the Controller, Type to Data
connect a:1:all 1:1:1	Connect all of T1-1 to the Router that is in slot 1
rename 1 "LocalUnit" "Boulder"	Rename the Adit 600 from "LocalUnit" (default) to "Boulder" (LAN)
rename 1 "RemoteUnit" "wan1"	Rename WAN #1 from "RemoteUnit" (default) to "wan1"
set 1:1 ip address 1.1.1.1 255.255.255.0	Set the Ethernet IP address, in the conventional IP address format. (Router LAN)
set 1:1 phy auto	Set the Physical Specifications to auto-negotiate
set 1 "wan1" rip ip updates never	Set "wan1" to not send RIP updates
add 1 "wan1" static ip network 2.2.2.0 255.255.255.0 1	Adds a static IP network (route) to the WAN interface
set 1:1:1 encapsulation ppp	Set the encapsulation on trunk 1 to PPP
set 1 "wan1" trunk 1	Set the WAN interface named "wan1" to be mapped to trunk 1
reset 1	Reboot the router, to enable all configurations set

## Router Configuration

### Back-to-Back with PPP

---

#### Denver Router in Slot 1

Command	Description
set 1 default	Set Router to default settings
disconnect a:1	Disconnect all connections to the T1 on the Controller (slot a)
disconnect 1	Disconnect all connections to the router in slot 1
set clock1 a:1	Set primary master transmit clock source
set a:1:all type data	Set the T1-1 of the Controller, Type to Data
connect a:1:all 1:1:1	Connect all of T1-1 to the Router that is in slot 1
rename 1 "LocalUnit" "Denver"	Rename the Adit 600 from "LocalUnit" (default) to "Denver" (LAN)
rename 1 "RemoteUnit" "wan1"	Rename WAN #1 from "RemoteUnit" (default) to "wan1"
set 1:1 ip address 2.2.2.1 255.255.255.0	Set the Ethernet IP address, in the conventional IP address format. (Router LAN)
set 1:1 phy auto	Set the Physical Specifications to auto-negotiate
set 1 "wan1" rip ip updates never	Set "wan1" to not send RIP updates
add 1 "wan1" static ip network 1.1.1.0 255.255.255.0 1	Adds a static IP network (route) to the WAN interface
set 1:1:1 encapsulation ppp	Set the encapsulation on trunk 1 to PPP
set 1 "wan1" trunk 1	Set the WAN interface named "wan1" to be mapped to trunk 1
reset 1	Reboot the router, to enable all configurations set

## Back-to-Back with Frame Relay

The following configuration will set up two Routers back-to-back with Frame Relay.

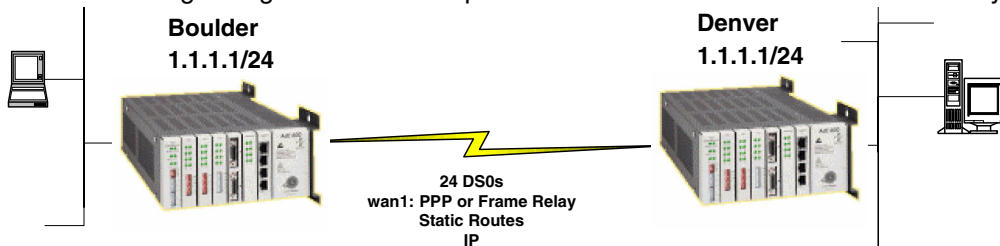

### Boulder Router in Slot 1

Command	Description
<code>set clock1 internal</code>	Set primary master transmit clock source
<code>set 1 default</code>	Set Router to default settings
<code>disconnect a:1</code>	Disconnect all connections to the T1 on the Controller (slot a)
<code>disconnect 1</code>	Disconnect all connections to the router in slot 1
<code>set a:1:all type data</code>	Set the T1-1 of the Controller, Type to Data
<code>connect a:1:all 1:1:1</code>	Connect all of T1-1 to the Router that is in slot 1
<code>rename 1 "LocalUnit" "Boulder"</code>	Rename the Adit 600 from "LocalUnit" (default) to "Boulder" (LAN)
<code>rename 1 "RemoteUnit" "wan1"</code>	Rename WAN #1 from "RemoteUnit" (default) to "wan1"
<code>set 1:1 ip address 1.1.1.1 255.255.255.0</code>	Set the Ethernet IP address, in the conventional IP address format. (Router LAN)
<code>set 1:1 phy auto</code>	Set the Physical Specifications to auto-negotiate
<code>add 1 "wan1" static ip network 2.2.2.0 255.255.255.0 1</code>	Adds a static IP network (route) to the WAN interface
<code>set 1:1:1 encapsulation fr</code>	Set the encapsulation on trunk 1 to Frame Relay
<code>set 1 lmi disable</code>	Disable LMI (Local Management Interface)
<code>set 1 "wan1" trunk 1</code>	Set the WAN interface named "wan1" to be mapped to trunk 1

## Router Configuration

### Back-to-Back with Frame Relay

set 1 "wan1" dlci 101	Set the DLCI number
reset 1	Reboot the router, to enable all configurations set

### Denver Router in Slot 3

Command	Description
set 3 default	Set Router to default settings
disconnect a:1	Disconnect all connections to the T1 on the Controller (slot a)
disconnect 3	Disconnect all connections to the router in slot 1
set clock1 a:1	Set primary master transmit clock source
set a:1:all type data	Set the T1-1 of the Controller, Type to Data
connect a:1:all 3:1:1	Connect all of T1-1 to the Router that is in slot 1
rename 3 "LocalUnit" "Denver"	Rename the Adit 600 from "LocalUnit" (default) to "Denver" (LAN)
rename 3 "RemoteUnit" "wan1"	Rename WAN #1 from "RemoteUnit" (default) to "wan1"
set 3:1 ip address 2.2.2.1 255.255.255.0	Set the Ethernet IP address, in the conventional IP address format. (Router LAN)
set 3:1 phy auto	Set the Physical Specifications to auto-negotiate
set 3 "wan1" rip ip updates never	Set "wan1" to not send RIP updates
add 3 "wan1" static ip network 1.1.1.0 255.255.255.0 1	Adds a static IP network (route) to the WAN interface
set 3:1:1 encapsulation fr	Set the encapsulation on trunk 1 to Frame Relay
set 3 lmi disable	Disable LMI (Local Management Interface)
set 3 "wan1" trunk 1	Set the WAN interface named "wan1" to be mapped to trunk 1
set 3 "wan1" dlci 101	Set the DLCI number
reset 3	Reboot the router, to enable all configurations set

# APPENDIX **A**

---

## ***User Events***

### **In this Appendix**

- User Events
- Authenticate Events
- Triggered Events
- Alarms

## **User Events**

### **Description**

“access” login terminated

Adit Initialized

“IP Address” was dynamically assigned by “remote”

Login accepted at “access” level

Login rejected

Password changed for “access” level

Port “X” connected

Port “X” down

System Date/Time Change recorded

Terminal inactivity, login terminated



## ***Authenticate Events***

### ***Description***

“*sysname*” failed to authenticate us using CHAP

“*sysname*” failed to authenticate us using PAP

Authentication successful to “*remote*” using CHAP

Authentication successful to “*remote*” using PAP

Authentication failure to “*remote*” using CHAP

Authentication failure to “*remote*” using CHAP  
CHAP secret mismatch

Authentication failure to “*remote*” using CHAP  
system name mismatch

Authentication failure to “*remote*” using CHAP  
Retry timeout occurred

WAN protocol is active (inactive) to “*remote*” on port “X”

LCP negotiation was successful to “*remote*”

IPCP negotiation was successful to “*remote*”

CCP negotiation failed to

## ***Triggered Events***

### ***Description***

Triggered IPX Network request from “X”

Triggered IPX Server request (to) from “X”

Triggered 802.3 IPX Server update (to) from “X”

Triggered 802.3 IPX Network update (to) from “X”

Triggered 802.2 IPX Server update (to) from “X”

Triggered 802.2 IPX Network update (to) from “X”

Triggered ETH II IPX Network update (to) from “X”

Triggered ETH II IPX Server update (to) from “X”

Triggered SNAP IPX Network update (to) from “X”

Triggered SNAP IPX Server update (to) from “X”

Triggered IP Network request (to) from “X”

Triggered ETH II IP Network update (to) from “X”

## ***Alarms***

Data integrity fault detected and corrected

This is logged when the unit detects and recovers from a loss of data synchronization.

Dedicated trunk connection on Port “X” lost

### ***Description***

[Local LAN, “remote”] [IPX SAP, IPX RIP] [“server name”, “network”] exists at [Local LAN, “remote”]

MAC Address Table is full

Triggered 802.3 IPX (Eth II IP) network update to “remote” fail

Triggered 802.3 IPX server update to “remote” fail

WAN data loss detected, recovery action taken

This is logged when the unit begins the recovery process from trunks with high error conditions.

[Pass, Drop] [dyn] [Any, Protocol=xx, Type=xx, Port=xx] [to, from] <rem sys>  
Firewall Rule <rule num>

---

**NOTE:** All alarms generate SNMP traps.

---

## ***User Events***

### ***Alarms***

---

# APPENDIX **B**

---

## *Protocol Types*

### **In this Appendix**

- Protocol Number in Firewall Filters
- Ethernet Protocol Types

## Protocol Types

### Protocol Number in Firewall Filters

---

## Protocol Number in Firewall Filters

In the Router cards we can filter based on protocol numbers in the Firewall Filters (WAN). See *Firewall Filters* on page 5-29 for Firewall instructions and See *Service* on page 5-33 for the field where this protocol number is entered.

Number	Keyword	Protocol	Reference
0	HOPOPT	IPv6 Hop-by-Hop Option	[RFC1883]
1	ICMP	Internet Control Message	[RFC702]
2	IGMP	Internet Group Management	[RFC1112]
3	GGP	Gateway-to-Gateway	[RFC823]
4	IP	IP in PIP (encapsulation)	[RFC2003]
5	ST	Stream	[RFC1190, RFC1819]
6	TCP	Transmission Control	[RFC793]
7	CBT	CBT	[Ballardie]
8	EGP	Exterior Gateway Protocol	[RFC888, DLM1]
9	IGP	any private interior gateway (used by Cisco for their IGRP)	[IANA]
10	BBN-RCC-MON	BBN RCC Monitoring	[SGC]
11	NVP-II	Network Voice Protocol	[RFC741, SC3]
12	PUP	PUP	[PUP, XEROX]
13	ARGUS	ARGUS	[RWS4]
14	EMCON	EMCON	[BN7]
15	XNET	Cross Net Debugger	[IEN158, JFH2]
16	CHAOS	Chaos	[NC3]
17	UDP	User Datagram	[RFC768, JBP]
18	MUX	Multiplexing	[IEN90, JBP]
19	DCN-MEAS	DCN Measurement Subsystems	[DLM1]
20	HMP	Host Monitoring	[RFC890, RH6]
21	PRM	Packet Radio Measurement	[ZSU]
22	XNS-IDP	XEROX NS IDP	[ETHERNET, XEROX]
23	TRUNK-1	Trunk-1	[BWB6]
24	TRUNK-2	Trunk-2	[BWB6]
25	LEAF-1	Leaf-1	[BWB6]

**Protocol Types**  
*Protocol Number in Firewall Filters*

Number	Keyword	Protocol	Reference
26	LEAF-2	Leaf-2	[BWB6]
27	RDP	Reliable Data Protocol	[RFC908, RH6]
28	IRTP	Internet Reliable Transaction	[RFC938, TXM]
29	ISO-TP4	ISO Transport Protocol Class 4	[RFC905, RC77]
30	NETBLT	Bulk Data Transfer Protocol	[RFC969, DDC1]
31	MFE-NSP	NFE Network Services Protocol	[MFENET, BCH2]
32	MERIT-INP	MERIT Internodal Protocol	[HWB]
33	SEP	Sequential Exchange Protocol	[JC120]
34	3PC	Third Party Connect Protocol	[SAF3]
35	IDPR	Inter-Domain Policy Routing Protocol	[MXS1]
36	XTP	XTP	[GXC]
37	DDP	Datagram Delivery Protocol	[WXC]
38	IDPR-CMTP	IDPR Control Message Transport Protocol	[MXS1]
39	TP++	TP++ Transport Protocol	[DXF]
40	IL	IL Transport Protocol	[Presotto]
41	IPv6	IPv6	[Deering]
42	SDRP	Source Demand Routing Protocol	[DXE1]
43	IPv6-Route	Routing Header for IPv6	[Deering]
44	IPv6-Frag	Fragment Header for IPv6	[Deering]
45	IDRP	Inter-Domain Routing Protocol	[Sue Hares]
46	RSVP	Reservation Protocol	[Bob Braden]
47	GRE	General Routing Encapsulation	[Tony Li]
48	MHRP	Mobile Host Routing Protocol	[David Johnson]
49	BNA	BNA	[Gary Salamon]
50	ESP	Encap Security Payload for IPv6	[RFC2406]
51	AH	Authentication Header for IPv6	[RFC2402]
52	I-NLSP	Integrated Net Layer Security TUBA	[GLENN]
53	SWIPE	IP with Encryption	[J16]
54	NARP	NBMA Address Resolution Protocol	[RFC1735]
55	MOBILE	IP Mobility	[Perkins]

## Protocol Types

### Protocol Number in Firewall Filters

---

Number	Keyword	Protocol	Reference
56	TLSP	Transport Layer Security Protocol using Kryptonnet key management	[Oberg]
57	SKIP	SKIP	[Markson]
58	IPv6-ICMP	ICMP for IPv6	[RFC1883]
59	IPv6-NoNxt	No Next Header for IPv6	[RFC1883]
60	IPv6-Opts	Destination Options for IPv6	[RFC1883]
61		any host internal protocol	[IANA]
62	CFTP	CFTP	[CFTP, HCF2]
63		any local network	[IANA]
64	SAT-EXPAK	SATNET and Backroom EXPAK	[SHB]
65	KRYPTOLAN	Kryptolan	[PXL1]
66	RVD	MIT Remote Virtual Disk Protocol	[MBG]
67	IPPC	Internet Pluribus Packet Core	[SHB]
68		any distributed file system	[IANA]
69	SAT-MON	SATNET Monitoring	[SHB]
70	VISA	VISA Protocol	[GXT1]
71	IPCV	Internet Packet Core Utility	[SHB]
72	CPNX	Computer Protocol Network Executive	[DXM2]
73	CPHB	Computer Protocol Heart Beat	[DXM2]
74	WSN	Wang Span Network	[VXD]
75	PVP	Packet Video Protocol	[SC3]
76	BR-SAT-MON	Backroom SATNET Monitoring	[SHB]
77	SUN-ND	SUN ND PROTOCOL-Temporary	[WM3]
78	WB-MON	WIDEBAND Monitoring	[SHB]
79	WB-EXPAK	WIDEBAND EXPAK	[SHB]
80	ISO-IP	ISO Internet Protocol	[MTR]
81	VMTP	VMTP	[DRC3]
82	SECURE-VMTP	SECURE-VMTP	[DRC3]
83	VINES	VINES	[BXH]
84	TTP	TTP	[JXS]
85	NSFNET-IGP	NSFNET-IGP	[HWB]
86	DGP	Dissimilar Gateway Protocol	[DGP, ML109]



<b>Number</b>	<b>Keyword</b>	<b>Protocol</b>	<b>Reference</b>
87	TCF	TCF	[GAL5]
88	EIGRP	EIGRP	[CISCO, GXS]
89	OSPFGRP	OSPFGRP	[RFC1583, JTM4]
90	Sprite-RPC	Sprite RPC Protocol	[SPRITE, BXW]
91	LARP	Locus Address Resolution Protocol	[BXH]
92	MTP	Multicast Transport Protocol	[SXA]
93	AX.25	AZ.25 Frames	[BK29]
94	IPIP	IP-within-IP Encapsulation Protocol	[JI6]
95	MICP	Mobile Internetworking Control Pro	[JI6]
96	SCC-SP	Semaphore Communications Sec. Pro.	[HXH]
97	ETHERIP	Ethernet-within-IP Encapsulation	[RFC3378]
98	ENCAP	Encapsulation Header	[FRC1241, RXB3]
99		any private encryption scheme	[IANA]
100	GMTP	GMTP	[RXB5]
101	IFMP	Ipsilon Flow Management Protocol	[Hinden]
102	PNNI	PNNI over IP	[Callon]
103	PIM	Protocol Independent Multicast	[Farinacci]
104	ARIS	ARIS	[Feldman]
105	SCPS	SCPS	[Durst]
106	QNX	QNX	[Hunter]
107	A/N	Active Networks	[Braden]
108	IPComp	IP Payload Compression Protocol	[RFC2393]
109	SNP	Sitara Networks Protocol	[Sridhar]
110	Compaq-Peer	Compaq Peer Protocol	[Volpe]
111	IPX-in-IP	IPX in IP	[Lee]
112	VRRP	Virtual Router Redundancy Protocol	[Hinden]
113	PGM	PBM Reliable Transport Protocol	[Speakman]
114		any 0-hop protocol	[IANA]
115	L2TP	Layer Two Tunneling Protocol	[Aboba]
116	DDX	D-II Data Exchange (DDX)	[Worley]
117	IATP	Interactive Agent Transfer Protocol	[Murphy]
118	STP	Schedule Transfer Protocol	[JMP]

## ***Protocol Types***

### *Protocol Number in Firewall Filters*

---

<b>Number</b>	<b>Keyword</b>	<b>Protocol</b>	<b>Reference</b>
119	SRP	SpectraLink Radio Protocol	[Hamilton]
120	UTI	UTI	[Lothberg]
121	SMP	SMP	[Ekblad]
122	SM	SM	[Crowcroft]
123	PTP	Performance Transparency Protocol	[Welzl]
124	ISIS over IPv4		[Przygienda]
125	FIRE		[Partridge]
126	CRTP	Combat Radio Transport Protocol	[Sautter]
127	CRUDP	Combat Radio User Datagram	[Sautter]
128	SSCOPMCE		[Waber]
129	IPLT		[Hollbach]
130	SPS	Secure Packet Shield	[McIntosh]
131	PIPE	Private IP Encapsulation within IP	[Petri]
132	SCTP	Stream Control Transmission Protocol	[Stewart]
133	FC	Fibre Channel	[Rajagopal]
134	RSVP-E2E-IGNORE		[RFC3175]
135-254		Unassigned	[IANA]
255		Reserved	[IANA]

## **Ethernet Protocol Types**

This table defines the protocol types that would be used by the LAN Protocol filters. The associated Hex number is entered into the Ethernet Value field see, *Defining Protocol Filters on page 4-23*.

<b>HEX</b>	<b>DESCRIPTION</b>
0000-05DC	IEEE 802.3 Length Field (0-1500 decimal)
1010-01FF	Experimental (for development) Conflicts with 802.3 length fields
0200	Xerox PUP - Conflicts with 802.3 length fields
0201	PUP Address Translation - Conflicts with 802.3 length fields
0600	Xeros XNS IDP
0800	DOD IP
0801	X.75 Internet
0802	NBS Internet
0803	ECMA Internet
0804	CHAOSnet
0805	X.25 Level 3
0806	ARP (for IP and for CHAOS)
0807	SNX Compatibility
081C	Symbolics Private
0888-088A	Xyplex
0900	Ungermann-Bass network debugger
0A00	Xerox 802.3 PUP
0A01	PUP 802.3 Address Translation

## ***Protocol Types***

### *Ethernet Protocol Types*

---

<b>HEX</b>	<b>DESCRIPTION</b>
0BAD	Banyan Systems Inc.
1000	Berkeley trailer negotiation
1001-100F	Berkeley Trailer encapsulation
1600	VALID
4242	BXS Basic Block Protocol
5208	BBN Simnet Private
6000	DEC Unassigned
6001	DEC MOP Dump/Load Assistance
6002	DEC MOP Remote Console
6003	DEC DECnet Phase IV
6004	DEC LAT
6005	DEC DECnet Diagnostics
6006	DEC DECnet Customer Use
6007	DEC DECnet SCA
6008	DEC unassigned
6009	DEC unassigned
6010-6014	3Com Corporation
7000	Ungermann-Bass download
7001	Ungermann-Bass NIU
7002	Ungermann-Bass NIU
7007	OS/9 Microware

<b>HEX</b>	<b>DESCRIPTION</b>
7020-7029	LRT (England)
7030	Proteon
7034	Cabletron
8003	Cronus VLN
8004	Cronus Direct
8005	HP Probe protocol
8006	Nestar
8008	AT&T
8010	Excelan
8013	SGI diagnostic type (obsolete)
8014	SGI network games (obsolete)
8015	SGI reserved type (obsolete)
8016	SGI "bounce server" (obsolete)
8019	Apollo
802E	Tymshare
802F	Tigan, Inc.
8035	Reverse ARP
8036	Aeonic Systems
8038	DEC LANBridge
8039	DEC Unassigned
803A	DEC Unassigned

## ***Protocol Types***

### *Ethernet Protocol Types*

---

<b>HEX</b>	<b>DESCRIPTION</b>
803B	DEC Unassigned
803C	DEC Unassigned
803D	DEC Ethernet CSMA/CD Encryption Protocol
803E	DEC Unassigned
803F	DEC LAN Traffic Monitor
8040	DEC Unassigned
8041	DEC Unassigned
8042	DEC Unassigned
8044	Planning Research Corporation
8046	AT&T
8047	AT&T
8049	ExperData (France)
805B	VMTP (Versatile Message Transaction Protocol, RFC-1045, Stanford)
805C	Stanford V Kernel production, Version 6.0
805D	Evans & Sutherland
8060	Little Machines
8062	Counterpoint Computers
8065	University of Massachusetts, Amherst
8066	University of Massachusetts, Amherst
8067	Veeco Integrated Automation

<b>HEX</b>	<b>DESCRIPTION</b>
8068	General Dynamics
8069	AT&T
806A	Autophon (Switzerland)
806C	ComDesign
806D	Compugraphic Corporation
806E-8077	Landmark Graphics Corporation
807A	Matra (France)
807B	Dansk Data Elektronik A/S (Denmark)
807C	Merit Internodal
807D	VitaLink Communications
807E	VitaLink Communications
807F	VitaLink Communications
8080	VitaLink Communications bridge
8081	Counterpoint Computers
8082	Counterpoint Computers
8083	Counterpoint Computers
8088	Xyplex
8089	Xyplex
808A	Xyplex
809B	Kinetics Ethertalk-Appletalk over Ethernet
809C	Datability

## ***Protocol Types***

### *Ethernet Protocol Types*

---

<b>HEX</b>	<b>DESCRIPTION</b>
809D	Datability
809E	Datability
809F	Spider Systems, Ltd. (England)
80A3	Nixdorf Computer (West Germany)
80A4-80B3	Siemens Gammasonics Inc.
80C0	Digital Communication Associates
80C1	Digital Communication Associates
80C2	Digital Communication Associates
80C3	Digital Communication Associates
80C6	Pacer Software
80C7	Applitek Corporation
80C8-80CC	Integraph Corporation
80CD	Harris Corporation
80CE	Harris Corporation
80CF-80D2	Taylor Inst.
80D3	Rosemount Corporation
80D4	Rosemount Corporation
80D5	IBM SNA Services over Ethernet
80DD	Varian Associates
80DE	Integrated Solutions TRFS (Transparent Remote File System)
80DF	Integrated Solutions



<b>HEX</b>	<b>DESCRIPTION</b>
80E0-80E3	Allen-Bradley
80E4-80F0	Datability
80F2	Retix
80F3	Kinetics, AppleTalk ARP (AARP)
80F4	Kinetics
80F5	Kinetics
80F7	Apollo Computer
80FF-8103	Wellfleet Communications
8107	Symbolics Private
8108	Symbolics Private
8109	Symbolics Private
8130	Waterloo Microsystems
8131	VG Laboratory Systems
8137	Novell (old) NetWare IPX (ECONFIG E Option)
8138	Novell
8139-813D	KTI
9000	Loopback (Configuration Test Protocol)
9001	Bridge Communications XNS Systems Management
9002	Bridge Communications TCP/IP Systems Management
9003	Bridge Communications
FF00	BBN BITAL LANBridge cache wakeup

***Protocol Types***  
*Ethernet Protocol Types*

---

# APPENDIX C

---

## *Troubleshooting*

### **In this Appendix**

- Communication Related Issues
- LAN Related Issues
- Diagnostics and Performance Tools
  - Verification
  - Statistics
  - System Reports

## **Communication Related Issues**

### ***Excessive Triggered Update Events on the Events screen***

This generally is an indication that the network is changing due to the addition or deletion of hardware. Once the information has been exchanged, these events should subside. If this continues, it may indicate that the number of networks or servers on the LAN exceed the Router's table capacity. Set the LAN NETWORK UPDATES field, located on the *Local Profile window* to <Send> or <Neither> and then statically configure the appropriate networks.

Excessive triggered update events may also be the result of information advertised to the Router by a Remote Unit. If this is the case, restrict advertising on the remote unit see, *Chapter 5, Profile Directory:Remote Profile*.

## **LAN Related Issues**

### ***Unable to add data filters, advertise networks or create static route entries***

The Router software will accommodate a maximum of 150 filters. Data filters, such as address, custom or protocol filters, networks advertised to no remotes, firewall filter rules and all static route entries are all considered filters. If you have been able to add filters in the past, but are no longer able to do so, this is an indication that the maximum limit has been reached. We suggest that you review all created data filters, advertised networks and static route entries and eliminate those that are no longer applicable. See *Chapter 4, LAN (Local) Profile Setup*.

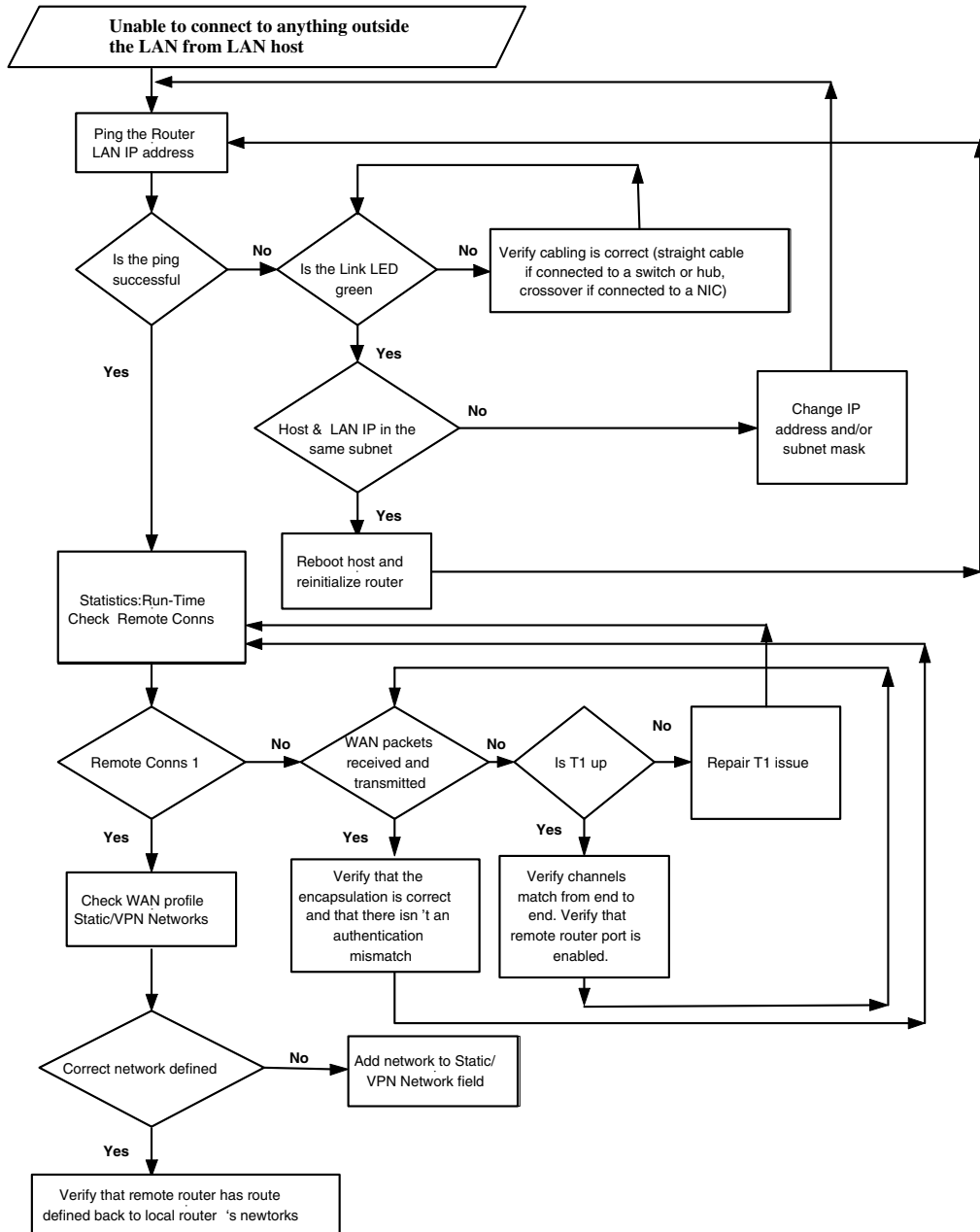

### ***Unable to access the Local (LAN) Router unit via Telnet***

First, verify that the local Router was given an IP Address that is on the same network as the workstation. Since Telnet uses the IP protocol, establish that IP is functioning correctly by “pinging” the local unit from the workstation or by pinging the workstation from the local unit. Pinging will verify that there is communication between the workstation and the Router. Since you are unable to Telnet into the local unit, you will need to connect the local unit to a workstation using the Async port. Once you are connected to the local unit, refer to *Chapter 7, Ping Utility*. The inability to ping from one device to the other indicates a problem with IP or possibly the Telnet software. Refer to your Telnet documentation for more information.

### ***Unable to access a remote unit via Telnet***

Refer to the instructions given above in **Unable to access the local unit via Telnet**. In addition, make sure that the workstation trying to Telnet, as well as the IP and ARP packets are authorized to communicate across the WAN. Review the **FORWARD MODE** field setting as well as the enabled filters on both the local and remote units to verify that they are set up to communicate (refer to Chapter 3, Configuration - Profile Directory - *Chapter 4, LAN (Local) Profile Setup* and *Chapter 5, Remote (WAN) Profile*). Also, if the remote network is different, define the local unit’s IP Address as the default route for the workstation and make sure that there is a remote route to the remote’s network in the Network/Server table.

Be aware that if you establish a firewall filter and do not expressly permit Telnetting into this unit, you will be denied access.

## ***Diagnostics and Performance Tools***

The Verification, Statistics and System Reports features are instrumental in diagnosing and troubleshooting the Router card.

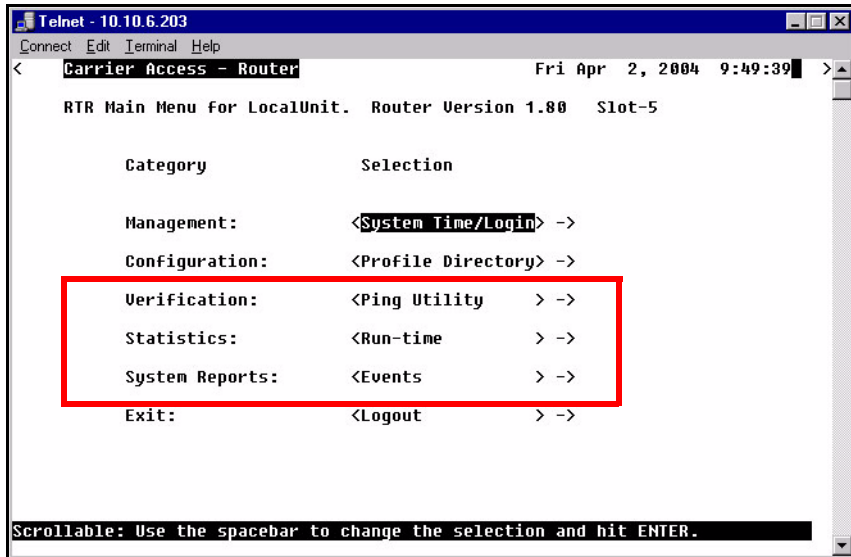

## Verification

The Verification section may be used to identify suspected communication problems between the local and remote devices. Verification options are:

### **Ping Utility**

Verifies the ability of the local unit to communicate by pinging remote or local devices. See *Ping Utility on page 7-2* for more information on this feature.

### **Trace Route**

The Trace Route option is used to verify timely and reliable connections. The Trace Route utility determines the path a packet follows from source to destination. See *Trace Route on page 7-6* for more information on this feature.

### **Port Monitor**

The Port Monitor is a diagnostic tool that is used to review the actual data being transmitted from, or received by the local Router. When the monitoring is started, a hexadecimal display of each transmission as it occurs is shown. See *Port Monitor on page 7-9* for more information on this feature.

---

**NOTE:** The Port Monitor decreases the throughput of the Router. It should only be used during installation and troubleshooting procedures, not during normal operation.

---

## Statistics

### **Run-Time**

The Run-Time is used to review data transmission information between the Local (LAN) unit and Remote (WAN) devices. This option allows you to review data transmission statistics to/from remote units. This data will help you to monitor the Router's connection/performance capabilities such as throughput, compression, and errors. See *Chapter 8, Statistics Window* for more information regarding this feature.



## **System Reports**

The System Reports menu presents data that may be useful in identifying WAN communication problems.

### **Events**

The Events listing offers on-going historical activity for the Router, while the Alarm listing indicates events that suggest further investigation. See *Events on page 9-2* for more information regarding this feature.

### **Alarms**

This screen provides a listing of any Alarms that have occurred on the Router. When an Alarm is triggered, the Router LED (labeled CRD) will display a red indicator light, which will stay on until the Alarm is cleared. Each Alarm is listed separately and the Count field will display a value of 1. See *Alarms on page 9-4* for more information regarding this feature.

### **Network/Servers**

By sending out IPX and IP RIP (Routing Information Protocol) and IPX SAP (Service Advertising Protocol) packets and monitoring RIP and SAP packets from other devices, the Router will learn about other servers and networks. The Router will constantly monitor RIP and SAP packets to ensure that the status of the network or server has changed. Should a RIP or SAP packet indicate a change in status, the Router would update the data in the table and send the information to all enabled remotes to exchange the updated data. See *Networks/Servers on page 9-6* for more information regarding this feature.

### **Address Tables**

The MAC Address and IP Address Tables, along with Network Tables are used to determine if and where the Router should send packets. See *Address Tables on page 9-9* for more information regarding this feature.

# Alarms

## Identify Alarm

### Alarm indicators

- Router LEDs - When an Alarm is triggered, the Router LED (labeled CRD) will display a red indicator light, which will stay on until the Alarm is cleared

The following chart describes each LED, and it's state, of the Router card.

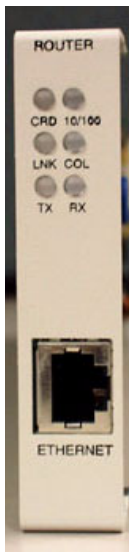

LED	State	Description
CRD	Off	Loss of power
	Green	No current alarms
	Red	Alarm state active. See alarm log for cause
	Red Flashing	Self-test or Boot in-process
	Yellow Flashing	Card is saving data to flash RAM, do not power down
10/100	Off	10 Mb Ethernet
	Green	100 Mb Ethernet
LNK	Off	No Ethernet link
	Green	Good Ethernet link
COL	Off	No current ethernet transmit collisions
	Yellow	Ethernet collisions have occurred and have not dropped to minimum level
	Yellow Flashing	Ethernet collision occurring
TX	Off	No Ethernet transmit activity
	Green	Ethernet transmit activity
RX	Off	No current Ethernet receive activity
	Green	Current Ethernet receive activity

## Display Alarms

To display Router alarms:

On the Main Menu, **System Reports** option select <Alarms - >, or use the [SPACEBAR] to scroll to Alarms if it not displayed.

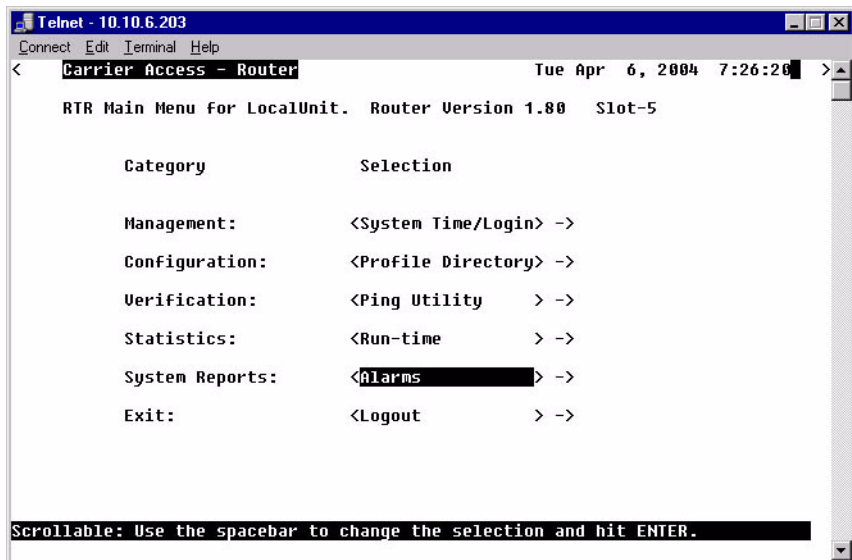

```
Telnet - 10.10.6.203
Connect Edit Terminal Help
< Carrier Access - Router Tue Apr 6, 2004 7:26:20 >
RTR Main Menu for LocalUnit. Router Version 1.80 Slot-5

Category Selection

Management: <System Time/Login> ->
Configuration: <Profile Directory> ->
Verification: <Ping Utility > ->
Statistics: <Run-time > ->
System Reports: <Alarms > ->
Exit: <Logout > ->

Scrollable: Use the spacebar to change the selection and hit ENTER.
```

This Window provides a listing of any Alarms that have occurred on the Router. Each Alarm is listed separately and the Count field will display a value of 1. See Alarms on page 9-4 for more information regarding this feature.

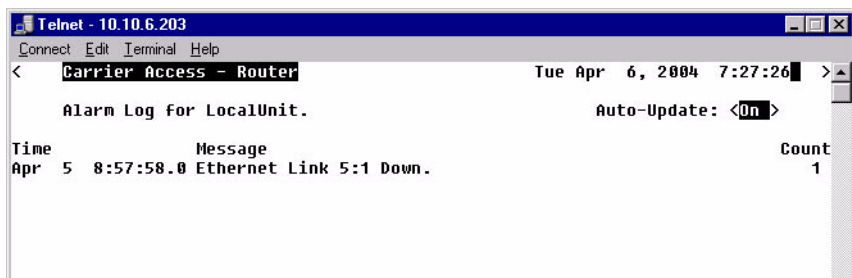

```
Telnet - 10.10.6.203
Connect Edit Terminal Help
< Carrier Access - Router Tue Apr 6, 2004 7:27:26 >
Alarm Log for LocalUnit. Auto-Update: <On >

Time Message Count
Apr 5 8:57:58.0 Ethernet Link 5:1 Down. 1
```

### ***Clear Alarm***

Once an alarm is identified then the process of clearing it can begin.

- Silence Alarm, if necessary (Alarm Cut Off CLI command: **aco**)
- Check Connection
- Check Cable, replace if necessary
- Check hardware and replace if necessary
- Call Customer Service

# GLOSSARY

---

<b>Annex D</b>	A frame relay standard extension dealing with the communication and signaling between customer premises and equipment and frame relay network equipment for the purpose of querying network status information.
<b>B8ZS</b>	Bipolar 8-Zero Substitution, a coding scheme that maintains ones density.
<b>Bit</b>	Contraction of the words "binary" and "digit".
<b>bps</b>	Bits per second
<b>CHAP</b>	Challenge Handshake Authentication Protocol
<b>CLI</b>	Command Line Interface
<b>Command Line</b>	The command line is where you enter MS-DOS commands.
<b>CSU</b>	Channel Service Unit, the interface to the T1 line that terminates the local loop.
<b>DHCP</b>	Dynamic Host Configuration Protocol. DHCP is a network configuration that allows maintenance to be performed from a central site rather than by end users.

## ***Glossary***

### ***DNS***

---

<b>DNS</b>	Domain Name Servers, also known as resolvers, are a system of computer which convert domain names into IP addresses, which consist of a string of four numbers up to three digits each.
<b>Filter</b>	An operating parameter used with routers that can be set to block the transfer of packets from one LAN to another.
<b>Firewall</b>	Any of a number of security schemes that prevent unauthorized users from gaining access to a computer network and/or may monitor the transfer of information to and from the network.
<b>Frame</b>	A fragment of data that is packaged into a frame format, which comprises a header, payload, and trailer.
<b>Hops</b>	Each individual short trip that packets make from router to router, as they are routed to their destination.
<b>IP</b>	Internet Protocol
<b>LMI</b>	Local Management Interface. A specification for the use of frame-relay products that define a method of exchanging status information between devices such as routers.
<b>Loopback</b>	A diagnostic test in which a signal is transmitted across a medium while the sending device waits for its return.
<b>Mbps</b>	Million Bits Per Second.
<b>NTP</b>	Network Time Protocol, developed to maintain a common sense of time among Internet hosts around the world. Many systems on the Internet run NTP, and have the same time (relative to Greenwich Mean Time).
<b>PAP</b>	Password Authentication Protocol

- Ping** Packet InterNet Grouper. PING is a program used to test whether a particular network destination on the Internet is online (i.e. working) by repeatedly bouncing a "signal" off a specified address and seeing how long that signal takes to complete the round trip. No return signal - site is down or unreachable. Portion is returned - trouble with the connection.
- Protocol** Procedure or set of rules.
- PVC** Permanent Virtual Circuit. A PVC is a permanent channel connection between two ATM devices. PVC's allow network transmissions to be started without having to first establish a connection with the end point ATM device. When a PVC is constructed, the end points of the connection will agree upon a path in which data will travel, and therefore agree upon the route that data will travel to reach its destination.
- RADIUS** Remote Authentication Dial-In Service. RADIUS is a client/server-based authentication software system. The software supports remote access applications, allowing an organization to maintain user profiles in a centralized database residing on an authentication server which can be shared by multiple remote access servers.
- RIP** Routing Information Protocol. RIP is based on distance vector algorithms that measure the shortest path between two points on a network, based on the addresses of the originating and destination devices. The shortest path is determined by the number of "hops" between those points. Each router maintains a routing table, or routing database, of known addresses and routes; each router periodically broadcasts the contents of its table to neighboring routers in order that the entire network can maintain a synchronized database.
- SNMP** Simple Network Management Protocol. SNMP is the most common method by which network managements applications can query a management agent using a supported MIB (Management Information Base). SNMP operates at the OSI application layer.
- Spanning Tree** Spanning Tree Protocol is a link management protocol that provides path redundancy while preventing undesirable loops in the network. For an Ethernet network to function properly, only one active path can exist between two stations.

## ***Glossary***

### ***SNMP***

---

#### **SNMP**

Simple Network Management Protocol. SNMP is the most common method by which network managements applications can query a management agent using a supported MIB (Management Information Base). SNMP operates at the OSI application layer.

#### **T1**

Trunk Level 1. A digital transmission link with a total signaling speed of 1.544 Mbps. T-1 is a standard for the digital transmission in North America

#### **Telnet**

An Internet standard protocol that enables a computer to function as a terminal working from a remote computer

#### **Trunk**

A communication line between two switching systems.



# INDEX

## Numerics

100T	
Full Duplex	4-43
Half Duplex	4-43
10T	
Full Duplex	4-43
Half Duplex	4-43
802.2	4-6
802.3	4-6

## A

Access	6-12
Add a Firewall Filter	5-30
Address Filter	
Device Name	4-24
MAC Address	4-24
Address Tables	
Auto-Update	9-11
Display	9-10
Learned From	9-11
Port Name	9-11
Adit	
Exiting	10-2, 10-3
IP Address	6-4
Name	6-4
Reinitializing	10-4
Subnet Mask	6-4
Adit Identification	
Adit	
Default Router	6-4
IP Address	6-4

Name	6-4
Subnet Mask	6-4
Admin	
Password	2-5
security level	2-4
Advertise	
Network/Server	4-25, 4-27
Selected Items	4-27
Setup Advertisement	4-27
Alarms	A-5
Auto-Update	9-5
Count	9-5
Message	9-5
Time	9-5
Annex D	Glossary-1
Authenticate Events	A-3
Authentication	5-14
by Remote	3-8
of Remote	3-9
Protocol	
PAP	3-8
Auto	
Logout Timer	2-5
Negotiate	4-43
Update	8-3, 9-5, 9-11

## B

B8ZS	Glossary-1
Back-to-Back with PPP	11-9
Basic Configuration	
Overview	6-2

## Index

### C

Remote Unit Profile ..... 6-9  
Router Identification ..... 6-4  
Routing Protocol/Security ..... 6-5  
Setup Complete ..... 6-13  
SNMP Configuration ..... 6-12  
WAN INterface Connections ..... 6-7  
Basic Setup ..... 11-2  
Bipolar 8 Zero Substitution ..... Glossary-1  
Bit ..... Glossary-1  
bps ..... Glossary-1  
Bridge  
  Forward Delay ..... 3-17, 3-19  
  Hello Time ..... 3-17  
  Max Age ..... 3-17  
  Priority ..... 3-17, 4-39, 5-42  
**C**  
Change Password ..... 2-6  
CHAP ..... 3-8, Glossary-1  
Clear Totals  
  All ..... 8-3  
  LAN  
    LAN ..... 8-3  
  WAN  
    WAN ..... 8-3  
CLI ..... Glossary-1  
Code Load ..... 2-10, 2-14  
Collision  
  Hi Threshold ..... 4-36  
  Lo Threshold ..... 4-36  
Command Line ..... Glossary-1  
Community Name ..... 3-11  
Compression ..... 5-14  
  Ratio to/from WAN ..... 8-5  
Config Load ..... 2-10  
Config Password ..... 2-5  
Config Upload/Download ..... 2-11  
config, security level ..... 2-4  
Configuration ..... 11-1

connecting to the router ..... 1-5  
connecting with Telnet ..... 1-5  
Continuous Ping ..... 7-4  
Continuous Ping Status  
  Response Count ..... 7-5  
  Timeout Count ..... 7-5  
CSU ..... Glossary-1

### D

Default Router ..... 5-10  
Defining  
  Address Filters ..... 4-24  
  Custom Filters ..... 4-22  
  Protocol Filters ..... 4-23  
Device Name ..... 5-28  
Devices  
  Local ..... 5-33  
DHCP ..... Glossary-1  
DHCP Server ..... 4-32  
DHCP Server/BOOTP Relay ..... 4-30  
  DHCP Server ..... 4-32  
  Domain Name Servers ..... 4-33  
  Lease Duration ..... 4-33  
  Name Server (NBNS) ..... 4-33  
  NetBIOS Name Server ..... 4-33  
  NetBIOS Node Type ..... 4-33  
  Node Type ..... 4-33  
  Number ..... 4-32  
  Scope ..... 4-33  
Diagnostics and Performance Tools ..... C-5  
Display ..... 9-10  
DLCI ..... 6-11  
DNS Proxy ..... 3-14  
  DNS Server ..... 3-15  
  Domain Name ..... 3-15  
  Site ..... 3-15  
DNS Resolver ..... 3-22  
DNS Server ..... 3-15  
Domain Name ..... 3-15

**E**

Enhanced Security .....	2-6
Esc Key .....	1-2
Eth II .....	4-6
Events .....	9-2
Authenticate .....	A-3
Count .....	9-3
Message .....	9-3
Time .....	9-3
Triggered .....	A-4
User .....	A-2
Excessive Triggered Update Events .....	C-2
Exit .....	10-1
Logout .....	10-2
Reinitialize .....	10-3

**F**

Facility .....	3-21
Fields	
Edit .....	1-3
Scroll .....	1-3
Select .....	1-3
Filter .....	5-39, Glossary-2
Filter Network/Server .....	5-35
Filter .....	5-39
Learn .....	5-39
Name .....	5-39
Network .....	5-38
Selected Items	
Filter/Learn .....	5-37
Setup .....	5-37
Type .....	5-38
Filters .....	4-19
Define .....	4-21
Define Filter .....	4-21
Defining Custom .....	4-22
Filter Name .....	4-21
Filter Type .....	4-21
Firewall .....	5-11, 5-29

Forward Mode .....	4-21
Network/Server .....	5-11
Setup .....	4-9
Source/Destination .....	4-21
Type .....	4-21
Firewall .....	Glossary-2
Filters .....	5-11, 5-29
Local Device(s) .....	5-33
Local IP Address/Network .....	5-34
Packets which Match this Rule .....	5-34
Remote IP Address/Network .....	5-34
Rule #1 .....	5-32
Services .....	5-33
Firewall Filters .....	11-5
Forward	
Mode .....	4-21
Forwarded to WAN .....	8-5
Frame .....	Glossary-2
Type .....	9-8
802.2 .....	4-6, 4-8
802.3 .....	4-6, 4-8
Eth II .....	4-6
Ethernet II .....	4-8
SNAP .....	4-6
Frame Relay .....	3-6, 11-4
Frame Relay Internet Connection .....	11-4

**G**

Gateway .....	4-15, 9-8
GRE Tunnel .....	5-7

**H**

Help .....	1-4
Hops .....	4-15, 9-8, Glossary-2

**I**

Installation .....	1-1
IP .....	6-10, Glossary-2
Address .....	5-28

## Index

### L

---

IP Address	6-11, 7-3, 7-4
IP Firewall	
Significant Bits	5-34
IPX	6-10
Router	4-15, 9-8
IPX Server Advertising	4-28
Name	4-29
Network	4-29
Selected Items	4-29
Type	4-29
<b>L</b>	
LAN	4-36
Network Updates	4-6
Packet	
Errors	8-4
Received	8-4
Transmitted	8-4
Packet Totals	8-4
LAN Collision Threshold	4-9, 4-34
Alarm	
Alarm	4-36
Collision	
Collision	4-36
Collision Hi Threshold	4-36
Collision Lo Threshold	4-36
LAN	4-36
Sample Interval	4-36
LAN IP	4-8
Default Router	4-8
IP Address	4-8
Subnet Mask	4-8
LAN IPX	4-8
802.2 Ext. Network	4-8
802.3 Ext. Network	4-8
Domain Name	4-32
Ethernet II Ext. Network	4-8
LAN Port Tests	
Continuous Ping Status	
Response Count	7-5
Timeout Count	7-5
IP Address	7-3
Operation	
Single Ping	7-4
Single Ping Status	7-4
IP Address	7-4
MAC Address	7-4
Result	7-5
Learn	5-39
Lease Duration	4-33
Level	3-21
Link Speed	4-9, 4-42
100T	
Full Duplex	4-43
Half Duplex	4-43
10T	
Full Duplex	4-43
Half Duplex	4-43
AutoNegotiate	4-43
LMI	Glossary-2
Load Defaults	2-12
Local	
Security Server	3-9
Local Device(s)	5-33
Local IP Address	5-23
Local IP Address/Network	5-34
Significant Bits	
Significant Bits	5-34
Local Profile	4-1, 4-3, 4-6
Advertise Network/Server	4-25
DHCP Server/BOOTP Relay	4-30
Filters	4-19
Frame Type	4-6
802.2	4-6
802.3	4-6
Eth II	4-6
SNAP	4-6
LAN Collision Threshold	4-34
LAN Network Updates	4-6
Link Speed	4-42

- 
- LocalUnit .....4-6
  - Secondary IP Address .....4-40
  - Setup .....4-9
    - Filters .....4-9
    - LAN Collision Threshold .....4-9
    - Link Speed .....4-9
    - Spanning Tree .....4-37
    - Static Addresses .....4-16
    - Static Networks .....4-10
  - Local Security Server .....3-9
  - Location .....6-12
  - login setup .....2-3
  - Logout .....10-2
  - Loopback .....Glossary-2
- M**
- MAC Address .....4-24, 5-28, 7-4
  - Management Overview .....2-2
  - Management Window .....2-1
  - Mask
    - Subnet .....4-14
  - Mbps .....Glossary-2
  - Metric .....4-14, 5-18, 5-20, 9-8
  - Mode
    - Forward .....4-21
- N**
- Name .....3-12, 5-39, 6-12
    - Device .....4-18, 4-24
    - Remote .....8-5
  - Name Server (NBNS) .....4-33
  - Names .....9-8
  - NAT
    - Gateway .....5-8, 5-9
  - NAT Addresses .....11-7
  - NAT Bypass Subnets .....5-24
  - NAT IP Address .....5-23
  - NAT/PAT .....11-5
  - NetBIOS
    - Name Server .....4-33
    - Node Type .....4-33
  - Network .....4-14, 4-27, 5-18, 5-20, 5-38
  - Network Time Protocol .....3-18
  - Networks/Servers
    - Frame Type .....9-8
    - Hops .....9-8
    - Metric .....9-8
    - Name .....9-8
    - Network .....9-7
    - Next Gateway .....9-8
    - Next IPX Router .....9-8
    - Ticks .....9-8
    - Type .....9-7
  - New Password .....1-6
  - Next
    - Gateway .....4-15, 9-8
    - IPX Router .....4-15, 9-8
  - Next Gateway .....4-15
  - Node Type .....4-33
  - Number
    - Bytes to Display .....7-10
- O**
- Operation
    - Single Ping .....7-4
- P**
- Packet
    - RIP .....4-26
    - SAP .....4-26
  - Packets which match this rule .....5-34
  - PAP .....3-8, Glossary-2
  - Password .....3-8, 3-9
  - password .....1-6
  - Ping .....Glossary-3
    - Continuous .....7-4
    - single .....7-4
    - Single Status .....7-4

## Index

### R

- Ping Utility ..... 7-2
- Port Monitor ..... 7-9
- Port Name ..... 9-11
- Port Number ..... 6-7
- PPP ..... 3-4, 3-5, 11-5, 11-9
- PPP in Frame Relay ..... 3-5
- PPP Internet Connection ..... 11-3
- Profile
  - Directory ..... 4-3
  - Local ..... 4-3
  - Remote ..... 5-4
- Profile Name ..... 6-10
- Protocol ..... 4-6, 5-6, 6-10, Glossary-3
  - Network Time ..... 3-18
  - Spanning Tree ..... 3-16, 4-37, 5-40
- Protocol Types ..... B-1
- PVC ..... Glossary-3
- R**
- Reboot After Load Code ..... 2-10, 2-14
- Reboot After Load Config ..... 2-10
- Record
  - Configurable ..... 4-4
- Reinitialize ..... 10-3
- Remote
  - Connections ..... 8-5
  - Name ..... 8-5
  - Security ..... 5-10
- Remote Adit Profile
  - Profile Name ..... 6-10
  - Protocol ..... 6-10
    - IP ..... 6-10
    - IPX ..... 6-10
    - Other ..... 6-10
- Remote IP Address/Network ..... 5-34
  - Significant Bits ..... 5-34
- Remote Name ..... 7-10
- Remote Profile ..... 5-1, 5-4
  - GRE Tunnel ..... 5-7
    - Protocol ..... 5-6
  - Default Router ..... 5-10
  - Filter Network/Server ..... 5-11
  - Filter Newtowk/Server ..... 5-35
  - Firewall Filters ..... 5-11, 5-29
    - Mode ..... 5-6
  - NAT Bypass Subnets ..... 5-24
  - NAT Gateway ..... 5-8, 5-9
    - Numbered ..... 5-10
    - Protocol ..... 5-6
  - RemoteUnit ..... 5-5
  - Security/Options ..... 5-10
  - Security/SNMP ..... 5-12
  - Setup ..... 5-10
  - Spanning Tree ..... 5-40
  - Static Addresses ..... 5-10, 5-11, 5-26
  - Static NAT Addresses ..... 5-22
  - Static/VPN Networks ..... 5-15
  - Subnet Mask ..... 3-21, 3-23, 3-24, 5-10
  - Trunk Port ..... 5-43
  - WAN Network Updates ..... 5-7
- Remote Unit Profile ..... 6-9
- RemoteUnit ..... 5-5
- Reports
  - Alarm Log ..... 9-5
  - Response Count ..... 7-5
  - Result ..... 7-5
- RIP ..... 4-6, 4-10, 5-15, Glossary-3
  - Mode Send ..... 3-3
  - RIP Mode Receive ..... 3-3
- Router ..... 11-1
- Router Card Profile ..... 3-1
  - Configuration ..... 3-2
    - DNS Proxy ..... 3-14
    - DNS Resolver ..... 3-22
    - Network Time Protocol ..... 3-18
  - RIP
    - Mode Receive ..... 3-3

Mode Send	3-3	SAP	4-6
Security	3-7	Scope	4-33
SNMP	3-10	Secondary IP Address	4-40
Spanning Tree Protocol	3-16	Security	3-7
SysLog	3-20	Address	3-9
Trunk	3-4	Authentication by Remote	3-8
Router Configuration	11-1	Authentication of Remote	3-9
Back-to-Back with PPP	11-9	Local Security Server	3-9
Basic Setup	11-2	Password	3-9
Internet Connection using NAT	11-7	Server	5-14
Internet Connection using PPP,		Type	3-9
NAT/PAT	11-5	User ID	3-8
PPP Internet Connection	11-3	Security Level	
Router Configurations		1 - View	2-4
Frame Relay Internet Connection	11-4	2 - Config	2-4
Router Identification	6-4	3 - Admin	2-4
Routing Protocol/Security	6-5	Security/Options	5-10
Rule #1	5-32	Security/SNMP	3-12, 5-12
Run-Time	8-2	Access	3-12
Auto-Update	8-3	Address	3-12
Clear Totals	8-3	Authentication by Remote	5-14
All	8-3	Community Name	3-11
LAN	8-3	Compression	5-14
WAN	8-3	Password	3-8
Comp. Ratio to/from WAN	8-5	Security Server	5-14
Errors	8-4	Typical Data	5-14
Forwarded to WAN	8-5	Selected Items	5-37
LAN Packet Totals	8-4	Server IP Address	3-21, 3-23
Statistics	8-4	Services	5-33
Receive	8-4	Set Poll Counter	6-8
Received	8-4	Set Poll Interval	6-8
Remote Connections	8-5	Setup	
Remote's Name	8-5	Advertisement	4-27
Throughput to/from WAN	8-5	Local Profile	4-9
Transmitted	8-4	Setup Complete	6-13
WAN Packet Totals	8-4	Significant Bits	5-34
		Single Ping	7-4
		Single Ping Status	7-4
		Continuous Ping	7-4

## S

Sample Interval . . . . . 4-36

## Index

### S

---

IP Address	7-4	Start IP Address	4-32
MAC Address	7-4	Start Monitor	7-10
Result	7-5	Static	
Site	3-15	Address	5-23, 5-25, 5-27, 5-31, 5-37, 5-44
SNAP	4-6	Addresses	4-16, 5-10, 5-11
SNMP	3-10, Glossary-3, Glossary-4	NetworksRemote Profile	
Community Name	3-11	Static Networks	5-10
Configuration	6-12	Setup	5-28
SYS Contact	3-11	Static Addresses	5-26
SYS Location	3-11	Device Name	4-18, 5-28
SYS Name	3-11	IP Address	4-18, 5-28
Trap Destination		MAC Address	4-18, 5-28
Address	3-13	Setup Static	4-18, 5-28
Location	3-13	IP Address	4-18
Name	3-13	MAC Address	4-18
Trap Destinations	3-12	Static NAT Addresses	5-22, 11-7
SNMP Communities		Local IP Address	5-23
Access	6-12	NAT IP Address	5-23
Address		Static Networks	4-10, 4-15
Address	6-12	Hops	4-15
Name	6-12	Metric	4-14
SNMP Configuration		Network	4-14
SNMP Communities	6-12	Next Gateway	4-15
SNMP Trap Destinations	6-12	Subnet Mask	4-14
SNMP Trap Destinations		Ticks	4-15
Address		Static/VPN Networks	5-15
Address	6-12	Metric	5-18, 5-20
Location	6-12	Network	5-18, 5-20
Name	6-12	Subnet Mask	5-18, 5-20
Software Images	2-13	Statistics	
Source		Run-Time	8-2
/destination	4-21	Auto-Update	8-3
Spanning Tree	Glossary-3	Clear Totals	8-3
Spanning Tree Protocol	3-16, 4-37, 5-40	Statistics Window	8-1
Bridge Forward Delay	3-17, 3-19	Subnet Mask	4-14, 5-18, 5-20, 6-11
Bridge Hello Time	3-17	SYS Contact	3-11
Bridge Max Age	3-17	SYS Location	3-11
Bridge Priority	3-17, 4-39, 5-42	Sys Log	3-21
Start Basic Configuration	6-2	SYS Name	3-11



- 
- SysLog ..... 3-21, 3-22, 3-23
    - System Log Message Service ..... 3-20
  - System Date and Time ..... 2-4
  - System Log Message Service ..... 3-22
  - System Reports
    - Address Tables
      - Auto-Update ..... 9-11
      - Display ..... 9-10
      - Learned From ..... 9-11
      - Port Name ..... 9-11
    - Alarms
      - Auto-Update ..... 9-5
      - Count ..... 9-5
      - Message ..... 9-5
      - Time ..... 9-5
    - Events ..... 9-2
      - Count ..... 9-3
      - Message ..... 9-3
      - Time ..... 9-3
    - Networks/Servers ..... 9-8
      - Frame Type ..... 9-8
      - Hops ..... 9-8
      - Metric ..... 9-8
      - Name ..... 9-8
      - Network ..... 9-7
      - Next Gateway ..... 9-8
      - Ticks ..... 9-8
      - Type ..... 9-7
  - System Reports Window ..... 9-1
  - System Time/Login ..... 2-3, 2-4
    - Admin Password ..... 2-5
    - Auto-Logout Timer ..... 2-5
    - Change Password ..... 2-6
    - Config Password ..... 2-5
    - Enhanced Security ..... 2-6
    - System Date and Time ..... 2-4
    - View Password ..... 2-5
- T**
- T1 ..... Glossary-4
  - Tab Key ..... 1-2
  - Telnet ..... Glossary-4
  - Telnet Session ..... 1-5
  - Throughput to/from WAN ..... 8-5
  - Ticks ..... 4-15, 9-8
  - Time
    - Login Setup ..... 2-4
    - time setup ..... 2-3
    - Timeout Count ..... 7-5
    - Trace Route ..... 7-6
    - Trap Destinations ..... 3-12
    - Triggered Events ..... A-4
    - Troubleshooting ..... C-1
      - Communication Related Issues ..... C-2
      - LAN Related Issues ..... C-2
  - Trunk ..... 3-4, Glossary-4
  - Trunk Port ..... 5-43
    - WAN Connection ..... 3-5
    - WAN Connection Type ..... 3-5
  - Type ..... 5-38
  - Typical Data ..... 5-14
- U**
- Unable to
    - Access a Remote Unit via Telnet ..... C-4
    - Access the Local Adit Unit via Telnet ... C-4
    - Add Data Filters ..... C-2
    - Advertise Networks ..... C-2
    - Create Static Route Entries ..... C-2
  - Upload/Download ..... 2-8
  - User Events ..... A-1, A-2
    - Alarms ..... A-5
  - User ID ..... 3-8, 5-14

## ***Index***

V

---

### **V**

Verification	
Ping Utility .....	7-2
Port Monitor .....	7-9
Trace Route .....	7-6
Verification Window .....	7-1
View Password .....	2-5
view, security level .....	2-4

### **W**

WAN	
Connection .....	3-5
Connection Type .....	3-5
Frame Relay .....	3-6
PPP .....	3-5
PPP in Frame Relay .....	3-5
Network Updates .....	5-7
Packet	
Errors .....	8-4
Received .....	8-4
Totals .....	8-4
Transmitted .....	8-4
WAN Connection .....	6-7
WAN Connection Type .....	6-7
WAN Interface Connections .....	6-7
Port Number .....	6-7
WAN Connection .....	6-7
WAN Connection Type .....	6-7
WAN Monitor	
Number of Bytes to Display .....	7-10
Remote Name .....	7-10
Start Monitor .....	7-10
WAN Port Number .....	6-11
DLCI .....	6-11

## Free Manuals Download Website

<http://myh66.com>

<http://usermanuals.us>

<http://www.somanuals.com>

<http://www.4manuals.cc>

<http://www.manual-lib.com>

<http://www.404manual.com>

<http://www.luxmanual.com>

<http://aubethermostatmanual.com>

Golf course search by state

<http://golfingnear.com>

Email search by domain

<http://emailbydomain.com>

Auto manuals search

<http://auto.somanuals.com>

TV manuals search

<http://tv.somanuals.com>