



MASTER

58GP, GS, & GSC 58DP, DR, & DRC Natural-Draft Furnaces

GAS FURNACES

USER'S INFORMATION MANUAL FOR THE OPERATION AND MAINTENANCE OF YOUR NEW GAS-FIRED FURNACE

FOR YOUR SAFETY

Do not store or use gasoline or other flammable vapors and liquids in the vicinity of this or any other gas appliance.

⚠WARNING: Improper installation, adjustment, alteration, service, maintenance, or use can cause carbon monoxide poisoning, explosion, fire, electrical shock, or other conditions which may cause injury or property damage. Consult a qualified installer, service agency, or your local gas supplier for information or assistance.

FOR YOUR SAFETY

What to do if you smell gas:

1. Do not try to light any appliance.
2. Do not touch any electrical switch.
3. Do not use any phone in your building. Immediately call your gas supplier from a neighbor's phone. Follow the gas supplier's instructions.
4. If you cannot reach your gas supplier, call the fire department.

NOTE TO INSTALLER:

This manual must be left with the equipment user.

WELCOME TO DEPENDABLE HOME-HEATING

Congratulations! Your new gas furnace is a sound investment that will reward you and your family with years of "warm memories" winter after winter.

Not only is your new furnace one of the more energy-efficient heating systems available today, it is also one of the most reliable. Spend just a few minutes with this manual to learn about the operation of your new furnace—and the small amount of maintenance it takes to keep it operating at peak efficiency. Years went into the development of your new furnace. Take a little time now to assure its most efficient operation for years to come.

Setting the thermostat back a few degrees—and compensating for the difference with warmer clothing—can make a big difference in your fuel consumption throughout the heating season. The few degrees at the top of your thermostat "comfort level" are the most costly to obtain.

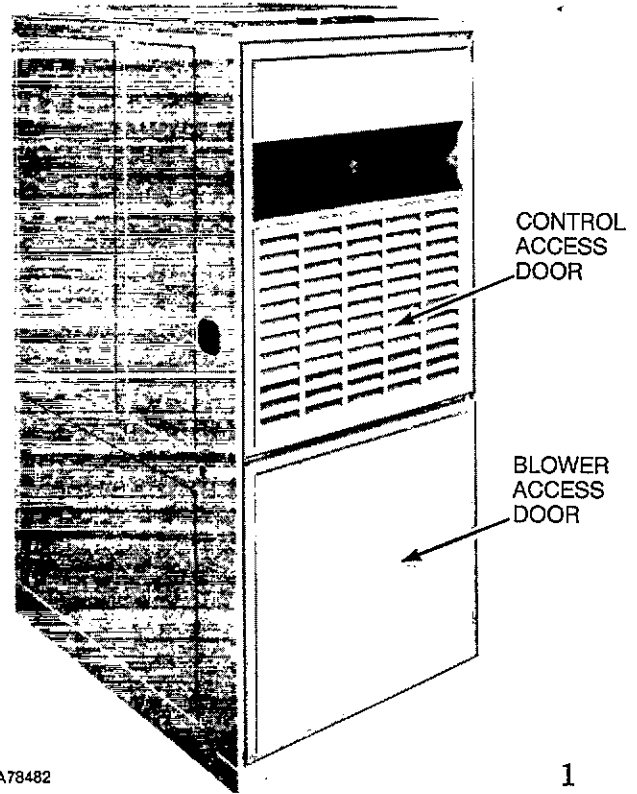

A78482

1

MODELS 58GP, GS, & GSC
UPFLOW FURNACE

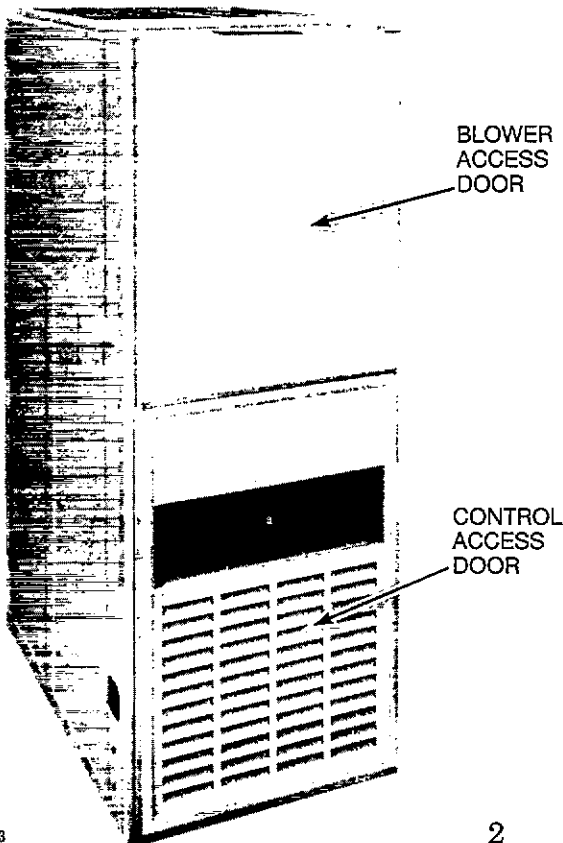

A78593

2

MODELS 58DP, DR, & DRC
DOWNFLOW FURNACE

Record the product and serial numbers of your new furnace in the spaces provided below. This information, along with the other ready-reference facts requested below, will be needed should you ever require service.

FURNACE IDENTIFICATION

Product No. _____

Serial No. _____

Pilot—Intermittent _____ Continuous _____

Date Installed _____

Dealer Name _____

Address _____

City _____

State _____ Zip _____

Telephone _____

UPFLOW FURNACE COMPONENTS

- 1 Draft Diverter
- 2 Control Knob (On/Off)
- 3 Internal Gas Valve
- 4 Ignition Pilot
- 5 Blocked Vent Shutoff System Switch
- 6 Gas Burner(s)
- 7 Gas Manifold
- 8 Rating Plate
- 9 Blower Door Safety Switch (may be on right-hand side of furnace).
- 10 Blower and Blower Motor
- 11 Filter Retainer (may be on side(s) of furnace).
- 12 Air Filter (may be on side(s) of furnace).

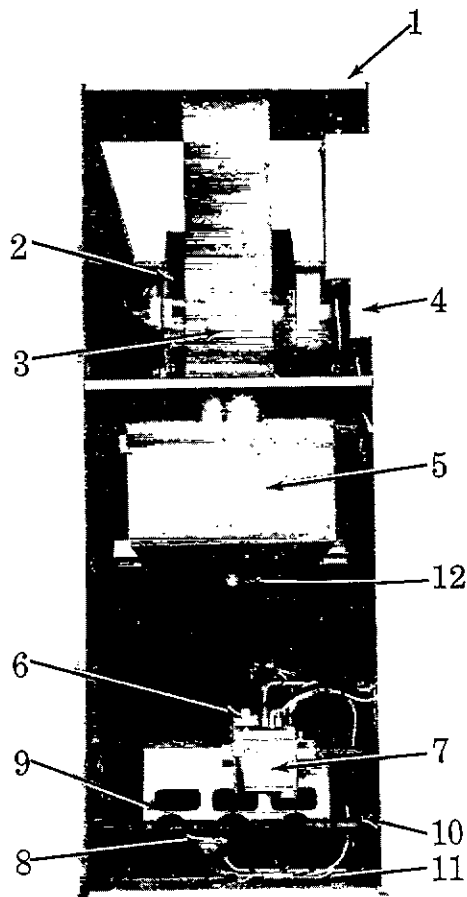
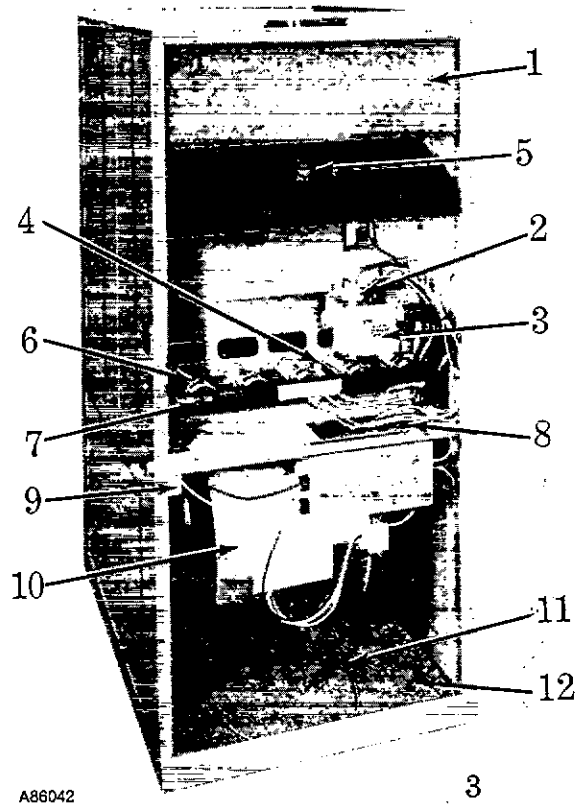

DOWNFLOW FURNACE COMPONENTS

- 1 Manual-Reset Auxiliary Limit Switch (Reset button on top of furnace)
- 2 Blower and Blower Motor
- 3 Vent Pipe (Internal)
- 4 Blower Door Safety Switch
- 5 Draft Diverter
- 6 Control Knob (On/Off)
- 7 Internal Gas Valve
- 8 Ignition Pilot
- 9 Gas Burner(s)
- 10 Gas Manifold
- 11 Rating Plate
- 12 Blocked Vent Shutoff System Switch

IMPORTANT FACTS

Your furnace must have an adequate supply of air for safe combustion and ventilation. Do not enclose it in an airtight room or "seal" it behind solid doors. The furnace may be in a closet, if air is supplied to the closet in accordance with the fuel gas codes.

To minimize the possibility of personal injury, fire, furnace damage, or improper operation—follow these safety rules:

- Keep the area around your furnace free of combustible materials, gasoline, and other flammable liquids and vapors.

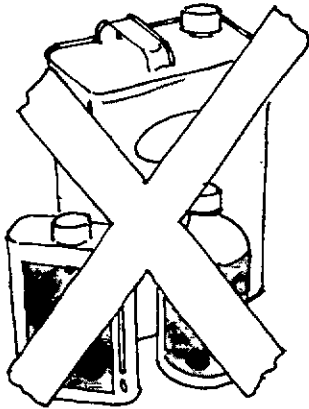

A86023

5

- Do not cover the furnace, store trash or debris near it, nor block the flow of air to it.

- Combustion air must be clean and uncontaminated by chlorine or fluorine. These compounds are present in many products around the home such as water softener salts, laundry bleaches, detergents, adhesives, paints, varnishes, paint strippers, waxes, and plastics.

Make sure that combustion air for your furnace does not contain any of these compounds. During remodeling be sure the combustion air is clean and uncontaminated. If these compounds are burned in your furnace, the heat exchangers and metal vent system may deteriorate.

- If your furnace is installed in the attic or within any other insulated space, it must be kept free of the insulating material. Examine the furnace area when installing—or when adding more insulation. Some of these materials may be combustible.

- Do not use this furnace if any part has been under water. Immediately call a qualified service technician to inspect the furnace and to replace any part of the control system and any gas control which has been under water.

NOTE: The qualified installer or agency must use only factory-authorized replacement parts, kits, and accessories when servicing or modifying this product.

This furnace contains SAFETY DEVICES which must be MANUALLY RESET. If the furnace is left unattended for an extended period of time, have it checked periodically for proper operation. This precaution will prevent problems associated with NO HEAT, such as frozen water pipes, etc., See Section Before You Request a "Service Call" in this manual.

SAFETY CONSIDERATIONS

Installation and servicing of heating equipment can be hazardous due to gas and electrical components. Only trained and qualified personnel should install, repair, or service heating equipment.

Untrained personnel can perform basic maintenance functions such as cleaning and replacing air filters. All other

operations must be performed by trained service personnel. Observe safety precautions in this manual, on tags, and on labels attached to the furnace and other safety precautions that may apply.

Recognize safety information: This is the safety-alert symbol Δ . When you see this symbol on the furnace and in instructions or manuals, be alert to the potential for personal injury.

Understand the signal word—DANGER, WARNING, or CAUTION. These words are used with the safety-alert symbol. DANGER identifies the most serious hazards which will result in severe personal injury or death. WARNING on the other hand could result in personal injury or death. CAUTION is used to identify unsafe practices, which would result in minor personal injury or product and property damage.

STARTING YOUR FURNACE

Your furnace is equipped with one of the following types of gas control systems:

- The manual ignition system has a continuously burning pilot flame. This pilot must be match-lit by hand.

The automatic intermittent ignition system does not have a continuously burning pilot flame. Instead, this pilot is automatically lit by an electric sparking device each time the thermostat signals your furnace to start.

Follow these important safeguards:

- Never attempt to manually light the pilot on a furnace that has an intermittent ignition system by using a match or any other source of flame.

- Read and follow the lighting or operating instructions affixed to the furnace blower access door.

- If you suspect a malfunction of your furnace's gas control system, such as the pilot not lighting when it should, refer to the shutdown procedures found on page 6 of this manual and the lighting instruction label affixed to the furnace blower access door. Turn off your furnace. Then, call your servicing dealer as soon as possible.

Δ WARNING

Should overheating occur, or the gas valve fail to shut off the gas supply, turn off the external manual gas valve to the furnace BEFORE turning off the electrical supply. A failure to adhere to this warning can result in a fire or explosion and physical injury or death.

CHECK AIR FILTER before starting your furnace. The filter should be clean and in place. Refer to page 7 of this manual for the proper maintenance procedure.

VENT DAMPER: If your furnace is equipped with an optional automatic vent damper, observe that the damper is

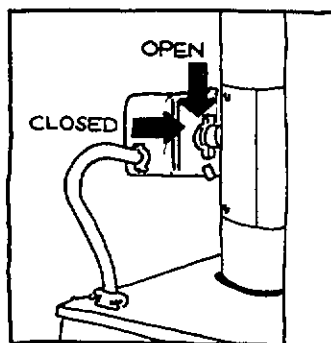

A86047

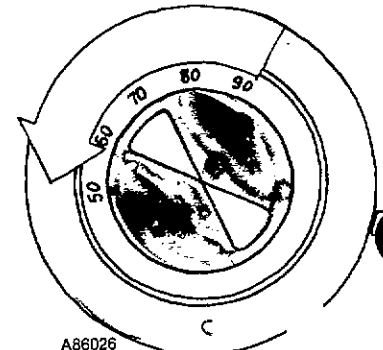

A86026

6

7

in the open position when the thermostat is "calling for heat." See Fig. 6. IF THE DAMPER IS NOT OPEN, shut down the furnace and call your dealer for service.

MANUAL IGNITION (CONTINUOUS) PILOT

NOTE: Your gas valve may be different from that pictured. Refer to the lighting instructions label affixed to your furnace blower access door (See Figs. 1 and 2 for door identification) for the correct picture.

1. Set your room thermostat to its lowest temperature setting. See Fig. 7.
2. Close the external manual gas valve. See Fig. 8.
3. Turn OFF the electrical supply to your furnace. See Fig. 9.

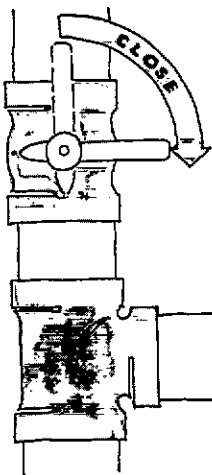

A86029

8

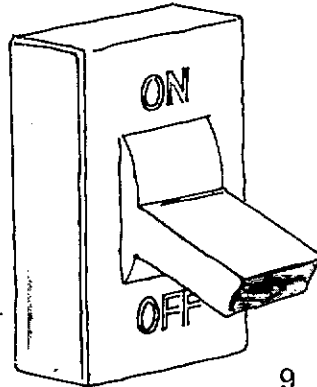

A86027

9

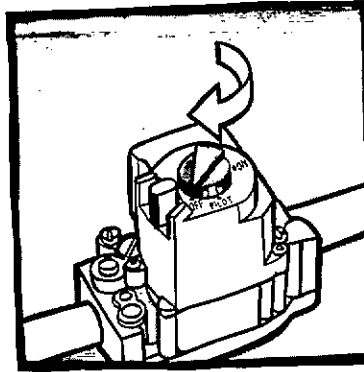

A89169

12

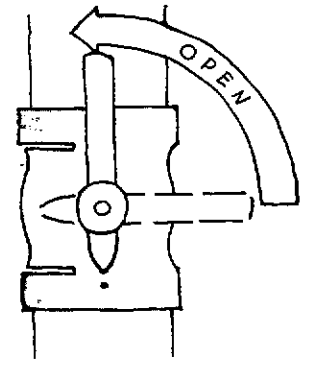

A86035

13

Refer to the lighting instruction label affixed to the furnace blower access door.

Depress the button or knob and hold it down. The pilot will light. Remove and extinguish the match while continuing to hold the button or knob down for at least 60 seconds. Then, release. The pilot will remain lit.

NOTE: If the pilot does not remain lit, repeat steps 5 through 8; however, hold the button down for a longer period of time (at least 90 seconds). If the pilot flame is extinguished after this second attempt, the thermocouple should be checked for a possible malfunction. Call your dealer for service.

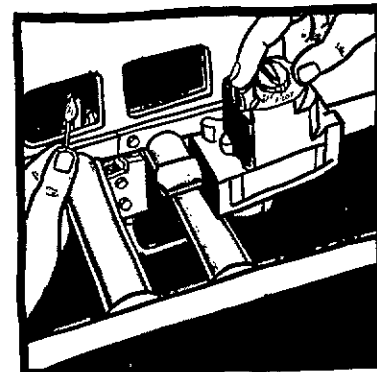

A89170

14

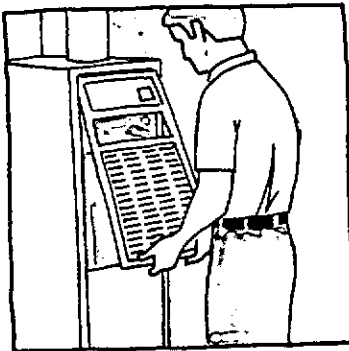

A86044

10

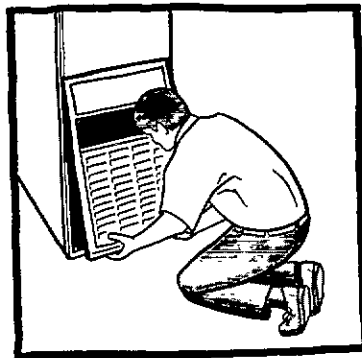

A89176

11

4. Remove the access door(s) from your furnace. Lift up and out at the bottom. See Fig. 10 for upflow and Fig. 11 for downflow furnaces.

NOTE: The blower access door must be installed to permit furnace operation. On downflow furnaces, the blower access door must be removed before the control access door is removed, then reinstalled.

5. Turn the control knob on the internal gas valve clockwise to the indicated OFF position. Wait 5 minutes for any expelled gas to dissipate. See Fig. 12.
6. After waiting 5 minutes, open the external manual gas valve. See Fig. 13.
7. Turn the control knob on the internal gas valve to the PILOT position.
8. Place a lighted match or other suitable source of flame near the top of the pilot. See Fig. 14.

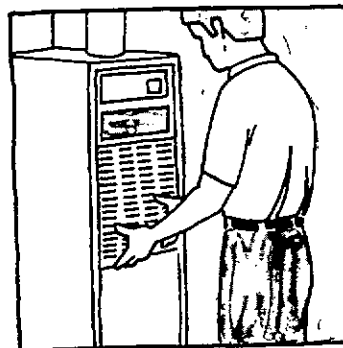

A86044

15

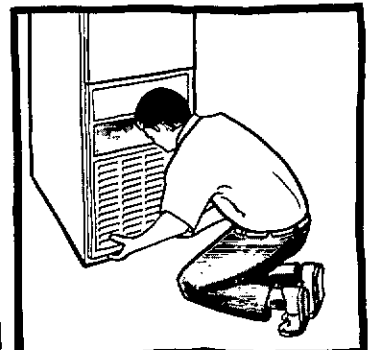

A89177

16

9. After the pilot flame is established, turn the control knob on the gas valve to the ON position.
10. Replace the access door. Insert door end into the furnace, push the door in and down. See Fig. 15 or 16. On downflow furnaces, remove the blower access door, install the control access door, then reinstall the blower access door.
11. Turn on the electrical supply to the furnace.
12. Adjust the room thermostat to a setting slightly above room temperature. This will automatically signal the

furnace to start. If your furnace is equipped with an optional vent damper, see Fig. 6 and VENT DAMPER paragraph above Fig. 6 for information about the vent damper.

- Furnace main burners should light shortly after you set the thermostat. After you verify that the burners are lit, you may adjust the room thermostat to your own personal comfort setting. If the burners fail to light, shut down your furnace and call your dealer for service. Refer to the lighting instruction label affixed to your furnace blower access door or page 6 for shut-down procedures.

NOTE: To conserve energy when the heating season has ended, you should shut down your manually ignited pilot. Follow the procedures in the "Shutting Down Your Furnace" section of this manual.

AUTOMATIC INTERMITTENT IGNITION PILOT

NOTE: Your gas valve may be different from that pictured. Refer to the operating instructions label affixed to your furnace blower access door (See Figs. 1 and 2 for door identification.) for the correct picture.

▲ WARNING

Never attempt to manually light the pilot on a furnace that has an intermittent ignition system by using a match or any other source of flame. A failure to adhere to this warning can result in an explosion, fire, electrical shock, personal injury, or death.

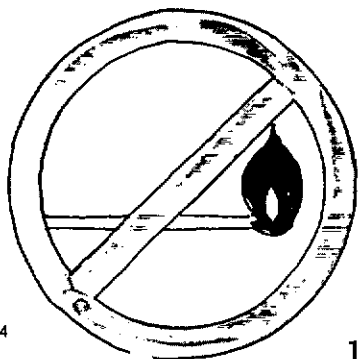

A86024

17

- Adjust your room thermostat to the lowest temperature setting. See Fig. 7.
- Close the external manual gas valve. See Fig. 8.
- Turn OFF the electrical supply to your furnace. See Fig. 9.
- Remove the access door(s) of your furnace. Lift up and out at the bottom. See Fig. 10 or 11.

NOTE: The blower access door must be installed to permit furnace operation. On downflow furnaces, the blower access door must be removed before the control access door is removed, then reinstalled.

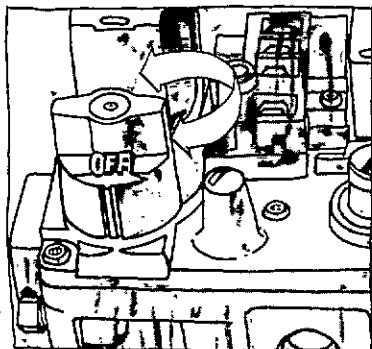

A87374

18

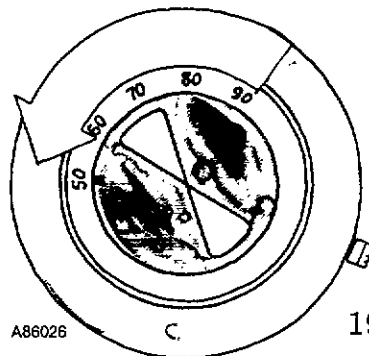

A86026

19

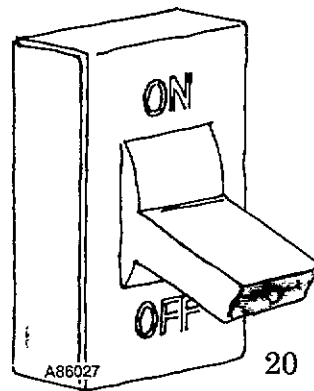

A86027

20

- Turn the control knob of the internal gas valve clockwise or counterclockwise (depending on the type valve supplied with your furnace) to the indicated OFF position. Wait 5 minutes for any expelled gas to dissipate. See Fig. 18.
- After waiting 5 minutes, turn the control knob to the ON position.
- Replace the access door. Insert door end into furnace, push the door in and down. See Fig. 15 or 16. On downflow furnaces, remove the blower access door, install the control access door, then reinstall the blower access door.
- Turn on the electrical supply to the furnace.
- Open the external manual gas valve. See Fig. 13.
- Adjust the room thermostat to a setting slightly above room temperature. This will automatically signal the furnace to start. If your furnace is equipped with an optional vent damper, see Fig. 6 and VENT DAMPER paragraph above Fig. 6 for information about the vent damper.
- The pilot ignition system will spark, lighting the pilot flame. After 40 to 70 seconds—a timed delay to permit verification that the pilot has been lit, the gas valve permits gas to flow to the burners where it is lit by the pilot. Flames warm the furnace's heat exchanger. After a built-in time delay of approximately 75 seconds, the furnace blower is switched on.
- Adjust your thermostat to the temperature that satisfies your comfort requirements.

IF THE PILOT DOESN'T LIGHT, or the burners fail to ignite, or if the blower doesn't come on . . . , shut down your furnace and call your dealer for service. Refer to the operating instruction label affixed to your furnace blower access door for shutdown procedures.

SHUTTING DOWN YOUR FURNACE

Once the heating season has ended, or if you ever suspect a malfunction, you'll want to turn your furnace off. The following procedures and the procedures on the lighting/operating instructions label on your furnace must be followed. Refer to the lighting/operating instruction label affixed to the blower access door for the correct gas valve picture.

MANUAL IGNITION PILOT

- Set your room thermostat to the lowest temperature setting. See Fig. 19.
- Turn OFF the electrical supply to your furnace. See Fig. 20.
- Remove the access door(s) from your furnace. Lift up and out at the bottom. See Fig. 10 for upflow and Fig. 11 for downflow furnaces.

NOTE: The blower access door must be installed to permit furnace operation. On downflow furnaces, the blower access

door must be removed before the control access door is removed, then reinstalled.

4. To shut off the burners but keep the pilot light burning, turn the control knob of the internal gas valve to the PILOT position.
5. To shut off the complete gas control system (pilot and burners), turn (and depress if required) the control knob on the internal gas valve clockwise or counterclockwise (depending on the type valve supplied with your furnace) to the indicated OFF position.
6. Close the external manual gas valve. See Fig. 8.
7. Replace the access door. See Fig. 15 or 16. On downflow furnaces, remove the blower access door, install the control access door, then reinstall the blower access door.
8. If the furnace is being shut down because a malfunction is suspected, call your dealer as soon as possible.

NOTE: To conserve energy when the heating season has ended, you should shut down your manually ignited pilot.

AUTOMATIC INTERMITTENT IGNITION PILOT

1. Set your room thermostat to the lowest temperature setting. See Fig. 19.
2. Close the external manual gas valve. See Fig. 8.
3. Turn OFF the electrical supply to your furnace. See Fig. 20.
4. Remove the access door(s) from your furnace. Lift up and out at the bottom. See Fig. 10 for upflow and Fig. 11 for downflow furnaces.

NOTE: The blower access door must be installed to permit furnace operation. On downflow furnaces, the blower access door must be removed before the control access door is removed, then reinstalled.

5. Turn the knob on the internal gas valve clockwise or counterclockwise (depending on the type valve supplied with your furnace) to the indicated OFF position. See Fig. 18.
6. Replace the access door. Insert door end into the furnace, push the door in and down. See Fig. 15 or 16. On downflow furnaces, remove the blower access door, install the control access door, then reinstall the blower access door.
7. If the furnace is being shut down because a malfunction is suspected, call your dealer as soon as possible.

PERFORMING ROUTINE MAINTENANCE

Inspect your furnace before each heating season. No obvious signs of deterioration of the furnace should exist.

● The return-air duct connection(s) must be physically sound, sealed to the furnace casing, and terminate outside the space containing the furnace.

The physical support of the furnace must be sound without sagging, cracks, gaps, etc. If the furnace uses only side return ducts, the opening in the furnace base must be sealed.

With the proper maintenance and care, your furnace will operate economically and dependably. Maintenance can easily be accomplished by someone who follows the directions found in this manual. However, before beginning maintenance, consider these safety precautions:

● **TURN OFF THE ELECTRICAL POWER SUPPLY TO YOUR FURNACE BEFORE REMOVING THE ACCESS DOORS TO SERVICE OR PERFORM MAINTENANCE.**

● **ALTHOUGH SPECIAL CARE HAS BEEN TAKEN TO MINIMIZE SHARP EDGES, BE EXTREMELY CAREFUL WHEN HANDLING PARTS OR REACHING INTO THE FURNACE.**

CHECK THE AIR FILTER

A dirty filter will cause excessive stress on the furnace heat exchanger. This stress can cause it to overheat and fail. Check the filter(s) every 3 to 4 weeks. Replace filter(s) when necessary, or clean if you have the reusable type.

Furnaces with side-return air inlets may have different size and type filters. Measure the existing filter for an exact fit. Use same type filter for replacement.

The air filter for upflow furnaces is normally located in the blower compartment. See Fig. 3. Filters for the downflow furnaces are typically located in the return-air plenum near the blower. If the filters have been installed in another location, contact your dealer for instructions.

To change or clean your filter, follow these steps:

1. Turn OFF the electrical supply to the furnace. See Fig. 20. Remove both access doors from your upflow furnace—the control access door first, and the blower access door second. Lift doors up and out. See Fig. 10 or 11. Remove only the blower access door of your downflow furnace.
2. Remove the filter.

● **UPFLOW FURNACES ONLY:** Push the filter retainer toward the back of the furnace until it clears the flange at the front of the furnace casing. Gently remove the filter and carefully turn it over to avoid spilling any dirt that may be on the filter. See Figs. 21 and 22.

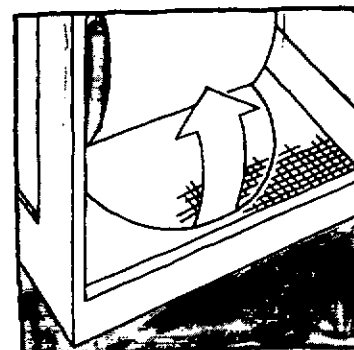

A86038

21

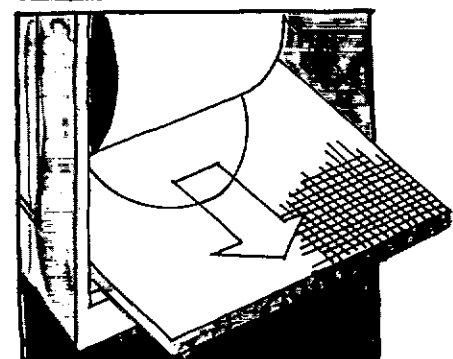

A86039

22

● **DOWNFLOW FURNACES ONLY:** Remove the two filters from inside the return-air plenum which is attached to the top of your furnace. Reaching in and up through the blower access area, tip the left-side filter toward center and raise it from the v-shaped channel in which it rests. Lower and remove the filter gently so that you do not dislodge any dirt that may have accumulated on it. Now, remove the filter on the right side in similar manner, down through the left-hand side of the blower compartment. See Figs. 23 and 24.

3. Inspect the filter.
4. If you have a dirty disposable filter, replace it with a new one. See Furnace Filter Table for replacement filter size. If you have a dirty reusable filter, wash it in a sink or tub; or use an outside garden hose to clean it. Always use cold water . . . and a mild liquid detergent, if necessary. Flush the filter from the side opposite of accumulated dirt. Then, allow the filter to air dry. After the reusable filter is dry, reinstall it with its cross-mesh binding side facing the furnace blower. **UPFLOW FURNACE ONLY:** Replace the filter retainer under the flange of the furnace casing.
5. Replace the access door(s) and restore electrical power to the furnace.

▲ CAUTION

Never operate your furnace without a filter. An accumulation of dust or lint on internal parts can cause a loss of efficiency, and damage to the blower motor and air conditioning system (when used.)

NOTE: Refer to the unit Installation Instructions for blower motor oiling information if oil ports are provided.

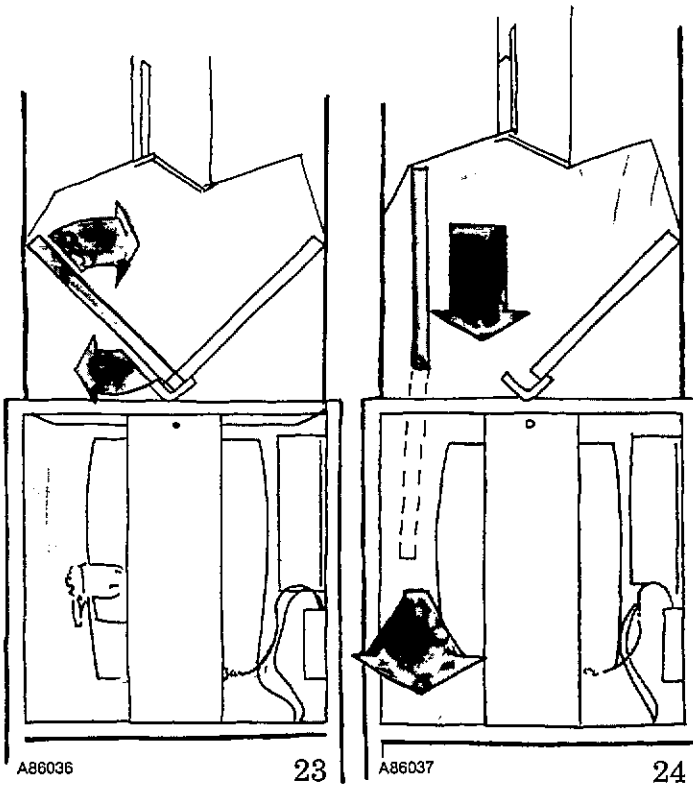

FURNACE FILTER TABLE

| UPFLOW FURNACE CASING WIDTH | FILTER SIZE (INCHES) | FILTER TYPE |
|-------------------------------|----------------------|-------------|
| 14-3/16 | 15-7/8 x 27-3/4 | Cleanable |
| 17-1/2 | 15-7/8 x 27-3/4 | Cleanable |
| 21 | 19-3/8 x 27-3/4 | Cleanable |
| 24-1/2 | 22-7/8 x 27-3/4 | Cleanable |
| 31-1/2 | 29-7/8 x 27-3/4 | Cleanable |
| DOWNFLOW FURNACE CASING WIDTH | FILTER (INCHES) | FILTER TYPE |
| 14-3/16 & 17-1/2 | 16 x 20 (two each) | Disposable |
| 21 & 24-1/2 | 16 x 20 (two each) | Cleanable |

INSPECT COMBUSTION AREA AND VENT SYSTEM

Inspect the combustion area and vent system before each heating season. An accumulation of dirt, soot, or rust can mean a loss of efficiency and unsafe performance. Buildups on the burners can cause faulty firing. This "delayed ignition" is characterized by an alarmingly loud sound. If your furnace makes a loud noise when the burners are ignited by the pilot, shut down the furnace—and call your servicing dealer. Refer to the lighting/operating instruction label affixed to your furnace blower access door (See Figs. 1 and 2 for door identification) for shutdown procedures.

Use your flashlight and follow these steps for inspecting the combustion area and vent system of your furnace:

1. Turn off the electrical supply to the furnace and remove the access door(s). See Figs. 9 and 10 or 11. The blower access door must be installed to permit furnace operation. On downflow furnaces, the blower access door must be removed before the control access door is removed, then reinstalled.
2. Carefully inspect the burner and the pilot areas for dirt, rust, or scale. See Fig. 25. Then, inspect the vent connection area, and the vent pipe for rust.

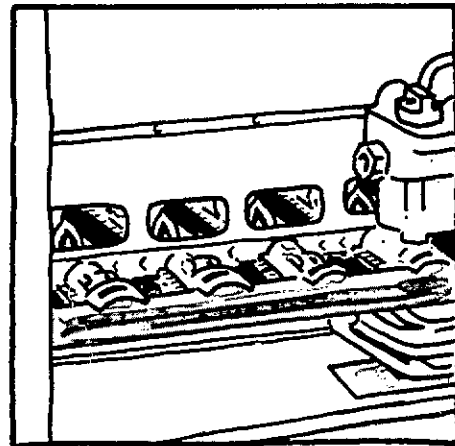

A86048

25

NOTE: If dirt, rust, soot, or scale accumulations or other discrepancies are found, call your servicing agency.

3. Inspect the vent pipe for a sag, holes, obstruction, or a disconnection. Horizontal vent pipes must slope upward at least 1/4 inch per linear foot away from the furnace.

▲ WARNING

If holes are found—or if the vent pipe is obstructed, or is not connected—toxic fumes can escape into your home. **DO NOT OPERATE YOUR FURNACE.** Call your service technician immediately.

Refer to the lighting/operating instruction label affixed to your furnace blower access door for shutdown procedures.

4. Replace the access door and restore electrical power to the furnace. See Fig. 15 or 16. On downflow furnaces, remove the blower access door, install the control access door, then reinstall the blower access door.
5. Start the furnace and observe its operation. If possible, watch the burner flames. See Fig. 25. Are they burning bright blue? If not (or if you suspect some other malfunction), call your servicing dealer.

Refer to the lighting/operating instruction label affixed to your furnace blower access door for shutdown procedures.

BEFORE YOU REQUEST A "SERVICE CALL"

BEFORE YOU CALL FOR SERVICE, CHECK FOR SEVERAL EASILY SOLVED PROBLEMS:

- Check for sufficient airflow. Check the air filter for dirt. Check for blocked return-air or supply-air grilles. Be sure they are open and unobstructed. If this isn't the cause, call your servicing dealer.

If your furnace isn't operating at all, check the following list for easy solutions:

- Is your thermostat set above room temperature? Is the switch in the HEAT position?
- Is the electrical power supply switch ON? Is the blower access door firmly in place? Are any fuses blown, or has a circuit breaker tripped?
- Locate the external manual gas valve in the gas supply pipe which leads to the furnace. Is this lever parallel with the pipe, indicating that the valve is open? Or is the lever at a right angle, indicating that the valve is closed? If closed, has the gas been shut off for safety reasons?

NOTE: Before proceeding with the next check, turn OFF the electrical power supply to the furnace. Remove the control access door. The blower access door must be installed to permit furnace operation. On downflow furnaces, the blower access door must be removed before the control access door is removed, then reinstalled.

- Is the control knob on the internal gas valve turned to the ON position? If it is not, be sure it has not been turned OFF for the purpose of safety. If nothing else seems to be amiss, follow the startup procedures found on the furnace.
- If your furnace has a manual ignition (continuous) pilot system, check for pilot flame. If there is no pilot flame, follow the manual startup procedures on the furnace label. If the pilot flame exists, check the control knob on the internal gas valve. If the knob is in the PILOT position, turn it to the ON position and complete the startup procedures.
- If your furnace uses an automatic, intermittent ignition pilot, check the control knob on the internal gas valve to be sure that it is in the ON position. If it is not, follow the appropriate startup procedures on the furnace label.
- **DOWNFLOW FURNACES ONLY:** Check the manual-reset auxiliary limit switch located on the top right-hand corner of the furnace. See Fig. 4. If the blower motor fails, this switch will shut off the furnace. Reset it by pushing the button on the switch. If it trips again, shut down the furnace and call for service. Refer to the lighting/operating instructions label affixed to your furnace blower access door (See Figs. 1 and 2 for door identification.) for shutdown procedures.

- Check the manual reset switch for the blocked vent shutoff system (located on the bottom of the draft diverter). See Fig. 3 or 4. If the vent is totally obstructed, the blocked vent shutoff system switch will shut off the furnace internal gas valve. To reset the switch: remove the furnace control door, push the reset button located on the back side of the switch, and reinstall the control door. If the blocked vent shutoff system switch trips for a second time, shut down the furnace and call a qualified service agency for service. Refer to the lighting/operating instructions label affixed to your furnace blower access door (See Figs. 1 and 2 for door identification.) for shutdown procedures.

- If your furnace still fails to operate, call a qualified service agency for troubleshooting and repairs. Specify the product and serial numbers of your furnace. (You should have them recorded on page 2 of this manual.) If the dealer knows exactly which furnace you have, he may be able to offer suggestions over the phone, or save valuable time through knowledgeable preparation for the service call.

REGULAR DEALER MAINTENANCE

In addition to the type of routine maintenance you might be willing to perform, your furnace should be inspected regularly by a qualified service agency. An inspection (preferably each year, but at least every other year) should include the following:

- Inspection of all flue product passages—including the burners, pilot, heat exchanger, draft diverter, and vent pipe.
- Inspection of all combustion and ventilation air passages and openings in the furnace and building to assure unobstructed air supply.
- Close inspection of all gas pipes leading to and inside of your home for leaks and/or deterioration.
- Inspection, cleaning, and lubrication (if oil ports are provided) of the blower, blower motor, and wheel.
- Routine inspection and cleaning/replacement of the air filter.
- Inspection of all supply-air and return-air ducts for air leaks, obstructions, and insulation.
- A check for loose fasteners. Inspection of all electrical wiring and their connections.
- Operational check of the furnace itself to determine working condition. Repair or adjustment should be made at this time.
- Any problems found should be resolved at this time.

Your servicing dealer may offer an economical service contract that covers seasonal inspections. Ask him for further details.

CARRIER CORPORATION

IF YOUR UNIT DOES NOT WORK, FOLLOW THESE STEPS IN ORDER:

FIRST: Contact the installer. You may find his name on the product or in your Homeowner's Packet. If his name is not known, call your builder if yours is a new residence.

SECOND: Contact the nearest CARRIER distributor. (See telephone yellow pages.)

THIRD: Contact:

CARRIER CORPORATION
Consumer Relations Department
Carrier Parkway
Syracuse, New York 13221
Telephone: 1-800-CARRIER

Product No. _____ Unit Serial No. _____

Date of Installation _____ Installed by _____

Name of Owner _____ Address of Installation _____

WITH UNCOATED HEAT EXCHANGER

Furnace Limited Warranty

ONE-YEAR WARRANTY—This CARRIER CORPORATION product is warranted to be free from defects in material and workmanship under normal use and maintenance for a period of one year from the date of original installation, whether or not actual use begins on that date. A new or remanufactured part to replace any defective part will be provided at CARRIER CORPORATION'S sole option without charge for the part itself, PROVIDED the defective part is returned to our distributor. This warranty applies only to the product in its original installation location and is voided if the product is reinstalled elsewhere.

THIS WARRANTY DOES NOT INCLUDE LABOR or other costs incurred for diagnosing, repairing, removing, installing, shipping, servicing or handling of either defective parts or replacement parts. SUCH COSTS MAY BE COVERED by a separate warranty provided by the installer.

EXTENDED NINE-YEAR WARRANTY ON HEAT EXCHANGER ONLY—During the second through tenth years after the date of original installation, CARRIER CORPORATION further warranty the heat exchanger against defects in material or workmanship under normal use and maintenance. A heat exchanger will be provided under the same conditions as stated in the One-Year Warranty.

LIMITATIONS OF WARRANTIES—ALL IMPLIED WARRANTIES (INCLUDING IMPLIED WARRANTIES OF MERCHANTABILITY) ARE HEREBY LIMITED IN DURATION TO THE PERIOD FOR WHICH EACH LIMITED WARRANTY IS GIVEN. SOME STATES DO NOT ALLOW LIMITATIONS ON HOW LONG AN IMPLIED WARRANTY LASTS, SO THE ABOVE LIMITATIONS MAY NOT APPLY TO YOU. THE EXPRESSED WARRANTIES MADE IN THIS WARRANTY ARE EXCLUSIVE AND MAY NOT BE ALTERED, ENLARGED, OR CHANGED BY ANY DISTRIBUTOR, DEALER, OR OTHER PERSON WHATSOEVER. ALL WORK UNDER THE TERMS OF THIS WAR-

RANTY SHALL BE PERFORMED DURING NORMAL WORKING HOURS. ALL REPLACEMENT PARTS, WHETHER NEW OR REMANUFACTURED, ASSUME AS THEIR WARRANTY PERIOD ONLY THE REMAINING TIME PERIOD OF THIS WARRANTY.

CARRIER WILL NOT BE RESPONSIBLE FOR:

1. Normal maintenance as outlined in the installation and servicing instructions or owners manual including filter cleaning and/or replacement and lubrication.
2. Damage or repairs required as a consequence of faulty installation or application by others.
3. Failure to start due to voltage conditions, blown fuses, open circuit breakers or other damages due to the inadequacy or interruption of electrical service.
4. Damage or repairs needed as a consequence of any misapplication, abuse, improper servicing, unauthorized alteration or improper operation.
5. Damage as a result of floods, winds, fires, lightning, accidents, corrosive atmosphere or other conditions beyond the control of CARRIER CORPORATION.
6. Parts not supplied or designated by CARRIER CORPORATION.
7. CARRIER CORPORATION products installed outside the continental U.S.A., Alaska, Hawaii and Canada.
8. Electricity or fuel costs or increases in electricity or fuel costs from any reason whatsoever including additional or unusual use of supplemental electric heat.
9. ANY SPECIAL, INDIRECT OR CONSEQUENTIAL PROPERTY OR COMMERCIAL DAMAGE OF ANY NATURE WHATSOEVER. Some states do not allow the exclusion of incidental or consequential damages, so the above limitation may not apply to you.

This warranty gives you specific legal rights, and you may also have other rights which vary from state to state.

Form No. 530-029 (11/86 New)

CARRIER CORPORATION

IF YOUR UNIT DOES NOT WORK, FOLLOW THESE STEPS IN ORDER:

- FIRST:** Contact the installer. You may find his name on the product or in your Homeowner's Packet. If his name is not known, call your builder if yours is a new residence.
- SECOND:** Contact the nearest CARRIER distributor. (See telephone yellow pages.)
- THIRD:** Contact:
CARRIER CORPORATION
Consumer Relations Department
Carrier Parkway
Syracuse, New York 13221
Telephone: 1-800-CARRIER

Product No. _____ Unit Serial No. _____
Date of Installation _____ Installed by _____
Name of Owner _____ Address of Installation _____

WITH COATED HEAT EXCHANGER

Deluxe Furnace Limited Warranty

ONE-YEAR WARRANTY—This CARRIER CORPORATION product is warranted to be free from defects in material and workmanship under normal use and maintenance for a period of one year from the date of original installation, whether or not actual use begins on that date. A new or remanufactured part to replace any defective part will be provided at CARRIER CORPORATION'S sole option without charge for the part itself, PROVIDED the defective part is returned to our distributor. This warranty applies only to the product in its original installation location and is voided if the product is reinstalled elsewhere.

THIS WARRANTY DOES NOT INCLUDE LABOR or other costs incurred for diagnosing, repairing, removing, installing, shipping, servicing or handling of either defective parts or replacement parts. SUCH COSTS MAY BE COVERED by a separate warranty provided by the installer.

EXTENDED NINETEEN-YEAR WARRANTY ON HEAT EXCHANGER ONLY—During the second through twentieth years after the date of original installation, CARRIER CORPORATION further warrants the heat exchanger against defects in material or workmanship under normal use and maintenance. CARRIER CORPORATION WILL, AT ITS OPTION, either provide a new heat exchanger free of charge or allow a credit in the amount of the then current retail selling price of an equivalent heat exchanger towards the purchase price of a new CARRIER CORPORATION furnace.

LIMITATIONS OF WARRANTIES—ALL IMPLIED WARRANTIES (INCLUDING IMPLIED WARRANTIES OF MERCHANTABILITY) ARE HEREBY LIMITED IN DURATION TO THE PERIOD FOR WHICH THE LIMITED WARRANTY IS GIVEN. SOME STATES DO NOT ALLOW LIMITATIONS ON HOW LONG AN IMPLIED WARRANTY LASTS, SO THE ABOVE MAY NOT APPLY TO YOU. THE EXPRESSED WARRANTIES MADE IN THIS WARRANTY ARE EXCLUSIVE AND MAY NOT BE ALTERED, ENLARGED, OR CHANGED BY ANY DISTRIBUTOR,

DEALER, OR OTHER PERSON WHATSOEVER. ALL WORK UNDER THE TERMS OF THIS WARRANTY SHALL BE PERFORMED DURING NORMAL WORKING HOURS. ALL REPLACEMENT PARTS, WHETHER NEW OR REMANUFACTURED, ASSUME AS THEIR WARRANTY PERIOD ONLY THE REMAINING TIME PERIOD OF THIS WARRANTY.

CARRIER WILL NOT BE RESPONSIBLE FOR:

1. Normal maintenance as outlined in the installation and servicing instructions or owners manual including filter cleaning and/or replacement and lubrication.
2. Damage or repairs required as a consequence of faulty installation or application by others.
3. Failure to start due to voltage conditions, blown fuses, open circuit breakers or other damages due to the inadequacy or interruption of electrical service.
4. Damage or repairs needed as a consequence of any misapplication, abuse, improper servicing, unauthorized alteration or improper operation.
5. Damage as a result of floods, winds, fires, lightning, accidents, corrosive atmosphere or other conditions beyond the control of CARRIER CORPORATION.
6. Parts not supplied or designated by CARRIER CORPORATION.
7. CARRIER CORPORATION products installed outside the continental U.S.A., Alaska, Hawaii and Canada.
8. Electricity or fuel costs or increases in electricity or fuel costs from any reason whatsoever including additional or unusual use of supplemental electric heat.
9. ANY SPECIAL, INDIRECT OR CONSEQUENTIAL PROPERTY OR COMMERCIAL DAMAGE OF ANY NATURE WHATSOEVER. Some states do not allow the exclusion of incidental or consequential damages, so the above limitation may not apply to you.

This warranty gives you specific legal rights, and you may also have other rights which vary from state to state.

Form No. 530-028 (11/86 New)



TO OBTAIN INFORMATION ON PARTS: Consult your installing dealer or classified section of your local telephone directory under the "Heating Equipment" or "Air Conditioning Contractors & Systems" headings for dealer listing by brand name. Have available the Model No., Series No., & Serial No. of your equipment to insure correct replacement part.

Carrier Corporation • Syracuse, New York 13221

Manufacturer reserves the right to discontinue, or change at any time, specifications or designs without notice and without incurring obligations.

Free Manuals Download Website

<http://myh66.com>

<http://usermanuals.us>

<http://www.somanuals.com>

<http://www.4manuals.cc>

<http://www.manual-lib.com>

<http://www.404manual.com>

<http://www.luxmanual.com>

<http://aubethermostatmanual.com>

Golf course search by state

<http://golfingnear.com>

Email search by domain

<http://emailbydomain.com>

Auto manuals search

<http://auto.somanuals.com>

TV manuals search

<http://tv.somanuals.com>