

130CR

Electronic Cash Register



130CR-S



130CR-M

User's Manual

START-UP is QUICK and EASY!
Simple to use!
4 departments and 100 PLUs
Automatic Tax Calculations
Calculator function

CASIO®



Thank you very much for purchasing this CASIO electronic cash register.
START-UP is QUICK and EASY!

Part-1 of this User's Manual can help you make a quick start.

Once you have mastered the QUICK START operations, you will undoubtedly want to expand your use of this machine by studying other sections of Part-2.

Original Carton/Package

If for any reason, this product is to be returned to the store where purchased, it must be packed in the original carton/package.

Location

Locate the Cash register on a flat, stable surface, away from heaters or areas exposed to direct sunlight, humidity or dust.

Power Supply

Your cash register is designed to operate on standard household current (120V, 220V, 230V or 240V; 50/60Hz). Do not overload the outlet by plugging in too many appliances.

Cleaning

Clean the cash register exterior with a soft cloth which has been moistened with a solution of a mild neutral detergent and water, and wrung out.

Be sure that the cloth is thoroughly wrung out to avoid damage to the printer.

Never use paint thinner, benzene, or other volatile solvents.

Safety precautions

- To use this product safely and correctly, read this manual thoroughly and operate as instructed. After reading this guide, keep it close at hand for easy reference. Please keep all informations for future reference.
- Always observe the warnings and cautions indicated on the product.

About the icons

In this guide various icons are used to highlight safe operation of this product and to prevent injury to the operator and other personnel and also to prevent damage to property and this product. The icons and definitions are given below.



Indicates that there is a risk of severe injury or death if used incorrectly.



Indicates that injury or damage may result if used incorrectly.

Icon examples

To bring attention to risks and possible damage, the following types of icons are used.



The \triangle symbol indicates that it includes some symbol for attracting attention (including warning). In this triangle the actual type of precautions to be taken (electric shock, in this case) is indicated.



The \otimes symbol indicates a prohibited action. In this symbol the actual type of prohibited actions (disassembly, in this case) will be indicated.



The \bullet symbol indicates a restriction. In this symbol the type of actual restriction (removal of the power plug from an outlet, in this case) is indicated.

Warning!

Handling the register



Should the register malfunction, start to emit smoke or a strange odor, or otherwise behave abnormally, immediately shut down the power and unplug the AC plug from the power outlet. Continued use creates the danger of fire and electric shock.

- Contact CASIO service representative.



Do not place containers of liquids near the register and do not allow any foreign matter to get into it. Should water or other foreign matter get into the register, immediately shut down the power and unplug the AC plug from the power outlet. Continued use creates the danger of short circuit, fire and electric shock.

- Contact CASIO service representative.



Should you drop the register and damage it, immediately shut down the power and unplug the AC plug from the power outlet. Continued use creates the danger of short circuit, fire and electric shock.

- Attempting to repair the register yourself is extremely dangerous. Contact CASIO service representative.

⚠ Warning!



Never try to take the register apart or modify it in any way. High-voltage components inside the register create the danger of fire and electric shock.

- Contact CASIO service representative for all repair and maintenance.

Power plug and AC outlet



Use only a proper AC electric outlet. Use of an outlet with a different voltage from the rating creates the danger of malfunction, fire, and electric shock. Overloading an electric outlet creates the danger of overheating and fire.



Make sure the power plug is inserted as far as it will go. Loose plugs create the danger of electric shock, overheating, and fire.

- Do not use the register if the plug is damaged. Never connect to a power outlet that is loose.



Use a dry cloth to periodically wipe off any dust built up on the prongs of the plug. Humidity can cause poor insulation and create the danger of electric shock and fire if dust stays on the prongs.



Do not allow the power cord or plug to become damaged, and never try to modify them in any way. Continued use of a damaged power cord can cause deterioration of the insulation, exposure of internal wiring, and short circuit, which creates the danger of electric shock and fire.

- Contact CASIO service representative whenever the power cord or plug requires repair or maintenance.

⚠ Caution!



Do not place the register on an unstable or uneven surface. Doing so can cause the register — especially when the drawer is open — to fall, creating the danger of malfunction, fire, and electric shock.



Do not place the register in the following areas.

- Areas where the register will be subject to large amounts of humidity or dust, or directly exposed to hot or cold air.
- Areas exposed to direct sunlight, in a close motor vehicle, or any other area subject to very high temperatures.

The above conditions can cause malfunction, which creates the danger of fire.



Do not overlay bend the power cord, do not allow it to be caught between desks or other furniture, and never place heavy objects on top of the power cord. Doing so can cause short circuit or breaking of the power cord, creating the danger of fire and electric shock.



Be sure to grasp the plug when unplugging the power cord from the wall outlet. Pulling on the cord can damage it, break the wiring, or cause short, creating the danger of fire and electric shock.



Never touch the plug while your hands are wet. Doing so creates the danger of electric shock. Pulling on the cord can damage it, break the wiring, or cause short, creating the danger of fire and electric shock.

Contents

| | |
|---|-----------|
| Getting to know your cash register | 6 |
| Daily Job Flow | 8 |
| Part-1 QUICK START OPERATION | 9 |
| (You can operate this ECR on a basic level by reading the following sections) | |
| 1. Initialization | 9 |
| 2. To Select the Date Format and Monetary Mode | 9 |
| 3. Loading Paper | 10 |
| 4. Basic Programming for QUICK START – TIME/DATE | 11 |
| 5. Basic Operation after Basic Programming | 13 |
| 6. Daily Management Report | 17 |
| Part-2 CONVENIENT OPERATION | 19 |
| (Please keep these sections to expand your use.) | |
| 1. Various Programming | 19 |
| 2. Various Operations | 30 |
| Part-3 CALCULATOR FUNCTION..... | 36 |
| 1. Calculator Mode | 36 |
| Part-4 USEFUL INFORMATION | 38 |
| 1. Troubleshooting | 38 |
| 2. Specifications | 38 |

Before you start

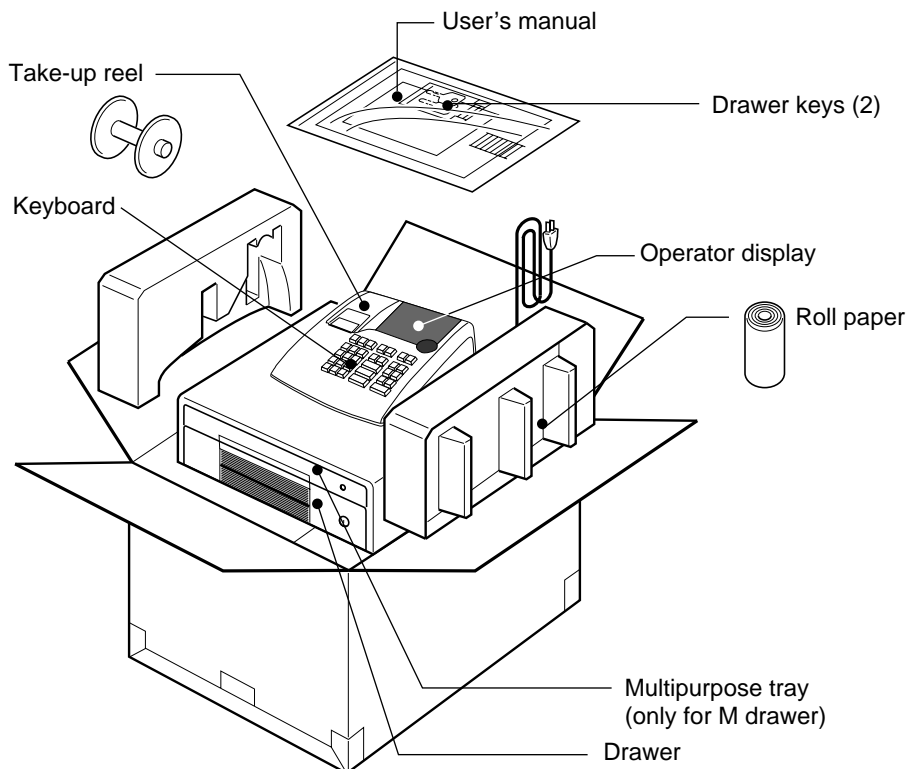

Getting to know your cash register

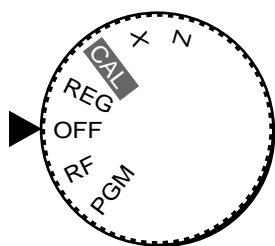

The position of the Mode Switch controls the type of operations you can perform on the cash register.

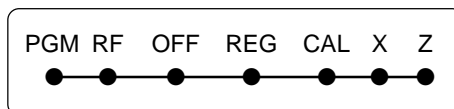

Note:

An error is generated (E01 displayed) whenever the position of the Mode Switch is changed during registration.

OFF

In this position, the power of the cash register is off.

REG (Register)

This is the position used for registration of normal transactions.

RF (Refund)

This is the position used for registration of refunds.

CAL (Calculator)

This is the position used for calculator mode.

PGM (Programming)

This is the position used to program the cash register to suit the needs of your store.

X (Read)

This is the position used to produce reports of daily sales totals without clearing the totals.

Z (Reset)

This is the position used to produce reports of daily sales totals. This setting clears the totals.

Display

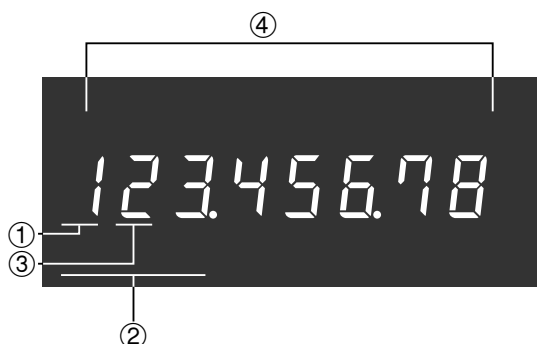

① **Department Number Display**

Anytime you press a department key to register a unit price, the corresponding department number appears here.

② **PLU Number Display**

Anytime you perform a PLU registration, the corresponding PLU number appears here.

③ **Number of Repeat Display**

Anytime you perform "repeat registration" (page 13), the number of repeats appears here.

Note that only one digit is displayed for the number of repeats.

④ **Numeric Display**

Entered values (unit prices or quantities) and calculated values (subtotals, totals or change amount due) are displayed here. The capacity of the display is 8 digits.

This part of the display can be used to show the current time or date between registrations (page 32).

Keyboard

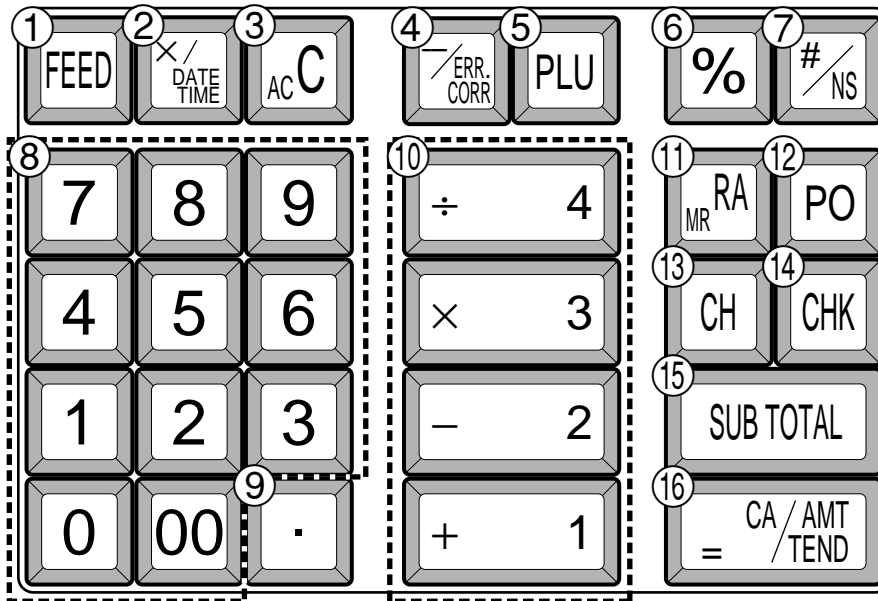

Certain keys have two functions; one for register mode and one for calculator mode.

In this manual, we will refer to specific keys as noted below to make the operations as easy to understand as possible:

Register Mode

- ① **FEED** Feed Key
- ② **x / DATE TIME** Multiplication/Date Time Key
- ③ **AC C** Clear Key
- ④ **/ ERR CORR** Minus/Error Correction Key
- ⑤ **PLU** PLU (Price Look Up) key
- ⑥ **%** Percent Key
- ⑦ **# / NS** Reference Number/No Sale Key
- ⑧ **0 1 ~ 9 , 00** Numeric Keys and 2-zero key
- ⑨ **.** Decimal key
- ⑩ **+ 1 - 2 x 3 ÷ 4** Department Keys
- ⑪ **RA / MR** Received On Account Key
- ⑫ **PO** Paid Out Key
- ⑬ **CH** Charge Key

- ⑭ **CHK** Check Key
- ⑮ **SUB TOTAL** Subtotal Key
- ⑯ **= CA / AMT TEND** Cash Amount Tendered Key

Calculator Mode

- ③ **AC c** AC Key
- ⑥ **%** Percent Key
- ⑧ **0 1 ~ 9 , 00** Numeric Keys and 2-zero key
- ⑨ **.** Decimal key
- ⑩ **+ 1 - 2 x 3 ÷ 4** Arithmetic Operation Keys
- ⑪ **RA / MR** Memory Recall key
- ⑯ **= CA / AMT TEND** Equal Key

Daily Job Flow

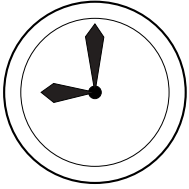

Before Opening The Store

1. Plugged in?
2. Enough Roll Paper?
3. Date and Time is correct?
4. Enough small change in the drawer?

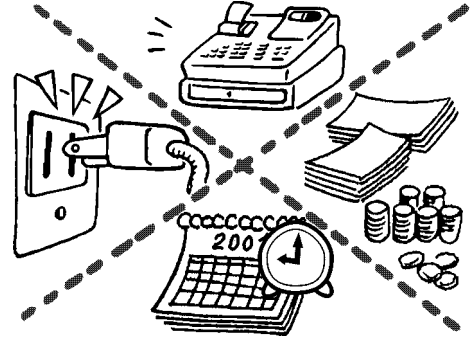

While The Store Is Open

1. Registrations.
2. Issuing latest daily sales total if needed.
(Generating report by Mode Switch to X position.)

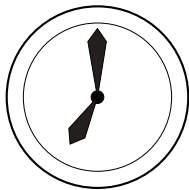

After Closing The Store

1. Issuing Daily Sales Total.
(Resetting report by Mode Switch to Z position.)
2. Picking up money in the drawer.
3. Turn the Mode Switch to OFF.

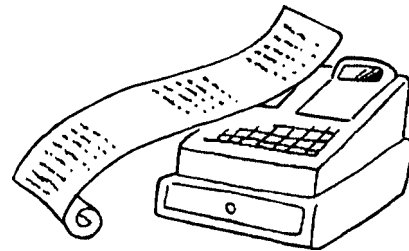



1. Initialization / Loading Memory Protection Battery

Important

You must initialize the Cash register.

To initialize the cash register

1. Set the Mode Switch to OFF.
2. Plug the power cord of the cash register into an AC outlet.
3. Load the memory protection batteries.
4. Set the Mode Switch to REG.

Note: To prevent to lose all of your settings and sales data, we recommend you to install the memory protection batteries.

To load the memory protection batteries

1. Remove the printer cover.
2. Open the battery compartment cover.
3. Load 3 new UM-3, R6P (SUM-3) or LR6 (AM-3) type batteries into the compartment. Be sure that the plus (+) and minus (-) ends of each battery are facing in the directions indicated by the illustrations inside the battery compartment (Figure 1).
4. Slide the memory protection battery compartment cover back into place.
5. Replace the printer paper and printer cover.

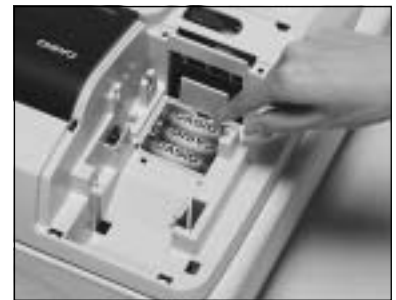

(Figure 1)

REPLACE MEMORY PROTECTION BATTERIES AT LEAST ONCE EVERY YEAR.

2. To Select the Date Format and Monetary Mode

You can select the date format and Monetary mode after initialization depending on the requirements in your area. Default date format is Day/Month/Year. Default Monetary Mode is Add 2.

Example:

Change the date format to Month/Day/Year, and change Monetary mode to Add 0.

1. Set the Mode Switch to PGM.
2. Press the following keys.

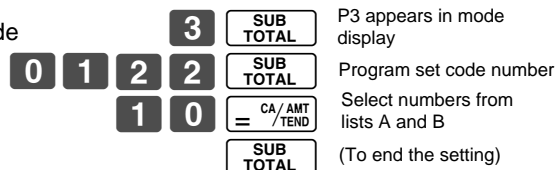

| Date Format Selections | |
|------------------------|---|
| Year/Month/Day | 0 |
| Month/Day/Year | 1 |
| Day/Month/Year | 2 |

| Monetary Mode Selections | |
|--------------------------|---|
| Add 0 (0.) | 0 |
| Add 1 (0.0) | 1 |
| Add 2 (0.00) | 2 |

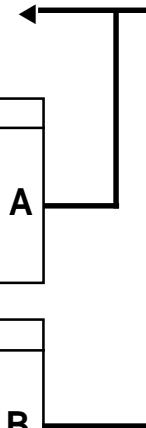

3. Loading Paper Roll And Replacing The Printer's Ink Roll

Mode Switch to REG

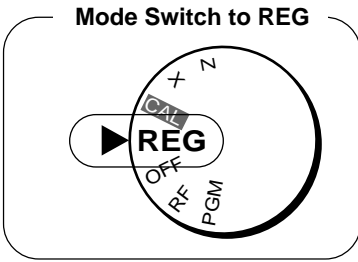

1. To load journal paper

- ① Remove the printer cover by lifting up the back.



- ② Put a roll of journal paper into the holder.
- ③ Cut the leading end of the roll paper with scissors and insert the paper into the inlet.



- ④ Press the **FEED** key until 20 or 30 cm of paper is fed from the printer.
- ⑤ Roll the paper onto the take-up reel a few turns.



- ⑥ Set the left plate of the take-up reel and place the reel into the register.



- ⑦ Press the **FEED** key to take up any slack in the paper.
- ⑧ Replace the printer cover by placing the cover's front tab into the register's groove.



2. To remove journal paper

- ① Remove the printer cover following the instructions above.
- ② Press the **FEED** key until approximately 20cm of the paper is fed from the printer.
- ③ Cut off the roll paper.



- ④ Remove the take-up reel from the printer and take off the left plate of the reel.
- ⑤ Remove the journal paper from the take-up reel.



- ⑥ Cut off the paper left in the printer and press the **FEED** key until the remaining paper is fed out from the printer.



- ⑦ Remove the core of the paper.



- ⑧ Load new paper following the instructions above, and replace the printer cover.

Default printer setting is for Journal. To print receipts, please refer to 1-7-3 on page 24 to switch the printer for Receipt or Journal.

▶ To load receipt paper

- ① To use the printer to print receipts, follow steps 1 through 4 of "To load journal paper".
- ② Pass the leading end of the receipt paper through the printer cover's paper outlet and replace the printer cover.
- ③ Tear off any excess paper.

Mode Switch to OFF

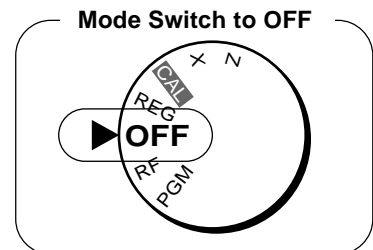

▶ To replace the ink roll

- ① Remove the printer cover.
- ② Lift up the tab on the ink roll marked "PULL UP".



- ③ Install a new Ink Roll and press it down firmly but gently until it snaps into place.
- ④ Replace the printer cover onto the cash register.
- ⑤ Press the **#/NS** key to check for correct operation.

Options: Roll paper – P-5860
Ink Roll – IR-40

4. Basic Programming for QUICK START

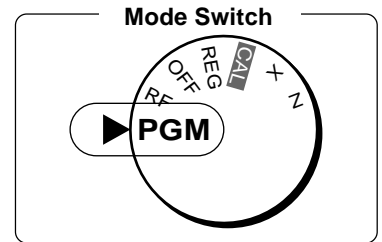

Part-1

| Procedure | Purpose |
|--|--|
| <p>1. Turn the mode switch to PGM position.</p> | <p>Programming</p> |
| <p>2. Press the following keys to set the current time.</p> <p>Example: 13:18 PM = 1318</p> <div style="display: flex; align-items: center; justify-content: center;"> <div style="text-align: center; margin-right: 10px;"> <p>1 3 1 8</p> <p>Time Minutes</p> </div> <div style="margin-right: 10px;"> <p>1 SUB TOTAL</p> </div> <div style="margin-right: 10px;"> <p>X/DATE TIME</p> </div> <div> <p>AC C</p> </div> </div> <p>P appears in mode display (to end the time setting)</p> <ul style="list-style-type: none"> • Enter 4 digits • 24-hour time format | <p>Setting the current time</p> |
| <p>3. Press the following keys to set the current date.</p> <p>Example: January 8, 2005 = 050108</p> <div style="display: flex; align-items: center; justify-content: center;"> <div style="text-align: center; margin-right: 10px;"> <p>0 5 0 1 0 8</p> <p>Year Month Day</p> </div> <div style="margin-right: 10px;"> <p>1 SUB TOTAL</p> </div> <div style="margin-right: 10px;"> <p>X/DATE TIME</p> </div> <div> <p>AC C</p> </div> </div> <p>P appears in mode display (to end the date setting)</p> <ul style="list-style-type: none"> • Enter 6 digits • Enter last 2 digits for year set. (2006 → 06) | <p>Setting the current date</p> |
| <p>4. You can set only one tax calculation system – either an add-on or an add-in depending on the laws in your area. Press the following keys to set the tax rate.</p> <p>Example: Set tax rate 1 as 5.25% and tax rate 2 as 10%.</p> <div style="display: flex; align-items: center; justify-content: center; margin-bottom: 10px;"> <div style="text-align: center; margin-right: 10px;"> <p>3 SUB TOTAL</p> </div> <div> <p>P3 appears in mode display</p> </div> </div> <div style="display: flex; align-items: center; justify-content: center; margin-bottom: 10px;"> <div style="text-align: center; margin-right: 10px;"> <p>0 1 2 5</p> </div> <div style="margin-right: 10px;"> <p>SUB TOTAL</p> </div> <div> <p>Program set code No. for tax rate 1</p> </div> </div> <div style="display: flex; align-items: center; justify-content: center; margin-bottom: 10px;"> <div style="text-align: center; margin-right: 10px;"> <p>5 . 2 5</p> </div> <div style="margin-right: 10px;"> <p>= CA/AMT TEND</p> </div> <div> <p>5.25% tax rate</p> </div> </div> <div style="display: flex; align-items: center; justify-content: center; margin-bottom: 10px;"> <div style="text-align: center; margin-right: 10px;"> <p>5 0 0 3</p> </div> <div style="margin-right: 10px;"> <p>= CA/AMT TEND</p> </div> <div> <p>50 for Round off and 03 for VAT (Value Added Tax) – Add In</p> </div> </div> <div style="display: flex; align-items: center; justify-content: center; margin-bottom: 10px;"> <div style="margin-right: 10px;"> <p>SUB TOTAL</p> </div> <div style="margin-right: 10px;"> <p>SUB TOTAL</p> </div> <div> <p>Program set code No. for tax rate 2</p> </div> </div> <div style="display: flex; align-items: center; justify-content: center; margin-bottom: 10px;"> <div style="text-align: center; margin-right: 10px;"> <p>0 2 2 5</p> </div> <div style="margin-right: 10px;"> <p>SUB TOTAL</p> </div> <div> <p>10% tax rate</p> </div> </div> <div style="display: flex; align-items: center; justify-content: center; margin-bottom: 10px;"> <div style="text-align: center; margin-right: 10px;"> <p>1 0</p> </div> <div style="margin-right: 10px;"> <p>= CA/AMT TEND</p> </div> <div> <p>50 for Round off and 03 for VAT (Value Added Tax) – Add In</p> </div> </div> <div style="display: flex; align-items: center; justify-content: center; margin-bottom: 10px;"> <div style="text-align: center; margin-right: 10px;"> <p>5 0 0 3</p> </div> <div style="margin-right: 10px;"> <p>= CA/AMT TEND</p> </div> <div> <p>50 for Round off and 03 for VAT (Value Added Tax) – Add In</p> </div> </div> <div style="display: flex; align-items: center; justify-content: center;"> <div style="margin-right: 10px;"> <p>SUB TOTAL</p> </div> <div> <p>(to end the setting)</p> </div> </div> <ul style="list-style-type: none"> • See page 26 to specify the tax system and rounding for details. | <p>Setting the Tax rate</p> |
| <p>5. Press the following keys to preset tax status of departments.</p> <p>Tax status for the Departments are fixed as Non-taxable.</p> <p>Example: Set Departments 1 and 2 as taxable status 1.</p> <div style="display: flex; align-items: center; justify-content: center; margin-bottom: 10px;"> <div style="text-align: center; margin-right: 10px;"> <p>1 SUB TOTAL</p> </div> <div> <p>P appears in mode display</p> </div> </div> <div style="display: flex; align-items: center; justify-content: center;"> <div style="text-align: center; margin-right: 10px;"> <p>RA/MR + 1 - 2</p> </div> <div style="margin-right: 10px;"> <p>SUB TOTAL</p> </div> <div> <p>SUB TOTAL</p> </div> </div> <ul style="list-style-type: none"> • See page 19 to change the fixed tax status. | <p>Setting the status of Departments</p> |

| Procedure | Purpose |
|---|-------------------------|
| <p>6. For the Euro only</p> <p>6-1. Press the following keys to define the main currency/print out currency of the subtotal.</p> <div style="text-align: center;"> <p>3 SUB TOTAL P3 appears in mode display</p> <p>2 4 2 2 SUB TOTAL</p> <p>1 = CA/AMT /TEND</p> <p>Euro Status</p> <p>SUB TOTAL (to end the setting)</p> <p>Euro status</p> <p>(1) Main currency = Local, Print out subtotal = Local: 0</p> <p>(2) Main currency = Euro, Print out subtotal = Euro: 1</p> <p>(3) Main currency = Local, Print out subtotal = Both: 2</p> <p>(4) Main currency = Euro, Print out subtotal = Both: 3</p> </div> <p>6-2. Press the following keys to set the currency exchange rate against the Euro.</p> <div style="text-align: center;"> <p>3 SUB TOTAL P3 appears in mode display</p> <p>1 9 9 9 SUB TOTAL</p> <p>1 9 7 7 3 = CA/AMT /TEND</p> <p>Exchange rate Decimal position (up to 6 digits)</p> <p>SUB TOTAL (to end the setting)</p> <p>Example: (Exchange rate and decimal position)</p> <p>Currency exchange rate = 1 Euro in local currency</p> <p>1 Euro = 1.9583 DM : 1 9 5 5 8 3 5</p> </div> | <p>Setting the Euro</p> |

| Procedure | Purpose |
|---|-----------------------------------|
| <p>For Australia only.</p> <p>You can set some programmable options to suit the Australian GST by the following procedure.</p> <p>1. Turn the mode switch to Z position.</p> <p>2. Press the following keys to program.</p> <div style="text-align: center;"> <p>0 1 0 1 2 0 0 1 SUB TOTAL = CA/AMT /TEND</p> <p>If you want to cancel this operation, press SUB TOTAL instead of = CA/AMT /TEND.</p> </div> | <p>Setting the Australian GST</p> |

| Procedure | Purpose |
|---|--|
| <p>For the Euro only.</p> <p>You can restrict the registable currency to the Euro only by the following procedure.</p> <p>1. Turn the mode switch to Z position.</p> <p>2. Issue all reset report including periodic data.</p> <p>3. Press the following keys to set.</p> <div style="text-align: center;"> <p>0 1 0 7 2 0 0 2 SUB TOTAL = CA/AMT /TEND</p> <p>If you want to cancel this operation, press SUB TOTAL instead of = CA/AMT /TEND.</p> </div> | <p>Restricting the currency (Euro)</p> |

5. Basic Operation after Basic Programming

Note:

Whenever an error is generated (E01 displayed), the input figures reset to 0.

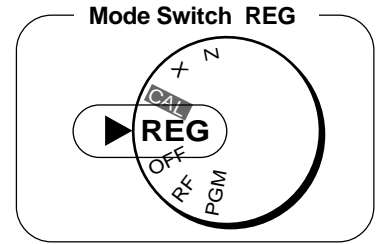

Part-1



5-1 Open the drawer without a sale

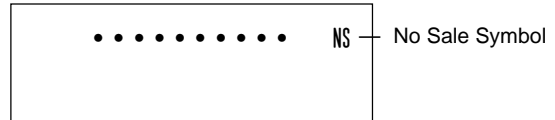

5-2 Basic operation

Example

| | |
|----------------------|--------|
| Unit Price | \$1.00 |
| Quantity | 1 |
| Dept. | 1 |
| Cash Amount tendered | \$5.00 |

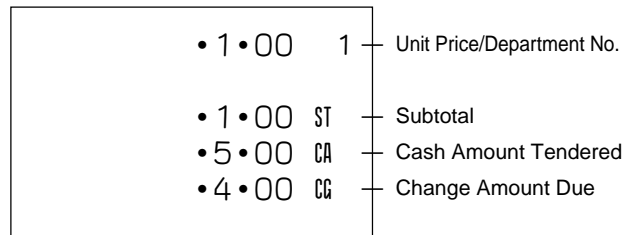
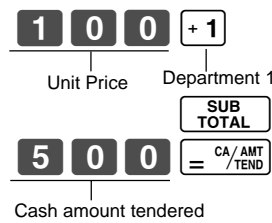

5-3 Multiple registration of the same items

Example

| | | |
|------------|--------|--------|
| Unit Price | \$1.00 | \$1.35 |
| Quantity | 2 | 3 |
| Dept. | 1 | 2 |

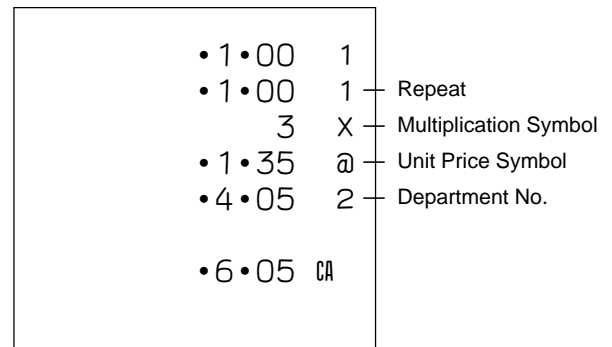
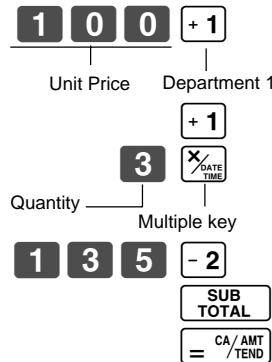

Note that repeat registration can be used with unit prices up to 6 digits long.

5-4 Charge sales

Example

| | | | |
|------------|--------|--------|--------|
| Unit Price | \$1.00 | \$2.00 | \$3.00 |
| Quantity | 1 | 1 | 1 |
| Dept. | 1 | 2 | 1 |

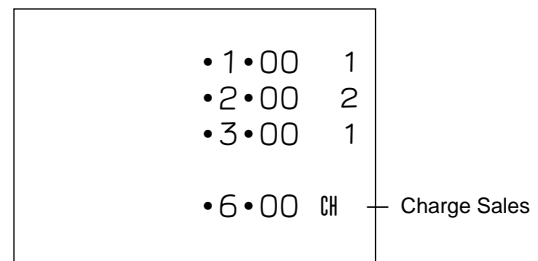
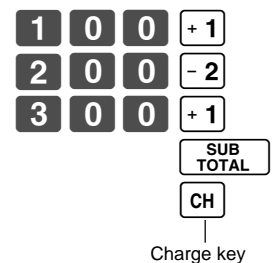

You cannot perform the amount tendered operation using the CH key.

5-5 Split cash/charge sales

Example

| | | | |
|----------------------|--------|--------|--------|
| Unit Price | \$2.00 | \$3.00 | \$4.00 |
| Quantity | 1 | 1 | 1 |
| Dept. | 1 | 2 | 1 |
| Cash Amount tendered | \$5.00 | | |

Operation

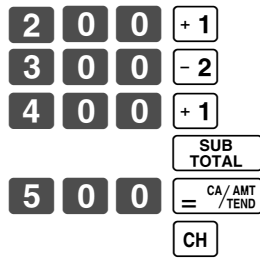

Printout

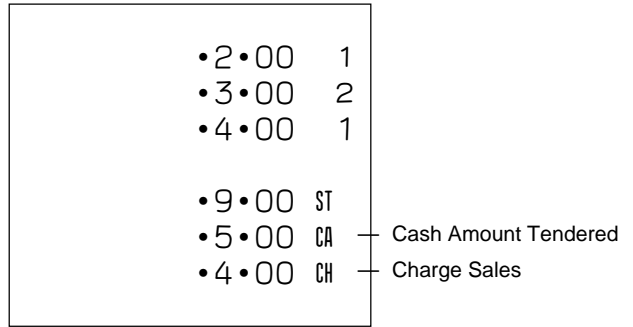

5-6 Corrections

Corrections can be made while you are registering the item (before you press a department key), or after it has already been registered into the memory (by pressing a department key).

5-6-1 Before you press a department key

AC C key clears the last item entered.

Example

- Entered 400 for unit price by mistake instead of 100.

Operation

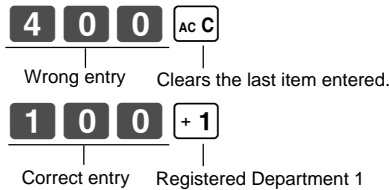

Printout

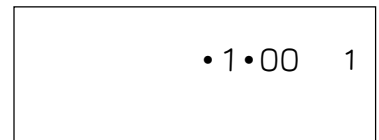

- Entered unit price first instead of quantity and then pressed **X/DATE TIME**.

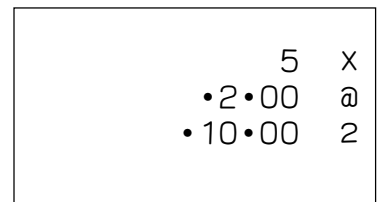
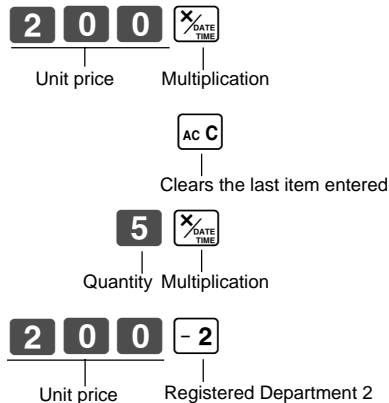

- Entered 150 for unit price by mistake instead of 105.

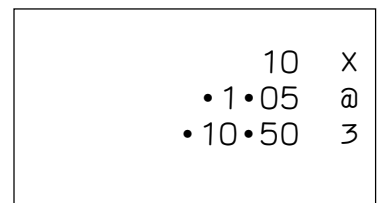
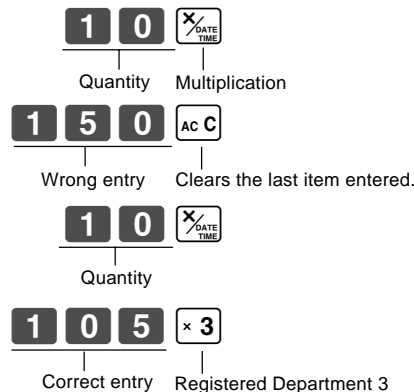

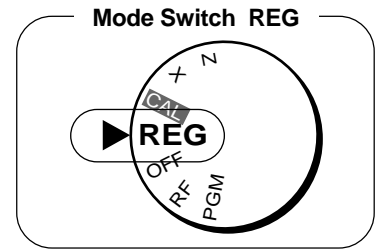

Part-1

Operation

Printout

5-6-2 After you pressed a department key

ERR. CORR key cancels the last registered item.

Example

- Entered unit price 550 by mistake instead of 505 and pressed a department key.

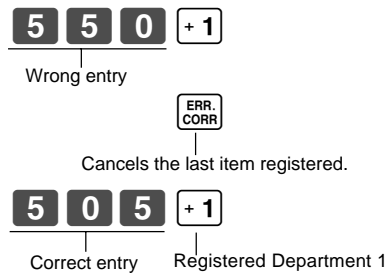

| | |
|-------|----|
| •5•50 | 1 |
| -5•50 | VD |
| •5•05 | 1 |

- Entered unit price 220 by mistake instead of 230 and pressed a department key.

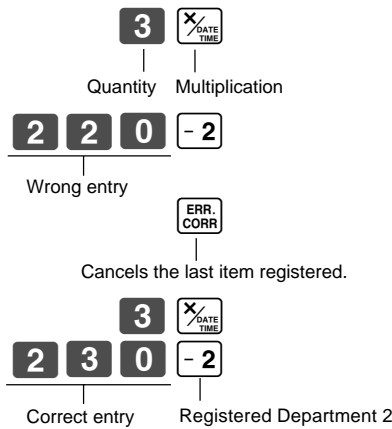

| | | |
|-------|----|---|
| | 3 | X |
| •2•20 | @ | |
| •6•60 | 2 | |
| -6•60 | VD | |
| | 3 | X |
| •2•30 | @ | |
| •6•90 | 2 | |

5-7-1 Registering with currency exchange

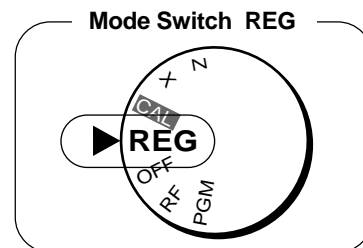

Example

| | |
|----------------------|-----------------|
| Unit Price | 2.00 |
| Quantity | 3 |
| Dept. | 1 |
| Cash Amount Tendered | Euro 15.00 |
| Rate | 1Euro = 0.5 Fr |
| Main currency | Local (Fr) |
| Printout of ST | Both currencies |

Operation ————— **Display**

3 X DATE TIME
2 0 0 + 1
PO
SUB TOTAL

Pressing **PO** before subtotal converts the subtotal amount into the Euro.

1200E

1 5 00
PO

Pressing **PO** after amount tendered converts the amount into the Euro. *1

1500E

= CA / AMT / TEND

Press = CA / AMT / TEND to finalize the transaction. The change amount in the main currency is shown on the display. *2

150

= CA / AMT / TEND

You can switch the currency of change amount repeatedly by pressing the = CA / AMT / TEND key.

300E

- *1 If the payment is the same as the subtotal amount, you can omit this operation. Press = CA / AMT / TEND key directly after the subtotal.
- *2 If the payment is less than the subtotal amount, the cash register specifies it as a partial payment and shows the balance in the main currency on the display.

Printout

| | | |
|--------|----|-------------------------------|
| 3 | X | |
| •2•00 | @ | |
| •6•00 | 1 | |
| •6•00 | ST | Subtotal in the main currency |
| €12•00 | @ | Subtotal after conversion |
| €15•00 | CA | Payment in the Euro |
| | @ | |
| •7•50 | CA | Payment after conversion |
| •1•50 | CG | Change in the main currency |
| €3•00 | @ | Change in the sub currency |

6. Daily Management Report

This section tells you the procedures to use to produce reports of the transaction data stored in the cash register's memory.

Important

Remember that when you issue a reset (Z) report, the data that is reported is cleared from the applicable totalizers. To view data without clearing totalizers, issue a read (X) report.

6-1 Financial Report

Operation

Printout

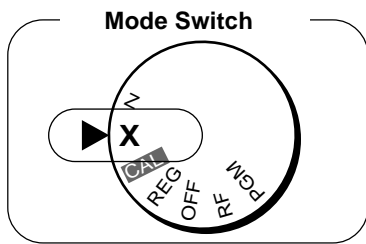

| | |
|---------------|----------------------------|
| 08-01-05 | Date |
| 12-35#0085 | Time/Consecutive No. |
| X | Read Symbol |
| 158 * | Gross Sales No. of items |
| •16676•48 * | Gross Sales Amount |
| 46 NT | Net Sales No. of Customers |
| •16675•99 NT | Net Sales Amount |
| •16518•99 CA# | Cash Total in Drawer |
| •92•00 CH# | Charge Total in Drawer |
| •70•00 *CK | Check Total in Drawer |

6-2 General Control Read/Reset Report

Operation

Printout

6-2-1 Daily Read/Reset Report

Mode Switch to **X**
(Read)



Z (Reset) report

| | |
|-------------|--|
| 08-01-05 | Date |
| 19-35#0086 | Time/Consecutive No. |
| 0001 Z | Non-resettable No. of Resets/RESET Symbol ** |
| 48 1 | No. of Items/Dept. No. |
| •166•94 | Amount |
| 61 2 | |
| •1259•15 | |
| 44 3 | |
| •15175•39 | |
| 5 4 | |
| •75•00 | |
| 158 * | Gross Sales No. of Items |
| •16676•48 * | Gross Sales Amount |

Mode Switch to **Z**
(Reset)



| | | |
|------------|------|---|
| • 1•40 | - | Reduction Amount |
| • 0•91 | %+ | Premium/Discount Amount |
| • 1182•64 | TA | Taxable Amount for Tax Rate 1 |
| • 62•07 | TX | Tax Amount for Tax Rate 1 |
| • 167•45 | *TA | Taxable Amount for Tax Rate 2 |
| • 16•75 | TX2 | Tax Amount for Tax Rate 2 |
| 46 | NT | Net Sales No. of Customers |
| • 16675•99 | NT | Net Sales Amount |
| 47 | CA | Cash Sales Count |
| • 16513•99 | CA | Cash Sales Amount |
| 4 | CH | Charge Sales Count |
| • 92•00 | CH | Charge Sales Amount |
| 1 | CK | Check Sales Count |
| • 70•00 | CK | Check Sales Amount |
| • 15•00 | RA | Received On Account Amount |
| • 10•00 | PO | Paid Out Amount |
| 4 | VD | Error Correction Count |
| 1 | RF | Refnd Mode Count |
| • 3•00 | RF | Refund Mode Amount |
| 16 | CA X | No. of <input type="checkbox"/> CA/ <input type="checkbox"/> AMT/ <input type="checkbox"/> TEND key operation |
| 1 | NS | No sale Count |
| • 16518•99 | CA # | Cash in Drawer |
| • 92•00 | CH # | Charge in Drawer |
| • 70•00 | *CK | Check in Drawer |
| 000001 | | Non-resettable Grand Sales total |
| 6675•99 | | (Printed only on RESET report) ² |

X (Read) report is the same except ¹ and ².

6-2-2 Periodic Read/Reset Report

Operation

Printout

Mode Switch to

Z or **X**

1 0 CA/ AMT/ TEND

| | |
|--------------|----------------------------|
| 08-01-05 | Date |
| 19-50#0087 | Time/Consecutive No. |
| # 10#•••• X | Read Symbol |
| 77 * | Gross Sales No. of Items |
| • 1116•90 * | Gross Sales Amount |
| 11 NT | Net Sales No. of Customers |
| • 1116•90 NT | Net Sales Amount |



CONVENIENT OPERATION

1. Various Programming

1-1 Unit price for Departments

Example

| | | | |
|------------|--------|--------|---------|
| Unit Price | \$1.00 | \$2.20 | \$11.00 |
| Dept. | 1 | 2 | 3 |

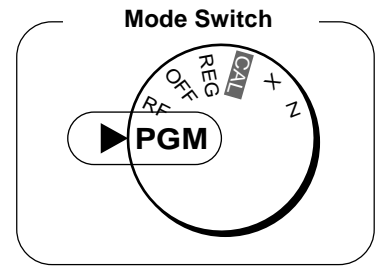
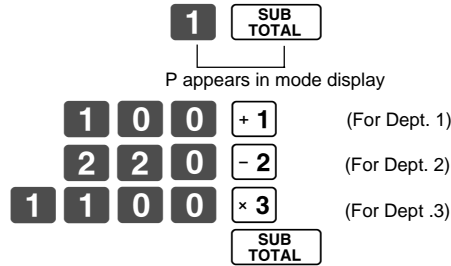

• Unit prices within the range of 0.01~9999.99.

1-2 Rate for percent key

Example

| | |
|---------------|------|
| Discount Rate | 2.5% |
|---------------|------|

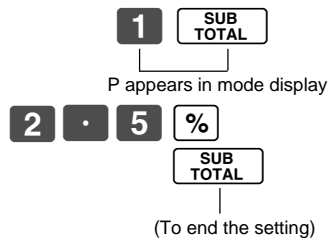

• The rate within the range of 00.01 to 99.99%.

1-3 To change tax status for Departments

Tax status for the Departments 1~4 are initialized as Non-Taxable.

Example

| | | |
|--------|-----------|-----------|
| Status | Taxable 1 | Taxable 2 |
| Depts. | 1 | 2 |

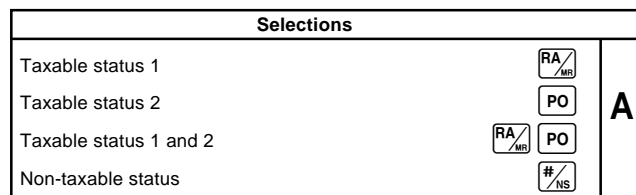
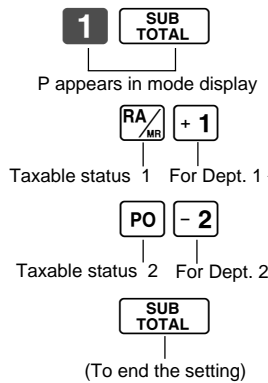

Part-2

1-4 Status for Department

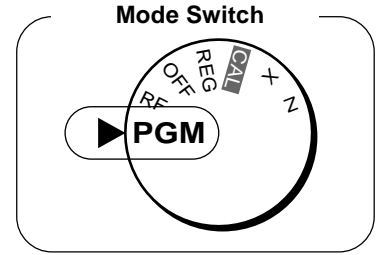

Example

| Depts. | Selections | | |
|--------|------------|---|---|
| | A | B | C |
| 1 | 0 | 4 | 1 |
| 2 | 0 | 5 | 1 |

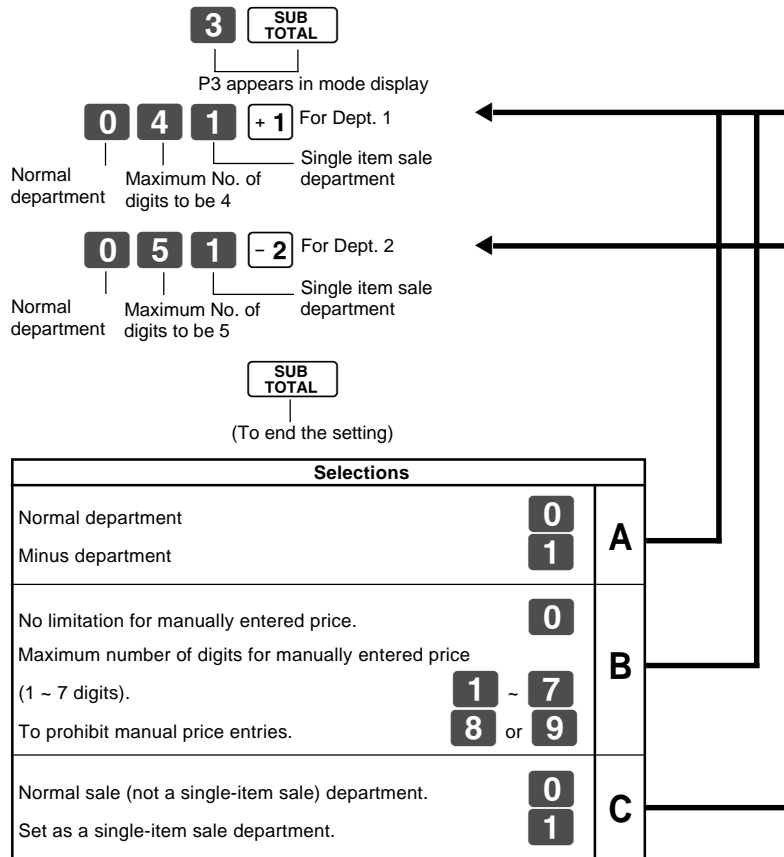

1-5 Status for percent key

1-5-1 To change taxable status for the percent key

The percent key is initialized as Non-taxable.

Example

Change Percent key registration as a Taxable status 1.

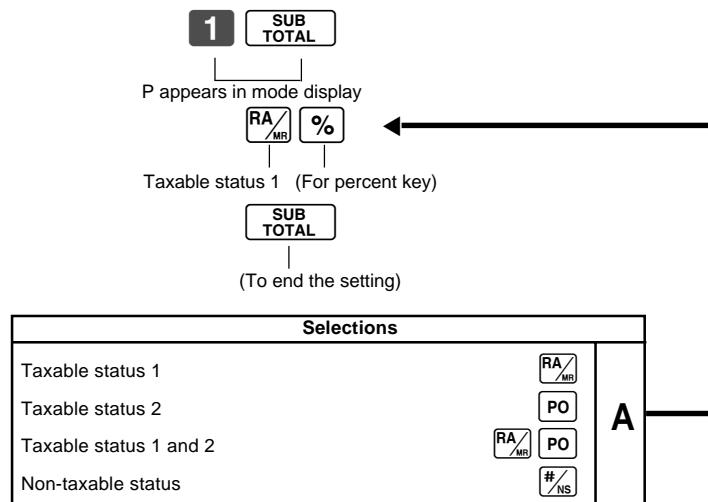

1-5-2 Status for percent key

Example

| | |
|---------|----|
| Round | Up |
| Percent | %+ |

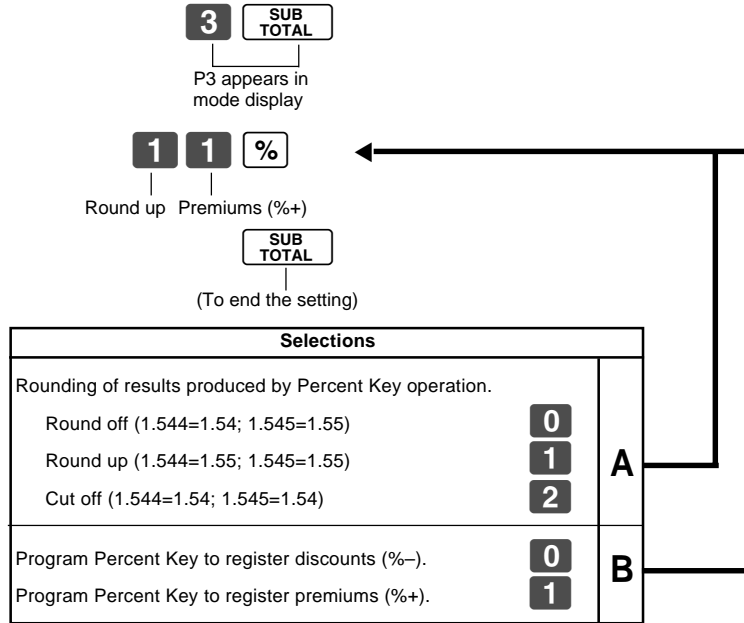

Part-2

1-6 Taxable Status for minus key

Example :

Change minus key registrations
Taxable status 1.

The minus key is initialized as Non-taxable.

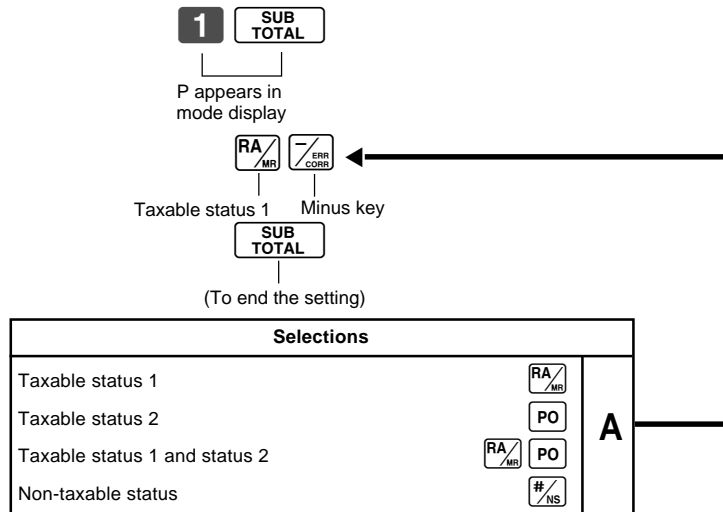

1-7 General features

1-7-1 To set general controls

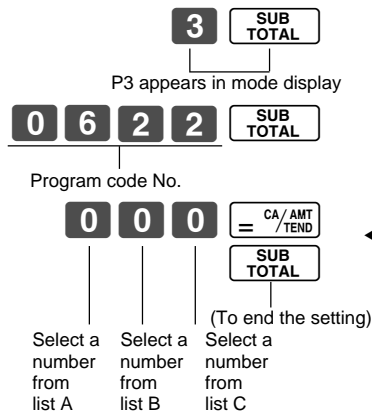
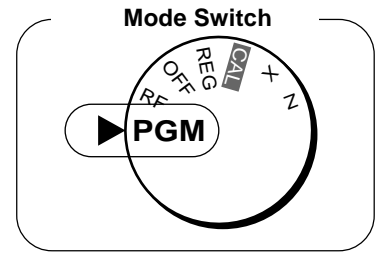

| Selections | | | |
|---|-----|-----|---|
| Maintain key buffer during receipt issue in REG mode. | | | |
| Reset the transaction number to zero whenever a General Control Reset Report is issued. | | | |
| Allow credit balance registration. | | | |
| No | Yes | Yes | 0 |
| | | No | 1 |
| | No | Yes | 2 |
| | | No | 3 |
| Yes | Yes | Yes | 4 |
| | | No | 5 |
| | No | Yes | 6 |
| | | No | 7 |

| Selections | | | |
|--|-----|-----|---|
| Limit the last 2 digits of cash amount tendered to 00, 25, 50 and 75 when Denmark rounding is specified for subtotal and total amount. | | | |
| Allow partial cash amount tendered. | | | |
| Allow partial check amount tendered. | | | |
| Yes | Yes | No | 0 |
| | | Yes | 1 |
| | No | No | 2 |
| | | Yes | 3 |
| No | Yes | No | 4 |
| | | Yes | 5 |
| | No | No | 6 |
| | | Yes | 7 |

| Selections | |
|---------------------------------------|---|
| Use the 00 key on a numeric keyboard. | 0 |
| Use the 00 key as a 000 key. | 1 |

1-7-2 To set printing controls

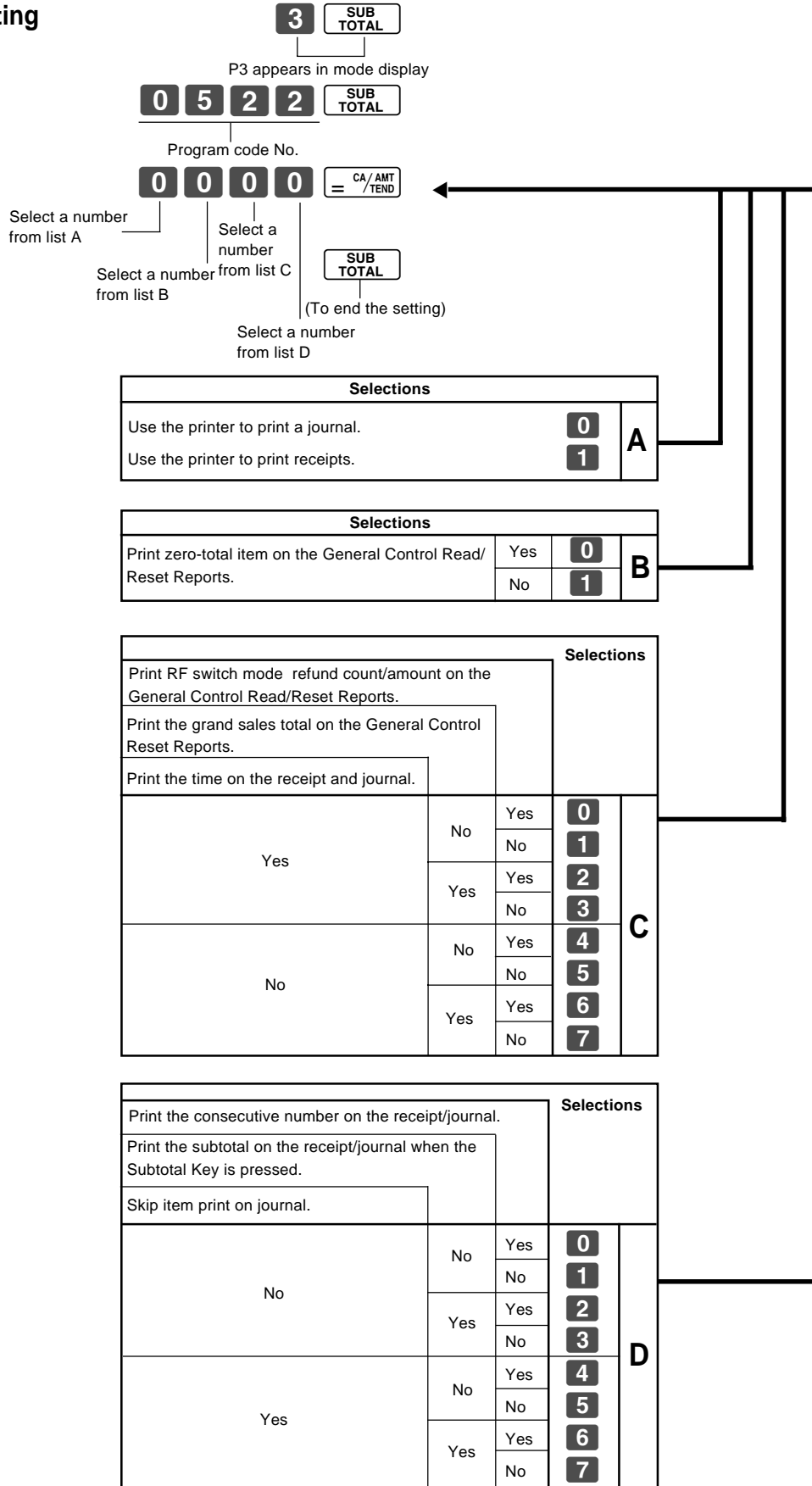

Part-2

1-7-3 Printer switch for Receipt or Journal

The printer is initialized as journal.

Example

To print a receipt

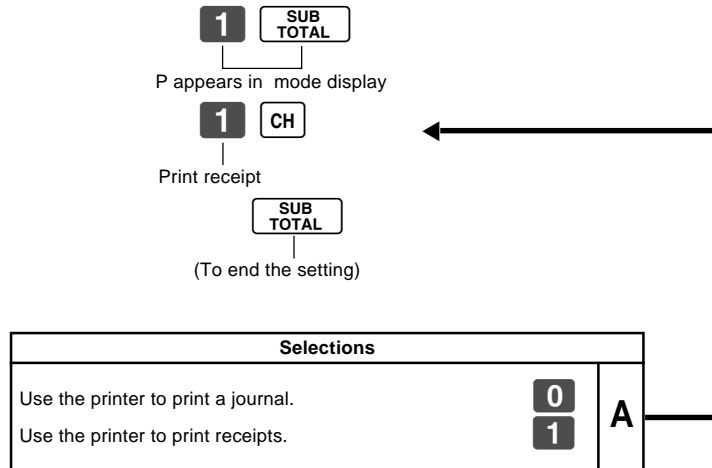
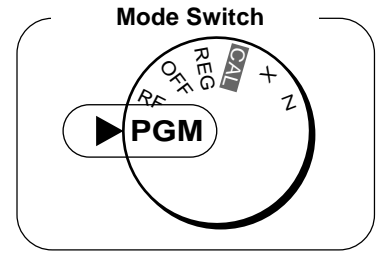

- Printer selection to print a journal or receipts can also be set on procedures 1-7-2 "To set printing controls".

1-8 PLU setting

1-8-1 Linkage with Departments

Example

| | | |
|----------------|---|-----|
| PLU No. | 1 | 100 |
| Link Dept. No. | 1 | 4 |

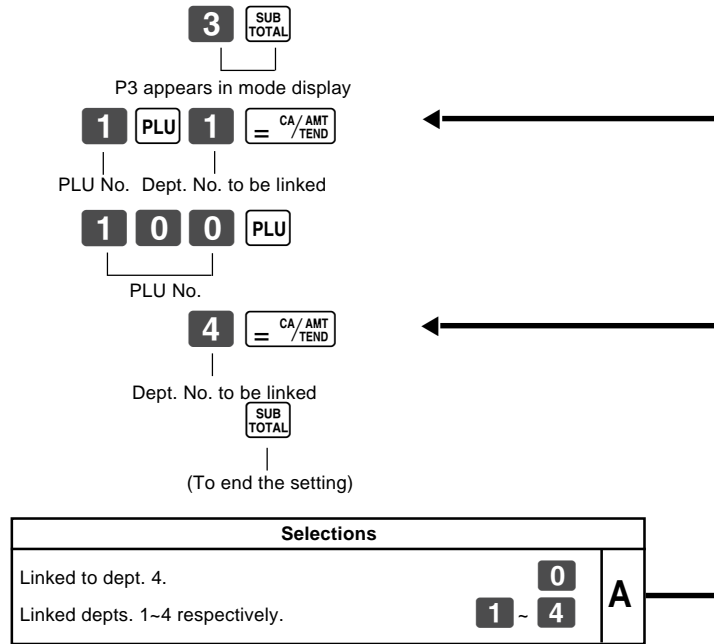

- 100 PLUs can be set.
- When the linked department is not specified, the PLU is linked to department 4.
- Status for a single-item sale and tax status are followed the specified linked department.

1-8-2 Unit Prices for PLUs

Example

| | | |
|------------|--------|--------|
| PLU No. | 1 | 2 |
| Unit Price | \$1.00 | \$3.00 |

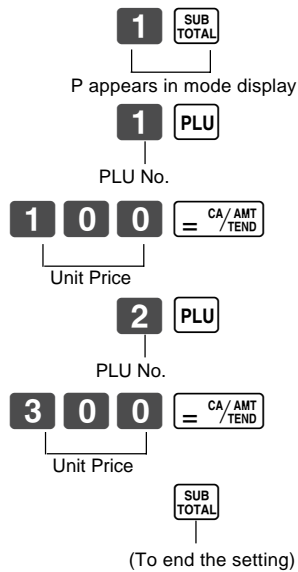

- Unit prices within the range of \$0.01~999.99.

1-9 Setting the Tax Rate and rounding

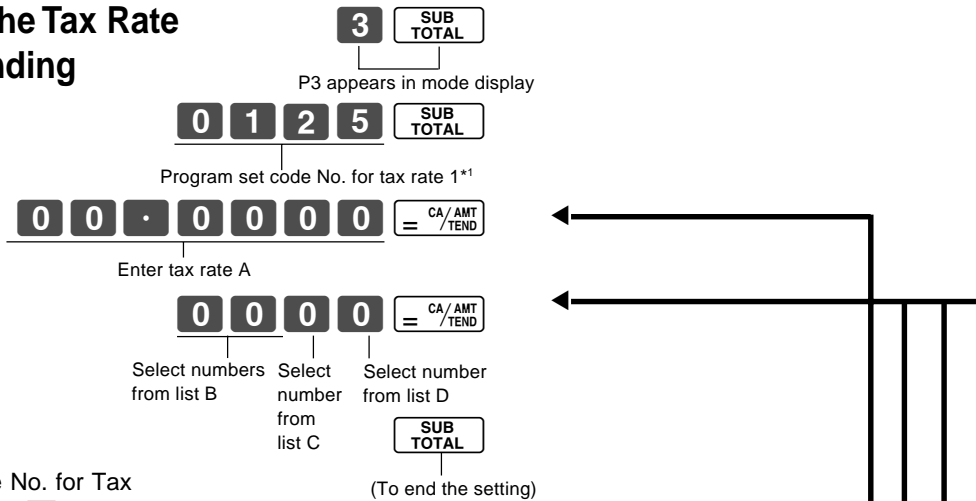

*1 Program set code No. for Tax rate 2 is 0 2 2 5 .

- You can use either an add-on rate tax or an add-in rate tax (VAT), depending on the requirements in your area. You can specify only one tax rate.
- The normal rounding specification tells the cash register how to round tax amounts to the proper number of decimal places.
- The special rounding specification and Denmark rounding tell the cash register how to round off subtotals and totals so that their rightmost 2 digits are 00, 25, 50 and 75.
- Note that the rounding specification you program for your cash register depends on the tax laws of your country.

| Tax rate specifications | |
|---|------------|
| The tax rate within the range of 0.0001 ~ 99.9999%. Use . key for decimal point. | A |
| Normal rounding specifications | |
| Cut off to 2 decimal places. (1.544=1.54; 1.545=1.54) | 0 0 |
| Round off to 2 decimal places. (1.544=1.54; 1.545=1.55) | 5 0 |
| Round up to 2 decimal places. (1.544=1.55; 1.545=1.55) | 9 0 |
| B | |
| Special rounding specifications for subtotal and total amounts | |
| No specifications | 0 |
| Special rounding 1 0 ~ 2 → 0; 3 ~ 7 → 5; 8 ~ 9 → 10 Examples: 1.21=1.20; 1.26=1.25; 1.28=1.30 | 1 |
| Special rounding 2 0 ~ 4 → 0; 5 ~ 9 → 10 Examples: 1.123=1.120; 1.525=1.530 | 2 |
| Denmark rounding (set the amount tender restriction on page 18 also) 00 ~ 12 → 0; 13 ~ 37 → 25; 38 ~ 62 → 50; 63 ~ 87 → 75; 88 ~ 100 → 100 Examples: 1.11=1.00; 1.28=1.25; 1.39=1.50; 1.80=1.75; 1.99=2.00 | 3 |
| C | |
| Scandinavian rounding | 6 |
| 00 ~ 24 → 0; 25 ~ 74 → 50; 75 ~ 99 → 100 Examples: 1.21=1.0; 1.30=1.50; 1.87=2.00 | |
| Australian rounding (only for tax rate 1) | 7 |
| 0 ~ 2 → 0; 3 ~ 7 → 5; 8 ~ 9 → 10 Examples: 1.21=1.20; 1.26=1.25; 1.28=1.30 | |
| Tax system specifications for subtotal and total amounts | |
| No specifications. | 0 |
| Specifies add-on rate tax. | 2 |
| Specifies add-in rate tax (VAT). | 3 |
| D | |

1-10 To control Tax Status printing

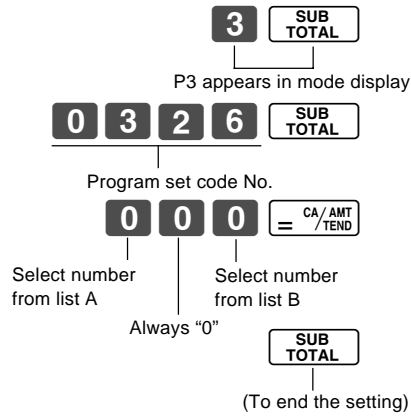
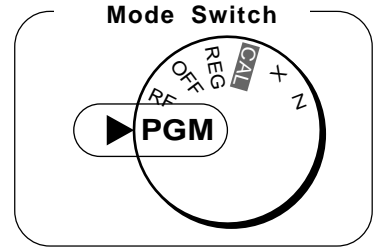

| | | Selections | |
|--|-----|------------|---|
| Print tax total line (only for Australia). | | | |
| Print tax symbol (only for Australia). | | | |
| Yes | No | 0 | A |
| | Yes | 1 | |
| No | No | 2 | |
| | Yes | 3 | |

| | | Selections | |
|---|-----|------------|---|
| Print taxable amount. | | | |
| Print taxable amount and tax amount for Add-in. | | | |
| Yes | Yes | 0 | B |
| | No | 1 | |
| No | Yes | 2 | |
| | No | 3 | |

Part-2

1-11 Printing to read All Pre-set Data

- Printing preset data.

1-11-1 Printing preset data except PLU settings

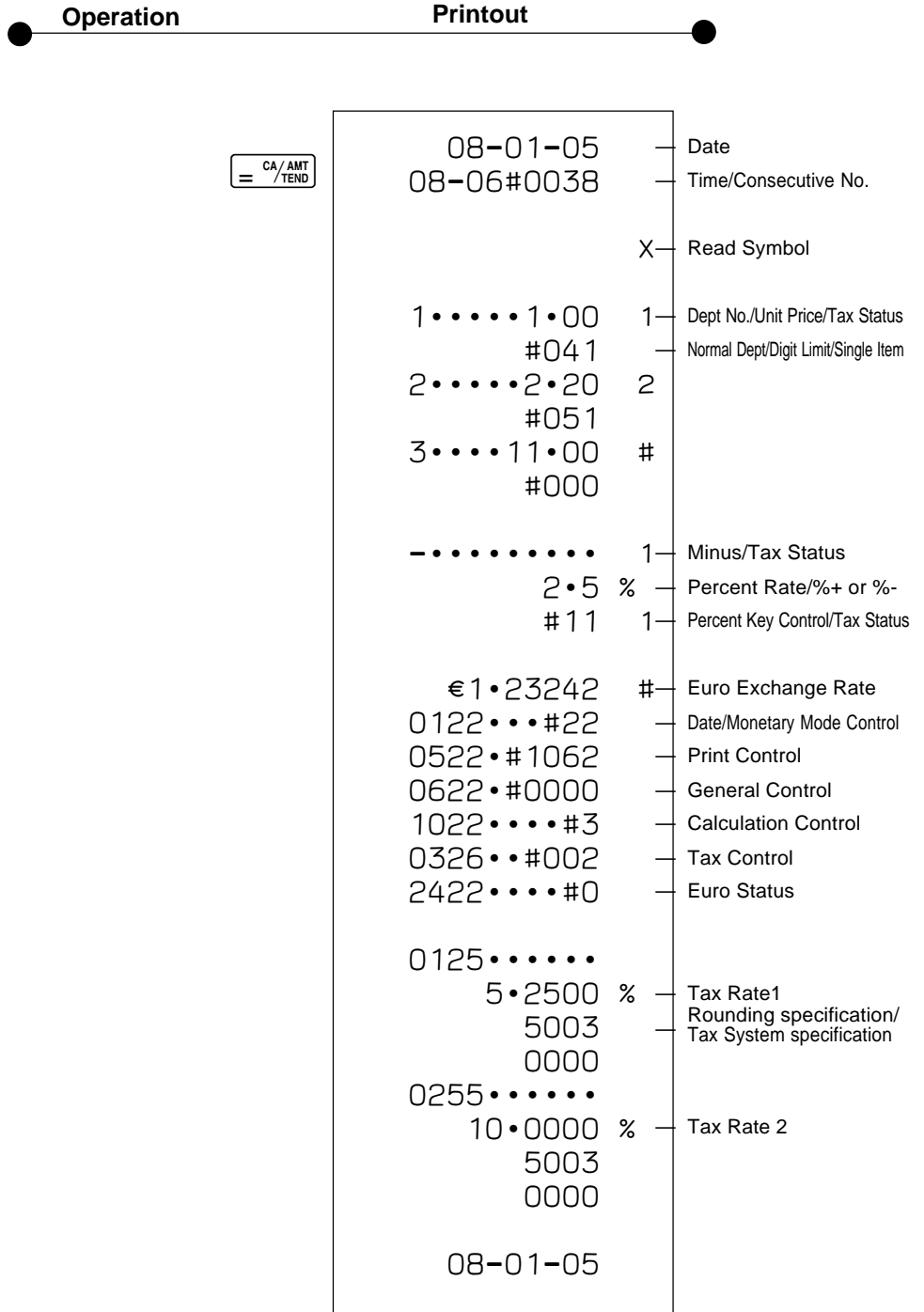

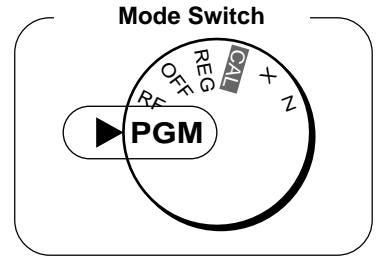

1-11-2 Printing preset PLU settings



1 = CA/AMT / TEND

| | | |
|-------------|---|--|
| 08-01-05 | — | Date |
| 08-10#0039 | — | Time/Consecutive No. |
| | X | Read symbol |
| 001...1.00 | 1 | PLU No./Unit Price/ Linked department |
| 002...2.20 | 2 | |
| 003...3.00 | 3 | |
| 004...4.00 | 4 | |
| 005...5.20 | 1 | |
| 006...6.00 | 2 | |
| 007...7.00 | 3 | |
| 099...8.00 | 4 | |
| 100...10.00 | 3 | |
| 08-01-05 | | |

Part-2



2. Various Operations

2-1 Registration using preset price for Departments.

(Programming: See page 19)

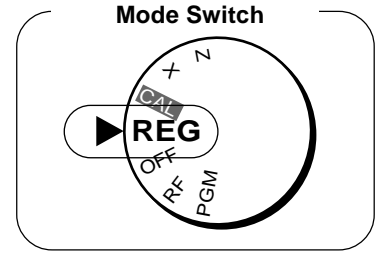

Example

| | | | |
|-----------------|---------|--------|---------|
| Unit Price | \$1.00 | \$2.20 | \$11.00 |
| Quantity | 1 | 2 | 4 |
| Depts. | 1 | 2 | 3 |
| Amount tendered | \$50.00 | | |

| ● | Operation | ● | Printout | | | | | | | | | | | | | | | | | | | | | | | | | | | |
|---------|--|---------------------------------------|--|--------|---|---------------------------------------|--------|---|---------------------------------------|--------|---|--------|---|---|-----------------------|---------|---|---------------------------------------|---------|---|--|---------|----|--|---------|----|----------------------|--------|----|--------|
| | + 1 - 2 - 2 4 \times DATE TIME \times 3 SUB TOTAL 5 0 0 0 = CA/AMT/TEND | | <table style="width: 100%; border-collapse: collapse;"> <tr> <td style="text-align: right;">• 1•00</td> <td style="text-align: right;">1</td> <td>Unit Price Programmed to Department 1</td> </tr> <tr> <td style="text-align: right;">• 2•20</td> <td style="text-align: right;">2</td> <td>Unit Price Programmed to Department 2</td> </tr> <tr> <td style="text-align: right;">• 2•20</td> <td style="text-align: right;">2</td> <td>Repeat</td> </tr> <tr> <td style="text-align: right;">4</td> <td style="text-align: right;">X</td> <td>Multiplication Symbol</td> </tr> <tr> <td style="text-align: right;">• 11•00</td> <td style="text-align: right;">@</td> <td>Unit Price Programmed to Department 3</td> </tr> <tr> <td style="text-align: right;">• 44•00</td> <td style="text-align: right;">3</td> <td></td> </tr> <tr> <td style="text-align: right;">• 49•40</td> <td style="text-align: right;">ST</td> <td></td> </tr> <tr> <td style="text-align: right;">• 50•00</td> <td style="text-align: right;">CA</td> <td>Cash Amount Tendered</td> </tr> <tr> <td style="text-align: right;">• 0•60</td> <td style="text-align: right;">CG</td> <td>Change</td> </tr> </table> | • 1•00 | 1 | Unit Price Programmed to Department 1 | • 2•20 | 2 | Unit Price Programmed to Department 2 | • 2•20 | 2 | Repeat | 4 | X | Multiplication Symbol | • 11•00 | @ | Unit Price Programmed to Department 3 | • 44•00 | 3 | | • 49•40 | ST | | • 50•00 | CA | Cash Amount Tendered | • 0•60 | CG | Change |
| • 1•00 | 1 | Unit Price Programmed to Department 1 | | | | | | | | | | | | | | | | | | | | | | | | | | | | |
| • 2•20 | 2 | Unit Price Programmed to Department 2 | | | | | | | | | | | | | | | | | | | | | | | | | | | | |
| • 2•20 | 2 | Repeat | | | | | | | | | | | | | | | | | | | | | | | | | | | | |
| 4 | X | Multiplication Symbol | | | | | | | | | | | | | | | | | | | | | | | | | | | | |
| • 11•00 | @ | Unit Price Programmed to Department 3 | | | | | | | | | | | | | | | | | | | | | | | | | | | | |
| • 44•00 | 3 | | | | | | | | | | | | | | | | | | | | | | | | | | | | | |
| • 49•40 | ST | | | | | | | | | | | | | | | | | | | | | | | | | | | | | |
| • 50•00 | CA | Cash Amount Tendered | | | | | | | | | | | | | | | | | | | | | | | | | | | | |
| • 0•60 | CG | Change | | | | | | | | | | | | | | | | | | | | | | | | | | | | |

2-2 Single-Item Sales

(Programming: See page 20)

Example 1:

| | | |
|------------|------------------|--|
| Status | Single item sale | |
| Unit Price | \$0.50 | |
| Quantity | 1 | |
| Dept. | 1 | |

| | | | | | | | |
|---------|---|------------|---|--|--------|----|------------|
| 5 0 + 1 | <table style="width: 100%; border-collapse: collapse;"> <tr> <td style="text-align: right;">• 0•50</td> <td style="text-align: right;">1</td> <td></td> </tr> <tr> <td style="text-align: right;">• 0•50</td> <td style="text-align: right;">CA</td> <td>Cash Sales</td> </tr> </table> | • 0•50 | 1 | | • 0•50 | CA | Cash Sales |
| • 0•50 | 1 | | | | | | |
| • 0•50 | CA | Cash Sales | | | | | |

For this example, Dept. 1 is programmed for a single-item-sale. (Programming: See page 16.)

Example 2:

| | | |
|------------|--------|------------------|
| Status | Normal | Single item sale |
| Unit Price | \$1.00 | \$0.50 |
| Quantity | 1 | 1 |
| Dept. | 2 | 1 |

| | | | | | | | | | | |
|--|---|------------|---|--|--------|---|--|--------|----|------------|
| 1 0 0 - 2 5 0 + 1 SUB TOTAL = CA/AMT/TEND | <table style="width: 100%; border-collapse: collapse;"> <tr> <td style="text-align: right;">• 1•00</td> <td style="text-align: right;">2</td> <td></td> </tr> <tr> <td style="text-align: right;">• 0•50</td> <td style="text-align: right;">1</td> <td></td> </tr> <tr> <td style="text-align: right;">• 1•50</td> <td style="text-align: right;">CA</td> <td>Cash Sales</td> </tr> </table> | • 1•00 | 2 | | • 0•50 | 1 | | • 1•50 | CA | Cash Sales |
| • 1•00 | 2 | | | | | | | | | |
| • 0•50 | 1 | | | | | | | | | |
| • 1•50 | CA | Cash Sales | | | | | | | | |

Single-item sale cannot be finalized if an item is registered previously.

2-3 Check sales

Example:

| | |
|------------|---------|
| Unit Price | \$35.00 |
| Quantity | 2 |
| Dept. | 4 |

Operation **Printout**

3 5 0 0 + 4
+ 4
SUB TOTAL
CHK

•35•00 4
 •35•00 4
 •70•00 CK — Check Sales

2-4 Split cash/ check sales

Example:

| | | |
|----------------------|---------|---------|
| Unit Price | \$30.00 | \$25.00 |
| Quantity | 1 | 1 |
| Depts. | 2 | 3 |
| Cash amount tendered | \$20.00 | |
| Check | \$35.00 | |

3 0 0 0 - 2
2 5 0 0 × 3
SUB TOTAL
2 0 0 0 = CA/AMT/TEND
CHK

•30•00 2
 •25•00 3
 •55•00 ST
 •20•00 CA
 •35•00 CK

Part-2

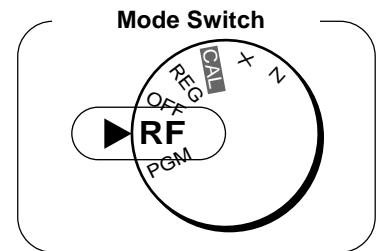

2-5 Refund

Example

| | | |
|------------|--------|--------|
| Unit Price | \$1.00 | \$2.00 |
| Quantity | 1 | 1 |
| Dept. | 2 | 3 |

Operation **Printout**

1 0 0 - 2
2 0 0 × 3
SUB TOTAL
= CA/AMT/TEND

13-55#0074 RF — Refund Mode Indicator
 •1•00 2
 •2•00 3
 •3•00 CA

After you finish RF mode operation, be sure to return the Mode Switch to the REG (register) setting.

2-6 PLU operation

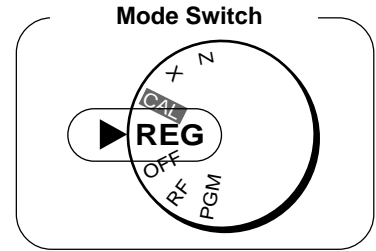

2-6-1 PLU registration

(Programming: See page 25)

Example

| | | |
|----------------------|---------|--------|
| PLU No. | 1 | 2 |
| Unit Price | \$1.00 | \$2.00 |
| Quantity | 2 | 4 |
| Link Dept. No. | 1 | 1 |
| Cash Amount tendered | \$10.00 | |

| | |
|--|--|
| Operation | Printout |
| <p>1 <input type="button" value="PLU"/></p> <p>4 <input type="button" value="X/DATE TIME"/></p> <p>2 <input type="button" value="PLU"/></p> <p><input type="button" value="CA/AMT TEND"/></p> | <pre> 001...1.00 001...1.00 4 X .2.00 @ 002...8.00 .10.00 CA </pre> <p>PLU No.</p> <p>Repeat</p> <p>Multiplication Symbol</p> <p>Preset Unit Price</p> <p>Cash Amount Tendered</p> |

2-6-2 PLU Single-Item Sale

(Programming: See page 25)

Example

| | |
|------------|------------------|
| PLU No. | 1 |
| Status | Single item sale |
| Unit Price | \$1.00 |
| Quantity | 1 |

| | |
|--|--|
| Operation | Printout |
| <p>1 <input type="button" value="PLU"/></p> | <pre> 001...1.00 .1.00 CA </pre> |

- For this example, linked department 1 is programmed for a single-item-sale. (Programming: See page 23)
- Single-item sale cannot be finalized if an item is registered previously.

2-6-3 PLU report

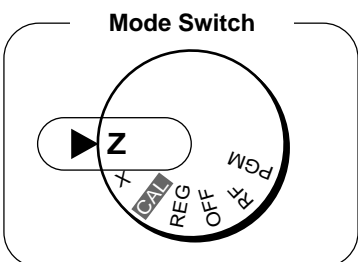
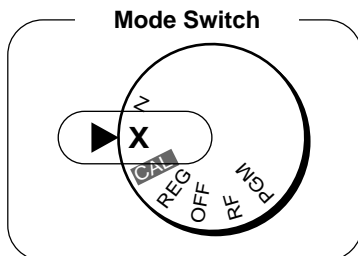

| | |
|---|--|
| Operation | Printout |
| <p>0 1 <input type="button" value="CA/AMT TEND"/></p> <p>(Read)</p> <p>0 1 <input type="button" value="CA/AMT TEND"/></p> <p>(Reset)</p> | <pre> 08-01-05 18-16#0238 #01#0001 Z 001.....12 .12.00 002.....27 ----- 100.....10 .180.00 ----- 1284 .10856.89 </pre> <p>Reset Counter</p> <p>PLU No./No. of items</p> <p>Amount</p> <p>PLU total count</p> <p>PLU total amount</p> |

2-7 Other registrations

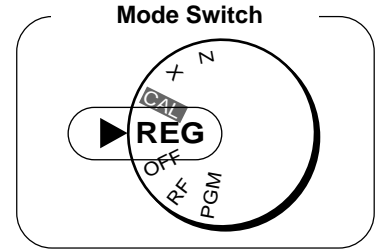

2-7-1 Reading the Time and Date

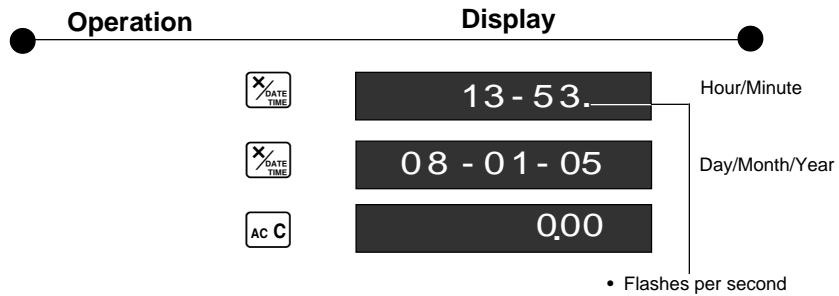

2-7-2 Paid out from cash in drawer

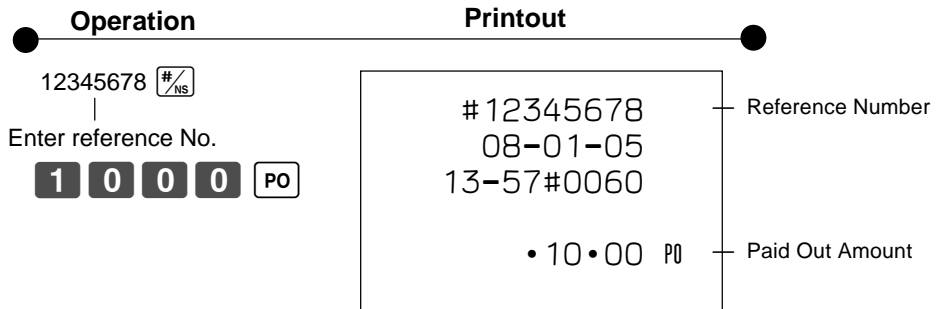

2-7-3 Cash received on account

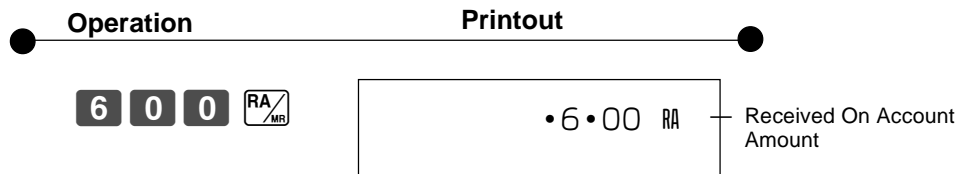

2-7-4 Registering identification numbers

A reference number or ID number of up to 8 digits can be registered prior to any transaction.

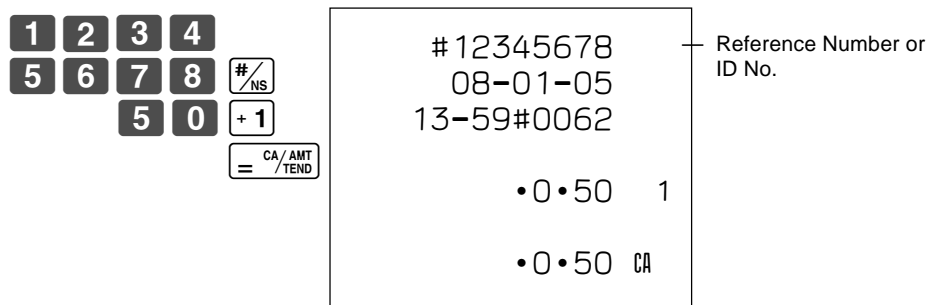

Part-2

2-7-5 Reduction on subtotal

Example:
Amount due reduced by \$0.50.

| Operation | Printout | | | | | | | | | | | | | | | | | | | | | | | | | | | | | | | | | | | | |
|--|----------|---|-----|-----|---|---|---|-----|-----------|--|--|--|---|---|---|--|-----------------|--|--|--|---|--|--|--|--|---|------|---|---|------|---|---|------|--|-----------|--|--|
| <table border="0" style="margin-left: 20px;"> <tr><td style="border: 1px solid black; padding: 2px;">1</td><td style="border: 1px solid black; padding: 2px;">0</td><td style="border: 1px solid black; padding: 2px;">0</td><td style="border: 1px solid black; padding: 2px;">+ 1</td></tr> <tr><td style="border: 1px solid black; padding: 2px;">2</td><td style="border: 1px solid black; padding: 2px;">0</td><td style="border: 1px solid black; padding: 2px;">0</td><td style="border: 1px solid black; padding: 2px;">+ 4</td></tr> <tr><td colspan="4" style="text-align: center; border: 1px solid black; padding: 2px;">SUB TOTAL</td></tr> <tr><td style="border: 1px solid black; padding: 2px;">5</td><td style="border: 1px solid black; padding: 2px;">0</td><td colspan="2" style="border: 1px solid black; padding: 2px;">-</td></tr> <tr><td colspan="4" style="text-align: center; border: 1px solid black; padding: 2px;">CA / AMT / TEND</td></tr> <tr><td colspan="4" style="text-align: center; border: 1px solid black; padding: 2px;">=</td></tr> </table> | 1 | 0 | 0 | + 1 | 2 | 0 | 0 | + 4 | SUB TOTAL | | | | 5 | 0 | - | | CA / AMT / TEND | | | | = | | | | <table style="width: 100%; border-collapse: collapse;"> <tr><td style="width: 15px;">•</td><td style="width: 40px;">1.00</td><td style="width: 10px;">1</td></tr> <tr><td>•</td><td>2.00</td><td>4</td></tr> <tr><td>•</td><td>0.50</td><td></td></tr> <tr><td colspan="3" style="padding-top: 10px;">• 2.50 CA</td></tr> </table> | • | 1.00 | 1 | • | 2.00 | 4 | • | 0.50 | | • 2.50 CA | | |
| 1 | 0 | 0 | + 1 | | | | | | | | | | | | | | | | | | | | | | | | | | | | | | | | | | |
| 2 | 0 | 0 | + 4 | | | | | | | | | | | | | | | | | | | | | | | | | | | | | | | | | | |
| SUB TOTAL | | | | | | | | | | | | | | | | | | | | | | | | | | | | | | | | | | | | | |
| 5 | 0 | - | | | | | | | | | | | | | | | | | | | | | | | | | | | | | | | | | | | |
| CA / AMT / TEND | | | | | | | | | | | | | | | | | | | | | | | | | | | | | | | | | | | | | |
| = | | | | | | | | | | | | | | | | | | | | | | | | | | | | | | | | | | | | | |
| • | 1.00 | 1 | | | | | | | | | | | | | | | | | | | | | | | | | | | | | | | | | | | |
| • | 2.00 | 4 | | | | | | | | | | | | | | | | | | | | | | | | | | | | | | | | | | | |
| • | 0.50 | | | | | | | | | | | | | | | | | | | | | | | | | | | | | | | | | | | | |
| • 2.50 CA | | | | | | | | | | | | | | | | | | | | | | | | | | | | | | | | | | | | | |

2-7-6 Premium/Discount

- 2.5% premium/discount (programmed to [%] key) applied to first item.

- 7% premium/discount applied to transaction total.
- For programming the [%] key as percent minus or percent plus, see page 21.
- For programming percent rate, see page 20.

| Operation | Premium | Discount | | | | | | | | | | | | | | | | | | | | | | | | | | | | | | | | | | | | | | | | | | | | | | | | | | | | | | | | | | | | | | | | | | | | | | | | | | | | | | | | | | | | | | | | | | | | | | | | | | | | | | | | | | | | | | | | | | | | | | | | | | | | | | | | | | | | |
|--|---------|----------|-----|------|----|---|---|---|-------------------------|---|---|-----|---|---|---|-----|-----------|--|--|--|---|---|--|--|-----------------|--|--|--|---|--|--|--|---|---|------|---|---|------|---|---|---|---|-----------------------|--|-----|---|--|-----|----|--|--|--|-------------------------|---|------|--|---|------|--|--|--|--|--|---|------|---|---|------|---|--|--|--|--|---|------|---|---|------|---|--|--|--|--|---|------|----|---|------|----|--|--|--|----------|--|---|---|--|---|----|--|--|--|-----------------------|---|------|--|---|------|--|--|--|--|-------------------------|-----------|--|--|--|--|--|--|--|--|--|-----------|--|--|--|--|--|--|--|--|--|--|
| <table border="0" style="margin-left: 20px;"> <tr><td style="border: 1px solid black; padding: 2px;">1</td><td style="border: 1px solid black; padding: 2px;">0</td><td style="border: 1px solid black; padding: 2px;">0</td><td style="border: 1px solid black; padding: 2px;">+ 1</td></tr> <tr><td colspan="4" style="text-align: center; border: 1px solid black; padding: 2px;">%</td></tr> <tr><td style="border: 1px solid black; padding: 2px;">2</td><td style="border: 1px solid black; padding: 2px;">0</td><td style="border: 1px solid black; padding: 2px;">0</td><td style="border: 1px solid black; padding: 2px;">- 2</td></tr> <tr><td style="border: 1px solid black; padding: 2px;">3</td><td style="border: 1px solid black; padding: 2px;">0</td><td style="border: 1px solid black; padding: 2px;">0</td><td style="border: 1px solid black; padding: 2px;">+ 1</td></tr> <tr><td colspan="4" style="text-align: center; border: 1px solid black; padding: 2px;">SUB TOTAL</td></tr> <tr><td style="border: 1px solid black; padding: 2px;">7</td><td colspan="3" style="border: 1px solid black; padding: 2px;">%</td></tr> <tr><td colspan="4" style="text-align: center; border: 1px solid black; padding: 2px;">CA / AMT / TEND</td></tr> <tr><td colspan="4" style="text-align: center; border: 1px solid black; padding: 2px;">=</td></tr> </table> | 1 | 0 | 0 | + 1 | % | | | | 2 | 0 | 0 | - 2 | 3 | 0 | 0 | + 1 | SUB TOTAL | | | | 7 | % | | | CA / AMT / TEND | | | | = | | | | <table style="width: 100%; border-collapse: collapse;"> <tr><td style="width: 15px;">•</td><td style="width: 40px;">1.00</td><td style="width: 10px;">1</td><td style="width: 10px;">•</td><td style="width: 40px;">1.00</td><td style="width: 10px;">1</td><td style="width: 10px;">-</td><td style="width: 10px;">1</td><td style="width: 10px;">-</td><td style="width: 10px;">Premium/Discount Rate</td></tr> <tr><td></td><td>2.5</td><td>%</td><td></td><td>2.5</td><td>%-</td><td></td><td></td><td></td><td>Premium/Discount Amount</td></tr> <tr><td>•</td><td>0.03</td><td></td><td>•</td><td>0.03</td><td></td><td></td><td></td><td></td><td></td></tr> <tr><td>•</td><td>2.00</td><td>2</td><td>•</td><td>2.00</td><td>2</td><td></td><td></td><td></td><td></td></tr> <tr><td>•</td><td>3.00</td><td>1</td><td>•</td><td>3.00</td><td>1</td><td></td><td></td><td></td><td></td></tr> <tr><td>•</td><td>6.03</td><td>ST</td><td>•</td><td>5.97</td><td>ST</td><td></td><td></td><td></td><td>Subtotal</td></tr> <tr><td></td><td>7</td><td>%</td><td></td><td>7</td><td>%-</td><td></td><td></td><td></td><td>Premium/Discount Rate</td></tr> <tr><td>•</td><td>0.42</td><td></td><td>•</td><td>0.42</td><td></td><td></td><td></td><td></td><td>Premium/Discount Amount</td></tr> <tr><td colspan="10" style="padding-top: 10px;">• 6.45 CA</td></tr> <tr><td colspan="10" style="padding-top: 10px;">• 5.55 CA</td></tr> </table> | • | 1.00 | 1 | • | 1.00 | 1 | - | 1 | - | Premium/Discount Rate | | 2.5 | % | | 2.5 | %- | | | | Premium/Discount Amount | • | 0.03 | | • | 0.03 | | | | | | • | 2.00 | 2 | • | 2.00 | 2 | | | | | • | 3.00 | 1 | • | 3.00 | 1 | | | | | • | 6.03 | ST | • | 5.97 | ST | | | | Subtotal | | 7 | % | | 7 | %- | | | | Premium/Discount Rate | • | 0.42 | | • | 0.42 | | | | | Premium/Discount Amount | • 6.45 CA | | | | | | | | | | • 5.55 CA | | | | | | | | | | |
| 1 | 0 | 0 | + 1 | | | | | | | | | | | | | | | | | | | | | | | | | | | | | | | | | | | | | | | | | | | | | | | | | | | | | | | | | | | | | | | | | | | | | | | | | | | | | | | | | | | | | | | | | | | | | | | | | | | | | | | | | | | | | | | | | | | | | | | | | | | | | | | | | | | |
| % | | | | | | | | | | | | | | | | | | | | | | | | | | | | | | | | | | | | | | | | | | | | | | | | | | | | | | | | | | | | | | | | | | | | | | | | | | | | | | | | | | | | | | | | | | | | | | | | | | | | | | | | | | | | | | | | | | | | | | | | | | | | | | | | | | | | | | |
| 2 | 0 | 0 | - 2 | | | | | | | | | | | | | | | | | | | | | | | | | | | | | | | | | | | | | | | | | | | | | | | | | | | | | | | | | | | | | | | | | | | | | | | | | | | | | | | | | | | | | | | | | | | | | | | | | | | | | | | | | | | | | | | | | | | | | | | | | | | | | | | | | | | |
| 3 | 0 | 0 | + 1 | | | | | | | | | | | | | | | | | | | | | | | | | | | | | | | | | | | | | | | | | | | | | | | | | | | | | | | | | | | | | | | | | | | | | | | | | | | | | | | | | | | | | | | | | | | | | | | | | | | | | | | | | | | | | | | | | | | | | | | | | | | | | | | | | | | |
| SUB TOTAL | | | | | | | | | | | | | | | | | | | | | | | | | | | | | | | | | | | | | | | | | | | | | | | | | | | | | | | | | | | | | | | | | | | | | | | | | | | | | | | | | | | | | | | | | | | | | | | | | | | | | | | | | | | | | | | | | | | | | | | | | | | | | | | | | | | | | | |
| 7 | % | | | | | | | | | | | | | | | | | | | | | | | | | | | | | | | | | | | | | | | | | | | | | | | | | | | | | | | | | | | | | | | | | | | | | | | | | | | | | | | | | | | | | | | | | | | | | | | | | | | | | | | | | | | | | | | | | | | | | | | | | | | | | | | | | | | | | |
| CA / AMT / TEND | | | | | | | | | | | | | | | | | | | | | | | | | | | | | | | | | | | | | | | | | | | | | | | | | | | | | | | | | | | | | | | | | | | | | | | | | | | | | | | | | | | | | | | | | | | | | | | | | | | | | | | | | | | | | | | | | | | | | | | | | | | | | | | | | | | | | | |
| = | | | | | | | | | | | | | | | | | | | | | | | | | | | | | | | | | | | | | | | | | | | | | | | | | | | | | | | | | | | | | | | | | | | | | | | | | | | | | | | | | | | | | | | | | | | | | | | | | | | | | | | | | | | | | | | | | | | | | | | | | | | | | | | | | | | | | | |
| • | 1.00 | 1 | • | 1.00 | 1 | - | 1 | - | Premium/Discount Rate | | | | | | | | | | | | | | | | | | | | | | | | | | | | | | | | | | | | | | | | | | | | | | | | | | | | | | | | | | | | | | | | | | | | | | | | | | | | | | | | | | | | | | | | | | | | | | | | | | | | | | | | | | | | | | | | | | | | | | | | | | | | | |
| | 2.5 | % | | 2.5 | %- | | | | Premium/Discount Amount | | | | | | | | | | | | | | | | | | | | | | | | | | | | | | | | | | | | | | | | | | | | | | | | | | | | | | | | | | | | | | | | | | | | | | | | | | | | | | | | | | | | | | | | | | | | | | | | | | | | | | | | | | | | | | | | | | | | | | | | | | | | | |
| • | 0.03 | | • | 0.03 | | | | | | | | | | | | | | | | | | | | | | | | | | | | | | | | | | | | | | | | | | | | | | | | | | | | | | | | | | | | | | | | | | | | | | | | | | | | | | | | | | | | | | | | | | | | | | | | | | | | | | | | | | | | | | | | | | | | | | | | | | | | | | | | | | |
| • | 2.00 | 2 | • | 2.00 | 2 | | | | | | | | | | | | | | | | | | | | | | | | | | | | | | | | | | | | | | | | | | | | | | | | | | | | | | | | | | | | | | | | | | | | | | | | | | | | | | | | | | | | | | | | | | | | | | | | | | | | | | | | | | | | | | | | | | | | | | | | | | | | | | | | | |
| • | 3.00 | 1 | • | 3.00 | 1 | | | | | | | | | | | | | | | | | | | | | | | | | | | | | | | | | | | | | | | | | | | | | | | | | | | | | | | | | | | | | | | | | | | | | | | | | | | | | | | | | | | | | | | | | | | | | | | | | | | | | | | | | | | | | | | | | | | | | | | | | | | | | | | | | |
| • | 6.03 | ST | • | 5.97 | ST | | | | Subtotal | | | | | | | | | | | | | | | | | | | | | | | | | | | | | | | | | | | | | | | | | | | | | | | | | | | | | | | | | | | | | | | | | | | | | | | | | | | | | | | | | | | | | | | | | | | | | | | | | | | | | | | | | | | | | | | | | | | | | | | | | | | | | |
| | 7 | % | | 7 | %- | | | | Premium/Discount Rate | | | | | | | | | | | | | | | | | | | | | | | | | | | | | | | | | | | | | | | | | | | | | | | | | | | | | | | | | | | | | | | | | | | | | | | | | | | | | | | | | | | | | | | | | | | | | | | | | | | | | | | | | | | | | | | | | | | | | | | | | | | | | |
| • | 0.42 | | • | 0.42 | | | | | Premium/Discount Amount | | | | | | | | | | | | | | | | | | | | | | | | | | | | | | | | | | | | | | | | | | | | | | | | | | | | | | | | | | | | | | | | | | | | | | | | | | | | | | | | | | | | | | | | | | | | | | | | | | | | | | | | | | | | | | | | | | | | | | | | | | | | | |
| • 6.45 CA | | | | | | | | | | | | | | | | | | | | | | | | | | | | | | | | | | | | | | | | | | | | | | | | | | | | | | | | | | | | | | | | | | | | | | | | | | | | | | | | | | | | | | | | | | | | | | | | | | | | | | | | | | | | | | | | | | | | | | | | | | | | | | | | | | | | | | |
| • 5.55 CA | | | | | | | | | | | | | | | | | | | | | | | | | | | | | | | | | | | | | | | | | | | | | | | | | | | | | | | | | | | | | | | | | | | | | | | | | | | | | | | | | | | | | | | | | | | | | | | | | | | | | | | | | | | | | | | | | | | | | | | | | | | | | | | | | | | | | | |

2-8 About the daylight saving time

It is possible to set the internal clock forward/backward by 1~9 hour(s) for the daylight saving time.

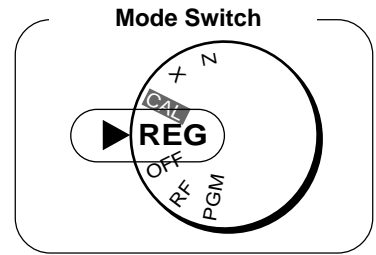

| | Operation | Display | |
|----------------------|-------------|--------------------|-------------------------|
| • Forward by 1 hour | | 12 - 34 | |
| | * 1 | 12 - 34 (blinking) | |
| | | 13 - 34 | Set forward by 1 hour. |
| | AC C | 0.00 | |
| • Backward by 1 hour | | 12 - 34 | |
| | - 2 | 12 - 34 (blinking) | |
| | * 1 | 12 - 34 (blinking) | |
| | | 11 - 34 | Set backward by 1 hour. |
| | AC C | 0.00 | |

*Put **2** ~ **9**, in case of set the clock by 2~9 hours.

Part-2

Part 3

CALCULATOR FUNCTION

1. Calculator Mode

While registering at REG mode, you can switch to CAL mode and then return to REG mode to resume the registration.

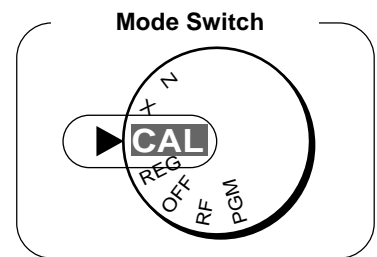

1-1 Calculation examples

| Operation | Display |
|--|--|
| $5 + 3 - 2 =$ $(23 - 56) \times 78 =$ $(4 \times 3 - 6) \div 3.5 + 8 =$ 12% on 1500 | <div style="border: 1px solid black; padding: 2px; text-align: center;">C 0</div> <div style="border: 1px solid black; padding: 2px; text-align: center;">6.</div> <div style="border: 1px solid black; padding: 2px; text-align: center;">-2574.</div> <div style="border: 1px solid black; padding: 2px; text-align: center;">9.7142857</div> <div style="border: 1px solid black; padding: 2px; text-align: center;">180.</div> |

1-2 Memory recall

Recalls the current amount onto the display.

- during registration: current subtotal
- registration has been completed: the last amount

On CAL mode

Example:
Divide the current subtotal \$30.00 at REG mode by 3 (to divide the bill between 3 people).

| Operation | Display |
|---------------------------------------|---------|
| $\text{MR} \div 3 =$ Memory recall | 10. |

On REG mode

Recalls the current result by pressing $\text{MR} =$ key at CAL mode on the display.

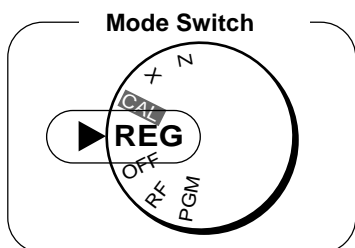

Example:
Recall the current result at CAL mode during registration, and register the cash amount due for each person.

| Operation | Printout |
|--|---|
| $\text{MR} =$ $\text{MR} =$ $\text{MR} =$ Memory recall | • 10.00 1 • 20.00 2 • 30.00 ST • 10.00 CA • 10.00 CA • 10.00 CA • 0.00 CG |

1-3 Setting for calculator operation

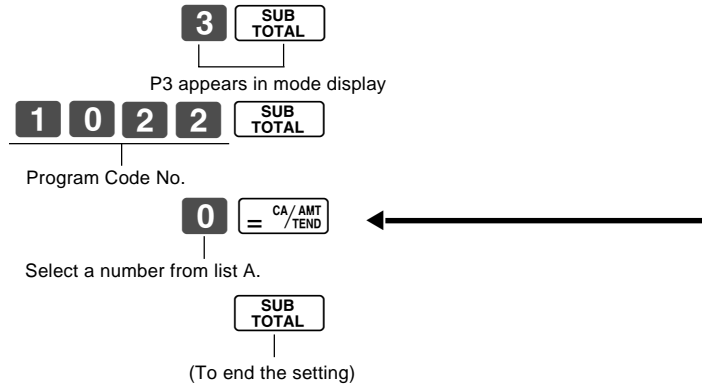
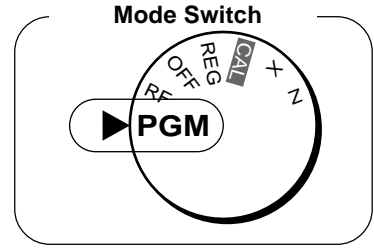

| | | | Selections | |
|---|-----|-----|------------|---|
| Open drawer whenever [= CA/AMT /TEND] is pressed.* | | | No | 0 |
| Open drawer whenever [%] is pressed. | | | Yes | 1 |
| Print No. of Equal key operations on General Control X and Z reports. | Yes | No | 2 | A |
| | | Yes | 3 | |
| No | No | No | 4 | |
| | | Yes | 5 | |
| | Yes | No | 6 | |
| | | Yes | 7 | |

* Drawer does not open during registration procedures even if you press [= CA/AMT /TEND] by turning the mode switch to CAL position.

Part-3



USEFUL INFORMATION

1. Troubleshooting

| | Symptom/Problem | Most common causes | Solutions |
|---|--|---|--|
| 1 | E01 appears on the display. | Changing modes without completing transaction. | Return mode switch to where it stops buzzing and press  . |
| 2 | E94 appears on the display. | Printer paper is jammed. | Remove jammed paper. Turn Mode switch to OFF then turn to ON, or Turn power OFF and then turn power ON. |
| 3 | No date or time on receipt. Paper is not advancing enough. | Printer is programmed as a journal. | Program printer to print receipts. |
| 4 | Drawer opens up after ringing up only one time. | Department is programmed as a single item dept. | Program the dept. as a normal dept. |
| 5 | Not clearing totals at end of day after taking report. | Using X mode to take out reports. | Use Z mode to take out reports. |
| 6 | Programming is lost whenever register is unplugged or there is a power outage. | Bad or no batteries. | Put in new batteries. |
| 7 | Register is inoperative. Can't get money out of drawer. | No power. | Pull lever underneath register at rear. |

2. Specifications

INPUT METHOD

Entry: 10-key system; Buffer memory 8 keys (2-key roll over)
 Display (LED): Amount 8 digits (zero suppression); Department/PLU No.; No. of repeats

PRINTER

Receipt: 12 digits (Amount 10 digits, Symbol 2 digits)
 (or journal) Automatic paper roll winding (journal)
 Paper roll: 58 mm × 80 mm Ø (Max.)

CALCULATIONS

Entry 8 digits; Registration 7 digits; Total 8 digits

CALCULATOR FUNCTION

8 digits; Arithmetic calculations; Percent calculations

Memory protection batteries:

The effective service life of the memory protection batteries (3 UM-3, R6P (SUM-3) or LR6 (AM-3) type batteries) is approximately one year from installation into the machine.

Power source/Power consumption: See the rating plate.

Operating temperature: 0°C to 40°C (32°F to 104°F)

Humidity: 10 to 90%

Dimensions/Weight: 203 mm(H)× 330 mm(W)× 360 mm(D) with S drawer
 4.1 kg with S drawer
 250 mm(H)× 410 mm(W)× 450 mm(D) with M drawer
 9 kg with M drawer

Specifications and design are subject to change without notice.

When the cash drawer does not open!

In case of power failure or the machine is in malfunction, the cash drawer does not open automatically. Even in these cases, you can open the cash drawer by pulling drawer release lever (see below).

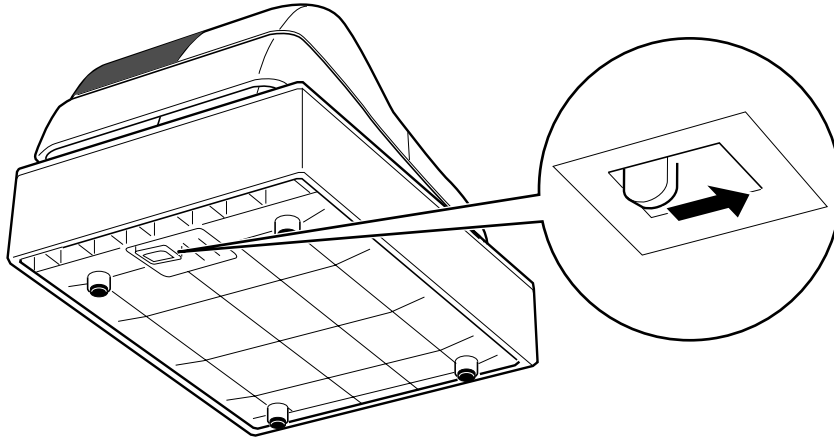

Important!

The drawer will not open, if it is locked with a drawer lock key.

To lock/unlock the multipurpose tray

(only for M size drawer)

- A. Turn the lever (1) clockwise to lock the tray (the indicator becomes red).
- B. Turn the lever (1) counterclockwise to unlock the tray (the indicator becomes green).

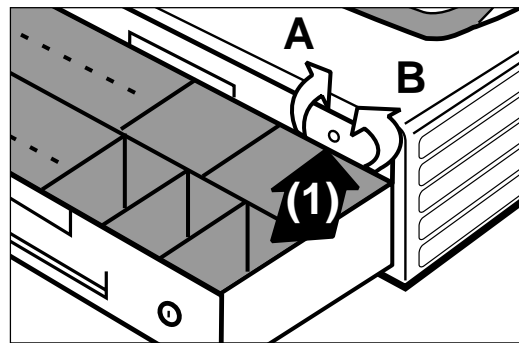

The main plug on this equipment must be used to disconnect mains power. Please ensure that the socket outlet is installed near the equipment and shall be easily accessible.



Casio Europe GmbH
Bornbarch 10, 22848 Norderstedt
Germany

Please keep all information for future reference.

CASIO®

CASIO COMPUTER CO., LTD.
6-2, Hon-machi 1-chome
Shibuya-ku, Tokyo 151-8543, Japan

MO0411-A

130CR*E
Printed in Indonesia
Printed on recycled paper.

Free Manuals Download Website

<http://myh66.com>

<http://usermanuals.us>

<http://www.somanuals.com>

<http://www.4manuals.cc>

<http://www.manual-lib.com>

<http://www.404manual.com>

<http://www.luxmanual.com>

<http://aubethermostatmanual.com>

Golf course search by state

<http://golfingnear.com>

Email search by domain

<http://emailbydomain.com>

Auto manuals search

<http://auto.somanuals.com>

TV manuals search

<http://tv.somanuals.com>