

CTK-1100

USER'S GUIDE GUÍA DEL USUARIO

Please keep all information for future reference.

Guarde toda información para tener como referencia futura.



GUIDELINES LAID DOWN BY FCC RULES FOR USE OF THE UNIT IN THE U.S.A. (not applicable to other areas).

NOTICE

This equipment has been tested and found to comply with the limits for a Class B digital device, pursuant to Part 15 of the FCC Rules. These limits are designed to provide reasonable protection against harmful interference in a residential installation. This equipment generates, uses and can radiate radio frequency energy and, if not installed and used in accordance with the instructions, may cause harmful interference to radio communications. However, there is no guarantee that interference will not occur in a particular installation. If this equipment does cause harmful interference to radio or television reception, which can be determined by turning the equipment off and on, the user is encouraged to try to correct the interference by one or more of the following measures:

- Reorient or relocate the receiving antenna.
- Increase the separation between the equipment and receiver.
- Connect the equipment into an outlet on a circuit different from that to which the receiver is connected.
- Consult the dealer or an experienced radio/TV technician for help.

FCC WARNING

Changes or modifications not expressly approved by the party responsible for compliance could void the user's authority to operate the equipment.

Important!

Please note the following important information before using this product.

- Before using the optional AD-E95100L Adaptor to power the unit, be sure to check the AC Adaptor for any damage first. Carefully check the power cord for breakage, cuts, exposed wire and other serious damage. Never let children use an AC adaptor that is seriously damaged.
- Never attempt to recharge batteries.
- Do not use rechargeable batteries.
- Never mix old batteries with new ones.
- Use recommended batteries or equivalent types.
- Always make sure that positive (+) and negative (–) poles are facing correctly as indicated near the battery compartment.
- Replace batteries as soon as possible after any sign they are getting weak.
- Do not short-circuit the battery terminals.
- The product is not intended for children under 3 years.
- Use only CASIO AD-E95100L adaptor.
- The AC adaptor is not a toy.
- Be sure to disconnect the AC adaptor before cleaning the product.



This mark applies in EU countries only.



Manufacturer:
CASIO COMPUTER CO.,LTD.
6-2, Hon-machi 1-chome, Shibuya-ku, Tokyo 151-8543, Japan
Responsible within the European Union:
CASIO EUROPE GmbH
Casio-Platz 1, 22848 Norderstedt, Germany

Safety Precautions

Before using the instrument, be sure to carefully read through the instructions contained in this manual.

Symbols

Various symbols are used in this user's guide and on the product itself to ensure that the product is used safely and correctly, and to prevent injury to the user and other persons as well as damage to property. Those symbols along with their meanings are shown below.

DANGER

This symbol indicates information that, if ignored or applied incorrectly, creates the danger of death or serious personal injury.

WARNING

This indication stipulates matters that have the risk of causing death or serious injury if the product is operated incorrectly while ignoring this indication.

CAUTION

This indication stipulates matters that have the risk of causing injury as well as matters for which there is the likelihood of occurrence of physical damage only if the product is operated incorrectly while ignoring this indication.

Symbol Examples



This triangle symbol (\triangle) means that the user should be careful. (The example at left indicates electrical shock caution.)



This circle with a line through it (\odot) means that the indicated action must not be performed. Indications within or nearby this symbol are specifically prohibited. (The example at left indicates that disassembly is prohibited.)



The black dot (\bullet) means that the indicated action must be performed. Indications within this symbol are actions that are specifically instructed to be performed. (The example at left indicates that the power plug must be unplugged from the electrical socket.)

DANGER

Alkaline Batteries

Perform the following steps immediately if fluid leaking from alkaline batteries ever gets into your eyes. 

1. Do not rub your eyes! Rinse them with water.
2. Contact your physician immediately. Leaving alkaline battery fluid in your eyes can lead to loss of sight.

WARNING

Smoke, Strange Odor, Overheating

Continued use of the product while it is emitting smoke, a strange odor, or heat creates the risk of fire and electric shock. Take the following steps immediately.

1. Turn off power.
2. If you are using the AC adaptor for power, unplug it from the wall outlet.
3. Contact your original retailer or an authorized CASIO Service Provider.

AC Adaptor

● Misuse of the AC adaptor creates the risk of fire and electric shock. Always make sure you observe the following precautions. 

- Be sure to use only the AC adaptor that is specified for this product.
- Use only a power source whose voltage is within the rating marked on the AC adaptor.
- Do not overload electrical outlets and extension cords. 

● Misuse of the AC adaptor's electric cord can damage or break it, creating the risk of fire and electric shock. Always make sure you observe the following precautions. 

- Never place heavy objects on the cord or subject it to heat.
- Never try to modify the cord or subject it to excessive bending.
- Never twist or stretch the cord.
- Should the electric cord or plug become damaged, contact your original retailer or authorized CASIO Service Provider. 

● Never touch the AC adaptor while your hands are wet. 

Doing so creates the risk of electric shock.

● Use the AC adaptor where it will not be splashed with water. Water creates the risk of fire and electric shock. 

● Do not place a vase or any other container filled with liquid on top of the AC adaptor. Water creates the risk of fire and electric shock. 

Batteries

Misuse of batteries can cause them to leak, resulting in damage to nearby objects, or to explode, creating the risk of fire and personal injury. Always make sure you observe the following precautions. 

- Never try to take batteries apart or allow them to become shorted.
- Never expose batteries to heat or dispose of them by incineration.
- Never mix old batteries with new ones.
- Never mix batteries of different types.
- Do not charge the batteries.
- Make sure the positive (+) and negative (-) ends of the batteries are facing correctly.

Do not incinerate the product.

Never throw the product into fire. 

Doing so can cause it to explode, creating the risk of fire and personal injury.

Water and Foreign Matter

Water, other liquids, and foreign matter (such as pieces of metal, pencils, etc.) getting into the product create the risk of fire and electric shock. Take the following steps immediately. 

1. Turn off power.
2. If you are using the AC adaptor for power, unplug it from the wall outlet.
3. Contact your original retailer or an authorized CASIO Service Provider.

Disassembly and Modification

Never try to take this product apart or modify it in any way. Doing so creates the risk of electric shock, burn injury, or other personal injury. Leave all internal inspection, adjustment, and maintenance up to your original retailer or authorized CASIO Service Provider. 



Dropping and Impact

Continued use of this product after it has been damaged by dropping or subjecting it to strong impact creates the risk of fire and electric shock. Take the following steps immediately.

1. Turn off power.
2. If you are using the AC adaptor for power, unplug it from the wall outlet.
3. Contact your original retailer or an authorized CASIO Service Provider.



Plastic Bags

Never place the plastic bag the product comes in over your head or in your mouth. Doing so creates the risk of suffocation. Particular care concerning this precaution is required where small children are present.



Keep off of the product and stand.*

Climbing onto the product or stand can cause it to tip over or become damaged. Particular care concerning this precaution is required where small children are present.



Location

Avoid locating the product on an unstable stand, on an uneven surface, or any other unstable location. An unstable location can cause the product to fall over, creating the risk of personal injury.



⚠ CAUTION

AC Adaptor

- Misuse of the AC adaptor creates the risk of fire and electric shock. Always make sure you observe the following precautions.
 - Do not locate the electric cord near a stove or other sources of heat.
 - Never pull on the cord when unplugging from the electrical outlet. Always grasp the AC adaptor when unplugging.
 - Insert the AC adaptor into the wall outlet as far as it will go.
 - Unplug the AC adaptor from the wall outlet during lightening storms or before leaving on a trip or other long-term absence.
 - At least once a year, unplug the AC adaptor from the wall outlet and wipe away any dust that is built up in the area around the prongs of the plug.
 - Never use detergent to clean the power cord, especially the plug and jack parts.



Relocating the Product

Before relocating the product, always unplug the AC adaptor from the wall outlet and disconnect all other cables and connecting cords. Leaving cords connected creates the risk of damage to the cords, fire, and electric shock.



Cleaning

Before cleaning the product, always unplug the AC adaptor from the wall outlet first. Leaving the AC adaptor plugged in creates the risk of damage to the AC adaptor, fire, and electric shock.



Batteries

Misuse of batteries can cause them to leak resulting in damage to nearby objects, or to explode, creating the risk of fire and personal injury. Always make sure you observe the following precautions.

- Use only batteries that are specified for use with this product.
- Remove batteries from the product if you do not plan to use it for a long time.

Connectors

Connect only the specified devices and equipment to the product's connectors. Connection of a non-specified device or equipment creates the risk of fire and electric shock.



Location

Avoid the following locations for this product. Such locations create the risk of fire and electric shock.



- Areas subject to high humidity or large amounts of dust.
- In food preparation areas or other areas subject to oil smoke.
- Near air conditioning equipment, on a heated carpet, in areas exposed to direct sunlight, inside of a vehicle parked in the sun, or any other area that subjects the product to high temperatures.

Display Screen

- Never push on the display screen's LCD panel or subject it to strong impact. Doing so can cause the LCD panel's glass to crack, creating the risk of personal injury.
- Should the LCD panel ever crack or break, never touch the liquid inside of the panel. LCD panel liquid can cause skin irritation.
- Should LCD panel liquid ever get inside your mouth, immediately wash out your mouth with water and contact your physician.
- Should LCD panel liquid ever get into your eyes or onto your skin, rinse with clear water for at least 15 minutes, and then contact a physician.



Sound Volume

Do not listen to music at very loud volumes for long periods. Particular care concerning this precaution is required when using headphones. High volume settings can damage your hearing.



Heavy Objects

Never place heavy object on top of the product.

Doing so can make the product top heavy, causing the product to tip over or the object to fall from it, creating the risk of personal injury.



Correct Stand* Assembly

An incorrectly assembled stand can tip over, causing the product to fall and creating the risk of personal injury.



Make sure you assemble the stand correctly, following the assembly instructions that come with it. Make sure you mount the product on the stand correctly.

* Stand is available as an option.

IMPORTANT!

When using batteries, be sure to replace them or shift to one of the alternate power sources whenever you notice any of the following symptoms.

- Instrument does not turn on
- Display that is flickering, dim, or difficult to read
- Abnormally low speaker/headphone volume
- Distortion of sound output
- Occasional interruption of sound when playing at high volume
- Sudden power failure when playing at high volume
- Flickering or dimming of the display when playing at high volume
- Continued sound output even after you release a key
- A tone that is totally different from the one that is selected
- Abnormal rhythm pattern and Song Bank play



Introduction

Congratulations upon your selection of this CASIO musical instrument. This keyboard provides you with the following features and functions.

100 tones

- Choose from among orchestral sounds, synthesized sounds, and more.

100 rhythms

- 100 versatile rhythms help to add plenty of life to all your keyboard performances.

Auto Accompaniment

- Simply play a chord and the corresponding rhythm, bass and chord parts play automatically.

100-tune Song Bank

- A wide selection of favorites including "ODE TO JOY" and "JINGLE BELLS" is yours for your listening enjoyment or play along fun. A simple operation cuts out the melody part or accompaniment part of the tune, allowing you to play along on the keyboard.



Contents

Safety Precautions E-1

Introduction E-5

General Guide E-8

Song Bank Quick

Reference E-10

Playing Back a Song Bank Tune E-10

Power Supply E-12

Using a Household Power Outlet E-12

Using Batteries E-12

Auto Power Off E-13

Settings E-13

Connections E-14

Phones/Output Terminal E-14

Accessories and Options E-14

Basic Operations E-15

Playing the Keyboard E-15

Selecting a Tone E-15

Auto Accompaniment E-17

Selecting a Rhythm E-17

Playing a Rhythm E-17

Adjusting the Tempo E-18

Using Auto Accompaniment E-18

Using a Fill-in Pattern E-21

Synchro Starting Accompaniment with
Rhythm Play E-21

Adjusting the Accompaniment Volume ... E-21

Using the Song Bank E-22

Playing Back a Song Bank Tune E-22

Song Bank Mode Display E-23

Adjusting the Tempo of a Song Bank
Tune E-24

Changing the Tone of a Song Bank
Tune's Melody E-24

Playing Along with a Song Bank Tune ... E-25

Applause Sound E-26

Playing Back All Song Bank Tunes in
Succession E-26

Using the Chord Book E-27

Looking Up a Chord Using the Chord
Book E-28

Keyboard Settings E-31

Transposing the Keyboard E-31

Tuning the Keyboard E-32



Troubleshooting E-33

Specifications E-34

Operating Precautions E-35

Appendix A-1

Tone List A-1

Fingered Chord Chart A-2

Percussion Instrument List A-4

Rhythm List A-5

Song List A-6

General Guide

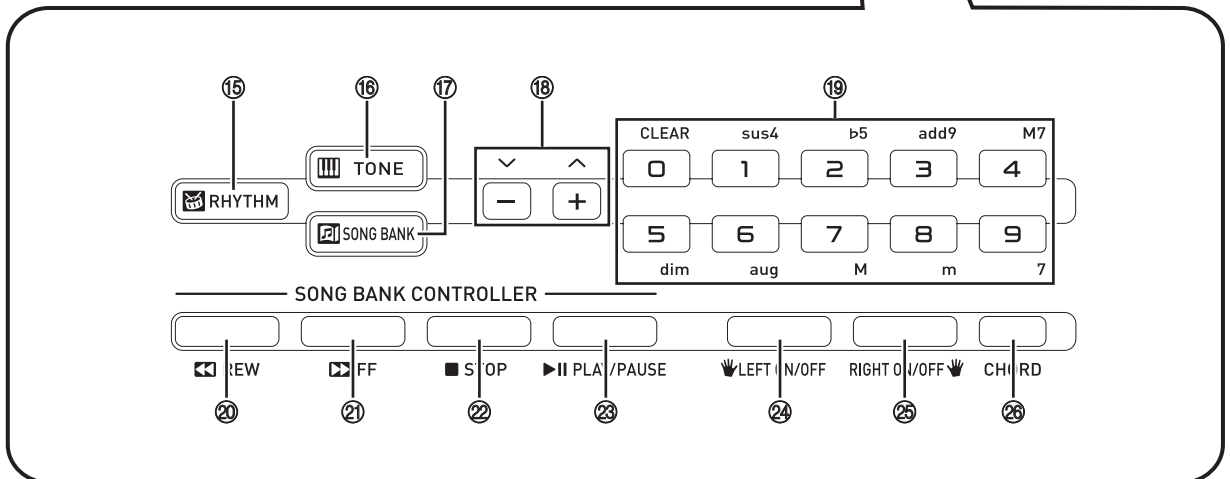
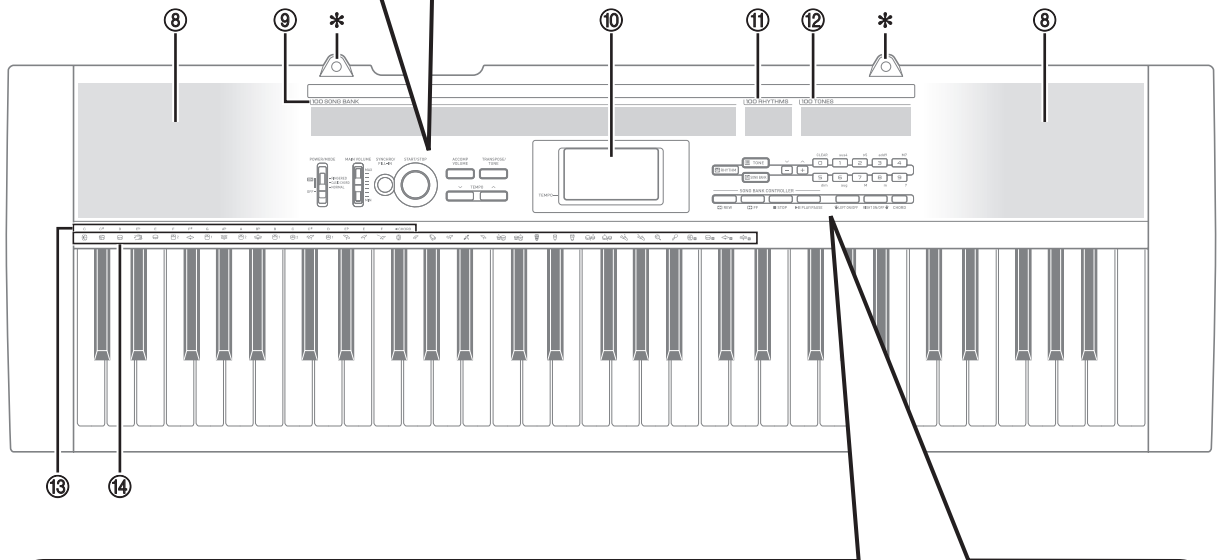
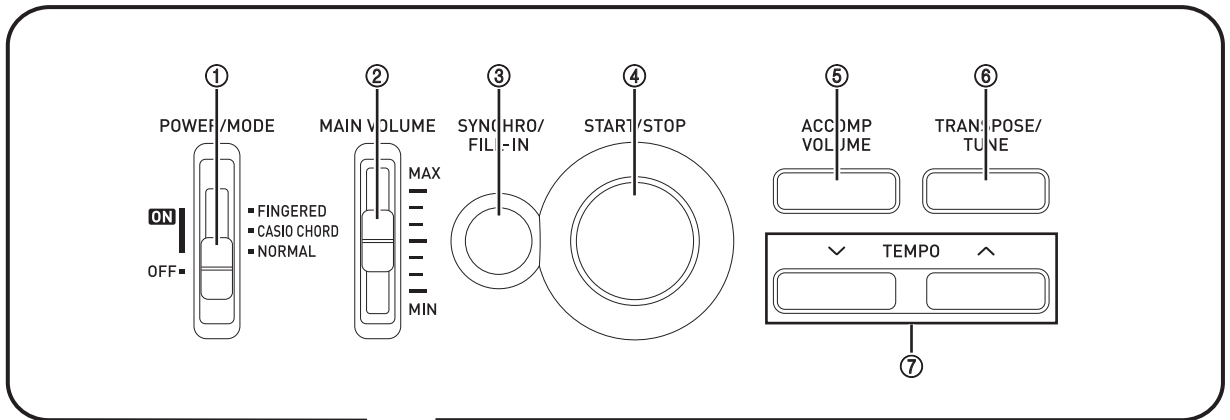

- ① POWER/MODE switch
- ② MAIN VOLUME slider
- ③ SYNCHRO/FILL-IN button
- ④ START/STOP button
- ⑤ ACCOMP VOLUME button
- ⑥ TRANSPOSE/TUNE button
- ⑦ TEMPO buttons
- ⑧ Speakers
- ⑨ Song Bank list
- ⑩ Display
- ⑪ Rhythm list
- ⑫ Tone list
- ⑬ CHORD root names
- ⑭ Percussion instrument list
- ⑮ RHYTHM button
- ⑯ TONE button
- ⑰ SONG BANK button
- ⑱ [+]/[-] buttons
 - Negative values can be changed only by using [+] and [-] to increase and decrease the displayed value.
- ⑲ Number buttons/Chord specification buttons
 - For input of numbers to change displayed settings.
 - For input of chord specification data when using the Chord Book.
- ⑳ REW button
- ㉑ FF button
- ㉒ STOP button
- ㉓ PLAY/PAUSE button
- ㉔ LEFT ON/OFF button
- ㉕ RIGHT ON/OFF button
- ㉖ CHORD button

Rear Panel

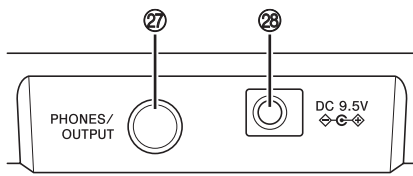

- ⑳ PHONES/OUTPUT terminal
- ㉑ DC 9.5V terminal

***Attachment of the Score Stand**

Insert both ends of the music stand provided with the keyboard into the two holes on the top surface.

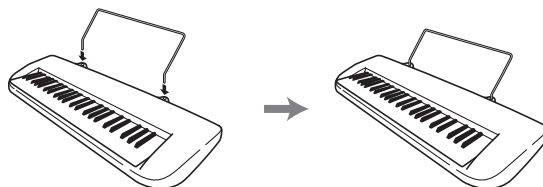

Song Bank Quick Reference

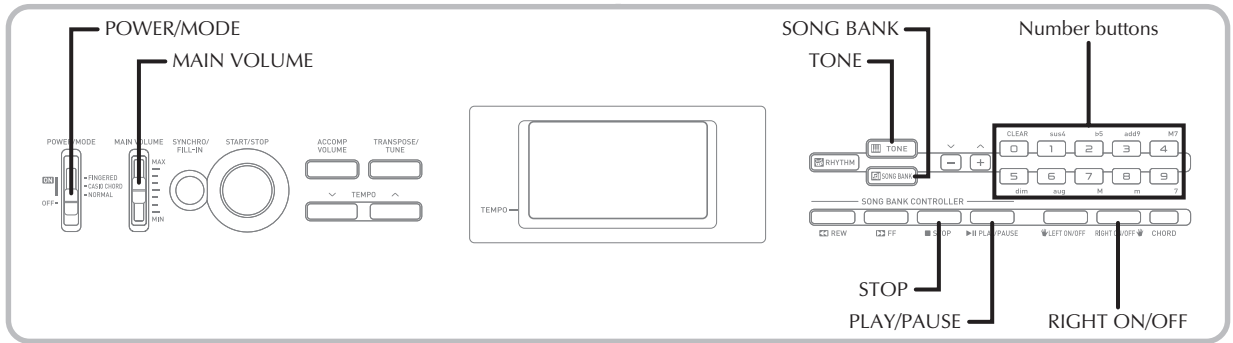

A selection of 100 Song Bank tunes comes built-in for your listening pleasure or play along fun. A simple operation cuts out the melody part or accompaniment part of the tune, allowing you to play along on the keyboard. See "Using the Song Bank" on page E-22 for details on playing along with Song Bank tunes.

Playing Back a Song Bank Tune

To play back a Song Bank tune

- 1 Set the POWER/MODE switch to NORMAL.
- 2 Use the MAIN VOLUME slider to lower the keyboard volume to a relatively low level.
- 3 Press the SONG BANK button to enter the Song Bank Mode.



Appears when SONG BANK button is pressed

- 4 Use the Song Bank list to find the tune you want to play back, and then use the number buttons to input the tune's two-digit number.
Example: To select "68", input 6 and then 8.
 - Not all of the available songs are shown on the song bank list printed on the keyboard console. For a complete list, see the "Song List" on page A-6.
- 5 Press the PLAY/PAUSE button to start play of the tune.
 - The tune plays in an endless loop, re-starting after it reaches the end.

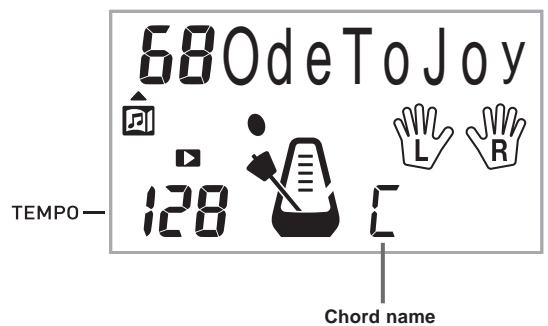



- 6 Press the RIGHT ON/OFF button to turn off the right-hand melody part and try playing along on the keyboard.

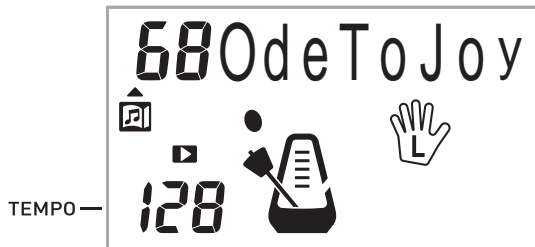

- 7 Press the RIGHT ON/OFF button again to turn the melody part back on.
- You can also turn the accompaniment part on and off by pressing the LEFT ON/OFF button.
- 8 Press the STOP button to stop playback of the Song Bank tune.
- 9 Press the TONE button to exit the Song Bank Mode and return to the tone and rhythm selection screen.



Indicator turns off

NOTE

- You can also perform the following operations during play of a Song Bank tune.
 - Pause: Press the PLAY/PAUSE button.
 - Fast Forward: Press the FF (fast forward) button.
 - Rewind: Press the REW (rewind) button.

Power Supply

Prepare a household power outlet or batteries.

IMPORTANT!

- Be sure to comply with the "Safety Precautions" provided in this manual. Incorrect use of this product creates the risk of electric shock and fire.
- Always make sure that the Digital Keyboard is turned off before plugging in or unplugging the AC adaptor, or before loading or removing batteries.

Using a Household Power Outlet

Make sure that you use only the AC adaptor specified for this keyboard. Use of a different type of AC adaptor can cause malfunction.

**Specified AC Adaptor: AD-E95100L
(JEITA Standard plug)**

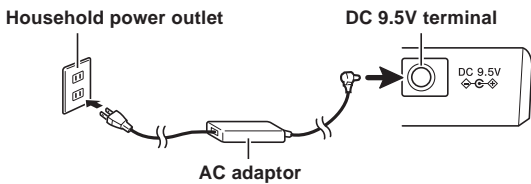

IMPORTANT!

- The AC adaptor will become warm to the touch after very long use. This is normal and does not indicate malfunction.
- To prevent breaking of the wire, take care to avoid putting any type of load on the power cord.

No bending!

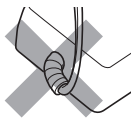

No winding!

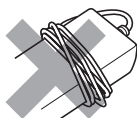

- Never insert metal, pencils, or any other objects into the product's 9.5V DC terminal. Doing so creates the risk of accident.

Using Batteries

You can use six AA-size batteries for power.

- Use alkaline or zinc-carbon batteries.
Never use oxyride or any other nickel based batteries.

Open the battery cover on the bottom of the Digital Keyboard, load the batteries, and then close the cover.

- Take care to ensure that the positive (+) and negative (-) ends of the batteries are facing correctly.

- 1 Remove the battery compartment cover.

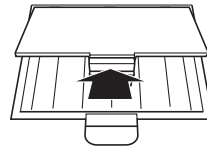

- 2 Load 6 AA-size batteries into the battery compartment.

- Make sure that the positive (+) and negative (-) ends are facing correctly.

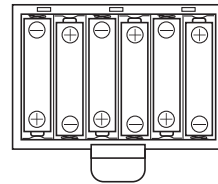

- 3 Insert the tabs on the battery compartment cover into the holes provided and close the cover.

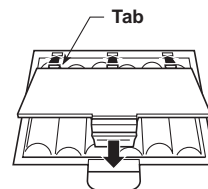



Important Battery Information

- The following shows the approximate battery life.
Zinc-carbon batteries 2 hours*
 - * The above value is standard battery life at normal temperature, with the keyboard volume at medium setting. Temperature extremes or playing at very loud volume settings can shorten battery life.
- Any of the following symptoms indicate low battery power. Replace batteries as soon as possible whenever any of the following occurs.
 - Instrument does not turn on
 - Display that is flickering, dim, or difficult to read
 - Abnormally low speaker/headphone volume
 - Distortion of sound output
 - Occasional interruption of sound when playing at high volume
 - Sudden power failure when playing at high volume
 - Flickering or dimming of the display when playing at high volume
 - Continued sound output even after you release a key
 - A tone that is totally different from the one that is selected
 - Abnormal rhythm pattern and Song Bank play

Auto Power Off

The Digital Keyboard will turn off automatically to preserve power if you do not perform any operation for about six minutes.

To disable Auto Power Off

Hold down the TONE button while turning on the keyboard to disable Auto Power Off.

NOTE

- When Auto Power Off is disabled, the keyboard does not turn off automatically no matter how long it is left with no operation being performed.
- Auto Power Off is automatically enabled whenever you turn on keyboard power.

Settings

All keyboard settings are returned to their initial defaults whenever keyboard power is turned back on after being turned off by operation of the POWER/MODE switch or Auto Power Off.

Connections

Phones/Output Terminal

Before connecting phones or other external equipment, be sure to first turn down the volume settings of the keyboard and the connected equipment. You can then adjust volume to the desired level after connections are complete.

[Rear Panel]

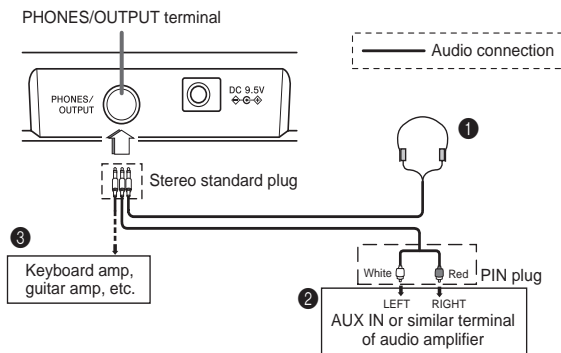

Connecting Phones (Figure 1)

Connecting phones cuts off output from the keyboard's built-in speakers, so you can play even late at night without disturbing anyone.

Audio Equipment (Figure 2)

Connect the keyboard to a audio equipment using a commercially available connecting cord with a standard plug on one end and two PIN plugs on the other end. Note that the standard plug you connect to the keyboard must be a stereo plug, otherwise you will be able to output only one of stereo channels. In this configuration, you normally set the input selector of the audio equipment to the terminal (usually marked AUX IN or something similar) where the cord from the keyboard is connected. See the user documentation that comes with your audio equipment for full details.

Musical Instrument Amplifier (Figure 3)

Use a commercially available connecting cord* to connect the keyboard to a musical instrument amplifier.

* Be sure to use a connecting cord that has a stereo standard plug on the end you connect to the keyboard, and a connector that provides dual channel (left and right) input to the amplifier to which you are connecting. The wrong type of connector at either end can cause one of the stereo channels to be lost.

When connected to a musical instrument amplifier, set the volume of the keyboard to a relatively low level and make output volume adjustments using the amplifier's controls.

[Connection Example]

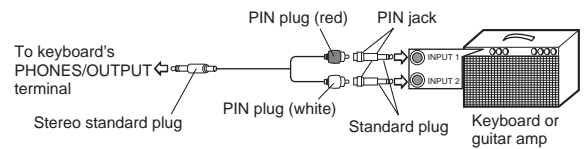

Accessories and Options

Use only the accessories and options specified for this keyboard. Use of non-authorized items creates the danger of fire, electrical shock, and personal injury.

- You can get information about accessories that are sold separately for this product from the CASIO catalog available from your retailer, and from the CASIO website at the following URL.

<http://world.casio.com/>

Basic Operations

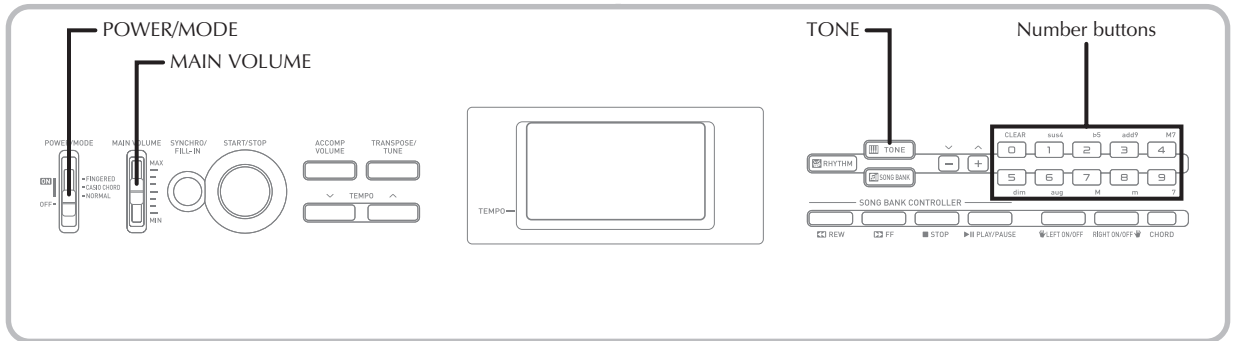

This section provides information on performing basic keyboard operations.

Playing the Keyboard

To play the keyboard

- 1 Set the POWER/MODE switch to NORMAL.
- 2 Use the MAIN VOLUME slider to lower the keyboard volume.
 - It's always a good idea to set the keyboard volume at a relatively low level before playing.
- 3 Play something on the keyboard.

Selecting a Tone

This keyboard comes with 100 built-in tones. Use the following procedure to select the tone you want to use.

To select a tone

- 1 Find the tone you want to use in the TONE List and note its tone number.
 - Not all of the available tones are shown on the tone list printed on the keyboard console. For a complete list, see the "Tone List" on page A-1.
- 2 Press the TONE button.

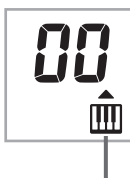

Appears when TONE button is pressed

- 3 Use the number buttons to input the two digit tone number for the tone you want to select.
Example: To select "26", input 2 and then 6.

NOTE

- Always input both digits for the tone number, including a leading zero (if any). If you input one digit and stop, the display will automatically clear your input after a few seconds.
- You can also increment the displayed tone number by pressing [+], and decrement it by pressing [-].

Combination tones

The following describes the two types of combination tones that are available.

Layered Tones (Tone Numbers: 80 through 89)

Example: 80 STR PIANO

This tone layers a strings tone with a piano tone so they both sound when a keyboard key is pressed.

Split Tones (Tone Numbers: 90 through 96)

Example: 90 BASS/PIANO

This tone splits the keyboard so one range is assigned a bass tone and another range is assigned a piano tone.

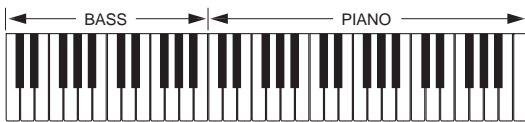

Percussion sounds

Example: 99 PERCUSSION

This tone assigns various percussion sounds to the keyboard. See the "Percussion Instrument List" on page A-4 for full details.

Sound Effect Tones

With sound effect tones 77 through 79, the type of sound produced depends on the octave where the key you press is located. When 78 PHONE is selected available sound types are PUSH TONE 1, PUSH TONE 2, RING 1, RING 2, and BUSY SIGNAL.

Polyphony

The term polyphony refers to the maximum number of notes you can play at the same time. The keyboard has 12-note polyphony, which includes the notes you play as well as the rhythms and auto-accompaniment patterns that are played by the keyboard. This means that when a rhythm or auto-accompaniment pattern is being played by the keyboard, the number of notes (polyphony) available for keyboard play is reduced. Also note that some of the tones offer only 6-note polyphony.

NOTE

- When rhythm or auto accompaniment is playing, the number of sounds simultaneously played is reduced.

Digital Sampling

A number of the tones that are available with this keyboard have been recorded and processed using a technique called digital sampling. To ensure a high level of tonal quality, samples are taken in the low, mid, and high ranges and then combined to provide you with sounds that are amazingly close to the originals. You may notice very slight differences in volume or sound quality for some tones when you play them at different positions on the keyboard. This is an unavoidable result of multiple sampling, and it is not a sign of malfunction.

Auto Accompaniment

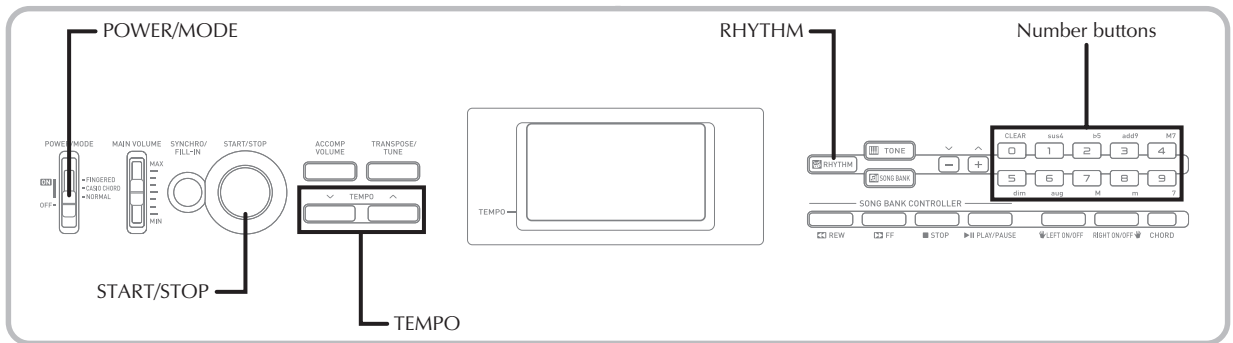

This keyboard automatically plays bass and chord parts in accordance with the chords you finger. The bass and chord parts are played using sounds and tones that are automatically selected to select the rhythm you are using. All of this means that you get full, realistic accompaniments for the melody notes you play with your right hand, creating the mood of an one-person ensemble.

Selecting a Rhythm

This keyboard provides you with 100 exciting rhythms that you can select using the following procedure.

To select a rhythm

- Find the rhythm you want to use in the RHYTHM List and note its rhythm number.
 - Not all of the available rhythms are shown on the rhythm list printed on the keyboard console. For a complete list, see the "Rhythm List" on page A-5.
- Press the RHYTHM button.

Appears when RHYTHM button is pressed



- Use the number buttons to input the two digit rhythm number for the rhythm you want to select.

Example: To select "64", input 6 and then 4.

NOTE

- "00" is the initial default rhythm setting whenever you turn on keyboard power.
- You can also increment the displayed rhythm number by pressing [+] and decrement it by pressing [-].

Playing a Rhythm

Use the following procedure to start and stop rhythm play.

To play a rhythm

- Set the POWER/MODE switch to NORMAL.
- Press the START/STOP button to start play of the currently selected rhythm.
- To stop rhythm play, press the START/STOP button again.

NOTE

- All of the keyboard keys are melody keys while the POWER/MODE switch is set to NORMAL.

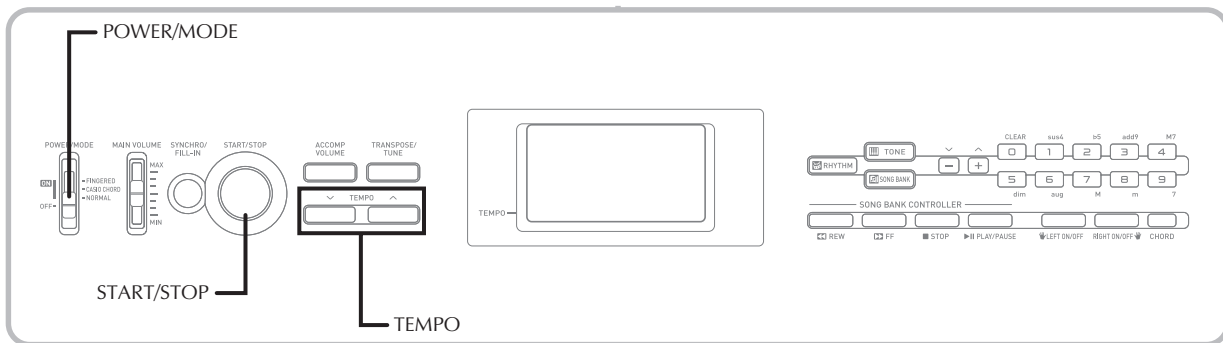

Adjusting the Tempo

You can adjust the tempo of rhythm play within a range of 20 to 255 beats per minute. The tempo setting is applied to Auto Accompaniment chord play, and song bank operations.

To adjust the tempo

- Use the TEMPO buttons (▲/▼) to adjust the tempo.
 - ▲: Increases the tempo value.
 - ▼: Decreases the tempo value.

Example: Hold down the ▼ button until the tempo value 110 is on the display.



NOTE

- Pressing both TEMPO buttons (▲ and ▼) at the same time resets the tempo to the default value of the currently selected rhythm.

Using Auto Accompaniment

The following procedure describes how to use the keyboard's Auto Accompaniment feature. Before starting, you should first select the rhythm you want to use and set the tempo of the rhythm to the value you want.

To use Auto Accompaniment

- Set the POWER/MODE switch to CASIO CHORD or FINGERED.
- Press the START/STOP button to start play of the currently selected rhythm.
- Play a chord.
 - The actual procedure you should use to play a chord depends on the current POWER/MODE switch position. Refer to the following pages for details on chord play.

CASIO CHORD Page E-19
 FINGERED Page E-20

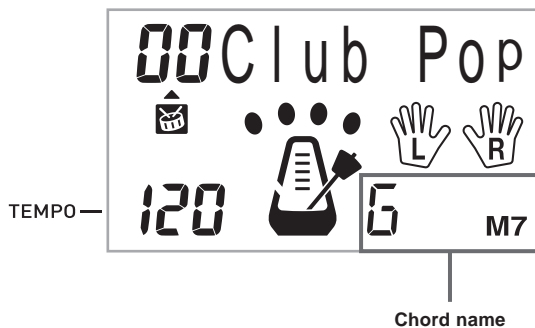

- To stop Auto Accompaniment play, press the START/STOP button again.

CASIO CHORD

This method of chord play makes it possible for anyone to easily play chords, regardless of previous musical knowledge and experience. The following describes the CASIO CHORD "Accompaniment keyboard" and "Melody keyboard", and tells you how to play CASIO CHORDs.

CASIO CHORD Accompaniment Keyboard and Melody Keyboard

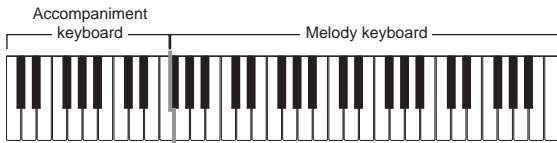

NOTE

- The accompaniment keyboard can be used for playing chords only. No sound will be produced if you try playing single melody notes on the accompaniment keyboard.

Chord Types

CASIO CHORD accompaniment lets you play four types of chords with minimal fingering.

Chord types	Example
<p>Major chords</p> <p>Major chord names are marked above the keys of the accompaniment keyboard. Note that the chord produced when you press an accompaniment keyboard does not change octave, regardless of which key you use to play it.</p>	<p>C Major (C)</p>
<p>Minor chords (m)</p> <p>To play a minor chord, keep the major chord key depressed and press any other accompaniment keyboard key located to the right of the major chord key.</p>	<p>C minor (Cm)</p>
<p>Seventh chords (7)</p> <p>To play a seventh chord, keep the major chord key depressed and press any other two accompaniment keyboard keys located to the right of the major chord key.</p>	<p>C seventh (C7)</p>
<p>Minor seventh chords (m7)</p> <p>To play a minor seventh chord, keep the major chord key depressed and press any other three accompaniment keyboard keys located to the right of the major chord key.</p>	<p>C minor seventh (Cm7)</p>

NOTE

- It makes no difference whether you press black or white keys to the right of a major chord key when playing minor and seventh chords.

FINGERED

FINGERED provides you with a total of 15 different chord types. The following describes the FINGERED “Accompaniment keyboard” and “Melody keyboard”, and tells you how to play a C-root chord using FINGERED.

FINGERED Accompaniment Keyboard and Melody Keyboard

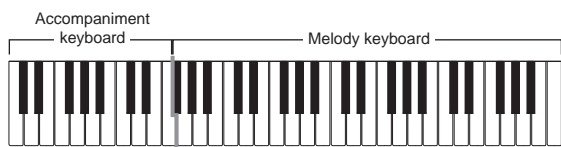

NOTE

- The accompaniment keyboard can be used for playing chords only. No sound will be produced if you try playing single melody notes on the accompaniment keyboard.

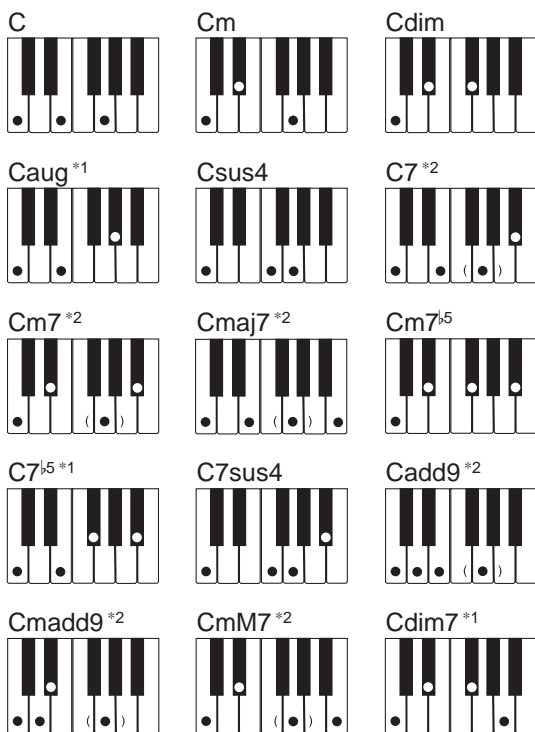

See the “Fingered Chord Chart” on page A-2 for details on playing chords with other roots.

*1: Inverted fingerings cannot be used. The lowest note is the root.

*2: The same chord can be played without pressing the 5th G.

NOTE

- Except for the chords specified in note*1 above, inverted fingerings (i.e. playing E-G-C or G-C-E instead of C-E-G) will produce the same chords as the standard fingering.
- Except for the exception specified in note*2 above, all of the keys that make up a chord must be pressed. Failure to press even a single key will not play the desired FINGERED chord.

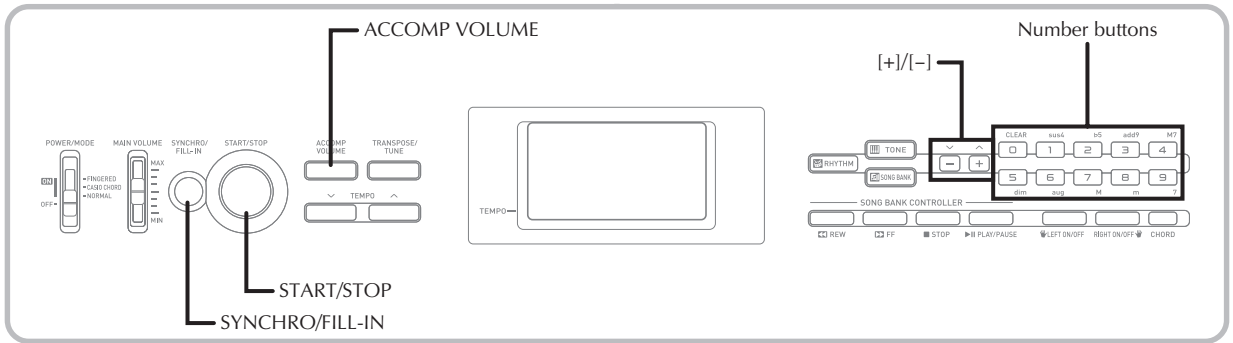

Using a Fill-in Pattern

Fill-in patterns let you momentarily change the rhythm pattern to add some interesting variation to your performances.

The following procedure describes how to use the Fill-in feature.

To insert a fill-in

- 1 Press the START/STOP button to start rhythm play.
- 2 Press the SYNCHRO/FILL-IN button to insert a fill-in pattern for the rhythm you are using.

Synchro Starting Accompaniment with Rhythm Play

You can set up the keyboard to start rhythm play at the same time you play the accompaniment on the keyboard.

The following procedure describes how to use synchro start. Before starting, you should first select the rhythm you want to use, set the tempo, and use the POWER/MODE switch to select the chord play method you want to use (CASIO CHORD, FINGERED).

To use synchro start

- 1 Press the SYNCHRO/FILL-IN button to put the keyboard into synchro start standby.



- 2 Play a chord on the accompaniment keyboard and the rhythm pattern starts to play automatically.

NOTE

- If the POWER/MODE switch is set to NORMAL, only the rhythm plays (without a chord) when you play on the accompaniment keyboard.
- To cancel synchro start standby, press the SYNCHRO/FILL-IN button one more time.

Adjusting the Accompaniment Volume

You can adjust the volume of the accompaniment parts as a value in the range of 0 (minimum) to 9.

- 1 Press the ACCOMP VOLUME button.

Current accompaniment volume setting



- 2 Use the number buttons or the +/[-] buttons to change the current volume setting value.

Example: 5



NOTE

- The current accompaniment volume value that appears in Step 1 automatically clears from the display if you do not input anything within about five seconds.
- Pressing [+] and [-] buttons at the same time automatically sets an accompaniment volume of 7.

Using the Song Bank

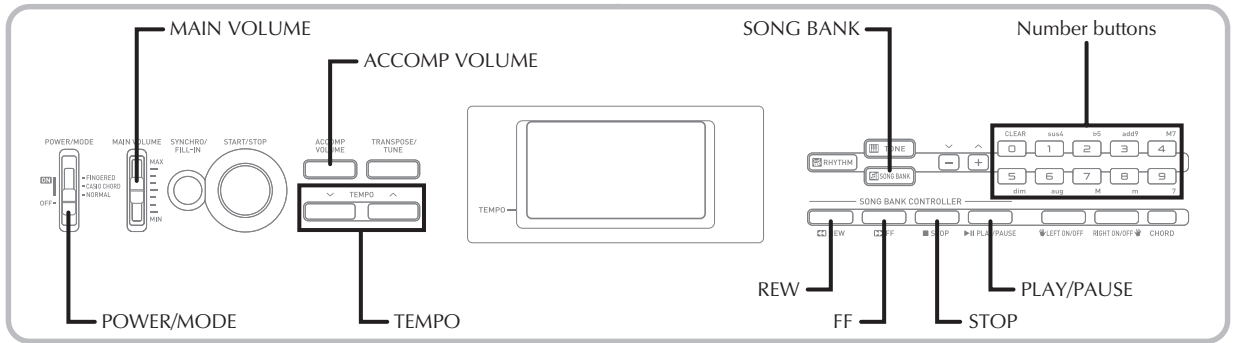

A selection of 100 Song Bank tunes comes built-in for your listening enjoyment or play along fun. You can turn off the left-hand or right-hand part to practice with the remaining part.

Playing Back a Song Bank Tune

To play back a Song Bank tune

- 1 Set the POWER/MODE switch to NORMAL.
- 2 Adjust the main volume and accomp volume.
- 3 Press the SONG BANK button to enter the Song Bank Mode.



Appears when SONG BANK button is pressed

- 4 Use the Song Bank list to find the tune you want to play back, and then use the number buttons to input the tune's two-digit number.

Example: To select "50", input 5 and then 0.

- Not all of the available songs are shown on the song bank list printed on the keyboard console. For a complete list, see the "Song List" on page A-6.

NOTE

- "00" is the initial default Song Bank tune setting whenever you turn on keyboard power.
- You can also increment the displayed tune number by pressing [+], and decrement is by pressing [-].
- Before advancing to the next step, which actually starts playback, you can adjust the tempo (page E-18), select a tone (page E-15) for the melody part, or turn off the left-hand or right-hand part (page E-25).

- 5 Press the PLAY/PAUSE button to start play of the tune.

Appears when PLAY/PAUSE button is pressed



Chord name

- 6 Press the STOP button to stop playback of the Song Bank tune.

To pause Song Bank tune play

- 1 While a Song Bank tune is playing, press the PLAY/PAUSE button to pause it.

The indicator "II" appears while a tune play is paused.

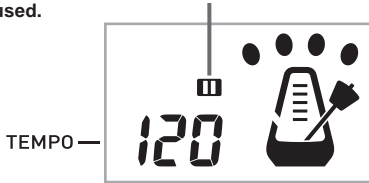

- 2 To resume play, press PLAY/PAUSE again.

To fast reverse during playback

- 1 While playback is in progress, hold down the REW button.

The indicator "◀◀" appears while a fast reverse operation is in progress.



- Beeps sound during fast reverse to give you an idea of where you are located in the tune.
1 beep: indicates a change to another measure.
2 beeps: indicates the beginning of the tune.

- 2 To resume normal playback, release the REW button.

To fast forward during playback

- 1 While playback is in progress, hold down the FF button.

The indicator "▶▶" appears while a fast forward operation is in progress.



- Beeps sound during fast forward to give you an idea of where you are located in the tune.
1 beep: indicates a change to another measure.
3 beeps: indicates the ending of the tune.

- 2 To resume normal playback, release the FF button.

NOTE

- Each time you select a new Song Bank tune, the tone, tempo, and rhythm settings of the keyboard change to those programmed for the tune, and the accompaniment volume level changes to 7.
- You can change the tone and tempo setting while a tune is playing, but you cannot change the rhythm setting.
- You can also adjust the accompaniment volume (page E-21) for tunes 00 through 80.

Song Bank Mode Display

In the Song Bank Mode, the display shows a variety of information about the tune being played.

[Playback Display]

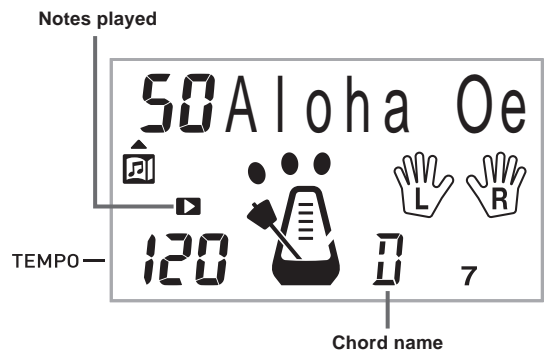

NOTE

- Chord names are not displayed for Songs 81 through 99.

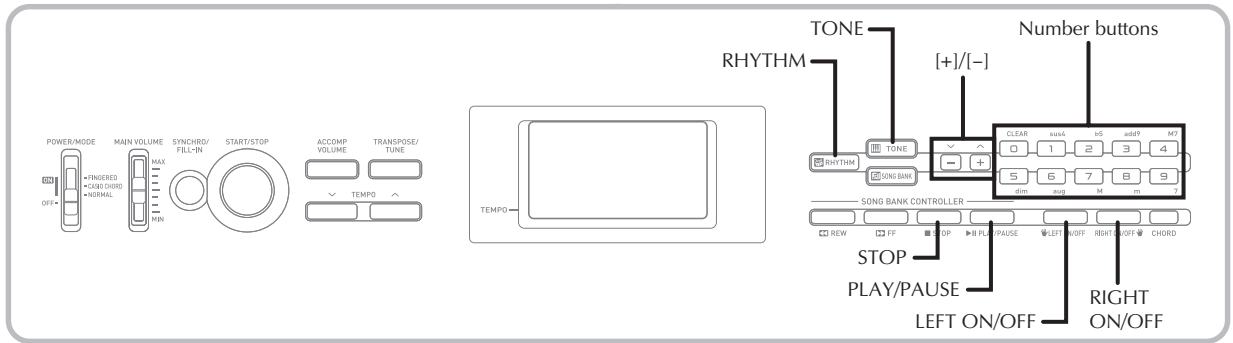

Adjusting the Tempo of a Song Bank Tune

To change the tempo of a Song Bank tune

The tempo can be set within a range of 20 to 255 beats per minute. The tempo setting can be adjusted while the tune is stopped, playing back, or paused.

- 1 Use the TEMPO buttons (▲/▼) to adjust the tempo.
 ▲ : each press increases the value
 ▼ : each press decreases the value

NOTE

- Pressing both the [▲] and [▼] TEMPO buttons at the same time returns the tempo setting to the preset value for the currently selected tune.
- Song Bank tunes 81 through 99 are arranged so their tempos change part way through the tunes. If you use the above procedure to change the tempo setting while one of these tunes is playing, however, the tempo you set is used for the entire tune without any change part way through.

Changing the Tone of a Song Bank Tune's Melody

You can select any one of the keyboard's 100 tones to be used to play the melody part of a Song Bank tune. The tone setting can be changed while the tune is stopped or playing back.

- 1 While a song is playing back, press the TONE button.

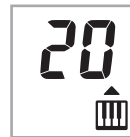

- 2 Find the tone you want in the Tone List, and then use the number buttons or the [+] and [-] buttons to specify the tone number.

Example: To select "30", input 3 and then 0.

NOTE

- Pressing both the [+] and [-] buttons at the same time selects "00".
- With two-hand tunes (81 to 99), you can select tones for both the left hand part and right hand part.
- To return a Song Bank tune to its original settings, simply select that tune again.

Playing Along with a Song Bank Tune

Each Song Bank tune has a left-hand (accompaniment) part and a right-hand (melody) part. You can turn off the left-hand part or right-hand part of a Song Bank tune and play along with the remaining part on the keyboard.

Tune Numbers	00 to 80	81 to 99
Accompaniment Type	Auto-accompaniment	Piano Solo
Left-hand Part	Auto-accompaniment (percussion, bass, chords)	Left-hand notes
Right-hand Part	Melody	Right-hand notes

To play along with a Song Bank tune

- 1 Perform steps 1 through 4 under "To play back a Song Bank tune" on page E-22 to select the song you want to play along with.
- 2 Press the RIGHT ON/OFF or LEFT ON/OFF button for the part you want to turn off.
 - Press the RIGHT ON/OFF button to turn off the right hand (melody) part, or the LEFT ON/OFF button to turn off the left hand (accompaniment) part.
 - The display shows the on/off status of each part.
Example: Left-hand part on, right-hand part off



- 3 Press the PLAY/PAUSE button to start play of the Song Bank Tune.
 - Only the part (melody or accompaniment) that is turned on is played, so you can play the other part on the keyboard.
 - You can press the RIGHT ON/OFF and LEFT ON/OFF buttons to turn parts on and off while playback is in progress.
- 4 To end playback, press the STOP button.

Auto-accompaniment Tunes (Tune Numbers 00 to 80)

During playback of these tunes in the Song Bank Mode, the chord specification method for the left hand is always FINGERED for these tunes.

Two-hand Tunes (Tune Numbers 81 to 99)

During playback of these tunes in the Song Bank Mode, the entire keyboard functions as a melody.

NOTE

- With two-hand tunes (81 to 99), you cannot turn off both the left-hand and right-hand parts at the same time.
- The selected Song Bank tune continues to repeat until you stop playback by pressing the STOP button.
- The accompaniment volume setting (page E-21) affects auto-accompaniment tunes (00 to 80) only.
- Chord names are not displayed during playback of two-hand tunes (81 to 99).
- Turning off both the left-hand and right-hand parts of the auto-accompaniment tunes (00 to 80) results in obbligato accompaniment being played.

Applause Sound

Whenever you turn off the left hand or right hand part of a Song Bank tune and play it back, an applause sound is produced when the tune reaches the end.

To turn off the applause sound

- 1 Press the STOP button and the LEFT ON/OFF or RIGHT ON/OFF button at the same time.

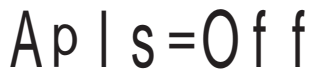

Ap | s = Off

- Pressing the STOP button and the LEFT ON/OFF or RIGHT ON/OFF button at the same time again turns the applause sound back on.

Playing Back All Song Bank Tunes in Succession

- 1 Use the TONE or RHYTHM button to change to any mode other than the Song Bank Mode.



Indicator turns off.

- 2 Press the PLAY/PAUSE button to start playback of the Song Bank tunes starting from tune 00.
- 3 To stop Song Bank tune playback, press the STOP button.
 - Pausing playback automatically cancels consecutive playback of all Song Bank tunes. Re-starting playback causes repeat playback of the current tune only.

Using the Chord Book

The Chord Book mode of this keyboard lets you use button operations to sound a chord, even if you do not know how to finger it on the keyboards. Specifying a chord using the Chord Book also causes its Auto Accompaniment to play.

What is a chord?

A chord is made up of a root note, upon which is stacked a number of other notes. A variety of different chords can be created by changing the notes stacked onto a root.

<Example: C chord>

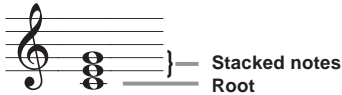

Chord Names

Chords are named using upper-case letters from A through G, which indicate the root note of the chord. If the root note is a sharp or flat, the chord itself is sharp or flat. A chord name may also be followed by a degree number or other symbols that indicate certain characteristics about the chord.

<Examples>

C Root	Sharp F# Root	Flat Bb Root	Minor Am Root	Sharp Diminished C# dim Root
Seventh G7 Degree Root	Major seventh FM7 Degree Root	Sus fourth Esus4 Root		

<Note Names>

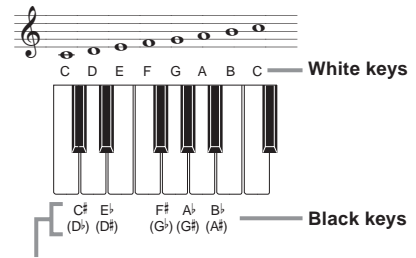

Sharps and flats can be referred to using either of the names shown here. The names in the upper row of this illustration are used by this keyboard, because they are the names that are most commonly used in musical notation.

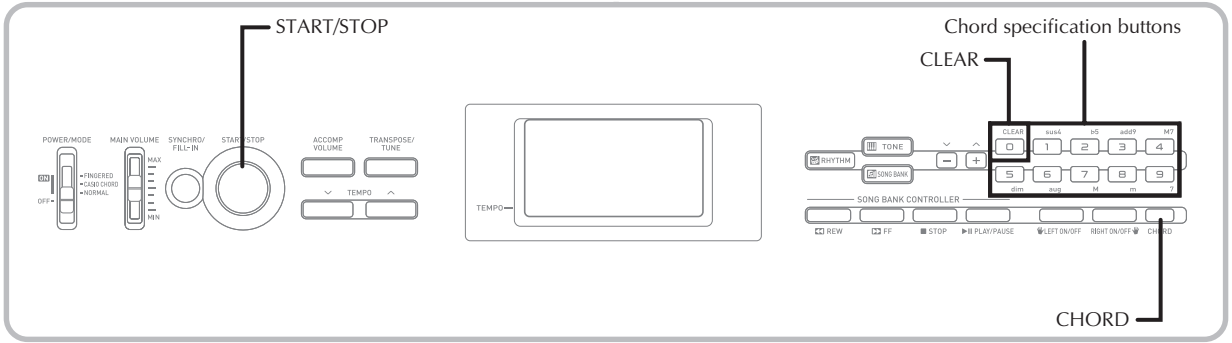

Looking Up a Chord Using the Chord Book

- 1 Press the CHORD button to enter the Chord Book mode.



- 2 Press the CLEAR button.
 - This step is necessary to clear any previously input chord name.

- 3 If the chord name you plan to input is a non-major chord, use the chord specification buttons to specify the chord type.
 - Chord types are indicated by the small letters above the chord specifications buttons.
 - Non-major chords include minor, seventh, sustained, etc. chords.
 - See page E-30 for details on the chord specification buttons.
 - Skip step 3 if you want to input a major chord name.

<Example: F#m7-5>

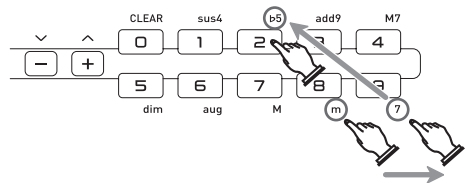

- 4 Press the accompaniment keyboard key that corresponds to the root note of the chord.
- This causes the appropriate chord to sound.
 - A dash appears in place of the chord name if the chord cannot be recognized by the keyboard.
 - To specify F[#], for example, press the F[#] key.

<Example: F[#]m7-5>

C[#]E^b (F[#])^bB^b C[#]E^b
C D E F G A B C D E F

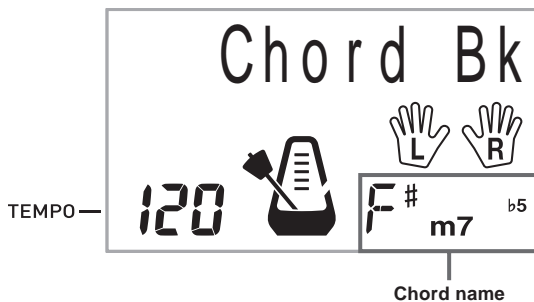

- 5 Check to make sure that the chord name on the display is the one you want. If it isn't, repeat the above from step 2.

NOTE

- You can also use the [+] and [-] buttons to change the displayed chord name.
- The tone used to sound chords you play on the accompaniment keyboard while using the Chord Book is the same tone used by the accompaniment part of the rhythm that was selected before you entered the Chord Book mode. Depending on the rhythm that was selected, some of the notes that make up a chord may be omitted when you play the chord on the accompaniment keyboard in the Chord Book Mode. This is due to the internal chord conversion function, arrangements, and polyphony limitations.
- You can press the START/STOP button to start play of a rhythm pattern and then use the Chord Book to specify a chord. This will cause the rhythm pattern to change in accordance with the specified chord.
- Changing to a different rhythm pattern (rhythm number) exits the Chord Book mode.

Chord Name Modifier Keys

Chord Type	Symbol and Name	Reference	Modifier Key
major	C (C major)		_____
minor	Cm (C minor)		
aug	Caug (C augmented)	C+5	
sus 4	Csus4 (C sustained fourth)		
dim	Cdim (C diminished)	C°	
7th	C7 (C seventh)		
M7	CM7 (C major seventh)	Cmaj7 CΔ7	
minor 7	Cm7 (C minor seventh)		
minor M7	CmM7 (C minor Major seventh)		
minor 7-5	Cm7-5 (C minor seventh flat five)	C°	

Chord Type	Symbol and Name	Reference	Modifier Key
7sus 4	C7sus4 (C seventh sus fourth)		
add 9	Cadd9 (C add ninth)		
m add 9	Cm add9 (C minor add ninth)		
7th-5	Cs7-5 (C seventh flat five)	C7b5	
dim7	Cdim7 (C diminished seventh)		

NOTE

- While a chord name is on the display, you can press keys on the accompaniment keyboard to find out the fingerings of the same chord with a different root.
- You can also scroll through chord names using the [+] and [-] buttons.

Keyboard Settings

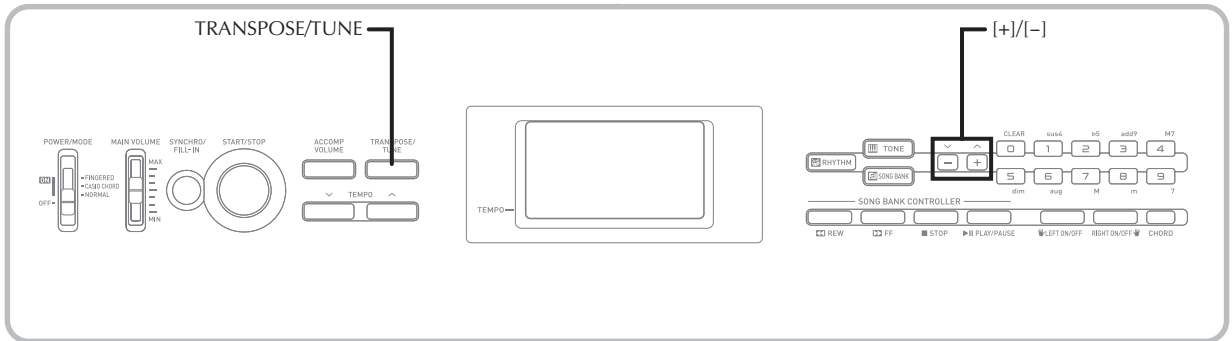

Transposing the Keyboard

Transpose lets you raise and lower the overall key of the keyboard in semitone units. If you want to play an accompaniment for a vocalist who sings in a key that's different from the keyboard, for example, simply use transpose to change the key of the keyboard.

To transpose the keyboard

- 1 Press the TRANPOSE/TUNE button until the transpose screen appears on the display.

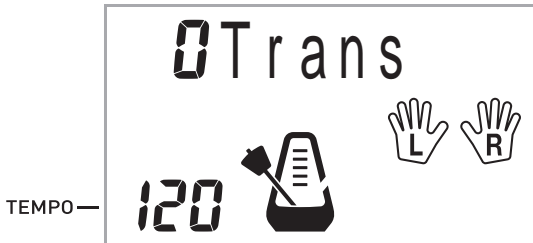

- 2 Use [+] and [-] to change the transpose setting of the keyboard.

Example: To transpose the keyboard five semitones upwards.



NOTE

- The keyboard can be transposed within a range of -6 to +5.
- The default transpose setting is "0" when keyboard power is turned on.
- If you leave the transpose screen on the display for about five seconds without doing anything, the screen is automatically cleared.
- The transpose setting also affects Auto Accompaniment.
- Playing back a Song Bank tune automatically returns the transpose setting to its standard default of "0".
- The allowable pitch range you can transpose within depends on the tone you are using. If a transpose operation causes a note to be outside of the pitch range for the tone being used, the keyboard automatically plays the same note in the nearest octave that falls within the pitch range of the tone you are using.

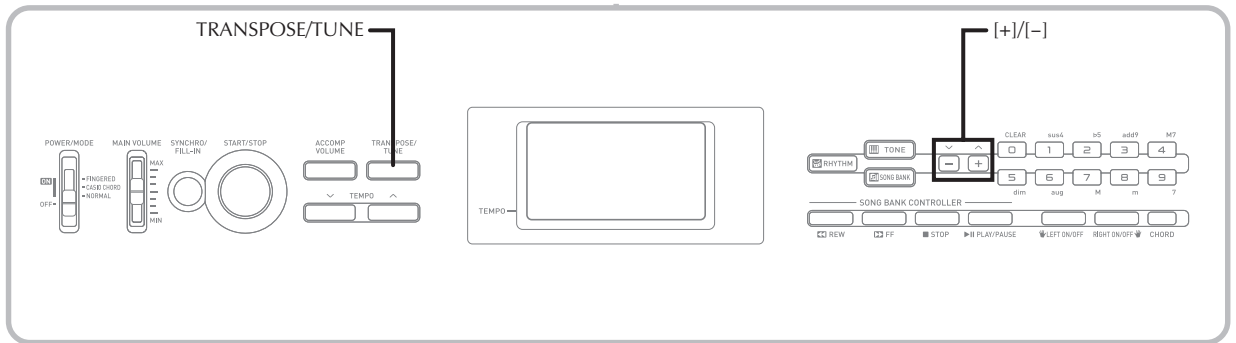

Tuning the Keyboard

The tuning feature lets you fine tune the keyboard to match the tuning of another musical instrument.

To tune the keyboard

- 1 Press the TRANPOSE/TUNE button twice to display the tuning screen.

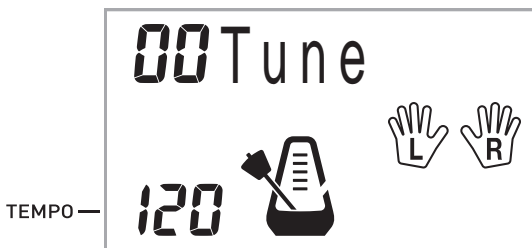

- 2 Use [+] and [-] to change the tuning setting of the keyboard.

Example: To lower the tuning by 20.



NOTE

- The keyboard can be tuned within a range of -50 cents to +50 cents.
*100 cents is equivalent to one semitone.
- The default tuning setting is "00" when keyboard power is turned on.
- If you leave the tuning screen on the display for about five seconds without doing anything, the screen is automatically cleared.
- The tuning setting also affects Auto Accompaniment.
- Playing back a Song Bank tune automatically returns the tuning setting to its standard default of "00".

Troubleshooting

Problem	Possible Cause	Action	See page
No keyboard Sound	<ol style="list-style-type: none"> 1. Power supply problem. 2. Power is not turned on. 3. Volume setting is too low. 4. The POWER/MODE switch is in the CASIO CHORD or FINGERED position. 	<ol style="list-style-type: none"> 1. Correctly attach the AC adaptor, make sure that batteries poles (+/-) are facing correctly, and check to make sure that batteries are not dead. 2. Set the POWER/MODE switch to the NORMAL position. 3. Use the MAIN VOLUME slider to increase volume. 4. Normal play is not possible on the accompaniment keyboard while the POWER/MODE switch is set to CASIO CHORD or FINGERED. Change the POWER/MODE switch setting to NORMAL. 	<p>Pages E-12, 13</p> <p>Page E-15</p> <p>Page E-15</p> <p>Page E-15</p>
Any of the following symptoms while using battery power.	Low battery power	Replace the batteries with a set of new ones or use the AC adaptor.	Pages E-12, 13
<ul style="list-style-type: none"> • Instrument does not turn on • Display that is flickering, dim, or difficult to read • Abnormally low speaker/headphone volume • Distortion of sound output • Occasional interruption of sound when playing at high volume • Sudden power failure when playing at high volume • Flickering or dimming of the display when playing at high volume • Continued sound output even after you release a key • A tone that is totally different from the one that is selected • Abnormal rhythm pattern and Song Bank play 			
Auto Accompaniment does not sound.	Auto accompaniment volume is set to 0.	Use the ACCOMP VOLUME button to increase the volume.	Page E-21
The key or tuning does not match when playing along with another instrument.	The tuning or transpose parameter is set to a value other than 0 or 00.	Change the transpose or tuning parameter value to 0 or 00.	Pages E-31, 32
Missing Song Bank tune.	<ol style="list-style-type: none"> 1. Left-hand or right-hand part is turned off. 2. Accompaniment volume is set to 0. 	<ol style="list-style-type: none"> 1. Check the display to see if the indicator for one of the parts is not displayed. If so, press the part's button (LEFT ON/OFF, RIGHT ON/OFF) to turn it on. 2. Adjust accompaniment volume. 	<p>Page E-25</p> <p>Page E-21</p>

Specifications

Model:	CTK-1100
Keyboard:	61 standard-size keys, 5 octaves
Tones:	100
Polyphony:	12 notes maximum (6 for certain tones)
Auto Accompaniment Rhythm Patterns: Tempo: Chords: Rhythm Controller: Accomp Volume:	100 Variable (236 steps, ♩ = 20 to 255) 2 fingering methods (CASIO CHORD, FINGERED) START/STOP, SYNCHRO/FILL-IN 0 to 9 (10 steps)
Song Bank Tunes: Controllers:	100 PLAY/PAUSE, STOP, REW, FF, LEFT ON/OFF (ACCOMP), RIGHT ON/OFF (MELODY)
Other Functions Transpose: Tuning:	12 steps (-6 semitones to +5 semitones) Variable (A4 = approximately 440Hz ±50 cents)
Terminals Phones/Output Terminal: Power Supply Terminal:	Stereo standard jack (Output is monaural.) Output Impedance: 78Ω Output Voltage: 4V (RMS) MAX 9.5V DC
Power Supply: Batteries: AC Adaptor: Auto Power Off:	Dual power supply system 6 AA-size zinc-carbon batteries or alkaline batteries Battery Life: Approximately 2 hours continuous operation on zinc-carbon batteries AD-E95100L Turns power off approximately 6 minutes after last key operation.
Speaker Output:	2.0W + 2.0W
Power Consumption:	9.5V ∴ 7.7W
Dimensions:	94.9 x 30.4 x 9.3 cm (37 ³ / ₈ x 11 ¹⁵ / ₁₆ x 3 ¹¹ / ₁₆ inch)
Weight:	Approximately 3.3kg (7.3lbs) (without batteries)

NOTE

- Design and specifications are subject to change without notice.

Operating Precautions

Be sure to read and observe the following operating precautions.

□ Location

Avoid the following locations for this product.

- Areas exposed to direct sunlight and high humidity
- Areas subjected to temperature extremes
- Near a radio, TV, video deck, or tuner

The above devices will not cause malfunction of the product, but the product can cause interference in the audio or video of a nearby device.

□ User Maintenance

- Never use benzine, alcohol, thinner, or other chemical agents to clean the product.
- To clean the product or its keyboard, wipe with a soft cloth moistened in a weak solution of water and a mild neutral detergent. Wring all excess moisture from the cloth before wiping.

□ Included and Optional Accessories

Use only accessories that are specified for use with this product.

Use of unauthorized accessories creates the risk of fire, electric shock, and personal injury.

□ AC Adaptor Handling Precautions

- Use a power outlet that is easily accessible so you can unplug the AC adaptor when a malfunction occurs or whenever else you need to do so.
- The AC adaptor is intended for indoor use only. Do not use it where it might be exposed to splashing or moisture. Do not place any container, such as a flower vase, that contains liquid on the AC adaptor.
- Store the AC adaptor in a dry place.
- Use the AC adaptor in an open, well-ventilated area.
- Never cover the AC adaptor with newspaper, a table cloth, a curtain, or any other similar item.
- Unplug the AC adaptor from the power outlet if you do not plan to use the product for a long time.
- Never try to repair the AC adaptor or modify it in any way.
- AC adaptor operating environment
 - Temperature: 0 to 40°C
 - Humidity: 10% to 90% RH
- Output polarity: ⚡⚡⚡

□ Weld Lines

Lines may be visible on the exterior of the product. These are “weld lines” that result from the plastic molding process. They are not cracks or scratches.

□ Musical Instrument Etiquette

Always be aware of others around you whenever using this product. Be especially careful when playing late at night to keep the volume at levels that do not disturb others. Other steps you can take when playing late at night are closing windows and using headphones.

- Any reproduction of the contents of this manual, either in part or its entirety, is prohibited. Except for your own, personal use, any other use of the contents of this manual without the consent of CASIO is prohibited under copyright laws.
- IN NO EVENT SHALL CASIO BE LIABLE FOR ANY DAMAGES WHATSOEVER (INCLUDING, WITHOUT LIMITATION, DAMAGES FOR LOSS OF PROFITS, BUSINESS INTERRUPTION, LOSS OF INFORMATION) ARISING OUT OF THE USE OF OR INABILITY TO USE THIS MANUAL OR PRODUCT, EVEN IF CASIO HAS BEEN ADVISED OF THE POSSIBILITY OF SUCH DAMAGES.
- The contents of this manual are subject to change without notice.
- The actual appearance of the product may be different from that shown in the illustrations in this User's Guide.
- Company and product names used in this manual may be registered trademarks of others.

Appendix/Apéndice

Tone List

Lista de sonidos

PIANO	
00	PIANO 1
01	PIANO 2
02	HONKY-TONK
03	STUDIO PIANO
04	ELEC PIANO 1
05	ELEC PIANO 2
06	ELEC PIANO 3
07	ELEC PIANO 4
08	HARPSICHORD
09	CLAVELECTRO
ORGAN	
10	ELEC ORGAN 1
11	ELEC ORGAN 2
12	ELEC ORGAN 3
13	ELEC ORGAN 4
14	CHURCH ORGAN
15	PIPE ORGAN
16	REED ORGAN
17	ACCORDION
18	BANDONEON
19	HARMONICA
GUITAR/BASS	
20	GUT GUITAR
21	ACOUS GUITAR
22	JAZZ GUITAR
23	ELEC GUITAR
24	MUTE GUITAR
25	DIST GUITAR
26	WOOD BASS
27	ELEC BASS
28	SLAP BASS
29	BANJO
STRINGS/ENSEMBLE	
30	VIOLIN
31	CELLO
32	HARP
33	STRINGS 1
34	STRINGS 2
35	STRINGS 3
36	SYNTH-STR 1
37	SYNTH-STR 2
38	CHOIR
39	VOICE OOH

BRASS/REED/PIPE	
40	TRUMPET
41	TUBA
42	BRASS ENS
43	FR.HORN 1
44	FR.HORN 2
45	BRASS 1
46	BRASS 2
47	SYN-BRASS 1
48	SYN-BRASS 2
49	SYN-BRASS 3
50	SOPRANO SAX
51	ALTO SAX
52	TENOR SAX
53	OBOE
54	CLARINET
55	PICCOLO
56	FLUTE
57	RECORDER
58	PAN FLUTE
59	WHISTLE
SYNTH-SOUND	
60	SYN-LEAD 1
61	SYN-LEAD 2
62	SYN-LEAD 3
63	SYN-CALLIOPE
64	SYN-PAD 1
65	SYN-PAD 2
66	SYN-PAD 3
67	GLASS HMCA
68	COUNTRY FARM
69	SYN-BASS
70	PEARL DROP
71	COSMIC SOUND
72	SOUNDTRACK
73	SPACE PAD
74	VOICE BASS
75	APPLAUSE
76	SYNTH-SFX
77	VEHICLE
78	PHONE
79	FUNNY

LAYER	
80	STR PIANO
81	STR E.PIANO
82	CHOIR E.P
83	CHOIR ORGAN
84	STR GUITAR
85	STR HARP
86	BRASS STR
87	VIB PAD
88	12 STR GTR
89	CHOIR STR
SPLIT/PERCUSSION	
90	BASS/PIANO
91	BASS/E.PIANO
92	BASS/VIB
93	BASS/GUT GTR
94	V.BASS/OOH
95	STR/PIANO
96	STR/TRUMPET
97	VIBRAPHONE
98	MARIMBA
99	PERCUSSION

Fingered Chord Chart

Cuadros de acordes Fingered

This table shows the left-hand fingerings (including inverted forms) for a number of often-used chords.

Esta tabla muestra las digitaciones (incluyendo las formas invertidas) para varios de los acordes más a menudo usados.

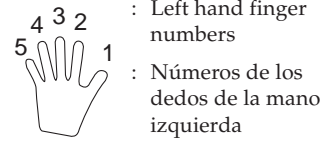

Chord Root	M	m	7	m7	dim7	M7	m7-5	dim
C	[5, 3, 1]	[5, 3, 1]	[5, 3, 2, 1]	[5, 3, 2, 1]	[5, 3, 2, 1]	[5, 3, 2, 1]	[5, 3, 2, 1]	[5, 3, 2]
C# (D♭)	[5, 3, 1]	[5, 3, 1]	[5, 3, 2, 1]	[5, 3, 2, 1]	[5, 3, 2, 1]	[5, 3, 2, 1]	[5, 3, 2, 1]	[5, 3, 2]
D	[5, 3, 1]	[5, 3, 1]	[5, 3, 2, 1]	[5, 3, 2, 1]	[5, 3, 2, 1]	[5, 3, 2, 1]	[5, 3, 2, 1]	[5, 3, 2]
E♭ (D#)	[5, 3, 1]	[5, 3, 1]	[5, 3, 2, 1]	[5, 3, 2, 1]	[5, 3, 2, 1]	[5, 3, 2, 1]	[5, 3, 2, 1]	[5, 3, 2]
E	[5, 3, 1]	[5, 3, 1]	[5, 3, 2, 1]	[5, 3, 2, 1]	[5, 3, 2, 1]	[5, 3, 2, 1]	[5, 3, 2, 1]	[5, 3, 2]
F	[5, 3, 1]	[5, 3, 1]	[5, 3, 2, 1]	[5, 3, 2, 1]	[5, 3, 2, 1]	[5, 3, 2, 1]	[5, 3, 2, 1]	[5, 3, 2]
F# (G♭)	[5, 3, 1]	[5, 3, 1]	[5, 3, 2, 1]	[5, 3, 2, 1]	[5, 3, 2, 1]	[5, 3, 2, 1]	[5, 3, 2, 1]	[5, 3, 2]
G	[5, 3, 1]	[5, 3, 1]	[5, 3, 2, 1]	[5, 3, 2, 1]	[5, 3, 2, 1]	[5, 4, 2, 1]	[5, 3, 2, 1]	[5, 3, 2]
A♭ (G#)	[5, 3, 1]	[5, 3, 1]	[5, 4, 2, 1]	[5, 4, 2, 1]	[5, 3, 2, 1]	[5, 4, 2, 1]	[5, 4, 2, 1]	[5, 3, 2]
A	[5, 3, 1]	[5, 3, 1]	[5, 4, 2, 1]	[5, 4, 2, 1]	*	[5, 4, 2, 1]	[5, 4, 2, 1]	[5, 3, 2]
B♭ (A#)	[5, 3, 1]	[5, 3, 1]	[5, 4, 2, 1]	[5, 4, 2, 1]	*	[5, 4, 2, 1]	[5, 4, 2, 1]	[5, 3, 2]
B	[5, 2, 1]	[5, 2, 1]	[5, 3, 2, 1]	[5, 3, 2, 1]	*	[5, 3, 2, 1]	[5, 4, 2, 1]	[5, 3, 2]

Chords marked with asterisk (*) cannot be played in the Fingered Mode on this keyboard.

En este teclado, los acordes marcados con asterisco (*) no pueden ejecutarse en el modo de digitación.

Chord Root Type	aug	sus4	7 sus4	m add9	m M7	7-5	add9
C	[5, 3, 1]	[5, 2, 1]	[5, 3, 2, 1]	[4, 3, 2, 1]	[5, 3, 2, 1]	[5, 3, 2, 1]	[4, 3, 2, 1]
C# (Db)	[5, 3, 1]	[5, 2, 1]	[5, 3, 2, 1]	[4, 3, 2, 1]	[5, 3, 2, 1]	[5, 3, 2, 1]	[4, 3, 2, 1]
D	[5, 3, 1]	[5, 2, 1]	[5, 3, 2, 1]	[4, 3, 2, 1]	[5, 3, 2, 1]	[5, 3, 2, 1]	[4, 3, 2, 1]
Eb (D#)	[5, 3, 1]	[5, 2, 1]	[5, 3, 2, 1]	[4, 3, 2, 1]	[5, 3, 2, 1]	[5, 3, 2, 1]	[4, 3, 2, 1]
E	[5, 3, 1]	[5, 2, 1]	[5, 3, 2, 1]	[4, 3, 2, 1]	[5, 3, 2, 1]	[5, 3, 2, 1]	[4, 3, 2, 1]
F	[5, 3, 1]	[5, 2, 1]	[5, 3, 2, 1]	[4, 3, 2, 1]	[5, 3, 2, 1]	[5, 3, 2, 1]	[4, 3, 2, 1]
F# (Gb)	[5, 3, 1]	[5, 2, 1]	[5, 3, 2, 1]	[4, 3, 2, 1]	[5, 3, 2, 1]	[5, 3, 2, 1]	[4, 3, 2, 1]
G	[5, 3, 1]	[5, 2, 1]	[5, 3, 2, 1]	[4, 3, 2, 1]	[5, 4, 2, 1]	[5, 3, 2, 1]	[4, 3, 2, 1]
Ab (G#)	[5, 3, 1]	[5, 2, 1]	[5, 4, 2, 1]	[4, 3, 2, 1]	[5, 4, 2, 1]	[5, 4, 2, 1]	[4, 3, 2, 1]
A	[5, 3, 1]	[5, 2, 1]	[5, 4, 2, 1]	[4, 3, 2, 1]	[5, 4, 2, 1]	[5, 4, 2, 1]	[4, 3, 2, 1]
Bb (A#)	*	[5, 2, 1]	[5, 4, 2, 1]	[4, 3, 2, 1]	[5, 4, 2, 1]	[5, 4, 2, 1]	[4, 3, 2, 1]
B	*	[5, 2, 1]	[5, 3, 2, 1]	[5, 3, 2, 1]	[5, 3, 2, 1]	[4, 3, 2, 1]	[5, 3, 2, 1]

Percussion Instrument List

Lista de instrumentos de percusión

- PERCUSSION (tone 99) assigns 39 percussion sound to the keyboard as illustrated below. The sound assigned to each key are indicated above the keyboard.
- PERCUSSION (sonido 99) asigna 39 sonidos de percusión al teclado como se ilustra debajo. Los sonidos asignados a cada tecla se indican sobre el teclado.

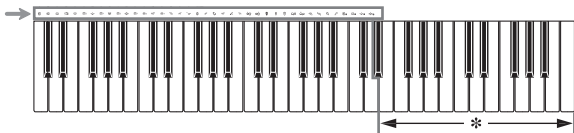

* No sound is produced when the keys in this range are pressed.

* Cuando se presionan las teclas en esta gama no se produce ningún sonido.

BASS DRUM	OPEN HI-HAT	COWBELL	LOW TIMBALE
SIDE STICK	MID TOM 1	CRASH CYMBAL 2	HIGH AGOGO
ACOUSTIC SNARE	HIGH TOM 2	CLAVES	LOW AGOGO
HAND CLAP	CRASH CYMBAL 1	RIDE CYMBAL 2	CABASA
ELECTRIC SNARE	HIGH TOM 1	RIDE CYMBAL 1	MARACAS
LOW TOM 2	RIDE CYMBAL 1	CHINESE CYMBAL	VOICE BASS DRUM
CLOSED HI-HAT	RIDE BELL	TAMBOURINE	VOICE SNARE
LOW TOM 1	SPLASH CYMBAL	MUTE HIGH CONGA	VOICE CLOSED HI-HAT
PEDAL HI-HAT		OPEN HIGH CONGA	VOICE OPEN HI-HAT
MID TOM 2		LOW CONGA	
		HIGH CONGA	
		HIGH TIMBALE	

Rhythm List**Lista de ritmos**

POPS I	JAZZ/FUSION	LATIN
00 CLUB POP	40 BIG BAND	70 BOSSA NOVA
01 VOCAL POP	41 SLOW SWING	71 SAMBA
02 RAP POP	42 SWING	72 MAMBO
03 FUNKY POP 1	43 FOX TROT	73 RHUMBA
04 SOUL BALLAD	44 JAZZ WALTZ	74 CHA-CHA-CHA
05 POP BALLAD	45 MODERN JAZZ	75 MERENGUE
06 LOVE BALLAD	46 COOL	76 REGGAE
07 FUNKY POP 2	47 HARD BOP	77 BOLERO
08 EPIC BALLAD	48 ACID JAZZ	78 TANGO 2
09 LITE POP	49 LATIN FUSION	79 LAMBADA
POPS II	DANCE/FUNK	80 PUNTA
10 16 BEAT SHFL	50 VOCAL GROOVE	81 CUMBIA
11 16 BEAT POP	51 RAVE	82 SKA
12 16 BEAT FUNK	52 CLUB GROOVE	83 TEX-MEX
13 8 BEAT POP	53 TECHNO	84 SALSA
14 8 BEAT SOUL	54 TRANCE	85 FOLKLORE
15 8 BEAT SHFL	55 HOUSE	86 PASODOBLE
16 DANCE POP 1	56 GROOVE SOUL	87 RUMBA CATALANA
17 DANCE POP 2	57 DISCO	88 SEVILLANA
18 POP FUSION	58 RAP	VARIOUS
19 FOLKIE POP	59 FUNK	89 FOLK
ROCK	EUROPEAN	90 COUNTRY
20 ROCK WALTZ	60 POLKA 1	91 BLUEGRASS
21 SLOW ROCK 1	61 POLKA 2	92 TOWNSHIP
22 SLOW ROCK 2	62 MARCH 1	93 FAST GOSPEL
23 SOFT ROCK 1	63 MARCH 2	94 SLOW GOSPEL
24 SOFT ROCK 2	64 WALTZ	95 ADANI
25 SOFT ROCK 3	65 VIENNESE WALTZ	96 BALADI
26 POP ROCK 1	66 FRENCH WALTZ	97 BAROQUE
27 POP ROCK 2	67 SLOW WALTZ	98 ENKA
28 50'S ROCK	68 SERENADE	99 NEW AGE
29 60'S SOUL	69 TANGO 1	
30 4 BEAT ROCK		
31 ROCK		
32 HEAVY ROCK		
33 8 BEAT ROCK		
34 STRAIGHT ROCK		
35 HEAVY METAL		
36 TWIST		
37 NEW ORLNS R&R		
38 CHICAGO BLUES		
39 R&B		

Song List / Lista de canciones

SONG BANK / BANCO DE CANCIONES

00	JUPITER FROM "THE PLANETS"	34	MY WILD IRISH ROSE	72	LA DONNA É MOBILE FROM "RIGOLETTE"
01	DECK THE HALL	35	DOWN IN THE VALLEY	73	POLKA FROM "THE BARTERED BRIDE"
02	WE WISH YOU A MERRY CHRISTMAS	36	SHE WORE A YELLOW RIBBON	74	CHANSON DU TOREADOR FROM "CARMEN"
03	JINGLE BELLS	37	HOUSE OF THE RISING SUN	75	HABANERA FROM "CARMEN"
04	SILENT NIGHT	38	AURA LEE	76	PRELUDE FROM "L'ARLÉSIENNE"
05	JOY TO THE WORLD	39	WHEN JOHNNY COMES MARCHING HOME	77	LE CYGNE FROM "LE CARNAVAL DES ANIMAUX"
06	O CHRISTMAS TREE	40	CAMPTOWN RACES	78	MARCH FROM "THE NUTCRACKER"
07	WHEN THE SAINTS GO MARCHING IN	41	SWANEE RIVER (OLD FOLKS AT HOME)	79	SCENE FROM "SWAN LAKE"
08	GREENSLEEVES	42	JEANNIE WITH THE LIGHT BROWN HAIR	80	THAIS MEDITATION
09	AMAZING GRACE	43	YANKEE DOODLE	81	MINUET IN G MAJOR
10	JOSHUA FOUGHT THE BATTLE OF JERICHO	44	RED RIVER VALLEY	82	JESUS BLEIBET MEINE FREUDE
11	AULD LANG SYNE	45	MY OLD KENTUCKY HOME	83	GAVOTTE (GOSSEC)
12	TWINKLE TWINKLE LITTLE STAR	46	HOME ON THE RANGE	84	CANON (PACHELBEL)
13	LIGHTLY ROW	47	OH! SUSANNA	85	LARGO (HÄNDEL)
14	ACH DU LIEBER AUGUSTIN	48	BEAUTIFUL DREAMER	86	CHOPSTICKS
15	LONDON BRIDGE	49	TURKEY IN THE STRAW	87	AMERICAN PATROL
16	J'AI PERDU LE DO DE MA CLARINETTE	50	ALOHA OE	88	THE ENTERTAINER
17	SUR LE PONT D'AVIGNON	51	JAMAICA FAREWELL	89	GOING HOME FROM "FROM THE NEW WORLD"
18	GRANDFATHER'S CLOCK	52	HOLDIRIDIA	90	FRÖHLICHER LANDMANN
19	I'VE BEEN WORKING ON THE RAILROAD	53	SANTA LUCIA	91	PIANO SONATA op.13 "PATHÉTIQUE" 2nd Mov.
20	LITTLE BROWN JUG	54	LA CUCARACHA	92	FÜR ELISE
21	LONG LONG AGO	55	LA PALOMA	93	TURKISH MARCH (MOZART)
22	MICHAEL ROW THE BOAT ASHORE	56	CIELITO LINDO	94	PIANO SONATA K.545 1st Mov.
23	THE NOBLE DUKE OF YORK	57	TROIKA	95	WEDDING MARCH FROM "MIDSUMMER NIGHT'S DREAM"
24	SIPPIN' CIDER THROUGH A STRAW	58	SZLA DZIEWECZKA	96	HUNGARIAN DANCES no.5
25	UNDER THE SPREADING CHESTNUT TREE	59	WALTZING MATILDA	97	NOCTURNE op.9-2 (CHOPIN)
26	SUMM SUMM SUMM	60	AJO MAMMA	98	ETUDE op.10-3 "CHANSON DE L'ADIEU"
27	THE MUFFIN MAN	61	RASA SAYANG	99	VALSE op.64-1 "PETIT CHIEN"
28	ANNIE LAURIE	62	SAKURA SAKURA		
29	DANNY BOY	63	AIR FROM "SUITE no.3"		
30	MY BONNIE	64	SPRING FROM "THE FOUR SEASONS"		
31	IF YOU'RE HAPPY AND YOU KNOW IT, CLAP YOUR HANDS	65	TOY SYMPHONY		
32	MY DARLING CLEMENTINE	66	SYMPHONY no.101 "CLOCK" 2nd Mov.		
33	HOME SWEET HOME	67	SERENADE FROM "EINE KLEINE NACHTMUSIK"		
		68	ODE TO JOY		
		69	BRIDAL MARCH FROM "LOHENGRIN"		
		70	TRIUMPHAL MARCH FROM "AIDA"		
		71	BRINDISI FROM "LA TRAVIATA"		



This recycle mark indicates that the packaging conforms to the environmental protection legislation in Germany.

Esta marca de reciclaje indica que el empaquetado se ajusta a la legislación de protección ambiental en Alemania.

CASIO®

CASIO COMPUTER CO.,LTD.
6-2, Hon-machi 1-chome
Shibuya-ku, Tokyo 151-8543, Japan



MA1004-A Printed in China
CTK1100ES1A

Free Manuals Download Website

<http://myh66.com>

<http://usermanuals.us>

<http://www.somanuals.com>

<http://www.4manuals.cc>

<http://www.manual-lib.com>

<http://www.404manual.com>

<http://www.luxmanual.com>

<http://aubethermostatmanual.com>

Golf course search by state

<http://golfingnear.com>

Email search by domain

<http://emailbydomain.com>

Auto manuals search

<http://auto.somanuals.com>

TV manuals search

<http://tv.somanuals.com>