

WK-1800 WK-1630 WK-1600

USER'S GUIDE

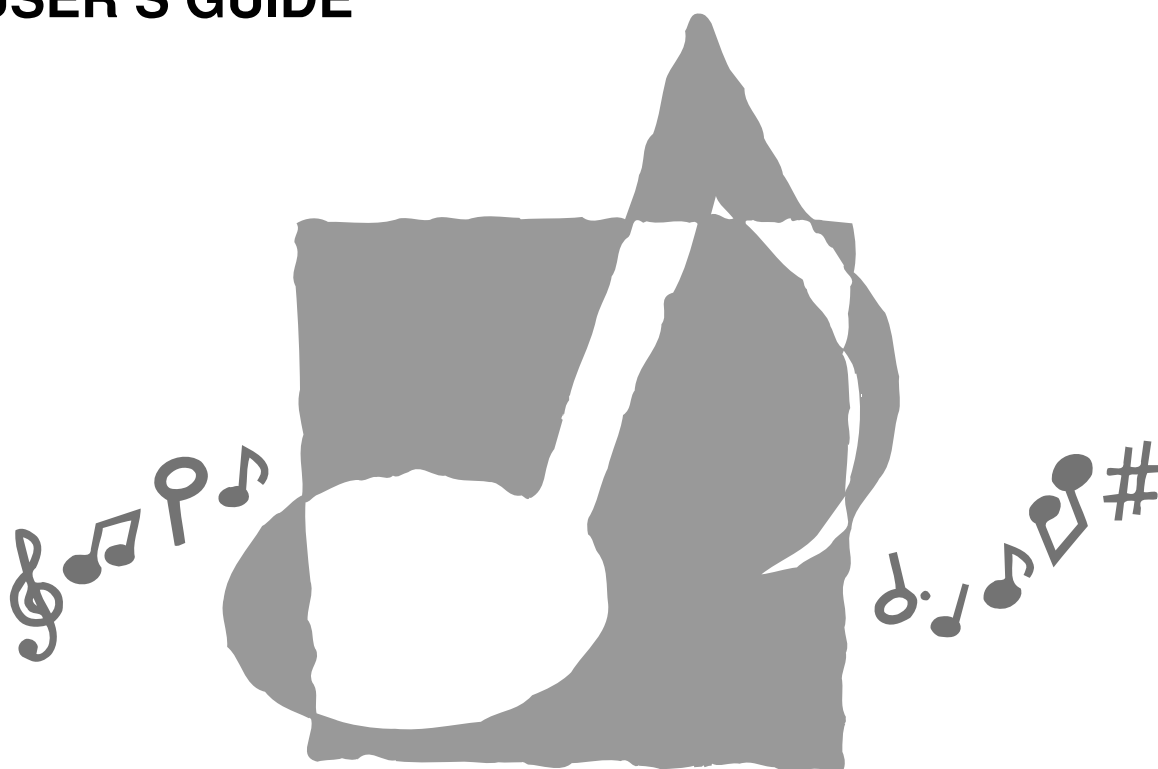

P



WK1800-E-1

CASIO®

GUIDELINES LAID DOWN BY FCC RULES FOR USE OF THE UNIT IN THE U.S.A. (not applicable to other areas).

NOTICE

This equipment has been tested and found to comply with the limits for a Class B digital device, pursuant to Part 15 of the FCC Rules. These limits are designed to provide reasonable protection against harmful interference in a residential installation. This equipment generates, uses and can radiate radio frequency energy and, if not installed and used in accordance with the instructions, may cause harmful interference to radio communications. However, there is no guarantee that interference will not occur in a particular installation. If this equipment does cause harmful interference to radio or television reception, which can be determined by turning the equipment off and on, the user is encouraged to try to correct the interference by one or more of the following measures:

- Reorient or relocate the receiving antenna.
- Increase the separation between the equipment and receiver.
- Connect the equipment into an outlet on a circuit different from that to which the receiver is connected.
- Consult the dealer or an experienced radio/TV technician for help.

FCC WARNING

Changes or modifications not expressly approved by the party responsible for compliance could void the user's authority to operate the equipment.

Welcome...

To the happy family of satisfied CASIO electronic musical instrument owners! To get the most out of the many features and functions of the keyboard, be sure to carefully read this manual and keep it on hand for future reference.

Important!

When using batteries, be sure to replace them or shift to one of the alternate power sources whenever you notice any of the following symptoms.

- Dim power supply indicator
- Instrument does not turn on
- Display that is flickering, dim, or difficult to read
- Abnormally low speaker/headphone volume
- Distortion of sound output
- Occasional interruption of sound when playing at high volumes
- Sudden power failure when playing at high volumes
- Flickering or dimming of the display when playing at high volume
- Continued sound output even after you release a key
- A totally different tone may sound
- Abnormal rhythm pattern and demo tune play
- Loss of power, sound distortion, or low volume when playing from a connected computer or MIDI device
- Sudden power failure while reading from or writing to a diskette (WK-1800 only)



CASIO ELECTRONICS CO., LTD.
Unit 6, 1000
North Circular Road
London NW2 7JD, U.K.

This mark is valid in the EU countries only.
Please keep all information for future reference.

Safety Precautions

Symbols

Various symbols are used in this operating manual and on the product itself to ensure that the product is used safely and correctly, and to prevent injury to the user and other persons as well as damage to property. Those symbols along with their meanings are shown below.

WARNING

This indication stipulates matters that have the risk of causing death or serious injury if the product is operated incorrectly while ignoring this indication.

CAUTION

This indication stipulates matters that have the risk of causing injury as well as matters for which there is the likelihood of occurrence of physical damage only if the product is operated incorrectly while ignoring this indication.

Symbol Examples



This triangle symbol () means that the user should be careful. (The example at left indicates electrical shock caution.)



This circle with a line through it () means that the indicated action must not be performed. Indications within or nearby this symbol are specifically prohibited. (The example at left indicates that disassembly is prohibited.)



The black dot () means that the indicated action must be performed. Indications within this symbol are actions that are specifically instructed to be performed. (The example at left indicates that the power plug must be unplugged from the electrical socket.)

WARNING

Please use caution regarding the handling of the AC adaptor.

- Do not use a voltage other than the indicated power supply voltage. Use of a voltage other than that indicated may cause fire or electrical shock.
- If the power cord should become damaged (exposed wires, disconnection, etc.), purchase a new AC adaptor. Use of a damaged power cord may cause fire or electrical shock.

- Do not cut or damage the power cord. Also do not place heavy objects on top of it or subject it to excessive heat. Damage to the power cord may cause fire or electrical shock.
- Do not attempt to shape the power cord or subject it to excessive bending, twisting or pulling. This may cause fire or electrical shock.
- Please use the adaptor specified for this instrument. Use of another adaptor may cause fire, electrical shock, or malfunction.



Do not locate the instrument or its stand on an uneven or unstable surface.

- Locating the instrument or its stand on an uneven or unstable surface can cause it to fall, creating the danger of personal injury.

Do not place containers containing water or other liquids on the instrument.

- Do not place the following objects on the instrument. Placing such objects on the instrument may cause fire or electrical shock if they spill and get inside the instrument.



- Containers filled with water or other liquids (including vases, potted plants, cups, cosmetics and medicines)
- Small metal objects (including hairpins, sewing needles and coins)
- Flammable objects



In the event a foreign object should happen to get inside the instrument, please take the following actions:

1. Turn power off.
2. Unplug the AC adaptor from the wall outlet.
3. If there are any batteries loaded in the keyboard, remove them.
- Do not touch the batteries directly with your hands when removing them. They may be hot or battery fluid may be leaking from them.
4. Consult with the dealer where you purchased the keyboard or with an authorized CASIO service provider.



Do not disassemble or modify the instrument.

- Never attempt of take apart or modify the instrument, its accessories, or separately sold options. Doing so may cause fire, electrical shock or malfunction. Consult your dealer concerning all inspection, adjustment or repair of internal components.



Do not use if there is an abnormality or malfunction.

- Do not use the instrument if there appear to be abnormalities such as the presence of smoke or abnormal odor. Also do not use the instrument if there appear to be malfunctions such as the power not coming on or sound not being produced. Use under such conditions may cause fire or electrical shock. In such cases, take the following actions immediately. Never attempt to repair the instrument yourself.



1. Turn power off.
 2. Unplug the AC adaptor from the wall outlet.
 3. If there are any batteries loaded in the keyboard, remove them.
- Do not touch the batteries directly with your hands when removing them. They may be hot or battery fluid may be leaking from them.
4. Consult with the dealer where you purchased the keyboard or with an authorized CASIO service provider.



When the instrument has been dropped:

- In the case the instrument has been dropped or damaged, take the following actions. Continued use may cause fire or electrical shock.



1. Turn power off.
 2. Unplug the AC adaptor from the wall outlet.
 3. If there are any batteries loaded in the keyboard, remove them.
- Do not touch the batteries directly with your hands when removing them. They may be hot or battery fluid may be leaking from them.
4. Consult with the dealer where you purchased the keyboard or with an authorized CASIO service provider.



Be careful of the bags around children.

- Never allow anyone to place the plastic bags of the instrument, its accessories, and its separately sold options over their heads. Doing so may cause suffocation. Particular caution is required in homes with small children.

CAUTION

AC Adaptor

- Do not locate the power cord in close proximity to heaters or other heating appliances. This may cause the cord to melt leading to possible fire or electrical shock.
- When unplugging the AC adaptor from an electrical outlet, always make sure to pull on the adaptor itself and not the cord. Pulling excessively on the cord may cause it to be damaged or break leading to possible fire or electrical shock.
- Do not touch the AC adaptor with wet hands when it is plugged in. This may cause electrical shock.
- When not using the instrument for an extended period such as when traveling, always make sure to unplug the AC adaptor from the electrical outlet for safety reasons.
- After use turn off the power switch of the instrument and unplug the AC adaptor from the electrical outlet.
- At least once a year, unplug the AC adaptor from the power outlet and clean the area around the prongs of the plug. Dust build up around the prongs can create the danger of fire.



Batteries

- Improper battery use may cause batteries to rupture and leak. This may cause injury, malfunction of the instrument or discoloration of furniture and other articles that come into contact with battery fluid. Take care to observe the following.
- Install batteries so their polarity (+/-) matches that indicated on the instrument.
- For safety and to prevent possible leakage of battery fluid, always make sure to remove batteries from the instrument when you do not plan to use it for a long time.
- Always make sure that the batteries making up a set are all of the same type.
- Never combine new batteries with old ones.
- Never dispose of batteries by incinerating them. Never short or disassemble batteries, and do not expose them to excessive heat.
- Replace dead batteries as soon as possible.
- Never attempt to recharge batteries.

Transport

- When transporting the instrument, always make sure to unplug the AC adaptor from the electrical outlet and confirm that all other external connections have been disconnected. Only then should the instrument be transported. If the above is not done, the cord may be damaged leading to possible fire or electrical shock.



Care

- Whenever caring, make sure to first unplug the AC adaptor from the electrical outlet. Also remove the instrument's batteries if battery power is being used.



Location

- Never locate the instrument in areas subject to high humidity or heavy accumulation of dust. Doing so may cause fire or electrical shock.
- Never locate the instrument in areas subject to grease splatters or steam, such as in a kitchen or near a humidifier. Doing so may cause fire or electrical shock.



Do not place keyboard on lacquered furniture.

- The instrument's silicone rubber feet may eventually blacken or scar lacquered surfaces. Use felt cloth pads to insulate the feet or preferably use a CASIO musical instrument stand designed for your keyboard.

Do not place heavy objects on the instrument.

- Do not place heavy objects on the instrument. This may cause the instrument to tip over or break resulting in injury.

Volume

- Very high volume levels can damage hearing. Avoid using the instrument at very high volume settings for long periods. Consult with a physician immediately if you experience impaired hearing or ringing in the ears.

Liquid Crystal Display (LCD) Precautions

- Avoid subjecting the keyboard's LCD to strong impact, which can crack or break the LCD's glass creating the danger of personal injury.
- Should the LCD glass ever crack or break, do not allow the liquid inside the LCD to come into contact with your skin, which can cause inflammation and reddening.
 - *Should the LCD liquid get into your mouth, immediately wash out your mouth with water and then consult a physician.
 - *Should the LCD liquid get in your eyes or on your skin, immediately flush with water for at least 15 minutes and then consult a physician.

Do not get onto the instrument or stand.*

- Do not crawl on top of the instrument or its optional stand. Particular caution is required in homes having small children. This may cause the instrument or stand to tip over and break resulting in injury.

Optional Stand*

- Carefully assemble the stand following the assembly instructions that come with it. Securely tighten all bolts, nuts, and fasteners, and make sure that you mount the instrument correctly onto the stand. Incorrectly or insufficiently tightening screws, or incorrectly mounting the instrument onto the stand can cause the stand to tip over or the instrument to fall off the stand, possibly leading to injury.

* The stand is available as an option.

E-4

Care of your keyboard

Avoid strong impact and rough handling.

Your keyboard is made of precision components that can malfunction when subjected to strong impact and rough handling.

Avoid heat, humidity or direct sunlight.

Do not overexpose the instrument to direct sunlight, or place it near an air conditioner, or in any extremely hot place.

Do not use near a TV or radio.

This instrument can cause video or audio interference with TV and radio reception. If this happens, move the instrument away from the TV or radio.

Do not use lacquer, thinner or similar chemicals for cleaning.

Clean the keyboard with a soft cloth dampened in a weak solution of water and a neutral detergent. Soak the cloth in the solution and squeeze until it is almost dry.

Avoid use in areas subjected to temperature extremes.

Extremely high or low temperature can cause figures on the LCD screen to become dim and difficult to read. This condition should correct itself when the keyboard is brought back to normal temperature.

Lithium Battery Precautions

The keyboard comes with a built-in lithium battery that supplies power to the memory to retain Song Sequencer, Pattern Sequencer and other data while keyboard power is turned off. If the power of the lithium battery is low, turning off keyboard power can result in deletion of all data stored in its memory.

The normal life of the original battery is five years from the time it is loaded at the factory. Due to time spent in transit and storage, the original battery probably will not provide a full five years of service life. It is up to you to contact your nearest CASIO service provider about having the lithium battery replaced periodically.

* CASIO COMPUTER CO., LTD. shall not be held responsible for any losses to you or any third party due to loss or corruption of data caused by malfunction or repair of this keyboard, or by battery replacement.

NOTE

You may notice lines in the finish of the case of this keyboard. These lines are a result of the molding process used to shape the plastic of the case. They are not cracks or breaks in the plastic, and are no cause for concern.



Main Features

Song Sequencer

A built-in six-track sequencer gives you full control over the tone, volume, pan position, and other parameters for each recorded track. Use in combination with Auto Accompaniment, the Song Sequencer provides you with all the tools you need to create your own full-fledged ensembles.

Pattern Sequencer

Alter any of the 120 built-in rhythm patterns to create your own, original patterns. You can even store up to 10 of your patterns in memory for later recall.

130 rhythms

120 built-in rhythms include rock, pops, jazz, and other rhythms specially arranged for piano accompaniment. You can even store up to 10 of your own rhythm patterns in memory for later recall.

Auto Accompaniment

Simply play a chord and the corresponding rhythm, bass, and chords parts play along automatically. One Touch Presets instantly recalls the most suitable tone and tempo settings to match the rhythm you are using, while Free Session automatically produces pre-programmed chord progressions so you can play ensembles with yourself.

232 tones

Choose from among a versatile collection of 200 built-in orchestra tones, synthesized sounds, drum sets and more. You can even store up to 32 of your own original sound creations in memory for instant recall when you need them.

Synthesizer

Change the parameters of any of the built-in sounds to produce your own original creations. Up to 32 of original sounds can be stored in memory for later recall.

General MIDI compatibility

General MIDI compatible tones let you connect to a personal computer for quick and easy "desktop music" capabilities. This keyboard can be used as a desktop music input device or sound source.

Mixer

You can specify tone, volume, pan position, and other parameters for each built-in Auto Accompaniment part and each track recorded with the Pattern Sequencer or Song Sequencer. You can also control the same parameters for each channel during MIDI input.

Registration Memory

Keyboard setups can be stored in memory for later recall and instant settings whenever you need them. Up to 20 setups (5 setups x 4 banks) can be stored in registration memory.

DSP Effects

10 DSP effects such as reverb and chorus come built in.

Built-in floppy disk drive (WK-1800 only)

Save original tones and rhythms, or songs you created with the Song Sequencer to disk for long-term storage. You can also load a disk with a standard MIDI file (SMF) and play it back on the keyboard.

Contents

Welcome..... E-1

Safety Precautions E-2

Care of your keyboard E-4

Main Features E-5

Contents..... E-6

General Guide..... E-8

About the Display E-10

Connections..... E-12

Phones and Line Out Terminals E-12

Phones/Output Terminal E-12

Sustain/Assignable Jack Terminal E-13

Accessories and Options E-13

Power Supply..... E-14

Using Batteries E-14

Using the AC Adaptor E-14

Auto Power Off..... E-15

Settings and Memory Contents E-15

Basic Operations E-16

Getting Started..... E-16

Selecting a Tone E-16

Using Layer..... E-17

Using Split..... E-17

Using Layer and Split Together E-18

Using Touch Response E-18

Transposing the Keyboard..... E-19

Tuning the Keyboard E-19

Using DSP Effects E-19

Tuning DSP Effects On and Off E-20

Using the PITCH BEND Wheel E-20

Using the MODULATION Wheel..... E-20

Auto Accompaniment E-21

About the MODE Button E-21

Selecting a Rhythm..... E-21

Playing a Rhythm..... E-21

Adjusting the Tempo E-22

Using Auto Accompaniment E-22

Using an Intro Pattern E-24

Using a Fill-in Pattern E-24

Using Variation Rhythm Patterns..... E-25

Synchro Starting Accompaniment with
Rhythm Play E-25

Finishing with an Ending Pattern E-25

Using Auto Harmonize E-25

Using One-touch Preset E-26

Using Free Session E-26

Turning Auto Accompaniment Parts On
and Off E-27

Adjusting the Accompaniment Volume E-27

Mixer Function E-28

Mixer Features E-28

Mixer Modes E-28

Turning Channels On and Off..... E-29

Changing the Parameters of a Channel .. E-30

Synthesizer Mode E-32

Synthesizer Functions E-32

Creating a User Tone E-34

Naming a User Tone and Storing It In
Memory E-35

Registration Memory..... E-37

Registration Memory Features E-37

To Save a Setup in Registration Memory ...	E-38
To Recall a Setup from Registration Memory	E-38

Using the Song Sequencer..... E-39

Songs and Tracks	E-39
Recording	E-39
Global Settings and Operations	E-39
Song Sequencer Data	E-39
Song Sequencer Memory Capacity	E-40
Song Sequencer Memory Precautions	E-40
Song Sequencer Modes	E-40
Real-time Recording	E-40
Punch-in Recording	E-42
To Delete the Contents of a Specific Track	E-44
Playing Back from Song Sequencer Memory	E-45
Song Sequencer and Mixer Operations	E-45
Global Settings and Operations	E-45

Pattern Sequencer..... E-48

Pattern Sequencer Basics	E-48
Using the Pattern Create Mode	E-50
Using the Pattern Edit Mode	E-52
Exiting the Pattern Sequencer Mode	E-56

Keyboard Settings..... E-58

Using the Keyboard Settings Menu	E-58
Setting Screens	E-59

MIDI..... E-60

What is MIDI?	E-60
General MIDI	E-60
Making MIDI Settings.....	E-61
MIDI Messages	E-62
MIDI Functions and Mixer Functions	E-64
Bulk Sending Keyboard Data	E-65

Using the Floppy Disk Drive (WK-1800 Only)..... E-67

Floppy Disk Drive Features	E-67
About Floppy Diskettes	E-67
Basic Diskette Operation	E-68
Playing Back an SMF	E-69
Saving and Recalling Memory Data	E-70
Using the Utilities	E-71
Disk Drive Error Messages	E-74

Troubleshooting E-75

Specifications E-77

Appendix A-1

Note Table	A-1
Free Session Chord Progression Chart	A-2
Drum Assignment List	A-5
Fingered Chord Chart	A-6
Chord Conversion Table	A-8

MIDI Implementation Chart

General Guide

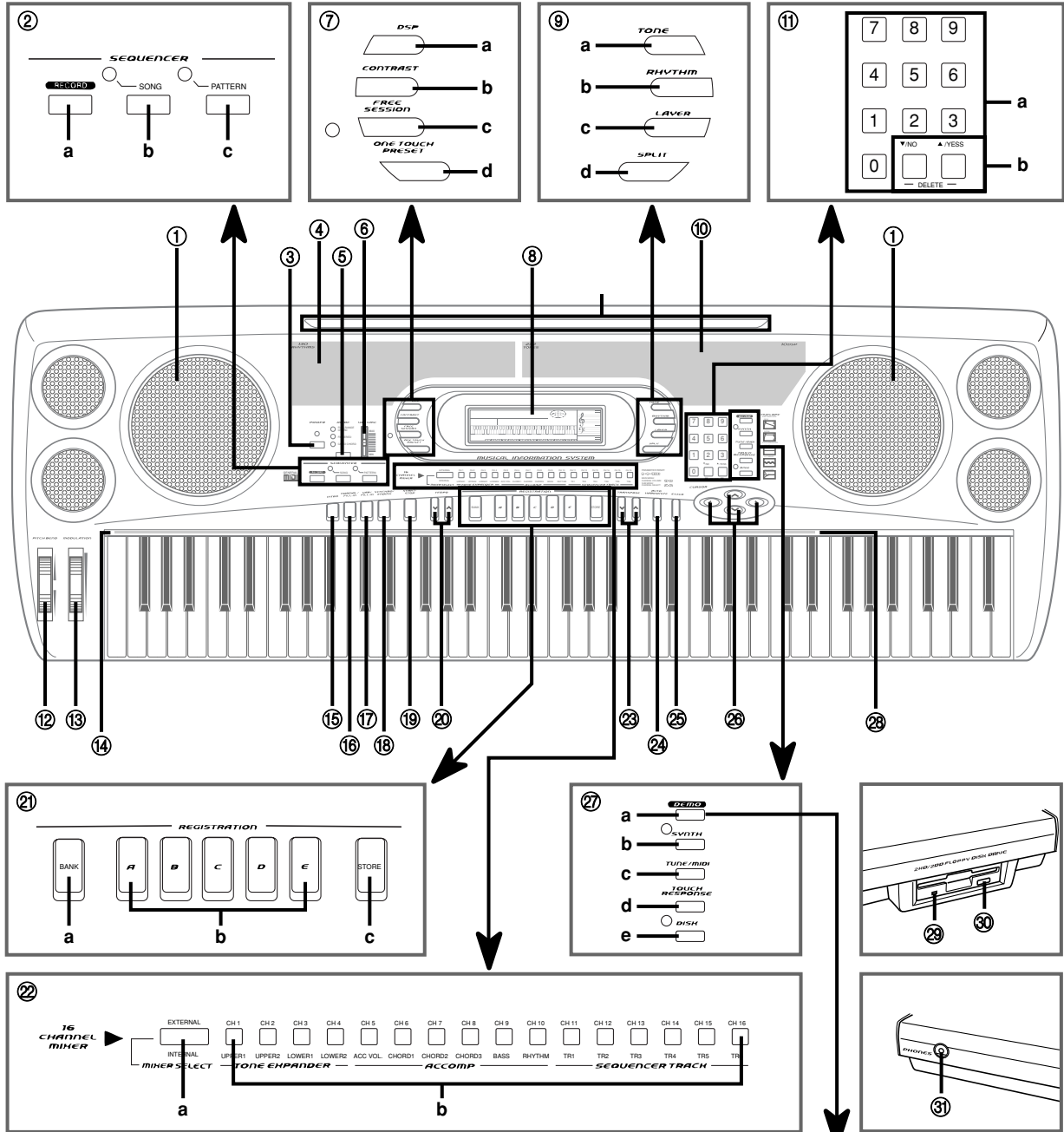

Playing a Demo Tune

Pressing the DEMO button starts demo tune play. There are two demo tunes, which continuously play in sequence. To stop demo tune play, press either the DEMO button or the START/STOP button.

NOTES

- Pressing the [+]/[-] keys skips to the next demo tune.
- You can select a tone for the keyboard (page E-16) before starting demo tune play, and then use that tone to play along with the demo tune.
- MIDI are disabled while a demo tune is playing.
- Auto Harmonize, layer, split, and Auto Accompaniment Mode settings are automatically cancelled whenever demo tune is playing. These settings are restored after demo tune play is complete.

- Key, button, and other names are indicated in the text of this manual using bold type.
- Illustrations in this User's Guide shows the WK-1800.

- ① Speakers
- ② Sequencer
 - (a) RECORD button
 - (b) SONG button
 - (c) PATTERN button
- ③ POWER button
- ④ Rhythm list
- ⑤ MODE button
- ⑥ MAIN VOLUME slider
- ⑦ (a) DSP (digital effect) button
 - (b) CONTRAST button
 - (c) FREE SESSION button
 - (d) ONE TOUCH PRESET button
- ⑧ Display
- ⑨ (a) TONE button
 - (b) RHYTHM button
 - (c) LAYER button
 - (d) SPLIT button
- ⑩ Tone list
- ⑪ (a) Number keys
 - (b) [+]/[-] keys (YES/NO keys)
- ⑫ PITCH BEND wheel
- ⑬ MODULATION wheel
- ⑭ CHORD name
- ⑮ INTRO button
- ⑯ NORMAL/FILL-IN button
- ⑰ VARIATION/FILL-IN button
- ⑱ SYNCHRO/ENDING button
- ⑲ START/STOP button
- ⑳ TEMPO buttons
- ㉑ (a) BANK button
 - (b) REGISTRATION buttons (A to E)
 - (c) STORE button
- ㉒ (a) MIXER SELECT button
 - (b) CHANNEL buttons (CH1 to CH16)
- ㉓ TRANSPOSE button
- ㉔ AUTO HARMONIZE button
- ㉕ ENTER button
- ㉖ Cursor keys
In this User's Guide, cursor key operations are indicated as: [◀], [▶], [▲], [▼].
- ㉗ •WK-1800
 - (a) DEMO button
 - (b) SYNTH button
 - (c) TUNE/MIDI button
 - (d) TOUCH RESPONSE button
 - (e) DISK button
- WK-1600/1630
 - (a) DEMO button
 - (b) SYNTH button
 - (c) TUNE button
 - (d) MIDI button
 - (e) TOUCH RESPONSE button
- ㉘ Percussion instrument indicators
- ㉙ Access lamp
- ㉚ Eject button
- ㉛ •WK-1800
PHONES terminal
- WK-1600/1630
PHONES/OUTPUT terminal

Rear Panel

• WK-1800

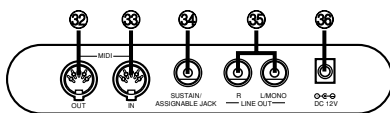

- ㉚ MIDI OUT terminal
- ㉛ MIDI IN terminal
- ㉜ SUSTAIN/ASSIGNABLE JACK terminal
- ㉝ LINE OUT R, LINE OUT L/MONO terminal
- ㉞ DC 12V terminal

• WK-1600/1630

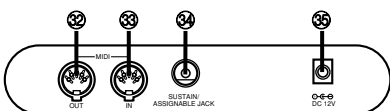

- ㉚ MIDI OUT terminal
- ㉛ MIDI IN terminal
- ㉜ SUSTAIN/ASSIGNABLE JACK terminal
- ㉝ DC 12V terminal

*Attaching the Score Stand

Insert the music stand into the slot in the top of the keyboard.

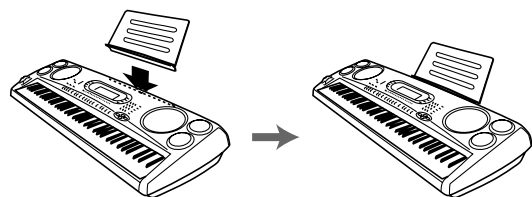

About the Display

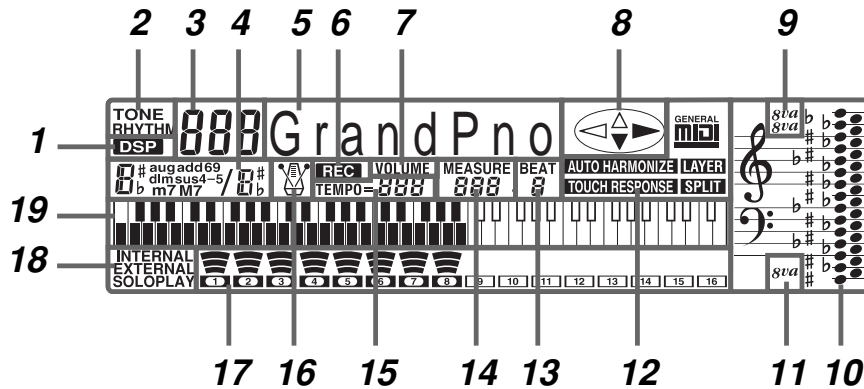

- 1** DSP indicator
Appears when a DSP effect is turned on.
- 2** TONE/RHYTHM indicator
TONE is shown during tone selection and display, while RHYTHM is shown during rhythm selection and display.
- 3** Tone/Rhythm number
Number of currently selected tone or rhythm. The TONE/RHYTHM indicator shows whether the number is a tone or rhythm. This display area also shows other information when you are using the Pattern Sequencer and Song Sequencer.
- 4** Chord name display
Shows chord names while Auto Accompaniment is being used.
- 5** Tone/Rhythm name
Name of currently selected tone or rhythm. The TONE/RHYTHM indicator shows whether the name is a tone or rhythm. This area also shows other information in other modes.
- 6** Record indicator
While the Song Sequencer or Pattern Sequencer is turned on, this indicator flashes to indicate record standby and remains on the display without flashing while recording is in progress.
- 7** VOLUME indicator
Appears when you are using the Mixer to change the volume parameter of a specific channel.
- 8** Cursor key indicators
Indicated keys are those that are operational for the function you are currently performing.
- 9** Octave symbol 1
One symbol indicates the note being produced by the keyboard is one octave higher than the note shown in the staff notation area **10**. Two symbols indicate two octaves higher.
- 10** Staff notation area
Notes you play on the keyboard, notes played back from memory, chord forms, and received MIDI data* are shown here.
- 11** Octave symbol 2
One symbol indicates the note being produced by the keyboard is one octave lower than the note shown in the staff notation area **10**.
- 12** Indicators
An indicator appears to indicate that a function (Layer, Auto Harmonize, Split, General MIDI Mode, Touch Response) is currently in use.
- 13** Beat number
Shows the beat number during rhythm and Auto Accompaniment play, and while the Song Sequencer or Pattern Sequencer is turned on.
- 14** Measure
Shows the measure number from the start of play during rhythm and Auto Accompaniment play, and while the Song Sequencer or Pattern Sequencer is turned on. In the Mixer Mode, displays the current channel's on/off status.
- 15** Tempo indicator
Shows the tempo as a value indicating the number of beats per minute during rhythm and Auto Accompaniment play, and while the Song Sequencer or Pattern Sequencer is turned on. This display area also shows other information in other modes.
- 16** Metronome
You can turn on the metronome to provide a reference beat for your keyboard play.
- 17** Level meter
The numbers 1 through 16 correspond to Mixer channels. The level meter indicates which channels are on and off, and also indicates the volume level.
- 18** Mixer mode indicator
Indicates the current Mixer mode (Internal, External, External/Solo, External/Play).
- 19** Graphic keyboard
Notes you play on the keyboard, notes played back from memory, and received MIDI data* are indicated on the graphic keyboard.

* Any receive data outside the range of E1 to G7 is not displayed.

■ NOTES ■

- Display examples shown in this User's Guide are intended for illustrative purposes only. The actual text and values that appear on the display may differ from the examples shown in this User's Guide.
- Backlight brightness may appear somewhat unstable immediately after the keyboard is turned on. This does not indicate malfunction, and brightness will stabilize after a few seconds.

The back lighting of the display is provided by a fluorescent light, which loses its brightness over very long periods of use. When this happens, contact your original dealer or a CASIO service provider about having the backlight replaced. Note that you will be charged for such replacement.

Adjusting Display Contrast

- Display contrast can be adjust to one of 100 levels for easy viewing.
- Adjusting display contrast helps to make figures easier to read from any viewing angle.
- Within five seconds after pressing the CONTRAST button, press [+] to increase the contrast value (making the display darker) or [-] to decrease it (making the display lighter).
- After you release CONTRAST, the message "Contrast" remains on the display for a few moments, during which you can change the contrast setting further using [+] and [-] or by inputting a contrast value with the number keys.

The contrast can be set to a value from 0 to 99. The initial default setting is 50.

Connections

• WK-1800

Phones and Line Out Terminals

Before connecting phones or other external equipment, be sure to first turn down the volume settings of the keyboard and the connected equipment. You can then adjust volume to the desired level after connections are complete.

[Front]

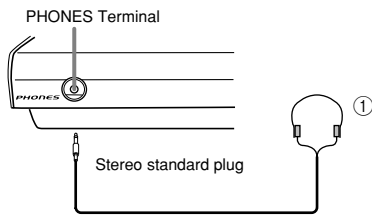

Connecting Phones (Figure ①)

Connecting phones cuts off output from the keyboard's built-in speakers, so you can play even late at night without disturbing anyone.

[Rear Panel]

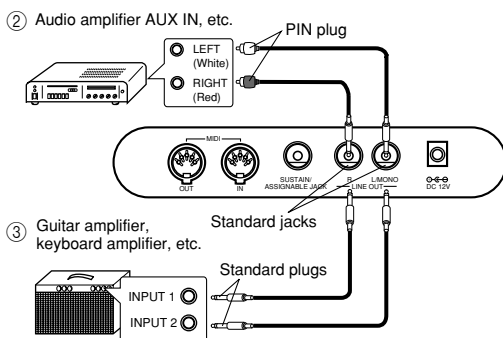

Connecting to Audio Equipment ②

Use commercially available cords to connect to the two jacks as shown in Figure ②. It is up to you to purchase connecting cables like the ones shown in the illustration for connection. Normally in this configuration, you must set the audio equipment's input selector to the setting that specifies the terminal (such as AUX IN) that the keyboard is connected to. Use the keyboard's VOLUME slider to adjust the volume level.

Connecting to a Musical Instrument Amplifier ③

Use commercially available cords to connect to the two jacks as shown in Figure ③. It is up to you to purchase connecting cables like the ones shown in the illustration for connection. Use the keyboard's VOLUME slider to adjust the volume level.

- If your amplifier has only one input jack, use an adapter like the one shown below.

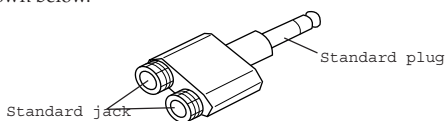

NOTE

You can also connect the keyboard's MIDI terminal to a computer or sequencer. See "MIDI" on page E-60 for details.

• WK-1600/1630

Phones/Output Terminal

Before connecting phones or other external equipment, be sure to first turn down the volume settings of the keyboard and the connected equipment. You can then adjust volume to the desired level after connections are complete.

[Front]

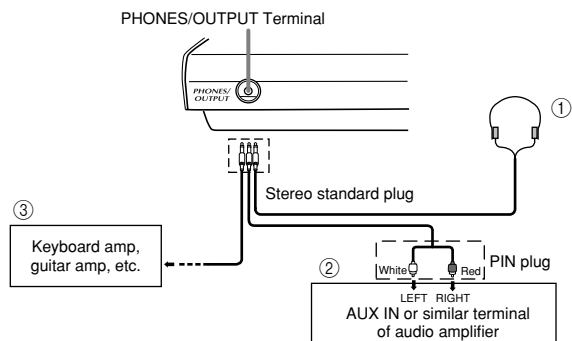

Connecting Phones (Figure ①)

Connecting phones cuts off output from the keyboard's built-in speakers, so you can play even late at night without disturbing anyone.

Audio Equipment (Figure ②)

Connect the keyboard to a audio equipment using a commercially available connecting cord with a standard plug on one end and two PIN plugs on the other end. Note that the standard plug you connect to the keyboard must be a stereo plug, otherwise you will be able to output only one of stereo channels. In this configuration, you normally set the input selector of the audio equipment to the terminal (usually marked AUX IN or something similar) where the cord from the keyboard is connected. See the user documentation that comes with your audio equipment for full details.

Musical Instrument Amplifier (Figure ③)

Use a commercially available connecting cord to connect the keyboard to a musical instrument amplifier.

NOTE

Be sure to use a connecting cord that has a stereo standard plug on the end you connect to the keyboard, and a connector that provides dual channel (left and right) input to the amplifier to which you are connecting. The wrong type of connector at either end can cause one of the stereo channels to be lost.

When connected to a musical instrument amplifier, set the volume of the keyboard to a relatively low level and make output volume adjustments using the amplifier's controls.

Connection Example

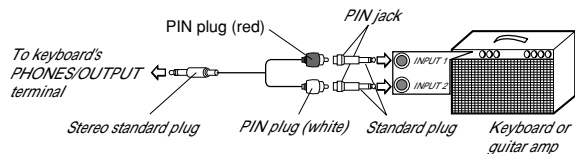

NOTE

You can also connect the keyboard's MIDI terminal to a computer or sequencer. See "MIDI" on page E-60 for details.

Sustain/Assignable Jack Terminal

You can connect an optional sustain pedal (SP-2 or SP-10) to the SUSTAIN/ASSIGNABLE JACK terminal to enable the capabilities described below.

For details on how to select the pedal function you want, see "Assignable Jack Function" on page E-59.

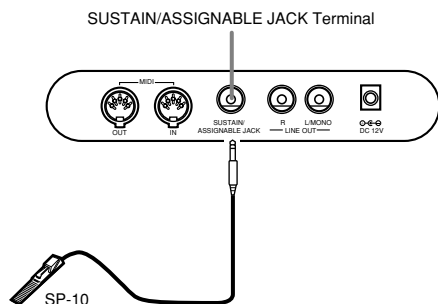

Sustain Pedal

- With piano tones, depressing the pedal causes notes to linger, much like a piano's damper pedal.
- With organ tones, depressing the pedal causes notes to continue to sound until the pedal is released.

Sostenuto Pedal

- As with the sustain pedal function described above, depressing the sostenuto pedal causes notes to be sustained.
- The difference between a sostenuto pedal and sustain pedal is the timing. With a sostenuto pedal, you press the keys and then depress the pedal before you release the keys. Only the notes that are sounding when the pedal is depressed are sustained.

Soft Pedal

Depressing the pedal softens the sound of the notes being played.

Rhythm Start/Stop Pedal

In this case, the pedal performs the same functions as the START/STOP button.

Accessories and Options

Use only the accessories and options specified for this keyboard. Use of non-authorized items creates the danger of fire, electrical shock, and personal injury.

Power Supply

This keyboard can be powered by current from a standard household wall outlet (using the specified AC adaptor) or by batteries. Always make sure you turn the keyboard off whenever you are not using it.

Using Batteries

Always make sure you turn off the keyboard before loading or replacing batteries.

To load batteries

1. Remove the battery compartment cover.

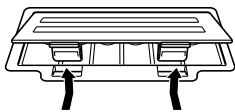

2. Load six D-size batteries into the battery compartment.
 - Make sure that the positive (+) and negative (-) ends are facing correctly.

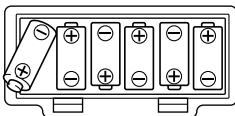

3. Insert the tabs on the battery compartment cover into the holes provided and close the cover.

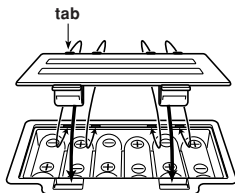

The keyboard may not function correctly if you load or replace batteries with power turned on. If this happens, turning the keyboard off and then back on again should return functions back to normal.

Important Battery Information

- The following shows the approximate battery life.
Alkaline batteries 2 hours
The above value is standard battery life at normal temperature, with the keyboard volume at medium setting. Temperature extremes or playing at very loud volume settings can shorten battery life.
- Any of the following symptoms indicate low battery power. Replace batteries as soon as possible whenever any of the following occurs.
 - Dim power supply indicator
 - Instrument does not turn on
 - Display that is flickering, dim, or difficult to read
 - Abnormally low speaker/headphone volume
 - Distortion of sound output
 - Occasional interruption of sound when playing at high volumes
 - Sudden power failure when playing at high volumes
 - Flickering or dimming of the display when playing at high volume
 - Continued sound output even after you release a key
 - A totally different tone may sound
 - Abnormal rhythm pattern and demo tune play

- Loss of power, sound distortion, or low volume when playing from a connected computer or MIDI device
- Sudden power failure while reading from or writing to a diskette (WK-1800 only)

IMPORTANT!

Improper handling of batteries can cause them to burst and leak, which creates the danger of personal injury or damage due to contact with battery fluid. Be sure to note the following important precautions.

- Always make sure that the positive (+) and negative (-) poles are facing correctly as indicated inside the battery compartment.
- To avoid damage caused by leaking batteries, be sure to remove batteries from the keyboard whenever you leave it unattended for long periods (such as when leaving on a trip).
- Never mix batteries of different types.
- Never mix old batteries with new ones.
- Never discard batteries by incinerating them, do not allow their poles to be shorted (connected to each other), never take batteries apart, and do not expose batteries to direct heat.
- Replace batteries as soon as possible after any sign they are getting weak.
- Never attempt to recharge batteries.

Using the AC Adaptor

Make sure that you use only the AC adaptor specified for this keyboard.

Specified AC Adaptor: AD-12

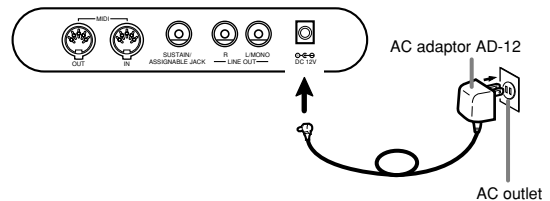

Also note the following important warnings and precautions when using the AC adaptor.

WARNING!

- Take care to avoid any damage to or breakage of the power cord. Never place any heavy objects on the power cord or expose it to direct heat. Doing so creates the danger of power cord damage, fire, and electrical shock.
- Use only the specified AC adaptor. Use of another type of adaptor creates the danger of fire and electrical shock.

CAUTION!

- For safety sake, be sure to unplug the AC adaptor from the wall outlet whenever leaving the keyboard unattended for a long time (such as when leaving on a trip).
- Always turn off the keyboard and unplug the AC adaptor from the wall outlet when you are not using the keyboard.

IMPORTANT!

- Make sure that the keyboard is turned off before connecting or disconnecting the AC adaptor.
- Using the AC adaptor for a long time can cause it to become warm to the touch. This is normal and does not indicate malfunction.

Auto Power Off

When you are using battery power, keyboard power turns off automatically whenever you leave it on without performing any operation for about 6 minutes. When this happens, press the POWER button to turn power back on.

NOTE

Auto Power Off is disabled (it does not function) when you are using the AC adaptor to power the keyboard.

To disable Auto Power Off

Hold down the TONE button while turning on the keyboard to disable Auto Power Off.

- When Auto Power Off is disabled, the keyboard does not turn off automatically no matter how long it is left with no operation being performed.

Settings and Memory Contents

The following describes what happens to settings and memory contents when power is turned off.

Settings

Tone, rhythm, and other "main keyboard settings" in effect when the keyboard is turned off manually by pressing POWER or automatically by Auto Power Off are still in effect the next time you turn power back on.

Main Keyboard Settings

Tone number, rhythm number, touch response on/off, touch response sensitivity, accompaniment mode, DSP on/off, DSP selection, assignable jack setting, tempo, Mixer parameters (tone, volume, pan, effect send, channel on/off, accompaniment volume), keyboard channel, General MIDI on/off, Pitch Bend range, accomp MIDI out on/off, MIDI in chord judge on/off, registration bank, layer on/off, auto harmonize on/off, split on/off, split point, Song Sequencer settings (song number, metronome, quantize), Pattern Sequencer settings (metronome, quantize), sound range shift on/off, contrast setting, SMF playback settings (WK-1800 only)

Memory Contents

In addition to the above settings, Registration, Song Sequencer, Pattern Sequencer, and Synthesizer memory contents are also retained when power is turned off.

Power Requirements

The keyboard comes with a built-in lithium battery that supplies power to the memory to retain Song Sequencer, Pattern Sequencer and other data while keyboard power is turned off. If the power of the lithium battery is low, turning off keyboard power can result in deletion of all data stored in its memory.

The normal life of the original battery is five years from the time it is loaded at the factory. Due to time spent in transit and storage, the original battery probably will not provide a full five years of service life. It is up to you to contact your nearest CASIO service provider about having the lithium battery replaced periodically.

Note that you will be charged separately for lithium battery replacement.

To protect against loss of valuable memory data, we strongly suggest that you use either of the following methods to back it up.

- Perform a MIDI dump of the data to a computer or other external device for storage. See "Bulk Sending Keyboard Data" on page E-65 for details.
- Save the data to diskette (WK-1800 only). See "Using the Floppy Disk Drive" on page E-67 for details.

To initialize the keyboard and delete all data

You can either fully initialize the keyboard or initialize parameters only.

Full Initialization

Use this procedure to return all keyboard settings to what they were when you purchased it. Note that this procedure clears all data from memory.

1. While holding down the **ENTER** button, turn on keyboard power.

Reset?

2. Press **YES** to initialize the keyboard or **NO** to turn on power without changing any settings.
 - The above procedure restores registration memory to its factory default contents. Any setup data stored in registration memory is deleted by the above procedure.

Parameter Initialization

Use this procedure to return all keyboard settings to what they were when you purchased it. Note that this procedure does not affect user tones, user rhythms, registration memory contents, and display contrast settings.

While keyboard power is on, press the [+], [-], and ENTER buttons at the same time.

Basic Operations

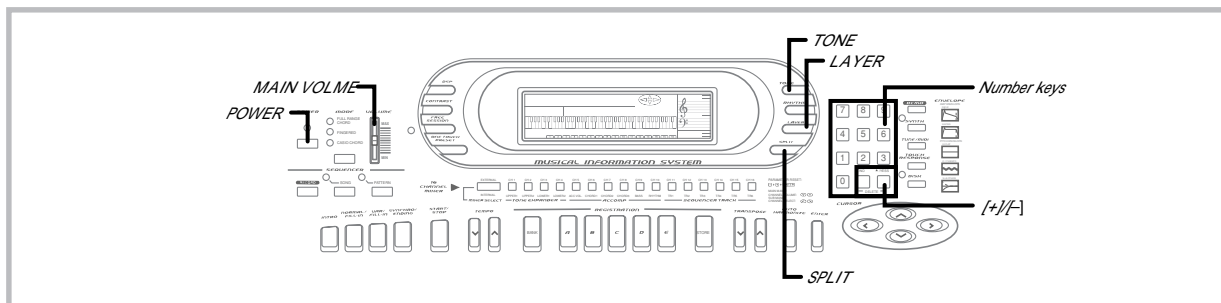

This section provides information on performing basic keyboard operations.

Getting Started

To play the keyboard

1. Press the **POWER** button to turn the keyboard on.
2. Use the **MAIN VOLUME** slider to set the volume to a relatively low level.
3. Play something on the keyboard.

Selecting a Tone

This keyboard comes with 200 built-in tones. Use the following procedure to select the tone you want to use.



To select a tone

1. Find the tone you want to use in the keyboard's Tone List and note its tone number.
2. Press the **TONE** button.
3. Use the **number keys** to input the three digit tone number for the tone you want to select.
Example: To select "032 ACOUSTIC BASS", input 0, 3 then 2.

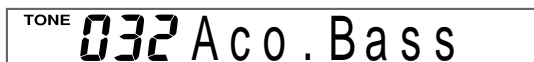

NOTES

- Always input all three digits for the tone number, including leading zeros (if any). If you input one or two digits and stop, the display will automatically clear your input after a few seconds.
- You can also increment the displayed tone number by pressing [+], and decrement it by pressing [-].
- When one of the drum sets is selected (tone numbers 192 through 199), each keyboard key is assigned a different percussion sound. See page A-5 for details.
- The 32 tones number 200 through 231 are for storage of original tones created using the synthesizer (page E-32). Once original tones are stored, they can be recalled and used just like the built-in tones. When the keyboard is shipped from the factory, tones 200 through 231 contain the same contents as tone number 128 to 159.

Names of tone numbers 128 through 199

No. Tone Name	DCO	polyphony	No. Tone Name	DCO	polyphony
128 OCTAVE PIANO	2	16	168 TOUCH STR PNO *	2	16
129 BREATHY SAX	1	32	169 TOUCH STRINGS *	2	16
130 STEREO PIANO	2	16	170 TOUCH VIB PNO *	2	16
131 ELEC PIANO 3	1	32	171 TOUCH BASS *	2	16
132 DETUNED EP 1	2	16	172 BRASS FALL	2	16
133 DETUNED EP 2	2	16	173 BRASS SLIDE	1	32
134 DETUNED EP 3	2	16	174 FEEDBACK	2	16
135 DETUNED CLAVI	2	16	175 PIANO = STR	2	16
136 ELEC ORGAN 1	1	32	176 SYNTH-PAD 1	2	16
137 ELEC ORGAN 2	1	32	177 SYNTH-PAD 2	2	16
138 ELEC ORGAN 3	1	32	178 SYNTH-PAD 3	2	16
139 ELEC ORGAN 4	1	32	179 SYNTH-PAD 4	2	16
140 ELEC ORGAN 5	2	16	180 SYNTH-PAD 5	2	16
141 PIPE ORGAN	2	16	181 SYNTH-PAD 6	2	16
142 STEREO GUITAR	2	16	182 SYNTH-PAD 7	2	16
143 12 STR GUITAR	2	16	183 SYNTH-PAD 8	2	16
144 SLAP BASS 3	1	32	184 SYNTH-LEAD 1	2	16
145 SYNTH-BASS 3	1	32	185 SYNTH-LEAD 2	2	16
146 SYNTH-BASS 4	1	32	186 SYNTH-SFX 1	2	16
147 SYNTH-BASS 5	1	32	187 SYNTH-SFX 2	2	16
148 STRINGS 3	2	16	188 SYNTH-SFX 3	2	16
149 TRUMPET 2	1	32	189 SYNTH-SFX 4	2	16
150 BRASS SECTION	2	16	190 SEQUENCE 1	2	16
151 SYNTH-BRASS 3	2	16	191 SEQUENCE 2	2	16
			DRUM SET		
152 STRINGS PIANO	2	16	192 DRUM SET 1	STANDARD SET	
153 STRINGS EP	2	16	193 DRUM SET 2	ROOM SET	
154 STR HARPSI	2	16	194 DRUM SET 3	POWER SET	
155 STR CELESTA	2	16	195 DRUM SET 4	ELECTRONIC SET	
156 STR KALIMBA	2	16	196 DRUM SET 5	SYNTH SET	
157 STRINGS HORN	2	16	197 DRUM SET 6	JAZZ SET	
158 STEREO STR GTR	2	16	198 DRUM SET 7	BRUSH SET	
159 SITAR AAH	2	16	199 DRUM SET 8	ORCHESTRA SET	
160 HARP ENS	2	16			
161 VOICE ENS	2	16			
162 BRASS ENS	2	16			
163 OCTAVE SAX	2	16			
164 PIPE ENS	2	16			
165 PERC ENS	2	16			
166 VIBES ENS	2	16			
167 REVERSE ORCH	2	16			

* What you hear differs according to how strongly you press the keyboard.

Polyphony

The term polyphony refers to the maximum number of notes you can play at the same time. The keyboard has 32-note polyphony, which includes the notes you play as well as the rhythms and auto-accompaniment patterns that are played by the keyboard. This means that when a rhythm or auto-accompaniment pattern is being played by the keyboard, the number of notes (polyphony) available for keyboard play is reduced. Also note that some of the tones offer only 16-note polyphony.

Digital Sampling

A number of the tones that are available with this keyboard have been recorded and processed using a technique called digital sampling. To ensure a high level of tonal quality, samples are taken in the low, mid, and high ranges and then combined to provide you with sounds that are amazingly close to the originals. You may notice very slight differences in volume or sound quality for some tones when you play them at different positions on the keyboard. This is an unavoidable result of multiple sampling, and it is not a sign of malfunction.

Using Layer

With layer you can assign two different tones (a main tone and a layered tone) to the keyboard, both of which play whenever you press a key. For example, you could layer the FRENCH HORN tone on the BRASS tone to produce a rich and brassy sound.

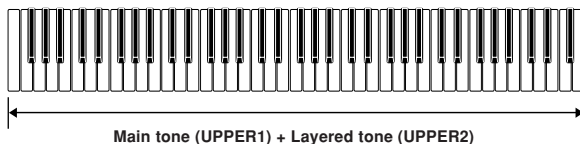

To layer two tones

1. Select the main tone and layered tone.
 - Use the Mixer to select the tones, following the procedure under "Changing the Parameters of a Channel" on page E-30. The main tone is UPPER1, while the layered tone is UPPER2.
 - If you don't want to use the Mixer, select a keyboard tone as you normally would (page E-16). This is the main tone. Next, proceed to step 2.
2. Press **LAYER** to turn on tone layering.
 - This causes the LAYER indicator to appear on the display.

LAYER

- The layered tone name and number appear on the display for about five seconds. During this time you can use the number keys to input a tone number to change the layered tone if you want. After about five seconds, the display changes to the main tone name and number.
3. Now try playing something on the keyboard.
 - Both tones are played at the same time.
 4. Press **LAYER** to unlayer the tones and return the keyboard to normal.
 - This causes the LAYER indicator to disappear.

NOTE

Layering is produced by sounding Mixer internal mode CH 1 (UPPER1) and CH 2 (UPPER2) at the same time. This means you can use the Mixer to change the volume balance and stereo pan position parameters for both the main tone and layered tone. See "Mixer Function" on page E-28 for details.

Using Split

With split you can assign two different tones (a main tone and a split tone) to either end of the keyboard, which lets you play one tone with your left hand and another tone with your right hand. For example, you could select STRINGS as the main (high range) tone and PIZZICATO as the split (low range) tone, putting an entire string ensemble at your fingertips.

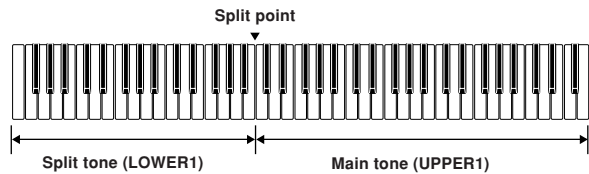

To split the keyboard

1. Select the main tone and split tone.
 - Use the Mixer to select the tones, following the procedure under "Changing the Parameters of a Channel" on page E-30. The main tone is UPPER1, while the split tone is LOWER1.
 - If you don't want to use the Mixer, select a keyboard tone as you normally would (page E-16). This is the main tone. Next, proceed to step 2.
2. Press **SPLIT**.
 - This causes the SPLIT indicator to appear on the display.

SPLIT

- The split tone name and number appear on the display for about five seconds. During this time you can use the number keys to input a tone number to change the split tone if you want. After about five seconds, the display changes to the main tone name and number.
3. Now try playing something on the keyboard.
 - The lower range (left side) of the keyboard is assigned the split tone, while the upper range (right side) is assigned the main tone.
 - The location on the keyboard where the changeover between the two tones occurs is called the split point. See "To change the location of the split point" on page E-18 for details on changing the location of the split point.
 4. Press **SPLIT** again to unsplit the keyboard and return it to normal.
 - This causes the SPLIT indicator to disappear.

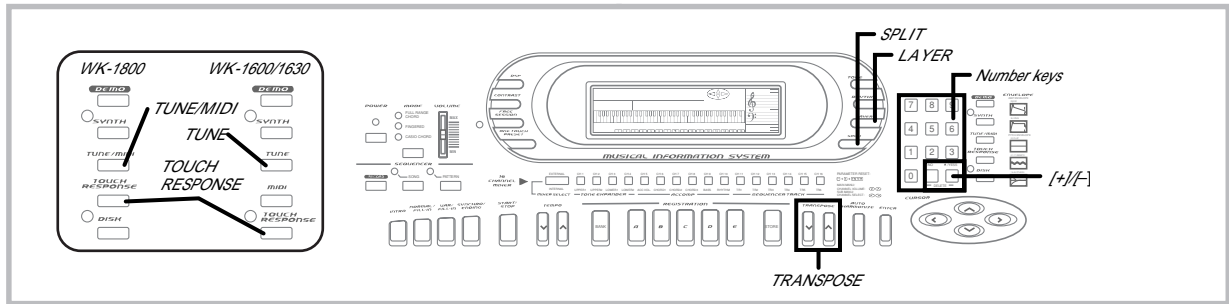

NOTE

Split is produced by using Mixer internal mode CH 1 (UPPER1) and CH 3 (LOWER1) at the same time. This means you can use the Mixer to change the volume balance and stereo pan position parameters for both the main tone and split tone. See "Mixer Function" on page E-28 for details.

To change the location of the split point

While holding down the SPLIT button, press the keyboard key where you want the lowest note (the leftmost key) of the upper range (right side range) to be.

Using Layer and Split Together

You can use layer and split together to create a layered split keyboard. When you use layer and split in combination, the high range of the keyboard is assigned two tones (main tone + layered tone), and the low range two tones (split tone + layered split tone).

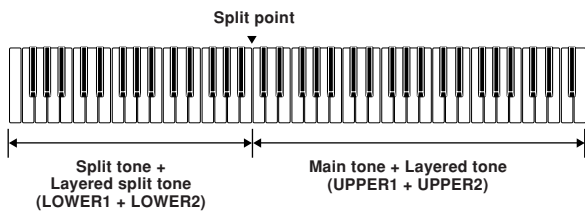

To layer-split the keyboard

1. Select the main tone, layered tone, split tone, and layered split tone.
 - Use the Mixer to select the tones, following the procedure under "Changing the Parameters of a Channel" on page E-30. The main tone is UPPER1, the layered tone is UPPER2, the split tone is LOWER1, and the layered split tone is LOWER2.
2. Turn on both layer and split to layer split the keyboard.
 - Press LAYER once to turn on layer.
 - Press SPLIT once to turn on split.
 - The LAYER and SPLIT indicators should be on the display to indicate that they are turned on.
 - The layered split tone name and number appear on the display for about five seconds. During this time you can use the number keys to input a tone number to change the layered split tone if you want. After about five seconds, the display changes to the main tone name and number.
3. Now try playing something on the keyboard.
4. Press LAYER once and SPLIT once to unlayer split the keyboard and return it to normal.

NOTES

- Layer-split is produced by using Mixer internal mode CH 1 (UPPER1), CH 2 (UPPER2), CH 3 (LOWER1), and CH 4 (LOWER2) at the same time. This means you can use the Mixer to change the volume balance and stereo pan position parameters for each of the tones. See "Mixer Function" on page E-28 for details.
- You can use the Mixer to turn off individual channels (layer split tones). This means you could turn off CH 4 (LOWER2), for example, to sound a single tone in the lower range and two layered tones in the upper range. See "Turning Channels On and Off" on page E-29 for details.

Using Touch Response

Turning on touch response causes the volume and sound quality of keyboard output to change in accordance with the amount of pressure applied to the keyboard.

To turn touch response on and off

- Press the TOUCH RESPONSE button to toggle touch response on and off.
- Turning on touch response causes the TOUCH RESPONSE indicator to appear on the display.

TOUCH RESPONSE

To set the touch response sensitivity

1. Press TOUCH RESPONSE to turn on touch response.
 - The TOUCH RESPONSE indicator appears on the display.
2. Within five seconds after pressing TOUCH RESPONSE, use [+] and [-] or number keys [0] to [3] to select the sensitivity setting you want to use.

"0 ExLight" : "1 Light" : "2 Normal" : "3 Heavy" : "Touch Off"

- "ExLight" outputs powerful sound even with light key pressure, while "Heavy" requires very heavy key pressure to output powerful sound.
- Pressing [+] and [-] at the same time returns sensitivity to the "Normal" setting.
- In addition to pressing the TOUCH RESPONSE button, you can also turn off touch response by selecting "Touch Off" as the sensitivity setting.

NOTES

- Touch response operations affect the keyboard's internal sound source as well as MIDI OUT data.
- Touch response settings do not affect Song Sequencer playback, accompaniment, or MIDI note data received from an external source.
- Touch response affects different tones in different ways.

Transposing the Keyboard

Transpose lets you raise and lower the overall key of the keyboard in semitone units. If you want to play accompaniment for a vocalist whose sings in a specific key, for example, you can use transpose to change the key of the keyboard without having to learn to play the song in another key.

To transpose the keyboard

Use the **TRANSPOSE buttons** (▲ and ▼) to change the transpose setting of the keyboard.

Example: To transpose the keyboard five semitones upwards.

05 Trans.

NOTES

- The keyboard can be transposed within a range of -12 (one octave downwards) to +12 (one octave upwards).
- The default transpose setting is 00 when keyboard power is turned on.
- The display changes from the transpose screen back to its normal screen if you do not perform any key operation for about three seconds.
- To return the transpose setting its initial default of 00, display the transpose screen and press the **TRANSPOSE buttons** (▲ and ▼) at the same time.
- The transpose setting also affects the sequencer and Auto Accompaniment. It does not, however, affect Auto Accompaniment drum parts.

Tuning the Keyboard

The tuning feature lets you fine tune the keyboard to match the tuning of another musical instrument.

To tune the keyboard

1. Press the **TUNE/MIDI button** to display the tuning screen.
 - With the WK-1600/1630, this button is named TUNE.

00 Tune

2. Use **[+]** and **[-]** buttons to change the tuning setting of the keyboard.

Example: To lower the tuning by 20.

-20 Tune

NOTES

- The keyboard can be tuned within a range of -50 cents to 50 cents (±50 cents*).
- * 100 cents is equivalent to one semitone.
- The default tuning setting is 00 when keyboard power is turned on.
- The display changes from the tuning screen back to its normal screen if you do not perform any key operation for about five seconds.
- To return the tuning setting to its initial default of 00, display the tuning screen and press the **[+]** and **[-]** buttons at the same time.
- The tuning setting also affects the sequencer and Auto Accompaniment. It does not, however, affect Auto Accompaniment drum parts.

Using DSP Effects

DSP effects make it possible for you to add a variety nuances to your music quickly and easily. The following is a list of 10 DSP effects that are available. Try using each one to find out how it changes the sound produced by the keyboard. Note that only one effect can be applied at a time.

No.	Effect Name	Display Indicator	Description
0	Reverb 1	Reverb1	Deep reverb
1	Reverb 2	Reverb2	Medium reverb
2	Reverb 3	Reverb3	Shallow reverb
3	Chorus	Chorus	More depth and breadth
4	Tremolo	Tremolo	Slight modulation of volume
5	Phase Shifter	Phaser	Rotary speaker effect
6	Organ Speaker	Organ Speaker	Electronic organ rotary speaker effect
7	Enhancer	Enhancer	Attack effect by enhancing high harmonics
8	Flanger	Flanger	Jet plane effect that causes the sound to build and then decay
9	EQ Loudness	Loudness	Enhanced lower tones

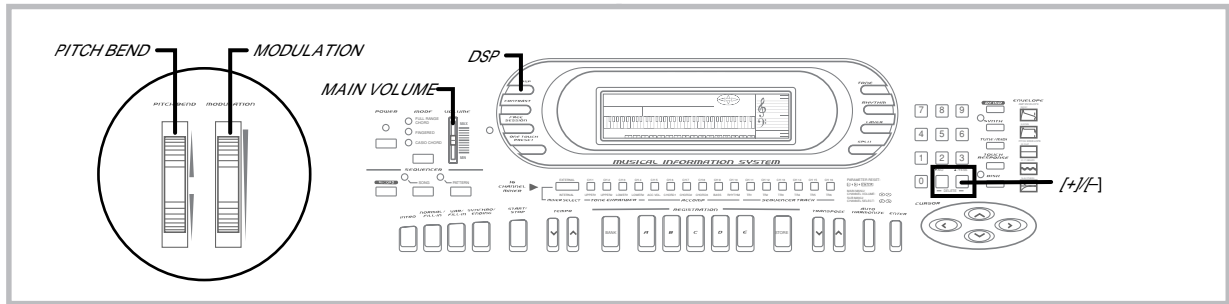

Turning DSP Effects On and Off

You can turn the currently selected DSP effect on and off by pressing the DSP button.

- The current DSP effect's on/off status is indicated on the display by the **DSP** indicator. The digital effect is on while this indicator is displayed, and off when it is not displayed.
- Press the DSP button to toggle the currently selected digital effect on and off.

To turn the DSP effect on and off

1. Press the **DSP button**.
 - This causes one of the two digital effect screens shown below to appear.

When the current digital effect is turned on

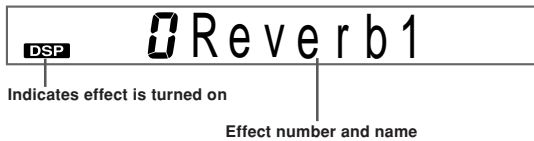

When the current digital effect is turned off



- The above screens clear if you do not perform any operation within about five seconds.

2. While a digital effect screen is on the display, use the **[+]** and **[-]** buttons to scroll through the digital effects, until the one you want is displayed.

NOTES

- Playing a demo tune (page E-8) automatically changes the effect to the one that is assigned to the tune. You cannot change or cancel a demo tune effect.
- Changing the effect setting while sound is being output by the keyboard causes a slight break in the sound when the effect changes.
- The DSP effect is applied not only to the notes you play on the keyboard, but also to rhythms and Auto Accompaniment patterns. Note that effects 3 through 6, and effect 8 can produce a mood that is not suitable for certain types of music when they are applied to rhythms and Auto Accompaniment. When this happens, you can turn off application of the effect to the rhythm and Auto Accompaniment by using the Mixer to set the effect send volume of the accompaniment channel to zero. For details on the actual procedure for doing this, see "Changing the Parameters of a Channel" on page E-30.
- Setting the keyboard's MAIN VOLUME slider to high volume when Effect 9 (EQ Loudness) is being applied can cause distortion for certain tones and rhythm patterns. When this happens, lower the MAIN VOLUME setting.

Using the PITCH BEND Wheel

As its name suggests, the PITCH BEND wheel lets you "bend" the pitch of a sound. This makes it possible to add a touch of realism to saxophone and other tones.

To use the PITCH BEND wheel

While holding down a keyboard key with your right hand, use your left hand to rotate the **PITCH BEND wheel** up and down.

- Releasing the PITCH BEND wheel returns the note to its original pitch.

NOTES

- With saxophone and electrical guitar tones, the most realistic sounding effects can be produced if you play notes and operate the PITCH BEND wheel simultaneously.
- See "Pitch Bend Range (Initial Default: 02)" on page E-59 for changing the bend range of the PITCH BEND wheel.
- Never turn on keyboard power while the PITCH BEND wheel is rotated.

Using the MODULATION Wheel

Modulation applies vibrato, which modulates the pitch of a note. It works best with notes that are sustained (held) by keeping a keyboard key held down, especially when playing the melody with a violin or other similar tone.

To use the MODULATION Wheel

While playing melody notes with your right hand, rotate the **MODULATION wheel** with your left to apply vibrato to the notes.

- The amount of vibrato applied depends on how far you rotate the **MODULATION wheel** upwards. Setting the wheel to its neutral position (rotated as far downwards as it can go) turns vibrato off.

NOTES

- Modulation can be used to add greater expression to sustained melody notes being played using a violin, synthetic reed, or other similar tone.
- Modulation affects different tones in different ways.

Auto Accompaniment

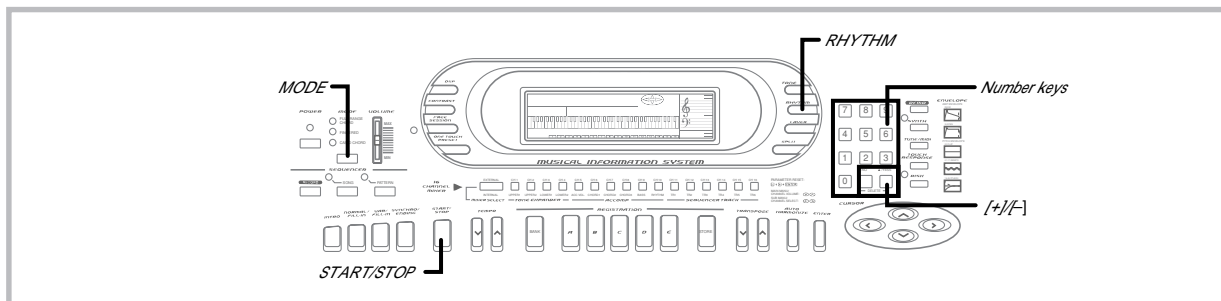

This keyboard automatically plays bass and chord parts in accordance with the chords you finger. The bass and chord parts are played using sounds and tones that are automatically selected in accordance with the rhythm you are using. All of this means that you get full, realistic accompaniments for the melody notes you play with your right hand, creating the mood of an one-person ensemble.

About the MODE Button

Use the MODE button to select the accompaniment mode you want to use. Each press of the MODE button cycles through the available accompaniment modes as shown in the illustration below.

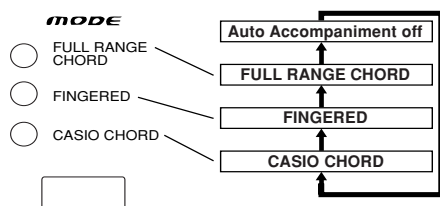

- Only rhythm sounds are produced when all accompaniment mode lamps are off.
- The currently selected accompaniment mode is shown by the mode lamps above the MODE button. Information on using each of these modes starts from page E-22.

Selecting a Rhythm

This keyboard provides you with 120 exciting built-in rhythms that you can select using the following procedure.

To select a rhythm

1. Find the rhythm you want to use in the keyboard's Rhythm List and note its rhythm number.
2. Press the **RHYTHM** button.
3. Use the **number keys** to input the three-digit rhythm number for the rhythm you want to select.
Example: To select "042 JUNGLE" press 0, 4 then 2.

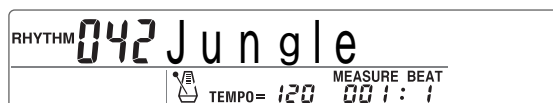

NOTES

- Always input three digits for rhythm numbers, including any leading zeros if necessary (as in 032). The rhythm number input display clears after a few seconds if you don't input three digits.
- You can also change the displayed rhythm number using [+] and [-].
- The 10 rhythm numbers 120 to 129 are provided for storage of rhythm patterns created by you using the Pattern Sequencer. You can also recall these rhythms using the procedure described above. Simply input a rhythm number from 000 to 119.
- Rhythms 110 through 119 (FOR PIANO II) are made up of chord accompaniments only, without drum or other rhythm sounds. Because of this, these rhythms do not sound while auto accompaniment is turned off (all the indicator lamps above the MODE button are off). You can specify chords by using these rhythms while auto accompaniment is turned on (indicated when one of the indicator lamps above the MODE button is lit) or with Free Session.

Playing a Rhythm

Press the START/STOP button to start play of the currently selected rhythm. You can then play along with the rhythm on the keyboard. To stop rhythm play, press START/STOP again.

NOTE

Chords will sound along with the rhythm if any of the three accompaniment mode lamps above the MODE button is lit. If you want to play the rhythm pattern without chords, press the MODE button until all of the lamps are off.

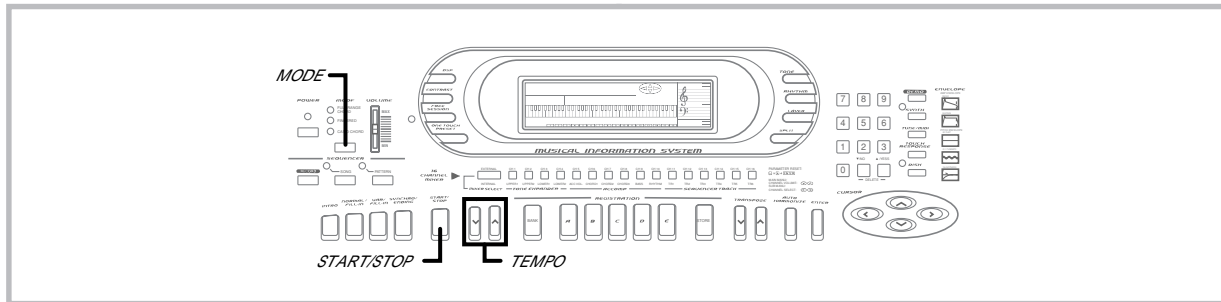

Adjusting the Tempo

You can adjust the tempo (number of beats per minute) of rhythm play within a range of 30 to 255.

To adjust the tempo

Press one of the **TEMPO** buttons to increase [▲] or decrease [▼] the tempo setting.



NOTES

- Pressing both TEMPO buttons (▲ and ▼) at the same time resets the tempo to the default value of the currently selected rhythm.
- The tempo value indicates the number of quarter note beats per minute.

Using Auto Accompaniment

The following procedure describes how to use the keyboard's Auto Accompaniment feature. Before starting, you should first select the rhythm you want to use and set its tempo to the value you want.

To use Auto Accompaniment

- Use the **MODE** button to select FULL RANGE CHORD, FINGERED, or CASIO CHORD as the accompaniment mode.
 - The currently selected accompaniment mode is the one whose lamp is lit. See "About the MODE Button" on page E-21 for details.
- Press the **START/STOP** button to start play of the currently selected rhythm.
- Play a chord to start Auto Accompaniment.
 - The actual procedure you should use to play a chord depends on the currently selected accompaniment mode. Refer to the following pages for details on chord play.

CASIO CHORD Page E-22
 FINGERED Page E-23
 FULL RANGE CHORD Page E-23

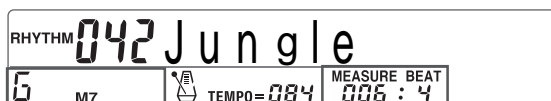

Name of chord being played

Current measure and beat

- To stop Auto Accompaniment play, press the **START/STOP** button again.

CASIO CHORD

This method of chord play makes it possible for anyone to easily play chords, regardless of previous musical knowledge and experience. The following describes the CASIO CHORD "Accompaniment keyboard" and "Melody keyboard", and tells you how to play CASIO CHORDS.

CASIO CHORD Accompaniment Keyboard and Melody Keyboard

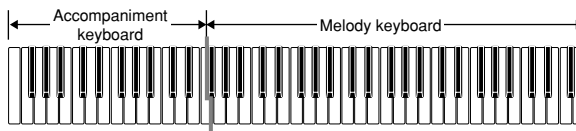

IMPORTANT!

The accompaniment keyboard can be used for playing chords only. No sound will be produced if you try playing single melody notes on the accompaniment keyboard.

Chord Types

CASIO CHORD accompaniment lets you play four types of chords with minimal fingering.

Chord Types	Example
Major chords Major chord names are marked above the keys of the accompaniment keyboard. Note that the chord produced when you press an accompaniment keyboard does not change octave, regardless of which key you use to play it.	C Major (C)
Minor chords (m) To play a minor chord, keep the major chord key depressed and press any other accompaniment keyboard key located to the right of the major chord key.	C minor (Cm)
Seventh chords (7) To play a seventh chord, keep the major chord key depressed and press any other two accompaniment keyboard keys located to the right of the major chord key.	C seventh (C7)
Minor seventh chords (m7) To play a minor seventh chord, keep the major chord key depressed and press any other three accompaniment keyboard keys located to the right of the major chord key.	C minor seventh (Cm7)

NOTE

It makes no difference whether you press black or white keys to the right of a major chord key when playing minor and seventh chords.

FINGERED

FINGERED provides you with a total of 15 different chord types. The following describes the FINGERED "Accompaniment keyboard" and "Melody keyboard", and tells you how to play a C-root chord using FINGERED.

FINGERED Accompaniment Keyboard and Melody Keyboard

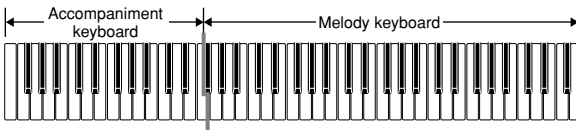

IMPORTANT!

The accompaniment keyboard can be used for playing chords only. No sound will be produced if you try playing single melody notes on the accompaniment keyboard.

C 	Cm 	Cdim
Caug *1 	Csus4 	C7 *2
Cm7 *2 	Cmaj7 *2 	Cm7⁻⁵
C7⁻⁵ *1 	C7sus4 	Cadd9 *2
Cmadd9 *2 	CmM7 *2 	Cdim7 *1

See the "Fingered Chord Chart" on page A-6 for details on playing chords with other roots.

- *1: Inverted fingerings cannot be used. The lowest note is the root.
- *2: The same chord can be played without pressing the 5th G.

NOTES

- Except for the chords specified in note*1 above, inverted fingerings (i.e. playing E-G-C or G-C-E instead of C-E-G) will produce the same chords as the standard fingering.
- Except for the exception specified in note*2 above, all of the keys that make up a chord must be pressed. Failure to press even a single key will not play the desired FINGERED chord.

FULL RANGE CHORD

This accompaniment method makes it possible to play a total of 38 chord variations: the 15 available with FINGERED plus 23 additional variations. The keyboard interprets any input of three or more keys that matches a FULL RANGE CHORD pattern to be a chord. Any multi-key input that is not a FULL RANGE CHORD pattern is interpreted as melody play. Because of this, there is no need for a separate accompaniment keyboard, and the entire keyboard from end-to-end can be used for both melody and chords.

FULL RANGE CHORD Accompaniment Keyboard and Melody Keyboard

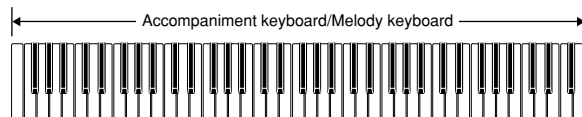

Using Variation Rhythm Patterns

In addition to the standard rhythm pattern, you can also switch to a secondary "variation" rhythm pattern for a bit of variety.

To change to the variation rhythm pattern

1. Press the **START/STOP** button to start rhythm play.
2. Press the **VARIATION/FILL-IN** button to switch to the variation pattern for the rhythm you are using.

NOTE

To switch back to the normal (non-variation) rhythm pattern, press the **NORMAL/FILL-IN** button.

To insert a fill in into a variation rhythm

While a variation rhythm pattern is playing, press the **VARIATION/FILL-IN** button to insert a fill in pattern for the variation rhythm you are using.

Synchro Starting Accompaniment with Rhythm Play

You can set up the keyboard to start rhythm play at the same time you play the accompaniment on the keyboard.

PREPARATION

- Select a rhythm and set its tempo.
- Select the accompaniment mode you want to use.

To use synchro start

1. Press the **SYNCHRO/ENDING** button to put the keyboard into synchro start standby.



2. Play a chord on the accompaniment keyboard.
 - The rhythm pattern starts to play automatically as soon as you play a chord.

NOTES

- Only the rhythm plays (without chords) if all the lamps above the **MODE** button are off.
- If you press the **INTRO** button before playing anything on the keyboard, the rhythm starts automatically with an intro pattern when you play something on the keyboard.
- To cancel synchro start standby, press the **SYNCHRO/ENDING** button one more time.

Finishing with an Ending Pattern

You can end your performances with an ending pattern that brings the rhythm you are using to a natural-sounding conclusion.

To finish with an ending pattern

While the rhythm is playing, press the **SYNCHRO/ENDING** button.

- This causes the ending pattern to play, which brings rhythm accompaniment to an end.

NOTE

The timing when the ending pattern starts depends on when you press the **SYNCHRO/ENDING** button. If you press the button before the second beat of the current measure, the ending pattern starts playing immediately. Pressing the button at any point in the measure after the second beat results in the ending pattern playing from the beginning of the following measure.

Using Auto Harmonize

When you are using Auto Accompaniment, Auto Harmonize automatically adds three additional notes to your melody in accordance with the chord that is being played. The result is a harmony effect that makes your melody line richer and fuller.

To use Auto Harmonize

1. Use the **MODE** button to select **FINGERED** or **CASIO CHORD** as the accompaniment mode.
 - The currently selected accompaniment mode is the one whose lamp is lit. See "About the MODE Button" on page E-21 for details.

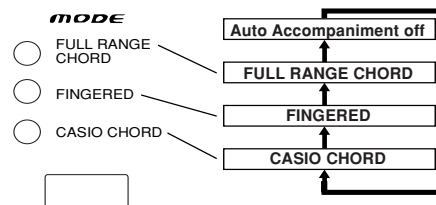

2. Press **AUTO HARMONIZE** to turn on Auto Harmonize.
 - This causes the **AUTO HARMONIZE** indicator to appear on the display.

AUTO HARMONIZE

3. Start Auto Accompaniment play, and play something on the keyboard.
4. To turn off Auto Harmonize, press **AUTO HARMONIZE**.
 - This causes the **AUTO HARMONIZE** indicator to disappear.

NOTES

- Auto Harmonize turns off temporarily whenever you start demo tune play, or perform a Synthesizer or floppy disk operation (WK-1800 only). It turns back on as soon as the operation or function that caused it to turn off is finished.
- Note that you cannot use Auto Harmonize and layer at the same time.
- Auto Harmonize is enabled only when the Auto Accompaniment mode is **FINGERED** or **CASIO CHORD**.

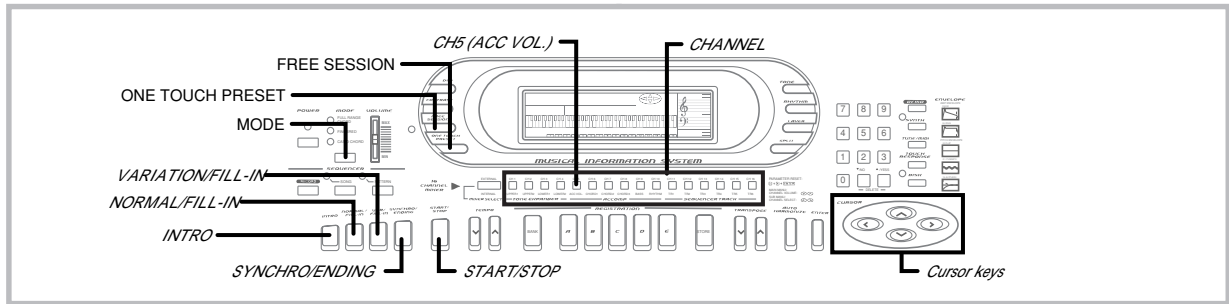

About Auto Harmonize notes and tones

The notes you play on the keyboard are called “melody notes,” while the notes added to the melody by Auto Harmonize is called the “harmonize notes.” Auto Harmonize normally uses the tone you selected for the melody notes as the tone for the harmonize notes, but you can use the Mixer (page E-28) to specify a different tone for the harmonize notes.

The harmonize note tone is assigned to Mixer Channel 2, so change Channel 2 to the tone you want to use for the harmonize notes.

In addition to the tone, you can also use the Mixer to change a number of other parameters, such as volume balance. See “Changing the Parameters of a Channel” on page E-30 for details on these procedures.

NOTES

- The default harmonize note tone when you first turn on Auto Harmonize is the same tone as the melody note tone.
- Changing the melody tone setting automatically changes the harmonize note tone to the same setting.

Using One-touch Preset

One-touch preset automatically makes the settings listed below in accordance with the rhythm pattern you are using.

- Keyboard tone and volume
- Layer or Auto Harmonize on/off
- Layered tone and volume (when layer is turned on) or harmonize tone and volume (when harmonize is turned on).
- Tempo
- Accompaniment volume

To use one-touch preset

1. Select the rhythm you want to use.
2. Use the **MODE** button to select the accompaniment mode you want to use.
3. Press the **ONE TOUCH PRESET** button.
 - This automatically makes the one-touch preset settings in accordance with the rhythm you selected.
4. Start rhythm and Auto Accompaniment, and play something on the keyboard.
 - Accompaniment is played using the one touch preset settings.

Using Free Session

This keyboard comes pre-programmed with a collection of “Free Sessions,” which are Auto Accompaniments that automatically match chord progression, tone, tempo and other settings to the currently selected rhythm pattern. Starting a Free Session causes the entire keyboard to become a melody keyboard for play along with the repeating chord progression of the Free Session.

Pre-programmed settings in accordance with the selected rhythm pattern are used whenever Free Session is turned on.

- Chord progression
- Keyboard tone and volume
- Layer or Auto Harmonize on/off
- Layered tone and volume (when layer is turned on) or harmonize tone and volume (when harmonize is turned on).
- Tempo
- Accompaniment volume

To use Free Session

1. Select the rhythm you want to use.
2. Press the **FREE SESSION** button.
 - The lamp above the button lights to indicate that Free Session is turned on.
3. Press the **START/STOP** button.
 - This starts the repeating chord progression of the preset Auto Accompaniment to match the selected rhythm.
 - Press **START/STOP** again if you want to stop the progression.
4. To turn off Free Session, press the **FREE SESSION** button again.
 - The lamp above the **FREE SESSION** button is not lit when Free Session is turned off.

NOTES

- The default root note of the first chord is C (See “Free Session Chord Progression Chart” on page A-2 for details). You can change to a different root by pressing the corresponding key within the accompaniment keyboard instead of **START/STOP** in the above procedure.
- You can also use the **INTRO**, **NORMAL/FILL-IN**, **VARIATION/FILL-IN**, and **SYNCHRO/ENDING** buttons while Free Session accompaniment is playing.
- Tone and tempo settings can be changed while a Free Session Auto Accompaniment is playing. The rhythm pattern can also be changed while a Free Session Auto Accompaniment is playing, but the chord progression does not change in this case unless you stop Auto Accompaniment and restart it.
- You must stop the Auto Accompaniment to change the root note of the first chord.
- Changing to a rhythm pattern with a different meter can affect chord change timing.

Turning Auto Accompaniment Parts On and Off

Auto Accompaniment patterns are made up of five parts, named: Chord 1, Chord 2, Chord 3, Bass, and Rhythm. You can turn these parts on and off to create exactly the type of accompaniment pattern you want. Parts are turned on and off using channel buttons 6 through 10. The table below shows the relationship between accompaniment parts and channel buttons.

Auto Accompaniment Part	Channel Button
Chord 1	CH6
Chord 2	CH7
Chord 3	CH8
Bass	CH9
Rhythm	CH10

See "Turning Channels On and Off" on page E-29 for full details on how to turn Auto Accompaniment parts on and off.

NOTE

With some rhythm patterns, some parts are assigned all rests (which mean they normally do not play even when turned on).

Adjusting the Accompaniment Volume

The following procedure adjusts the overall volume of all the accompaniment parts by specifying a value in the range of 000 (minimum) to 127 (maximum).

- Accompaniment volume can be changed in the Internal Mode only. See "Mixer Modes" on page E-28 for details on the Internal Mode.

1. Press the **CH5 (ACC VOL.)** button.
2. Use the **[▲]** and **[▼]** cursor keys to increase or decrease the displayed value.



New accompaniment volume setting

NOTES

- You can also use the Mixer to adjust the volume for each individual Auto Accompaniment part. See "Mixer Function" on page E-28 for details.
- The accompaniment volume setting screen is cleared if you do not input anything for about five seconds.

Mixer Function

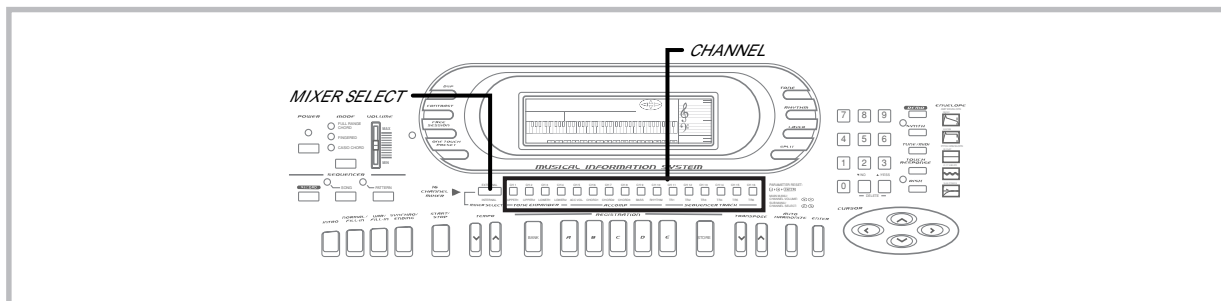

Mixer Features

The Auto Accompaniment feature and sequencers of this keyboard can play up to 16 different musical instrument parts at the same time. You can also play along on the keyboard, and even use layer and split to add even more instrument parts.

For example, the following table shows the seven parts that would play if you use layer to play two tones on the keyboard while Auto Accompaniment play is in progress.

(1)	Keyboard	Main tone
(2)		Layered tone
(3)	Auto Accompaniment	Chord 1
(4)		Chord 2
(5)		Chord 3
(6)		Bass
(7)		Rhythm

The Mixer makes it possible for you to turn each of the above parts on and off, and also specify the tone, volume, stereo (pan) point, and DSP effect for each.

NOTE

The above explanation applies to the Mixer's Internal Mode.

Parts and Channels

Each part for keyboard play, Auto Accompaniment patterns and Song Sequencer tunes is assigned to one of 16 channels. You can use the Mixer to select a channel and adjust various parameters of the assigned part. The following table shows the parts assigned to each channel.

Channel Number	Part	Channel Button Name
CH1	Main tone	UPPER1
CH2	Layered tone Auto Harmonize harmony tone	UPPER2
CH3	Split tone	LOWER1
CH4	Layered/split tone Auto Harmonize split tone	LOWER2
CH5	Main accompaniment volume	ACC VOL.
CH6	Auto Accompaniment chord 1	CHORD1
CH7	Auto Accompaniment chord 2	CHORD2
CH8	Auto Accompaniment chord 3	CHORD3
CH9	Auto Accompaniment bass	BASS
CH10	Auto Accompaniment rhythm	RHYTHM
CH11	Song Sequencer track 1	TR1
CH12	Song Sequencer track 2	TR2
CH13	Song Sequencer track 3	TR3
CH14	Song Sequencer track 4	TR4
CH15	Song Sequencer track 5	TR5
CH16	Song Sequencer track 6	TR6

NOTES

- In this manual, "channel" is abbreviated as "CH," which matches the channel numbers marked on the keyboard above the CHANNEL buttons.
- The CHANNEL button name in the above table corresponds to the text marked on the keyboard below the CHANNEL buttons.
- The part names shown in the "Part" column of the above table correspond to the parts that can be selected using the Mixer's internal mode. In the case of the External Mode (see following section), the part assigned to each channel corresponds to each MIDI channel.

Mixer Modes

The Mixer has two main modes, an Internal mode and an External Mode, each of which is described in detail below.

Internal Mode

This mode lets you control each channel (internal channels) when using the keyboard internal control (keyboard play, Auto Accompaniment, Song Sequencer playback). This is the default Mixer mode whenever you turn on keyboard power.

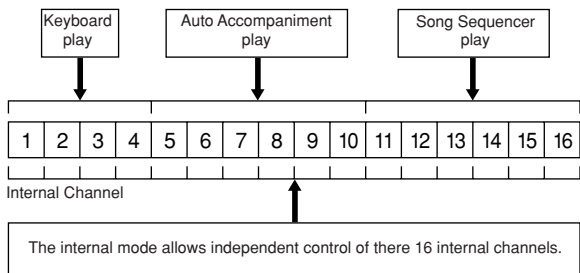

External Mode

The External Mode provides control of each channel (external channels) when the keyboard's sound source is under control (MIDI input, SMF playback*) of an external device.

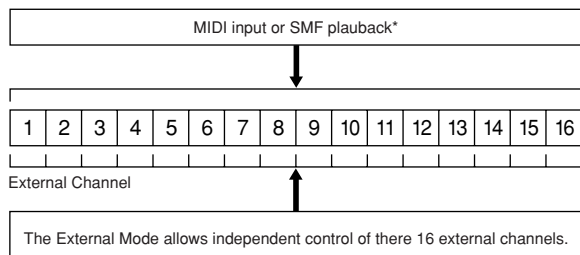

The External Mode has three sub-modes: External, External/Solo, and External/Play.

- External This is the basic External Mode, which is used for most external channel parameters.
- External/Solo This mode turns one channel on and all other channels off. It is used playing MIDI input (or SMF playback*) that simultaneously uses multiple channels of the keyboard's sound source.
- External/Play This mode is a mirror of the External/Solo Mode. It turns one channel off and all other channels on. It comes in handy, for example, when you want to turn off a specific part of SMF playback* and play along on the keyboard.

NOTES

- The internal channels controlled by the internal mode are completely different from the external channels controlled by the external mode. This means that there are a total of 32 different channels. The Mixer mode saves internal mode and External Mode parameters separately from each other.
- The External Mode is for MIDI (or SMF playback*). Operation of the External/Play Mode is particularly suited to MIDI play. See "MIDI" on page E-60 for information about how the Mixer is used during MIDI operations.

* SMF Playback (WK-1800 only)

The built-in disk drive of the WK-1800 allows playback of SMF (standard MIDI files) from diskette. See "Using the Floppy Disk Drive (WK-1800 Only)" on page E-67 for details.

To select the Mixer mode

Press the MIXER SELECT button to toggle between the Mixer mode sub-modes as shown in the illustration below. The currently selected mode is indicated on the display.

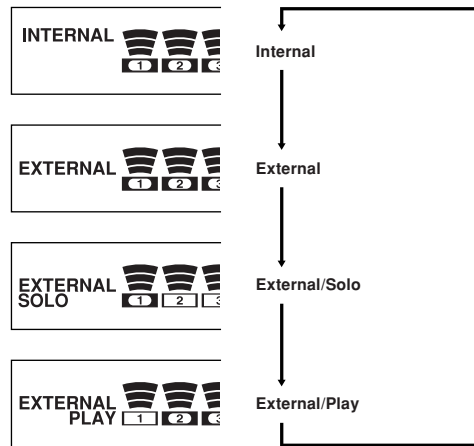

Turning Channels On and Off

Press the CHANNEL buttons to toggle individual channels on and off. Indicators on the display show the current on/off status of each channel.

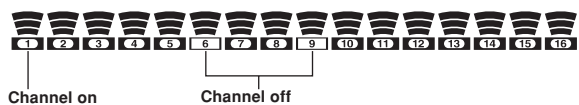

The channel affected and the operation performed when a CHANNEL button is pressed depends on what Mixer mode you are in, as described below.

Internal Mode

- Each press of a CHANNEL button toggles the applicable channel on and off (except CH5).
- The on/off status of each channel determines the on/off status of the corresponding part for keyboard play, Auto Accompaniment, and Song Sequencer playback.
- Changing to a different rhythm causes Mixer Settings for CH6 through CH10 to change to the default settings assigned to the new rhythm. These settings also change to the defaults for the currently selected rhythm pattern whenever you switch between the Intro, Normal, Variation, Fill-in, and Ending patterns.

External Mode

On/off settings in this mode affect MIDI input and SMF playback channels (WK-1800 only).

- In the External Mode, each press of CHANNEL button CH1 through CH16 toggles the applicable channel on and off.
- In the External/Solo Mode, pressing a CHANNEL button turns on that channel and turns all the other channels off.
- In the External/Play Mode, pressing a CHANNEL button turns off that channel and turns all the other channels on.

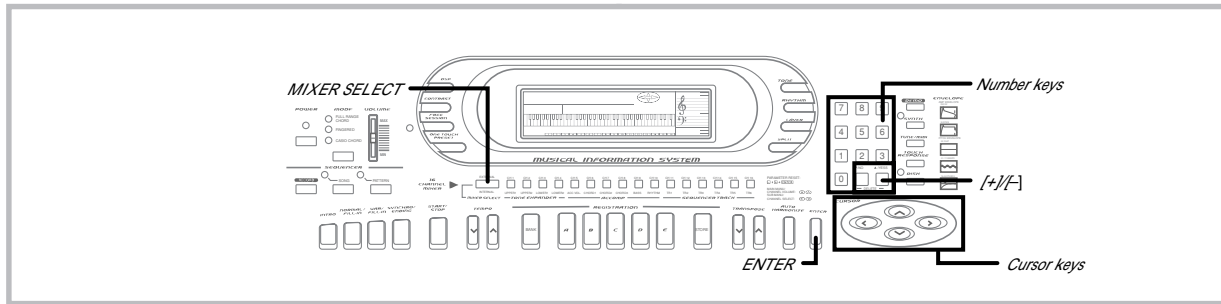

Changing the Parameters of a Channel

Use the following procedure to change the parameters of each individual channel.

PREPARATION

- Turn off the Synthesizer, Song Sequencer, or Pattern Sequencer if any of them are turned on.

To change channel parameters

1. Press the **MIXER SELECT** button to select the Mixer mode you want to use.
 - Select the internal mode to make layer, split, Auto Accompaniment, or Song Sequencer settings.
 - Select the External Mode to make MIDI settings.
 - You can also make settings using the External/Solo or External/Play Modes, but we recommend using the External Mode.
2. Use the [**◀**] and [**▶**] **cursor keys** to select the channel whose parameters you want to change.
 - See page E-28 for details on layer, split, Auto Accompaniment, and Song Sequencer channel assignments.
 - The frame around the currently selected channel (the current channel) flashes, to indicate that it is selected.



- The on/off status of the current channel is indicated in the measure number area of the display (item 11 on page E-10).

On **on** Off **off**

3. Change the current channel's tone and volume parameters while a channel number frame is flashing, if you want.
 - Use the number keys or [+] and [-] keys to change the tone.
 - Use [**▲**] and [**▼**] to change the volume. The current volume setting is shown as a value in the metronome area of the display (item 15 on page E-10), and by the level indicator.



4. To make additional settings for the current channel, press the **ENTER** button while a channel number frame is flashing.
 - See "To make additional channel parameter settings" for details on making additional channel parameters.

5. After making additional settings in step 4, press the **ENTER** button.
 - If you do not perform any operation for about five seconds while a channel number frame is flashing, the display returns to that in step 1 of the above procedure automatically.

NOTES

- Internal Mode and External Mode settings you make with the above procedure are stored separately.
- You can change the parameters of a channel regardless of whether the channel is on or off.
- Changing a Mixer internal mode channel setting causes the MIDI message that corresponds to the change to be output through the MIDI OUT terminal.

To make additional channel parameter settings

When making channel parameter settings, press the **ENTER** button to display the first additional channel parameter screen.

Use the [**▲**] and [**▼**] cursor keys to scroll through the setting screens shown below.

While any setting screen is on the display, use the number keys or [+] and [-] to change the parameter to the value you want.

Parameter	Screen	Setting Range
Program Change Number	000 Prog. No.	000 ~ 231
[▲] ↑	[▼] ↓	
Volume	110 Volume	000 ~ 127
[▲] ↑	[▼] ↓	
Pan	054 Pan	000 ~ 127
[▲] ↑	[▼] ↓	
Effect Send	070 Effect	000 ~ 127
[▲] ↑	[▼] ↓	
Fine Tune	00 FineTune	-50 ~ 00 ~ 50
[▲] ↑	[▼] ↓	
Coarse Tune	00 C. Tune	-12 ~ 00 ~ 12
[▲] ↑	[▼] ↓	
Expression	127 Express	000 ~ 127

See the following section titled "Additional Channel Mode Parameters" on page E-31 for details on what each of these parameters controls.

NOTES

- The first screen is normally the pan screen. If you used the additional channel parameter screens since turning on power, the last setting you used appears first.
- You can use the [**◀**] and [**▶**] cursor keys to change the current channel while an additional channel parameter screen is on the display.
- Channel 10 is reserved for drum sounds, so only tone number 192 to 199 can be selected.

Additional Channel Mode Parameters

The following describes each of the additional channel mode parameters.

Program Change Number

This parameter controls the tone assigned to the channel.

Volume

This is the parameter that controls the volume of the selected channel.

Pan

This parameter controls the pan pot, which is the center point of the left and right stereo channels. Setting 064 specifies center, a value less than 064 moves the point left and a value greater than 064 moves it right.

Effect Send

This parameter controls the depth of the digital effect (DSP) for each channel. Enhancer and Loudness, however, are not changed.

Fine Tune

This parameter controls the fine tuning of the selected channel's pitch in cent units.

Coarse Tune

This parameter controls the coarse tuning of the selected channel's pitch in semitone units.

Expression

This parameter controls the volume of the selected channel. Though this parameter is identical to the volume parameter, it is used for desktop music applications.

Synthesizer Mode

The Synthesizer of this keyboard provides all the tools you need for creating your own original tones. Simply select one of the built-in tones and change its parameters to create your own original sound. You can even store your sounds in memory for later recall using the same procedure as that used to select a preset tone.

Synthesizer Functions

The following describes how to use each of the functions available with the Synthesizer.

Synthesizer Parameters

The sounds of the preset tones built into this keyboard are controlled by settings called "parameters." To create a user tone, you first recall a preset tone and then change its parameters. Note that drum set tones (192 through 199) cannot be used as the basis of a user tone. The figure below shows the parameters that make up the preset tones and what each parameter does. As you can see, these parameters can be divided into four groups, each of which is described in detail in the following pages.

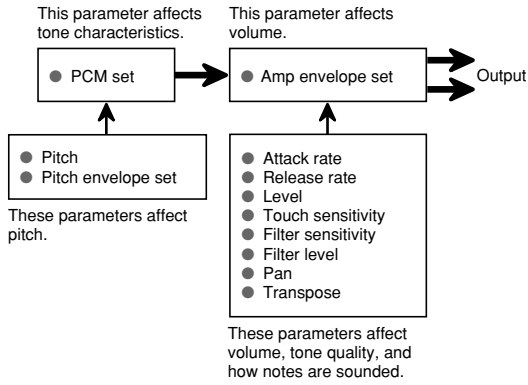

(1) Tone Characteristic Parameter

■ PCM Set

This parameter determines the characteristics of a tone by switching its digitally sampled waveform. You can select a piano, guitar, synthesizer, or any other of a variety of musical instrument and digitally sampled waveforms.

(2) Volume Characteristic Parameter

■ Amp Envelope Set

This set gives you a choice of a variety of different volume envelopes (changes in volume over time): slow attack when a key is pressed, quick attack when a key is pressed, continued sound while a key is depressed, etc.

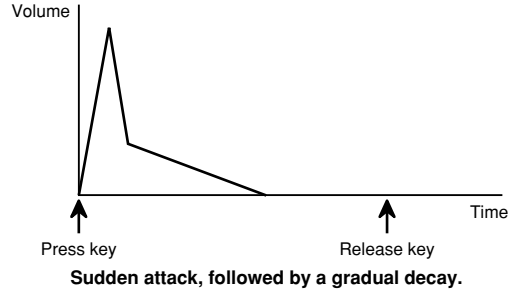
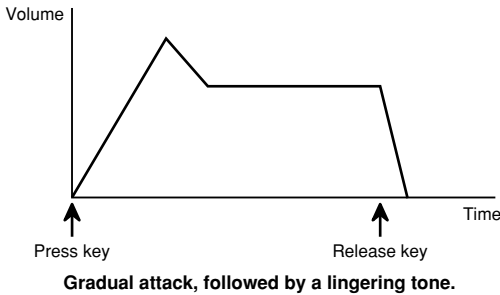

(3) Tone Pitch Parameters

■ Pitch

This parameter controls the overall pitch of the tone.

■ Pitch Envelope Set

This parameter provides a variety of pitch envelopes from which you can choose.

■ NOTE ■

Pitch envelope 00 selects "No change (flat)," 01 through 17 selects "Vibrato," and 18 through 45 selects "Other."

(4) Volume, Tone Quality, Parameters

■ Attack Rate

This parameter lets you set the speed of the attack (the period from the point when you press a key to the point that the tone reaches its maximum volume). Use this parameter to make fine adjustments to the tone characteristics of the amp envelope you are using.

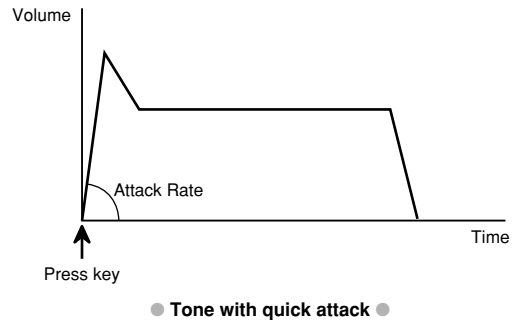
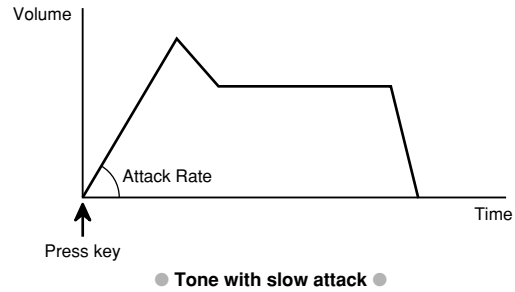

■ Release Rate

This parameter controls the speed of a tone's release (the period from the point when you release a key to the point that the tone stops sounding). Use this parameter to make fine adjustments to the tone characteristics of the amp envelope you are using.

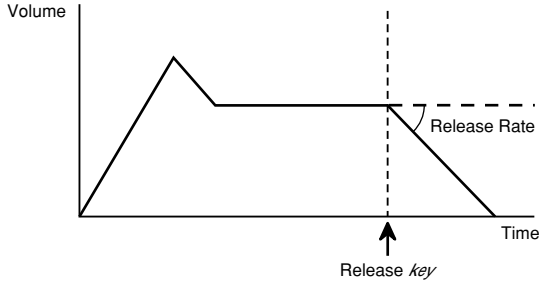

● Tone with slow release ●

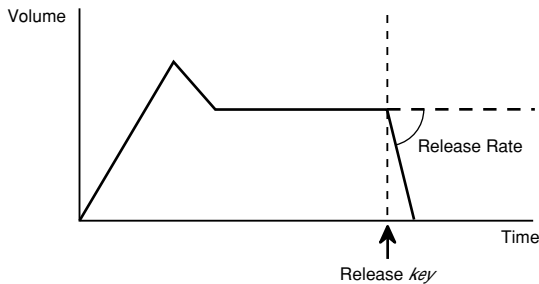

● Tone with quick release ●

■ Level

This parameter controls the overall volume of the tone.

■ Touch Sensitivity

This parameter controls changes in the volume of the tone in accordance with pressure applied to the keyboard keys. You can specify more volume for stronger and less volume for lighter pressure, less volume for stronger pressure, or the same volume regardless of how much pressure is applied to the keys.

■ Filter Sensitivity

This parameter uses a digital filter to controls change in the quality of the tone in accordance with pressure applied to the keyboard keys.

■ Filter Level

This parameter controls how the digital filter is applied.

■ Pan

This parameter controls the stereo center point when using the keyboard's built in speakers and when otherwise producing stereo output.

■ Transpose

This parameter controls how much the key of the keyboard should be raised or lowered.

1DCO and 2DCO Tones

"DCO" stands "Digitally Controlled Oscillator," and it represents the smallest unit of sound output by this keyboard. Some of the built-in tones are simple tones (1DCO), and some are layered tones (2DCO). Whenever you select a 2DCO tone as the basis for creating a user tone, remember that you must change the parameters of both of the tones (DCO1 and DCO2) that make up the layered 2DCO tone.

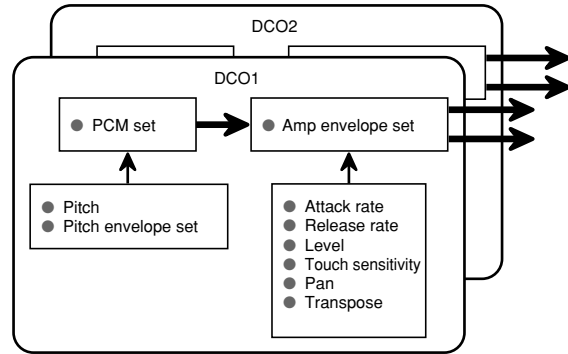

Saving User Tones

The group of tone numbers from 200 through 231 (USER01 through USER32) is called the "user area" because they are reserved for storage of user tones. After you recall a preset tone and change its parameters to create your own user tone, you can store it in the user area for later recall. You can recall your tones using the same procedure that you use when selecting a preset tone.

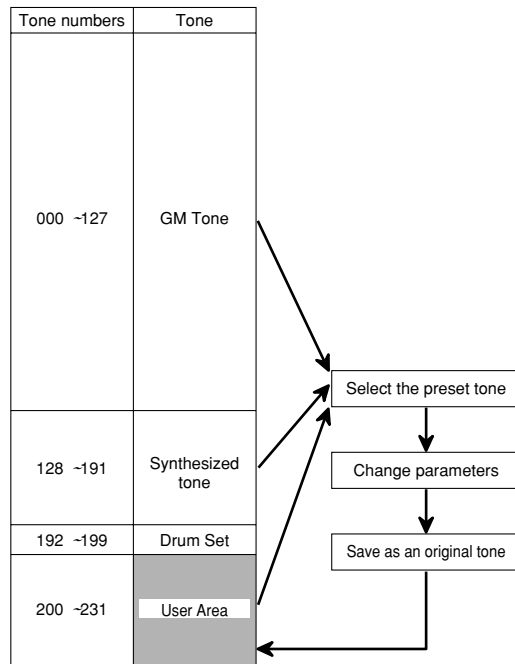

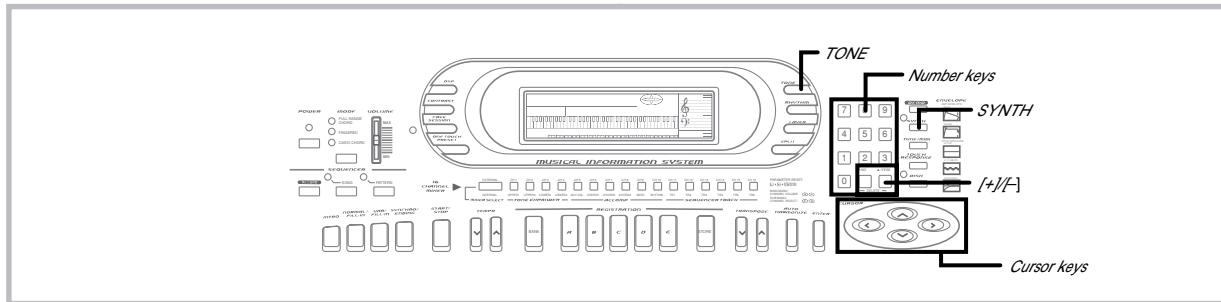

NOTES

- When the keyboard is shipped from the factory, the user area (tones 200 to 231) contain the same tones as tones 128 through 159.
- You cannot use a drum set tone (192 to 199) as the basis of a user tone.
- Whenever you save a tone and assign it one of the tone numbers in the user area, any tone data previously assigned to that number is replaced with the new data.
- The keyboard comes with a built-in lithium battery that supplies power to the memory to retain memory contents while keyboard power is turned off. See "Lithium Battery Precautions" on page E-4 for important information about the lithium battery.
- You can use the keyboard's MIDI capabilities to save your original tones to a computer or other external storage device. See "Bulk Sending Keyboard Data" on page E-65 for details.
- With the WK-1800, you can use the built-in disk drive to save original tones to diskette. See "Using the Floppy Disk Drive (WK-1800 Only)" on page E-67 for details.

Creating a User Tone

Use the following procedure to select a preset tone and change its parameters to create a user tone.

1. First, select the preset tone you want to use as a basis for your user tone.

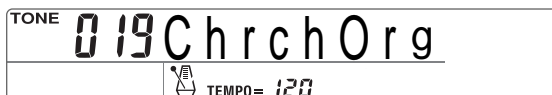

2. Press the **SYNTH** button.
 - This causes the indicator lamp next to the SYNTH button to light and displays a screen that shows whether the tone you selected is a DCO1 or DCO2 tone.

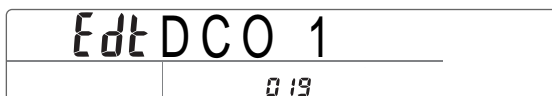

3. Use [**◀**] and [**▶**] to display the parameter whose setting you want to change.



- Each press of [**◀**] or [**▶**] changes to the next parameter. See "Parameters and Their Settings" on this page for information about each parameter.

4. Use [**+**] and [**-**] to change the setting of the currently displayed parameter.
 - You can also use the number keys to input a value to change a parameter setting. See "Parameters and Their Settings" below for information on setting range for each parameter.
5. If the preset tone you selected in step 1 is a 2DCO tone, press [**▼**] twice to display the DCO2 parameters.

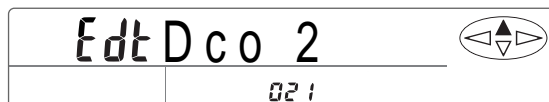

6. Repeat steps 3 and 4 to set the DCO2 parameters.
 - Press [**▲**] two more times to return to the DCO1 parameters.
7. Play something on the keyboard.
 - To save the tone you created, perform the procedure under "Naming a User Tone and Storing It In Memory" (page E-35), starting from step 2.
 - To exit user tone creation and return the tone to its original parameters, press the **SYNTH** button twice or the **TONE** button once.

Parameters and Their Settings

The following describes the function of each parameter and also shows its setting range.

■ **PCM Set (000 to 288)**

This parameter switches the digitally sampled waveform.

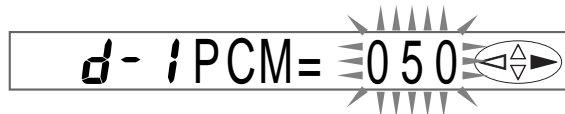

■ **Amp Envelope Set (000 to 288)**

This parameter controls volume characteristics over time.

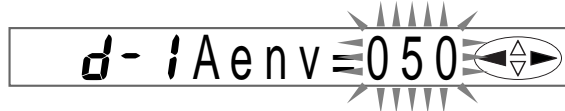

■ **Attack Rate (001 to 127)**

This parameter controls the speed of the attack. The greater the value, the faster the attack of the selected amp envelope.



■ Release Rate (001 to 127)

This parameter controls the speed of a tone's release. The greater the value, the faster the release of the selected amp envelope.



■ Pitch Envelope Set (00 to 45)

This parameter controls the pitch of a tone over time.

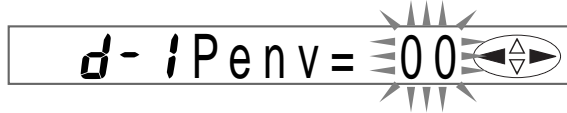

■ Pitch (-64 to 63)

This parameter controls the overall pitch of the tone. A greater positive value raises the pitch from standard, while a negative value lowers the pitch. A setting of zero sets the pitch to the standard setting for the selected tone.

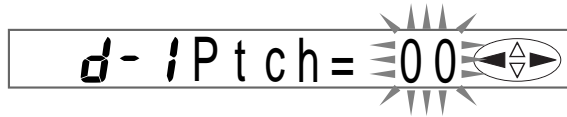

■ Transpose (-12 to 12)

This parameter raises and lowers overall tuning by semitone units. A setting of -12 is one octave lower, while 12 is 1 octave higher.

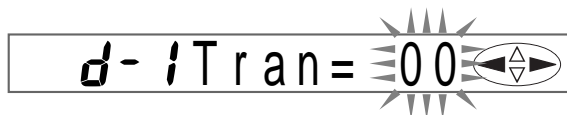

■ Level (000 to 127)

This parameter controls the overall volume of the tone. The greater the value, the greater the volume. Setting a level of zero means that the tone does not sound at all.



■ Touch Sensitivity (-64 to 63)

This parameter controls changes in the volume of the tone in accordance with the pressure applied to the keyboard keys. A greater positive value increases the volume of the output as pressure increases, while a negative value decreases volume with increased keyboard pressure. A setting of zero specifies no change in output volume in accordance with keyboard pressure.

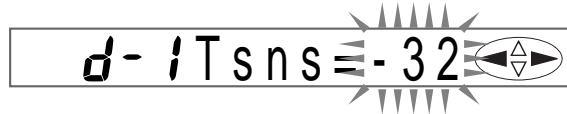

■ Pan (-64 to 63)

This parameter controls the stereo center point when using the keyboard's built-in speakers and when otherwise producing stereo output. A larger value moves the center point to the right, while a smaller value moves it to the left.

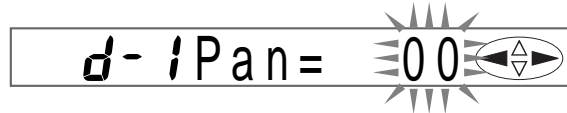

■ Filter Sensitivity (000 to 127)

This parameter controls changes in the quality of the tone in accordance with pressure applied to the keyboard keys. A greater value increases the change in tone quality as pressure increases, while a smaller value decreases the change in tone quality. A setting of zero specifies no change.



■ Filter Level (000 to 127)

This parameter controls the extent to which the digital filter is applied. The greater the value, the more open the filter and the clearer the sound produced. A smaller value softens the sound.

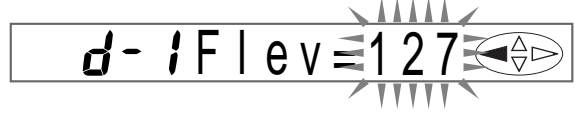

User Tone Creation Hints

The following hints provide helpful advice on making user tone creation a bit quicker and easier.

Use a preset tone that is similar to the one you are trying to create. Whenever you already have a rough idea of the tone you are trying to create, it is always a good idea to start with a preset tone that is similar. If you want to use a layered tone, start out with a 2DCO tone.

Determine the most important parameter.

The PCM Set and Amp Envelope Set parameters are the major factors that determine the overall personality of a tone. Start out with these two parameters to get the general sound you want, and then use the other parameters to add the finishing touches.

Experiment with various different settings.

There are no real rules about what a tone should sound like. Let your imagination run free and experiment with different combinations. You may be surprised at what you can achieve.

DATA EXAMPLE

Tone Name Base tone number

No.	Parameter	Range of Value	DCO1	DCO2
1	PCM Set	000 ~ 288	244	245
2	Amp Envelope Set	000 ~ 288	244	245
3	Attack Rate	001 ~ 127	087	087
4	Release Rate	001 ~ 127	027	027
5	Pitch Envelope Set	00 ~ 45	00	00
6	Pitch	-64 ~ 00 ~ 63	00	00
7	Transpose	-12 ~ 00 ~ 12	00	00
8	Level	000 ~ 127	087	090
9	Touch Sense	-64 ~ 00 ~ 63	-09	59
10	Pan	-64 ~ 00 ~ 63	-63	63
11	Filter Sense	000 ~ 127	000	118
12	Filter Level	000 ~ 127	079	087

◆Press keys hard/soft

Tone Name Base tone number

No.	Parameter	Range of Value	DCO1	DCO2
1	PCM Set	000 ~ 288	112	113
2	Amp Envelope Set	000 ~ 288	112	113
3	Attack Rate	001 ~ 127	089	115
4	Release Rate	001 ~ 127	028	028
5	Pitch Envelope Set	00 ~ 45	00	00
6	Pitch	-64 ~ 00 ~ 63	-04	04
7	Transpose	-12 ~ 00 ~ 12	00	00
8	Level	000 ~ 127	087	095
9	Touch Sense	-64 ~ 00 ~ 63	63	63
10	Pan	-64 ~ 00 ~ 63	00	00
11	Filter Sense	000 ~ 127	019	019
12	Filter Level	000 ~ 127	075	095

◆Hold down keys

Naming a User Tone and Storing It In Memory

The following procedure shows how to assign a name to a user tone and store the tone in memory. Once a tone is stored, you can call it up just as you do with a preset tone.

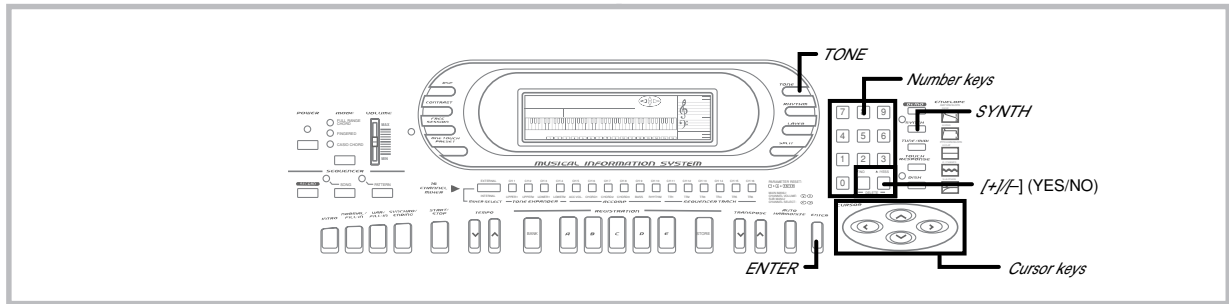

To name a user tone and store it in memory

1. Select a preset tone to use as the basis for the user tone. Next, press the **SYNTH** button and change the parameter settings to create your tone.
2. After making parameter settings to create the user tone, press the **SYNTH** button.
 - This causes the message "Save?" to appear on the display.



- To abort the save operation without saving anything, press NO, which causes the message "Delete?" to appear on the display. Press NO to return to the parameter setting screen without deleting the tone.
- Pressing YES while the "Delete?" message is on the screen deletes the tone and exits the Synthesizer.

3. Press **YES** in response to the "Save?" message to display the destination user area tone number.

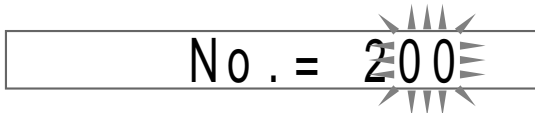

4. Use the **number keys** to change the user area tone number on the display until the one where you want to store the tone is shown.
 - You can select any tone number from 200 to 231.

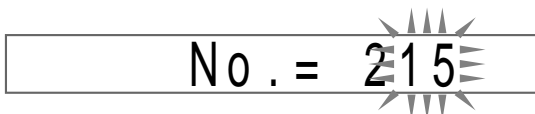

5. Press **ENTER**.
 - This displays the user tone input screen to appear, with the first character of the default tone name flashing, which indicates that you can input letters.
 - If you do not want to assign a name, skip steps 6 and 7.



6. Use **[+]** and **[-]** and the **number keys** to display the first character of the name.
 - **[+]** and **[-]** input alpha characters, while the number keys input numerals.



7. Press **[▶]** to move to the next character. Repeat step 6 to input the rest of the characters of the name.



8. Press **ENTER** to save the user tone.

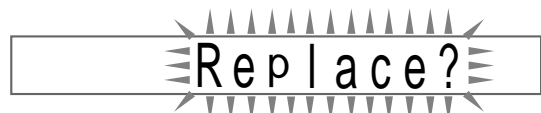

- Press YES to save the new tone and replace any tone data already assigned to the tone number you selected. Pressing NO does not save the tone and returns to the screen in step 2, above.
- To cancel the save operation and exit the Synthesizer, press SYNTH or TONE. Pressing the SYNTH button again (before selecting another tone) returns to the Synthesizer with all of your parameter settings still in place.

NOTE

Auto Harmonize, layer, split, Auto Accompaniment, demo tunes, Song Sequencer, Pattern Sequencer, MIDI, and floppy disk (WK-1800 only) operations are all disabled while you are using the Synthesizer.

Letters and Numerals

The table below shows the letters and numerals that you can input for a tone name.

A	B	C	D	E	F	G	H	I	J
K	L	M	N	O	P	Q	R	S	T
U	V	W	X	Y	Z	!	#	\$	%
&	'	()	-	@	^	_	{	}
'	0	1	2	3	4	5	6	7	8
9									

Registration Memory

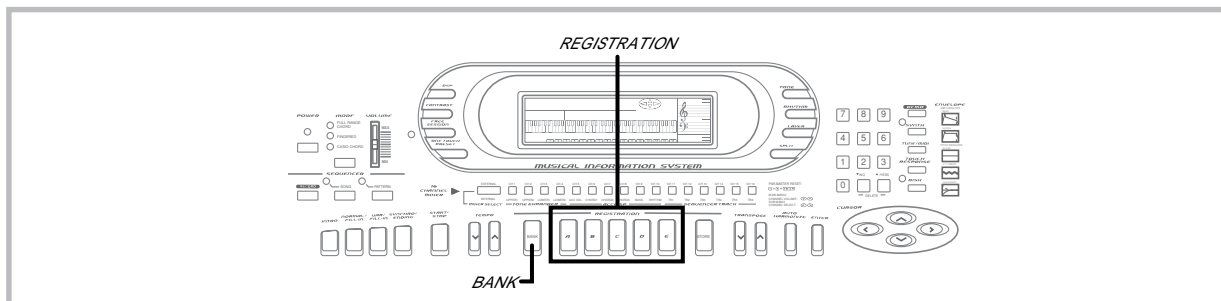

Registration Memory Features

Registration memory lets you store up to 20 (5 sets x 4 banks) keyboard setups for instant recall whenever you need them. The following is a list of settings that are saved in registration memory.

Registration Memory Settings

- Tone
- Rhythm
- Tempo
- Split on/off
- Split point
- Layer on/off
- Auto Harmonize on/off
- Mixer settings
- Keyboard channel on/off
- DSP (digital effect) on/off
- DSP (digital effect) settings
- Accompaniment mode
- Touch Response settings
- Assignable jack setting
- Transpose
- Tuning
- Pitch Bend range
- Sound range shift on/off

NOTES

- Registration memory functions are disabled while you are using the Synthesizer, Song Sequencer, Pattern Sequencer, demo tune function, or floppy disk operations (WK-1800 only).
- Registration memory contains factory default setups when you first purchase the keyboard and after you initialize the keyboard (page E-15). Try recalling some of the default setups to see what they do.

Setup Names

Set ups are stored into registration memory by assigning them names. Each setup name consists of a bank number from 0 to 3, followed by a letter from A to E. The 20 setup names range from 0A through 3E as shown below.

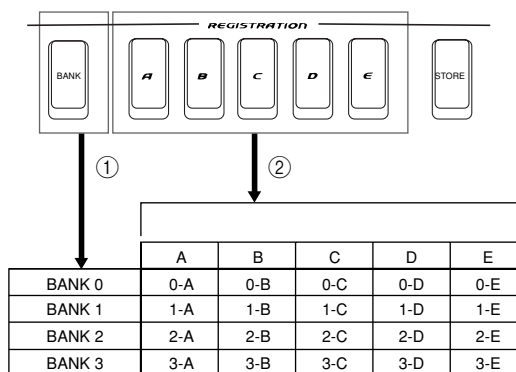

- ① Use the BANK button to select the bank. Each press of BANK cycles through the bank numbers from 0 to 3.
- ② Use the REGISTRATION buttons to specify the letter part of the setup name.

NOTES

- Whenever you save a setup and assign it a setup name, any setup data previously assigned to that name is replaced with the new data.
- The keyboard comes with a built-in lithium battery that supplies power to the memory to retain memory contents while keyboard power is turned off. See "Lithium Battery Precautions" on page E-4 for important information about the lithium battery.
- You can use the keyboard's MIDI capabilities to save your setup data to a computer or other external storage device. See "Bulk Sending Keyboard Data" on page E-65 for details.
- With the WK-1800, you can use the built-in disk drive to save setup data to diskette. See "Using the Floppy Disk Drive (WK-1800 Only)" on page E-67 for details.

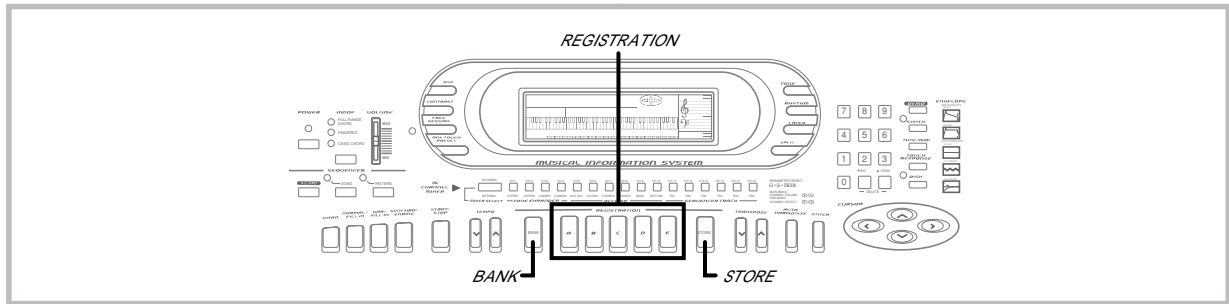

To Save a Setup in Registration Memory

1. Select a tone and rhythm, and otherwise set up the keyboard the way you want it.
 - See "Registration Memory Settings" on page E-37 for details on what data is stored in the registration memory.
2. Use the **BANK** button to select the bank you want.
 - If you do not perform any operation for about five seconds after pressing the BANK button, the display returns to the contents in step 1, above.
 - Bank 0 selected.

0-Bank

- Bank 1 selected.

1-Bank

3. While holding down the **STORE** button, press a **REGISTRATION** button.
 - The following display appears when you press the **B** button.

1B Store

4. Release the **STORE** and **REGISTRATION** button.

NOTES

- The setup is saved as soon as you press a REGISTRATION button in step 3, above.
- With the WK-1800, you can batch save all setups to diskette. See "Using the Floppy Disk Drive (WK-1800 Only)" on page E-67 for details.

To Recall a Setup from Registration Memory

1. Use the **BANK** button to select the bank.
 - If you do not perform any operation for about five seconds after pressing the BANK button, the keyboard automatically clears the registration memory recall screen.

1-Bank

2. Press the **REGISTRATION** button to input the letter part of the setup name.

1B Recall

- The setup name along with the message "Recall" appear on the display for about five seconds.

NOTE

If you press a REGISTRATION button without using the BANK button to select a bank first, the last bank number selected is used.

Using the Song Sequencer

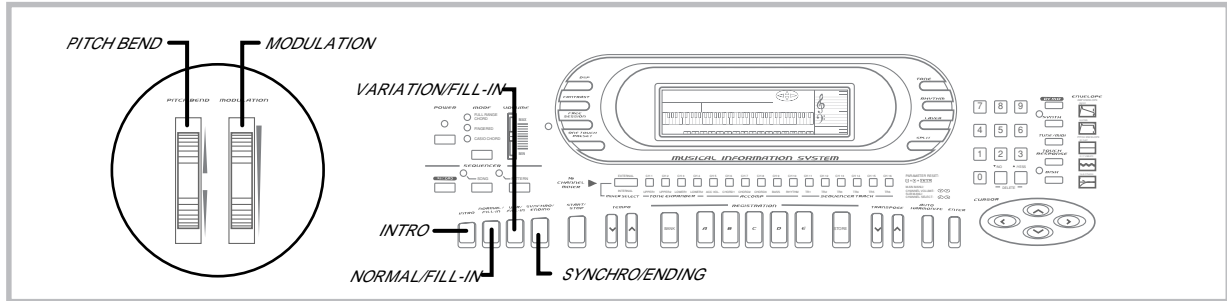

The built-in Song Sequencer lets you record up to two separate songs in memory for later playback.

Songs and Tracks

The Song Sequencer records and plays back much like a standard tape recorder. You can have up to two separate, independent songs in Song Sequencer memory at the same time. Each song is made up of a total of six tracks, each of which can be recorded separately. Then when you play back the tracks together, it sounds like an entire group of musicians, each playing a different part.

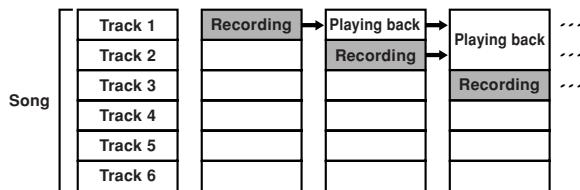

As shown in the illustration above, you add tracks one-by-one while listening to the tracks you recorded previously.

NOTES

- With this keyboard, Track 1 can be used to record keyboard play and Auto Accompaniment. Tracks 2 through 6 can be used for keyboard play only, so they are called melody tracks. As shown in the illustration above, you record Tracks 2 through 6 while listening to what you have already recorded up to that point.
- Note that each track is independent of the others. This means that even if you make a mistake while recording, you only need to re-record the track where the mistake was made.
- Tone settings can be changed during recording, and each tone change is recorded in the applicable track. This means you can have up to six different instrument parts in one song.

Recording

There are two methods you can use to record with the Song Sequencer: real-time recording and punch-in recording.

Real-time Recording

With this method, notes are recorded as you play them on the keyboard.

Punch-in Recording

This method lets you re-record from a specific section of a song that is already in memory. You can use punch-in recording to correct mistakes you made during real-time recording.

Global Settings and Operations

A global setting or operation is one that affects all the tracks that make up a song. The following is a list of the global settings and operations.

- Metronome setting
- Song delete
- Meter setting
- Initial tempo value
- Quantize setting after recording

See "Global Settings and Operations" on page E-45 for full details on what each setting and operation does, and how to use them.

Song Sequencer Data

The type of data that is stored by the Song Sequencer during a recording operation depends on whether you are using real-time recording or punch-in recording. The same type of data is recorded regardless of the track, except that only Track 1 records Auto Accompaniment.

Real-time Recording – Track 1 Only

The following data is recorded by Track 1 in addition to the data listed described under "Real-time Recording – All Tracks" below.

- Rhythm pattern and rhythm pattern changes during recording
- INTRO, SYNCHRO/ENDING, NORMAL/FILL-IN, VARIATION/FILL-IN button operations
- Chords played on the accompaniment keyboard

Real-time Recording – All Tracks

- Notes played on the keyboard
- Initial tone setting and any changes made during recording
- PITCH BEND Wheel operations
- MODULATION Wheel operations
- Pedal operations (when an optional pedal is connected)

Punch-in Recording – Track 1 Only

The following data is recorded by Track 1 only during punch-in recording.

- Rhythm pattern changes during recording
- Chord specifications
- INTRO, SYNCHRO/ENDING, NORMAL/FILL-IN, VARIATION/FILL-IN button operations

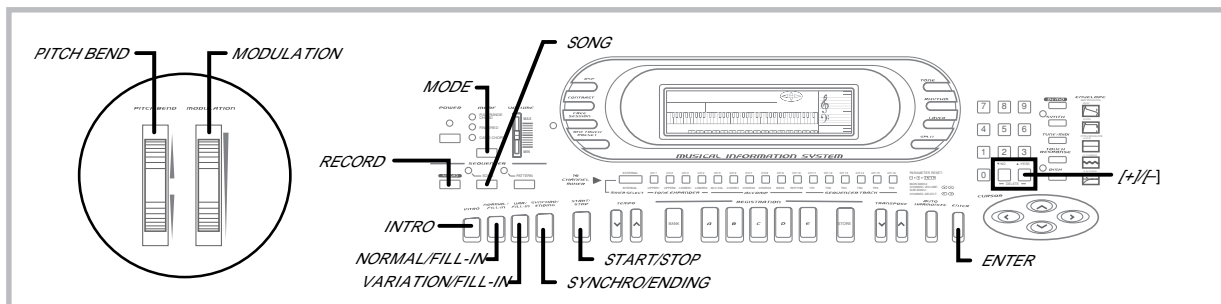

Punch-in Recording – Tracks 1 through 6

- Notes played on the keyboard
- Initial tone setting and any changes made during recording
- PITCH BEND Wheel operations
- MODULATION Wheel operations
- Pedal operations (when an optional pedal is connected)

Unrecorded Data

The following data is not recorded by the Song Sequencer.

- Touch Response on/off setting
- One-touch preset operations
- Registration memory operations
- Free Session
- Layer, split, Auto Harmonize settings

One-time Only Settings

Tempo

Only one tempo setting can be made at the beginning of the recording. Tempo cannot be changed while recording is in progress.

Mixer (CH11 to CH16)

Mixer settings can be made at the beginning of the recording only, but they can be changed after the recording is complete. The Mixer settings in effect when you enter record standby are the ones that are recorded.

Song Sequencer Memory Capacity

Song Sequencer memory capacity depends on the keyboard model.
WK-1800 : 8,000 notes

WK-1600/1630 : 4,900 notes

- Available notes can all be used for a single song, or divided between two songs.
- The measure number (item 11 on page E-10) and beat number (item 10 on page E-10) flashing on the display during recording indicates that memory is almost full (space for about 100 notes or less remaining).
- Recording stops automatically as soon as memory becomes full. Auto Accompaniment and rhythm pattern play also stops at this time if you are using them.

Song Sequencer Memory Precautions

Note the following important points about data stored in Song Sequencer Memory.

- Recording to a track that already contains data replaces the previous recording with the new one.
- The keyboard comes with a built-in lithium battery that supplies power to the memory to retain Song Sequencer memory data. If this lithium battery goes dead, memory contents are deleted any time keyboard power is turned off. The normal life of the original battery is five years from the time it is loaded at the factory. It is up to you to contact your nearest CASIO service provider about having the lithium battery replaced periodically. Note that the cost for battery replacement will be charged to you.

- Turning off the keyboard while a record operation is in progress causes any data partially recorded to a track to be deleted.
- Song Sequencer memory contents can be sent to a computer or other external device as MIDI data for storage. See “Bulk Sending Keyboard Data” on page E-65 for details.
- With the WK-1800, you can also store Song Sequencer memory data on a floppy diskette. See “Using the Floppy Disk Drive (WK-1800 Only)” on page E-67 for details.

Song Sequencer Modes

The song sequencer has two modes: a Record/Playback Mode for real-time recording, punch-in recording, and song playback, and a Global Mode. The following illustration shows how each of these modes is indicated.

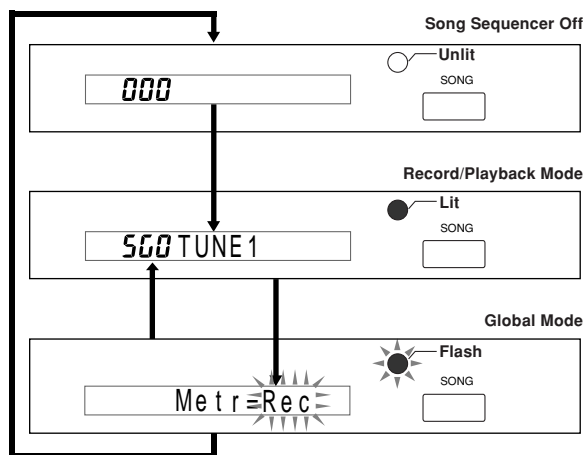

- The indicator lamp above the SONG button is off when the Song Sequencer is turned off.
- Pressing the SONG button once turns on the Song Sequencer and enters the Record/Playback Mode. The indicator lamp above the SONG button turns on at this time.
- Pressing the SONG button again changes to the Global Mode, which causes the indicator lamp above the SONG button to flash.
- Pressing the SONG button exits the Global Mode.
- Pressing the ENTER button in the Global Mode returns to the Record/Playback Mode.

Real-time Recording

Note that the procedure you use for Track 1 is different from that for Tracks 2 through 6.

PREPARATION

- Determine the tones and rhythms (if any) that you want to use.
- Use the MODE button to select the Auto Accompaniment mode you want to start recording with. If you do not want to start with Auto Accompaniment, select OFF.
- Set the tempo that you want to use during recording.

NOTES

- You can change the tone and rhythm while recording is in progress. Any changes you make become part of the recorded data.
- The tempo you use for recording does not affect the tempo of the playback. This means you can record at a very slow tempo for easy play, and then speed up the tempo for playback.
- If you are using a rhythm pattern, notes are recorded using the meter (time) of the rhythm pattern. If you are not using a rhythm pattern, you must set the meter yourself using the procedure under "Meter (3)" on page E-46.
- The following procedure shows the most basic operations for real-time recording to Track 1. For other variations, see "Track 1 Real-time Recording Variations" on this page.

To use real-time recording in Track 1

- Press the **SONG** button once.
 - This causes the indicator lamp above the SONG button to light.
- Select the user song area to which you want to record.
 - Use [+] and [-] to select User Song Area 0 (SG0) or User Song Area 1 (SG1).



- Change Mixer settings (CH1) if you want. The Mixer settings you make for CH1 are copied to Track 1 during recording.

- Press the **RECORD** button to enter record standby.
 - The REC indicator and the frame around the CH11 (Track 1) flashes on the display.

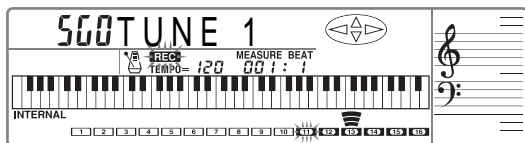

- Track 1 (CH11) is automatically selected as the record track whenever you enter record standby.
- Channels CH 11 through CH 16 of the level meter show which tracks already contain recorded data. See "Level Meter During Record Operations" on page E-44 for details on how to read the level meter.

- Make any tone, rhythm, or accompaniment mode setting you want.
- Press the **START/STOP** button to start recording.
 - At this time the REC indicator stops flashing.
 - The metronome normally sounds during recording. If you want to turn off the metronome, use the procedure under "Metronome Setting (1)" on page E-46.
- Play the notes you want to record on the keyboard.
 - Chords played on the accompaniment keyboard in accordance with the accompaniment method selected with the MODE button are also recorded in Track 1.
 - PITCH BEND Wheel and pedal operations are also recorded. See "Real-time Recording—All Tracks" on page E-39 for details.

- After you are finished playing, press **START/STOP** again to stop recording.
 - The REC indicator clears from the display when recording is stopped.
 - Pressing START/STOP again at this point plays back the song that you just finished recording. See "Playing Back from Song Sequencer Memory" on page E-45 for details on song playback.

NOTES

- Real-time recording to a track that already contains data replaces the previous recording with the new one.
- If you make a mistake while recording, you can either record over again from step 1, or you can use punch-in recording (page E-42) to correct them.
- If you change the rhythm pattern part way through real-time recording, the meter value indicated on the display remains unchanged, even if the new rhythm has a different meter.

Track 1 Real-time Recording Variations

The following describes a number of different variations you can use when recording to Track 1 using real-time recording. All of these variations are based upon the procedure described under "To use real-time recording in Track 1" on this page.

To record without rhythm

Skip step 5. Real-time recording without a rhythm starts when you press a keyboard key.

To start recording with synchro start

In place of step 5, press the SYNCHRO/ENDING button. Auto-accompaniment and recording will both start when you play a chord on the accompaniment keyboard.

To record using an intro, ending, or fill-in

During recording, the INTRO, SYNCHRO/ENDING, NORMAL/FILL-IN, and VARIATION/FILL-IN buttons (page E-24 to 25) can all be used to perform their normal operation.

To synchro start Auto Accompaniment with an intro pattern

In place of step 5, press the SYNCHRO/ENDING button and then the INTRO button. Auto Accompaniment will start with the intro pattern when you play a chord on the accompaniment keyboard.

To start Auto Accompaniment part way into a recording

In place of step 5, press the SYNCHRO/ENDING button and then start playing on the melody keyboard to start recording without accompaniment. When you reach the point where you want accompaniment to start, play a chord on the accompaniment keyboard to start Auto Accompaniment.

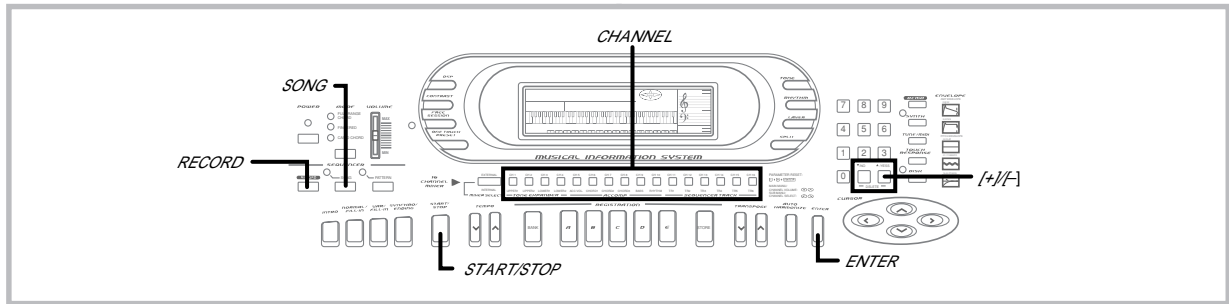

To use real-time recording in Tracks 2 through 6

NOTE

If you are performing real-time recording in Tracks 2 through 6 immediately after you finished real-time recording in Track 1, skip steps 1 and 2 of the following procedure.

1. Press the **SONG** button once.
 - This causes the indicator lamp above the SONG button to light.
2. Select the user song area to which you want to record.
 - Use [+] and [-] to select User Song Area 0 (SG0) or User Song Area 1 (SG1).
 - Change Mixer settings for the channel if you want. The Mixer settings you make for the channel are copied to applicable track during recording.
3. Press the **RECORD** button to enter record standby.
 - The REC indicator appears, and the frame around the currently selected channel (track) flashes on the display.

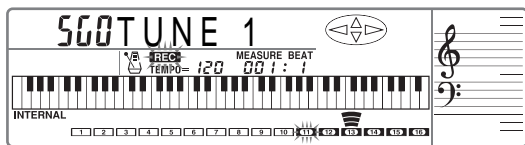

- Channels CH 11 through CH 16 of the level meter show which tracks already contain recorded data. See "Level Meter During Record Operations" on page E-44 for details on how to read the level meter.

4. Select the track to which you want to record.
 - Use CHANNEL buttons CH12 (Track 2) through CH16 (Track 6) to select the track you want.

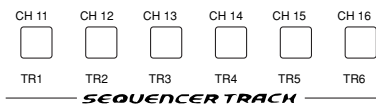

5. Make any tone setting you want.
6. Press the **START/STOP** button to start recording.
 - At this time the REC indicator stops flashing.
 - The metronome normally sounds during recording. If you want to turn off the metronome, use the procedure under "Metronome Setting (M)" on page E-46.
7. Play the notes you want to record on the keyboard.

8. After you are finished, press **START/STOP** to stop recording.
 - The REC indicator disappears from the display when recording is stopped.
9. At this point you can repeat steps 3 through 8 for other tracks, if you want.

Punch-in Recording

Note that the procedure you use for Track 1 is different from that for Tracks 2 through 6.

PREPARATION

- Determine the tones that you want to use.
- Set the tempo that you want to use during recording.

NOTES

- You can change tone and rhythm while recording is in progress.
- The previously recorded rhythm pattern is automatically selected at first, but you can change the rhythm during punch-in recording. Changing the rhythm during punch-in recording, however, may cause the metronome display and rhythm beat to be out of synch with the rhythm that is playing.
- The tempo you use for recording does not affect the tempo of the playback. This means you can record at a very slow tempo for easy play, and then speed up the tempo for playback.

To use punch-in recording in Track 1

1. Press the **SONG** button once.
 - This causes the indicator lamp above the SONG button to light.
2. Select the user song area that contains the song whose contents you want to change using punch-in recording.
 - Use [+] and [-] to select User Song Area 0 (SG0) or User Song Area 1 (SG1).
3. Press the **RECORD** button to enter record standby.
 - The REC indicator appears, and the frame around the CH11 (Track 1) flashes on the display.

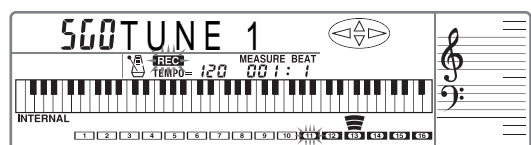

- Channels CH 11 through CH 16 of the level meter show which tracks already contain recorded data. See “Level Meter During Record Operations” on page E-44 for details on how to read the level meter.

4. Make any tone setting you want.
5. Press the **ENTER** button to enter the Punch-in Mode.

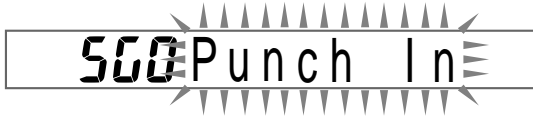

6. Press the **START/STOP** button to start playback of the song in the user song area you selected in step 2.
7. When playback reaches the part you want to change, play the new part on the keyboard.
 - Playback from memory stops and recording begins as soon as you play something on the keyboard.
 - You can change the rhythm setting while recording is in progress.
 - Continue playing until the end of the song.

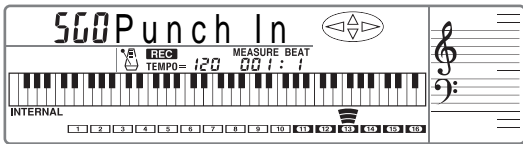

- You can also change Auto Accompaniment chords during punch-in recording by playing chords on the accompaniment keyboard.
- If a synchro start operation is already recorded in Track 1, playing something on the accompaniment keyboard starts rhythm play and records it. See “Synchro Starting Accompaniment with Rhythm Play” on page E-25 or details on using synchro start.

8. After you are finished, press **START/STOP** to stop recording.
 - The REC indicator disappears from the display when recording is stopped.
 - After recording is stopped, you can press the **START/STOP** button to playback what you have just recorded. See “Playing Back from Song Sequencer Memory” on page E-45 for details on the type of data recorded to Song Sequencer memory.

To use punch-in recording in Tracks 2 through 6

NOTE

If you are performing punch-in recording in Tracks 2 through 6 immediately after you finished punch-in recording in Track 1, skip steps 1 and 2 of the following procedure.

1. Press the **SONG** button once.
 - This causes the indicator lamp above the SONG button to light.
2. Select the user song area that contains the song whose contents you want to change using punch-in recording.
 - Use [+] and [-] to select User Song Area 0 (SG0) or User Song Area 1 (SG1).
3. Press the **RECORD** button to enter record standby.
 - The REC indicator appears, and the frame around the CH11 (Track 1) flashes on the display.

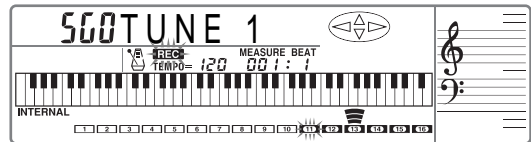

- Channels CH 11 through CH 16 of the level meter show which tracks already contain recorded data. See “Level Meter During Record Operations” on page E-44 for details on how to read the level meter.

4. Select the track whose contents you want to change.
 - Use CHANNEL buttons CH12 (Track 2) through CH16 (Track 6) to select the track you want.

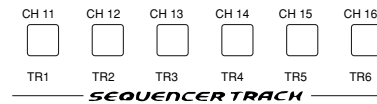

5. Make any tone setting you want.
6. Press the **ENTER** button to enter the Punch-in Mode.



- Pressing the ENTER button again exits the Punch-in Mode.

7. Press the **START/STOP** button to start playback of the song in the user song area you selected in step 2.
8. When playback reaches the part you want to change, play the new part on the keyboard.
 - Playback of the current track stops and punch-in recording starts as soon as you play something on the keyboard.
 - Pressing the ENTER button instead of playing something on the keyboard starts recording of a blank in the selected track (except for the accompaniment of Track 1) until you play something.
 - Continue playing until the end of the song.

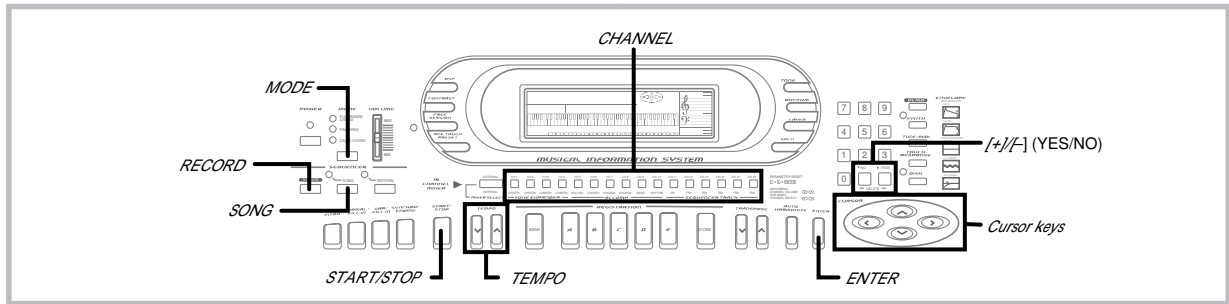

9. After you are finished, press **START/STOP** to stop recording.
 - The REC indicator disappears from the display when recording is stopped.
10. At this point you can repeat steps 3 through 9 for other tracks, if you want.

Playback Tracks

When recording to a track with the Song Sequencer, the contents of any tracks that are already recorded normally play back. These are called playback tracks. You can turn playback tracks on (so they play during recording) or off (so they don't play). See "Turning Channels On and Off" on page E-29 for details.

Level Meter During Record Operations

Channels CH11 through CH16 correspond to Tracks 1 through 6. During record standby, the level meter shows which tracks are already recorded. Three level meter segments indicate a channel is already quoted, while no segment indicates that the channel is empty (unrecorded).

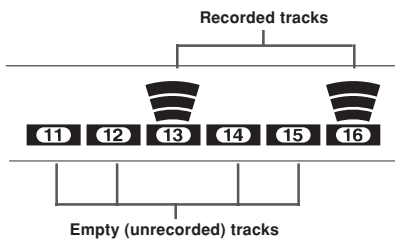

To Delete the Contents of a Specific Track

Note that a track delete operation cannot be undone. Make sure you no longer need the contents of a track before you delete them.

1. Press the **SONG** button once.
 - This causes the indicator lamp above the SONG button to light.
2. Select the user song area that contains the track whose contents you want to delete.
 - Use [+] and [-] to select User Song Area 0 (SG0) or User Song Area 1 (SG1).



3. Press the **RECORD** button to enter record standby.
 - The REC indicator appears, and the frame around the CH11 (Track 1) flashes on the display.

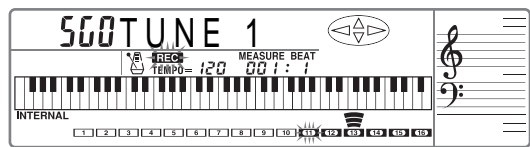

- Channels CH 11 through CH 16 of the level meter show which tracks already contain recorded data. See "Level Meter During Record Operations" on this page for details on how to read the level meter.
4. Select the track whose contents you want to delete.
 - Use CHANNEL buttons CH11 (Track 1) through CH16 (Track 6) to select the track you want.
 5. Press [+] and [-] at the same time.

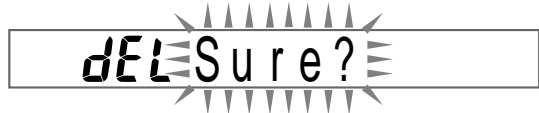

6. Press **YES** to delete the selected track or **NO** to abort the delete operation.



- After a few moments, the keyboard exits the record operation.
- The message "dEL No Data" appears on the display for about one second if the track you selected in step 4 does not contain any data.

Playing Back from Song Sequencer Memory

Use the following procedure when you want to play back the contents of Song Sequencer memory.

- Skip steps 1 and 2 of the following procedure if you have just finished a real-time recording operation.

To play back from Song Sequencer memory

1. Press the **SONG** button once.
 - This causes the indicator lamp above the SONG button to light.
2. Select the user song area that contains the song you want to play back.
 - Use [+] and [-] to select User Song Area 0 (SG0) or User Song Area 1 (SG1).
3. Press the **START/STOP** button to start playback.
 - Use the TEMPO buttons to adjust the playback tempo.
 - See the notes below for other operations you can perform during playback.
4. Press the **START/STOP** button again to stop playback.

NOTES

- Pressing the START/STOP button starts playback from the beginning of the selected song.
- You can play along on the keyboard during Song Sequencer playback. You can use layer, and split for keyboard play.
- You can use the Mixer to adjust the volume level and stereo points of the playback track. Such settings are output from MIDI OUT when they are made.
- You cannot change the MODE button setting during Song Sequencer playback.

Song Sequencer and Mixer Operations

During Song Sequencer playback standby and playback, all four cursor keys and the ENTER button function as Mixer operation buttons. This means you can change Mixer settings for each track for both recording and playback.

Mixer Settings Recorded by Each Track

Mixer settings are recorded independently for each track. Mixer settings are recorded as track data under either of the following two conditions.

- Mixer and bend range settings made for CH1 during Song Sequencer playback standby are recorded to the track selected for recording.
- Mixer settings are saved for the applicable channels regardless of whether they are made during recording or playback.

Mixer Settings During Playback

Selecting a song area causes the Mixer settings recorded for each track to be recalled and assigned to their corresponding channels.

Turning Tracks On and Off

- During playback standby or actual playback, you can turn Tracks 1 through 6 on and off using CHANNEL buttons CH11 through CH16. This means you can select which channels (parts) you want to play or even play back a single channel.
- You can also turn the playback of previously recorded channels on and off during real-time recording.

NOTE

During real-time recording standby, CHANNEL buttons CH11 through CH16 are used to select the record track. This means you cannot use the CHANNEL buttons to turn playback channels on and off during record standby.

Global Settings and Operations

A global setting or operation is one that affects all the tracks that make up a song. The following is a list of the global settings and operations.

- ① Metronome setting
- ② Song delete
- ③ Meter setting
- ④ Initial tempo value
- ⑤ Quantize setting after recording
- ⑥ Quantize execution

To make global settings

1. Press the **SONG** button once.
 - This causes the indicator lamp above the button to light.
2. Select the user song area that contains the song whose global settings you want to change.
 - Use [+] and [-] to select User Song Area 0 (SG0) or User Song Area 1 (SG1).
3. Press the **SONG** button again.
 - This causes the indicator lamp above the button to flash, and the first global setting screen to appear on the display.
4. Use the [◀] and [▶] cursor keys to scroll through the global setting and operation screens.
 - The numbers shown to the left of the sample displays below correspond to the following sections that provide details on each setting.

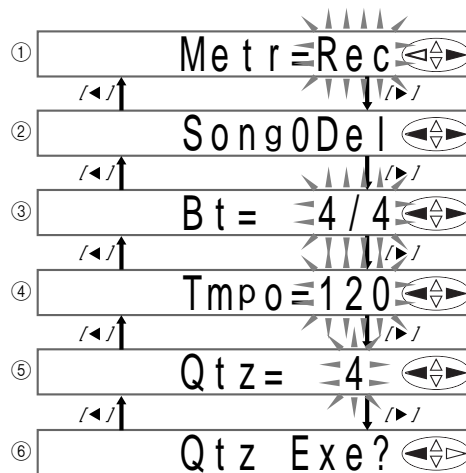

5. When the item you want is on the screen, change it to the setting you want.
 - See the explanations following this procedure for details on making each global setting.
6. After you are finished making a particular setting, press the **ENTER** button to return to the Record/Playback Mode screen.
 - Press [◀] or [▶] in place of ENTER if you want to change to another setting screen and make other settings.

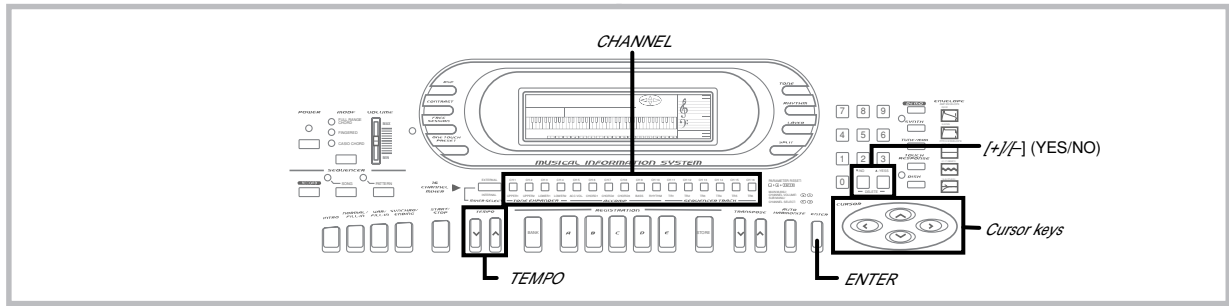

Metronome Setting (①)

This setting controls whether or not the metronome sounds during Song Sequencer real-time recording and playback.

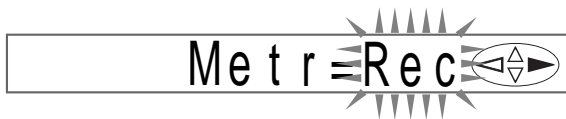

Display Indicator	Meaning
O f f	Metronome off
R e c	Metronome sounds during recording only (initial default setting)
R & P	Metronome sounds during recording and playback

Metronome sound: The first beat is a chime, followed by a standard metronome click for the other beats.

- Use [+] and [-] to change the metronome setting.

Song Delete (②)

Use this operation to delete a song from a specific user song area.

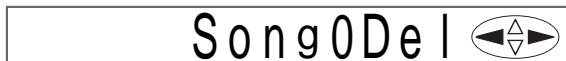

- From the Global menu, use [◀] and [▶] to display the "Song0Del" screen, and then press [+] and [-] at the same time.
 - A message appears to confirm whether you want to delete the song.

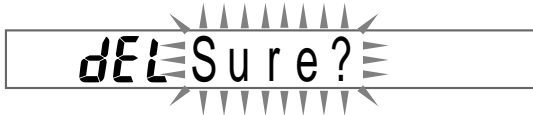

- Press **YES** to delete the song or **NO** to abort the delete operation without deleting anything.
 - Pressing YES causes the message shown below to appear for about one second. Next, the display returns to the Record/Playback Mode screen.



Meter (③)

This setting specifies the meter of the song.

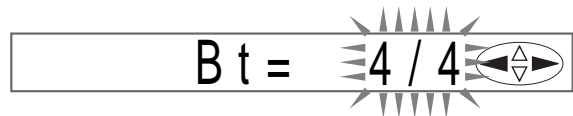

NOTE

If a song is already recorded with a rhythm, the meter of the rhythm is set automatically.

Setting	Setting
2 / 4	3 / 8
3 / 4	5 / 8
4 / 4 (initial value)	6 / 8
5 / 4	7 / 8
6 / 4	9 / 8
7 / 4	

- Use [+] and [-] to change the setting.

Initial Tempo (④)

This setting specifies the initial tempo value for song playback.

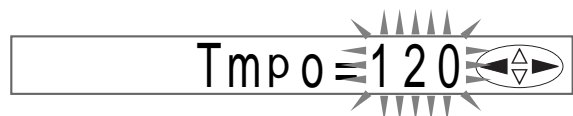

- Use [+] and [-] to set the initial tempo value within the range of 030 to 255.
- The setting you make here does not affect the tempo during real-time recording.
- You can use the TEMPO buttons to change the tempo of a song while it is playing. Pressing both the TEMPO buttons at the same time during song playback returns the tempo to the initial default value you set here.

Record Quantize Setting (⑤)

This setting determines the quantize value after recording. After recording, quantize adjusts the timing of notes input to each track on the keyboard to match those selected by the setting you make here.

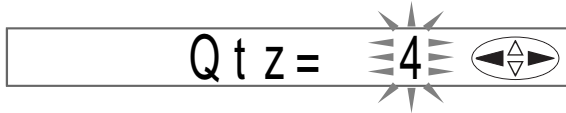

1. Use the **CHANNEL buttons** to select the channel whose quantize setting you want to change.
2. Use **[+]** and **[-]** to change the setting.

Display Indicator	Meaning
4	Quantize quarter notes (initial value)
8	Quantize 8 th notes
8 T	Quantize 8 th triplicate notes
1 6	Quantize 16 th notes
1 6 T	Quantize 16 th triplicate notes
3 2	Quantize 32 nd notes
3 2 T	Quantize 32 nd triplicate notes
6 4	Quantize 64 th notes

Quantize Execute (⑥)

Use this procedure to execute the quantize setting made under "Record Quantize Setting (⑤)" on this page.



1. Use the **[◀]** and **[▶]** **cursor keys** to display the "Qtz Exe?".
 - A message appears to confirm whether you want to execute.
2. Press **YES** to execute or **NO** to abort the operation.
 - Pressing YES causes the message "qt Pls Wait" to appear for about one second. Next, the display returns to the record/playback mode.



Pattern Sequencer

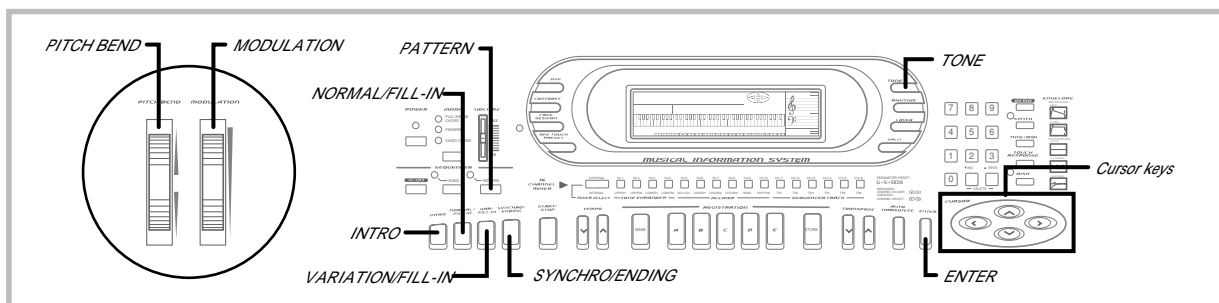

The Pattern Sequencer lets you modify the keyboard's 120 built-in Auto Accompaniment patterns or create your own original pattern from scratch.

Pattern Sequencer Basics

Each Auto Accompaniment pattern is actually a group of six different elements named: normal, intro, variation, normal fill in, variation fill in, and ending. Each element is made up of five parts, named: Rhythm, Bass, Chord 1, Chord 2, and Chord 3. The following table shows the makeup of each element.

Element	Parts				
Intro	Rhythm	Bass	Chord 1	Chord 2	Chord 3
Normal	Rhythm	Bass	Chord 1	Chord 2	Chord 3
Variation	Rhythm	Bass	Chord 1	Chord 2	Chord 3
Normal fill-in	Rhythm	Bass	Chord 1	Chord 2	Chord 3
Variation fill-in	Rhythm	Bass	Chord 1	Chord 2	Chord 3
Ending	Rhythm	Bass	Chord 1	Chord 2	Chord 3

Pattern Sequencer Recording Contents

The Pattern Sequencer lets you record notes for each of the parts that makes up an element. You can alter any of the elements of a built-in Auto Accompaniment, or you can create one or more of your own original elements from scratch.

Content that can be recorded to each part within each element using real-time recording

- Notes played on the keyboard
- PITCH BEND wheel operation (Bend range fixed at 2 for user pattern creation)
- MODULATION wheel operation
- Pedal operation (when an optional pedal is connected)

Content that can be recorded once for each pattern

- Tempo
- Beat (Only when work area is empty.)

Content that can be recorded to each element

- Number of measures
The number of measures for Intro, Normal, Variation, and Ending can be specified only when recording to a blank element. Fill-in is always one measure long, and cannot be changed.
- Fill-in (Cannot change inside one measure.)
- Original key

Content that can be recorded to each part of each element

- Tone (TONE button or Mixer function setting. Cannot change inside element.)
- Pan (Set using Mixer.)
- Effect send (Set using Mixer.)
- Expression (Set using Mixer.)
- Chord conversion table
- Break point

Pattern Sequencer Memory Capacity

WK-1800 : Approximately 6,800 notes

WK-1600/1630 : Approximately 5,800 notes

- The measure number (item 11 on page E-10) and beat number (item 10 on page E-10) flashing on the display during recording indicates that memory is almost full (space for about 100 notes or less remaining).
- Recording stops automatically as soon as memory becomes full.

Element Display Indicators

Indicator	Element	How to Select
	Normal	Press the NORMAL/FILL-IN button to toggle between normal and normal fill in.
	Normal Fill In	
	Variation	Press the VARIATION/FILL-IN button to toggle between variation and variation fill in.
	Variation Fill In	
	Intro	Press the INTRO button.
	Ending	Press the SYNCHRO/ENDING button.

Pattern Sequencer Modes

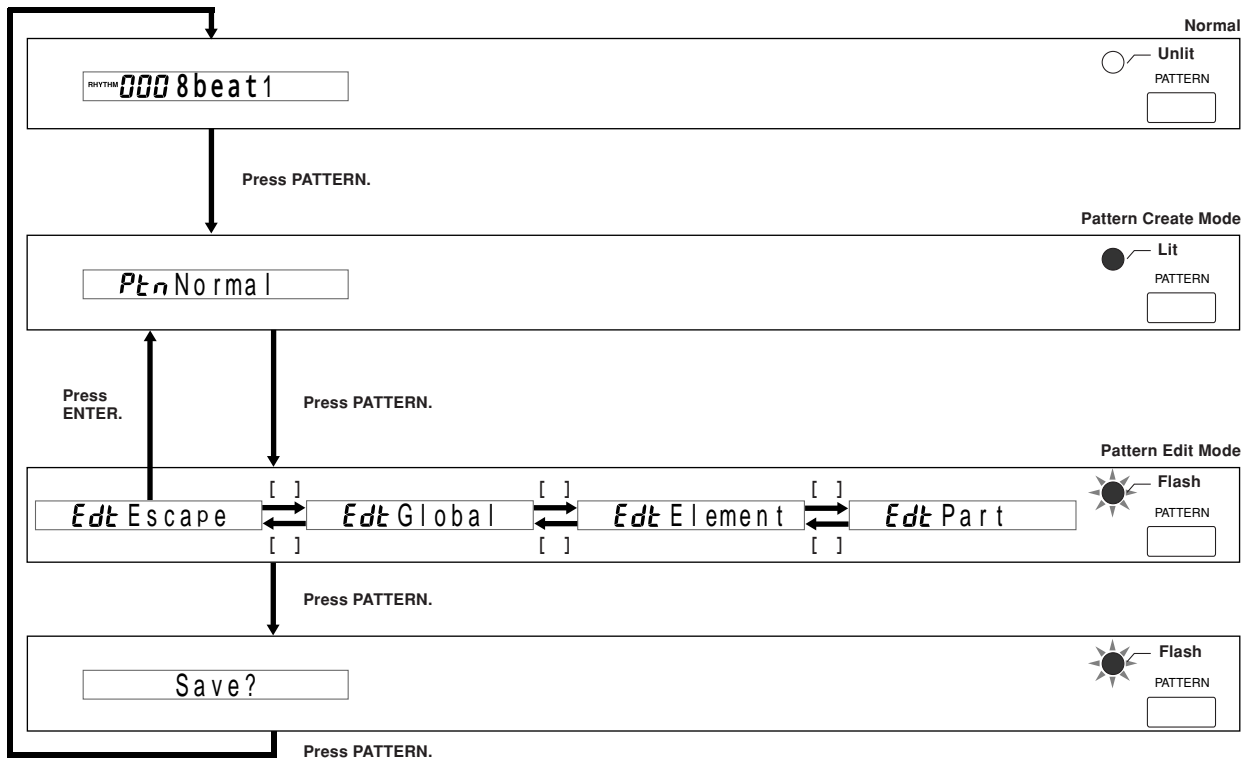

The Pattern Sequencer has two modes: a Pattern Create Mode for recording a new pattern, and a Pattern Edit Mode for changing the settings of a pattern.

After you finish creating or editing a pattern, you store it in memory and assign it a number for later recall.

The following procedure provides the basics for navigating between Pattern Sequencer modes.

To navigate between Pattern Sequencer modes

1. Before turning on the Pattern Sequencer, select the rhythm you want to use as a base for your original rhythm.
2. Press the **PATTERN** button.
 - This enters the Pattern Create Mode, which is indicated when the indicator lamp above the PATTERN button is lit. The indicator "Ptn" in the tone/rhythm number area of the display (item 3 on page E-10) also indicates that the Pattern Create Mode.
 - Entering the Pattern Create Mode copies the rhythm you selected in Step 1 into the Song Sequencer work area. Operations you perform with the Pattern Sequencer affect the pattern that is currently in the work area.
 - If the rhythm pattern you selected in step 1 is too large to fit in the work area, the Message "Ptn Mem Full" appears on the display for about three seconds. After that, the keyboard enters to the Pattern Create Mode with the work area empty. To make more room in the work area for the rhythm pattern, delete user rhythm patterns stored in the user area (pattern numbers 100 through 109) that you no longer need.
 - In the Pattern Create Mode, you can play back the accompaniment pattern in the work area and even record along with the playback. See "Using the Pattern Create Mode" on page E-50 for full details on using the Pattern Create Mode.

3. Press the **PATTERN** button again.

- This enters the Pattern Edit Mode, which is indicated when the indicator lamp above the PATTERN button is flashing. The indicator "Edt" in the tone/rhythm number area of the display (item 3 on page E-10) also indicates the Pattern Edit Mode.
- The Pattern Edit Mode screen can be scrolled between the following three menus with the [▲] and [▼] cursor keys: "Global", "Element", and "Part". In addition to the menus, there is also an Escape screen for exiting the Pattern Edit Mode. Each contains parameters for making settings for the accompaniment pattern in the Pattern Sequencer work area. See "Using the Pattern Edit Mode" on page E-52 for full details on using the Pattern Edit Mode.
- Displaying the Pattern Edit Mode's "Escape" screen and then pressing the ENTER button returns to the Pattern Create Mode in step 2.

4. Press the **PATTERN** button again.

- The indicator lamp above the PATTERN button continues to flash, and the message "Save?" appears on the display. See "Exiting the Pattern Sequencer Mode" on page E-56 for details on how to save Pattern Sequencer data.

* Work Area

- The work area is an area of memory where rhythm pattern data is stored temporarily during recording and editing. After you are finished recording or editing, you can specify whether you want to save work area contents or delete them without saving.

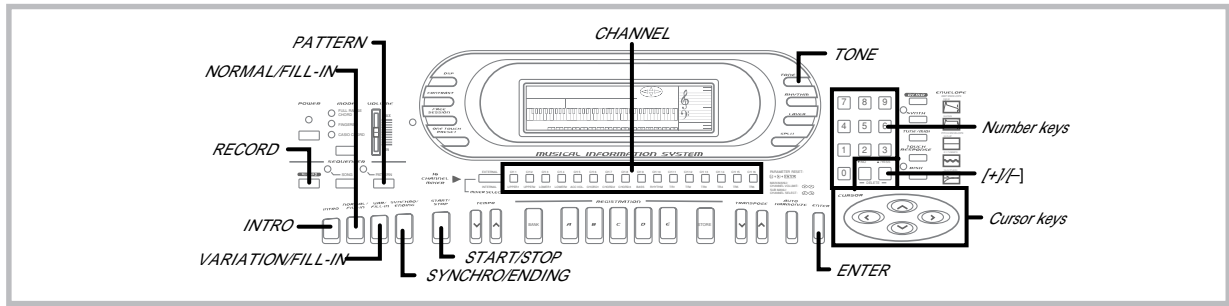

Saving an Edited Pattern

- The 10 rhythm numbers 120 through 129 make up the user rhythm area, where you can store your original rhythms. You can recall a user rhythm with the same operation as that for recalling a built-in pattern, and you can even use a user rhythm pattern as the base for creating a new rhythm pattern.
- The keyboard comes with a built-in lithium battery that supplies power to the memory to retain memory contents while keyboard power is turned off. See "Power Requirements" on page E-15 for important information about the lithium battery.
- You can use the keyboard's MIDI capabilities to save your original accompaniment patterns to a computer or other external storage device. See "Bulk Sending Keyboard Data" on page E-65 for details.
- With the WK-1800, you can use the built-in disk drive to save original accompaniment patterns to diskette. See "Using the Floppy Disk Drive (WK-1800 Only)" on page E-67 for details.
- You can store up to 10 accompaniment patterns in the user area, but the actual number of patterns you will be able to store depends on their sizes. If the patterns you store are relatively large, memory become full after fewer than 10 patterns are stored.

Using the Pattern Create Mode

This section describes how to use the Pattern Create Mode to create an original accompaniment pattern.

IMPORTANT!

The procedures in this section all assume that you have read and are familiar with the information under "Pattern Sequencer Basics" on page E-48, and that you already know how to navigate between Pattern Sequencer modes.

NOTE

Be sure to save your work whenever you quit an accompaniment pattern creation session. See "Exiting the Pattern Sequencer Mode" on page E-56 for details.

Pattern Creation Techniques

You can use either of the two following techniques to create an accompaniment pattern.

- **Base Pattern Editing**
While playing back the part of a built-in pattern or previously created user pattern, you can add or delete notes, or completely delete a part and replace it with a new one.
- **From Scratch**
With this method, you must input all the parts for all the elements you want to use. With this method, you must use the procedure under "Work Area Clear" on page E-54 to clear the Pattern Sequencer work area before you start recording.

The record procedure is identical, no matter which of the above methods you use.

The following procedure tells you how to play back individual elements of the accompaniment pattern currently stored in the Pattern Sequencer work area. If you are going to use the base pattern editing method described above, you can use this procedure to become familiar with all the parts that make up the pattern before you actually start editing it.

To play back elements of the accompaniment pattern in the work area

1. While the Pattern Sequencer is turned off, press the **PATTERN** button once to enter the Pattern Create Mode.

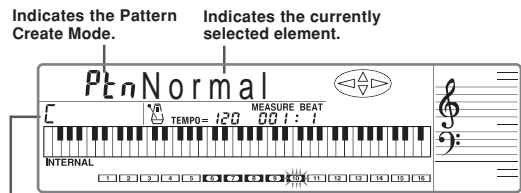

Original Key

2. Select the element you want to play back.
 - The Normal element is always selected first when you initially turn on the Pattern Sequencer.
 - Use the following buttons to select the other elements.
 - NORMAL/FILL-IN Toggles between Normal and Normal Fill-In elements.
 - VARIATION/FILL-IN .. Toggles between Variation and Variation Fill-In elements.
 - INTRO Selects Intro element.
 - SYNCHRO/ENDING ... Selects Ending element.
3. Press the **START/STOP** button.
 - The selected element plays in a loop, repeating itself.
 - The display shows measure and beat numbers during element playback.
 - You can perform the following operations during element playback.
 - Tempo changes
 - Part on and off
 - Mixer operations*1
 - Tone operations*2
4. To stop playback, press **START/STOP** again.

*1 The cursor keys and ENTER button function as Mixer operation buttons during playback. Auto Accompaniment uses internal channels CH6 through CH10, which can be used when making part settings. See "Changing the Parameters of a Channel" on page E-30 for details on using the Mixer to make settings.

*2 You can change the tone setting by pressing TONE button, and then using the number keys, [+], and [-] to specify a tone number. The Pattern Sequencer turns off automatically if you do not perform any operation for about five seconds. You can change the tone settings of each part inside each element.

NOTES

- Pressing the PATTERN button while a pattern is playing stops accompaniment playback and enters the Pattern Edit Mode.
- Use the Mixer to adjust the volume balance between channels. First set the Global Volume parameter to 127. Next, adjust the Expression parameter volume balance. See "Additional Channel Mode Parameters" on page E-31 for details.

To record an accompaniment pattern

PREPARATION

- Select the accompaniment pattern (rhythm) that you want to use as a base.
- Use the procedure under "To play back elements of the accompaniment pattern in the work area" on page E-50 to play back the pattern and become familiar with its elements and parts. During playback, you can practice playing the notes you plan to record.
- Determine the number (120 to 129) you will assign to the new pattern.
- If you want to use the metronome, use the procedure under "Metronome Setting" on page E-53 to select the metronome setting you want.

IMPORTANT!

You cannot record accompaniment patterns converted using the Pattern Conversion Disk. See "Using the Utilities" on page E-71 for details.

NOTE

If you playback the base pattern before recording, skip step 1 in the following procedure.

1. While the Pattern Sequencer is turned off, press the **PATTERN** button once to enter the Pattern Create Mode.

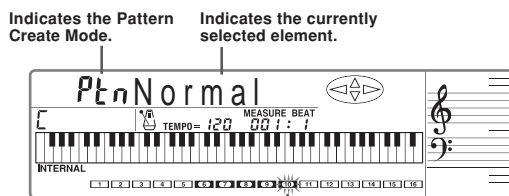

Frames around the channel numbers that correspond to the currently selected parts flash.

2. Select the element you want to record.
 - Use the same procedures as those described for step 2 under "To play back elements of the accompaniment pattern in the work area" on page E-50.
3. Press the **RECORD** button to enter record standby.
 - This causes the REC indicator to appear on the display.
 - If the accompaniment pattern is once converted using the Pattern Conversion Disk, the message "NotCASIO" appears on the display, indicating that it cannot be recorded (WK-1800 only).
4. Select the parts you want to record.
 - The Rhythm part (CH10) is selected initially whenever you turn on the Pattern Sequencer. Use CHANNEL buttons CH6 through CH10 to select parts.
 - The frames around the channel numbers that conform to the currently selected parts flash to show they are selected.
 - Note that you cannot select parts once recording starts. Be sure to select the parts you want before you start recording.
5. Press the **START/STOP** button.
 - At this time the REC indicator stops flashing.
 - All parts of the selected element play back in an endless loop. You can record notes in the currently selected parts.
 - Measure and beat numbers are shown on the display during recording.
 - Pressing any keyboard key starts actual recording.
6. Record in part in sequence.
 - You can perform the following operations during element recording.
 - Turn parts (channels) to be recorded on and off
 - Tempo changes
 - Tone operations*1
 - See "Recording Parts" on this page for details on recording to each part.

7. After you finish recording, press the **START/STOP** button again.
 - This stops recording, which causes the REC indicator to disappear from the display.
8. Repeat steps 2 through 7 for each of the elements of the accompaniment pattern.
9. See "To exit the Pattern Sequencer Mode and save work area contents" on page E-56 for details on how to save patterns.
 - If you want to turn off the Pattern Sequencer without saving anything, perform the procedure under "To exit the Pattern Sequencer Mode without saving work area contents" on page E-57.

*1 You can change the tone setting by pressing TONE button, and then using the number keys to specify a tone number. The tone number input display clears automatically if you do not perform any operation for about five seconds.

NOTES

- You cannot change the selected parts and element while recording is in progress.
- If you are having problems getting the timing right when trying to input notes starting from the first beat of the first measure, skip step 5 (pressing the START/STOP button) of the above sequence. As soon as you play something on the keyboard, recording starts right at the first beat of the first measure.

Recording Parts

The following describes how to record each part. Perform these operations when you reach step 6 of the procedure under "To record an accompaniment pattern" on this page.

NOTES

- See "To delete specific notes" on page E-52 for details on deleting specific notes.
- See "To delete a part" on page E-52 for details on deleting an entire part.
- Bass, Chord 1, Chord 2, and Chord 3 are all normally recorded with a root note of C. Use the procedure under "Setting the Original Key for Each Element" on page E-55 for information about recording with a different root note.

To record the Rhythm part

1. Press **CHANNEL** button CH10 to select the rhythm part.
2. Select a drum sound (tone number 192 through 199).
3. Use the keyboard to play the rhythm part. Use the measure and beat values that appear on the display for timing.

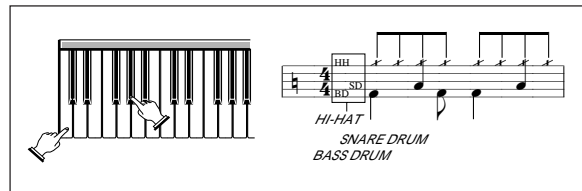

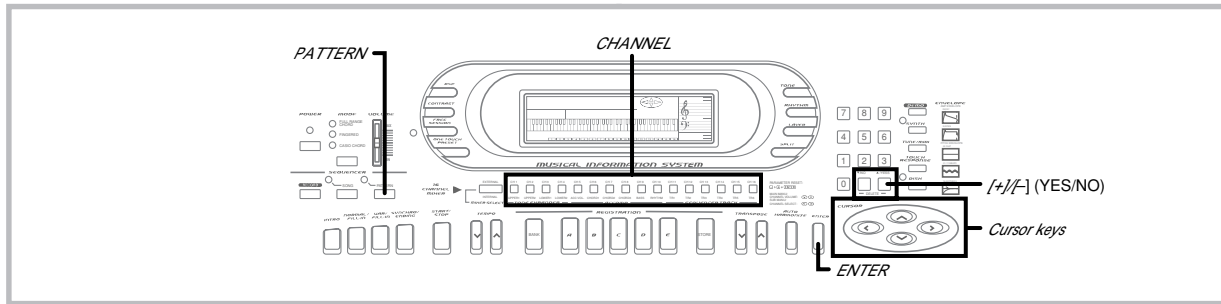

To record the Bass part

1. Press **CHANNEL** button CH9 to select the bass part.
2. Select a bass tone.
3. Use the keyboard to play the bass part. Use the measure and beat values that appear on the display for timing.

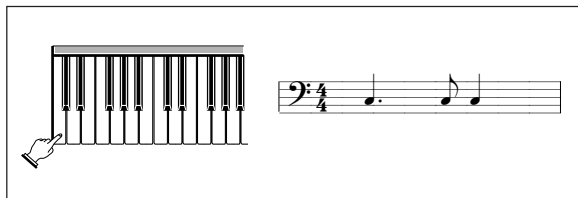

To record Chord 1, 2, and 3 parts

1. Use **CHANNEL** buttons CH6, CH7, and CH8 to select a chord part.
2. Select a chord tone. Use any tone besides the drum sounds.
3. Use the keyboard to play the chord part. Use the measure and beat values that appear on the display for timing.

To delete specific notes

- Play the accompaniment pattern.
- While holding down [+] and [-], press the keyboard key that corresponds to the note you want to delete at the time the note sounds in order to delete it. To get the timing right, you probably should press the keyboard key just before the note sounds. This will delete that single note only.

To delete a part

- During record standby, select the part you want to delete and then press [+] and [-] at the same time. In response to the message "dEL Sure?" that appears on the display, press the YES button to delete all of the contents of the part or NO to abort the delete procedure without deleting anything.

Using the Pattern Edit Mode

This section describes how to use the Pattern Edit Mode to change various settings for a pattern you are currently creating or are about to create.

IMPORTANT!

The procedures in this section all assume that you have read and are familiar with the information under "Pattern Sequencer Basics" on page E-48, and that you already know how to navigate between Pattern Sequencer modes.

To select main menus and sub-menus in the Pattern Edit Mode

1. While in the Pattern Create Mode, press the **PATTERN** button once to enter the Pattern Edit Mode.
 - This causes the indicator lamp above the PATTERN button to flash, and the Global menu to appear on the display.

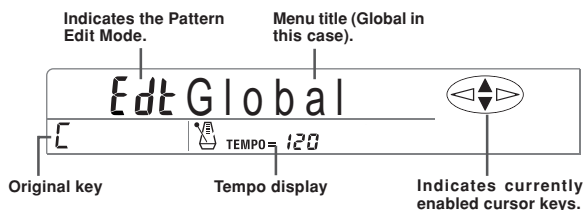

2. Perform the key operations described below to display a different main-menu or sub-menu.
 - Use the [▲] and [▼] cursor keys to move between main-menus.
 - Press the ENTER button, [◀], or [▶] to scroll through the sub-menu of the current main-menu. The sample display below is the Global menu's metronome sub-menu.

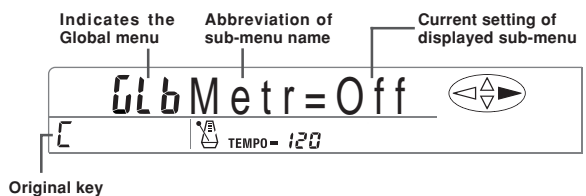

- Use [+] and [-] to change the setting of the sub-menu on the display.
 - To return to a main menu from one of its sub-menus, press the ENTER button.
3. To return to the Pattern Create Mode, maneuver to the "Escape" screen and then press **ENTER**.

Main-menu and Sub-menu Screens

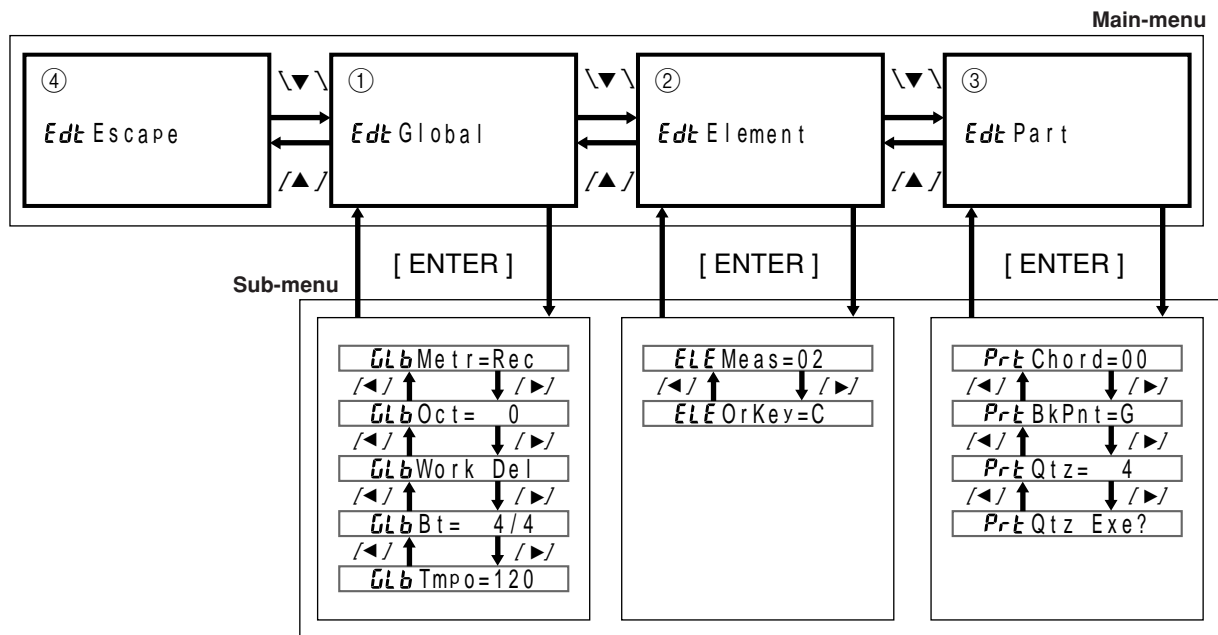

The above shows the main-menu and sub-menu screens. The text inside the frames are the main-menu and sub-menu names that appear on the display.

① Global Menu

This menu is for making settings that affect all sub-menus that make up the accompaniment pattern. The letters "GLb" indicate the Global menu, while the other letters are abbreviations of sub-menu names, as listed below.

- Metr Metronome
- Oct..... Octave Shift
- Work Del ... Work area clear (All Delete)
- Bt Meter (beat)
- Tmpo Tempo

For details on what each sub-menu controls and its available settings, see "Global Setting Sub-menus" on this page.

② Element Menu

This menu is for making settings for individual elements that make up an accompaniment pattern. The letters "ELE" indicate the Element menu, while the other letters are abbreviations of sub-menu names, as listed below.

- Meas Measure
- OrKey Original Key

For details on what each sub-menu controls and its available settings, see "Element Sub-menus" on page E-55.

③ Part Menu

This menu contains sub-menus for specifying how chords played on the accompaniment keyboard will be sounded during pattern playback. Settings can be made for each part of an accompaniment pattern. The letters "Prt" indicate the Part menu, while the other letters are abbreviations of sub-menu names, as listed below.

- Chord Chord conversion table
- BkPnt Break point
- Qtz Quantize
- Qtz Exe? Quantize Execute

For details on what each sub-menu controls and its available settings, see "Part Sub-menus" on page E-55.

④ Escape Screen

When this screen is on the display, press the ENTER button to return to the Pattern Create Mode.

Global Setting Sub-menus

After displaying the Global menu in the Pattern Edit Mode, use the [◀] and [▶] cursor keys to scroll through the Global sub-menus.

Metronome Setting

This setting controls whether or not the metronome sounds during pattern recording and playback.



Display Indicator	Meaning
O f f	Metronome off
R e c	Metronome sounds during recording only (initial default setting)
R & P	Metronome sounds during recording and playback

Metronome sound: The first beat is a chime, followed by a standard metronome click for the other beats.

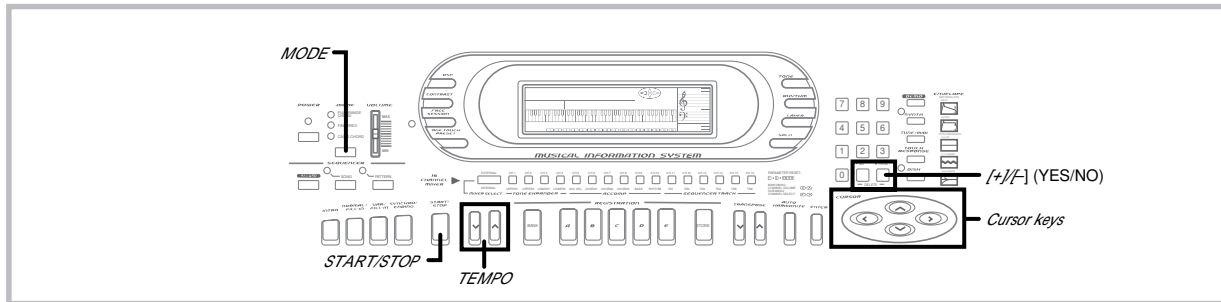

Octave Shift

When using the piccolo tone, there may be cases when very high notes you want to play are not included within the range of the keyboard. When this happens, you can use octave shift to shift the keyboard range one octave up. In this case you can use octave shift to shift the range of the tone up or down.
Note that octave shift is available with the Pattern Sequencer only.

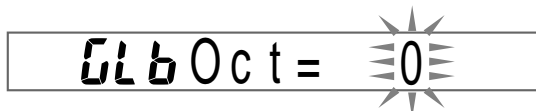

Use [+] and [-] to select the octave shift setting you want.

- 1: Range shifted one octave down.
- 0: No shift
- 1: Range shifted one octave up.

Work Area Clear

Use this operation to clear Pattern Sequencer work area contents. You must clear the work area when you plan to create an original accompaniment pattern from scratch.



1. In the Global menu, use [◀] and [▶] to display the "Work Del" screen, and then press the [+] and [-] buttons at the same time.



- This message confirms whether or not you really want to clear work area contents.

2. Press YES to clear work area contents or NO to abort the clear operation without clearing anything.
 - The message shown below appears for about one second and then the display returns to the Global menu.



Meter (Beat)

This setting specifies the meter of the accompaniment pattern.

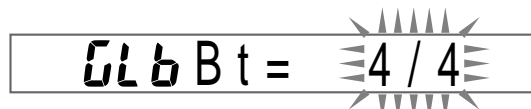

The display shown here appears when you specify a meter that is not included in the table below.

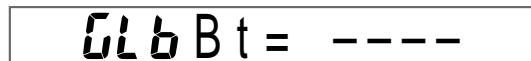

IMPORTANT!

You can set the meter immediately after clearing the Pattern Sequencer work area only (see above). In other cases, the meter of the accompaniment pattern currently in the work area is used, and cannot be changed. In this case the display does not flash.

Setting	Setting
2 / 4	3 / 8
3 / 4	5 / 8
4 / 4 (initial value)	6 / 8
5 / 4	7 / 8
6 / 4	9 / 8
7 / 4	

- Use [+] and [-] to change the setting.

Tempo

This setting specifies the initial tempo value for the accompaniment pattern.

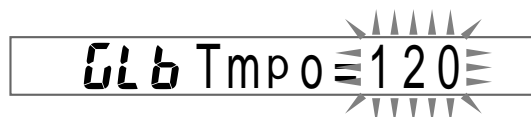

- Use [+] and [-] to set the initial tempo value within the range of 030 to 255.
- If the accompaniment pattern is playing when you change this setting, the tempo of the pattern does not change immediately. The value you specify becomes the current pattern's default tempo value, so you need to press both TEMPO buttons at the same time to have the newly set tempo take effect for an ongoing pattern.

NOTE

When you turn on the Pattern Sequencer, the initial default tempo value of the accompaniment pattern you are using as a base is applied first.

Element Sub-menus

After displaying the Element menu in the Pattern Edit Mode, use the [◀] and [▶] cursor keys to scroll through the Element sub-menus.

Setting the Number of Measures for Each Element

You can specify the number of measures for each element (except for the fill-in element) of an accompaniment pattern before you start recording it.

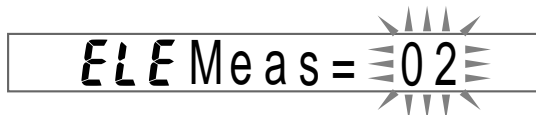

IMPORTANT!

You can specify the number of measures for each element only in the following cases.

- Immediately after clearing Pattern Sequencer work area contents (page E-54).
- After all the parts of the element whose number of measures you want to change have been deleted using the Pattern Create Mode.

In all other cases, the number of measures that is pre-programmed for the base accompaniment pattern cannot be changed.

- Use [+] and [-] to input a value of 01 to 16 for the number of measures.

Setting the Original Key for Each Element

You can set the basic key for each element when recording an accompaniment pattern. The default setting for the original key is C.



When you play the chord that is set as the element's original key while playing back an accompaniment pattern, all notes recorded on the element are played back exactly as they are recorded (and are not affected by chord conversion table).

NOTES

- You can change the Original Key setting for each element in the following cases only.
 - Immediately after clearing the Pattern Sequencer work area. See "Work Area Clear" on page E-54 for details on the work area clear operation.
 - After all parts of the element whose Original Key you want to change have been deleted using the Pattern Create Mode (page E-52).
- In all other cases, the Original Key setting of the accompaniment pattern used as the base pattern is used, and cannot be changed. In this case the display does not flash.
- Set the original key to C if you want your pattern to be compatible with built-in patterns.

Setting	Setting
C	F [♯]
C [♯]	G
D	A [♭]
E [♭]	A
E	B [♭]
F	B

- Use [+] and [-] to change settings.

Part Sub-menus

After displaying the Part menu in the Pattern Edit Mode, use the [◀] and [▶] cursor keys to scroll through the Part sub-menus.

Part Settings

All Part menu settings can be made separately for each part. The following shows which parameters can be set for each part.

	Rhythm	Bass	Chord 1	Chord 2	Chord 3
Chord Conversion Table	~				
Break Point	~				
Quantize Setting					
Quantize Execute					

See "To play back elements of the accompaniment pattern in the work area" on page E-50 for details on how to select elements and parts to make settings.

Accompaniment Pattern Playback During Part Setting

Pressing the START/STOP button while setting Part menu parameters starts playback of the Auto Accompaniment pattern, so you can immediately hear how a change in a parameter affects the accompaniment. You can perform the following operations while Auto Accompaniment is playing.

- You can specify chords using the chord play method (CASIO CHORD, FINGERED, FULL RANGE CHORD) that suits the accompaniment mode selected with the MODE button.
- You can change sub-menu settings, and immediately hear how changes affect the accompaniment pattern.

Chord Conversion Table Sub-menu

Use this sub-menu to specify the chord conversion table of the accompaniment pattern for each part of an element.



Accompaniment patterns are normally recorded in the key of C. When you select an accompaniment pattern and specify a key by with the accompaniment keyboard, the pattern is transposed from the key of C to the specified key. Simply transposing chords on a one-to-one basis, however, can result in mechanical, unnatural sounding patterns. To compensate for this, the keyboard has 19 built-in chord conversion tables that make chord progressions in different keys sound more natural.

- Select the part of an element whose setting you want to change, and then use [+] and [-] to specify a value in the range of 00 to 18, which specifies the chord conversion table number.
- See "Chord Conversion Table" on page A-8 for details on chord conversion table numbers and contents.

Break Point Sub-menu

Use this sub-menu to specify the break point of the accompaniment pattern for each part of an element.



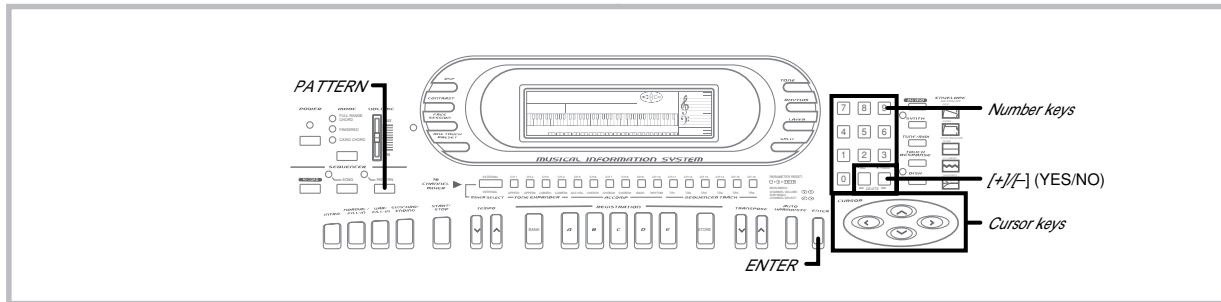

* Break Point

- Once you specify a break point, any chord above the break point is played in the next lower octave when playing back chords using CASIO CHORD, FINGERED, and FULL RANGE CHORD.

Setting	Setting
C	F [♯]
C [♯]	G
D	A [♭]
E [♭]	A
E	B [♭]
F	B

- Use [+] and [-] to change settings.

Quantize Setting

This setting determines the quantize value after recording. The timing of notes previously recorded from the keyboard can be matched with the note timing made with this setting.

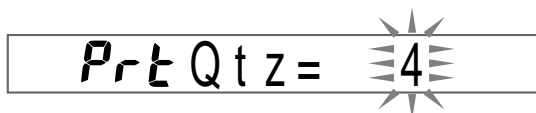

Display Indicator	Meaning
4	Quantize quarter notes (initial value)
8	Quantize 8 th notes
8 T	Quantize 8 th triplicate notes
1 6	Quantize 16 th notes
1 6 T	Quantize 16 th triplicate notes
3 2	Quantize 32 nd notes
3 2 T	Quantize 32 nd triplicate notes
6 4	Quantize 64 th notes

NOTE

The length of the last note of the accompaniment pattern you create may be altered by the quantize setting.

Quantize Execute

Use the following procedure to execute the quantize operation in accordance with current quantize settings.

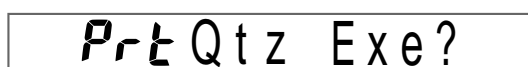

- In the Global menu, use the [◀] and [▶] cursor keys to display the message "Prt Qtz Exe?".
- Press the YES key to execute the quantize operation or NO to abort the operation.
 - Pressing YES causes the "qt Pls Wait" message to appear and remain on the display until the quantize operation is complete. The message shown below appears for about 1 second after the quantize operation is complete. Then the keyboard returns to the part menu.



Exiting the Pattern Sequencer Mode

Use the following procedures to exit the Pattern Sequencer Mode. The procedure you should use depends on whether you want to save or discard the contents of the work area.

To exit the Pattern Sequencer Mode and save work area contents

NOTE

Perform this operation only after you have finished creating the pattern you want to save.

- Press the PATTERN button.
 - This causes the message shown below to appear, which asks if you want to save work area contents.



- Press the YES key to save the pattern.
 - See "To exit the Pattern Sequencer Mode without saving work area contents" on page E-57 for details on what how to exit without saving.

3. Use the **number keys** or [+] and [-] to specify the user rhythm number where you want to save the pattern, and then press the **ENTER button**.
 - You can input any number in the range of 120 to 129.

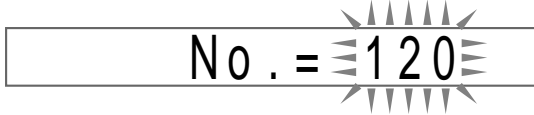

No. = 120

4. Press the [◀] or [▶] **cursor key** to move the cursor to the rhythm name input area, and input a name for the rhythm.
 - Use [+] and [-] to scroll through letters at the current cursor location.
 - Use the [◀] and [▶] cursor keys to move the cursor left and right.



105 USER01

5. After you are finished inputting the name, press the **ENTER button** to save the rhythm pattern under the name you specified.
 - The message "Complete" appears on the display for about one second, and then the Pattern Sequencer turns off. The currently selected rhythm at this time is the one you just saved.
 - If the rhythm number you specified already contains a rhythm, the message "Replace?" appears when you press ENTER in step 5 above, to ask whether you want to replace the existing rhythm with the new one. Press YES to replace or NO to return to step 1 of the above procedure so you can specify a different rhythm number.

To exit the Pattern Sequencer Mode without saving work area contents

1. Press the **PATTERN button**.
 - This causes the message shown below to appear, which asks if you want to save work area contents.



Save?

2. Press the **NO key**.



Delete?

- The above message asks if you really want to delete work area contents.
3. Press the **YES key** to exit without saving work area contents, or **NO** to abort this operation and return to the Pattern Sequencer Mode.

Keyboard Settings

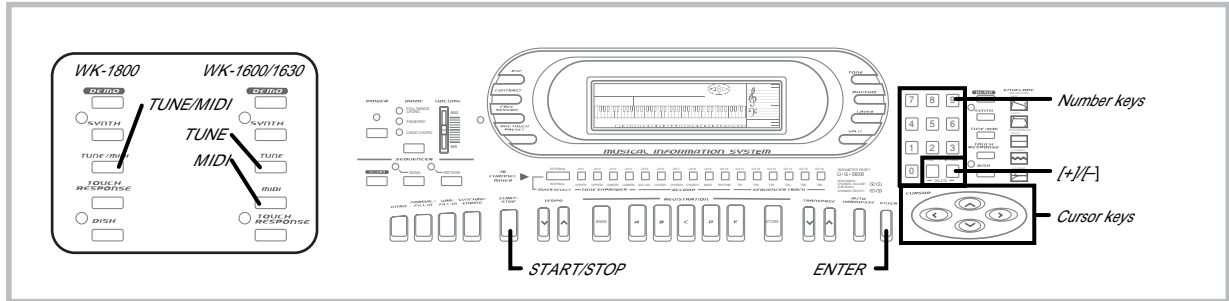

Using the Keyboard Settings Menu

The following describes how to use the keyboard settings menu to change the bend range, the assignable jack function, and the sound range shift setting.

To use the keyboard settings menu

1. Press the **TUNE/MIDI** button.
With the WK-1600/1630, this button is named **MIDI**.
2. Use the **[▲]** and **[▼]** cursor keys to display the screen for the setting you want to make, as shown below.

WK-1800

	Tuning screens (page E-19)
	MIDI settings (page E-62)
	Pitch Bend range
	Assignable jack function
	Sound range shift setting
	Bulk send, receive (page E-65)

WK-1600/1630

	MIDI settings (page E-62)
	Pitch Bend range
	Assignable jack function
	Sound range shift setting
	Bulk send, receive (page E-65)

3. Use **[+]** and **[-]** or the **number keys** to change the setting.
 - Settings you make are applied even if you do not press the **ENTER** button.
 - Pressing **[+]** and **[-]** at the same time returns the display value to its initial default.
 - See the following section titled "Setting Screens" for details on each setting.
4. After making the settings you want, press the **TUNE/MIDI** button (**MIDI** button on the WK-1600/1630) to clear the setting screen.
 - The setting screen also clears automatically if you do not perform any operation for about five seconds.

Setting Screens

Pitch Bend Range (Initial Default: 02)

This setting specifies the change in pitch caused when the pitch bender is at its maximum position. You can set a value in the range of 00 (no change) to 12 (12 semitones).



Assignable Jack Function (Initial Default: SUS)

This setting specifies the function of the foot pedal as: sustain, sostenuto, soft, or rhythm pedal.

Sustain Pedal (SUS)

Applies a sustain effect*1 when the pedal is pressed.



Sostenuto Pedal (SoS)

Applies a sostenuto effect*2 when the pedal is pressed.



Soft Pedal (SFt)

Softens notes played while pedal is depressed.



Rhythm Pedal (rHy)

Pedal performs same operations as the START/STOP button.



*1 Sustain Effect

With piano tones and other sounds that decay, the pedal acts as a damper pedal, with sounds being sustained longer when the pedal is depressed. With organ tones and other continuous sounds, notes played on the keyboard continue to sound until the pedal is released. In either case, the sustain effect is also applied to any notes that are played while the pedal is depressed.

*2 Sostenuto Effect

This effect performs the same way as sustain, except that it is applied only to notes that are sounding already when the pedal is depressed. It does not affect notes that are played after the pedal is depressed.

Sound Range Shift (Initial Default: OFF)

This setting shifts the range of a specific tone one octave up or down. This makes it possible to shift the piccolo tone range so you can play it within the keyboard range. You can also shift bass and other low-range tones so they can be played within the keyboard range.



Sound Range Shift Off

- Sound within range specified by General MIDI.

Sound Range Shift On

1 octave up	
072	Piccolo
1 octave down	
032	Acoustic Bass
033	Fingered Bass
034	Picked Bass
035	Fretless Bass
036	Slap Bass 1
037	Slap Bass 2
038	Synth Bass 1
039	Synth Bass 2
043	Contrabass

MIDI

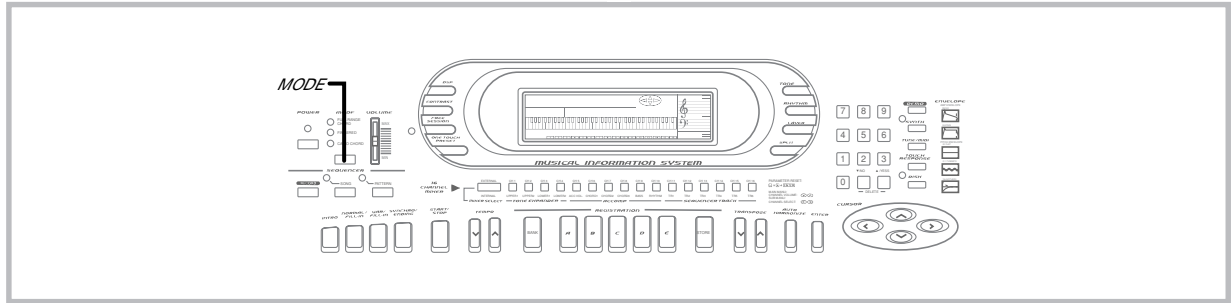

What is MIDI?

The letters MIDI stand for Musical Instrument Digital Interface, which is the name of a worldwide standard for digital signals and connectors that makes it possible to exchange musical data between musical instruments and computers (machines) produced by different manufacturers. MIDI compatible equipment can exchange keyboard key press, key release, tone change, and other data as messages. Though you do not need any special knowledge about MIDI to use this keyboard as a stand-alone unit, MIDI operations require a bit of specialized knowledge. This section provides you with an overview of MIDI that will help to get you going.

MIDI Connections

MIDI messages are sent out through the MIDI OUT terminal of one machine to the MIDI IN terminal of another machine over a MIDI cable. To send a message from this keyboard to another machine, for example, you must use a MIDI cable to connect the MIDI OUT terminal of this keyboard to the MIDI IN terminal of the other machine. To send MIDI messages back to this keyboard, you need to use a MIDI cable to connect the other machine's MIDI OUT terminal to the MIDI IN terminal of this keyboard.

To use a computer or other MIDI device to record and playback the MIDI data produced by this keyboard, you must connect the MIDI IN and MIDI OUT terminals of both machines in order send and receive data.

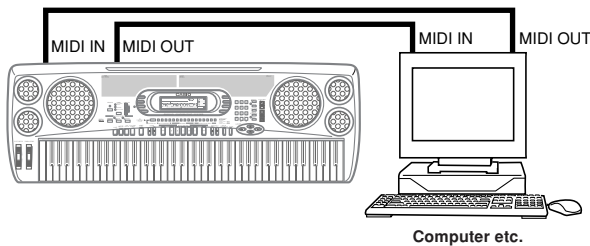

MIDI Channels

MIDI allows you to send the data for multiple parts at the same time, with each part being sent over a separate MIDI channel. There are 16 MIDI channels, numbered 1 through 16, and MIDI channel data is always included whenever you exchange data (key press, pedal operation, etc.).

This keyboard is equipped with multi-timbre capabilities, which means it can receive messages over all 16 MIDI channels and play up to 16 parts at the same time.

Keyboard and pedal operations performed on this keyboard are sent out by selecting a MIDI channel (1 to 16) and then sending the appropriate message.

General MIDI

As we have already seen, MIDI makes it possible to exchange musical data between devices produced by different manufacturers. This musical data does not consist of the notes themselves, but rather information on whether a keyboard key is pressed or released, and the tone number.

If tone number 1 on a keyboard produced by Company A is PIANO while tone number 1 on a Company B's keyboard is BASS, for example, sending data from Company A's keyboard to Company B's keyboard produces a result entirely different from the original. If a computer, sequencer or other device with auto accompaniment capabilities is used to produce music data for the Company A keyboard which has 16 parts (16 channels) and then that data is sent to the Company B keyboard which can receive only 10 parts (10 channels), the parts that cannot be played will not be heard.

The standard for the tone numbering sequence, the number of parts, and other general factors that determine the sound source configuration, which was arrived at by mutual consultations by manufacturers, is called General MIDI.

The General MIDI standard defines the tone numbering sequence, the drum sound numbering sequence, the number of MIDI channels that can be used, and other general factors that determine the sound source configuration. Because of this, musical data produced on a General MIDI sound source can be played back using similar tones and identical nuances as the original, even when played on another manufacturer's sound source.

This keyboard conforms with General MIDI standards, so it can be connected to a computer or other device and used to play back General MIDI data that has been purchased, downloaded from the Internet, or obtained from any other source.

Making MIDI Settings

This section describes the MIDI settings you need to make when connecting this keyboard to a sequencer, synthesizer, or other external device. Once connected, you can send and receive data, and even play back commercially available General MIDI data.

MIDI Settings

GM SYSTEM ON/OFF (Default: on)

The parameters of the executable channel are always initialized whenever the GM SYSTEM ON/OFF setting is changed.

on GM Mode

on: Tones sound within the range prescribed by General MIDI.

oFF: Causes the range of "072 Piccolo" to be raised one octave, and the range of "032 Acoustic Bass" to be lowered one octave.

1 octave up	
072	Piccolo
1 octave down	
032	Acoustic Bass
033	Fingered Bass
034	Picked Bass
035	Fretless Bass
036	Slap Bass 1
037	Slap Bass 2
038	Synth Bass 1
039	Synth Bass 2
043	Contrabass

KEYBOARD CHANNEL (Default: 01)

This parameter sets the channel for MIDI messages to an external device. You can set any MIDI channel in the range of 01 to 16 as the keyboard channel.

01 Keybd Ch

MIDI IN CHORD JUDGE ON/OFF (Default: oFF)

Use MIDI IN CHORD JUDGE when you want to use note data received from an external device through MIDI IN to play chords. It comes in handy when you want to control Auto Accompaniment chord progressions from a computer or other external device.

oFF Chord

on: Turns MIDI IN CHORD JUDGE on, which allows chord settings to be made using keyboard channel note data input through the MIDI IN terminal when the chord fingering method is selected by the MODE button.

oFF: Turns MIDI IN CHORD JUDGE off.

LOCAL CONTROL (Default: on)

This setting determines whether or not the keyboard and sound source of this keyboard are connected internally. When recording to a computer or other external device connected to this keyboard's MIDI IN/OUT terminal, it helps if you turn LOCAL CONTROL off.

on Local

on: Anything played on the keyboard is sounded by the internal sound source and simultaneously output as a MIDI message from the MIDI OUT terminal.

oFF: Anything played on the keyboard is output as a MIDI message from the MIDI OUT terminal, without being sounded by the internal sound source. Turn LOCAL CONTROL off whenever you are using the MIDI THRU function of a computer or other external device. Also note that no sound is produced by the keyboard if LOCAL CONTROL is turned off and no external device is connected.

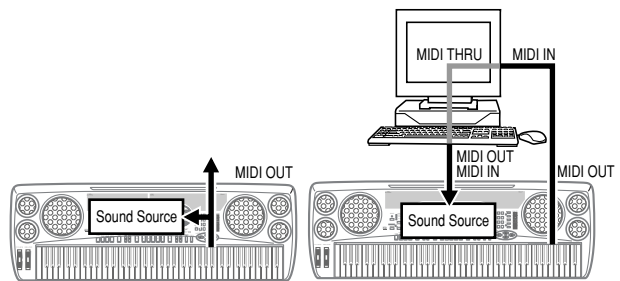

LOCAL CONTROL On

Notes played on the keyboard are sounded by the internal sound source and output as MIDI messages from the MIDI OUT terminal.

LOCAL CONTROL Off

Notes played on the keyboard are output as MIDI messages from the MIDI OUT terminal, but not sounded directly by the internal sound source. The MIDI THRU terminal of the connected device can be used to return the MIDI message and sound it on this keyboard's sound source.

ACCOMP MIDI OUT (Default: oFF)

oFF AcompOut

on: Auto Accompaniment is played by the keyboard and the corresponding MIDI message is output from the MIDI OUT terminal.

oFF: Auto Accompaniment MIDI messages are not output from the MIDI OUT terminal.

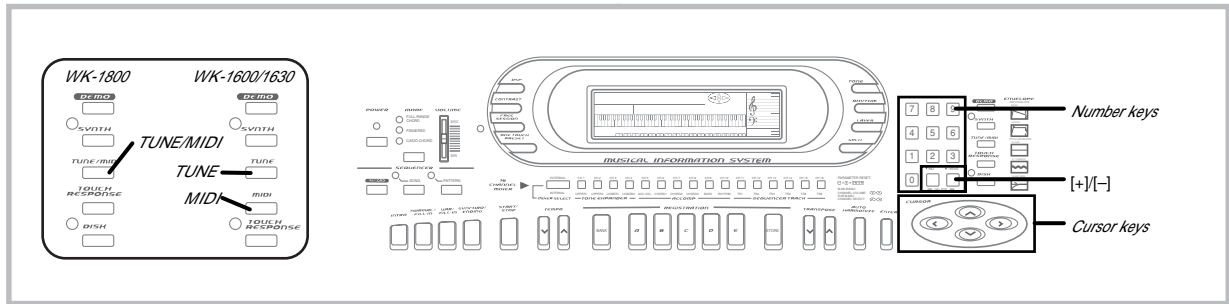

To make MIDI settings on the WK-1800

1. Press the **TUNE/MIDI** button.
2. Use the **[▲]** and **[▼]** **cursor keys** to display the MIDI screen for the setting you want to make, as shown below.

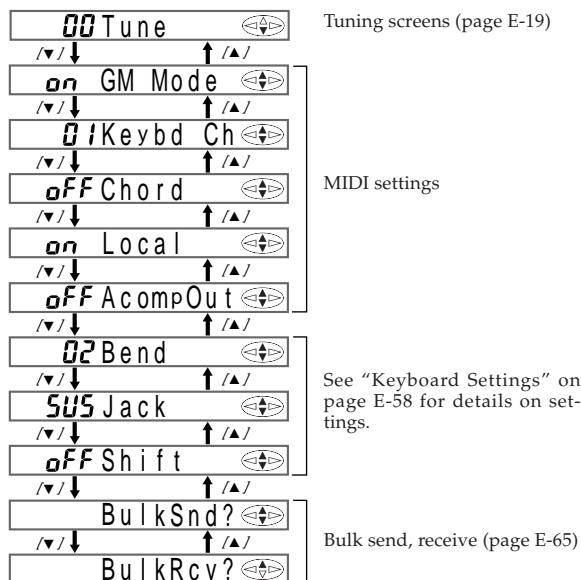

3. Use **[+]** and **[-]** or the **number keys** to change the setting.
 - Settings you make are applied even if you do not press the ENTER button.
4. Press the **TUNE/MIDI** button to clear the setting screen. The setting screen also clears automatically if you do not perform any operation for about five seconds.

To make MIDI settings on the WK-1600/1630

1. Press the **MIDI** button.
2. Use the **[▲]** and **[▼]** **cursor keys** to display the MIDI screen for the setting you want to make, as shown below.

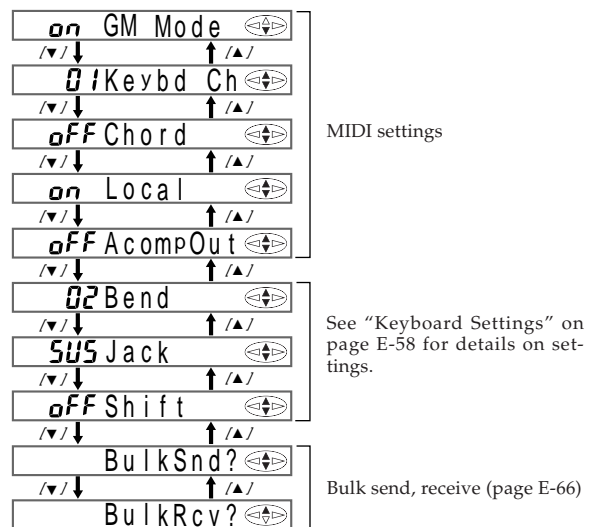

3. Use **[+]** and **[-]** or the **number keys** to change the setting.
 - Settings you make are applied even if you do not press the ENTER button.
4. Press the **MIDI** button to clear the setting screen. The setting screen also clears automatically if you do not perform any operation for about five seconds.

MIDI Messages

There is a wide variety of messages defined under the MIDI standard. This section details the particular messages that can be sent and received by this keyboard. An asterisk (*) is used to mark messages that affect the entire keyboard, while messages without an asterisk are those that affect only a particular channel.

NOTE ON/OFF

This message sends data when a key is pressed (NOTE ON) or released (NOTE OFF).

A NOTE ON/OFF message includes a note number (to indicate the note whose key is being pressed or released) and velocity (keyboard pressure as a value from 1 to 127). NOTE ON velocity is always used to determine the relative strength of the note. This keyboard does not receive NOTE OFF velocity data.

Pressing a keyboard key sends the corresponding NOTE ON message from the MIDI OUT terminal, while releasing the key sends the corresponding NOTE OFF message.

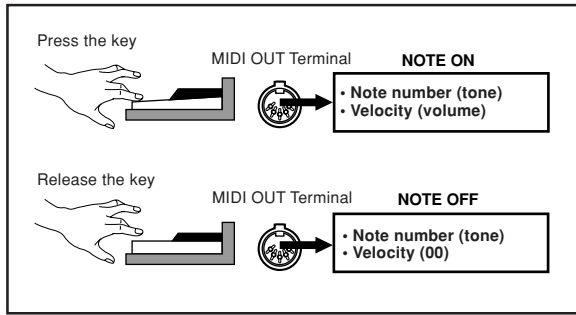

NOTE

The pitch of a note depends on the tone that is being used, as shown in the "Note Table" on page A-1. Whenever this keyboard receives a note number that is outside its range for that tone, the same tone in the nearest available octave is substituted.

PROGRAM CHANGE

This is the tone select message. PROGRAM CHANGE can contain tone data within the range of 0 to 127. A PROGRAM CHANGE message is sent out through the keyboard's MIDI OUT terminal whenever you manually change its tone number. Receipt of a PROGRAM CHANGE message from an external device changes the tone setting of this keyboard.

PITCH BEND

This message carries pitch bend information for sliding pitch upwards or downwards during keyboard play. Performing a pitch bend operation on this keyboard simultaneously changes the pitch of the built-in sound source and sends a PITCH BEND message out through the MIDI OUT terminal.

CONTROL CHANGE

This message adds effects such as vibrato and volume changes. CONTROL CHANGE data includes a control number (to identify the effect type) and a control value (to specify the on/off status and depth of the effect). The following is a list of data that can be send or received using CONTROL CHANGE.

Effect	Control Number
BANK SELECT*1	0/32
Modulation	1
Volume	7
Pan	10
Expression	11
Hold1	64
Sostenuto	66
Soft Pedal	67
Effect depth	91
RPN*2	100 / 101
Data Entry	6 / 38

*1 The BANK SELECT setting of PROGRAM CHANGE can be used to access any of this keyboard's 232 tones when selecting tones on this keyboard from an external device. The 232 tones are divided between four banks, as described below.

- Bank 0: 128 General MIDI tones (PROGRAM CHANGE 0 to 127)
- Bank 1: 64 variation tones (PROGRAM CHANGE 0 to 63)
- Bank 2: 8 drum sets (PROGRAM CHANGE 0 to 7)
- Bank 3: 32 user tones (PROGRAM CHANGE 0 to 31)

Immediately prior to sending the PROGRAM CHANGE message, send two successive CONTROL CHANGE messages containing the following data.
 CONTROL NUMBER=0 CONTROL VALUE=<bank number>
 CONTROL NUMBER=32 CONTROL VALUE= 0

NOTE

Data received by the sound source of this keyboard over MIDI Channel 10 is always treated as drum set data, and can be sounded using one of the eight drum set sounds only. Because of this, PROGRAM CHANGE 0 through 7 always corresponds to drum set tones, so BANK SELECT data is not necessary when PROGRAM CHANGE is received over channel 10.

*2 "RPN" stands for "Registered Parameter Number", which is a special control change number used when combining multiple control changes. The parameter being controlled is selected using the control values of control numbers 100 and 101, and then settings are made using the control values of DATA ENTRY (control numbers 6 and 38).

This keyboard supports pitch bend sense, coarse tune, and fine tune RPNs sent from other MIDI machines.

NOTE

Sustain (CONTROL NUMBER 64), sostenuto (CONTROL NUMBER 66), and soft (CONTROL NUMBER 67) effects applied using the foot pedal can also be sent and received.

ALL SOUND OFF

This message forces all sound being produced over the current channel to stop.

ALL NOTES OFF

This message causes all notes being produced over the current channel due to NOTE ON messages to stop. This message is valid only for MIDI data notes.

RESET ALL CONTROLLERS

This messages initializes pitch bend and all other control changes.

SYSTEM EXCLUSIVE*

This message is used to control system exclusives, which are fine adjustments that are unique to a particular MIDI device. Originally, system exclusives were unique to a particular model, but now there are also universal system exclusives that are applicable to machines that are different models and even produced by different manufacturers. The following are the system exclusive messages supported by this keyboard.

GM SYSTEM ON ([F0] [7E] [7F] [09] [01] [F7])

GM SYSTEM ON is used by an external machine to turn on this keyboard's GM system. "GM" stands for "General MIDI".

- GM SYSTEM ON takes more time to process than other messages, so it can take more than 100 msec until the next message is processed.

GM SYSTEM OFF ([F0] [7E] [7F] [09] [02] [F7])

GM SYSTEM OFF is used by an external device to turn off this keyboard's GM system.

EFFECT CHANGE ([F0] [44] [0B] [09] [XX] [F7])

EFFECT CHANGE switches between the keyboard's internal digital effects. The "XX" parameter in the syntax shown above stands for a hexadecimal value that represents an effect number sent from an external machine. A list of the hexadecimal values that can be specified and their meanings is shown below.

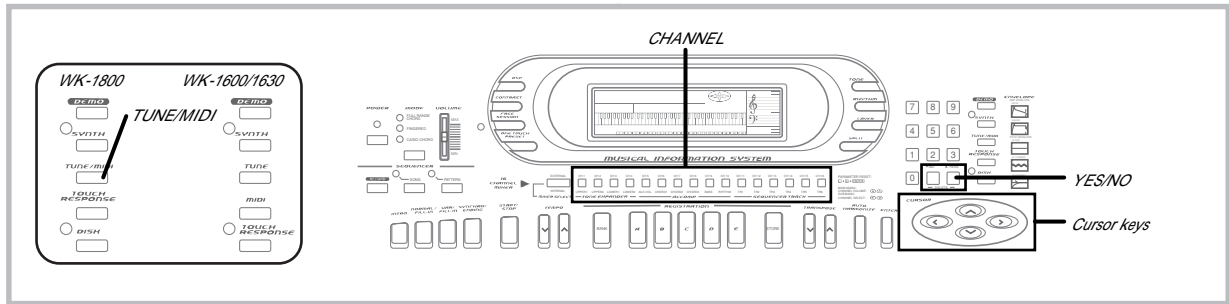

Effect Number	Digital Effect	Hex. Value
0	REVERB 1	00
1	REVERB 2	01
2	REVERB 3	02
3	CHORUS	03
4	TREMOLO	04
5	PHASE SHIFTER	05
6	ORGAN SPEAKER	06
7	ENHANCER	07
8	FLANGER	08
9	EQ LOUDNESS	09
oFF	OFF	0F

MIDI Functions and Mixer Functions

As explained under "Mixer Modes" on page E-28, this keyboard has a total of 32 channels: 16 internal channels and 16 external channels. Of these, you can use the external channels to play notes on the keyboard in accordance with received MIDI data and select tones. Internal channel settings have no effect on MIDI receive data. (Excluding External/Play)

NOTE

The above explanation applies to the External/Solo and Internal Modes only. It does not apply to the External/Play Mode.

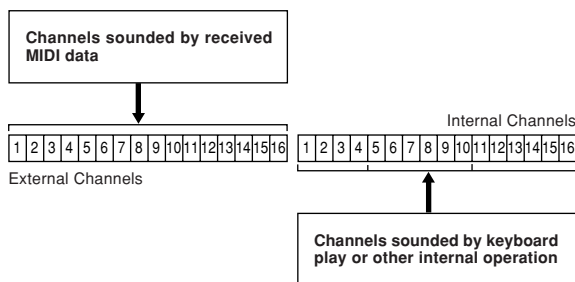

The Mixer can be used in combination with MIDI functions to perform a variety of operations. The following examples show how to use each Mixer mode for controlling MIDI send and receive operations.

NOTE

The following examples assume that you are already familiar with Mixer operations, especially how to change and use the Mixer modes. If you aren't, see "Mixer Function" on page E-28 for details.

Internal Mode

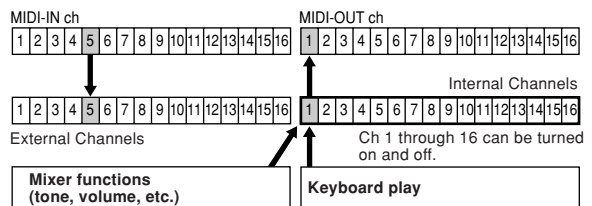

In the Internal Mode, Mixer settings (channel on/off, volume, and other settings) are affected by internal channel settings only. MIDI input can be controlled using the external channels only, so the Mixer can be used without affecting MIDI input. Because of this, the Internal Mode is best for the following type of application.

- When you want to use the multi-timbre capabilities of the keyboard's sound source to play along on the keyboard with playback of external MIDI data, and make separate settings for the keyboard notes. You can use the Internal Mode to change the tone, layer, split and other settings for keyboard play, without affecting MIDI input.

External Mode

Operations are different in the External, External/Solo, and External/Play Modes.

External Mode

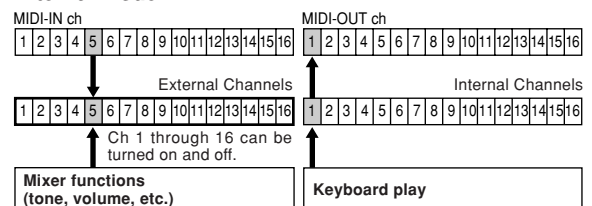

In the External Mode, Mixer functions affect the external channels, so they also have a direct effect on the corresponding MIDI input channels. Because of this, the External Mode is best for the following types of applications.

- To control MIDI input channel on/off settings. The CH1 through CH16 CHANNEL buttons correspond to MIDI channels 1 through 16, so channels can be toggled on and off by pressing the corresponding button.
- You can use the Mixer to change the tone and volume for each channel, and to make a variety of other settings. See "Changing the Parameters of a Channel" on page E-30.

NOTES

- All settings except for Channel on/off are changed at the next MIDI message receive after the setting is made.
- Though you can play on the keyboard without affecting MIDI input as with the Internal Mode, you cannot change keyboard settings. Except for when a channel other than the current channel is selected, you can change the main tone setting using the standard tone selection procedure shown under "Selecting a Tone" on page E-16.

External/Solo Mode

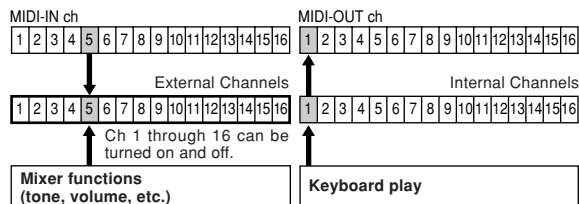

In this mode, only the channel on/off method is different from the External Mode. Pressing a CHANNEL button turns on only the channel assigned to that button and turns all other channels off. This mode is normally used for checking the contents of a specific channel during MIDI receive. You can change settings, play on the keyboard, and perform other operations just as you do in the External Mode.

External/Play Mode

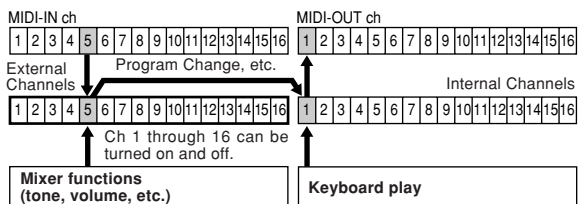

This mode is the opposite of the External/Solo Mode in that pressing a CHANNEL button turns off only the channel assigned to that button and turns all other channels on. This capability comes in handy when you want to cut out a part of the MIDI receive data and play that part on the keyboard. This is different from the play along capability of the Internal Mode, where you play along as all the parts of the MIDI receive data play. For example, let's say the keyboard is receiving a tune that uses MIDI Channels 1 through 10, and you want to play the horn section part on Channel 5 on the keyboard. Simply enter the External/Play Mode and press the CH5 CHANNEL button. This turns off CH5 and copies its Mixer settings (tone, control changes, and other data) to internal channel CH1, which is the channel that controls the keyboard tone (main tone). Now you can use the keyboard to play the horn section part on the keyboard, using the appropriate MIDI data settings.

Bulk Sending Keyboard Data

This keyboard stores a variety of internal data, including data recorded with the sequencers and synthesizer. This data can be sent and received in bulk as MIDI exclusive data through the MIDI terminals. This capability makes it possible for you use a computer or other MIDI machine as an external storage device for your data. Before performing the following procedures, you must first connect this keyboard's MIDI IN and MIDI OUT terminals to an external machine using MIDI cables.

NOTE

Some software does not support MIDI exclusive data.

To bulk send data from the keyboard to an external device with the WK-1800

1. Set up the other device by putting it in its receive standby mode.
 - See the documentation that comes with the other device for details.
2. Press the **TUNE/MIDI** button.
3. Press the **[▼]** cursor key to display the bulk send screen.

BulkSnd?

4. Press the **YES** key to start the bulk send operation.
 - The bulk send screen is automatically cleared from the display of the keyboard after the operation is complete.

To bulk import data from another device with the WK-1800

1. Press the **TUNE/MIDI** button.
2. Press the **[▼]** cursor key to display the bulk receive screen.

BulkRcv?

3. Press the **YES** key to enter bulk receive standby.
4. Perform the bulk send operation on the other device.
 - See the documentation that comes with the other device for details.
 - The bulk receive screen is automatically cleared from the display of the keyboard after the operation is complete.

00 Tune	Tuning screens (page E-19)
/▼/ ↓ ↑ /▲/	
0n GM Mode	MIDI settings (page E-62)
/▼/ ↓ ↑ /▲/	
01 Keybd Ch	
/▼/ ↓ ↑ /▲/	
oFF Chord	
/▼/ ↓ ↑ /▲/	
0n Local	
/▼/ ↓ ↑ /▲/	
oFF AcompOut	
/▼/ ↓ ↑ /▲/	
02 Bend	See "Keyboard Settings" on page E-58 for details on settings.
/▼/ ↓ ↑ /▲/	
5U5 Jack	
/▼/ ↓ ↑ /▲/	
oFF Shift	
/▼/ ↓ ↑ /▲/	
BulkSnd?	Bulk send
/▼/ ↓ ↑ /▲/	
BulkRcv?	Bulk receive
/▼/ ↓ ↑ /▲/	

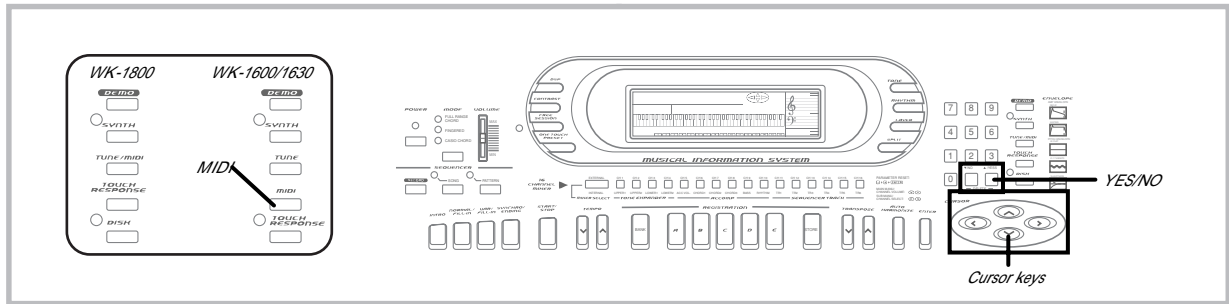

To bulk send data from the keyboard to an external device with the WK-1600/1630

1. Set up the other device by putting it in its receive standby mode.
 - See the documentation that comes with the other device for details.
2. Press the **MIDI** button.
3. Press the [▼] **cursor key** to display the bulk send screen.



4. Press the **YES** key to start the bulk send operation.
 - The bulk send screen is automatically cleared from the display of the keyboard after the operation is complete.

To bulk import data from another device with the WK-1600/1630

1. Press the **MIDI** button.
2. Press the [▼] **cursor key** to display the bulk receive screen.



3. Press the **YES** key to enter bulk receive standby.
4. Perform the bulk send operation on the other device.
 - See the documentation that comes with the other device for details.
 - The bulk receive screen is automatically cleared from the display of the keyboard after the operation is complete.

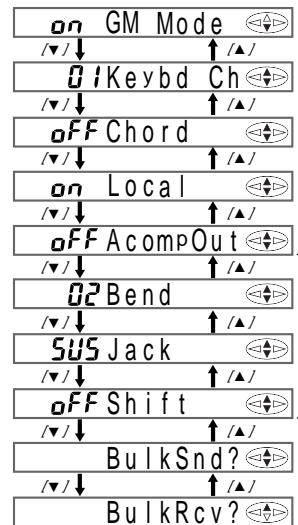

MIDI settings (page E-62)

See "Keyboard Settings" on page E-58 for details on settings.

Bulk send

Bulk receive

Using the Floppy Disk Drive (WK-1800 Only)

Floppy Disk Drive Features

The WK-1800 comes with a built-in disk drive, which provides you with the capabilities described below.

- You can save sequencer and synthesizer data on a floppy diskette for long-term storage. When you need the data again, simply insert the diskette into the disk drive and load it.
- You can play back SMF (standard MIDI file) data created on a personal computer and saved to diskette.
- You can convert rhythm data saved to diskette from another make of electronic musical instrument (Roland, Technics) and save it as user rhythm data.

Floppy Diskette Precautions

IMPORTANT!

- Avoid the following locations when storing and using diskettes. Any of the conditions noted below can cause data stored on the diskette to become corrupted.
 - Near TVs, on top of audio equipment, or in any area exposed to magnetism. Take special care to keep diskettes away from any source of magnetism.
 - Areas exposed to direct sunlight, or subject to high humidity or temperature extremes.
- Failure to observe any of the following precautions can cause data stored on the diskette to become corrupted.
 - Never try to take a diskette apart.
 - Never open the shutter of the diskette or touch the film inside with your fingers.
 - Never bend a diskette or otherwise subject it to rough handling.
 - Affix labels in the spaces provided only, and do not affix labels on top of previous ones.

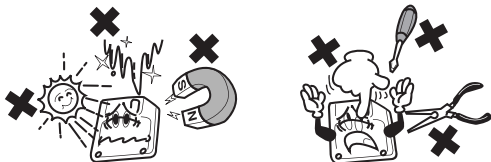

- Do not eject the diskette from the drive while the access lamp is lit or flashing or turn off keyboard power with a diskette in the drive. Doing either can cause data on the diskette to become corrupted and can even cause malfunction of the disk drive.
- Never insert any foreign objects into the disk drive. Doing so can cause it to malfunction.
- The disk drive uses a magnetic head. A dirty head cannot read data from a diskette properly and can corrupt existing data on the diskette. To avoid this, be sure to use a commercially available head cleaning diskette to periodically clean the head.
- Do not use a computer, another electronic musical instrument, or any other device to change a file name or file contents created with this keyboard. Doing so can make the data unusable by this keyboard and even cause malfunction of the keyboard.

Note that CASIO COMPUTER CO., LTD. shall not be held liable for any loss to you or any third party due to corruption or accidental erasure of data on a diskette.

About Floppy Diskettes

This section contains important information about handling diskettes. Be sure to read it before going any further.

Diskette Types

The WK-1800 supports use of both 3.5" 2HD (1.44MB formatted) and 2DD (720KB formatted) diskettes. Use of other disk sizes and capacities is not supported.

Diskette Type Indicators

- 2HD A 2HD diskette is marked with the letters "HD" in the upper right corner of the front side. Also, there is a square hole in the lower right corner.
- 2DD This type of diskette does not have a hole in the lower right corner.

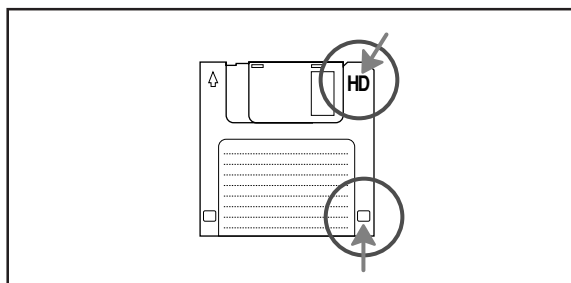

Write Protection

IMPORTANT!

- You can write protect a diskette so data on it cannot be deleted and no new data can be stored on the diskette. Also, a write protected diskette cannot be formatted. You can read data from a diskette regardless of whether or not it is write protected.

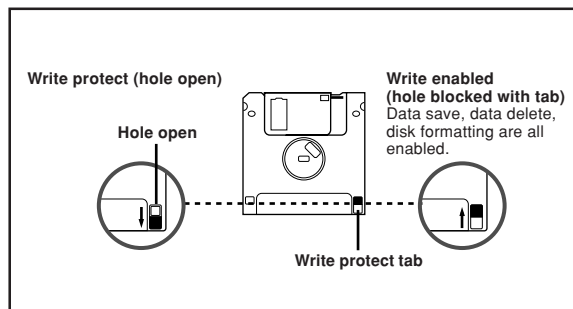

- When the write protect hole is open as shown in the illustration, you can read the contents of the diskette, but you cannot write data to or delete data from the diskette. After saving important data to a diskette, be sure to open its write protect hole to protect the data against accidental changes or deletion.
- The diskette that comes with the keyboard contains sample data and programs. It is write protected to avoid accidental erasure or formatting. Make sure you handle this diskette carefully to avoid damaging or erasing its data.

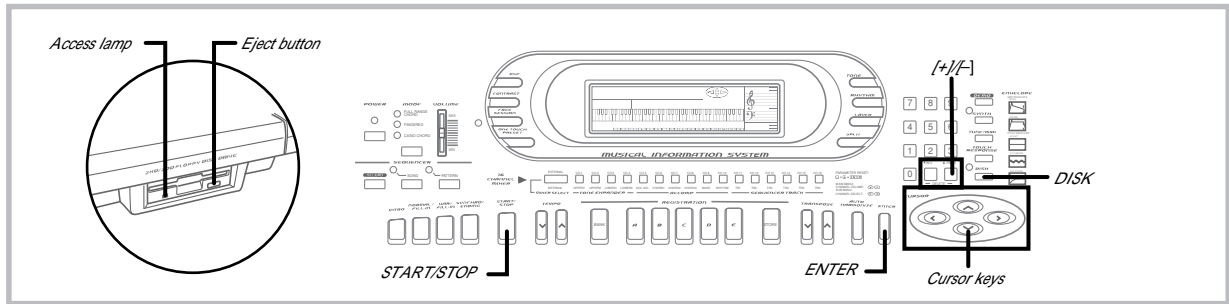

Inserting and Ejecting a Diskette

The following describes how to insert a diskette into the disk drive and how to eject it.

To insert a diskette into the floppy disk drive

1. With the label area of the diskette facing up, insert the diskette shutter first into the disk drive, as shown in the illustration.

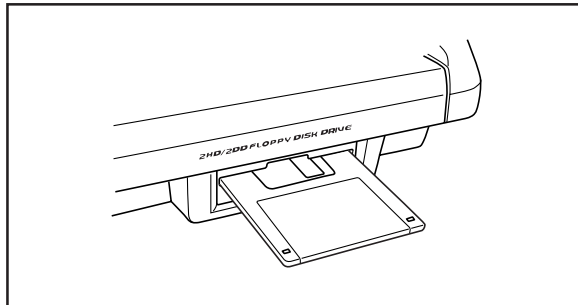

2. Slide the diskette into the drive as far as it will go, until it clicks into place.

To eject a diskette from the floppy disk drive

IMPORTANT!
Before ejecting a diskette, always check to make sure that the access lamp is not lit or flashing. A lit or flashing access lamp means that the keyboard is performing a data read or write operation. Ejecting a diskette while it is being accessed can cause its data to become corrupted.

1. Press the **Eject button**.
 - This causes the diskette to be partially ejected from the disk drive.
2. Remove the diskette from the drive by hand.

Basic Diskette Operation

The following is the basic procedure when using a diskette.

1. Insert a diskette into the keyboards disk drive.
2. Press the **DISK button**.
 - This causes the indicator lamp above the DISK button to light, which indicates the SMF Play Mode. See "Playing Back an SMF" on page E-69 for details on using this mode.
3. Press the **DISK button** again to display the first disk operation screen.
 - The indicator lamp above the DISK button flashes at this time.
4. Scroll through the disk operation screens.
 - Use the [▲] and [▼] cursor keys to scroll through the four available screens.

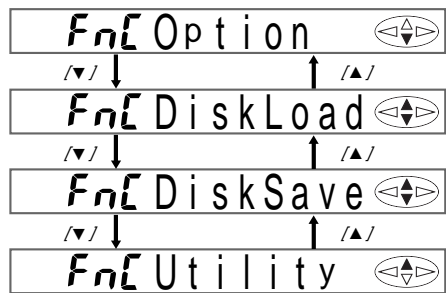

- Option ... Use this screen to set SMF playback options. See "Playing Back an SMF" on page E-69.
 - DiskLoad ... Use this screen to load a file created with the WK-1800. See "To load keyboard data from a diskette" on page E-71.
 - DiskSave ... Use this screen to save data created with the WK-1800. See "To save keyboard data to diskette" on page E-70.
 - Utility ... Use this screen to access utilities that let you convert rhythm data, delete data from a diskette, and format a diskette. See "Using the Utilities" on page E-71.
5. Perform the operation for the displayed disk operation screen.
 - Use the [◀] and [▶] cursor keys to make settings.
 - See the sections that follow this procedure for full details on performing disk operations.
 6. After you are finished, press the **DISK button**.
 - This causes the indicator lamp above the DISK button to go out.

NOTE
You will be able to start the above procedure even when there is no diskette in the disk drive.

Playing Back an SMF

SMF (standard MIDI file) is a data format that makes it possible to port MIDI data between sequencers and synthesizers of different type and brand. There are actually three different SMF formats, named 0, 1, and 2. This keyboard supports SMF Format 0, which is the most common. Most synthesizers, sequencers, and commercially available pre-recorded software and MIDI files use SMF Format 0. The built in disk drive of the WK-1800 lets you play back files created with a personal computer or other device and saved to diskette.

To play a specific file from diskette

1. Insert the diskette that contains the file into the keyboard's disk drive.
 - The diskette labeled "WK1800 ACCESSORY DISK" that comes with the keyboard contains files you can use for this procedure.
2. Press the **DISK button**.
 - This causes the indicator lamp above the DISK button to light, which indicates the SMF Play Mode.
 - At this time the name of one of the files contained on the diskette appears on the display.
3. Use [+] and [-] to select the file you want to play.
4. Press the **START/STOP button** to start play of the file whose name is flashing on the display.

File name

SQL *****
5. To stop file play, press **START/STOP** again.
 - File play also stops automatically when the end of the file is reached.

NOTE

After you stop file play part way through by pressing the START/STOP button, you can exit the file play mode by pressing the DISK button twice.

To play back all files on a diskette

Insert the diskette that contains the files into the keyboard's disk drive.

PREPARATION

- The diskette that comes with the keyboard contains files you can use for this procedure.

1. Press the **DISK button** twice.
 - This causes the "Option" disk operation screen to appear on the display. The indicator lamp above the DISK button flashes at this time.

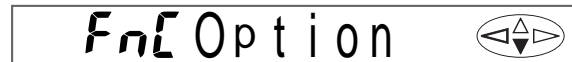

2. Use the [◀] and [▶] cursor keys to select the playback type.

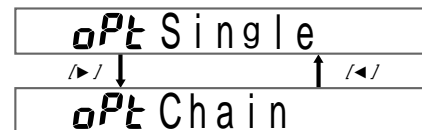

- Single ... Plays the currently selected file only.
- Chain ... Plays back all files on the diskette.

3. While "Chain" is on the display, press the **ENTER button** to start playback.
 - The name of the file that is playing is shown on the display.

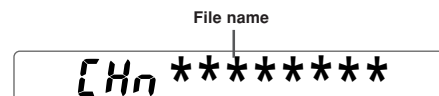

4. Press the **START/STOP button** to start playback.
5. To stop SMF play, press **START/STOP** again.
 - If you do not press START/STOP, SMF play plays one file after the other in an endless loop.

NOTE

After you stop SMF play part way through by pressing the START/STOP button, you can exit the disk operation screen by pressing the DISK button twice.

Operations During Playback

You can change the following settings while a file is playing from diskette.

- Mixer settings (See "Mixer Function" on page E-28.)
- Tempo settings

NOTES

- Even after you make Mixer and tempo settings during SMF playback, they may change to other settings if the data in the file contains such settings.
- File data is played over External Channels.

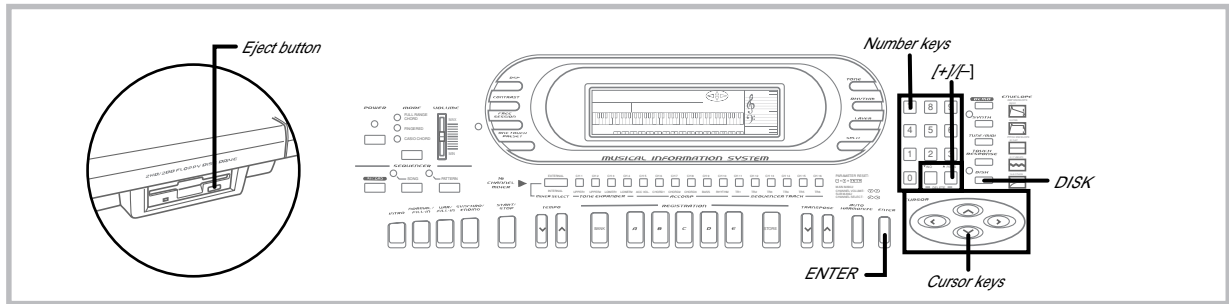

Saving and Recalling Memory Data

The built-in disk drive lets you save sequencer, synthesizer, and other data from the keyboard's memory to diskette for later recall when you need it.

Savable Data

The following is a list of keyboard data that can be saved to diskette.

- (1) User rhythms created using the Pattern Sequencer
- (2) User song data created using the Song Sequencer
- (3) User tones created using the Synthesizer
- (4) Setups saved in registration memory

- Saving tone, rhythm, or song data only causes each tone, rhythm, or song to be saved as a separate file.
- Saving registration memory data only causes all 20 setups (5 setups x 4 banks) in registration memory to be saved as a single file.
- Using the save all operation causes all the data currently in keyboard memory to be saved as a single file.

NOTES

- You can save individual tones, rhythms and songs in separate files only. You cannot save all tones, or all rhythms, or both songs in a single file.
- All registration memory data can be batch saved in a single file only. You cannot save individual banks or setups.

File Name Extensions

A three-letter extension is automatically added to file names to identify the type of data the file contains. The keyboard does not display extensions, but they will appear if you view the file names on a computer.

No.	Data Type	Extension	Screen Indication	File Contents
1	Pattern Sequencer	CPt	Pattern	Single user rhythm created with the Pattern Sequencer
		EPt	Pattern	Single user rhythm converted from data created on another make keyboard
2	Song Sequencer	Cs3	Song	Single user song created with the Song Sequencer
3	User Tones	Ct3	Tone	Single user tone
4	Registration	Cr3	Regist	20 setups (5 setups x 4 banks)
5	Save All	CA3	All	File produced by a save all operation

To save keyboard data to diskette

1. Check the data you want to save.
 - Make sure that everything is set up and configured the way you want to save it.
 - If you want to save a user tone, rhythm, or song, note its number.
2. Insert the diskette to which you want to save the data into the keyboard's disk drive. At this time close the diskette's write protect tab to enable writing.
3. Press the **DISK** button twice.
4. Press the [▼] **cursor key** twice to display the "Disk Save" screen.
5. Use the [◀] and [▶] **cursor keys** to display the screen for the type of data you want to save, and then press **ENTER**.

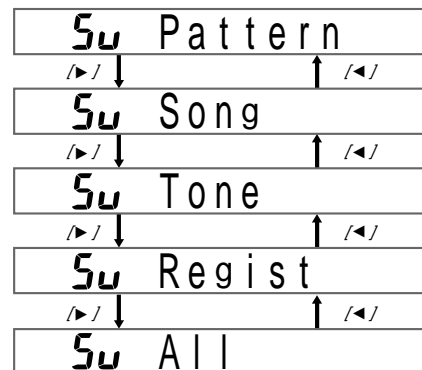

- The remainder of this example is based on selecting "Tone" in the above step.
6. Specify the location (tone number) of the data you want to save, and then press **ENTER**.
 - Use the number keys to input a two-digit number, or use [+] and [-] to increase and decrease the displayed number.
 - Inputting a user tone number displays the name assigned to the tone. You can leave this as the name of the file you are saving, or you can assign a different name.
 - Skip this step if you are saving registration memory data or all data.
 7. Input the name of the file.
 - Use [+] and [-] to scroll through letters at the current cursor location.
 - Use the [◀] and [▶] cursor keys to move the cursor left and right.

8. After inputting the file name, press the **ENTER** button to start the save operation.

- If the diskette already contains a file with the name you specified in step 7, the message "Replace?" appears, asking if you want to replace the existing file with the new one. Press the YES button to replace the existing file, or NO to return to step 7 of this procedure.
- The message "Pls Wait" remains on the display while the file save operation is being performed.

IMPORTANT!

- Do not perform any key operation while the message "Pls Wait" is on the display. In particular, never turn off keyboard power. Doing so can cause all data on the disk to become corrupted and unusable.
- Sudden power loss due to low battery power during the data save operation can corrupt the data on a diskette. Because of this, use of the specified AC adaptor is recommended whenever you are saving data to diskette.

9. The message "Complete" appears on the display for about one second when the data save operation is complete.

- The keyboard returns to step 5 of this procedure after the "Complete" message clears from the display.
- Repeat steps 5 through 9 if you want to save more data.
- After you finish your diskette operations, press the DISK button so the indicator lamp above it goes out. Next, press the eject button to eject the diskette, and then remove it by hand.

NOTES

- When saving registration memory data or all data, simply skip step 6 of the above procedure.
- See "Letters and Numerals" on page E-36 for the characters that can be input for the file name.
- We recommend that you make a separate record of the names of files and their contents to make it easier to find the data you need when you need it.
- To exit the disk operation screens at any time during the above procedure, press the DISK button so the indicator lamp above it goes out.
- When saving Pattern type data (single user rhythm), each file can hold a maximum of about 5,000 notes. To save a user rhythm pattern that has more than 5,000 notes, select All in step 5 of the above procedure to save all keyboard data. See "File Name Extensions" on page E-70 for details on the extensions appended to file names.

To load keyboard data from a diskette

NOTE

The following procedure describes how to load a user tone as an example of the load operation. The procedures for loading other types of data is identical, except where noted.

1. Insert the diskette that contains the data you want to load into the keyboard's disk drive.
2. Press the **DISK** button twice.
3. Press the **[▼]** cursor key once to display the "Disk Load" screen.
4. Use the **[◀]** and **[▶]** cursor keys to display the screen for the type of data you want to load, and then press **ENTER**.

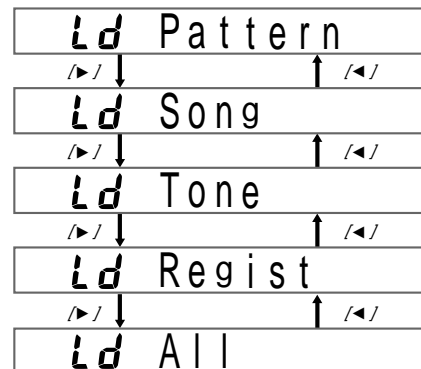

- Pressing ENTER causes the name of the first file of the type you specify to appear on the display.
- The remainder of this example is based on selecting "Tone" in the above step.

5. Use **[+]** and **[-]** to display the name of the file you want to load, and then press **ENTER**.

6. Specify the location (tone number) where you want to store the data.

- Use the number keys to input a two-digit number, or use **[+]** and **[-]** to increase and decrease the displayed number.
- Skip this step if you are saving registration memory data or all data.

7. Press the **ENTER** button to start the load operation.

- The message "Replace?" appears, asking if you want to replace the existing data with the loaded data. Press the YES button to replace the existing data, or NO to return to step 4 of this procedure.
- The message "Pls Wait" remains on the display while the file save operation is being performed.

IMPORTANT!

Do not perform any key operation while the message "Pls Wait" is on the display. In particular, never turn off keyboard power. Doing so can cause all data on the disk to become corrupted and unusable.

8. The message "Complete" appears on the display for about one second when the data load operation is complete.

- The keyboard returns to step 4 of the above procedure after the "Complete" message clears from the display.
- Repeat steps 4 through 8 if you want to load more data.
- You can quit diskette operations at any time during the above operation by pressing the DISK button so the indicator lamp above it goes out.

NOTES

- When loading registration memory data or all data, simply skip step 6 of the above procedure.
- To exit the disk operation screens at any time during the above procedure, press the DISK button so the indicator lamp above it goes out.
- If an error occurs while data saved to a diskette by a Save All operation is being loaded back into keyboard memory, user tones, user rhythms, Song Sequencer data, and registration memory data that was in memory when the load operation started will all be deleted.

Using the Utilities

This section describes the utilities that are provided to convert rhythm pattern data from another keyboard, to delete data from a diskette, and to format a diskette.

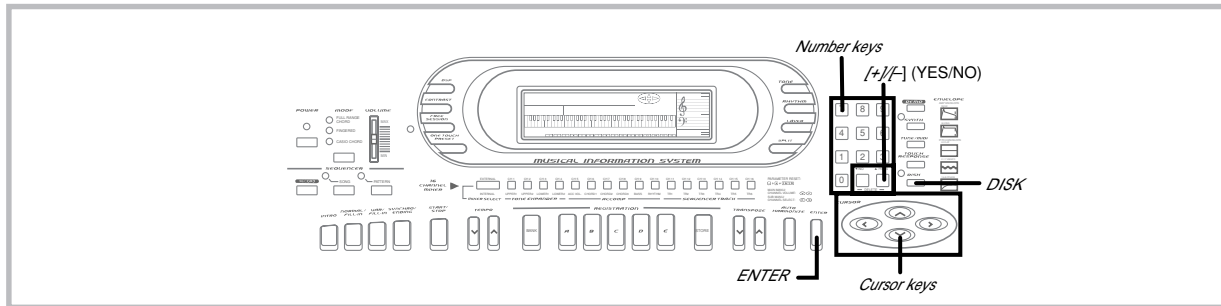

Converting Rhythm Pattern Data From Another Keyboard

Use the procedure described here to convert rhythm pattern data created on a Technics, or Roland brand keyboard so it can be used on the WK-1800.

IMPORTANT!

- The data conversion capabilities of this keyboard are intended for personal, non-commercial purposes only.
- The sound source and accompaniment system of this keyboard is different from those used by other manufacturers, so converted data played on this keyboard may sound different from what it sounds like when played on its equipment.
- You may not be able to convert some accompaniment patterns created on other keyboards.
- Please direct all inquiries concerning accompaniment pattern conversion to CASIO COMPUTER CO., LTD.

NOTES

- Data can be converted one files at a time.
- Converted data is stored in the user rhythm area of this keyboard's memory.

To convert rhythm data

Before getting started...

- Prepare the diskette labeled "WK1800 ACCESSORY DISK", which comes with the WK-1800.
- Prepare the diskette that contains the rhythm pattern data you want to convert.
- Eject and remove any diskette currently in the WK-1800 disk drive.
- Make sure there is a user rhythm number available to store the converted data.

1. Press the **DISK** button twice.
 - This displays the first disk operation screen.
2. Press the [▼] **cursor key** three times to display the "Utility" screen.
3. Use the [◀] and [▶] **cursor keys** to display the "Pt-nConv" (pattern conversion) screen.
4. Press the **ENTER** button.
 - This causes a data type selection screen to appear on the display.

Con Type = Tec

Display	Manufacturer Name
Tec	Technics
Rol	Roland

5. Use [+] and [-] to display the indicator for the type of data you are converting from, and then press the **ENTER** button.
 - The following shows the display indicator for each data type.

Con InsConFD

6. Insert the "WK1800 ACCESSORY DISK" into the disk drive of the WK-1800, and then press the **ENTER** button.
 - The message "Pls Wait" appears, followed by the message shown below.

Con ChgPt nFD

7. Eject and remove the "WK1800 ACCESSORY DISK" and insert the diskette that contains the data you want to convert. Next, press the **ENTER** button.
 - Inserting the data disk causes the message "Select" to appear on the display for about one second. Next the name of one of the files on the disk appears.

8. Use [+] and [-] to display the name of the file you want to convert, and then press the **ENTER** button.

9. Specify the file characteristics.
 - File characteristic depend on the type of data you are converting. See "File Characteristics" on page E-73 for details on how to set file characteristics for each type of data.
 - The conversion starts as soon as you specify the file characteristics. The message "Pls Wait" indicates that conversion is being performed.

10. Specify the user rhythm number where you want to store the converted data.
 - Use [+] and [-] to specify a number in the range of 120 to 129.

11. Press the **ENTER** button to load the converted data.
 - If the rhythm number you specify already contains data, the message "Replace?" appears, asking if you want to replace the existing data with the converted data. Press the YES button to replace the existing data, or NO to return to step 10 of this procedure.

12. The message "Complete" appears when the conversion is complete. Next, the message "Continu?" appears to ask if you want to convert more data.
 - Press the YES button if you want to convert more data from the same manufacturer, or NO to return to step 3 of this procedure.
 - To exit the procedure, press the DISK button so the indicator lamp above it goes out.

NOTE

To exit the above procedure at any time, press the DISK button so the indicator lamp above it goes out.

File Characteristics

Use the following procedures to specify the file characteristics for each type of data during the rhythm data conversion procedure. These steps should be performed for step 9 of the procedure under "Converting Rhythm Pattern Data From Another Keyboard" on page E-72.

(A) To specify Technics file characteristics

1. Use [+] and [-] to specify Bank A, B, or C, and then press **ENTER**.

Con Bank = A

2. Use [+] and [-] to specify Area 0 or 1, and then press **ENTER**.

Con Area = 0

(B) To specify Roland file characteristics

1. Use [+] and [-] to select either basic (B) or advanced (A) and the chord type (M, m, 7th). Various combinations are available, so scroll through the selections until you find the one you want, and then press **ENTER**.

Con Mode = B-M

2. Use [+] and [-] to specify one of the three available conversion processes, and then press **ENTER**.

Con Proces = 0

To delete a file from a diskette

IMPORTANT!

The file delete operation cannot be undone. Make sure you no longer need a file before you delete it.

1. Insert the diskette that contains the file you want to delete into the keyboard's disk drive. At this time close the diskette's write protect tab to enable writing.
2. Press the **DISK button** twice.
 - This causes the "Option" disk operation screen to appear on the display. The indicator lamp above the DISK button flashes at this time.
3. Press [▼] three times to display the "Utility" screen.

4. Use [◀] and [▶] to display the "FileDel" (file delete) screen, and then press the **ENTER button**.

- This causes a file name to appear on the screen as shown below.

File name
dELTUNE1
File name extension
[S]

5. Use [+] and [-] to display the name of the file you want to delete, and then press the **ENTER button**.

- The message "Sure?" appears on the display to confirm whether or not you really want to delete the file.

6. Press **YES** to delete the file or **NO** to abort the operation without deleting anything.

- After the file is deleted, the message "Complete" appears on the display for about one second. Then the keyboard returns to step 4 of the above procedure.

NOTES

- To exit the above procedure at any time, press the DISK button so the indicator lamp above it goes out.
- This keyboard cannot delete an SMF from a disk.

To format a floppy diskette

IMPORTANT!

Formatting a diskette that contains data deletes the data. Make sure you no longer need any data that may be on a diskette before you format it.

1. Press the **DISK button** twice.
 - This causes the "Option" disk operation screen to appear on the display. The indicator lamp above the DISK button flashes at this time.
2. Press [▼] three times to display the "Utility" screen.
3. Use [◀] and [▶] to display the "Format" screen, and then press the **ENTER button**.
 - This causes the message "Insert FD" to appear, prompting you to insert the diskette you want to format into the disk drive.
4. Insert the diskette that you want to format into the keyboard's disk drive, and then press the **ENTER button**.
 - The message "Sure?" appears on the display to confirm whether or not you really want to format the diskette.
5. Press **YES** to format the diskette or **NO** to abort the operation.
 - The message "Pls Wait" remains on the display while the format operation is being performed.
 - After the diskette is formatted, the message "Complete" appears on the display for about one second. Then the keyboard returns to step 3 of the above procedure.

NOTES

- To exit the above procedure at any time, press the DISK button so the indicator lamp above it goes out.
- A diskette formatted by MS-DOS or Windows can be used as it is on WK-1800. Diskettes formatted for other types of computers are not compatible.

Disk Drive Error Messages

Message	Cause	Action
Err ReadOnly	Attempt to save a file using the same name as an existing file that is read only.	Save the new file to a different diskette or use another name.
Err Format	<ol style="list-style-type: none"> 1. The format of the diskette is not compatible with this keyboard. 2. The diskette is not formatted. 3. The diskette is damaged. 	<ol style="list-style-type: none"> 1. Change to a diskette that has the proper format. E-67 2. Format the diskette. E-73 3. Use a different diskette.
Err Disk R/W	The diskette is damaged.	Use a different diskette.
Err DiskFull	The diskette is full.	<ol style="list-style-type: none"> 1. Use a different diskette. 2. Delete any files you no longer need in order to make room for the data you want to save. E-73
Err Mem Full	Keyboard memory became full while importing data from diskette.	<ol style="list-style-type: none"> 1. If you have user patterns stored in Pattern Sequencer memory, use the following procedure to delete user patterns you no longer need from the user area (patterns 120 to 129). <ol style="list-style-type: none"> ① Clear the work area using the procedure under "Work Area Clear" on page E-54. ② While the work area empty (cleared), use the procedure under "To exit the Pattern Sequencer Mode and save work area contents" on page E-56 to save the work area to the accompaniment pattern user area accompaniment numbers that contain patterns you no longer need. Saving the empty work area effectively deletes data currently stored in memory. 2. If you have song data stored in Song Sequencer memory (SG0, SG1), delete the song data you no longer need. E-46
Err Not SMF0	The file you are reading is not an SMF 0 format file.	Use SMF 0 format files only. E-69
Err No Disk	<ol style="list-style-type: none"> 1. The diskette is not loaded in the drive correctly. 2. No diskette is loaded in the drive. 	<ol style="list-style-type: none"> 1. Eject the diskette from the drive and reload it. E-68 2. Load a diskette into the drive.
Err No File	The keyboard cannot find any file it can read on the diskette.	Use a diskette that contains data stored by this keyboard or compatible data from another device.
Err Protect	The diskette is write protected.	<ol style="list-style-type: none"> 1. Use a different diskette. 2. Close the diskette's write protect hole to enable data storage. E-67
Err Convert	The accompaniment pattern data you are trying to convert is of a type that cannot be converted by this keyboard.	Try converting other accompaniment pattern data.
Err WrongDat	The data on the diskette is corrupted.	Use other data or another diskette.

Troubleshooting

Problem	Possible Cause	Action	See page
No sound when keyboard keys are pressed.	<ol style="list-style-type: none"> 1. Batteries are not loaded correctly. 2. Power is not turned on. 3. MAIN VOLUME setting is too low. 4. Playing in the accompaniment keyboard area while the MODE button setting is CASIO CHORD or FINGERED. 5. LOCAL CONTROL is off. 6. Mixer Channel 1 is off. 7. Mixer Channel 1 volume or expression setting is too low. 	<ol style="list-style-type: none"> 1. Check to make sure the AC adaptor is connected correctly, and that the +/- ends of the batteries are facing correctly. Check for dead batteries. 2. Press the POWER button to turn on power. 3. Use the MAIN VOLUME slider to increase volume. 4. None of the accompaniment mode indicators are lit, which means Auto Accompaniment is turned off. 5. Turn LOCAL CONTROL on. 6. Turn on Mixer Channel 1. 7. Use the Mixer to raise the volume or expression setting for channel 1. 	<p>Page E-14</p> <p>Page E-16</p> <p>Page E-16</p> <p>Page E-21</p> <p>Page E-61</p> <p>Page E-29</p> <p>Page E-30</p>
<p>Any of the following symptoms while using battery power.</p> <ul style="list-style-type: none"> • Dim power supply indicator • Instrument does not turn on • Display that is flickering, dim, or difficult to read • Abnormally low speaker/headphone volume • Distortion of sound output • Occasional interruption of sound when playing at high volumes • Sudden power failure when playing at high volumes • Flickering or dimming of the display when playing at high volume • Continued sound output even after you release a key • A totally different tone may sound • Abnormal rhythm pattern and demo tune play • Loss of power, sound distortion, or low volume when playing from a connected computer or MIDI device • Sudden power failure while reading from or writing to a diskette (WK-1800 only) 	Low battery power	Replace the batteries with a set of new ones or use the AC adaptor.	Page E-14
Auto Accompaniment does not sound.	<ol style="list-style-type: none"> 1. Accompaniment volume is set to 000. 2. Auto Accompaniment part Channels 6 through 10 are turned off. 3. Auto Accompaniment part Channels 6 through 10 volume or expression setting is too low. 	<ol style="list-style-type: none"> 1. Use the CH5 (ACC VOL.) button to increase the volume. 2. Use the Mixer to turn the channels on. 3. Use the Mixer to raise the volume or expression setting for the applicable channel. 	<p>Page E-27</p> <p>Page E-29</p> <p>Page E-30</p>
Sound output does not change when key pressure is varied.	Touch response is turned off.	Press the TOUCH RESPONSE button to turn it on.	Page E-18
The key or tuning does not match when playing along with another MIDI machine.	The tuning or transpose parameter is set to a value other than 00.	Change the transpose or tuning parameter value to 00.	Page E-19

Problem	Possible Cause	Action	See page
Some parts stop playing at some point during Sequencer playback.	Playback exceeds the maximum polyphony of the keyboard.	Use the Song Sequencer to decrease the number of parts playing at the same time by turning off channels.	Page E-45
Some parts don't play at all during Sequencer playback.	<ol style="list-style-type: none"> 1. The Mixer mode setting for the corresponding channel is off or External/Solo. 2. Volume or expression setting is too low. 	<ol style="list-style-type: none"> 1. Use the Mixer to make sure that channels are turned on. 2. Use the Mixer to check the volume or expression setting. 	Page E-29 Page E-30
Cannot record Auto Accompaniment or rhythm.	Track other than Track 1 is selected as the recording track. Tracks 2 through 6 are melody tracks.	Use the track select buttons to select Track 1.	Pages E-40, 42
Nothing happens when the LAYER or SPLIT button is pressed.	<ol style="list-style-type: none"> 1. One or more of the melody channels (2 through 4) is turned off. 2. The volume or expression setting of one or more of the melody channels (2 through 4) is too low. 	<ol style="list-style-type: none"> 1. Use the Mixer to turn on Channels 2 through 4. 2. Use the Mixer to raise the volume or expression setting of Channels 2 through 4. 	Page E-29 Page E-30
No sound is produced when playing MIDI data from a computer.	<ol style="list-style-type: none"> 1. MIDI cables are not connected properly. 2. Channel is turned off, or volume or expression setting is too low. 	<ol style="list-style-type: none"> 1. Connect MIDI cables properly. 2. Use the Mixer to turn the channel on, or raise the volume or expression setting. 	Page E-60 Pages E-29 to 30
The bass notes of General MIDI data being played back by a computer are one octave too low.	GM SYSTEM is turned off.	Turn on the GM SYSTEM.	Page E-61
Playing on the keyboard produces an unnatural sound when connected to a computer.	The computer's MIDI THRU function is turned on.	Turn off the MIDI THRU function on the computer or turn off LOCAL CONTROL on the keyboard.	Page E-61
Cannot record chord accompaniment data on a computer.	ACCOMP MIDI OUT is turned off.	Turn on ACCOMP MIDI OUT.	Page E-61

Specifications

Model:	WK-1800/WK-1600/WK-1630														
Keyboard:	76 standard-size keys, 6 1/4 octaves (with touch response on/off; ExLight/Light/Normal/Heavy touch)														
Tones:	232 (128 General MIDI, 64 variation, 8 drum, 32 user); with layer and split														
Rhythm Instrument Tones:	61														
Polyphony:	32 notes maximum (16 for certain tones)														
Digital Effects:	10 (REVERB 1, 2, 3; CHORUS; TREMOLO; PHASE SHIFTER; ORGAN SPEAKER; ENHANCER; FLANGER; EQ LOUDNESS)														
Auto Accompaniment	<p>Rhythm Patterns: 130 (120 + 10 user rhythms)</p> <p>Tempo: Variable (226 steps, ♩ = 30 to 255)</p> <p>Chords: 3 fingering methods (CASIO CHORD, FINGERED, FULL RANGE CHORD)</p> <p>Rhythm Controller: Start/Stop, Intro, Normal/Normal Fill-In, Variation/Variation Fill-In, Synchro/Ending</p> <p>Accomp Volume: 0 to 127 (128 steps)</p> <p>One Touch Presets: Recalls settings for tone, tempo, layer, and Auto Harmonize in accordance with rhythm.</p> <p>Auto Harmonize: Automatic addition of notes that harmonize with melody note in accordance with specified Auto Accompaniment chords.</p>														
Free Session	<p>Number of Patterns: 120 (Auto Accompaniment function based on preset chord progressions.)</p>														
Song Sequencer	<p>Songs: 2</p> <p>Recording Tracks: 6 (2 through 6 are melody tracks)</p> <p>Recording Method: Real-time</p> <p>Memory Capacity (total for two songs): Approximately 8,000 notes (WK-1800) Approximately 4,900 notes (WK-1600/1630)</p> <p>Punch In: Supported</p>														
Pattern Sequencer	<p>Number of Patterns: 10 (Rhythm numbers 120 to 129)</p> <p>Memory Capacity: Approximately 6,800 notes (WK-1800) Approximately 5,800 notes (WK-1600/1630)</p> <p>Elements: Intro, Normal, Variation, Normal Fill-In, Variation Fill-In, Ending</p> <p>Parts: Chord 1, 2, 3; Bass; Rhythm</p> <p>Recording Method: Real-time</p>														
Registration Memory	<p>Number of Setups: 20 (5 setups x 4 banks)</p> <p>Memory Contents: Tone, Rhythm, Tempo, Split on/off, Split point, Layer on/off, Auto Harmonize on/off, Mixer settings, Keyboard channel on/off, DSP (digital effect) on/off, DSP (digital effect) settings, Accompaniment mode, Touch Response settings, Assignable jack setting, Transpose, Tuning, Pitch Bend range, Sound range shift on/off</p>														
Demo Tunes:	<p>2</p> <table border="1"> <thead> <tr> <th>Tune Number</th> <th>Title</th> <th>Composer</th> <th>Time</th> </tr> </thead> <tbody> <tr> <td>1</td> <td>Over The Edge</td> <td>TECH-NOTE INTERNATIONAL LTD.</td> <td>2'20"</td> </tr> <tr> <td>2</td> <td>Night Breeze</td> <td>Hage Software</td> <td>1'56"</td> </tr> </tbody> </table>			Tune Number	Title	Composer	Time	1	Over The Edge	TECH-NOTE INTERNATIONAL LTD.	2'20"	2	Night Breeze	Hage Software	1'56"
Tune Number	Title	Composer	Time												
1	Over The Edge	TECH-NOTE INTERNATIONAL LTD.	2'20"												
2	Night Breeze	Hage Software	1'56"												

Synthesizer Parameters:	PCM set, amp envelope set, attack rate, release rate, pitch envelope set, pitch, level, touch sensitivity, pan, filter sensitivity, filter level, transpose
Mixer Channels: Modes: Parameters:	16 Internal, External, External/Solo, External/Play Program change number, volume, expression, pan, coarse tuning, fine tuning, Effect Send
MIDI:	16-channel multi-timbre receive, General MIDI Level 1
Other Functions Pitch Bend Range: Modulation: Transpose: Tuning:	Adjustable (12 semitones upwards and downwards) Equipped 25 steps (-12 semitones to +12 semitones) Adjustable (A4 = approximately 440Hz ±50 cents)
Terminals MIDI Terminal: Sustain/ Assignable Jack: • WK-1800 Headphones: Line Out (R, L/MONO): • WK-1600/1630 Headphones/Output: Power:	IN, OUT Standard jack (sustain, sostenuto, soft, rhythm start/stop) Stereo standard jack Output Impedance : 200Ω Output Voltage : 220mV (RMS) MAX Standard jack x 2 Output Impedance : 3kΩ Output Voltage : 1.5V (RMS) MAX Stereo standard jack Output Impedance: 200Ω Output Voltage: 5.5V (RMS) MAX 12V DC
Floppy Disk Drive (WK-1800 only) Type: Formats: Functions:	3.5" FDD 2DD (720KB MS-DOS format) 2HD (1.44MB MS-DOS format) Save and load of user tones, user rhythms, sequencer, and registration data; playback of SMF; disk formatting; file delete; accompaniment pattern style conversion
Power Supply: Batteries: Battery Life: AC Adapter: Auto Power Off:	Dual power supply system Six D-size batteries Approximately 2 hours continuous operation on alkaline batteries AD-12 Turns power off approximately six minutes after last key operation. Enabled under battery power only, can be disabled manually.
Speaker Output:	5W + 5W
Power Consumption:	12V --- 18W
Dimensions:	122.5 x 42.3 x 16.7 cm (48 1/4 x 16 11/16 x 6 9/16 inch)
Weight (without batteries):	Approximately 9.8kg (21.6 lbs) (WK-1800) Approximately 9.3kg (20.5 lbs) (WK-1600/1630)

Appendix

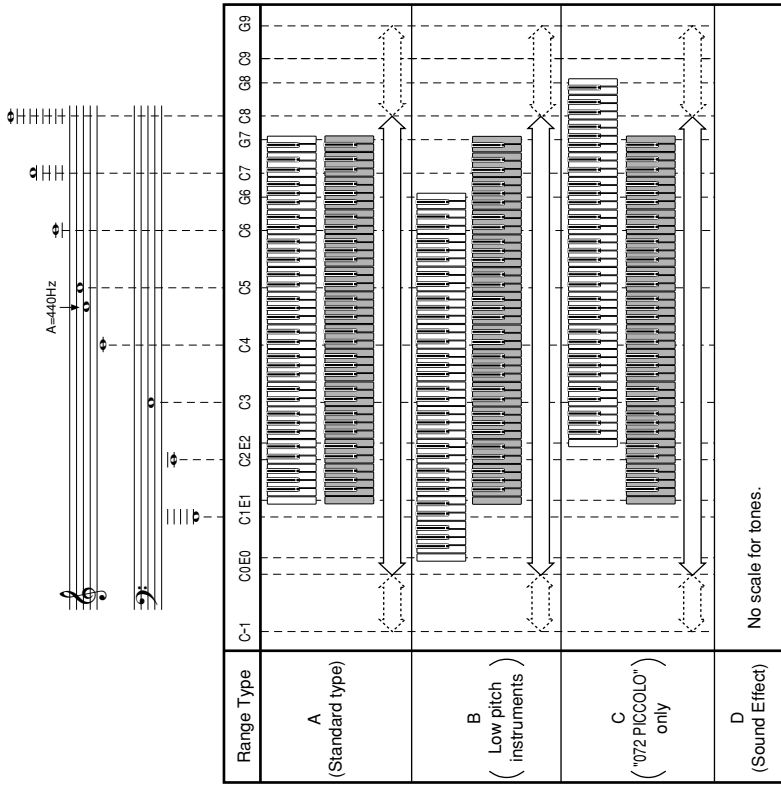

- aRange of keyboard play (SOUND RANGE SHIFT tuned on)
- bRange of keyboard play (SOUND RANGE SHIFT tuned off)
- cPlayable range (Transpose, when receiving MIDI data)
- dRange in which same note is played in nearest octave as a result of transpose and MIDI data receive operation. (Transpose, when receiving MIDI data)

Note Table

(1)	(2)	(3)	(4)	(1)	(2)	(3)	(4)	(1)	(2)	(3)	(4)	(1)	(2)	(3)	(4)
000	32	A	A0-C8	010	16	A	C4-C6	020	32	A	C2-C7	030	32	A	E2-D6
001	32	A	A0-C8	011	32	A	F3-F6	021	16	A	F3-F6	031	32	A	E2-D6
002	16	A	A0-C8	012	32	A	C3-C6	022	32	A	C4-C6	032	32	B	E1-G3
003	16	A	A0-C8	013	32	A	F4-C7	023	16	A	F3-F6	033	32	B	E1-G3
004	32	A	E1-G7	014	32	A	C4-F5	024	32	A	E2-C6	034	32	B	E1-G3
005	32	A	E1-G7	015	16	A	C4-C6	025	32	A	E2-C6	035	32	B	E1-G3
006	32	A	F2-F6	016	16	A	C2-C7	026	32	A	E2-D6	036	32	B	E1-G3
007	32	A	C2-C7	017	16	A	C2-C7	027	32	A	E2-D6	037	32	B	E1-G3
008	32	A	C4-C8	018	16	A	C2-C7	028	32	A	E2-D6	038	32	B	E1-G3
009	16	A	C5-C8	019	32	A	A0-C8	029	32	A	E2-D6	039	32	B	E1-G3

(1)	(2)	(3)	(4)	(1)	(2)	(3)	(4)	(1)	(2)	(3)	(4)				
040	32	A	G3-C7	050	32	A	C2-C7	060	16	A	F2-F5	070	32	A	A#1-C5
041	32	A	C3-C6	051	16	A	C2-C7	061	32	A	D3-G6	071	32	A	D3-G6
042	32	A	C2-C5	052	32	A	C3-G5	062	16	A	C2-C7	072	32	C	D5-C8
043	32	B	E1-G3	053	32	A	C3-G5	063	16	A	C2-C7	073	32	A	C4-C7
044	32	A	E1-C7	054	16	A	C3-C6	064	32	A	F3-D6	074	32	A	C4-C7
045	32	A	E1-C7	055	16	A	C3-C5	065	32	A	C3-G#5	075	32	A	C4-C7
046	32	A	B0-G7	056	32	A	A#3-A#6	066	32	A	F2-D#5	076	16	A	C4-C7
047	32	A	C2-A3	057	32	A	A#1-D#5	067	32	A	C2-G#4	077	32	A	G3-C6
048	32	A	E1-C7	058	32	A	F1-G3	068	32	A	A#3-G6	078	32	A	C4-C7
049	32	A	E1-C7	059	32	A	A#3-A#5	069	32	A	E3-A5	079	32	A	C4-C6

(1)	(2)	(3)	(4)	(1)	(2)	(3)	(4)	(1)	(2)	(3)	(4)				
080	16	A	A0-C8	090	16	A	C2-C7	100	16	A	C2-C7	110	16	A	G3-C7
081	16	A	A0-C8	091	16	A	C2-C7	101	16	A	C2-C7	111	32	A	C3-C5
082	16	A	C2-C7	092	16	A	C2-C7	102	16	A	C2-C7	112	32	A	C3-C5
083	16	A	C2-C7	093	16	A	C2-C7	103	16	A	C2-C7	113	32	A	C4-C5
084	16	A	C2-C7	094	16	A	C2-C7	104	32	A	C3-F5	114	16	A	E3-E5
085	16	A	C2-C7	095	16	A	C2-C7	105	32	A	C3-C6	*115	32	D	C4-C5
086	16	A	A0-C8	096	16	A	C2-C7	106	32	A	D3-G5	*116	32	D	C4-C5
087	16	A	A0-C8	097	16	A	C2-C7	107	32	A	G3-C6	*117	32	D	C4-C5
088	16	A	C2-C7	098	16	A	C2-C7	108	32	A	C3-G5	*118	16	D	C4-C5
089	32	A	C2-C7	099	16	A	C2-C7	109	16	A	C2-F5	*119	32	D	C4-C5

- (1): Tone number
 - (2): Maximum polyphony
 - (3): Range type
 - (4): Recommended sound range for General MIDI
- NOTES**
- The meaning of each range type is described to the right.
 - The pitch of tones marked with an asterisk do not change, no matter which keyboard key is pressed.
 - Turning on SOUND RANGE SHIFT (Page E-59) causes range type B and C tones to shift by one octave.

Free Session Chord Progression Chart: Key of C

No.	PATTERN NAME	Chord Progression
8 BEAT		
000	8 BEAT 1	C Am7 Dm7 G Gm A7 Dm E7 Am Am7 Dm Fm7 C Dm7 G7 C C
001	8 BEAT 2	CM7 Em7 Am7 Dm7 G7 C Em7 Am7 Dm7 G7 Em7 Fm7 B7 Em7 A7 Dm7 G7
002	8 BEAT BALLAD 1	C E7 Am7 D7 Gm7 C7 F Ab Bb
003	8 BEAT BALLAD 2	C F C F C Am Dm7 G7
004	8 BEAT BALLAD 3	CM7 Em7 Fm7 Em7 Asus Dm7 Gsus G Am Dm7 G7
005	PIANO ROCK	C Em F G7
006	POP ROCK 1	C Am7 C Am7 Dm7 x Gsus G7
007	POP ROCK 2	C x x x F x C x G x F x C x x x
008	70'S 8 BEAT	C x G x x G7 C C7 F x C x G7 C x F/G
009	60'S 8 BEAT	C F C Em Am F G C F C Em Am F G Em x 9/A Am 9/A Am 9/6 Dm 9/6 Dm 9/6 Am7/6 G7
16 BEAT		
010	16 BEAT 1	CM7 Fm7 CM7 x Fm7 Em7 Em7 A7 Dm7 Em7 Am7 Dm7 D7 CM7 x
011	16 BEAT 2	C x CM7 Dm7 x Fm7 Em7 Dm7 F/G C Fm7 F/G
012	16 BEAT SHUFFLE	C x CM7 Dm7 Em7 Dm7 Fm7 Em7 F/G C x F/G
013	16 BEAT BALLAD 1	CM7 Fm7 Fm7 Em7 A7 Dm7 G7 C
014	16 BEAT BALLAD 2	CM7 Am B7 F Gm7 C7 Am7 D7 Gm7 Em7 Am7 D7 Gm7 C7 F A7 B7 C
015	16 BEAT BALLAD 3	CM7 x Am7 x Dm7 x F/G x
016	16 BEAT SOUL	CM7 x x x Gm7 x CM7 x AM7 x CM7 x Gsus G
017	BIG BAND ROCK	Cm Gm A7 Fm Cm Gm A7 Fm E7 A7 Dm7 G7
018	FUNKY POP 1	C7 x x x F7 x C7 x G7 F7 C7 x
019	FUNKY POP 2	C Em7 Am7 Fm7 C Am Dm7 Gsus G7
ROCK		
020	SHUFFLE ROCK	C x x x F7 x C x G7 x C x F7 F7 x C x x G
021	8 BEAT ROCK	C Em Fm7 Dm7 F/G Am Em F C Am Em F x F/G G 9/4 Em7 Dm7
022	70'S ROCK	C B7 F C
023	80'S ROCK	C Em F Dm F/G C Em F Dm F/G Fm7 Em7 Dm7 Em7 Fm7 F/G
024	HEAVY METAL	C B7 F C B7 F C B7 F C B7 F C x F x G x
025	R & B	C7 x x x F7 x C7 x G7 F7 C7 x
026	ROCK	C x B7 Am G x F G Am x B7 F Am G Csus C
027	50'S R&R	C x x x G7 F x C x G7 F7 C x
028	NEW ORLANS R&R	C7 x x x F7 x C7 x G7 F7 C7 x
029	TWIST	C x x x F x C x G F C x
POPS I		
030	MODERN R&B	C E7 Am C7 F A7 Dm G E7 Am E7 Am D7 Dm Dm G7 C C
031	POP	C F C x x F G x C F C x B7 F C C
032	POP SHUFFLE	C F C F C F C Am G F C F C G7
033	80'S POP	C Am G6 Fm7 Dm7 F/G C Am G6 Fm7 Dm7 F/G A7 B7/A7 Gm7 Csus7 C7 A7 B7/A7 E7 F/G
034	SOUL POP	CM7 x x x Gm7 x CM7 x AM7 x CM7 x Gsus G
035	WORLD POP	CM7 Bm7 Am7 Dsus7 G
036	SLOW ROCK	C 9/8 Am Em7/6 F F/G G C G
037	6/8 BALLAD	C Asus A Dm G F Em Am Dm7 G7
038	SOUL BALLAD	C Dm7 E7 Am7 Gm7 C F6 Fdim 9/6 A7 D7 G7 E7 A7 D7 G7 C Bm7 E7 Am7 Gm7 C F6 Fdim 9/6 A7 D7 G7 C Gaug
039	ROCK WALTZ	C x F G F G C x C7 F G F/A 9/8 C Gsus7

Drum Assignment List

"←" indicates the same sound as STANDARD SET.

Key/Note Number	STANDARD SET	ROOM SET	POWER SET	ELECTRONIC SET	Key/Note Number	SYNTH SET	JAZZ SET	BRUSH SET	ORCHESTRA SET
E1 28	HIGH O SLAP				E1 27				CLOSED HI-HAT
F1 29	SCRATCH PUSH				F1 30				PEDAL HI-HAT
G1 31	SCRATCH PULL				G1 31				OPEN HI-HAT
A1 33	STICKS				A1 32				HIDE CYMBAL 1
B1 35	SQUARE CLICK				B1 34				JAZZ KICK 1
C2 36	METRONOME CLICK				C2 37				CONCERT BASS DRUM
D2 38	STANDARD KICK 2	POWER KICK 2	POWER KICK 2	POWER KICK 2	D2 38				CONCERT SNARE
E2 40	STANDARD KICK 1	POWER KICK 1	POWER KICK 1	ELEC KICK	E2 39				CASTANETS
F2 41	STANDARD SNARE 1	ROOM SNARE 1	POWER SNARE 1	ELEC SNARE	F2 42				CONCERT SNARE
G2 43	STANDARD SNARE 2	ROOM SNARE 2	ROOM SNARE 2	DANCE SNARE	G2 43				TIMPANI F
A2 45	LOW TOM 2	ROOM LOW TOM 2	ROOM LOW TOM 2	ELEC LOW TOM 2	A2 44				TIMPANI F#
B2 47	LOW TOM 1	ROOM LOW TOM 1	ROOM LOW TOM 1	ELEC LOW TOM 1	B2 46				TIMPANI G
C3 48	MID TOM 2	ROOM MID TOM 2	ROOM MID TOM 2	ELEC MID TOM 2	C3 48				TIMPANI A
D3 50	MID TOM 1	ROOM MID TOM 1	ROOM MID TOM 1	ELEC MID TOM 1	D3 50				TIMPANI B
E3 52	OPEN HI-HAT	ROOM HI TOM 2	ROOM HI TOM 2	ELEC HI TOM 2	E3 52				TIMPANI C
F3 53	HIGH TOM 2	ROOM HI TOM 1	ROOM HI TOM 1	ELEC HI TOM 1	F3 53				TIMPANI D
G3 55	HIGH TOM 1	ROOM HI TOM 1	ROOM HI TOM 1	REVERSE CYMBAL	G3 55				TIMPANI E
A3 57	CRASH CYMBAL 1				A3 56				TIMPANI F
B3 59	CRASH CYMBAL 2				B3 58				TIMPANI G
C4 60	RIDE BELL				C4 60				TIMPANI A
D4 62	TAMBOURINE				D4 62				TIMPANI B
E4 64	SPLASH CYMBAL				E4 64				TIMPANI C
F4 65	CHINA CYMBAL				F4 65				TIMPANI D
G4 67	CRASH CYMBAL 2				G4 67				TIMPANI E
A4 69	VIBRA-SLAP				A4 68				TIMPANI F
B4 71	HIGH BONGO				B4 70				TIMPANI G
C5 72	LOW BONGO				C5 72				CONCERT CYMBAL 2
D5 74	MUTE HIGH CONGA				D5 74				CONCERT CYMBAL 1
E5 76	LOW CONGA				E5 76				
F5 77	HIGH TIMBALE				F5 77				
G5 79	LOW TIMBALE				G5 79				
A5 81	HIGH AGOGO				A5 80				
B5 83	LOW AGOGO				B5 82				
C6 84	CABASA				C6 84				
D6 86	MARACAS				D6 86				
E6 88	SHORT HI WHISTLE				E6 88				APPLAUSE
	LONG LOW WHISTLE								
	SHORT GUIRO								
	LONG GUIRO								
	CLAVES								
	HIGH WOOD BLOCK								
	LOW WOOD BLOCK								
	MUTE CUICA								
	OPEN CUICA								
	MUTE TRIANGLE								
	OPEN TRIANGLE								
	JINGLE BELL								
	BELL TREE								
	CASTANETS								
	MUTE SURDO								
	OPEN SURDO								

Fingered Chord Chart

Chord Type Root	M	m	7	m7	dim7	M7	dim	m7-5
C								
C#/(D♭)								
D								
(D#)/E♭								
E								
F								
F#/(G♭)								
G								
(G#)/A♭								
A								
(A#)/B♭								
B								

NOTE

You can use the above fingerings to finger chords within the accompaniment keyboard range.

Chord Type Root	aug	sus4	7sus4	m add9	mM7	7-5	add9
C							
C#/(D♭)							
D							
(D♯)/E♭							
E							
F							
F#/(G♭)							
G							
(G♯)/A♭							
A							
(A♯)/B♭							
B							

Chord Conversion Table

- The applicable chord conversion table depends on the particular combination of elements and parts. The symbol ○ in the table below indicates that a chord table is applicable, while × indicates that a chord table is not applicable.
- The explanations in the "Description" column all assume the following conditions for the recorded accompaniment pattern.

Root: C

Major chords, unless specified otherwise.

- The explanations in the "Description" column describe how the recorded accompaniment (12 notes from C to B) are modified when an accompaniment chord is specified.
- The shaded rows are the default numbers for each element and part.

No.	Names	Element Names		Part Names			Description
		Intro, Ending	Normal, Variation, Normal/Fill-in, Variation/Fill-in	Bass	Chord 1	Chord 2	
00	Basic Bass	×	○	○	×		Normally used for the bass part.
01	7th Bass	×	○	○	×		Used for a bass part recorded by a 7th chord.
02	Basic Chord	×	○	×	○		Normally used for the chord part.
03	Basic Chord2	×	○	×	○		A variation of Number 02 with different conversion when Gm7/C is specified during accompaniment.
04	Variation Chord1	×	○	×	○		Specifying a 7th chord during play transforms the 5th note of the scale to the 7th note of the scale. In the case of C7, for example, G becomes B ^b .
05	Variation Chord2	×	○	×	○		Variation of number 04 (Variation Chord 1)
06	7th Chord	×	○	×	○		Used for the chord part when a 7th chord is recorded.
07	Minor Chord	×	○	×	○		Used for the chord part when a minor chord is recorded.
08	Major Phrase	×	○	×	○		Used for the chord part when a phrase is recorded in a major scale.
09	Minor Bass Phrase	×	○	○	×		Used for the bass part when a phrase is recorded in a minor scale.
10	Penta Phrase	×	○	×	○		Used for the chord part when a phrase is recorded in a penta scale (CDEGA).
11	Natural Minor	○	×	○	○		Transforms to natural minor when a minor chord is played.
12	Melodic Minor	○	×	○	○		Transforms to melodic minor (ascending) when a minor chord is played.
13	Harmonic Minor	○	×	○	○		Transforms to harmonic minor when a minor chord is played.
14	No Change	○	×	○	○		Original chord as recorded in response to chord that is played, without transformation to minor or major.
15	Melodic Minor 2	○	×	○	○		Variation of number 12 (Melodic Minor). Playing a major chord causes recorded B ^b notes to be transformed to B, while playing a minor chord plays B ^b as it is.
16	Dorian Scale	○	×	○	○		Play of a minor chord is transformed to the Dorian scale. The Dorian scale lowers the major scale E and B one semitone.
17	Minor → Major	○	×	○	○		Used for intro and ending recorded with minor chords.
18	Tension chord	×	○	×	○		Used for the tension chord part used in jazz, bossa nova, etc.

Blank sheet of lined paper with horizontal ruling lines.

Blank sheet of music paper with ten sets of five-line staves.

Blank sheet of music paper with ten sets of five-line staves.

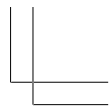
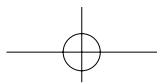

Blank musical staff

Blank musical staff

Blank musical staff

Blank musical staff

Blank musical staff

Blank musical staff

Blank musical staff

Blank musical staff

Blank musical staff

Blank musical staff

Blank musical staff

Blank musical staff

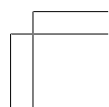
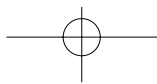
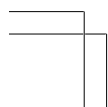
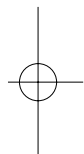
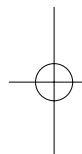

Blank sheet of music paper with ten sets of five-line staves.

MIDI Implementation Chart

Model WK-1800/WK-1600/WK-1630

Version: 1.0

Function	Transmitted	Recognized	Remarks
Basic Channel	1 - 16*1 1 - 16	1 - 16 1 - 16	*1 Hold in memory as long as the power is supplied
Mode	Mode 3 X *****	Mode 3 X *****	
Note Number:	28 - 103 *****	0 - 127 12 - 108*2	*2 See page A-1.
Velocity	Note ON Note OFF X 9nH v = 1 - 127 X 9nH v = 0	O 9nH v = 1 - 127 X 9nH v = 0, 8nH v = XX	XX = no relation
After Touch	Key's Ch's X X	X O*3	
Pitch Bender	O	O	
Control Change	0, 32 1 6, 38 7 10 11 64 66 67 91 O O O*4 O O O O*5 O*5 O*5 O	O O*3 O*4 O O O O O O O O O O	Bank select Modulation Data entry Volume Pan Expression Hold1 Sostenuto Soft pedal Effect send
100 101	O*4	O*4	RPN LSB, MSB

100, 101 120 121	<input type="radio"/> *4 <input checked="" type="radio"/> X <input checked="" type="radio"/> X	<input type="radio"/> *4 <input checked="" type="radio"/> X <input checked="" type="radio"/> X	RPN LSB, MSB All sound off Reset all controller
Program Change: True #	<input type="radio"/> 0 - 127 *****	<input type="radio"/> 0 - 127 *****	
System Exclusive	<input type="radio"/> *6	<input type="radio"/> *6	
System Common : Song Pos : Song Sel : Tune	<input checked="" type="radio"/> X <input checked="" type="radio"/> X <input checked="" type="radio"/> X	<input checked="" type="radio"/> X <input checked="" type="radio"/> X <input checked="" type="radio"/> X	
System Real Time : Clock : Commands	<input type="radio"/> O <input type="radio"/> O	<input type="radio"/> O <input type="radio"/> O	
Aux Messages : Local ON/OFF : All notes OFF : Active Sense : Reset	<input checked="" type="radio"/> X <input checked="" type="radio"/> X <input checked="" type="radio"/> X <input checked="" type="radio"/> X	<input checked="" type="radio"/> X <input type="radio"/> O <input type="radio"/> O <input checked="" type="radio"/> X	
Remarks	*3 Modulation and after touch for each channel are the same effect. *4 Pitch bend sense, fine tune, coarse tune send/receive, and RPN Null receive *5 In accordance with assignable jack setting *6 GM on/off GM ON : [F0] [7E] [7F] [09] [01] [F7] GM OFF : [F0] [7E] [7F] [09] [02] [F7] Effect change [F0] [44] [0B] [09] [XX] [F7] XX=00 : Reverb1, 01 : Reverb2, 02 : Reverb3, 03 : Chorus, 04 : Tremolo, 05 : Phaser, 06 : Organ Sp, 07 : Enhancer, 08 : Flanger, 09 : Loudness, 0F : OFF Bulk dump [F0] [44] [YY] [YY] [0L ₁₂₇] [0H ₁₂₇] [0L ₁₂₆] [0H ₁₂₆] [0L ₁₂₅] [0H ₁₂₅] [0L ₁₂₄] [0H ₁₂₄] [0L ₁₂₃] [0H ₁₂₃] [0L ₁₂₂] [0H ₁₂₂] [0L ₁₂₁] [0H ₁₂₁] [0L ₁₂₀] [0H ₁₂₀] [0L ₁₁₉] [0H ₁₁₉] [0L ₁₁₈] [0H ₁₁₈] [0L ₁₁₇] [0H ₁₁₇] [0L ₁₁₆] [0H ₁₁₆] [0L ₁₁₅] [0H ₁₁₅] [0L ₁₁₄] [0H ₁₁₄] [0L ₁₁₃] [0H ₁₁₃] [0L ₁₁₂] [0H ₁₁₂] [0L ₁₁₁] [0H ₁₁₁] [0L ₁₁₀] [0H ₁₁₀] [0L ₁₀₉] [0H ₁₀₉] [0L ₁₀₈] [0H ₁₀₈] [0L ₁₀₇] [0H ₁₀₇] [0L ₁₀₆] [0H ₁₀₆] [0L ₁₀₅] [0H ₁₀₅] [0L ₁₀₄] [0H ₁₀₄] [0L ₁₀₃] [0H ₁₀₃] [0L ₁₀₂] [0H ₁₀₂] [0L ₁₀₁] [0H ₁₀₁] [0L ₁₀₀] [0H ₁₀₀] [0L ₉₉] [0H ₉₉] [0L ₉₈] [0H ₉₈] [0L ₉₇] [0H ₉₇] [0L ₉₆] [0H ₉₆] [0L ₉₅] [0H ₉₅] [0L ₉₄] [0H ₉₄] [0L ₉₃] [0H ₉₃] [0L ₉₂] [0H ₉₂] [0L ₉₁] [0H ₉₁] [0L ₉₀] [0H ₉₀] [0L ₈₉] [0H ₈₉] [0L ₈₈] [0H ₈₈] [0L ₈₇] [0H ₈₇] [0L ₈₆] [0H ₈₆] [0L ₈₅] [0H ₈₅] [0L ₈₄] [0H ₈₄] [0L ₈₃] [0H ₈₃] [0L ₈₂] [0H ₈₂] [0L ₈₁] [0H ₈₁] [0L ₈₀] [0H ₈₀] [0L ₇₉] [0H ₇₉] [0L ₇₈] [0H ₇₈] [0L ₇₇] [0H ₇₇] [0L ₇₆] [0H ₇₆] [0L ₇₅] [0H ₇₅] [0L ₇₄] [0H ₇₄] [0L ₇₃] [0H ₇₃] [0L ₇₂] [0H ₇₂] [0L ₇₁] [0H ₇₁] [0L ₇₀] [0H ₇₀] [0L ₆₉] [0H ₆₉] [0L ₆₈] [0H ₆₈] [0L ₆₇] [0H ₆₇] [0L ₆₆] [0H ₆₆] [0L ₆₅] [0H ₆₅] [0L ₆₄] [0H ₆₄] [0L ₆₃] [0H ₆₃] [0L ₆₂] [0H ₆₂] [0L ₆₁] [0H ₆₁] [0L ₆₀] [0H ₆₀] [0L ₅₉] [0H ₅₉] [0L ₅₈] [0H ₅₈] [0L ₅₇] [0H ₅₇] [0L ₅₆] [0H ₅₆] [0L ₅₅] [0H ₅₅] [0L ₅₄] [0H ₅₄] [0L ₅₃] [0H ₅₃] [0L ₅₂] [0H ₅₂] [0L ₅₁] [0H ₅₁] [0L ₅₀] [0H ₅₀] [0L ₄₉] [0H ₄₉] [0L ₄₈] [0H ₄₈] [0L ₄₇] [0H ₄₇] [0L ₄₆] [0H ₄₆] [0L ₄₅] [0H ₄₅] [0L ₄₄] [0H ₄₄] [0L ₄₃] [0H ₄₃] [0L ₄₂] [0H ₄₂] [0L ₄₁] [0H ₄₁] [0L ₄₀] [0H ₄₀] [0L ₃₉] [0H ₃₉] [0L ₃₈] [0H ₃₈] [0L ₃₇] [0H ₃₇] [0L ₃₆] [0H ₃₆] [0L ₃₅] [0H ₃₅] [0L ₃₄] [0H ₃₄] [0L ₃₃] [0H ₃₃] [0L ₃₂] [0H ₃₂] [0L ₃₁] [0H ₃₁] [0L ₃₀] [0H ₃₀] [0L ₂₉] [0H ₂₉] [0L ₂₈] [0H ₂₈] [0L ₂₇] [0H ₂₇] [0L ₂₆] [0H ₂₆] [0L ₂₅] [0H ₂₅] [0L ₂₄] [0H ₂₄] [0L ₂₃] [0H ₂₃] [0L ₂₂] [0H ₂₂] [0L ₂₁] [0H ₂₁] [0L ₂₀] [0H ₂₀] [0L ₁₉] [0H ₁₉] [0L ₁₈] [0H ₁₈] [0L ₁₇] [0H ₁₇] [0L ₁₆] [0H ₁₆] [0L ₁₅] [0H ₁₅] [0L ₁₄] [0H ₁₄] [0L ₁₃] [0H ₁₃] [0L ₁₂] [0H ₁₂] [0L ₁₁] [0H ₁₁] [0L ₁₀] [0H ₁₀] [0L ₉] [0H ₉] [0L ₈] [0H ₈] [0L ₇] [0H ₇] [0L ₆] [0H ₆] [0L ₅] [0H ₅] [0L ₄] [0H ₄] [0L ₃] [0H ₃] [0L ₂] [0H ₂] [0L ₁] [0H ₁] [0L ₀] [0H ₀] [0L ₋₁] [0H ₋₁] [0L ₋₂] [0H ₋₂] [0L ₋₃] [0H ₋₃] [0L ₋₄] [0H ₋₄] [0L ₋₅] [0H ₋₅] [0L ₋₆] [0H ₋₆] [0L ₋₇] [0H ₋₇] [0L ₋₈] [0H ₋₈] [0L ₋₉] [0H ₋₉] [0L ₋₁₀] [0H ₋₁₀] [0L ₋₁₁] [0H ₋₁₁] [0L ₋₁₂] [0H ₋₁₂] [0L ₋₁₃] [0H ₋₁₃] [0L ₋₁₄] [0H ₋₁₄] [0L ₋₁₅] [0H ₋₁₅] [0L ₋₁₆] [0H ₋₁₆] [0L ₋₁₇] [0H ₋₁₇] [0L ₋₁₈] [0H ₋₁₈] [0L ₋₁₉] [0H ₋₁₉] [0L ₋₂₀] [0H ₋₂₀] [0L ₋₂₁] [0H ₋₂₁] [0L ₋₂₂] [0H ₋₂₂] [0L ₋₂₃] [0H ₋₂₃] [0L ₋₂₄] [0H ₋₂₄] [0L ₋₂₅] [0H ₋₂₅] [0L ₋₂₆] [0H ₋₂₆] [0L ₋₂₇] [0H ₋₂₇] [0L ₋₂₈] [0H ₋₂₈] [0L ₋₂₉] [0H ₋₂₉] [0L ₋₃₀] [0H ₋₃₀] [0L ₋₃₁] [0H ₋₃₁] [0L ₋₃₂] [0H ₋₃₂] [0L ₋₃₃] [0H ₋₃₃] [0L ₋₃₄] [0H ₋₃₄] [0L ₋₃₅] [0H ₋₃₅] [0L ₋₃₆] [0H ₋₃₆] [0L ₋₃₇] [0H ₋₃₇] [0L ₋₃₈] [0H ₋₃₈] [0L ₋₃₉] [0H ₋₃₉] [0L ₋₄₀] [0H ₋₄₀] [0L ₋₄₁] [0H ₋₄₁] [0L ₋₄₂] [0H ₋₄₂] [0L ₋₄₃] [0H ₋₄₃] [0L ₋₄₄] [0H ₋₄₄] [0L ₋₄₅] [0H ₋₄₅] [0L ₋₄₆] [0H ₋₄₆] [0L ₋₄₇] [0H ₋₄₇] [0L ₋₄₈] [0H ₋₄₈] [0L ₋₄₉] [0H ₋₄₉] [0L ₋₅₀] [0H ₋₅₀] [0L ₋₅₁] [0H ₋₅₁] [0L ₋₅₂] [0H ₋₅₂] [0L ₋₅₃] [0H ₋₅₃] [0L ₋₅₄] [0H ₋₅₄] [0L ₋₅₅] [0H ₋₅₅] [0L ₋₅₆] [0H ₋₅₆] [0L ₋₅₇] [0H ₋₅₇] [0L ₋₅₈] [0H ₋₅₈] [0L ₋₅₉] [0H ₋₅₉] [0L ₋₆₀] [0H ₋₆₀] [0L ₋₆₁] [0H ₋₆₁] [0L ₋₆₂] [0H ₋₆₂] [0L ₋₆₃] [0H ₋₆₃] [0L ₋₆₄] [0H ₋₆₄] [0L ₋₆₅] [0H ₋₆₅] [0L ₋₆₆] [0H ₋₆₆] [0L ₋₆₇] [0H ₋₆₇] [0L ₋₆₈] [0H ₋₆₈] [0L ₋₆₉] [0H ₋₆₉] [0L ₋₇₀] [0H ₋₇₀] [0L ₋₇₁] [0H ₋₇₁] [0L ₋₇₂] [0H ₋₇₂] [0L ₋₇₃] [0H ₋₇₃] [0L ₋₇₄] [0H ₋₇₄] [0L ₋₇₅] [0H ₋₇₅] [0L ₋₇₆] [0H ₋₇₆] [0L ₋₇₇] [0H ₋₇₇] [0L ₋₇₈] [0H ₋₇₈] [0L ₋₇₉] [0H ₋₇₉] [0L ₋₈₀] [0H ₋₈₀] [0L ₋₈₁] [0H ₋₈₁] [0L ₋₈₂] [0H ₋₈₂] [0L ₋₈₃] [0H ₋₈₃] [0L ₋₈₄] [0H ₋₈₄] [0L ₋₈₅] [0H ₋₈₅] [0L ₋₈₆] [0H ₋₈₆] [0L ₋₈₇] [0H ₋₈₇] [0L ₋₈₈] [0H ₋₈₈] [0L ₋₈₉] [0H ₋₈₉] [0L ₋₉₀] [0H ₋₉₀] [0L ₋₉₁] [0H ₋₉₁] [0L ₋₉₂] [0H ₋₉₂] [0L ₋₉₃] [0H ₋₉₃] [0L ₋₉₄] [0H ₋₉₄] [0L ₋₉₅] [0H ₋₉₅] [0L ₋₉₆] [0H ₋₉₆] [0L ₋₉₇] [0H ₋₉₇] [0L ₋₉₈] [0H ₋₉₈] [0L ₋₉₉] [0H ₋₉₉] [0L ₋₁₀₀] [0H ₋₁₀₀] [0L ₋₁₀₁] [0H ₋₁₀₁] [0L ₋₁₀₂] [0H ₋₁₀₂] [0L ₋₁₀₃] [0H ₋₁₀₃] [0L ₋₁₀₄] [0H ₋₁₀₄] [0L ₋₁₀₅] [0H ₋₁₀₅] [0L ₋₁₀₆] [0H ₋₁₀₆] [0L ₋₁₀₇] [0H ₋₁₀₇] [0L ₋₁₀₈] [0H ₋₁₀₈] [0L ₋₁₀₉] [0H ₋₁₀₉] [0L ₋₁₁₀] [0H ₋₁₁₀] [0L ₋₁₁₁] [0H ₋₁₁₁] [0L ₋₁₁₂] [0H ₋₁₁₂] [0L ₋₁₁₃] [0H ₋₁₁₃] [0L ₋₁₁₄] [0H ₋₁₁₄] [0L ₋₁₁₅] [0H ₋₁₁₅] [0L ₋₁₁₆] [0H ₋₁₁₆] [0L ₋₁₁₇] [0H ₋₁₁₇] [0L ₋₁₁₈] [0H ₋₁₁₈] [0L ₋₁₁₉] [0H ₋₁₁₉] [0L ₋₁₂₀] [0H ₋₁₂₀] [0L ₋₁₂₁] [0H ₋₁₂₁] [0L ₋₁₂₂] [0H ₋₁₂₂] [0L ₋₁₂₃] [0H ₋₁₂₃] [0L ₋₁₂₄] [0H ₋₁₂₄] [0L ₋₁₂₅] [0H ₋₁₂₅] [0L ₋₁₂₆] [0H ₋₁₂₆] [0L ₋₁₂₇] [0H ₋₁₂₇] [0L ₋₁₂₈] [0H ₋₁₂₈] [0L ₋₁₂₉] [0H ₋₁₂₉] [0L ₋₁₃₀] [0H ₋₁₃₀] [0L ₋₁₃₁] [0H ₋₁₃₁] [0L ₋₁₃₂] [0H ₋₁₃₂] [0L ₋₁₃₃] [0H ₋₁₃₃] [0L ₋₁₃₄] [0H ₋₁₃₄] [0L ₋₁₃₅] [0H ₋₁₃₅] [0L ₋₁₃₆] [0H ₋₁₃₆] [0L ₋₁₃₇] [0H ₋₁₃₇] [0L ₋₁₃₈] [0H ₋₁₃₈] [0L ₋₁₃₉] [0H ₋₁₃₉] [0L ₋₁₄₀] [0H ₋₁₄₀] [0L ₋₁₄₁] [0H ₋₁₄₁] [0L ₋₁₄₂] [0H ₋₁₄₂] [0L ₋₁₄₃] [0H ₋₁₄₃] [0L ₋₁₄₄] [0H ₋₁₄₄] [0L ₋₁₄₅] [0H ₋₁₄₅] [0L ₋₁₄₆] [0H ₋₁₄₆] [0L ₋₁₄₇] [0H ₋₁₄₇] [0L ₋₁₄₈] [0H ₋₁₄₈] [0L ₋₁₄₉] [0H ₋₁₄₉] [0L ₋₁₅₀] [0H ₋₁₅₀] [0L ₋₁₅₁] [0H ₋₁₅₁] [0L ₋₁₅₂] [0H ₋₁₅₂] [0L ₋₁₅₃] [0H ₋₁₅₃] [0L ₋₁₅₄] [0H ₋₁₅₄] [0L ₋₁₅₅] [0H ₋₁₅₅] [0L ₋₁₅₆] [0H ₋₁₅₆] [0L ₋₁₅₇] [0H ₋₁₅₇] [0L ₋₁₅₈] [0H ₋₁₅₈] [0L ₋₁₅₉] [0H ₋₁₅₉] [0L ₋₁₆₀] [0H ₋₁₆₀] [0L ₋₁₆₁] [0H ₋₁₆₁] [0L ₋₁₆₂] [0H ₋₁₆₂] [0L ₋₁₆₃] [0H ₋₁₆₃] [0L ₋₁₆₄] [0H ₋₁₆₄] [0L ₋₁₆₅] [0H ₋₁₆₅] [0L ₋₁₆₆] [0H ₋₁₆₆] [0L ₋₁₆₇] [0H ₋₁₆₇] [0L ₋₁₆₈] [0H ₋₁₆₈] [0L ₋₁₆₉] [0H ₋₁₆₉] [0L ₋₁₇₀] [0H ₋₁₇₀] [0L ₋₁₇₁] [0H ₋₁₇₁] [0L ₋₁₇₂] [0H ₋₁₇₂] [0L ₋₁₇₃] [0H ₋₁₇₃] [0L ₋₁₇₄] [0H ₋₁₇₄] [0L ₋₁₇₅] [0H ₋₁₇₅] [0L ₋₁₇₆] [0H ₋₁₇₆] [0L ₋₁₇₇] [0H ₋₁₇₇] [0L ₋₁₇₈] [0H ₋₁₇₈] [0L ₋₁₇₉] [0H ₋₁₇₉] [0L ₋₁₈₀] [0H ₋₁₈₀] [0L ₋₁₈₁] [0H ₋₁₈₁] [0L ₋₁₈₂] [0H ₋₁₈₂] [0L ₋₁₈₃] [0H ₋₁₈₃] [0L ₋₁₈₄] [0H ₋₁₈₄] [0L ₋₁₈₅] [0H ₋₁₈₅] [0L ₋₁₈₆] [0H ₋₁₈₆] [0L ₋₁₈₇] [0H ₋₁₈₇] [0L ₋₁₈₈] [0H ₋₁₈₈] [0L ₋₁₈₉] [0H ₋₁₈₉] [0L ₋₁₉₀] [0H ₋₁₉₀] [0L ₋₁₉₁] [0H ₋₁₉₁] [0L ₋₁₉₂] [0H ₋₁₉₂] [0L ₋₁₉₃] [0H ₋₁₉₃] [0L ₋₁₉₄] [0H ₋₁₉₄] [0L ₋₁₉₅] [0H ₋₁₉₅] [0L ₋₁₉₆] [0H ₋₁₉₆] [0L ₋₁₉₇] [0H ₋₁₉₇] [0L ₋₁₉₈] [0H ₋₁₉₈] [0L ₋₁₉₉] [0H ₋₁₉₉] [0L ₋₂₀₀] [0H ₋₂₀₀] [0L ₋₂₀₁] [0H ₋₂₀₁] [0L ₋₂₀₂] [0H ₋₂₀₂] [0L ₋₂₀₃] [0H ₋₂₀₃] [0L ₋₂₀₄] [0H ₋₂₀₄] [0L ₋₂₀₅] [0H ₋₂₀₅] [0L ₋₂₀₆] [0H ₋₂₀₆] [0L ₋₂₀₇] [0H ₋₂₀₇] [0L ₋₂₀₈] [0H ₋₂₀₈] [0L ₋₂₀₉] [0H ₋₂₀₉] [0L ₋₂₁₀] [0H ₋₂₁₀] [0L ₋₂₁₁] [0H ₋₂₁₁] [0L ₋₂₁₂] [0H ₋₂₁₂] [0L ₋₂₁₃] [0H ₋₂₁₃] [0L ₋₂₁₄] [0H ₋₂₁₄] [0L ₋₂₁₅] [0H ₋₂₁₅] [0L ₋₂₁₆] [0H ₋₂₁₆] [0L ₋₂₁₇] [0H ₋₂₁₇] [0L ₋₂₁₈] [0H ₋₂₁₈] [0L ₋₂₁₉] [0H ₋₂₁₉] [0L ₋₂₂₀] [0H ₋₂₂₀] [0L ₋₂₂₁] [0H ₋₂₂₁] [0L ₋₂₂₂] [0H ₋₂₂₂] [0L ₋₂₂₃] [0H ₋₂₂₃] [0L ₋₂₂₄] [0H ₋₂₂₄] [0L ₋₂₂₅] [0H ₋₂₂₅] [0L ₋₂₂₆] [0H ₋₂₂₆] [0L ₋₂₂₇] [0H ₋₂₂₇] [0L ₋₂₂₈] [0H ₋₂₂₈] [0L ₋₂₂₉] [0H ₋₂₂₉] [0L ₋₂₃₀] [0H ₋₂₃₀] [0L ₋₂₃₁] [0H ₋₂₃₁] [0L ₋₂₃₂] [0H ₋₂₃₂] [0L ₋₂₃₃] [0H ₋₂₃₃] [0L ₋₂₃₄] [0H ₋₂₃₄] [0L ₋₂₃₅] [0H ₋₂₃₅] [0L ₋₂₃₆] [0H ₋₂₃₆] [0L ₋₂₃₇] [0H ₋₂₃₇] [0L ₋₂₃₈] [0H ₋₂₃₈] [0L ₋₂₃₉] [0H ₋₂₃₉] [0L ₋₂₄₀] [0H ₋₂₄₀] [0L ₋₂₄₁] [0H ₋₂₄₁] [0L ₋₂₄₂] [0H ₋₂₄₂] [0L ₋₂₄₃] [0H ₋₂₄₃] [0L ₋₂₄₄] [0H ₋₂₄₄] [0L ₋₂₄₅] [0H ₋₂₄₅] [0L ₋₂₄₆] [0H ₋₂₄₆] [0L ₋₂₄₇] [0H ₋₂₄₇] [0L ₋₂₄₈] [0H ₋₂₄₈] [0L ₋₂₄₉] [0H ₋₂₄₉] [0L ₋₂₅₀] [0H ₋₂₅₀] [0L ₋₂₅₁] [0H ₋₂₅₁] [0L ₋₂₅₂] [0H ₋₂₅₂] [0L ₋₂₅₃] [0H ₋₂₅₃] [0L ₋₂₅₄] [0H ₋₂₅₄] [0L ₋₂₅₅] [0H ₋₂₅₅] [0L ₋₂₅₆] [0H ₋₂₅₆] [0L ₋₂₅₇] [0H ₋₂₅₇] [0L ₋₂₅₈] [0H ₋₂₅₈] [0L ₋₂₅₉] [0H ₋₂₅₉] [0L ₋₂₆₀] [0H ₋₂₆₀] [0L ₋₂₆₁] [0H ₋₂₆₁] [0L ₋₂₆₂] [0H ₋₂₆₂] [0L ₋₂₆₃] [0H ₋₂₆₃] [0L ₋₂₆₄] [0H ₋₂₆₄] [0L ₋₂₆₅] [0H ₋₂₆₅] [0L ₋₂₆₆] [0H ₋₂₆₆] [0L ₋₂₆₇] [0H ₋₂₆₇] [0L ₋₂₆₈] [0H ₋₂₆₈] [0L ₋₂₆₉] [0H ₋₂₆₉] [0L ₋₂₇₀] [0H ₋₂₇₀] [0L ₋₂₇₁] [0H ₋₂₇₁] [0L ₋₂₇₂] [0H ₋₂₇₂] [0L ₋₂₇₃] [0H ₋₂₇₃] [0L ₋₂₇₄] [0H ₋₂₇₄] [0L ₋₂₇₅] [0H ₋₂₇₅] [0L ₋₂₇₆] [0H ₋₂₇₆] [0L ₋₂₇₇] [0H ₋₂₇₇] [0L ₋₂₇₈] [0H ₋₂₇₈] [0L ₋₂₇₉] [0H ₋₂₇₉] [0L ₋₂₈₀] [0H ₋₂₈₀] [0L ₋₂₈₁] [0H ₋₂₈₁] [0L ₋₂₈₂] [0H ₋₂₈₂] [0L ₋₂₈₃] [0H ₋₂₈₃] [0L ₋₂₈₄] [0H ₋₂₈₄] [0L ₋₂₈₅] [0H ₋₂₈₅] [0L ₋₂₈₆] [0H ₋₂₈₆] [0L ₋₂₈₇] [0H ₋₂₈₇] [0L ₋₂₈₈] [0H ₋₂₈₈] [0L ₋₂₈₉] [0H ₋₂₈₉] [0L ₋₂₉₀] [0H ₋₂₉₀] [0L ₋₂₉₁] [0H ₋₂₉₁] [0L ₋₂₉₂] [0H ₋₂₉₂] [0L ₋₂₉₃] [0H ₋₂₉₃] [0L ₋₂₉₄] [0H ₋₂₉₄] [0L ₋₂₉₅] [0H ₋₂₉₅] [0L ₋₂₉₆] [0H ₋₂₉₆] [0L ₋₂₉₇] [0H ₋₂₉₇] [0L ₋₂₉₈] [0H ₋₂₉₈] [0L ₋₂₉₉] [0H ₋₂₉₉] [0L ₋₃₀₀] [0H ₋₃₀₀] [0L ₋₃₀₁] [0H ₋₃₀₁] [0L ₋₃₀₂] [0H ₋₃₀₂] [0L ₋₃₀₃] [0H ₋₃₀₃] [0L ₋₃₀₄] [0H ₋₃₀₄] [0L ₋₃₀₅] [0H ₋₃₀₅] [0L ₋₃₀₆] [0H ₋₃₀₆] [0L ₋₃₀₇] [0H ₋₃₀₇] [0L ₋₃₀₈] [0H ₋₃₀₈] [0L ₋₃₀₉] [0H ₋₃₀₉] [0L ₋₃₁₀] [0H ₋₃₁₀] [0L ₋₃₁₁] [0H ₋₃₁₁] [0L ₋₃₁₂] [0H ₋₃₁₂] [0L ₋₃₁₃] [0H ₋₃₁₃] [0L ₋₃₁₄] [0H ₋₃₁₄] [0L ₋₃₁₅] [0H ₋₃₁₅] [0L ₋₃₁₆] [0H ₋₃₁₆] [0L ₋₃₁₇] [0H ₋₃₁₇] [0L ₋₃₁₈] [0H ₋₃₁₈] [0L ₋₃₁₉] [0H ₋₃₁₉] [0L ₋₃₂₀] [0H ₋₃₂₀] [0L ₋₃₂₁] [0H ₋₃₂₁] [0L ₋₃₂₂] [0H ₋₃₂₂] [0L ₋₃₂₃] [0H ₋₃₂₃] [0L ₋₃₂₄] [0H ₋₃₂₄] [0L ₋₃₂₅] [0H ₋₃₂₅] [0L ₋₃₂₆] [0H ₋₃₂₆] [0L ₋₃₂₇] [0H ₋₃₂₇] [0L ₋₃₂₈] [0H ₋₃₂₈] [0L ₋₃₂₉] [0H ₋₃₂₉] [0L ₋₃₃₀] [0H ₋₃₃₀] [0L ₋₃₃₁] [0H ₋₃₃₁] [0L ₋₃₃₂] [0H ₋₃₃₂] [0L ₋₃₃₃] [0H ₋₃₃₃] [0L ₋₃₃₄] [0H ₋₃₃₄] [0L ₋₃₃₅] [0H ₋₃₃₅] [0L ₋₃₃₆] [0H ₋₃₃₆] [0L ₋₃₃₇] [0H ₋₃₃₇] [0L ₋₃₃₈] [0H ₋₃₃₈] [0L ₋₃₃₉] [0H ₋₃₃₉] [0L ₋₃₄₀] [0H ₋₃₄₀] [0L ₋₃₄₁] [0H ₋₃₄₁] [0L ₋₃₄₂] [0H ₋₃₄₂] [0L ₋₃₄₃] [0H ₋₃₄₃] [0L ₋₃₄₄] [0H ₋₃₄₄] [0L ₋₃₄₅] [0H ₋₃₄₅] [0L ₋₃₄₆] [0H ₋₃₄₆] [0L ₋₃₄₇] [0H ₋₃₄₇] [0L ₋₃₄₈] [0H ₋₃₄₈] [0L ₋₃₄₉] [0H ₋₃₄₉] [0L ₋₃₅₀] [0H ₋₃₅₀] [0L ₋₃₅₁] [0H ₋₃₅₁] [0L ₋₃₅₂] [0H ₋₃₅₂] [0L ₋₃₅₃] [0H ₋₃₅₃] [0L ₋₃₅₄] [0H ₋₃₅₄] [0L ₋₃₅₅] [0H ₋₃₅₅] [0L ₋₃₅₆] [0H ₋₃₅₆] [0L ₋₃₅₇] [0H ₋₃₅₇] [0L ₋₃₅₈] [0H ₋₃₅₈] [0L ₋₃₅₉] [0H ₋₃₅₉] [0L ₋₃₆₀] [0H ₋₃₆₀] [0L ₋₃₆₁] [0H ₋₃₆₁] [0L ₋₃₆₂] [0H ₋₃₆₂] [0L ₋₃₆₃] [0H ₋₃₆₃] [0L ₋₃₆₄] [0H ₋₃₆₄] [0L ₋₃₆₅		



This recycle mark indicates that the packaging conforms to the environmental protection legislation in Germany.

CASIO®

CASIO COMPUTER CO.,LTD.
6-2, Hon-machi 1-chome
Shibuya-ku, Tokyo 151-8543, Japan

MA0003-A  Printed in Malaysia
WK1800-E-1

Free Manuals Download Website

<http://myh66.com>

<http://usermanuals.us>

<http://www.somanuals.com>

<http://www.4manuals.cc>

<http://www.manual-lib.com>

<http://www.404manual.com>

<http://www.luxmanual.com>

<http://aubethermostatmanual.com>

Golf course search by state

<http://golfingnear.com>

Email search by domain

<http://emailbydomain.com>

Auto manuals search

<http://auto.somanuals.com>

TV manuals search

<http://tv.somanuals.com>