

Breverra

CONTOUR™/
CONTOUR SE
series



Instruction Manual



Para instrucciones en Español,
llamar al: 1-800-837-4044

www.centuryproducts.com

PM-1435AB

6/01

Download from Www.Somanuals.com. All Manuals Search And Download.

Avoid injury or death -
Read and understand this manual!

TABLE OF CONTENTS

This instruction manual is for:

- Breverra Contour Booster Car Seat
- Breverra Countour SE Booster Car Seat

Instructions for these models *are the same* unless otherwise noted.

Before You Begin

Important Information.....	1
Warnings.....	2
Basic Information.....	4

Use

Height and Weight Limits.....	5
Installation with harness system.....	6
Installation without harness system.....	7
Placing Child In Car Seat - with harness system.....	8
Placing Child In Car Seat - without harness system.....	10

Operations and Adjustments	12
• Harness Straps	
• Harness Tie	
• Buckle	
• Tether Strap	
• Changing Harness Strap Slots	
Harness System - removal and re-assembly.....	16

Special Information

Vehicle Seat Belts.....	18
• Locking Clip.....	25
Additional Information.....	26
• Installation of Anchor Hardware	
• Tether Storage	
• Care and Cleaning	
• Aircraft Use	
• Second Hand Car Seat	

IMPORTANT INFORMATION

No car seat can guarantee protection from injury in every situation, but proper use helps reduce the risk of serious injury or death.

Registration Information

Child restraints (car seats) could be recalled for safety reasons. You must register this restraint to be reached in a recall. Fill out the registration card attached to car seat and mail today or send your name, address, and the restraint's model number and manufacturing date to:

Century Products
P.O. Box 551
Elverson, PA 19520-9973
or call 1-888-224-6549

For recall information:

- Call the U.S Government's Auto Safety Hotline at 1-800-424-9393 (202-366-0123 in D.C. area)
- www.nhtsa.dot.gov
- Call Century Products at 1-800-837-4044

Safety First Check List

- ✓ Read and understand instruction manual and car seat labels.
- ✓ A vehicle combination lap/shoulder belt **MUST** be used when using car seat without harness system.
- ✓ Do not use vehicle "lap-only" belt across front of child.
- ✓ Secure children in back seat whenever possible.
- ✓ Never leave child unattended.
- ✓ Install car seat securely.
- ✓ Do not use after date shown on back of car seat.
- ✓ Do not allow anyone (babysitter, relatives, etc.) to use car seat without first understanding all instructions.

WARNINGS - Prevent serious injury or death:

Failure to follow these instructions and car seat labels can result in child striking the vehicle's interior during a sudden stop or accident. Secure child restraint with a vehicle seat belt as shown in this manual.

Not all vehicle seat belts can be used with car seat. Read "Vehicle Seat Belts" section:

- Car seat with harness system **MUST** be held securely at all times by a lap belt (or lap belt portion of a lap/shoulder belt) that will not change length while driving.
- Car seat without harness system **MUST** be used with a lap/shoulder belt.

Never use a vehicle "lap-only" belt across front of child.

Never put a car seat in a front vehicle seat unless recommended by vehicle owner's manual. National Highway Traffic Safety Administration (NHTSA) alerts vehicle owners that according to accident statistics, children up to age 12 are safer in the back seat. For vehicle's with air bags, refer to vehicle owner's manual for child restraint installation information.

If car seat is in a crash, it must be replaced. **DO NOT use it again!** A crash can cause unseen damage and using it again could result in serious injury or death.

WARNINGS - *Prevent serious injury or death* (continued):

DO NOT use car seat if it is damaged or has missing parts.

DO NOT use accessories or parts other than those provided by Century or Graco. Their use could alter the function of the car seat.

Never leave child unattended, even when sleeping.

BASIC INFORMATION

Certification

With Harness System:

Car seat meets or exceeds all applicable requirements of Federal Motor Vehicle Safety Standards for use in motor vehicles and aircraft.

Without Harness System:

Booster seat is certified for use in motor vehicles. Booster seat is **NOT** certified for use in aircraft.

Car Seat Useful Life

DO NOT use after date shown on back of car seat due to changing requirements and normal wear and tear.

Look for:

DO NOT USE
THIS CAR SEAT
AFTER DECEMBER

YEAR

Dangerous Vehicle Seats

Do not use car seat on rear-facing or side-facing vehicle seats.

Unoccupied Car Seat

Always secure car seat with a vehicle seat belt, even when unoccupied. An unsecured car seat can injure passengers.

Warm Weather

Car seat parts can get very hot in the sun or warm weather.

To avoid burns, always check before putting child in car seat.

Vehicle Seat Protection

Protect vehicle seat. Use a car seat mat, towel or thin blanket under and behind car seat.

HEIGHT and WEIGHT LIMITS

With Harness System

Child **MUST** meet all of the following requirements:

- Weight is 30 - 40 lbs. (13.6 - 18.1 kg).
- Height is 35 - 43 inches (89 - 109.2 cm) tall.
- Child is able to sit upright unassisted ★.
- Child's shoulders are **not** above top harness slots.

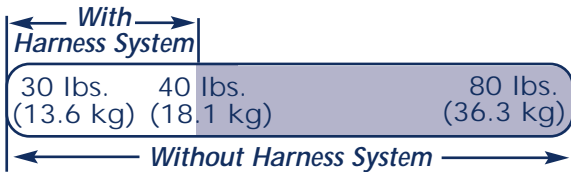

Without Harness System

Child **MUST** meet all of the following requirements:

- Weight is 30 - 80 lbs. (13.6 - 36.3 kg).
- Height is 35 - 50 inches (89 - 127 cm) tall.
- Child is able to sit upright unassisted ★.
- Top of child's ears are **not** above top of headrest.

★ The American Academy of Pediatrics recommends that children should be at least one year of age before being positioned forward facing.

Outgrowing Car Seat

⚠ WARNING

To avoid injuries from whiplash, top of child's ears must be below top edge of headrest.

INSTALLATION - *with harness system*

- 1 Place *forward-facing* on vehicle seat.
- 2 Lift seat pad flap, thread vehicle seat belt through openings and buckle belt (*fig. a*).
- 3 Press down firmly in center of car seat to compress vehicle seat cushion while tightening vehicle seat belt.

HINT: Use your knee to press down in center of car seat (*fig. b*).

- 4 Pull front to back and left to right to check for secure installation (*fig. c*). Vehicle lap belt **MUST** stay tight.

If not secure, see "Vehicle Seat Belts" section.

- 5 Attach tether hook (A) to anchor hardware (B) and tighten strap to remove any slack (*fig. d*).

If tether anchor hardware (B) is not available, see "Installation of Anchor Hardware" section.

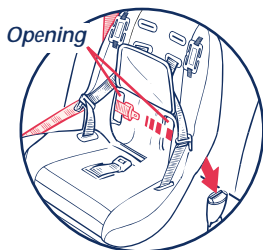

(*fig. a*)

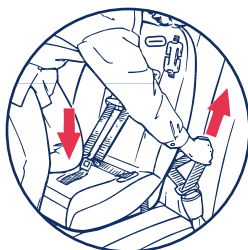

(*fig. b*)

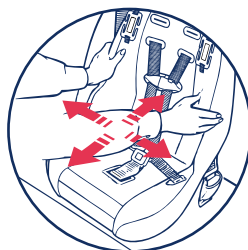

(*fig. c*)

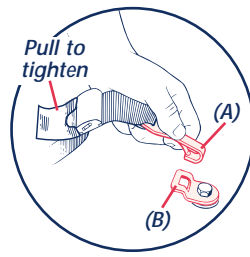

(*fig. d*)

INSTALLATION - *without harness system*

1 Place *forward-facing* on vehicle seating position with a vehicle lap/shoulder belt. See "Vehicle Seat Belts" section.

2 Tether may be used to stabilize booster seat:

Attach tether hook (A) to anchor hardware (B) and tighten strap to remove any slack (fig. a).

If tether anchor hardware (B) is not available, see "Installation of Anchor Hardware" section.

If not using tether, see "Tether Storage" section.

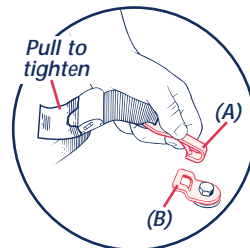

(fig. a)

PLACING CHILD IN CAR SEAT - *with harness system*

WARNING

To prevent serious injury or death:

- Vehicle seat belt must be routed through back of car seat when using harness system.
- Never place vehicle belt in front of child when using harness system.
- Do not use strap covers, blankets, cushions, or padding under harness straps or child unless provided by Century or Graco.
- Do not use harness straps that are loose or unbuckled. They must be snug and positioned over shoulders and thighs.

Adjust harness system:

Harness straps **must** be through slots **at** or just **above** shoulders.

- 1** Place child in car seat with child's back flat against back of car seat.
- 2** Place harness straps over child's shoulders and insert tongues into buckle.

Pull up on tongues to be sure they are locked.
- 3** Close harness tie:

Position harness tie at arm pit level.
- 4** Tighten harness straps so that they are snug with just enough room to insert one finger between child's chest and harness straps (*fig. a*).

Thigh straps must also be snug (*fig. b*).

PLACING CHILD IN CAR SEAT - *with harness system* (continued)

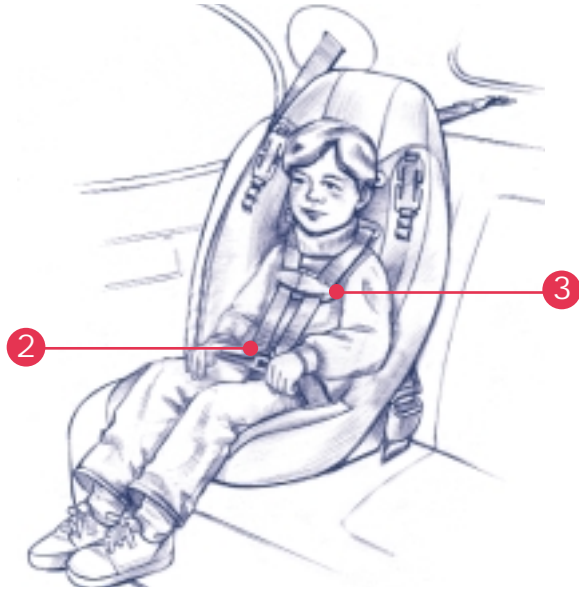

(fig. a)

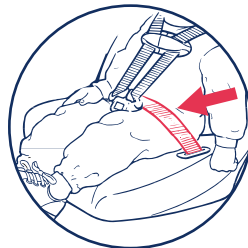

(fig. b)

PLACING CHILD IN CAR SEAT - *without harness system*

WARNING

To prevent serious injury or death:

- Shoulder belt **MUST** be properly positioned over shoulder (NOT touching child's neck and NOT low off shoulder).
- Lap/shoulder belt **MUST** be properly positioned exactly as shown in illustration.
- DO NOT use shoulder belt loose or positioned under child's arms (*fig. a*).
- Never use a vehicle "lap-only" belt across front of child.
- DO NOT allow child to slide down in car seat which could position lap belt across child's abdomen and shoulder belt over neck or face.
- If child will not keep vehicle shoulder belt properly positioned, DO NOT use this booster car seat. Use a different child restraint system.
- Vehicle belts **MUST** lay flat against child and **MUST** not be twisted.

Remove harness system (see "Harness System - removal and re-assembly" section).

- 1 Place child in car seat with child's back flat against back of car seat.
- 2 Place shoulder belt across child's chest.
- 3 Buckle belt and pull shoulder belt to adjust lap belt snugly.

Shoulder belt **MUST** lay across child's shoulder in red zone as shown (*fig. b*). If outside of red zone, see next steps for Comfort Clip use.

CAUTION:

Some shoulder belts with (emergency locking) retractors allow a child to pull belt out and change position of belt. Use of Comfort Clip helps prevent child from pulling belt out.

- 4 Thread shoulder belt through Comfort Clip **exactly** as shown and hook end of Comfort Clip through desired loop of webbing (*fig. c*).
- 5 Check to be sure shoulder belt is properly positioned over shoulder in red zone and snug against child.

PLACING CHILD IN CAR SEAT - *without harness system* (continued)

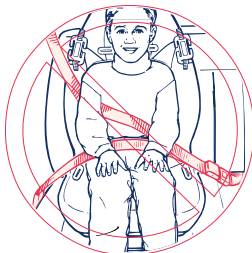

(fig. a)



(fig. b)

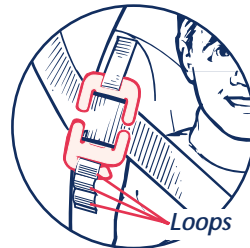

(fig. c)

OPERATIONS and ADJUSTMENTS

1

Harness Tie:

- To open: Press tab and pull apart (*fig. a*).
- To close: Snap halves together. Make sure harness tie is locked by pulling out on each half.

2

Buckle:

- To lock: Insert both tongues into buckle. Pull up on tongues to be sure they are locked.
- To unlock: Press red button and pull tongues out of buckle.

3

Tether Strap (*fig. b*):

- To tighten: Pull loose end of strap.
- To loosen: Lift adjuster.

OPERATIONS and ADJUSTMENTS (continued)

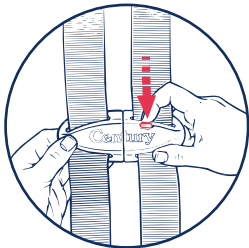
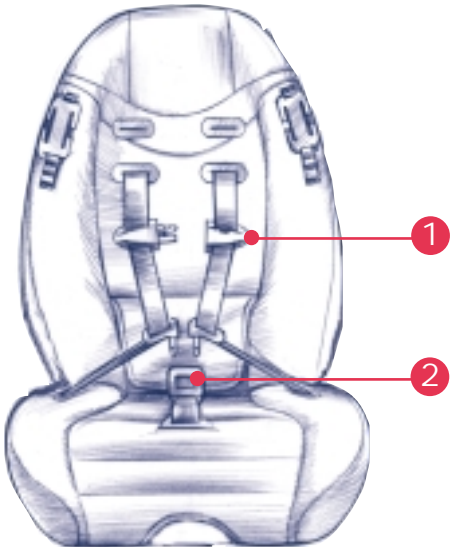

(fig. a)

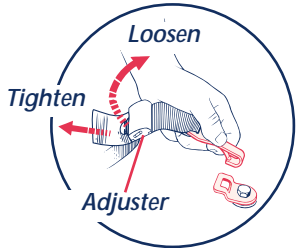

(fig. b)

OPERATIONS and ADJUSTMENTS (continued)

4 *Harness Straps (fig. c):*

A To loosen: Lift adjuster bar and pull harness straps from front of car seat to desired length.

or

To tighten: Lift adjuster bar and pull ends of harness straps down until all slack is removed.

B Pull harness straps on front side to lock adjuster bar.

C When adjusting harness straps, pull harness straps through tongues in buckle to remove all slack.

5 *Changing Harness Strap Slots:*

MUST use slots *at* or just *above* shoulders.

A Lift adjuster bar and pull harness straps out of current slots.

B Change harness strap slots.

Make sure harness straps are threaded through matching slot of seat pad and car seat.

It may be necessary to remove seat pad from top of car seat.

C Thread harness straps behind opening in metal plate and adjuster bar (*fig. d*).

D Lift adjuster bar and thread straps over adjuster bar, creating loop, and down behind metal plate (*fig. e*).

E Pull ends of harness straps down (*fig. f*).

F Adjust harness straps to fit child (see 4).

NOTE: Make sure straps are **NOT** twisted.

WARNING

To prevent serious injury or death:

End of each strap must be at least 2 inches (5 cm) below metal plate (*fig. f*).

OPERATIONS and ADJUSTMENTS (continued)

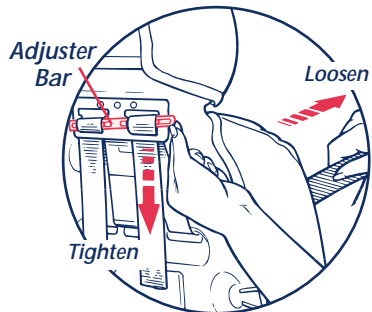

(fig. c)

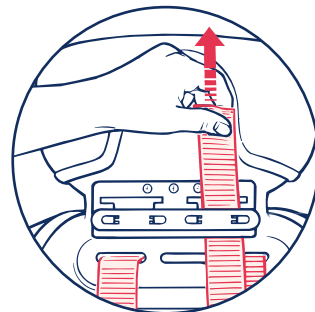

(fig. d)

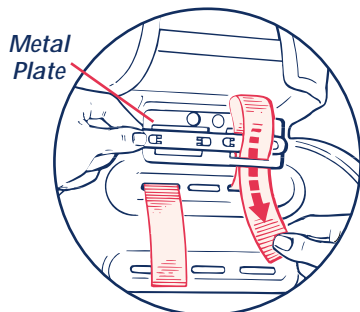

(fig. e)

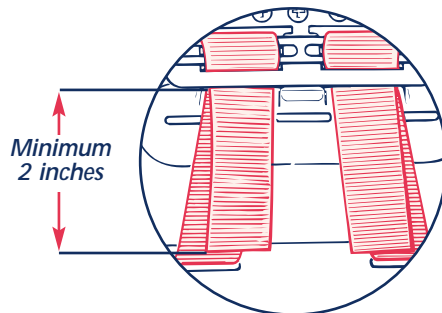

(fig. f)

HARNESS SYSTEM - *removal and re-assembly*

Removal:

- Lift adjuster bar and pull both harness straps out of current slots.
- Pull harness strap out of car seat, harness tie, and tongues.

Store all parts for future use.

- Push buckle and crotch strap down into crotch strap opening.

Re-assembly:

When re-assembling harness system, be sure harness straps are not twisted.

- 1 Thread end of harness strap down through slot in seat pad, under both clips on bottom and back up through slot in opposite side of car seat pad.
- 2 Thread ends through tongues or shields (available on some models).
- 3 Thread ends through harness tie.
- 4 Thread ends through desired slots and adjuster following instructions in "Operations and Adjustments" section.
- 5 Pull buckle out of of buckle slot.

HARNESS SYSTEM - *removal and re-assembly* (continued)

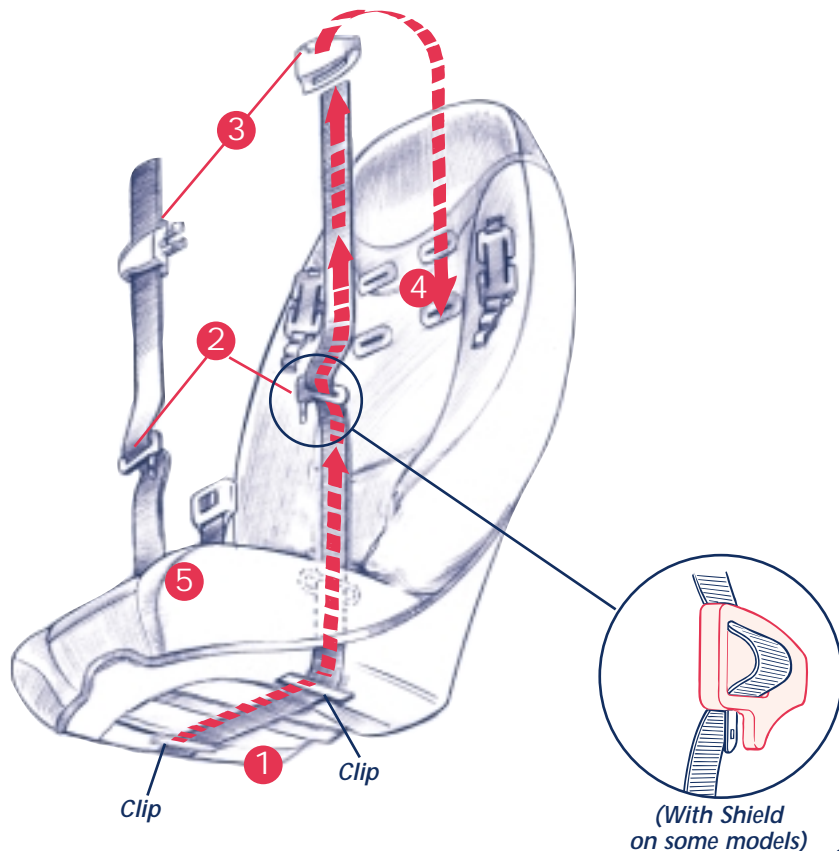

VEHICLE SEAT BELTS

WARNING

Not all vehicle seat belts can be used with a car seat:

- Car seat with harness system **MUST** be held securely at all times by a lap belt (or lap belt portion of a lap/shoulder belt) that will not change length while driving.
- Car seat without harness system **MUST** be used with a lap/shoulder belt.

If car seat with harness system is not held securely after following instructions in this manual, vehicle seat belt labels, and vehicle owner's manual:

- Move car seat to another seating location and try again, or
- Contact vehicle dealer for possible seat belt modification parts.

To provide the best installation of the car seat:

- Read the vehicle owner's manual regarding car seat installation and seat belt use with car seat.
- Follow all instruction labels on vehicle seat belt and car seat.

VEHICLE SEAT BELTS (continued)

✿ Lap Belts - Manually Adjustable

With Harness System:

The locking latch plate on some seat belts may slip and loosen after being buckled on car seat if positioned at a certain angle. If this happens, flip latch plate over (*fig. a*) and re-buckle. Test installation again to see if this works. If not, move car seat to another seating position.

Without Harness System:

DO NOT use this type of vehicle seat belt to secure child and booster car seat.

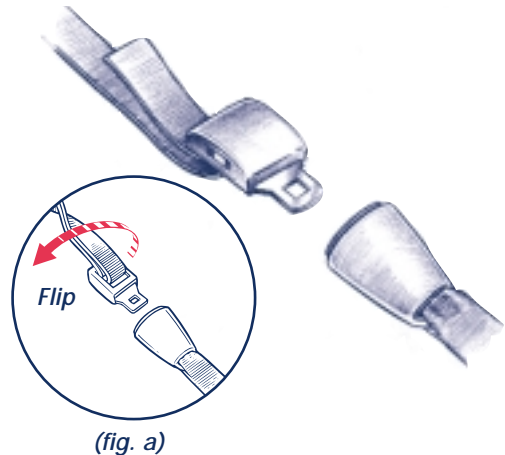

VEHICLE SEAT BELTS (continued)

✿ Lap Belts - With Retractor

With Harness System:

Lap belts with retractors may or may not hold a car seat securely.

Follow these steps to determine if you have a retractor system that will hold car seat securely:

- Pull belt all the way out.
- Allow belt to retract about 6 inches (15 cm).
- Pull out on belt again.

If belt is locked and you **cannot** pull the belt out any further, you have an Automatic Locking Retractor which may be used with a car seat. Remember, when installing a car seat, pull belt all the way out, buckle belt, and then tighten.

If you **can** pull the belt out again (step c), you have an Emergency Locking Retractor which **must not** be used with a car seat.

Without Harness System:

DO NOT use this type of vehicle seat belt to secure child and booster car seat.

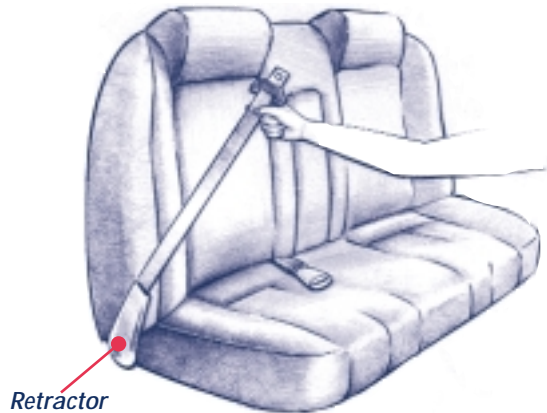

VEHICLE SEAT BELTS (continued)

✿ Passive Restraint - Lap Belt with Motorized Shoulder Belt

With or Without Harness System:

DO NOT use with any car seat.

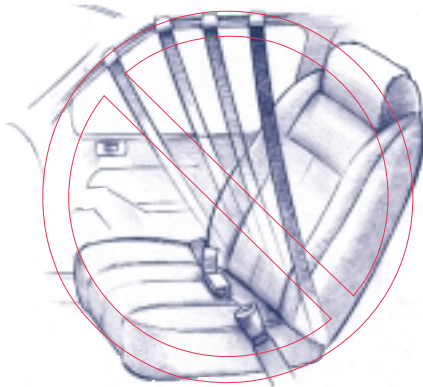

✿ Passive Restraint - Lap or Shoulder Belt Mounted on Door

With or Without Harness System:

DO NOT use with any car seat. Belts will not stay tight while driving.

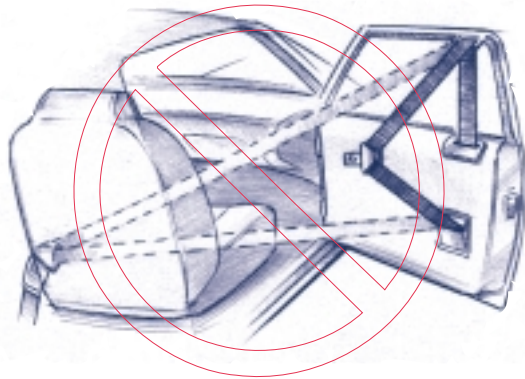

VEHICLE SEAT BELTS (continued)

Belts Forward of Seat Crease

With Harness System:

Vehicle seat belts located forward of seat crease may not securely hold car seat. Check vehicle owner's manual or see vehicle dealer for car seat installation requirements.

If approved for use with car seat by vehicle manufacturer, install car seat and check for secure installation by pulling car seat front to back. If car seat slides forward, DO NOT use these seat belts.

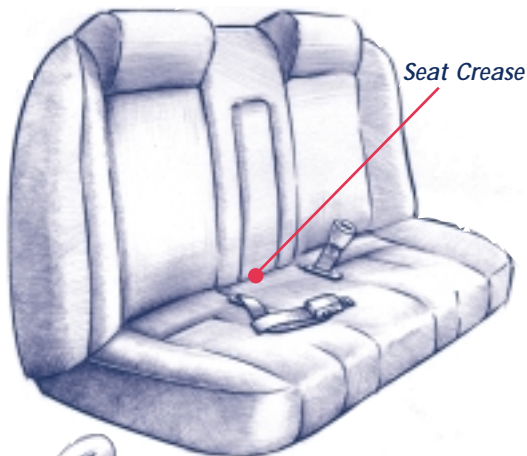

Without Harness System:

Lap/shoulder belts forward of the seat crease are **OK** to use. Follow vehicle owner's manual for specific instructions on how to use vehicle seat belts.

DO NOT use lap only belts.

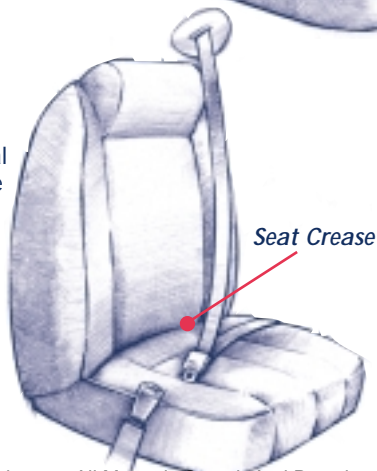

VEHICLE SEAT BELTS (continued)

✿ Combination Lap/Shoulder Belt with Locking Latch Plate

With Harness System:

OK to use. Follow vehicle owner's manual for specific instructions on how to use vehicle seat belts.

The locking latch plate on some seat belts may slip and loosen after being buckled on car seat if positioned at a certain angle. If this happens, flip the latch plate over (**fig. b**) and re-buckle. Test installation again to see if this works. If not, move car seat to another seating position.

Without Harness System:

OK to use. Follow vehicle owner's manual for specific instructions on how to use vehicle seat belts.

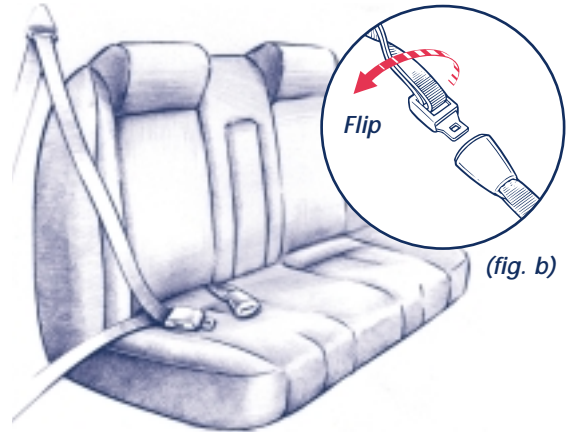

VEHICLE SEAT BELTS (continued)

✿ Combination Lap/Shoulder Belt with Sliding Latch Plate

With Harness System:

Pull on latch plate (*fig. a*). If belt slides freely through latch plate, a locking clip **MUST** be used. (See "Locking Clip" section.)

Without Harness System:

This vehicle seat belt system is **OK** to use with booster car seat.

Movement of the seat belt through the latch plate can allow an active toddler to slide down in car seat and re-position lap belt over abdomen and shoulder belt over neck or face which is dangerous.

A Locking Clip may be used on this type of vehicle seat belt to prevent movement of seat belt through latch plate limiting toddler's movement:

- 1 Install car seat and adjust lap/shoulder belt snugly around child.
- 2 Hold seat belts together at latch plate (*fig. b - page 25*) then unbuckle.
- 3 Slide locking clip on seat belts approximately 1/2 inch (1 cm) away from latch plate (see illustration page 25).
- 4 Re-buckle seat belt.

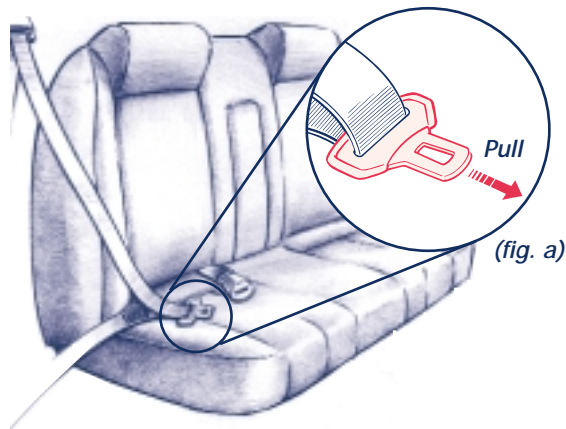

VEHICLE SEAT BELTS (continued)

Locking Clip

⚠ WARNING

Avoid serious injury or death:

- Failure to use locking clip where required will result in car seat not being securely held in place.
- Remove locking clip from seat belts when not being used with car seat.
- DO NOT use locking clip as a vehicle seat belt shortener.

When using car seat with harness system, you **MUST** use locking clip provided with car seat with a vehicle seat belt that slides freely through the latch plate or the lap belt cannot be tightly secured.

- 1 Install car seat and tighten vehicle seat belt.
- 2 Hold seat belts together at latch plate (*fig. b*) then unbuckle.
- 3 Slide locking clip on seat belts approximately 1/2 inch (1 cm) away from latch plate.
- 4 Re-buckle seat belt.

- 5 Test installation to see if car seat is secure.

If not secure, additional belt tightening may be required:

- Unbuckle vehicle seat belt.
- Hold belts together and remove locking clip.
- Shorten length of lap belt portion slightly by pulling belt through latch plate.
- Re-attach locking clip.
- Buckle vehicle seat belt.

HINT: Press car seat further down into vehicle seat cushion to help buckle vehicle seat belt.

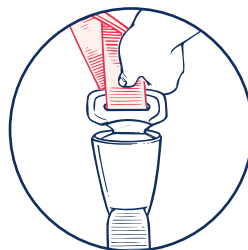

(*fig. b*)

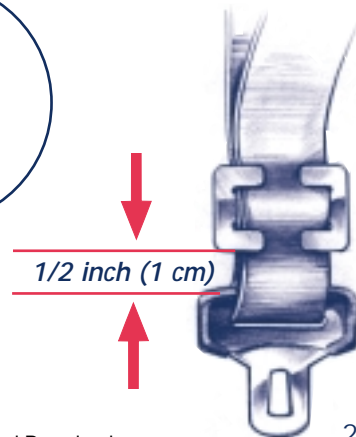

ADDITIONAL INFORMATION

Installation of Anchor Hardware

Vehicle may already be equipped with a tether anchor (top strap anchor). See vehicle owner's manual for location.

If vehicle does not have a tether anchor, one must be installed:

- Contact vehicle dealership for proper anchor location and installation.
- Before installing anchor, install car seat with harness system on a vehicle seat and check that the lap belt portion of the vehicle belt will hold car seat securely. If not, move car seat to another seating position.

If tether anchor hardware kit is not available at your vehicle dealership, one may be purchased at a local retailer or call Century at 1-800-837-4044.

WARNING

Avoid serious injury or death:

- Be sure anchor hole is properly sealed to prevent exhaust fumes and water from entering the vehicle.
- If you wish to remove anchor once child outgrows car seat, make sure hole is properly plugged or sealed to prevent exhaust fumes from entering the vehicle.

ADDITIONAL INFORMATION (continued)

Tether Storage

For storage of tether hook if not used with a belt position booster:

- Adjust tether strap length so hook end is as *short* as possible.
- Roll loose end of strap up.
- Place rolled up strap on top of adjuster and place rubber band around bundle.

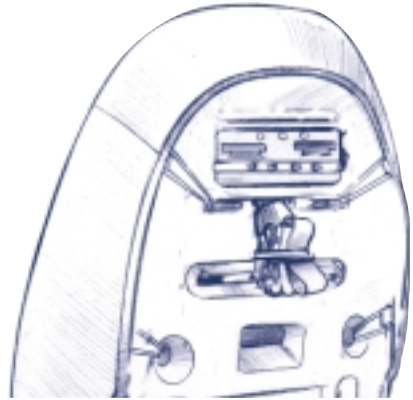

ADDITIONAL INFORMATION (continued)

Care & Cleaning

Removing Seat Pads:

If using harness system, remove harness system (see "Harness System - removing and re-assembly" section).

- 1 Turn car seat upside down:

Using a screwdriver, pry metal rod loose from car seat shell and slide elastic off.

CAUTION: Be careful not to damage webbing with screwdriver.

- 2 Turn car seat upright:

Unhook elastic from "J" hooks and pull seat pad off.

Reverse above steps for replacing seat pad, and harness system.

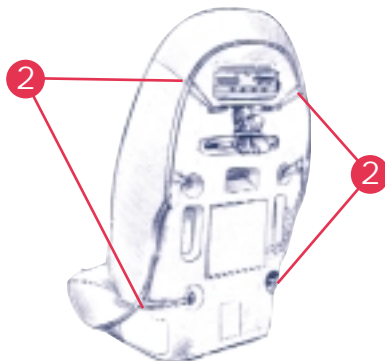
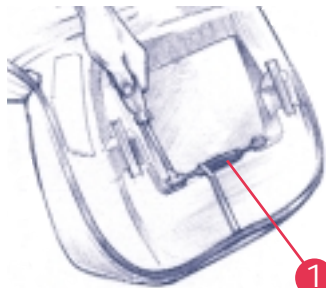

ADDITIONAL INFORMATION (continued)

Seat Pad:

Machine-wash separately on gentle cycle and drip dry.

Harness Straps:

Surface wash only with mild soap and damp cloth.

If harness straps are frayed or heavily soiled, they **MUST** be replaced.

Shell:

Wipe with mild solution of soap and water. Avoid wetting labels.

Never use “household detergents”: they can weaken plastic.

Buckle:

Rinse buckle with warm water. **DO NOT** use household detergents. Never lubricate buckle.

Aircraft Use

With Harness System:

This car seat is certified for use on aircraft when used **with** harness system (see label on car seat). Contact airline about their policy.

Use this car seat only on forward-facing aircraft seats.

Install car seat on an aircraft the **same way** it is installed in a vehicle except **DO NOT** use tether strap.

Without Harness System:

When used **without** harness system as a belt positioning booster seat, this restraint is **not** certified for use in aircraft because there is no shoulder belt available.

Second Hand Car Seat

Century advises against loaning or passing along car seat.

WARNING

Prevent serious injury or death:

- Buckle must be properly latched.
- Periodically inspect and clean buckle to remove objects or debris that could prevent latching.



If a part is damaged,
missing, or you need help
or replacement parts,
DO NOT return car seat
to the store.

CALL US FIRST

Call toll-free 1-800-837-4044
from anywhere in the U.S. or Canada
or fax at 1-610-286-4555.

or write us at:

Century Products
P.O. Box 100
Elverson, PA 19520-9974

Attention: Customer Service
Department



1 Fold instruction manual.



2 Store in pocket.

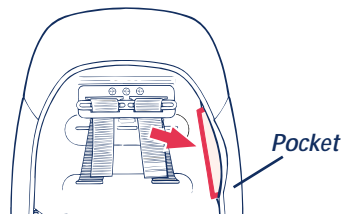

Century Products
Graco Children's Products Inc.
A Division of Newell Rubbermaid

Free Manuals Download Website

<http://myh66.com>

<http://usermanuals.us>

<http://www.somanuals.com>

<http://www.4manuals.cc>

<http://www.manual-lib.com>

<http://www.404manual.com>

<http://www.luxmanual.com>

<http://aubethermostatmanual.com>

Golf course search by state

<http://golfingnear.com>

Email search by domain

<http://emailbydomain.com>

Auto manuals search

<http://auto.somanuals.com>

TV manuals search

<http://tv.somanuals.com>