

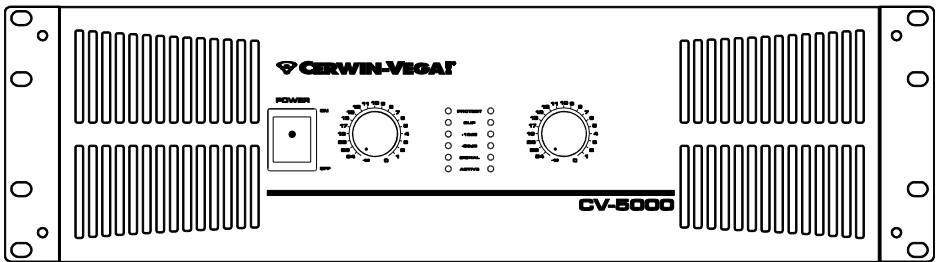

CV-5000

HEAVY DUTY PROFESSIONAL AMPLIFIER



USER MANUAL

IMPORTANT SAFETY INSTRUCTIONS

WARNING

1. Read these instructions - All the safety and operating instructions should be read before this product is operated.
2. Retain these instructions - The safety and operating instructions should be retained for future reference.
3. Heed all warnings - All warnings on the unit and in the operating instructions should be adhered to.
4. Follow all instructions - All operating and use instructions should be followed.
5. Do not use this unit near water - The appliance should not be used near water or moisture - for example, in a wet basement or near a swimming pool, and similar environments
6. Clean only with dry cloth.
7. Do not block any ventilation openings. Install in accordance with the manufacturer's instructions.
8. Do not install near any heat sources such as radiators, stoves, or other unit (including amplifiers) that produce heat.
9. Do not defeat the safety purpose of the polarized or grounding plug. A polarized plug has two blades with one wider than the other. A grounding plug has two blades and a third grounding prong. The wide blade or the third prong is provided for your safety. If the provided plug does not fit into your outlet, consult an electrician for replacement of the obsolete outlet.
10. Protect the power cord from being walked on or pinched particularly at the plugs, convenience receptacles, and at the point where they exit from the unit.
11. Only use attachments/accessories specified by the manufacturer.
12. Use only with the cart, stand, tripod, bracket, or table specified by the manufacturer, or sold with the unit. When a cart or rack is used, use caution when moving to avoid damage.
13. Unplug the unit during lightning storms or when unused for long periods of time.
14. Refer all servicing to qualified personnel. Servicing is required when the unit has been damaged in any way, such as power supply cord or plug is damaged, liquid has been spilled or objects have fallen into the unit has been exposed to rain or moisture, does not operate normally, or has been dropped.
15. Please keep the unit in a good ventilation environment.
16. **WARNING** To reduce the risk of fire or electric shock do not expose this unit to rain or moisture. The unit shall not be exposed to dripping or splashing and that no objects filled with liquids, such as vases, shall not be placed on this.



17. **WARNING** The mains plug or unit inlet is used as disconnect device; the disconnect device shall remain readily operable.
18. Power Sources - This product should be operated only from the type of power source indicated on the rating label. If you are not sure of the type of power supply to your home, consult your product dealer or local power provider. For products intended to operate from battery power, or other sources, refer the specific operating instructions.
19. Safety Check - Upon completion of any service or repairs to this product, ask the service technician to perform safety checks to determine that the product is in proper operating condition.
20. Don't touch conductive parts of output terminals to prevent hazardous electrical shock. The external wiring connected to the terminals requires installation by an instructed person or the used of ready - made leads or cords.
21. This equipment is for commercial & professional use only.
22. This product is in compliance with EU WEEE regulations. Disposal of end of life product should not be treated as municipal waste. Please refer to your local regulations for instructions on proper disposal of this product.
23. To prevent hazardous electrical shock, do not touch the conductive parts of the output terminals. The external wiring connected to the terminals requires installation by a qualified technician or the use of pre-fabricated leads or cords.
24. The unit shall not be exposed to dripping or splashing and that no objects filled with liquids, such as vases, shall be placed on the unit.
25. Main plug is used as disconnect device and it should remain readily operable during intended use. In order to disconnect the unit from the mains completely, the mains plug should be disconnected from the mains socket outlet completely. La prise du secteur ne doit pas être obstruée ou doit être facilement accessible pendant son utilisation. Pour être complètement déconnectée de l'alimentation d'entrée, la prise doit être débranchée du secteur.



Protective Grounding Terminal. The apparatus should be connected to a mains socket outlet with a protective grounding connection.



This lightning flash is intended to alert the user to the presence of non-insulated "dangerous voltage" on the output terminals that may be of sufficient magnitude to constitute a risk of electric shock. The external wiring connected to the terminals requires installation by a qualified engineer.



CAUTION
RISK OF ELECTRIC SHOCK
DO NOT OPEN



CAUTION: To reduce the risk of electric shock, do not remove any cover. No user-serviceable parts inside. Refer servicing to qualified service personnel only.



The lightning flash with arrowhead symbol within the equilateral triangle is intended to alert the user to the presence of uninsulated "dangerous voltage" within the product's enclosure that may be of sufficient magnitude to constitute a risk of electric shock.



The exclamation point within the equilateral triangle is intended to alert the user to the presence of important operation and maintenance (servicing) instructions in the literature accompanying this appliance.

CAUTION: To prevent electric shock, do not use this polarized plug with an extension cord, receptacle or other outlet unless the blades can be fully inserted to prevent blade exposure.

TABLE OF CONTENTS

Introduction	4
Features	5
Front Panel Controls	6
Rear Panel Controls	8
Protection	10
Setup	11
Connections	13
Wiring.....	15
Specifications.....	17

INTRODUCTION

Thank you for your decision to purchase Cerwin-Vega's innovative new CV Series professional power amplifier! Engineered for superior sound reproduction, the CV Series line of professional amplifiers deliver top quality audio at an affordable price. The CV Series offers a standard of reliability and efficiency that makes them the perfect solution for every DJ, musician, and sound engineer. Welcome to a new level of professional quality sound performance!

UNPACKING AND INSTALLATION

Although it is neither complicated to install nor difficult to operate your amplifier, a few minutes of your time is required to read this manual for a properly wired installation and to become familiar with the amp's features and how to use them. Please take care in unpacking your amp and do not discard the carton and other packing materials. They may be needed when moving your amp, and are required if it ever becomes necessary to return the unit for service. Never place the unit near a radiator, in front of heating vents, in direct sun light, in excessive humidity, or dusty locations to avoid damage to the amp and to guaranty it lives a long and reliable life. Connect your amp according to the description on the following pages.

FEATURES

The CV-5000 amplifier delivers the following power ratings.

2 x 1100 Watts at 8 ohm, 2 x 1800 Watts at 4 ohms and 2 x 2500 Watts at 2 ohms

2-channel, parallel or bridged mono operating modes for flexible application - 5000 Watts

...and the following features.

- Independent limiters for each channel reduce distortion.
- Independent input level controls for each channel allow precision adjustments.
- Precise signal and clip LED indicators to monitor performance, allow you to correct for overloading (clipping) condition.
- Low-frequency filters (30Hz or 50Hz) remove rumble and subsonic frequency.
- Twin-tunnel and two temperature-sensitivity forced-air cooling system to maintain a low, temperature working condition.
- Balanced XLR or balanced 1/4-inch TRS Combination input connector for each channel and LINK ports.
- 5-way output binding posts or Speaker connectors enable secure operation.
- High-current toroidal transformer for absolute reliability.
- Independent DC and thermal overload protection on each channel automatically protects amplifier and speaker.
- The CV-5000 can be mounted in any standard 19" rack.

FRONT PANEL CONTROLS

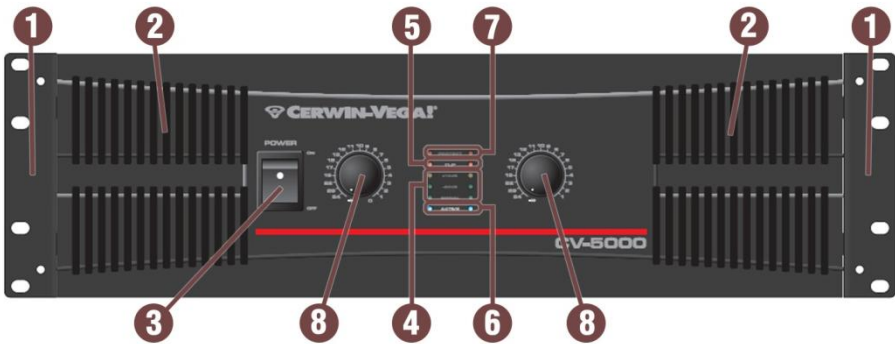

1. Rack Mounting Ears

Two front panel mounting holes are provided on each mounting ear.

2. Fan Vent

CV-5000 amplifier is cooled by two rear-mounted fans. Cool air flows through the front fan filters, reducing the temperature of the inside components while forcing the heat out the rear vents. Never block these vents and keep them clean at all time.

3. AC Power Switch

This switch controls the unit's main power.

4. Signal Indicators

These green and yellow LED will illuminate to indicate that a signal is present at the amplifier input, and that the signal is being amplified.

5. Clip Indicators

These red LED will illuminate at the clipping threshold. If it lights frequently, you could be overloading the amplifier and a distorted signal is possibly being output. Under heavy clipping activity, lower the channel gain controls to reduce the risk of damage to your speakers and amplifier.

6. Active Indicators

These blue LEDs indicate that AC power is connected and the amplifier is turned on.

7. Protect Indicators

These red LED indicate that the channel is in Protect mode. When the channel goes into protect mode all output for that channel will turn off by output relay. The protect LED will light when overheating or other severe problems occur. This is to protect any speakers connected to the channel. These LEDs light for approximately five seconds whenever the amplifier is powered on, and fade slowly when the amplifier is powered off. This is normal operation.

8. Channel input level control

These two 21-position controls adjust input level for their respective amplifier channels. In Bridged Mono Mode, only channel 1 input level control is used to adjust signal level. In Parallel Mode, both input level control are used to adjust signal level for their respective amplifier channels. At their fully counter-clockwise position, the signal is attenuated by more than 80dB. At their fully clockwise position, the signal is at unity gain. When 0 dBu of signal arrives at the input jacks and the Channel input level controls are set to their fully clockwise position, the amplifier delivers full power output.

REAR PANEL CONTROLS

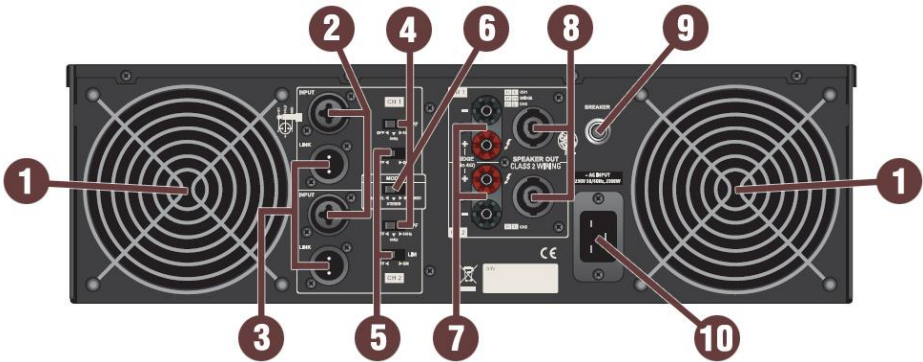

1. Fan

This is a variable speed cooling fan. Cool air enters the amplifier through the fan ports located on the front of the amplifier chassis, be sure not to block these ports when installing the amplifier or other associated equipment.

2. Input connectors

Connect the input source to these electronic balanced Combination connectors using either XLR or 1/4" TRS plugs. The 1/4" TRS and XLR plug configured as follows: Pin 2 (Tip) hot, Pin 3 (Ring) cold, and Pin 1 (Sleeve) ground. We recommend the use of balanced three-conductor cabling wherever possible. Unbalanced two-conductor 1/4" plugs can also be inserted into these inputs, but you will get better signal quality and less outside noise and hum if you use balanced lines. Stereo signal should be connected to both the Channel 1 and Channel 2 input jacks. When operating the CV-5000 in Bridged Mono or Parallel modes, use the Channel 1 input jack only.

3. Link connectors

These jacks are used to send a parallel signal form the channel Link jacks to another device or amplifier.

4. High Pass Filter (HPF) switch.

These slide switches are used to activate the built-in High Pass Filter.

The HPF rolls off signals below 30Hz or 50Hz. This improves bass performance by limiting sub-audio cone motion, making more power available for the speaker's rated frequency range. When the filter is turn off, a 5 Hz roll off protects against DC or deep sub-audio inputs.

5. Limiter switch

When the input signal connected to your amplifier is too high, you can end up with a distorted output signal. To prevent this, both channels of your CV-5000 feature a clip limiter that can be engaged or disengaged selectively.

6. Bridge / Stereo / Parallel switch

This switch changes the amplifier operating mode from either stereo or mono, and bridged or parallel. You can place this switch in "STEREO" position (center) for normal stereo operation. When placed in "PARALLEL" position, the channel 1 input signal is routed to the power amplifier of both channel. When placed "BRIDGED" position, the channel 1 input signal is routed to both amplifiers again. In Parallel and Bridged mode, the channel 2 input is ignored.

7. 5-way Binding Post

Connect each channel of the CV-5000 to 4 ohms or 8 ohms loudspeakers. Two pairs of 5-way binding posts are provided for each channel, so that paralleling of speakers is possible. Connection to the binding posts can be made with bare wire, banana plugs, or spade lug terminations. Make connections to both the Channel 1 and Channel 2 terminals for Stereo or Parallel Mode, or a single connection across the red terminals only of Channel 1 and Channel 2 for Bridged Mono Mode.

8. Speakon output connectors

You can use these to connect each channel of the CV-5000 to 4 ohms or 8 ohms loudspeakers. Using Speakon speaker cables, make connections to both the channel 1 and channel 2 connectors for Stereo or Parallel Mode, or to the Bridged mode connector for Bridged Mono Mode.

9. Circuit breaker

The circuit breaker replaces common disposable fuses. This circuit breaker will trip if there is a fault with the main voltage or if maximum output is exceeded. Simply depress the circuit breaker and power up the unit again.

10. AC input

This is an IEC connector for your included AC power cable.

PROTECTION

The CV-5000 incorporates protection features. The front panel Protection LED indicates the activity of the relay speaker connection circuitry in each channel. When the Protection LED turn on, this circuitry is active and all connected speakers are muted.

Initial Power Up - For approximately five seconds after initial power-up, the protection circuitry is activated and the speaker outputs are muted. If everything is operating normally, you will hear an audible click at the conclusion of this brief period, as the protection circuitry is deactivated and the amplifier begins delivering signal to connected speakers. It is normal for the Protection LED to fade gradually after the amplifier is powered off.

Thermal Protection - Abnormally high heat sink temperatures will engage the Protection circuitry for the overheating channel only. An output relay disconnects the speakers until normal temperature range is restored. During this time, the Protect LED will light. To guard against this problem, make sure the CV-5000 receives adequate ventilation on all sides and that both the front and rear panels are unobstructed. If the power transformer gets too hot, its thermal switch will disconnect all of the secondary power and disconnect both channel outputs.

Short Circuit - If output is shorted due to faulty wiring, the thermal circuitry will automatically protect the amplifier. If this occurs, the load will be disconnected by the thermal protection circuitry (also, the output relay opens).

DC Voltage Protection - If an amplifier channel detects DC voltage at the speaker output, the output relay immediately opens to prevent speaker damage.

Subsonic Frequency Protection - Built-in High Pass Filter provides subsonic frequency protection for each channel.

Current Limiting Protection - At the amplifier's full power limit, (or clipping point) the limiter circuitry will be activated. This is indicated by illumination of the Clip LED. The channel gain is automatically reduced, protecting the speakers from damage. This circuitry may be activated by uncontrolled feedback, oscillations, or improper equipment gain settings. This circuitry is virtually transparent in operation, and full signal bandwidth is maintained.

Any time the Protection LED lights up (except for approximately 5 seconds during initial power-up), there is reason to be concerned. If this occurs, turn the amplifier off immediately and check carefully all wiring and external equipments in order to locate and correct the condition.

SETUP

Clip Limiter



Clipping is the result of an amplifier running into a power supply limitation. The maximum output voltage that any amplifier can produce is limited by its power supply. Attempting to output a voltage (or current) level that exceeds the power supply results in a “flattenin” effect on the signal, making it’s waveform look cut off or “clipped”. A clipped waveform exhibits extreme harmonic distortion, dominated by large amplitude odd-ordered harmonics and making it sound harsh or dissonant.

The clip limiter detects this and reduces the gain to minimize the amount of overdrive. To preserve as much of the program dynamics as possible, limiting reduces the average program level until peaks barely clip. Each channel has its own clip limiter, and you can switch it on or off.

When driving full-range speakers, clip limiting reduces high frequency distortion caused by bass overload. It also protects higher frequency drivers from excess overdrive and harsh clipping harmonics.

HPF (Hi-Pass Filter)



A filter having a passband extending from some finite cutoff frequency (not zero) up to infinite frequency. Also known as a low-cut filter. HPF rolls off signals below 30Hz or 50Hz, removing the frequencies below the selected roll off. Reproduction of the signal’s bass portion is thus optimized, since ultra-low, distracting frequencies are eliminated, and more power is available for the reproduction of the wanted segment of the signal.

You should set up the filters so they best suit the frequency response of your speakers, since some speakers are particularly sensitive to over-exursion. The 50Hz filter works well with most compact full-range speakers.

Mode Select

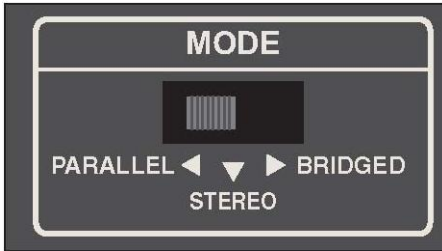

Stereo Mode

In stereo mode, both channels operate independently, with their input gain controls. Signal at channel 1's input produces output at channel 1, while signal at channel 2's input produces output at channel 2's output. Recommended minimum nominal load impedance for stereo operation is 2 ohms per channel.

Parallel Mode

When set to Parallel mode, a signal applied to channel 1's input will be amplified and appear at outputs for both channel 1 & 2. With set to parallel. The parallel mode is well-suited for applications in which driving two speakers with the same signal but with separate amplification.

Bridged Mono Mode

Bridged mono mode straps both amplifier channels together to make a very powerful, single-channel monaural amplifier. One channel "pushes" and the other channel "pulls" equally, doubling the power over that of either channel alone. Therefore the voltage is doubled, the peak power is quadrupled, and program power is roughly three times as high as that of the individual channel.

Signal is applied to the channel 1 input only and channel 1 input gain control is used to adjust signal level. The input gain control belonging to channel 2 are not used.

Note : Bridged mono mode is to be used only when the CV-5000 is connected to a 4 or 8 ohms speaker load. Use of Bridged mode with speaker loads of 4 ohms or less can result in severe damage to the unit due to excessive heat and current limiting.

Use extreme caution when operating the amplifier in Bridged Mono Mode. Never ground either side of the speaker cable when the amplifier is in Bridged Mono Mode ; the speaker load must "float" away from the amplifier chassis.

CONNECTIONS

Stereo Mode

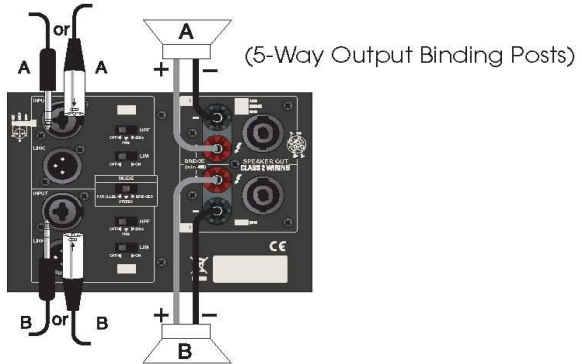

Parallel Mode

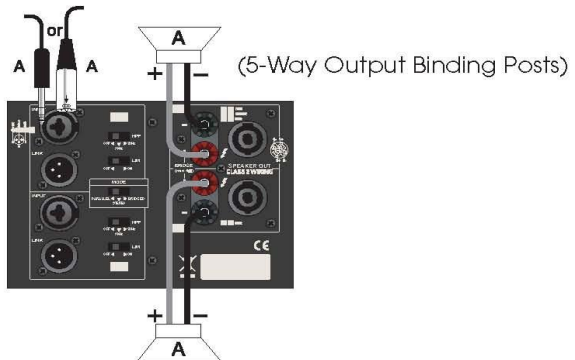

Bridged Mono Mode

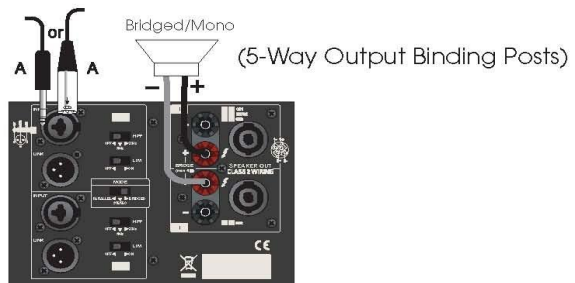

Stereo Mode

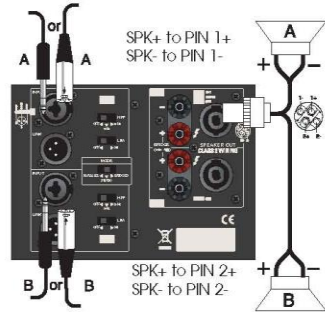
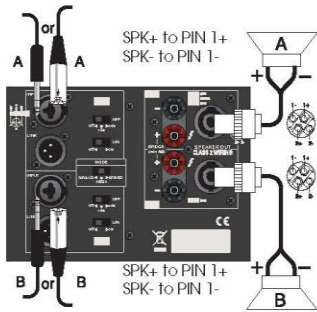

Parallel Mode

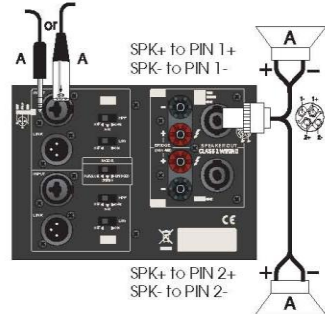
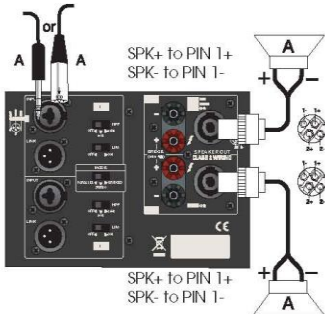

Bridged Mono Mode

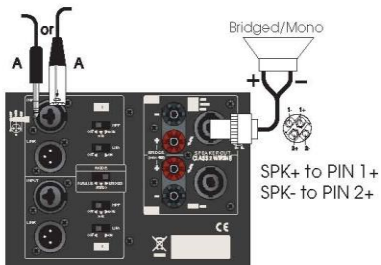

WIRING

These are several ways to interface the CV-5000 to support a variety of applications. The CV-5000 features balanced inputs and outputs, so connecting balanced and unbalanced signals is possible.

BALANCED TRS 1/4" CONNECTOR

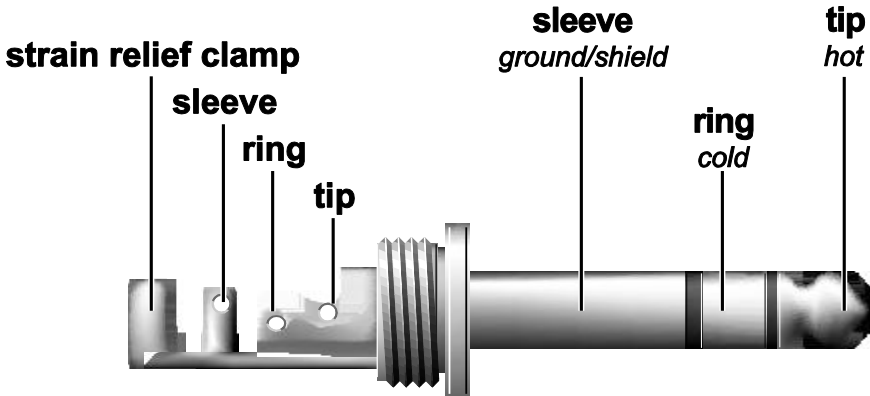

For connection of balanced and unbalanced plugs, ring and sleeve have to be bridged at the stereo plug.

UNBALANCED TRS 1/4" CONNECTOR

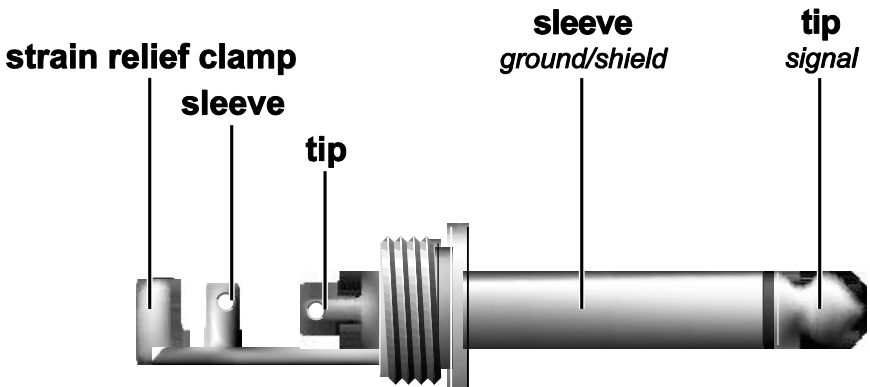

XLR BALANCED WIRING GUIDE

input



- 1 = ground/shield
- 2 = hot (+ve)
- 3 = cold (-ve)

output

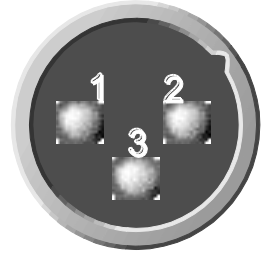

For unbalanced use pin 1 and pin 3 have to be bridged

SPEAKON® OUTPUT CONNECTOR

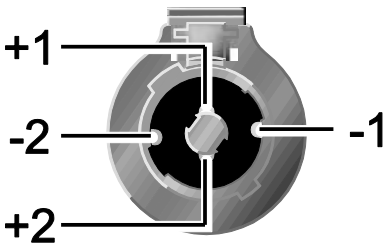
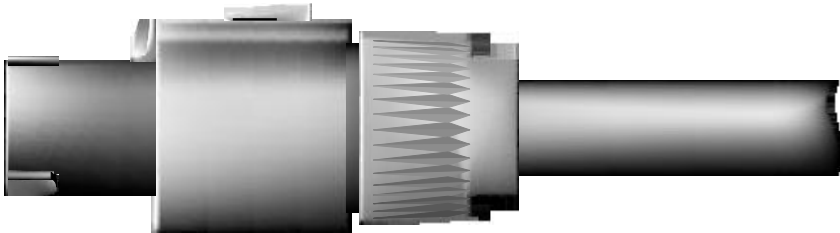

front view

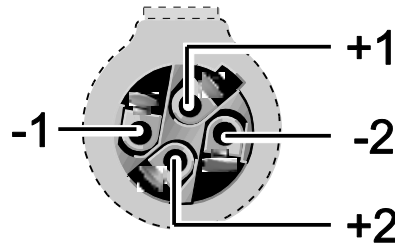

rear view

SPECIFICATIONS

OdB=0.775V OdBV=1V

Rated Output Power	Stereo
8 ohms	1100W
4 ohms	1800W
2 ohms	2500W
Rated Output Power	Bridged Mono
8 ohms	3600W
4 ohms	5000W
Signal to Noise Ratio (20 Hz ~ 20k Hz)	<-100dB
Distortion (SMPTE-IM)	< 0.02%
Input sensitivity @8 ohms	1.42V (+5.3dB)
Voltage Gain	36dB
Output Circuitry	Class-H, 3 tier
Current Consumption	120Vac / 240Vac
@ 1/8 power @4 ohms	13.9A / 6.5A
@ 1/3 power @4 ohms	26.9A / 10.5A
@ Rated power @4 ohms	56.4A / 26A
Distortion (20 Hz-20k Hz Half Power) (1k Hz Rated Power)	< 0.03% / 4Ω and 8Ω < 0.03% / 4Ω and 8Ω
Frequency Response	5Hz to 50kHz to -3dB
Damping Factor (400 Hz)	>300 at 8Ω
Input Impedance	10Kohm Unbalanced 20Kohm Balanced
Input Clipping	+14dB
Cooling	Continuously variable speed fan, Front to rear airflow

Connectors (each)

Input	Active balanced combo (XLR and 1/4" TRS common use) XLR male Link
Output	5-way Binding post and Speakon

Control

Front AC power switch, Channel 1 and 2 volume

Rear HPF switch, Limiter switch,
Mode selector switch

Indicators Active(blue), Protection(red), Clip(red),
Signal (green & yellow)

Protection Short circuit, Thermal, Current limit,
DC offset, Current inrush, RF protection,
Turn on / Turn off muting

Power requirements 100, 120/240Vac, 50/60Hz

Dimensions (W × H × D) 19"(482mm) x 5.25"(132mm) x 19"(482mm)

Net Weight 83.3lb
(37.2kg)

Specifications are subject to change without notice.



USA: The Stanton Group • 772 S. Military Trail • Deerfield Beach, FL • 33442
Phone: 1-954-949-9600 • Fax: 1-954-949-9590 • Email: info@Cerwin-Vega.com
Europe: Stanton Europe • 382 Avenue de la Couronne, 1050 Brussels, Belgium
Phone: +32 2 645 05 00 • Fax: +32 2 645 05 05 • Email: eurooffice@stantoneurope.com
Cerwin-Vega! is a division of the Stanton Group

Cerwin-Vega! reserves the right to make changes to product specifications and design at any time
© Copyright 2010 Cerwin-Vega!

Free Manuals Download Website

<http://myh66.com>

<http://usermanuals.us>

<http://www.somanuals.com>

<http://www.4manuals.cc>

<http://www.manual-lib.com>

<http://www.404manual.com>

<http://www.luxmanual.com>

<http://aubethermostatmanual.com>

Golf course search by state

<http://golfingnear.com>

Email search by domain

<http://emailbydomain.com>

Auto manuals search

<http://auto.somanuals.com>

TV manuals search

<http://tv.somanuals.com>