

DXG-587V HD

User's Manual

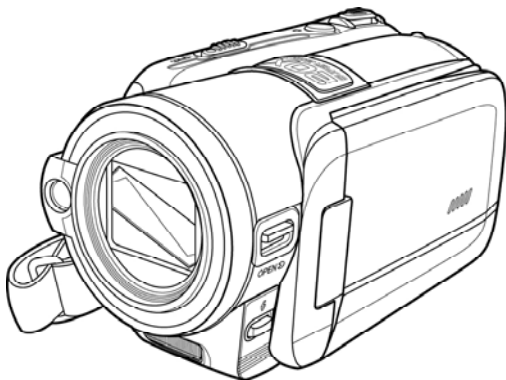

DXG USA

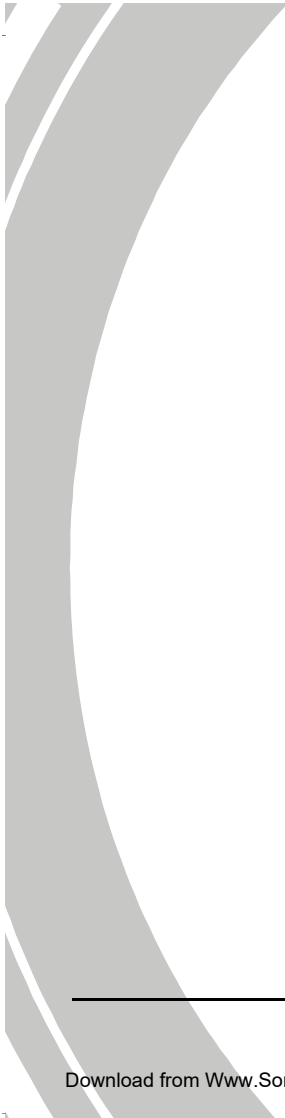

Table of Contents

<i>About this manual</i>	<i>v</i>
<i>Copyright</i>	<i>v</i>
<i>Precautions</i>	<i>vi</i>
<i>Before You Start</i>	<i>viii</i>
1 Introduction	1
<i>1.1 System requirements</i>	<i>1</i>
<i>1.2 Features</i>	<i>1</i>
<i>1.3 Unpacking the camcorder</i>	<i>2</i>
<i>1.4 About the camcorder</i>	<i>3</i>
1.4.1 Front view	3
1.4.2 Top view	3
1.4.3 Bottom view	4
1.4.4 Right view.....	4
1.4.5 Left view	5
1.4.6 Back view	5
1.4.7 Adjusting the LCD display.....	6
1.4.8 About the LEDs.....	10
2 Getting started	11
<i>2.1 Inserting an SD card</i>	<i>11</i>
<i>2.2 Inserting the battery</i>	<i>13</i>
<i>2.3 Charging the battery</i>	<i>15</i>
<i>2.4 Turning on/ off the camcorder</i>	<i>15</i>
<i>2.5 Changing modes</i>	<i>16</i>

2.6	<i>Before you start</i>	16
2.6.1	Setting the date and time	16
2.6.2	Setting the language	17
2.6.3	Setting the beep	18
2.7	<i>Shoot/Playback video</i>	19
2.7.1	Shooting a video clip	19
2.7.2	Playing the video clip	21
2.8	<i>Taking/viewing pictures</i>	22
2.8.1	Taking a still picture	22
2.8.2	Viewing images.....	23
2.9	<i>Connecting to a computer</i>	24
2.10	<i>Connecting to a standard TV</i>	24
2.11	<i>Connecting to an HDTV</i>	25
3	Using the camcorder	26
3.1	<i>Camcorder and voice recorder mode</i>	26
3.1.1	Camcorder and voice recorder mode....	26
3.1.2	Using the macro function	28
3.1.3	Using the AF Lock	28
3.1.4	Using the Manual Focus	28
3.1.5	Using the zoom function.....	30
3.1.6	Using the LED light	30
3.1.7	Using the Flash module	30
3.1.8	Using the Stabilizer function.....	30
3.1.9	Quick access controls	30
3.2	<i>Camera mode</i>	31

3.2.1	Camera mode icons	31
3.2.2	Using the macro function	32
3.2.3	Using the AF Lock	32
3.2.4	Using the Manual Focus	32
3.2.5	Using the zoom function.....	32
3.2.6	Using the LED light module.....	32
3.2.7	Using the flash module	32
3.2.8	Using the Stabilizer function.....	33
3.2.9	Quick access controls	33
3.3	<i>Camcorder Playback mode.....</i>	34
3.3.1	Camcorder Playback mode icons	34
3.4	<i>Camera Playback mode.....</i>	37
3.4.1	Camera Playback mode icons	37
3.5	<i>Thumbnail mode</i>	38
4	Using the menus	39
4.1	<i>Camcorder menu.....</i>	39
4.1.1.	White balance.....	39
4.1.2.	Video resolution.....	40
4.1.3.	Quality.....	41
4.1.4.	Color effect	42
4.1.5.	Night mode.....	43
4.1.6.	Stabilizer	44
4.1.7.	Capture mode.....	45
4.2	<i>Camcorder playback menu</i>	46
4.2.1	Delete.....	46

4.2.2	Protect	48
4.2.3	Autoplay	49
4.3	Camera menu	50
4.3.1	White balance	50
4.3.2	Resolution	51
4.3.3	Color effect	52
4.3.4	Night mode.....	53
4.3.5	Self timer	54
4.4	Camera playback menu.....	55
4.4.1	Delete.....	55
4.4.2	Protect	57
4.4.3	Autoplay	58
4.4.4	DPOF	59
4.5	System menu.....	60
4.5.1	Setting the beep.....	60
4.5.2	Auto power off.....	60
4.5.3	TV standard	61
4.5.4	Format	62
4.5.5	Default.....	63
4.5.6	Language	63
4.5.7	Frequency	64
4.5.8	Date/time	64
	Appendix	65
	Specifications.....	65
	Troubleshooting.....	68

Preface

Congratulations on your purchase of this advanced camcorder. Make sure that you read this manual carefully and keep it in a safe place for future reference.

About this manual

Every effort has been made to ensure that the contents of this manual are correct and up to date. However, no guarantee is made regarding the accuracy of the contents. If the contents of this manual do not tally with the camera, please take the camera as a criterion. We reserve the right to change the contents of this manual and specifications of the product without prior notice.

If the accessories do not tally with the actual package, please take the actual package as the criterion.

Copyright

© Copyright 2010.

All rights reserved. No part of this publication may be reproduced, transmitted, transcribed, stored in a retrieval system or translated into any language or computer language, in any form or by any means, electronic, mechanical, magnetic, optical, manual or otherwise, without the prior written permission from the manufacturer.

Precautions

General precautions

- Do not use or store the product in dusty, dirty, or sandy areas, as its components may be damaged.
- Do not store the product in a hot environment. High temperatures can shorten the life of electronic devices, damage batteries and warp or melt certain plastics.
- Do not store the product in cold areas. When the product warms up to its normal temperature, moisture can form inside; this may damage the electronic circuits.
- Do not attempt to open the casing or attempt your own repairs. High-voltage internal components create the risk of electric shock when exposed.
- Do not drop or knock the product. Rough handling may damage the internal components.
- Do not use harsh chemicals, cleaning solvents or strong detergents to clean the product. Wipe the product with a slightly damp soft cloth.
- Do not fire the flash while it is too close to the subject's eyes. Intense light from the flash can cause eye damage if it is fired too close to the eyes. When using the flash, the camera should be at least one meter from the eyes of the subject.
- Do not open the battery cover while an image is being recorded. Doing so will not only make storage of the current image impossible, it can also corrupt other image data already stored in file.
- If the product or any of its accessories are not working properly, take them to your nearest qualified service center. The personnel there will assist you and if necessary, arrange for the product to be repaired.
- Test for proper operation before using the camera.

Notes on the LCD Screen

Caution must be observed when dealing with the fluid contained in the LCD. Ensure that fluid does not leak if the screen becomes cracked or damaged. If this occurs, follow these steps:

- If the fluid makes contact with skin, wipe it with a clean cloth then rinse with a large amount of water.
- If the fluid makes contact with eyes, wash eyes with clean water for at least 15 minutes and seek immediate medical attention.
- If the fluid is swallowed, first rinse mouth with water, then drink a large amount of water and induce vomiting. Seek immediately medical attention.

Operation conditions

- This camera is designed for use in temperatures ranging from 0°C to 40°C (32°F to 104°F).
- Do not use or keep the camera in the following areas:
 - In areas subject to direct sunlight
 - In areas subject to high humidity or dust
 - Near air conditioners, heaters, or other areas subject to temperature extremes
 - Inside of a closed vehicle, especially one parked in the sun.
 - In areas subject to strong vibration

Power supply

- Use only the type of battery that came with your camera. Using any other type of battery may damage the equipment and invalidate the warranty.
- Ensure the battery is inserted correctly. Inserting the battery incorrectly can cause damage to the product and possibly start a fire.

- Remove the battery to avoid the fluid leakage if the camera is not going to be used for a long time.
- If the battery is crushed or damaged, remove it immediately to avoid the battery fluid leakage and abnormal expansion.

Before You Start

Take some test shots before performing a formal recording.

Before taking pictures with this DV camera in any important occasion (such as a wedding ceremony or an overseas trip), test the DV camera beforehand to ensure that it functions properly. Any additional loss caused by the malfunction of this product (such as costs of photography or any loss of benefit generated by the photography) is not the responsibility of the manufacturer and no compensation will be given for it.

Copyright information

Observe "No Photography" notices in certain locations. In these cases, you cannot record any live performance, improvisation or exhibits, even for personal purposes. Any transfer of pictures or memory card data must be conducted under the constraints of copyright law.

1 Introduction

Read this section to learn about the features and functions of the camcorder. This chapter also covers system requirements, package contents, and descriptions of the hardware components.

1.1 System requirements

The camcorder requires a PC with the following specifications:

- Operating System : Windows XP SP2 32/64bit, Vista 32/64bit and Windows7 32/64bit
- CPU: Intel/AMD Dual-Core or above
- Memory: At least 1GB or above
- Graphic Card: DirectX 9 is must, DirectX 10 is recommendation
- Interface: Standard USB 1.1 Port or Higher
- Hard Disk: At least 2GB of Available Disk Space

1.2 Features

The camcorder offers a variety of features and functions including:

- HD Digital camcorder
- Digital camera - (max. 12 Megapixels)
- Voice recorder
- USB mass storage
- 5x optical zoom, 4x digital (1080P: NO Digital Zoom)
- SD card reader

1.3 Unpacking the camcorder

The following items should be present in the package. If any item is missing or appears damaged, contact your dealer immediately.



Camcorder

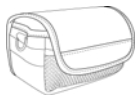

Pouch



User manual



HDMI cable



USB cable



AV cable



Battery charger



Power cord

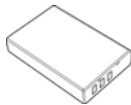

**Li-ion battery
NP-120**



**CD-ROM
(Application software)**

1.4 About the camcorder

Refer to the following illustrations to familiarize yourself with the buttons and controls of this camcorder.

1.4.1 Front view

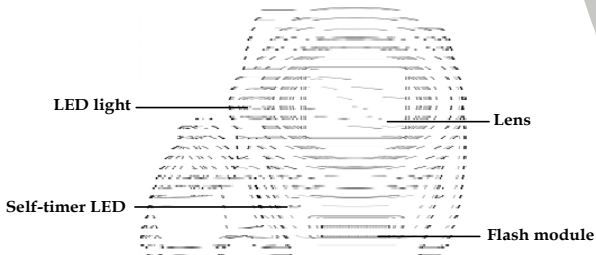

1.4.2 Top view

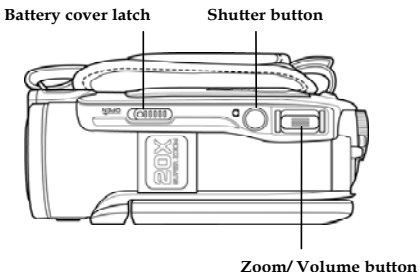

1.4.3 Bottom view

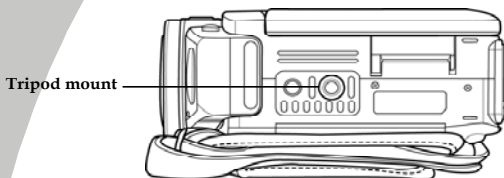

1.4.4 Right view

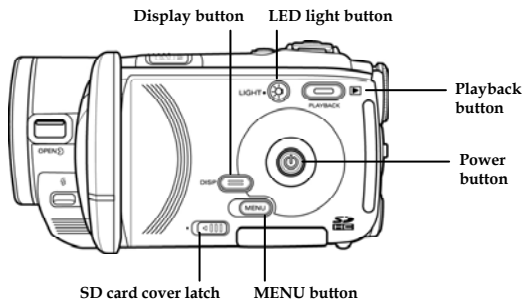
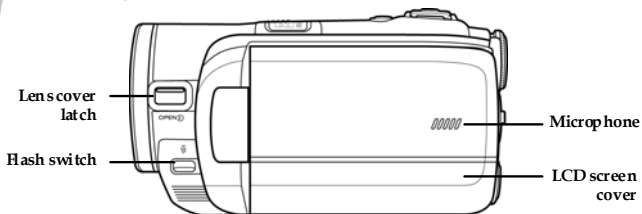

1.4.5 Left view

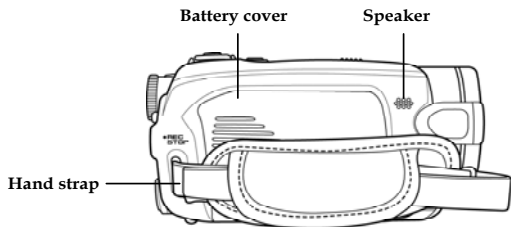

1.4.6 Back view

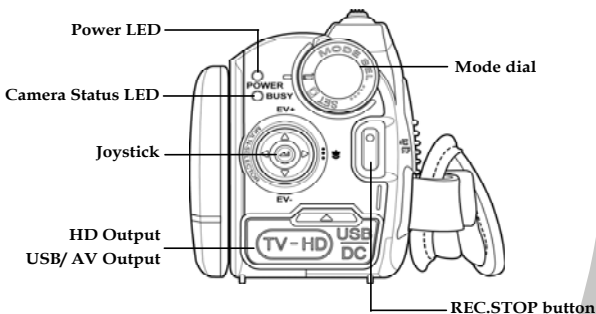



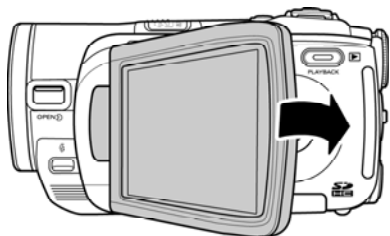
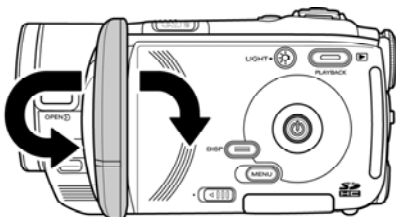
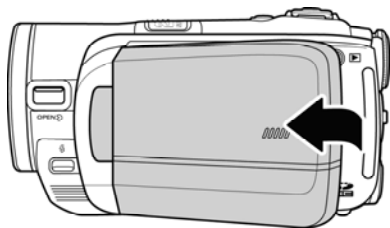

1.4.7 Adjusting the LCD display

Flip and twist the LCD screen as shown while capturing a still image or recording a video clip.



See the table below for a description of each button's function.

Button	Name	Function
	Power button	Press and hold to turn power on/off.
	Menu button	Press to display main OSD menus.
	Mode dial	Use to turn Camcorder , Camera , and SET modes. In Camcorder mode, press the REC.STOP button to start and stop recording. In Camcorder Playback mode, press the REC.STOP to pause/restart playing.
	Joystick	<ul style="list-style-type: none"> ● In Camcorder and Camera mode: <ol style="list-style-type: none"> 1. Move up/ down to adjust the exposure settings. 2. Press the joystick inwards to enable AF Lock. The AF Lock icon appears on the screen. 3. Press the joystick right repeatedly to switch to the MF mode. The MF icon appears on the screen when in MF mode. 4. Move right to enable the macro function. A  icon appears on the LCD screen when enabled. 5. Move left to adjust the white





balance settings.



● In **Camera Playback** mode:

1. Move right and left to view the stored images.
2. When the image is zoomed in, the LCD screen shows up/down/left/right direction keys. You may press the joystick to move the image.
3. Move Joystick button up to show all stored files in a 3x2 matrix thumbnail view.
4. In the **Thumbnail** mode, move up, down, left, right to select the thumbnail images and then press the center joystick button to view the image in full screen mode.

● In **Camcorder Playback** mode:

1. Press right and left to view the stored video clips and press the center joystick button to play/stop the video clips.
2. In **Playing** mode, move right to fast-forward a video clip and move left to rewind a video clip.
3. Move joystick button up to show all stored files in a 3x2 matrix thumbnail view.
4. In the **Thumbnail** mode, move up, down, left, right to select a

		<p>desired video clip and then press the center joystick button to show the video clip.</p> <ul style="list-style-type: none"> ● In SET mode, press up and down to highlight menu items and press the center joystick button to confirm.
	Shutter button	<ul style="list-style-type: none"> ● In Camera mode, press to take a photo. ● In Camcorder mode, you can also press to take a photo before recording a video clip.
	Playback button	In Camcorder and Camera mode, press to enter playback mode.
	Display button	Press once to turn off all OSD icons and press again to display all OSD icons off.
	Zoom button	<ul style="list-style-type: none"> ● In Camcorder and Camera modes, press right/ left to zoom in and out. ● In Camera Playback mode: In a 3x2 matrix thumbnail view, move zoom button to right to exit the view. ● In Camcorder Playback mode: <ol style="list-style-type: none"> 1. Press left/ right to increase or decrease the volume of the

		<p>video clip.</p> <p>2. In a 3x2 matrix thumbnail view, move zoom button to right to exit the view.</p>
	LED light button	<ul style="list-style-type: none"> ● In Camcorder and Camera modes, press the button to turn on/ off the increase light.
	SD card cover latch	<ul style="list-style-type: none"> ● Slide the latch to open the SD card cover when you insert the SD card.

1.4.8 About the LEDs

The following table describes the camera LEDs:

LED	Color	Definition
Power / Busy	Green	Power-on
	Red Blinking	Recording
Camera Status	Red	Camera busy
	Red Blinking	Self-timer is activated and flash in charge.
	Red Blinking Rapidly	2 seconds self-timer remaining.
Self-timer	Red Blinking	Self-timer is activated.
	Red Blinking Rapidly	2 seconds self-timer remaining.

2 Getting started

Read this section to learn how to start using the camcorder. This section covers basic functions such as switching on, inserting the battery and memory cards, and configuring preliminary settings. See later chapters for advanced functions.

2.1 Inserting an SD card

An SD card can be installed in the camcorder to provide additional storage space for still images, video clips, or other files.

1. Open the LCD screen cover and move the SD card cover latch in the direction of the arrow to open the SD card compartment cover.

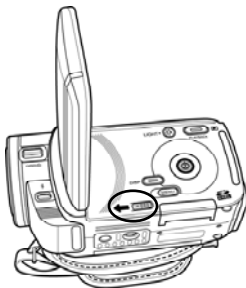

2. Insert an SD card, making sure the contacts are facing upwards.

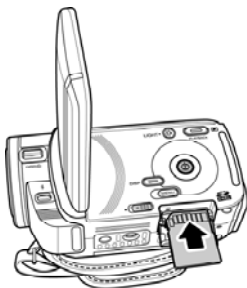

3. Close the SD card compartment cover.

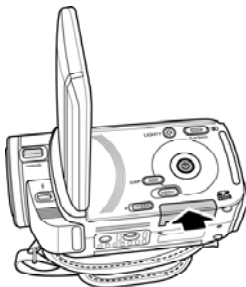
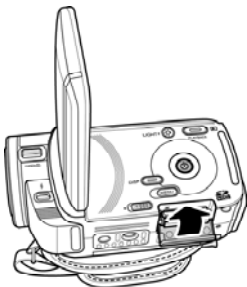

2.2 Inserting the battery

This camcorder is designed to use a rechargeable Li-ion battery. Only use the batteries supplied or similar batteries recommended by the manufacturer or your dealer.

● **Note:**

Install the battery exactly as described here. Installing the battery incorrectly could cause damage to the camcorder and possibly start a fire.

1. Slide the battery cover latch as shown and then the battery cover opens automatically.



2. Insert the battery as shown.



3. Close the battery cover as shown.

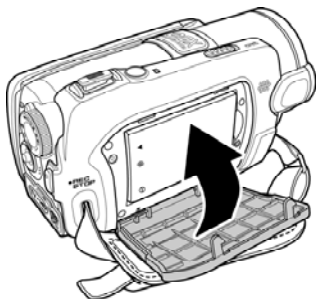

2.3 Charging the battery

You can charge the battery with the charging unit provided. Follow the below steps to charge your battery.

1. Insert the Li-ion battery into the charging bay. Connect one end of the power cord to the charging unit and then plug the other end to the wall outlet as shown.
2. The orange LED will light up for proper charging.
3. After full charge, the LED turns to green.
4. It takes about 290 minutes to achieve full charge. Actual charging time depends on current battery capacity and charging conditions.

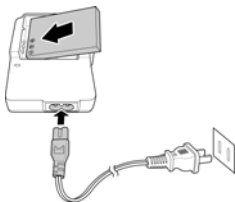

2.4 Turning on/ off the camcorder

Press and hold the power button to turn the camcorder on/off.

Notes:

Closing and opening the LCD screen can power on/off the camera.

2.5 Changing modes

The camcorder can operate in three modes, **Camcorder**, **Camera**, and **SET**. Move the mode dial to toggle different modes.

2.6 Before you start

Before you start using the camcorder, some basic settings such as date and time, languages and beep function need to be configured.

2.6.1 Setting the date and time

1. Turn on the camcorder, and move the mode dial to **SET**. Move the joystick up and down to highlight **Date / Time**. Press the center joystick button to confirm.

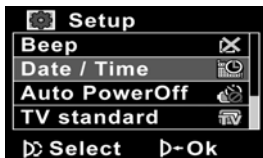

2. Move the joystick up and down to highlight each field and press the center joystick button to select a field.

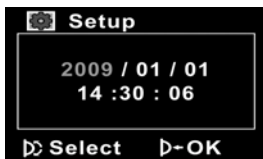

3. Adjust each value by moving the joystick up, down, left, or right. Press the center joystick button to save your changes.

2.6.2 Setting the language

1. Turn on the camcorder, and move the mode dial to **SET**. Move the joystick up and down to highlight **Language**. Press the center joystick button to select it.

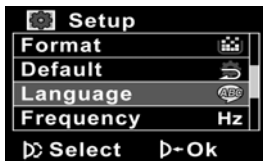

2. Move the joystick left and right to select the following languages: **English, Traditional Chinese, Simplified Chinese, German, Italian, Spanish, French, Turkish, Portuguese, Dutch, Japanese, Russian, Korean, and Arabic**. After the language is selected, press the center joystick button to confirm.

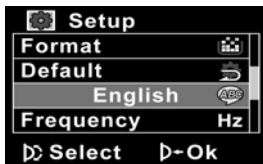

2.6.3 Setting the beep

1. Turn on the camcorder, and move the mode dial to **SET**. Move the joystick up and down to highlight **Beep**. Press the center joystick button to select it.

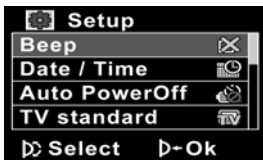

2. Move the joystick left and right to select X (Beep Off) or ✓ (Beep On) and press the center joystick button to confirm.

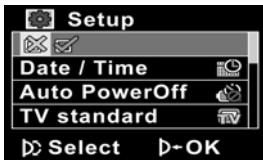

2.7 Shoot/Playback video

2.7.1 Shooting a video clip

1. Turn on the camcorder and move the mode dial to **Camcorder** mode.







2. Use the LCD screen to frame the video.
3. Press the **REC.STOP** button to start recording.
4. Press the **REC.STOP** button again to stop recording.
5. The video clip is automatically saved with a unique file name.

Notes:

1. The maximum length of each video recording file is approximately 3.66 GB.
2. The high-resolution settings result in larger files, and therefore shorter length.

3. The LCD preview and the ratio of a still-image capture can vary depending on the different video resolution settings. See the following table:

Video resolution	Preview	Taking pictures and focusing
WVGA	16:9 ratio	4:3 ratio
720P		
1080P	4:3 ratio	4:3 ratio
QVGA		

4. Before shooting a video clip, you can still take a photo in **Camcorder** mode.

2.7.2 Playing the video clip

1. In **Camcorder** mode, press the **Playback** button. The last played clip displays on the LCD screen.

Camcorder playback
mode indicator



2. Move the joystick right and left to select a desired video clip and press the center joystick button. The video clip starts playing.
3. Move the joystick left to rewind the video clip and move the joystick right to fast forward.
4. Press the **REC. STOP** button to pause the video playback. Press the center joystick button to resume the video playback.
5. When viewing the video clip, move the **Zoom** button left or right to adjust the volume.
6. Press the center joystick button to stop playing.
7. Press the **Playback** button again to return to **Camcorder** mode.

2.8 Taking/viewing pictures

2.8.1 Taking a still picture

1. Turn on the camcorder and move the **Mode Dial** to **Camera** mode.

Camera mode



2. Use the LCD screen to frame the picture.
3. Press the **Shutter** button to capture the image.
4. The picture is automatically saved with a unique file name.

2.8.2 Viewing images

1. In **Camera** mode, press the **Playback** button. The most recent image displays on the LCD screen.



2. Press the joystick right and left to scroll through the images.
3. Move the **Zoom** button right to zoom in the picture. There are two direction keys appears on the LCD screen. You may press the center joystick button to switch between the panning directions (up/down ↔ left/right).
4. Move Joystick button up fully to view the thumbnails of all stored images and then press the joystick up/down and left/right.
5. Press the center joystick button to view the image in full screen mode.
6. Press the **Playback** button again to return to **Camera** mode.

2.9 Connecting to a computer

Read this section to learn how to transfer files to a PC, show the video clips or photos on a TV.

Connect the camcorder to a computer with the USB cable provided.

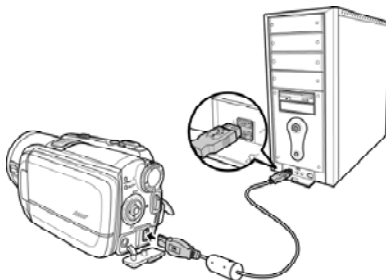

2.10 Connecting to a standard TV

Connect the camcorder to a standard TV as shown with the AV cable provided.

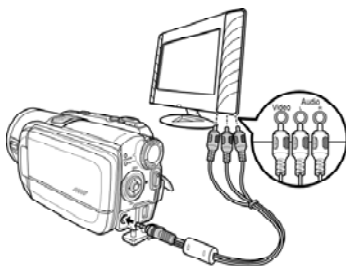

2.11 Connecting to an HDTV

Read this section to learn how to show the video clips or photos on an HDTV. Connecting to an HDTV offers the high resolution for displaying the video clips or photos.

Connect the camcorder to an HDTV with an HDMI cable as shown.

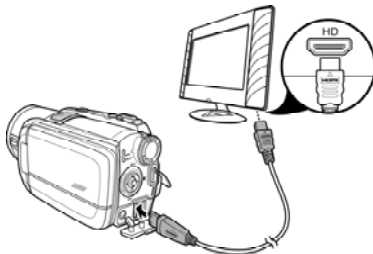

- **Note:**
Photo capturing, camcorder, and voice recording are not support when connected to an HDTV and TV.

3 Using the camcorder

Read this section to learn how to use the camcorder.

3.1 Camcorder and voice recorder mode

Use this mode to capture video clips or record voice and store them on an SD card.

3.1.1 Camcorder and voice recorder mode

Use the following picture to familiarize yourself with the Camcorder and voice recorder mode icons and symbols.

Camcorder mode

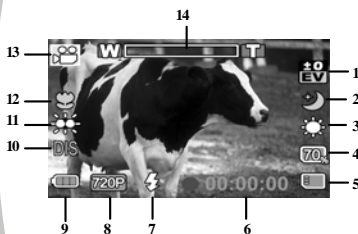















Voice recorder mode



Camcorder mode:



See the table below for a description of each icon and symbol.



1		EV compensation indicator
2		Night mode indicator
3		White balance indicator
4		Memory space indicator

5		Memory status indicator  : No SD card  : SD card in
6	00:00:00	Recording time indicator
7		Forced flash indicator
		Auto flash indicator
8		Resolution and frame rate indicator
9		Battery indicator
10		Stabilizer indicator
11		LED light indicator
12		Macro indicator
		Auto Focus (AF) lock indicator
		Manual Focus (MF) indicator
13		Camcorder mode indicator
14		Zoom indicator

Voice recorder mode:

See the table below for a description of each icon and symbol.

1		Memory status indicator  : SD card in  : No SD card
---	---	---

2		Indicates: press to record or stop
3		Battery indicator
4		Voice recorder mode indicator

3.1.2 Using the macro function

This function can capture subjects close to the lens. In macro mode, subjects can be as close as 5 cm.

While in **Camera** and **Camcorder** modes, move the joystick right to activate the macro function, and an  icon displays on the LCD screen.

3.1.3 Using the AF Lock

The **Auto Focus (AF) Lock** function is used to lock focus on a desired image.

1. Press the joystick inwards to enable AF Lock. The AF Lock icon appears on the screen.



2. Aim the camera on your desired subject.
3. Press the **REC** button to record videos or the shutter button to capture images.

3.1.4 Using the Manual Focus

The **Manual Focus (MF)** function is used to manually set the focus.

1. Press the joystick right repeatedly until the MF icon is displayed on the screen.



2. Aim the camera on your desired subject.
3. Move the zoom buttons left or right to manually adjust focus.

● **Note:**

To zoom in or out the image, press and hold the Display button, then move the zoom buttons left or right.

4. Press the **REC** button to record videos or the shutter button to capture images.

3.1.5 Using the zoom function

The camcorder is equipped with 5x optical zoom and 4X digital zoom.

Move the **Zoom** button **right** to get closer to a subject.

Move the **Zoom** button **left** to move away from a subject.



3.1.6 Using the LED light

Use the LED light to illuminate subjects in dark environments.

Press the **Light** button to switch on the light and press again to switch it off.

3.1.7 Using the Flash module

Use the flash module to illuminate subjects in dark environments when pressing the shutter button.

Three different flash modes are available: **Auto Flash**, **Forced Flash**, and **None**. You can toggle different flash modes by pressing the **Flash** switch. The Auto Flash icon  or Forced Flash icon  is displayed on the screen when activated.

3.1.8 Using the Stabilizer function

Use the Stabilizer function to reduce vibration caused by camcorder shanks during a video shoot.

See section 4.1.6 "Stabilizer".

3.1.9 Quick access controls

You can also make adjustments to exposure by pressing the joystick up and down.

In **Camcorder** and **Camera** modes, press the joystick up and down to adjust the EV compensation settings. Press the joystick left to choose white balance settings.

3.2 Camera mode

Use **Camera** mode to capture still pictures and store them in the on an SD card.





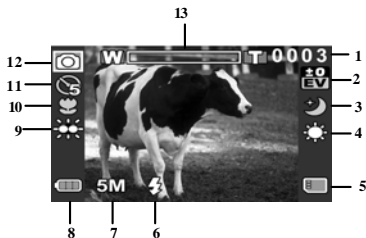





3.2.1 Camera mode icons

Use the following picture to familiarize yourself with the **Camera** mode icons and symbols.



See the table below for a description of each icon and symbol.

1	0003	Remaining number of photos
2		EV compensation indicator
3		Night mode indicator
4		White balance indicator
5		Memory status indicator : SD card indicator : No SD card
6		Forced flash indicator

		Auto flash indicator
7		File size indicator
8		Battery indicator
9		LED light indicator
10		Macro indicator
		Auto Focus (AF) lock indicator
		Manual Focus (MF) indicator
11		Self timer indicator
12		Camera mode indicator
13		Zoom indicator

3.2.2 Using the macro function

See section 3.1.2 "Using the macro function".

3.2.3 Using the AF Lock

See section 3.1.3 "Using the AF Lock".

3.2.4 Using the Manual Focus

See section 3.1.4 "Using the Manual Focus".

3.2.5 Using the zoom function

See section 3.1.5 "Using the zoom function".

3.2.6 Using the LED light module

See section 3.1.6 "Using the LED light".

3.2.7 Using the flash module

See section 3.1.7 "Using the Flash module".

3.2.8 Using the Stabilizer function

See section 3.1.8 "Using the Stabilizer function".

3.2.9 Quick access controls

See section 3.1.9 "Quick access controls".

3.3 Camcorder Playback mode

Use **Camcorder Playback** mode to review all the movie files stored on the SD card.

3.3.1 Camcorder Playback mode icons

Refer to the following picture to familiarize yourself with the **Camcorder Playback** mode icons and symbols.

Camcorder playback mode



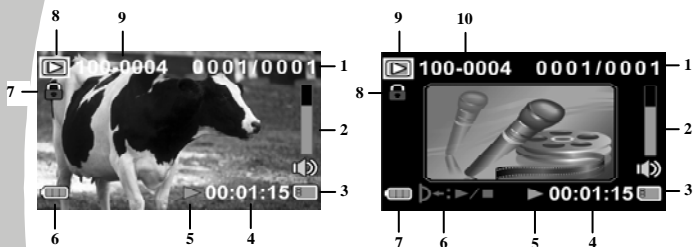

Voice playback mode



Camcorder mode:







See the table below for a description of each icon and symbol.



1	0001/0001	Displays the number of current camcorder / total number of recorded video clips
2		Volume level
3		Memory status indicator  : SD card in

		: No SD card
4	00:00:00	The length of every video clip
5		Play indicator
6		Battery status indicator
7		File protect indicator
8		Camcorder playback mode icon
9	100-0001	Displays the file number of the video clip

Voice Recorder mode:

See the table below for a description of each icon and symbol.

1	0001/0001	Displays the number of current audio/ total number of recorded audio clips
2		Volume level
3		Memory status indicator  : SD card in  : No SD card
4	00:00:00	The length of every audio clip
5		Play indicator
6		Indicates: press to Play/ Stop
7		Battery status indicator

8		File protect indicator
9		Voice playback mode
10	100-0001	Displays the file number of the audio clip

3.4 Camera Playback mode







Use **Camera Playback** mode to review all the image files stored in the camcorder.

3.4.1 Camera Playback mode icons

Refer to the following picture to familiarize yourself with the **Camera Playback** mode icons and symbols.



See the table below for a description of each icon and symbol.

1	0001/0001	Displays the number of current image / the total number of saved images
2		Memory status indicator  : SD card in  : No SD card
3		Battery status indicator
4		File protect indicator
5		Playback mode icon
6	100-0001	Displays the file number of the photo

3.5 Thumbnail mode

When in **Camera Playback** or **Camcorder Playback** modes, move Joystick button up to show images as thumbnails.

1. Turn on the camcorder and make sure it is in **Camera Playback** or **Camcorder Playback** mode.
2. The last played image /video clip displays on the screen. Move Joystick button up to view **six** thumbnail images /video clips on the LCD screen.



3. Move the joystick up/ down and left/ right to highlight an image, or a video clip, and press the center joystick button to view the image or playback the video clip or voice file in full screen mode.
4. Move joystick button up to return to thumbnail view.

4 Using the menus

Read this section to learn how to configure the camcorder settings and use the advanced features.

4.1 Camcorder menu

When in **Camcorder** mode, press the **Menu** button to show the camcorder options menu.

4.1.1. White balance

Use this option to correct color difference for different lighting conditions. When white balance is set to **Auto**, the camcorder automatically compensates for different lighting conditions.

1. Turn the camcorder on and ensure it is in **Camcorder** mode.
2. Press the **Menu** button and move the joystick up and down to highlight the **White Balance** option. Press the center joystick button to display the submenu.
3. Move the joystick left and right to select **Auto**, **Sunny**, **Cloudy**, **Tungsten**, or **Fluorescent**. Press the center joystick button to confirm.

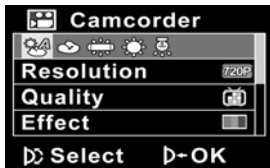
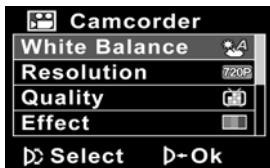

4. Press the **Menu** button again to exit the menu.

4.1.2. Video resolution

Use the resolution option to determine the resolution of the captured video. The larger screen size requires more memory storage space.

1. Turn the camcorder on and ensure it is in **Camcorder** mode.
2. Press the **Menu** button and move the joystick up and down to highlight the **Resolution** option. Press the center joystick button to display the submenu.
3. Press the joystick left and right to select **QVGA**, **WVGA**, **720P**, **1080P**. Press the center joystick button to confirm.

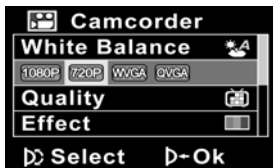
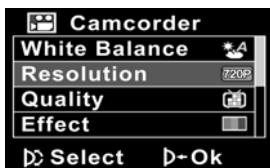

4. Press the **Menu** button again to exit the menu.

● Notes:

1. The LCD displays the 16:9 ratio while setting as WVGA, 720P, 1080P video resolution.
2. The LCD displays the 4:3 ratio while setting as QVGA video resolution.

4.1.3. Quality

There are two different levels of video quality. Higher quality video needs more memory storage space and higher speed SD card.

1. Turn the camcorder on and ensure it is in **Camcorder** mode.
2. Press the **Menu** button and move the joystick up and down to highlight the **Quality** option. Press the center joystick button to display the submenu.
3. Move the joystick left and right to select **Fine** or **Normal**. Press the center joystick button to confirm.

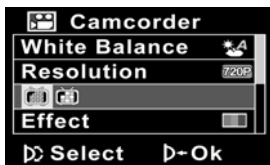
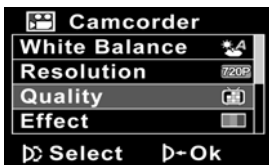

4. Press the **Menu** button again to exit the menu.

4.1.4. Color effect

The camcorder can capture standard color images, black and white images, or sepia tone to give an old-fashioned look.

1. Turn the camcorder on and ensure it is in **Camcorder** mode.
2. Press the **Menu** button and move the joystick up and down to highlight the **Effect** option. Press the center joystick button to display the submenu.
3. Move the joystick left and right to select **Color**, **B&W** or **Sepia**. Press the center joystick button to confirm.

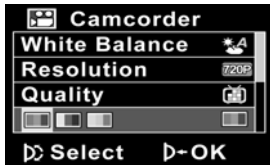
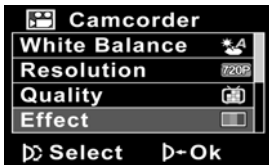

4. Press the **Menu** button again to exit the menu.

4.1.5. Night mode

Use this function to shoot a better video clip quality in dark environments.

1. Turn the camcorder on and ensure it is in **Camcorder** mode.
2. Press the **Menu** button and move the joystick up and down to highlight the **Night Mode** option. Press the center joystick button to display the submenu.
3. Move the joystick left and right to select **Off** or **Night mode** options. Press the center joystick button to confirm.

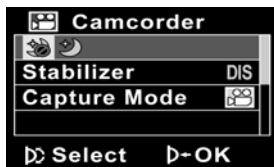
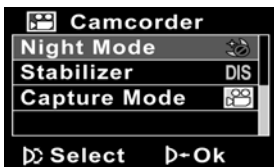

4. Press the **Menu** button again to exit the menu.

4.1.6. Stabilizer

Use this function to reduce vibration caused by camcorder shakes during a video shoot.

1. Turn the camcorder on and ensure it is in **Camcorder** mode.
2. Press the **Menu** button and move the joystick up and down to highlight the **Stabilizer** option. Press the center joystick button to display the submenu.
3. Move the joystick left and right to select **Off** or **Stabilizer** options. Press the center joystick button to confirm.

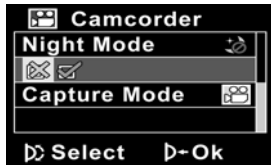
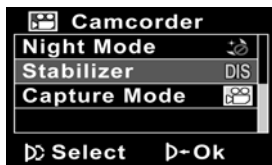

4. Press the **Menu** button again to exit the menu.
5. An icon **DIS** displays on the screen.

- **Note:**
Stabilizer function is available in video resolution QVGA, WVGA(30fps), and 720P(30fps) only.

4.1.7. Capture mode

Use this function to record sound or image.

1. Turn the camcorder on and ensure it is in **Camcorder** mode.
2. Press the **Menu** button and move the joystick up and down to highlight the **Capture Mode** option. Press the center joystick button to display the submenu.
3. Move the joystick left and right to select **Voice recorder** or **Video** options. Press the center joystick button to confirm.

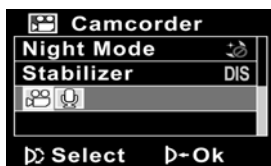
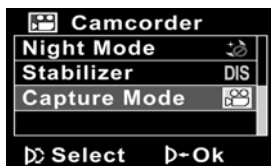

4. Press the **Menu** button again to exit the menu.

4.2 Camcorder playback menu

Use the playback menu to manage the files stored on the SD card.

4.2.1 Delete

Use this function to delete files.

1. Turn the camcorder on and ensure it is in **Camcorder** mode. Press the **Playback** button and then press the **Menu** button to display the **Camcorder Playback** menu.
2. Move the joystick up and down to select **Delete One** or **Delete All** options.

If you select **Delete One**, the playback screen appears again. Move the joystick right and left to locate the file you want to delete and press the center joystick button to confirm.

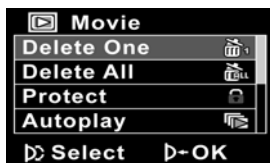

If you select **Delete All**, press the center joystick button to display the submenu.

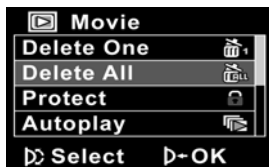

3. Move the joystick left and right to select X or \checkmark and press the center joystick button to delete.

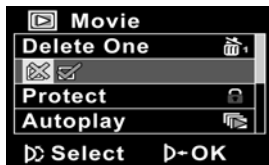

4. Press the **Menu** button again to exit the menu.

● **Note:**

Once deleted, files cannot be recovered so make sure you have a backup before you delete. Files that have been protected will not be deleted. You have to unlock the files first before deleting them.

4.2.2 Protect

Use this function to lock files to prevent accidental deletion.

1. Turn the camcorder on and ensure it is in **Camcorder** mode. Press the **Playback** button and then press the **Menu** button to display **Camcorder Playback** menu.
2. Move the joystick up and down to select the **Protect** option. Then playback screen appears again. Move the joystick to locate the file you want to protect and press the center joystick button to confirm. A lock  icon is displayed to show that the file is protected.

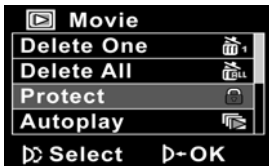

3. Press the **Menu** button again to exit the menu.

● **Note:**

To unlock a file, repeat the above steps. The  lock icon disappears when the file is unlocked.

4.2.3 Autoplay

Use this function to repeatedly play all movie clips stored in the internal memory or on the SD card.

1. Turn the camcorder on and ensure it is in **Movie** mode. Press the **Playback** button and then press the **Menu** button to display the **Movie Playback** menu.
2. Move the joystick up and down to select the **Autoplay** option and press the joystick inwards to confirm.
3. Move the joystick left/right to select \surd . The camcorder returns to the **Movie Playback** mode automatically.

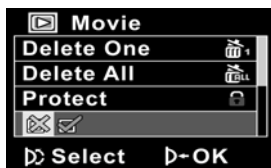
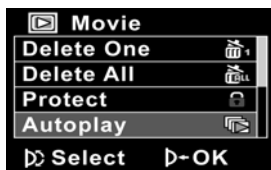

4. Press the joystick inwards to play all movie clips repeatedly.

4.3 Camera menu

In **Camera** mode, press the **Menu** button to show the **Camera Options** menu.

4.3.1 White balance

Use this option to correct color difference due to lighting conditions.

1. Turn the camcorder on and ensure it is in **Camera** mode.
2. Press the **Menu** button and move the joystick up and down to highlight the **White Balance** option. Press the center joystick button to display the submenu.
3. Move the joystick left and right to select **Auto**, **Sunny**, **Cloudy**, **Tungsten**, or **Fluorescent**. Press the center joystick button to confirm.

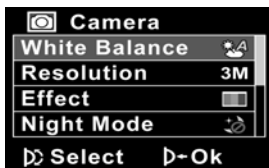

4. Press the **Menu** button again to exit the menu.

4.3.2 Resolution

Use this option to set the size of the captured image. Larger images contain more detail and therefore use more memory space.

1. Turn the camcorder on and ensure it is in **Camera** mode.
2. Press the **Menu** button and move the joystick up and down to highlight the **Resolution** option. Press the center joystick button to display the submenu.
3. Move the joystick left and right to select from **3M**, **5M** or **12M**. Press the center joystick button to confirm.

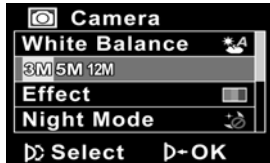
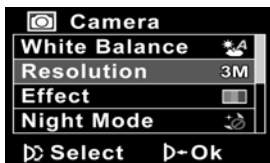

4. Press the **Menu** button again to exit the menu.

4.3.3 Color effect

The camcorder can capture standard color images, black and white images, or sepia tone to give an old-fashioned look.

1. Turn the camcorder on and ensure it is in **Camera** mode.
2. Press the **Menu** button and move the joystick up and down to highlight the **Effect** option. Press the center joystick button to display the submenu.
3. Move the joystick left and right to select **Color**, **B & W**, or **Sepia**. Press the center joystick button to confirm.

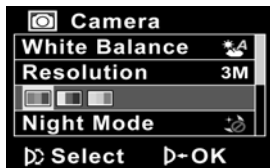
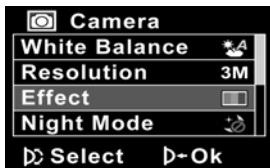

4. Press the **Menu** button again to exit the menu.

4.3.4 Night mode

Use this function to shoot a better photo quality in dark environments.

1. Turn the camcorder on and ensure it is in **Camera** mode.
2. Press the **Menu** button and move the joystick up and down to highlight the **Night Mode** option. Press the center joystick button to display the submenu.
3. Move the joystick left and right to select **Off** or **Night mode** option. Press the center joystick button to confirm.

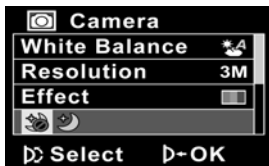
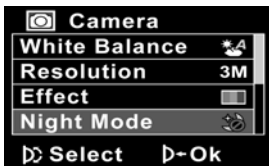

4. Press the **Menu** button again to exit the menu.

4.3.5 Self-timer

Use the self timer function to take a photo of yourself.

1. Turn the camcorder on and ensure it is in **Camera** mode.
2. Press the **Menu** button and move the joystick up and down to highlight the **Self-timer** option. Press the center joystick button to display the submenu.
3. Move the joystick left and right to select **Off**, **5 seconds**, or **10 seconds** options. Press the center joystick button to confirm.

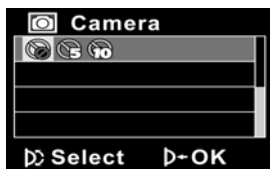

4. Press the **Menu** button again to exit the menu.

4.4 Camera playback menu

4.4.1 Delete

Use this function to delete files.

1. Turn the camcorder on and ensure it is in **Camera** mode. Press the **Playback** button and then press the **Menu** button to display the **Camera Playback** menu.
2. Move the joystick up and down to select the **Delete One** or **Delete All** options.

If you select **Delete One**, the playback screen appears again. Move the joystick left and right to locate the file you want to delete and press the center joystick button to confirm.



If you select **Delete All**, press the center joystick button to display the submenu.



3. Move the joystick left and right to select X or ✓ and then press the center joystick button to delete.

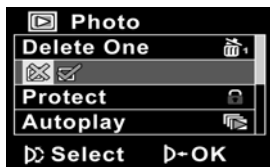

4. Press the **Menu** button again to exit the menu.

● **Note:**

Once deleted, files cannot be recovered so make sure you have a backup before you delete. Files that have been protected will not be deleted. You have to unlock the files first before deleting them.

4.4.2 Protect

Use this function to protect files.

1. Turn the camcorder on and ensure it is in **Camera** mode. Press the **Playback** button and then press the **Menu** button to display the **Camera Playback** menu.
2. Move the joystick up and down to select the **Protect** option. Then playback screen appears again. Press the joystick up and down to locate the file you want to protect and press the center joystick button to confirm. A lock  icon is displayed to show that the file is protected.



3. Press the **Menu** button again to exit the menu.

● **Note:**

To unlock a file, repeat the above steps. The  lock icon disappears when the file is unlocked.

4.4.3 Autoplay

The camcorder includes a slide show function, which repeatedly displays each image in turn with a regular interval.

1. Turn the camcorder on and ensure it is in **Camera** mode. Press the **Playback** button and then press the **Menu** button to display the **Camera Playback** menu.
2. Move the joystick up/down to select the **Autoplay** option and press the joystick inwards to confirm. The camcorder returns to the **Camera Playback** mode automatically.



3. Press the joystick inwards to play all pictures repeatedly.

4.4.4 DPOF

Use the DPOF (Digital Print Order Format) function to tag pictures stored in the memory card with print information.

1. Turn the camcorder on and ensure it is in **Camera** mode. Press the **Playback** button and then press the **Menu** button to display the **Camera Playback** menu.
2. Move the joystick up and down to highlight the **DPOF** option. Press the center joystick button to display the submenu.

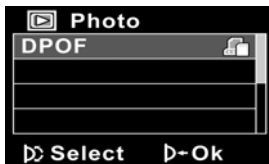

3. Press the **Menu** button again to exit the menu.

● **Notes:**

1. A memory card is required for DPOF function.
2. If DPOF is set, all photos are ordered to print.

4.5 System menu

The system menu is used to configure miscellaneous camera functions.

4.5.1 Setting the beep

See section 2.6.3 "Setting the Beep".

4.5.2 Auto power off

Use this function to switch the camcorder off automatically after a period of inactivity for power saving.

1. Turn on the camcorder and switch to **SET** mode.
2. Move the joystick up and down to highlight the **Auto Power Off** option. Press the center joystick button to display the submenu.
3. Move the joystick left and right to select **Off**, **1 minute**, or **5 minutes**. Press the center joystick button to confirm.



4.5.3 TV standard

Use the TV option to set the TV system for the area.

1. Turn on the camcorder and switch to **SET** mode.
2. Move the joystick up and down to highlight the **TV standard** option. Press the center joystick button to display the submenu.
3. Move the joystick left and right to select **NTSC** or **PAL**, and press the center joystick button to confirm.



4.5.4 Format

Use this function to format the current storage media. This format action will delete everything on the media.

1. Turn on the camcorder and switch to **SET** mode.
2. Move the joystick up and down to highlight the **Format** option. Press the center joystick button to display the submenu.
3. Move the joystick left and right to select **X** or **✓**, and press the center joystick button to confirm.

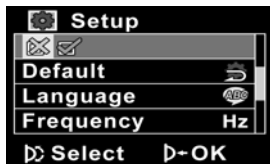
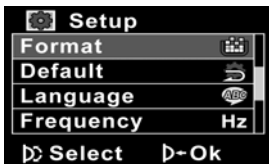

4. The current media (memory card) is formatted.

4.5.5 Default

Use this option to reset all settings to the default settings.

1. Turn on the camcorder and switch to **SET** mode.
2. Move the joystick up and down to highlight the **Default** option. Press the center joystick button to display the submenu.
3. Move the joystick left and right to select **X** or **√**, and press the center joystick button to confirm.

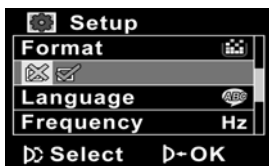
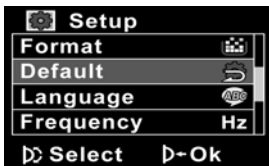

4.5.6 Language

See section 2.6.2 "Setting the language".

4.5.7 Frequency

Use the Frequency option to set the frequency system for your area.

To set the frequency:

1. Turn on the camcorder and switch to **SET** mode.
2. Move the joystick up and down to highlight the **Frequency** option. Press the center joystick button to display the submenu.
3. Move the joystick left and right to select **50 Hz** or **60 Hz**. Press the center joystick button to confirm.

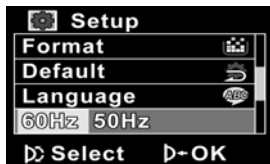
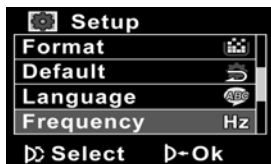

4.5.8 Date/time

See section 2.6.1 "Setting the date and time".

Appendix

Specifications

General	
Imaging sensor	1/2.5" CMOS 5.0 Megapixel sensor
Active pixels	5.0 Megapixel
Storage media	Internal: Built-in 128MB (available about 98MB) Nand flash memory External: SD Card (Up to SDHC 16GB Class6)
Sensor sensitivity	Auto
Color effects	Color/B&W/Sepia
Lens	5X Optical zoom lens Wide: F/3.2, f=6.26mm Tele: F/6.8, f=30.75mm
Focus range	Normal: 45cm ~ inf. Macro: Wide 20 ~ 45 cm Middle 10 ~ 45cm Tele 5 ~ 45cm

General

Video clips	Format: H.264 (AVI) Resolution: QVGA(30fps), WVGA(60fps), 720P(30fps) , 1080P(30fps) DIS Function WVGA(30fps), 720p(30fps), QVGA(30fps)
Still image	Formats: JPEG (EXIF2.2), DPOF, DCF Resolution: 3M, 5M, 12M
Zoom	Camcorder: 5X Optical Zoom, 4X Digital Zoom (1080P without Digital Zoom) Camera: 5X Optical zoom, 4X Digital Zoom Playback: Digital Zoom Max. 8X
Audio Video	Yes
TFT Monitor	3.0" TFT (960 x 240 pixels) (16:9)
LED light	Effective Range: 0.5m ~ 1m Mode: On / Off
Strobe (Camera)	Effective Range: 1m ~ 1.5m Mode: Auto / Off / Force
White balance	Auto/Sunny/Cloudy/Tungsten/ Fluorescent

General

EV compensation	-2.0 EV~+2.0 EV (0.5EV per step)
Self-timer	5 seconds, 10 seconds, Off
PC interface	USB 2.0 (high speed)
TV out format	NTSC/PAL/ HDMI
Shutter	1/2 ~ 1/ 2000 sec.
Auto power off	Off, 1 min., 5 min.
Power supply	Li-Ion battery NP-120
Dimension	57 (W) x 70 (H) x 129 (D) mm
Weight	Approx. 292+5g (without batteries)

Troubleshooting

Problem	Possible Cause	Solution
Cannot turn on the camcorder.	The batteries are not inserted correctly. The batteries have no power.	<ul style="list-style-type: none">• Insert the batteries correctly. (See 2.2 Inserting the batter.)• Please charge the battery. (See 2.3 Charging the battery.)
The camera suddenly turns off.	The auto power off function was enabled. The camera is running out of battery power.	<ul style="list-style-type: none">• Turn the power on again.• Please charge the battery. (See 2.3 Charging the battery.)
The captured image is not stored in memory.	Before the image is saved the power has been cut off.	When battery indicator turns empty (without green bars), replace the battery immediately.

<p>The camera turns off when capturing image using self-timer.</p>	<p>The camera is running out of battery power.</p>	<ul style="list-style-type: none"> • Please charge the battery. (see 2.3 Charging the battery)
<p>The image is out of focus.</p>	<p>The subject is beyond focus range.</p>	<ul style="list-style-type: none"> • Please take a picture within the available focus range and choose normal or macro mode. (See 3.2.2 Using the macro function).
<p>Memory card cannot be used.</p>	<p>The memory card is protected.</p> <p>The memory card contains non-DCF images taken by other cameras.</p>	<ul style="list-style-type: none"> • Unlock the memory card. <p>Format the memory card. (See 4.5.4 Format.) Before formatting the card, ensure you back up the files.</p>
<p>All buttons are</p>	<p>Short circuit occurred when</p>	<ul style="list-style-type: none"> • Remove the batteries from

inactive.

connecting the
camera with
other devices.

the camera and
insert again.



Free Manuals Download Website

<http://myh66.com>

<http://usermanuals.us>

<http://www.somanuals.com>

<http://www.4manuals.cc>

<http://www.manual-lib.com>

<http://www.404manual.com>

<http://www.luxmanual.com>

<http://aubethermostatmanual.com>

Golf course search by state

<http://golfingnear.com>

Email search by domain

<http://emailbydomain.com>

Auto manuals search

<http://auto.somanuals.com>

TV manuals search

<http://tv.somanuals.com>