

CREATIVE

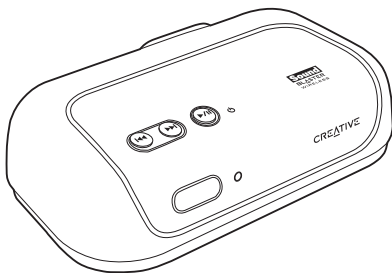

Sound Blaster® Wireless Receiver

User's Guide

Download from [Www.Somanuals.com](http://www.Somanuals.com). All Manuals Search And Download.

Congratulations!

Your Sound Blaster® Wireless Receiver complements Creative transmitters like Sound Blaster Wireless Transmitter and Sound Blaster X-Fi™ Notebook. Together, your receiver and transmitter enable you to enjoy high-quality music, wherever you are in your home, wirelessly. You can also expand your wireless system by adding on other Sound Blaster Wireless devices.

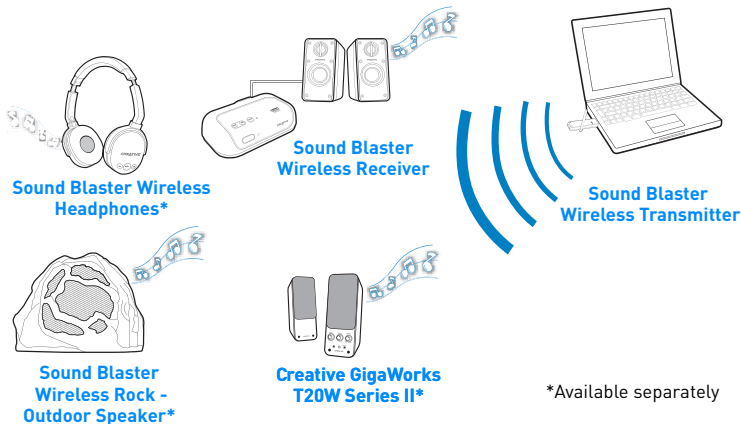

NOTE The term “receiver” used throughout this User’s Guide refers to the Sound Blaster Wireless Receiver. “Transmitter” refers to any of the transmitters mentioned above.

About Your Receiver

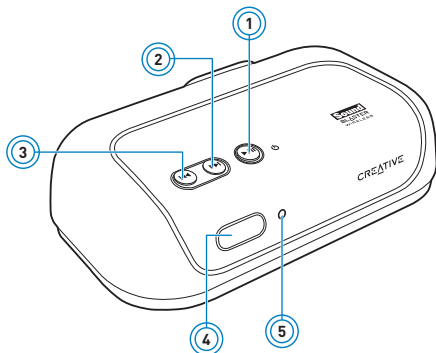

- 1 **Power/Standby and Play/Pause button**
Press to turn on.
Press and hold to enable Standby mode.
- 2 **Next/Fast forward button**
Press and hold to Fast forward.
- 3 **Previous/Rewind button**
Press and hold to Rewind.
- 4 **Infrared receiver**
- 5 **Power LED**
See "Understanding the Power LED" on page 14.
- 6 **Line Out jack**
- 7 **RCA Audio Line Out jacks**
- 8 **[Link/Connect] LED button**
See "Understanding the Link LED" on page 14.
- 9 **5V DC In jack**

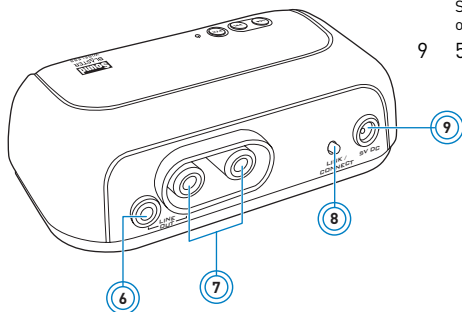

About Your Remote Control

Your remote control has an operating distance of up to three meters (approximately 9.8 feet). To remove and replace the remote control's battery, see "Replacing the remote control battery" on page 15.

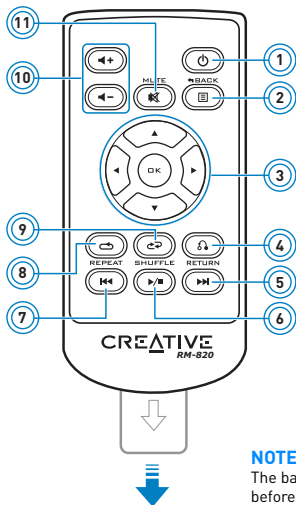

- 1 Power/Standby
- 2 iPod® Back/Menu*
- 3 Menu Navigation buttons
Press OK to execute the selected menu option.
- 4 (Not applicable)
- 5 Next/Fast forward
Press and hold to Fast forward.
- 6 Play/Pause
- 7 Previous/Rewind
Press and hold to Rewind.
- 8 Repeat
- 9 Shuffle
- 10 Volume up/down
- 11 Mute on/off

* For use with transmitters that support iPod players.

NOTE

The battery is included. Remove the plastic strip before using the remote control.

Setting Up Your Receiver

Step 1: Position your receiver

You can pair (connect wirelessly) your transmitter and receiver before positioning your receiver. Once paired, place your receiver up to 30 meters away from your transmitter.

NOTE Signal quality between the transmitter and receiver may be affected by any object or structure (for example, multiple walls) that is between the units. Experiment with different positions if necessary.

Step 2: Connect your receiver

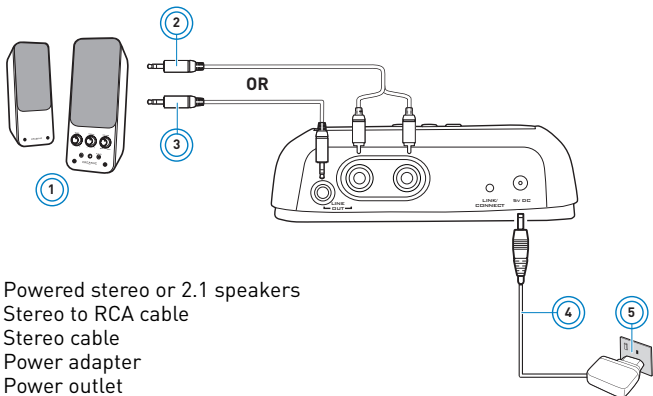

- 1 Powered stereo or 2.1 speakers
- 2 Stereo to RCA cable
- 3 Stereo cable
- 4 Power adapter
- 5 Power outlet

Step 3: Enable wireless control for your transmitter

For Sound Blaster Wireless Transmitter

The device's wireless features are enabled by default. If not, refer to its documentation to enable it.

For Sound Blaster X-Fi Notebook

Follow these steps to enable the device's wireless features:

- 1 Launch Entertainment Mode. To do this, click **Start -> Programs -> Creative -> Sound Blaster X-Fi Notebook -> Creative Console Launcher**.
- 2 Click the Wireless Music Control button.
- 3 Select the **Enable Wireless Music Control** check box.
The device's Link LED lights up green.

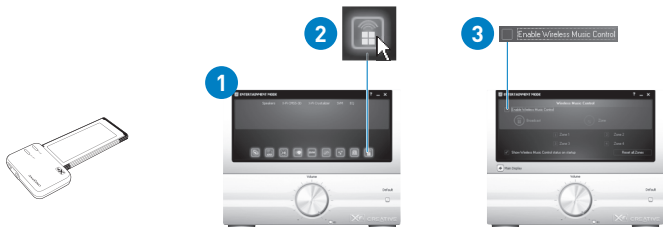

Step 4: Turn on your receiver and Auto Pair

Your transmitter and receiver pair (connect wirelessly) automatically when turned on. The Link LED, at the back of the receiver, flashes and then lights up green when pairing is successful.

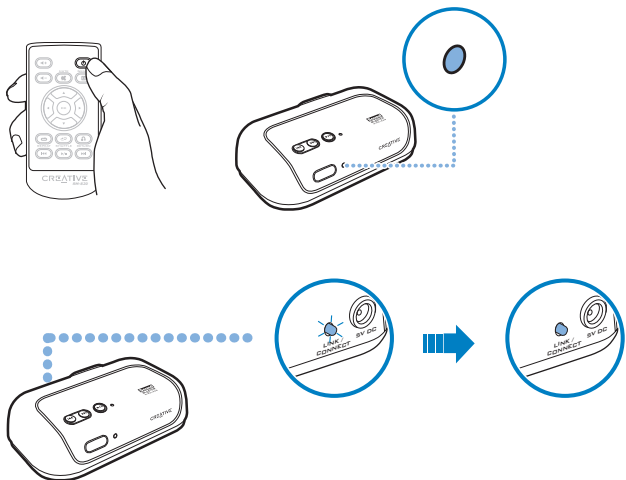

NOTE If your transmitter and receiver do not pair, simply reset them. On one unit at a time, press and hold the Connect button for five seconds.

Step 5: Play and stream music from transmitter

Play music on your transmitter and broadcast music to your receiver.

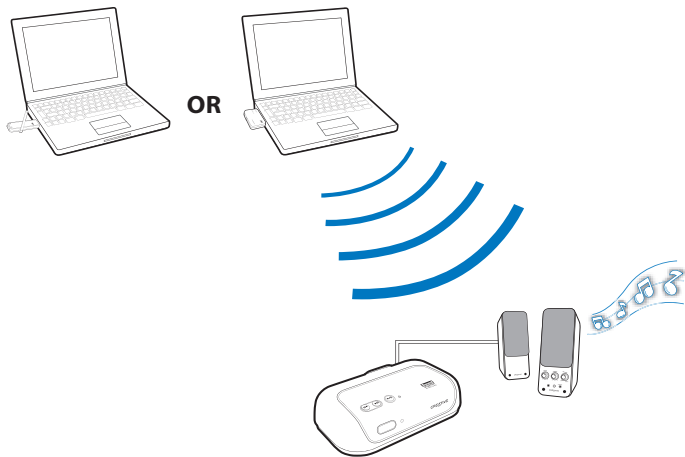

Setting Up Two or More Receivers

Repeat Steps 1 to 2 in "Setting Up Your Receiver" on page 4. In Step 4, turn on all your receivers. Your receivers pair automatically with your transmitter, and you can start playing music on all your receivers.

Manual Pairing

This section shows you how to pair your transmitter manually with two to four receivers. If you wish to use zone control, you must pair your units manually. For more information about broadcasting and zone control, see "Using Your Wireless Features" on page 11.

Only the first four manually paired receivers will be assigned to a wireless zone. Each manually paired receiver will be assigned to the next available zone.

Step 1: Press the Connect button on your transmitter

With your transmitter and receivers turned on, press the Connect button on your transmitter. Alternatively, you can click the Connect button in the transmitter software installed. The transmitter's Link LED flashes.

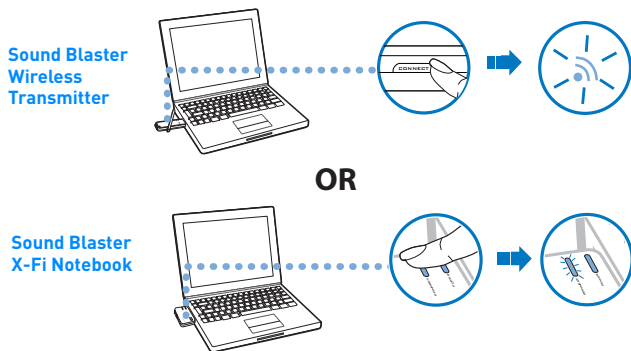

Step 2: Press the Connect button on your first receiver

This must be done within three minutes after pressing the Connect button on the transmitter (Step 1). Once the transmitter and receiver are paired successfully, the Link LED on both units light up green and remain on. The first receiver to be paired will be assigned to Zone 1.

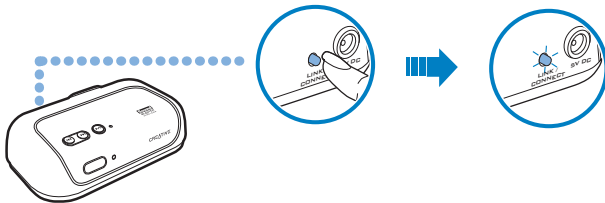

IMPORTANT DO NOT press the Connect button repeatedly on your transmitter or receiver before a pairing process is complete or else you may not be able to perform the correct zone assignment for your receivers.

Step 3: Press the Connect button on your transmitter again

The transmitter's Link LED flashes. Refer to the diagram in Step 1.

Step 4: Press the Connect button on your second receiver

Refer to the diagram in Step 2. Once the transmitter and receiver are paired successfully, the Link LED on both units light up green and remain on. Repeat the steps to pair your third and fourth receivers (if applicable) manually.

Step 5: Test your receivers

- 1 Play music from your transmitter.
- 2 Use the transmitter software to select the zones assigned to the receivers you want to activate or deactivate. See "Using Your Wireless Features" on page 11 for instructions do this.

NOTE For troubleshooting information, see "Troubleshooting" on page 16.

Using Your Wireless Features

Use the transmitter software installed on your computer to control your receivers remotely from your transmitter.

Broadcasting

Broadcasting can be used on any number of paired receivers. This feature enables you to activate or deactivate all paired receivers simultaneously.

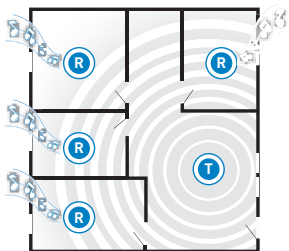

T Transmitter

R Receiver

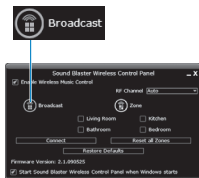

Sound Blaster
Wireless
Transmitter

OR



Sound Blaster
X-Fi Notebook

For Sound Blaster Wireless Transmitter

In Sound Blaster Wireless Control Panel, click the Broadcast  button.

For Sound Blaster X-Fi Notebook

In Entertainment Mode, click the **Enable Wireless Control** check box.

Zone Control

Zone control is limited to the first four manually paired receivers. This feature enables you to activate or deactivate each paired receiver individually.

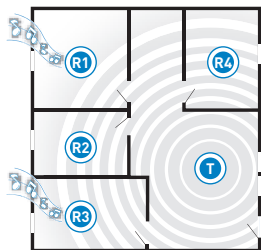



T Transmitter

R Receiver

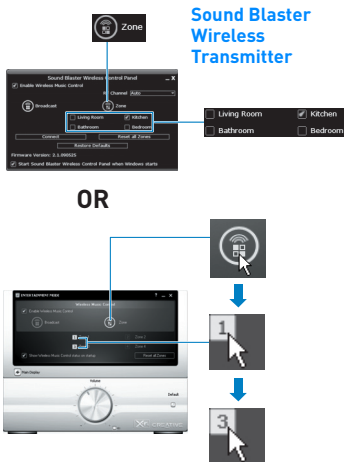
Sound Blaster
X-Fi Notebook



For Sound Blaster Wireless Transmitter

- 1 In Sound Blaster Wireless Control Panel, click the Zone button, and then click the zones assigned to the receivers you want to activate or deactivate.
- 2 Clicking the Zone  button will put the activated zones/receivers on standby.
- 3 Click the Zone  button again to activate the previously selected zones/receivers.

NOTE Your transmitter can only save and reactivate one combination of receivers. It remembers the last combination of activated receivers just before the Zone button is clicked.

For Sound Blaster X-Fi Notebook

- 1 In Entertainment Mode, click the Zone button, and then click the zone number buttons (1 to 4) assigned to the receivers you want to activate or deactivate.
- 2 Click the **Enable Wireless Music Control** check box to deselect it. Activated receivers will then be on standby.
- 3 Click the **Enable Wireless Music Control** check box again to select it. Previously selected receivers will be activated.

Other Information

Understanding the Power LED

LED	Behavior	Status
White	Stable	Turned on and ready for use
	Continuous slow flashing	Not detecting any signal or signal is weak
Red	Stable	In Standby mode
	Quick flashing (twice)	Receiving remote control signals
	Continuous slow flashing	Muted

Understanding the Link LED

LED	Behavior	Status
Green	Stable	Paired (Turned on / In Standby mode)
	Flashing	Pairing in progress
	Quick flashing (twice) -> Not lit -> Stable	Wireless reset
Not lit	-	Connection lost

Returning to factory default settings

Return to the factory default settings if you want to

- revert to the original volume setting,
- reset your zone numbering sequence, or
- “unpair” a receiver.

Press and hold the Previous/Rewind and Next/Fast forward buttons on your receiver together for five seconds. The Power LED goes off for two seconds before lighting up again.

NOTE The receiver pairs with your transmitter automatically if both return to factory default settings.

Replacing the remote control battery

Refer to the following diagram to remove and replace the battery (when it is depleted) from the remote control.

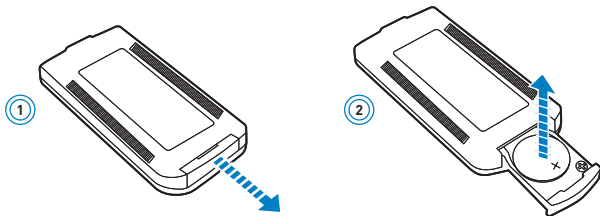

Troubleshooting

Here are some tips if you encounter these problems.

There is no sound from the speakers that are connected to the receiver.

Check the following:

- The Connect LEDs are lit up. Else see the following troubleshooting tip.
- The receiver is connected to the power outlet and turned on.
- The speaker system's power is turned on.
- You have connected the speakers to your receiver correctly.
- The receiver volume is not muted.

The wireless connection does not seem to work.

The Connect LEDs do not light up.

The signal from the transmitter may be weak or the receiver has lost its connection with the transmitter.

Try the following:

- Move your transmitter and receiver closer to each other.
- Reposition your transmitter or receiver so that there are fewer objects (for example, multiple walls or large metal structures) between them.
- Make sure your transmitter and receiver are not placed on metal surfaces.
- Reset the wireless connection. Press and hold the receiver's Connect button for five seconds.
- Disconnect the transmitter and receiver from the power source. Then reconnect them again and reset the wireless connection.

My receiver seems to be picking up extra noise, or there are intermittent pauses.

The position of your Sound Blaster Wireless devices as well as signals from other wireless routers or Bluetooth equipment may affect the quality of the transmissions.

Try the following:

- In Sound Blaster Wireless Control Panel, change the RF Channel from Auto to either Ch 1, 2 or 3.
- Place your transmitter and receivers closer to each other.
- Place your transmitter away from other devices that transmit wireless signals, and away from large metal surfaces.
- Reposition your devices so that there are fewer objects (for example, multiple walls or large metal structures) between them.
- Set your wireless LAN router's channel to Auto, 1 or 11. To do this, refer to your router's user documentation.
- Refrain from doing large file transfers via the wireless internet or Bluetooth connection while you are streaming music. Alternatively, stop streaming music during intensive file transfers.

I have two Sound Blaster Wireless transmitters. My receiver is receiving the incorrect transmission.

Your receiver may be alternating transmissions between the transmitters. Manually pair your receivers. See "Manual Pairing" on page 8.

My remote control is not responding.

- Your remote control's battery may have depleted. To remove and replace the battery, see "Replacing the remote control battery" on page 15.

Also check the following:

- You have installed the transmitter software.
- In the **Remote Control Settings** application, ensure that the **Enable control of Windows Application** check box is selected. To launch this application, click **Start -> All Programs -> Creative -> Remote Control Settings**.
- The media player that you are using must be the highlighted window for the playback functions to work.

I need to change the wireless zone numbers of my receivers.

Do the following:

- i. Return the receivers to factory default settings. See "Returning to factory default settings" on page 14.
- ii. Manually pair the receivers. Follow the steps in "Manual Pairing" on page 8.

All kinds of sounds from my computer are transmitted to the receiver.

Your transmitter streams all sounds from your computer to the receiver, including sounds from other programs, as well as system sounds and alerts. Disable these sounds, or close programs that generate unwanted sounds.

(For Sound Blaster X-Fi Notebook only)**When I switch my recording source from Mic In to Line In in Entertainment Mode, the wireless connection is lost.**

When the recording source is changed to Mic In, wireless music control is automatically disabled so that input from the microphone (for example, a private internet voice conversation) will not be unintentionally streamed to all paired receivers. After changing the recording source back to Line In, you must enable the wireless features again in Entertainment Mode.

General Specifications

Connectivity

- Audio Line Out - 3.5 mm (1/8") Stereo jack
- RCA Audio Line Out jacks

Power Adapter

- Supply Voltage: 5V +/- 5%
- Current: 1 A
- Power: 5 W

Radio Frequency (RF)

- Operating RF range: 2400 - 2483.5 MHz
- Number of RF channels: 3
- RF transmitter power output: 16 dBm (typical)

NOTE You cannot tune the RF channels.

Safety Information

Refer to the following information to use your product safely, and to reduce the chance of electric shock, short-circuiting, damage, fire, hearing impairment or other hazards.

Improper handling may void the warranty for your product. For more information, read the warranty available with your product.

- Read these instructions.
- Keep these instructions.
- Heed all warnings.
- Follow all instructions.
- Do not use this apparatus near water.
- Clean only with dry cloth.
- Do not block any ventilation openings. Install the product in accordance with the instructions.
- Do not install near heat sources such as radiators, heat registers, stoves, or other apparatus (including amplifiers) that produce heat.
- Do not expose your product to temperatures outside the range of 0°C to 40°C [32°F to 104°F].
- Do not pierce, crush or set fire to your product.
- Keep your product away from strong magnetic objects.
- Do not subject your product to excessive force or impact.
- Do not defeat the purpose of the polarized or grounding-type plug. A polarized plug has two blades with one wider than the other. A grounding type plug has two blades and a third grounding prong. The wide blade or the third prong are provided for your safety. If the provided plug does not fit into your outlet, consult an electrician for replacement of the obsolete outlet.
- Protect the power cord from being walked on or pinched particularly at plugs, convenience receptacles, and the point where they exit from the apparatus.
- Only use attachments/accessories specified by the manufacturer.
- Use only with the cart, stand, tripod, bracket or table specified by the manufacturer, or sold with the apparatus. When a cart is used, use caution when moving the cart/apparatus combination to avoid injury from tip-over.
- Unplug this apparatus during lightning storms or when unused for long periods of time.
- Do not dismantle or attempt to repair your product.

Refer all servicing to authorized and qualified service personnel. Servicing is required when the apparatus has been damaged in any way, such as power-supply cord or plug is damaged, liquid has been spilled or objects have fallen into the apparatus, the apparatus has been exposed to rain or moisture, does not operate normally, or has been dropped.

- **WARNING:** To reduce the risk of fire or electric shock, do not expose your product to water or moisture. If your product is moisture-resistant, take care not to immerse your product in water or expose it to rain.

Earphones

- When a conductive apparatus, such as earphones, is used in close proximity with a CRT television or CRT monitor, the latter may emit an electrostatic discharge. The electrostatic discharge can be felt as a static shock. While this static shock is usually harmless, it is good practice to avoid close contact with CRT devices when using earphones.
- Do not listen to audio on your earbuds or headphones at high volume for prolonged periods of time as hearing loss may result. For users in the United States, go to www.hei.org for more information.
- Do not listen to your audio device at high volume when driving, cycling or crossing the road, especially in heavy traffic, or in any other traffic condition where such use will hinder safe travel on the roads. We recommend that consumers be extremely cautious when using this device on the road.

Embedded Battery

- Do not attempt to remove the embedded battery. The product must be disposed of according to local environmental regulations. To replace the battery, return your product to your regional support office. For product service information, go to www.creative.com.

Removable Battery

- The battery must be recycled or disposed of properly. Contact local agencies for recycling and disposal information.
- Do not allow metal objects to touch the terminals of your battery.
- If there is leakage, an offensive odor, discoloration or deformation during charging or use, remove the battery and do not use it again. Clean your hands well before touching food or sensitive areas, for example, your eyes.

Wireless Device

- Switch off the device where it is prohibited, or when its use may cause danger or interference such as inside an aircraft, hospitals, or near refuelling points.

WEEE DIRECTIVE 2002/96/EC



The use of the WEEE Symbol indicates that this product may not be treated as household waste. By ensuring this product is disposed of correctly, you will help protect the environment. For more detailed information about the recycling of this product, please contact your local authority, your household waste disposal service provider or the shop where you purchased the product.

BATTERIES DIRECTIVE 2006/66/EC

For Removable Battery



This product may contain one or more of the following removable batteries:

Li-ion/polymer, button/coin cells, cylindrical cells. In this case, the following applies:

The crossed-out wheeled bin symbol indicates that the battery in this product should not be treated as unsorted municipal waste upon reaching its end of life. Instead it should be taken to separate collection and recycling schemes. Batteries containing heavy metal content will have a two-letter symbol for the chemical under the crossed-out wheeled bin symbol. 'Cd' stands for cadmium, 'Pb' for lead, and 'Hg' for mercury. You can help the environment and avoid public health hazards by recycling the battery at an authorized recycling facility or the place of purchase. To find the nearest authorized recycle centre contact your local authority. Instructions for removing the battery can be found in the product user manual. The instructions should be followed carefully before attempting to remove the battery.

For Integrated Battery

This product may contain a Lithium ion/polymer battery that should only be removed by an authorized recycling centre. By recycling this product at your local authorized recycling centre or the place of purchase, the battery will be removed and recycled separately.

Declaration of Conformity

According to the FCC96 208 and ET95-19

Manufacturer/Importer's Name: Creative Labs, Inc.
Manufacturer/Importer's Address: **1901 McCarthy Boulevard
Milpitas, CA. 95035
United States
Tel: (408) 428-6600**

declares under its sole responsibility that the product

Trade Name: **Creative Labs**
Model Numbers: **SB1122**

has been tested according to the FCC / CISPR22/97 requirement for Class B devices and found compliant with the following standards:

**EMI/EMC: ANSI C63.4 2003, FCC Part 15 , Subpart B & C
Complies with Canadian ICES-003 Class B, RSS-GEN & RSS-210**

This device complies with part 15 of the FCC Rules.

Operation is subject to the following two conditions:

- (1) This device may not cause harmful interference, and
- (2) This device must accept any interference received, including interference that may cause undesirable operation.

Ce matériel est conforme à la section 15 des règles FCC.

Son Fonctionnement est soumis aux deux conditions suivantes:

- (1) Le matériel ne peut être source D'interférences et
- (2) Doit accepter toutes les interférences reçues, Y compris celles pouvant provoquer un fonctionnement indésirable.

Compliance Manager
Creative Labs, Inc.
March 5th, 2009

Regulatory Information

Notice for the USA

FCC Part 15: This equipment has been tested and found to comply with the limits for a Class B digital device, pursuant to Part 15 of the FCC Rules. These limits are designed to provide reasonable protection against harmful interference in a residential installation. This equipment generates, uses and can radiate radio frequency energy and, if not installed and used in accordance with instructions, may cause harmful interference to radio communications. However, there is no guarantee that interference will not occur in a particular installation. If this equipment does cause harmful interference to radio or television reception, which can be determined by turning the equipment off and on, the user is encouraged to try to correct the interference by one or more of the following measures:

- Reorient or relocate the receiving antenna.
- Increase the separation between the equipment and receiver.
- Connect the equipment into an outlet on a circuit different from that to which the receiver is connected.
- Consult the dealer or an experienced radio/TV technician for help.

This device complies with part 15 of the FCC Rules. Operation is subject to the following two conditions:

- 1 This device may not cause harmful interference, and
- 2 This device must accept any interference received, including interference that may cause undesired operation.

CAUTION: To comply with the limits of the Class B digital device, pursuant to Part 15 of the FCC Rules, this device must be installed with computer equipment certified to comply with Class B limits.

All cables used to connect to the computer and peripherals must be shielded and grounded. Operation with non-certified computers or non-shielded cables may result in interference to radio or television reception.

MODIFICATION: Any changes or modifications not expressly approved by the grantee of this device could void the user's authority to operate the device.



WARNING: To satisfy FCC RF exposure requirements for mobile transmitting devices, a separation distance of 20 cm or more should be maintained between the antenna of this device and persons during device operation.

To ensure compliance, operations at closer than this distance is not recommended. The antenna used for this transmitter must not be co-located in conjunction with any other antenna or transmitter.

California Proposition 65 Statement

WARNING: Handling this product may expose you to chemicals known to the State of California to cause cancer and birth defects or other reproductive harm.

Wash hands after handling.

Explanatory Note: California Safe Drinking Water and Toxic Enforcement Act of 1986 (Proposition 65) requires special product labeling for products containing certain chemicals known to the State of California to cause cancer, birth defects or other reproductive harm. Creative has chosen to provide a warning based on its knowledge about the presence of one or more listed chemicals without attempting to evaluate the level of exposure. With Creative's products, the exposure may be below the Proposition 65 level of concern, or could even be zero. However, out of an abundance of caution, Creative has elected to place the Proposition 65 warning on its products.

Déclaration de la Proposition 65 de la Californie

AVERTISSEMENT: La manipulation de ce produit peut vous exposer à des produits chimiques qui sont reconnus par l'État de la Californie comme pouvant provoquer le cancer, des anomalies congénitales ou d'autres effets nuisibles à la reproduction.

Veillez vous laver les mains après l'avoir manipuler.

Note explicative: La Proposition 65 [California Safe Drinking Water and Toxic Enforcement Act of 1986] de la Californie sur les matières dangereuses et l'eau potable exige un étiquetage spécial pour les produits contenant certains produits chimiques qui sont reconnus par l'État de la Californie comme pouvant provoquer le cancer, des anomalies congénitales ou d'autres effets nuisibles à la reproduction. Creative a choisi d'inclure une mise en garde s'appuyant sur sa connaissance de la présence d'un ou de plusieurs de ces produits chimiques sans essayer d'en évaluer le niveau d'exposition. Pour les produits de Creative, le niveau d'exposition peut être inférieur au niveau critique établi par la Proposition 65 ou même être nul. Néanmoins, par souci extrême de prudence, Creative a choisi de placer l'avertissement de la Proposition 65 sur ses produits.

Notice for Canada

This Class B digital apparatus complies with Canadian ICES-003.

Operation is subject to the following two conditions:

- 1 This device may not cause harmful interference, and
- 2 This device must accept any interference received, including interference that may cause undesired operation.

Cet appareil numérique de la classe B est conforme à la norme NMB-003 du Canada.

CANADIAN CLASS B STATEMENT: This digital device does not exceed the Class B limits for radio noise emissions from digital apparatus as set out in the interference-causing equipment standard entitled "Digital Apparatus," ICES-003 of the Department of Communications.

Cet appareil numérique respecte les limites de bruits radioélectriques applicables aux appareils numériques de Classe B prescrites dans la norme sur le matériel brouilleur. "Appareils Numériques," NMB-003 édictée par le ministre des Communications.

MODIFICATION: Any changes or modifications not expressly approved by the grantee of this device could void the user's authority to operate the device.

Toute modification non approuvée explicitement par le fournisseur de licence de l'appareil peut entraîner l'annulation du droit de l'utilisateur à utiliser l'appareil.

European Compliance

This product conforms to the following:

EMC Directive 2004/108/EC.

Mains operated products for the European market comply with Low Voltage Directive 2006/95/EC.

Communication / RF wireless products for the European market comply with R&TTE Directive 1999/5/EC.

CAUTION: To comply with the Europe CE requirement, this device must be installed with CE certified computer equipment which meet with Class B limits.

All cables used to connect this device must be shielded, grounded and no longer than 3m in length. Operation with non-certified computers or incorrect cables may result in interference to other devices or undesired effects to the product.

MODIFICATION: Any changes or modifications not expressly approved by Creative Technology Limited or one of its affiliated companies could void the user's warranty and guarantee rights.

Information in this document is subject to change without notice and does not represent a commitment on the part of Creative Technology Ltd. No part of this manual may be reproduced or transmitted in any form or by any means, electronic or mechanical, including photocopying and recording, for any purpose without the written permission of Creative Technology Ltd.

Copyright © 2010 Creative Technology Ltd. All rights reserved. The Creative logo, Sound Blaster and X-Fi are trademarks or registered trademarks of Creative Technology Ltd. in the United States and/or other countries. iPod is a registered trademark of Apple Inc., registered in the U.S. and other countries.

Version 2.0

May 2010

Free Manuals Download Website

<http://myh66.com>

<http://usermanuals.us>

<http://www.somanuals.com>

<http://www.4manuals.cc>

<http://www.manual-lib.com>

<http://www.404manual.com>

<http://www.luxmanual.com>

<http://aubethermostatmanual.com>

Golf course search by state

<http://golfingnear.com>

Email search by domain

<http://emailbydomain.com>

Auto manuals search

<http://auto.somanuals.com>

TV manuals search

<http://tv.somanuals.com>