

Dell 1235cn

Multi Functional Printer User's Guide

www.dell.com | support.dell.com



features of your new laser printer

Your new printer is equipped with a number of special features that improve the quality of the documents you print. With the printer, you can:

SPECIAL FEATURES



Print with excellent quality and speed

- You can print in a full range of colors using cyan, magenta, yellow, and black.
- You can print with a resolution of up to 2400 x 600 dpi. See *Software section*.
- Your printer prints A4-sized paper at up to 16 ppm and letter-sized paper at up to 17 ppm. In Color mode, your printer prints A4-sized or letter sized paper at up to 4 ppm.

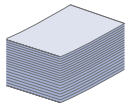

Handle many different types of printable material

- The 150-sheet tray supports plain paper in various sizes: letterhead, envelopes, labels, custom-sized media, postcards, and heavy paper.

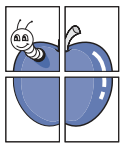

Create professional documents

- Print Watermarks. You can customize your documents with words, such as "Confidential". See *Software section*.
- Print Posters. The text and pictures of each page of your document are magnified and printed across the sheet of paper and can then be taped together to form a poster. See *Software section*.
- You can use preprinted forms and letterhead with plain paper. See *Software section*.



Save time and money

- To save paper, you can print multiple pages on one single sheet of paper.
- This printer automatically conserves electricity by substantially reducing power consumption when not in use.
- To save paper, you can print on both sides of the paper (double-sided printing). See *Software section*.



Print in various environments

- You can print with Windows 2000/XP/2003/Vista as well as Macintosh systems.
- Your printer is equipped with a USB interface and a network interface.

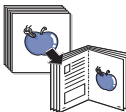

Copy originals in several formats

- Your printer can print multiple image copies from the original document on a single page.
- There are special functions to erase catalog and newspaper background.
- The print quality and image size may be adjusted and enhanced at the same time.

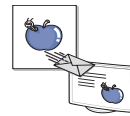

Scan the originals and send it right away

- Scan in color and use the precise compressions of JPEG, TIFF and PDF formats.
- Quickly scan and send files to multiple destinations using Networks scanning.

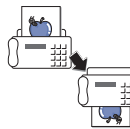

Set a specific time to transmit a Fax

- You can specify a certain time to transmit the fax and also send the fax to several stored destinations.
- After the transmission, the printer may print out the fax reports according to the setting.



ABOUT THIS USER'S GUIDE

This user's guide provides information about basic understanding of the printer as well as detailed explanation on each step during the actual usage. Both novice users and professional users can refer to this guide for installing and using the printer.

Some terms in this guide are used interchangeably, as below:



- Document is synonymous with original.
- Paper is synonymous with media, or print media.

Following table offers the conventions of this guide:

CONVENTION	DESCRIPTION	EXAMPLE
Bold	Used for texts on the display or actual prints on the printer.	Start
Note	Used to provide additional information or detailed specification of the printer function and feature.	 The date format may differ from country to country
Caution	Used to give users information to protect the printer from possible mechanical damage or malfunction.	 Do not touch the green underside of the toner cartridge.
Footnote	Used to provide more detailed information on certain words or a phrase.	a. pages per minute
(See page 1 for more information)	Used to guide users to the reference page for the additional detailed information.	(See page 1 for more information)



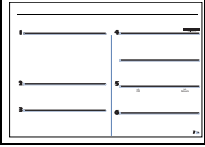
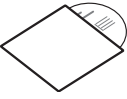







FINDING MORE INFORMATION

You can find information for setting up and using your printer from the following resources, either as a print-out or onscreen.















<p>Quick Install Guide</p> 	<p>Provides information on setting up your printer and this requires that you follow the instructions in the guide to prepare the printer.</p>
<p>Online User's Guide</p> 	<p>Provides you with step-by-step instructions for using your printer's full features, and contains information for maintaining your printer, troubleshooting, and installing accessories.</p> <p>This user's guide also contains a <i>Software section</i> to provide you with information on how to print documents with your printer in various operating systems, and how to use the included software utilities.</p> <p>Note You can access the user's guide in other languages from the Manual folder on the printer software CD.</p>
<p>Printer Driver Help</p> 	<p>Provides you with help information on printer driver properties and instructions for setting up the properties for printing. To access a printer driver help screen, click Help from the printer properties dialog box.</p>
<p>Dell website</p>	<p>If you have Internet access, you can get help, support, printer drivers, manuals, and order information from the Dell website, www.dell.com and support.dell.com.</p>

IMPORTANT SAFETY SYMBOLS AND PRECAUTIONS

What the icons and signs in this user's guide mean:

 WARNING	Hazards or unsafe practices that may result in severe personal injury or death.
 CAUTION	Hazards or unsafe practices that may result in minor personal injury or property damage.
 CAUTION	To reduce the risk of fire, explosion, electric shock, or personal injury when using your laser Multi-Function Printer (MFP), follow these basic safety precautions:
	Do NOT attempt.
	Do NOT disassemble.
	Do NOT touch.
	Follow directions explicitly.
	Unplug the power plug from the wall socket.
	Ensure the MFP is grounded to prevent electric shock.
	Call the service center for help.

These warning signs are here to prevent injury to you and others. Follow them explicitly. After reading this section, keep it in a safe place for future reference.

-  1. Read and understand all instructions.
-  2. Use common sense whenever operating electrical appliances.
-  3. Follow all warnings and instructions marked on the printer and in the literature accompanying the printer.
-  4. If an operating instruction appears to conflict with safety information, heed the safety information. You may have misunderstood the operating instruction. If you cannot resolve the conflict, contact your sales or service representative for assistance.
-  5. Unplug the printer from the AC wall socket and/or telephone jack before cleaning. Do not use liquid or aerosol cleaners. Use only a damp cloth for cleaning.
-  6. Do not place the printer on an unstable cart, stand or table. It may fall, causing serious damage.
-  7. Your printer should never be placed on, near or over a radiator, heater, air conditioner or ventilation duct.
-  8. Do not allow anything to rest on the power. Do not place your printer where the cords will be abused by persons walking on them.
-  9. Do not overload wall outlets and extension cords. This can diminish performance, and may result in the risk of fire or electric shock.
-  10. Do not allow pets to chew on the AC power, telephone or computer interface cords.
-  11. Never push objects of any kind into the printer through case or cabinet openings. They may touch dangerous voltage points, creating a risk of fire or shock. Never spill liquid of any kind onto or into the printer.
-    12. To reduce the risk of electric shock, do not disassemble the printer. Take it to a qualified service technician when repair work is required. Opening or removing covers may expose you to dangerous voltages or other risks. Incorrect reassembly could cause electric shock when the unit is subsequently used.



13. Unplug the printer from the telephone jack, computer and AC wall outlet and refer servicing to qualified service personnel under the following conditions:

- When any part of the power cord, plug or connecting cable is damaged or frayed.
- If liquid has been spilled into the printer.
- If the printer has been exposed to rain or water.
- If the printer does not operate properly after instructions have been followed.
- If the printer has been dropped, or the cabinet appears damaged.
- If the printer exhibits a sudden and distinct change in performance.



14. Adjust only those controls covered by the operating instructions. Improper adjustment of other controls may result in damage, and may require extensive work by a qualified service technician to restore the printer to normal operation.



15. Avoid using this printer during a lightning storm. There may be a remote risk of electric shock from lightning. If possible, unplug the AC power and telephone cord for the duration of the lightning storm.

16. The Power cord supplied with your printer should be used for safe operation. If you are using a cord which is longer than 2 m with 110 V printer, then it should be 16 AWG^a or bigger.

17. Use only No.26 AWG or larger telephone line cord.



18. SAVE THESE INSTRUCTIONS

19. This printer can be operated only in the country you have purchased (due to different voltage, telecommunication configuration and etc.).

a. AWG: American Wire Gauge

	2	Features of your new laser printer
	5	Safety information
INTRODUCTION	11	Printer overview
	11	Front view
	11	Rear view
	12	Control panel overview
	13	Understanding the Status LED
	13	Acknowledging the status of the toner cartridge
	14	Menu overview
	15	Supplied software
	15	Printer driver features
	15	Printer driver
GETTING STARTED	16	Setting up the hardware
	17	System requirements
	17	Microsoft® Windows®
	17	Macintosh
	18	Setting up the network
	18	Supported operation environments
	18	Configuring network protocol via the printer
	18	Using the SetIP program
	18	Installing the driver software
	19	
	20	Printer's basic settings
	20	Altitude adjustment
	20	Changing the display language
	20	Setting the date and time
	20	Changing the clock mode
	20	Changing the default mode
	20	Setting sounds
	21	Entering characters using the number keypad
	21	Using the save modes
	21	Auto continue
LOADING ORIGINALS AND PRINT MEDIA	23	Loading originals
	23	On the scanner glass
	23	In the ADF
	24	Selecting print media
	25	Specifications on print media
	26	Media sizes supported in each mode
	26	Guidelines for special print media
	27	Changing the size of the paper in the paper tray
	28	
	29	Printing on special print materials
	29	Feeding the print material manually
	29	Setting the paper size and type
COPYING	30	Copying
	30	Changing the settings for each copy
	30	Darkness
	30	Original Type
	30	Reduced or enlarged copy
	31	Changing the default copy settings

- 31 **ID card copying**
- 31 **Using special copy features**
 - 31 2-up or 4-up copying
 - 31 Poster copying
 - 32 Clone copying
 - 32 Erasing background images
 - 32 Gray enhance copying
- 32 **Setting copy timeout**

SCANNING

33

- 33 **Scanning basics**
- 33 **Scanning from the control panel**
 - 33 Setting scan information in Dell Scan Manager.
 - 33 Scanning to application programs
- 34 **Scanning by a network connection**
 - 34 Scanning to Email
- 35 **Changing the settings for each scan job**
- 35 **Changing the default scan settings**
- 35 **Setting up Address Book**
 - 35 Registering speed email numbers
 - 35 Configuring group email numbers
 - 35 Using Address Book entries
 - 35 Searching Address Book for an entry
 - 36 Printing Address Book

BASIC PRINTING

37

- 37 **Printing a document**
- 37 **Canceling a print job**

FAXING

38

- 38 **Sending a fax**
 - 38 Setting the fax header
 - 38 Adjusting the document settings
 - 39 Sending a fax automatically
 - 39 Sending a fax manually
 - 39 Confirming a transmission
 - 39 Automatic redialing
 - 39 Redialing the last number
 - 39 Sending a fax to multiple destinations
 - 40 Sending a delayed fax
 - 40 Sending a priority fax
- 41 **Receiving a fax**
 - 41 Changing receiving modes
 - 41 Receiving automatically in Fax mode
 - 41 Receiving manually in Tel mode
 - 41 Receiving manually using an extension telephone
 - 41 Receiving automatically in Ans/Fax mode
 - 41 Receiving faxes using DRPD mode
 - 42 Receiving in secure receiving mode
 - 42 Activating secure receiving mode
 - 42 Receiving faxes in memory
 - 42 Forwarding faxes
- 43 **Fax setup**
 - 43 Changing the fax setup options
 - 44 Changing the default document settings
 - 44 Printing sent fax report automatically

USING USB MEMORY DEVICE

46

- 44 Setting up Address Book
- 46 About USB memory**
- 46 Plugging in a USB memory device**
- 46 Scanning to a USB memory device**
 - 46 Scanning
 - 47 Customizing Scan to USB
- 47 Printing from a USB memory device**
 - 47 To print a document from a USB memory device:
- 47 Backing up data**
 - 47 Backing up data
 - 47 Restoring data
- 48 Managing USB memory**
 - 48 Deleting an image file
 - 48 Formatting a USB memory device
 - 48 Viewing the USB memory status
- 48 Printing directly from a digital camera**

MAINTENANCE

49

- 49 Printing reports**
 - 49 Printing a report
- 49 Adjusting the color contrast**
- 50 Clearing memory**
- 50 Cleaning your printer**
 - 50 Cleaning the outside
 - 50 Cleaning the inside
 - 52 Cleaning the scan unit
- 53 Maintaining the cartridge**
 - 53 Toner cartridge storage
 - 53 Expected cartridge life
 - 53 Redistributing toner
- 53 Replacing the toner cartridge**
- 55 Replacing the imaging unit**
- 56 Replacing the waste toner container**
- 57 Maintenance parts**
 - 57 Checking replaceables
- 57 Managing your printer from the website**
 - 57 To access Embedded Web Service:
- 57 Checking the printer's serial number**

TROUBLESHOOTING

58

- 58 Tips for avoiding paper jams**
- 58 Clearing document jams**
 - 58 Exit misfeed
 - 59 Roller misfeed
- 59 Clearing paper jams**
 - 59 In the tray 1
 - 59 In the fuser unit area
 - 60 In the paper exit area
- 62 Understanding display messages**
- 65 Solving other problems**
 - 65 Paper feeding
 - 65 Printing problems
 - 66 Printing quality problems
 - 68 Copying problems
 - 69 Scanning problems
 - 69 Dell Scan Manager problems
 - 70 Fax problems
 - 70 Common Windows problems

contents

	70	Common Macintosh problems
ORDERING SUPPLIES	71	Supplies
71	71	How to purchase
SPECIFICATIONS	72	General specifications
72	73	Printer specifications
	73	Scanner specifications
	73	Copier specifications
	74	Facsimile specifications
GLOSSARY		
75		
INDEX		
79		

introduction

These are the main components of your printer:

This chapter includes:

- Printer overview
- Control panel overview
- Understanding the Status LED
- Acknowledging the status of the toner cartridge
- Menu overview
- Supplied software
- Printer driver features

PRINTER OVERVIEW

Front view

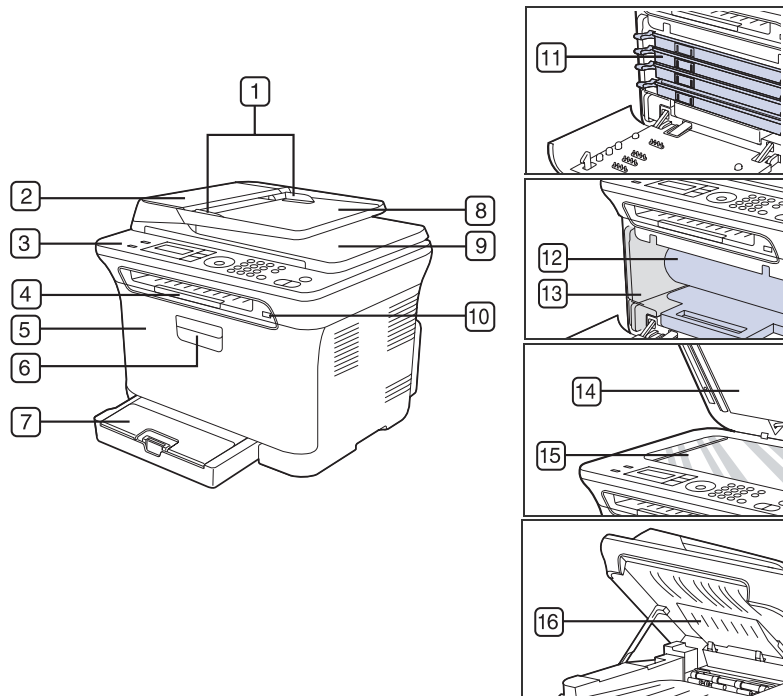

1	Document width guides	9	Document output tray
2	ADF	10	USB connector
3	Control panel	11	Toner cartridge
4	Output support	12	Imaging unit
5	Front cover	13	Waste toner container
6	Front cover handle	14	Scanner lid
7	Tray 1	15	Scanner glass
8	Document input tray	16	Scan unit

Rear view

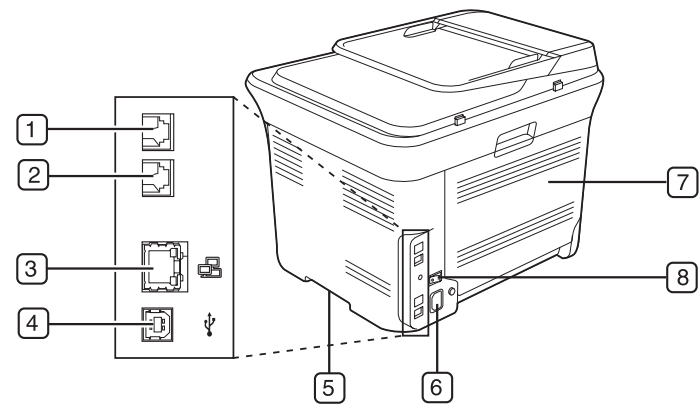

1	Extension telephone socket (EXT)	5	Handle
2	Telephone line socket	6	Power receptacle
3	Network port	7	Rear cover
4	USB port	8	Power switch

CONTROL PANEL OVERVIEW

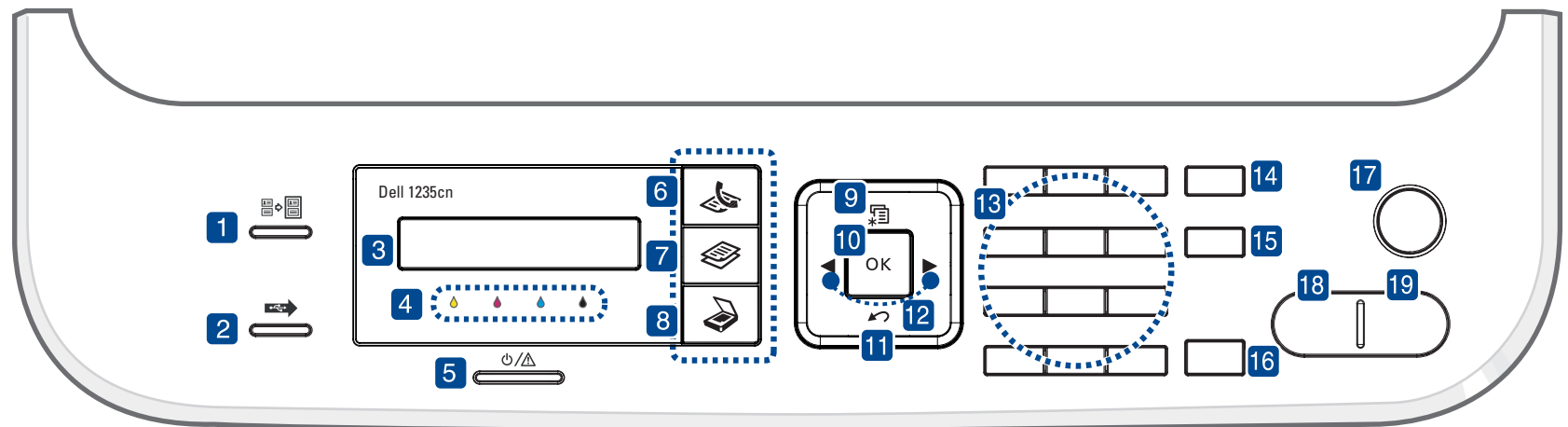

1 ID Copy	You can copy both sides of an ID card (e.g., driver's license) to a single side of paper. See "ID card copying" on page 31.
2 Direct USB	Allows you to directly print files stored on a USB Memory device when it is inserted into the USB connector on the front of your printer. See "About USB memory" on page 46.
3 Display	Shows the current status and prompts during an operation.
4 Toner colors	The toner colors shown below the LCD display co-works with the display messages. See Status LED with the toner cartridge messages. See "Acknowledging the status of the toner cartridge" on page 13.
5 Status	Shows the status of your printer. See "Understanding the Status LED" on page 13.
6 Fax	Activates Fax mode.
7 Copy	Activates Copy mode.
8 Scan/Email	Activates Scan mode.
9 Menu	Enters Menu mode and scrolls through the available menus.
10 OK	Confirms the selection on the screen.
11 Back	Sends you back to the upper menu level.
12 Left/right arrow	Scroll through the options available in the selected menu, and increase or decrease values. When entering characters, use right key to add empty space.
13 Number keypad	Dials a number or enters alphanumeric characters. See "Keypad letters and numbers" on page 21.
14 Address Book	Allows you to search for stored email addresses.
15 Redial/Pause	In ready mode, redials the last number, or in Edit mode, inserts a pause into a fax number.

16 On Hook Dial	Engages the telephone line.
17 Stop/Clear	Stops an operation at any time. In ready mode, clears/cancels the copy options, such as the darkness, the document type setting, the copy size, and the number of copies.
18 Black Start	Starts a job in Black and White mode.
19 Color Start	Starts a job in Color mode.

- All illustrations on this user's guide may differ from your printer depending on its options or models.
- The surface of the output tray may become hot if you print a large number of pages at once. Ensure that you do not touch the surface, and do not allow children near it.

UNDERSTANDING THE STATUS LED

The color of the **Status** LED indicates the printer's current status.

STATUS		DESCRIPTION
Off		<ul style="list-style-type: none">The printer is powered off-line.The printer is in power save mode. When data is received, or any button is pressed, it switches to on-line automatically.
Green	Blinking	<ul style="list-style-type: none">When the green LED blinks slowly, the printer is receiving data from the computer.When the green LED blinks rapidly, the printer is printing data.
	On	<ul style="list-style-type: none">The printer is powered on and can be used.
Red	Blinking	<ul style="list-style-type: none">A minor error has occurred and the printer is waiting for the error to be cleared. Check the display message, and solve the problem referring to "Understanding display messages" on page 62.The toner cartridge is low. Order a new toner cartridge, see "Ordering supplies" on page 71. You can temporarily improve print quality by redistributing the toner. See "Replacing the toner cartridge" on page 53.
	On	<ul style="list-style-type: none">A problem has occurred such as a paper jam, cover is open or no paper in the tray, so that the printer cannot continue the job. Check the message on the display, and see "Understanding display messages" on page 62 to solve the problem.The toner cartridge is empty, exhausted, or needs to be changed. See "Understanding display messages" on page 62.

 Always check the message on the display to solve the problem. The instruction in the Troubleshooting section will guide you to operate the printer properly. See "Understanding display messages" on page 62 for more information.

ACKNOWLEDGING THE STATUS OF THE TONER CARTRIDGE

The status of toner cartridges is indicated by the **Status** LED and the LCD display. If the toner cartridge is low or needs to be replaced, the **Status** LED turns red and the display shows the message. However the arrow mark shows which color toner is of concern or needs replacement with a new cartridge.

Example:



The above example shows the yellow cartridge status indicated by the arrow. Check the message to find out what the problem is and how to solve it. See "Understanding display messages" on page 62 for more information on error messages.

MENU OVERVIEW

The control panel provides access to various menus to set up the printer or use the printer's functions. These menus can be accessed by pressing **Menu**. Refer to the following diagram.



Some menus may not appear in the display depending on options or models. If so, it is not applicable to your printer.

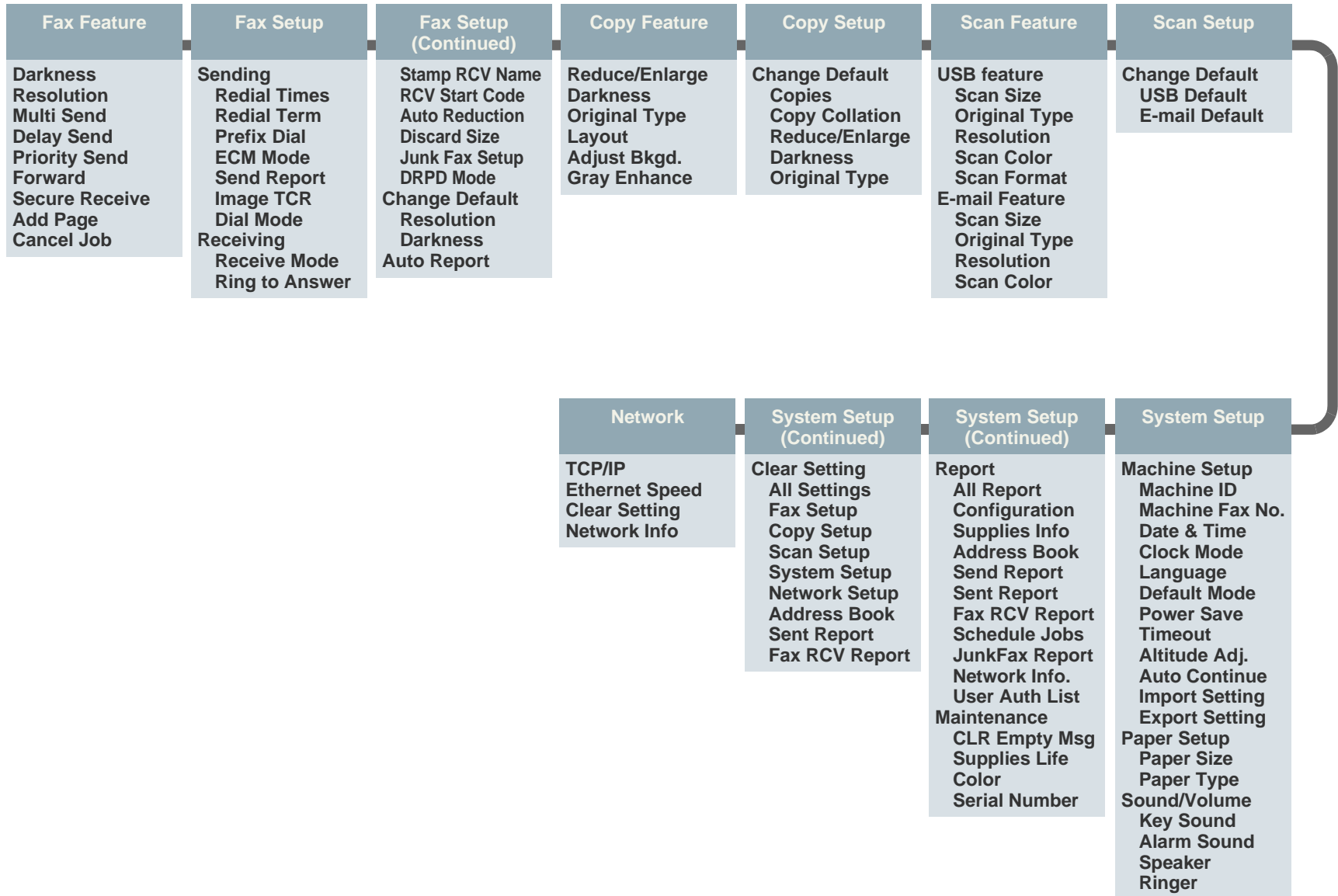

SUPPLIED SOFTWARE

You must install the printer software using the supplied CD to use your printer as a printer and a scanner, after you have set up your printer and connected it to your computer. The CD provides you with the following software.

CD	CONTENTS	
Printer software CD	Windows	<ul style="list-style-type: none"> • Printer driver: Use this driver to take full advantage of your printer's features. • Scanner driver: TWAIN and Windows Image Acquisition (WIA) drivers are available for scanning documents on your printer. • SmarThru^a: This is the accompanying Windows-based software for your multifunctional printer. • Dell Toner Management System™: Displays the status of the printer and the name of the job when you send a job to print. The Dell Toner Management System™ window also displays the level of toner remaining and allows you to order replacement toner cartridges. • Printer Setting Utility: This program allows you to set up printer's other options from your computer desktop. • Firmware Update Utility: This program helps you to update printer's firmware. • SetIP: Use this program to set your printer's TCP/IP addresses.
	Macintosh	<ul style="list-style-type: none"> • Printer driver: Use this driver to take full advantage of your printer's features. • Scanner driver: TWAIN driver is available for scanning documents on your printer. • Printer Setting Utility: This program allows you to set up printer's other options from your computer desktop.

a. Allows you to edit a scanned image in many ways using a powerful image editor and to send the image by email. You can also open another image editor program, like Adobe® Photoshop®, from SmarThru. For details, see the onscreen help supplied on the SmarThru program.

PRINTER DRIVER FEATURES

Your printer drivers support the following standard features:

- Paper orientation, size, source and media type selection
- Number of copies

In addition, you can use various special printing features. The following table shows a general overview of features supported by your printer drivers:

Printer driver

FEATURE	WINDOWS	MACINTOSH
Color mode	O	O
Printer quality option	O	O
Poster printing	O	X
Multiple pages per sheet (N-up)	O	O
Fit to page printing	O	O ^a
Scale printing	O	O
Watermark	O	X
Overlay	O	X

a. This feature is supported only MAC OS X 10.4 ~ 10.5.

getting started

This chapter gives you step-by-step instructions for setting up the printer.

This chapter includes:

- Setting up the hardware
- System requirements
- Setting up the network
- Printer's basic settings

SETTING UP THE HARDWARE

This section shows the steps to set up the hardware which is explained in the *Quick Install Guide*. Ensure you read *Quick Install Guide* and complete following steps.

1. Select a stable location.

Select a level, stable place with adequate space for air circulation. Allow extra space to open covers and trays.

The area should be well-ventilated and away from direct sunlight or sources of heat, cold, and humidity. Do not set the printer close to the edge of your desk or table.

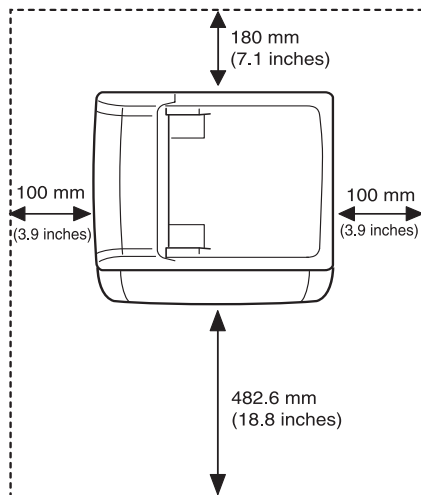

Printing is suitable for altitudes under 1,000 m (3,281 ft.). Refer to the altitude setting to optimize your printing. See "Altitude adjustment" on page 20 for more information.

Select a flat, stable surface so that the printer is not inclined greater than 2 mm (0.08 inch). Otherwise, printing quality may be affected.

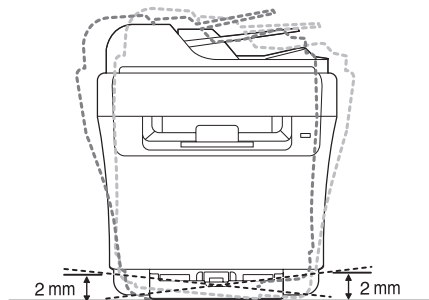

2. Unpack the printer and check all the enclosed items.
3. Remove the tape holding the printer tightly.
4. Load paper.

5. Ensure that all the cables are connected to the printer.
6. Turn the printer on.



When you move the printer, do not tilt or turn it upside down. Otherwise, the inside of the printer may be contaminated by toner, which can damage the printer or result in bad print quality.

SYSTEM REQUIREMENTS

Before you begin, ensure that your system meets the following requirements:

Microsoft® Windows®

Your printer supports the following Windows operating systems.

OPERATING SYSTEM	REQUIREMENT (RECOMMENDED)		
	CPU	RAM	FREE HDD SPACE
Windows 2000	Intel® Pentium® II 400 MHz (Intel Pentium III 933 MHz)	128 MB (256 MB)	600 MB
Windows XP	Intel Pentium III 933 MHz (Intel Pentium IV 1 GHz)	128 MB (256 MB)	1.5 GB
Windows Server 2003	Intel Pentium III 933 MHz (Intel Pentium IV 1 GHz)	128 MB (512 MB)	1.25 GB to 2 GB
Windows Vista®	Intel Pentium IV 3 GHz	512 MB (1024 MB)	15 GB
Windows Server 2008	Intel Pentium IV 1 GHz (Intel Pentium IV 2 GHz)	512 MB (2048 MB)	10 GB



- Internet Explorer 6.0 or higher is the minimum requirement for all Windows operating systems.
- Software installation can only be performed by users with Administrator rights.
- Windows Terminal Service is compatible with this printer.

Macintosh

OPERATING SYSTEM	REQUIREMENT (RECOMMENDED)		
	CPU	RAM	FREE HDD SPACE
Mac OS X 10.3 ~ 10.4	<ul style="list-style-type: none">• Intel Processor• Power PC G4/G5	<ul style="list-style-type: none">• 128 MB for a Power-PC based Mac (512 MB).• 512 MB for an Intel-based Mac (1 GB)	1 GB
Mac OS X 10.5	<ul style="list-style-type: none">• Intel Processor• 867 MHz or faster Power PC G4 /G5	512 MB (1 GB)	1 GB

SETTING UP THE NETWORK

You need to set up the network protocols on the printer to use it in the network environment. You can set up the basic network settings through the printer's control panel.

Supported operation environments

The following table shows the network environments supported by the printer:

ITEM	REQUIREMENTS
Network interface	<ul style="list-style-type: none">Ethernet 10/100 Base-TX
Network operating system	<ul style="list-style-type: none">Windows 2000/XP/2003/VistaMAC OS 10.3 ~ 10.5
Network protocols	<ul style="list-style-type: none">TCP/IPStandard TCP/IPLPRIPP/HTTPBonjourDHCPBOOTP

 If you are in a non-static IP address environment and need to setup a DHCP network protocol, go to the <http://developer.apple.com/networking/bonjour/download/>, select the program Bonjour for Windows compatible with your computer's operating system, and install the program. This program will allow you to fix the network parameter automatically. Follow the instruction in the installation window.

Configuring network protocol via the printer

To set up TCP/IP network parameters:

1. Ensure your printer is connected to the network with an RJ-45 Ethernet cable.
2. Ensure you have turned on the printer.
3. Press **Menu** on the control panel, until you see **Network** on the bottom line of the display and press **OK**.
4. Press the left/right arrow until **TCP/IP** appears and press **OK**.
5. Press the left/right arrow until **Static** appears and press **OK**.
6. Press the left/right arrow until **IP Address** appears and press **OK**. Enter a byte between 0 and 255 using the number keypad and press the left/right arrow to move between bytes. Repeat this to complete the address from the 1st byte to the 4th byte.
7. When you have finished, press **OK**. Repeat steps 6 and 7 to configure the other TCP/IP parameters: subnet mask and gateway address.

 Contact the network administrator if you are not sure how to configure.

 You can also set up the network settings through the network administration programs.

- **Embedded Web Service:** Web server embedded on your network print server, which allows you to:
 - Configure the network parameters necessary for the printer to connect to various network environments.
 - Customize printer settings.
- **SetIP:** Utility program that allows you to select a network interface and manually configure the IP addresses for use with the TCP/IP protocol. See "Using the SetIP program" on page 18.

Using the SetIP program



This program is for the network IP setting using the MAC address which is the hardware serial number of the network printer card or interface. Especially, it helps the network administrator set several network IPs at the same time.

-  You can only use SetIP program when your printer is connected to a network.
- The following procedure is based on Windows XP.

Installing the program

1. Insert the driver CD provided along with your machine. When the driver CD runs automatically, close the window.
2. Start Windows Explorer and open the X drive. (X represents your CDROM drive.)
3. Double-click **Application > SetIP**.
4. Double-click **Setup.exe** to install this program.
5. Click **OK**.
If necessary, select a language from the drop-down list.
6. Follow the instructions in the window and complete the installation.

Setting network values

1. Print the printer's network configuration report to find your printer's MAC address. See "Printing reports" on page 49.
2. From the Windows **Start** menu, select **All Programs → Dell → Dell printers → Dell 1235cn Color Laser MFP → SetIP**.
3. Click  to open the TCP/IP configuration window.
4. Enter the network card's MAC address, IP address, subnet mask, default gateway, and then click **Apply**.
 When you enter the MAC address, enter it without colon(:).
5. Click **OK**. The printer prints the network information. Confirm that the settings are correct.
6. Click **Exit**.

Installing the driver software

You have to install the printer software for printing. The software includes drivers, applications, and other user friendly programs. The following procedure is based on Windows XP. If you use Macintosh operating system, see the Software section.

-  The following procedure is applicable when the printer is being used as a network printer. If you want to connect your printer with a USB cable, refer to *Software section*.
- The procedure and popup window which appear during the installation may differ depending on the operating system, the printer feature, or the interface in use.

1. Connect the network cable to your printer.
2. Ensure that the network setup for your printer is completed. See "Setting up the network" on page 18. All applications should be closed on your computer before beginning installation.
3. Insert the Printer Software CD into your CD drive.
The CD should automatically run, and an installation window appears. If the installation window does not appear, click **Start** → **Run**. Type **X:\Setup.exe**, replacing "X" with the letter which represents your CD drive and click **OK**.
If you are running Windows Vista, click **Start** → **All Programs** → **Accessories** → **Run**, and type **X:\Setup.exe**.
If the **AutoPlay** window appears, click **Run Setup.exe** in **Install** or **run program** field, and click **Continue** in the **User Account Control** window.
4. Click **Next**.

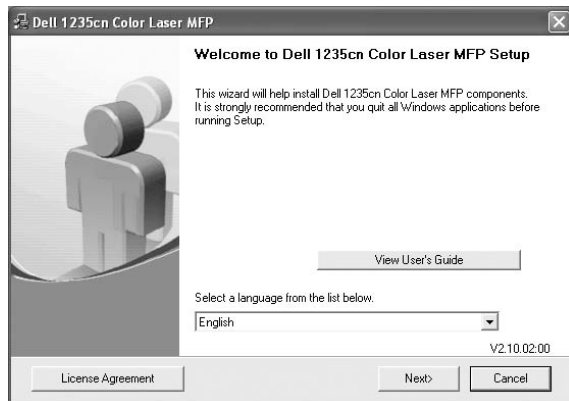

- The window shown above may differ slightly, if you are reinstalling the driver.
5. Select **Typical installation for a network printer**, and then click **Next**.

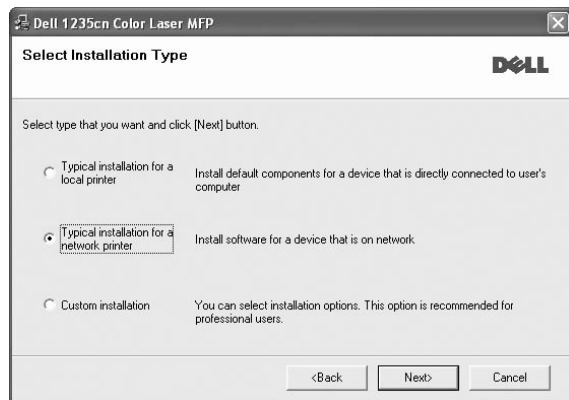

6. The list of printers available on the network appears. Select the printer you want to install from the list and then click **Next**.

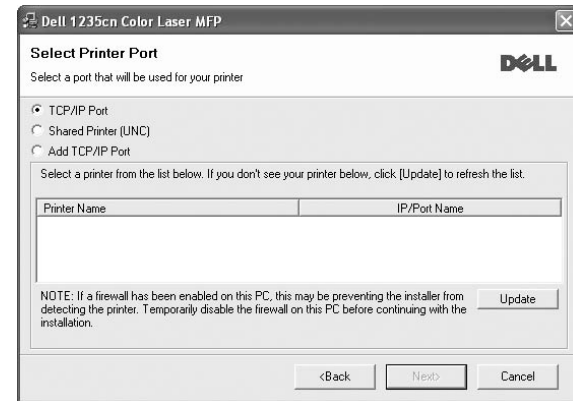

- If you do not see your printer on the list, click **Update** to refresh the list, or select **Add TCP/IP Port** to add your printer to the network. To add the printer to the network, enter the port name and the IP address for the printer.
 - To find a shared network printer (UNC Path), select **Shared Printer [UNC]** and enter the shared name manually or find a shared printer by clicking the **Browse** button.
 - ☞ If you are not sure of the IP address, contact your network administrator or print network information. See "Printing reports" on page 49.
7. After the installation is complete, a window appears asking you to print a test page. If you wish to do so, select the corresponding checkbox(es) and click **Finish**.
- ☞ • If your printer does not work properly after the installation, try to reinstall the printer driver. See *Software section* for more information.
 - During the printer driver installation process, the driver installer detects the location information for your operating system and sets the default paper size for your printer. If you use a different Windows location, you must change the paper size to match the paper you usually use. Go to printer properties to change the paper size after installation is complete.

PRINTER'S BASIC SETTINGS

After installation is complete, you may want to set the printer's default settings. Refer to the next section if you would like to set or change values.

Altitude adjustment

The print quality is affected by atmospheric pressure, which is determined by the height of the printer above sea level. The following information will guide you on how to set your printer for the best print quality or best quality of print.

Before you set the altitude value, find the altitude where you are using the printer.

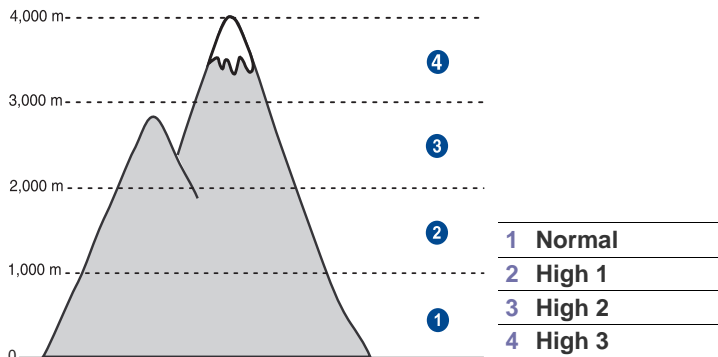

1. Click **Start** → **All Programs** → **Dell** → **Dell Printers** → **Dell 1235cn Color Laser MFP** → **Printer Setting Utility**. You can also click Printer Setting Utility on the status bar in Mac OS X.
2. Click **Setting** → **Altitude Adjustment**. Select the appropriate value from the dropdown list, and then click **Apply**.

 If your printer is connected to a network, **Embedded Web Service** screen appears automatically. Click **Machine Settings** → **Setup** (or **Machine Setup**) → **Adj.**. Select the appropriate altitude value, and then click **Apply**.

Changing the display language

To change the display language in the control panel:

1. Press **Menu** until **System Setup** appears on the bottom line of the display and press **OK**.
2. Press **OK** when **Machine Setup** appears.
3. Press the left/right arrow until **Language** appears and press **OK**.
4. Press the left/right arrow until the language you want appears and press **OK**.
5. Press **Stop/Clear** to return to ready mode.

Setting the date and time

The current date and time are shown on the display when your printer is on and ready to work. All of your faxes will have the date and time printed on them.

1. Press **Menu** until **System Setup** appears on the bottom line of the display and press **OK**.
2. Press **OK** when **Machine Setup** appears.
3. Press the left/right arrow until **Date & Time** appears and press **OK**.
4. Enter the correct time and date using the number keypad.
 - Month = 01 to 12
 - Day = 01 to 31
 - Year = requires four digits
 - Hour = 01 to 12 (12-hour mode)
00 to 23 (24-hour mode)
 - Minute = 00 to 59

 The date format may differ from country to country

You can also use the left/right arrow to move the cursor under the digit you want to correct and enter a new number.

5. To select **AM** or **PM** for 12-hour format, press the ***** or **#** button or any number button.

When the cursor is not under the AM or PM indicator, pressing the ***** or **#** button immediately moves the cursor to the indicator. You can change the clock mode to 24-hour format (e.g. 01:00 PM as 13:00). For details, see next section (Changing the clock mode).
6. Press **OK** to save the time and date.

When you enter a wrong number, **Out of Range** appears and the printer does not proceed to the next step. If this happens, re-enter the correct number.
7. Press **Stop/Clear** to return to ready mode.

Changing the clock mode

You can set your printer to display the current time in either a 12-hour or 24-hour format.

1. Press **Menu** until **System Setup** appears on the bottom line of the display and press **OK**.
2. Press **OK** when **Machine Setup** appears.
3. Press the left/right arrow until **Clock Mode** appears and press **OK**.
4. Press the left/right arrow to select the other mode and press **OK**.
5. Press **Stop/Clear** to return to ready mode.

Changing the default mode

Your printer is preset to Copy mode. You can switch this default mode between Fax mode and Copy mode.

1. Press **Menu** until **System Setup** appears on the bottom line of the display and press **OK**.
2. Press **OK** when **Machine Setup** appears.
3. Press the left/right arrow until **Default Mode** appears and press **OK**.
4. Press the left/right arrow until the default mode you want appears and press **OK**.
5. Press **Stop/Clear** to return to ready mode.

Setting sounds

You can control the following sounds:

- **Key Sound:** Turns the key sound on or off. With this option set to **On**, a tone sounds each time a key is pressed.

- **Alarm Sound:** Turns the alarm sound on or off. With this option set to **On**, an alarm tone sounds when an error occurs or fax communication ends.
- **Speaker:** Turns on or off the sounds from the telephone line through the speaker, such as a dial tone or a fax tone. With this option set to **Comm.** which means "Common," the speaker is on until the remote printer answers.



You can adjust the volume level using **On Hook Dial**.

- **Ringer:** Adjusts the ringer volume. For the ringer volume, you can select **Off**, **Low**, **Mid**, and **High**.

Speaker, ringer, key sound, and alarm sound

1. Press **Menu** until **System Setup** appears on the bottom line of the display and press **OK**.
2. Press the left/right arrow until **Sound/Volume** appears and press **OK**.
3. Press the left/right arrow until the sound option you want appears and press **OK**.
4. Press the left/right arrow until the desired status or volume for the sound you have selected appears and press **OK**.
5. If necessary, repeat steps 3 through 5 to set other sounds.
6. Press **Stop/Clear** to return to ready mode.

Speaker volume for On Hook Dial



You can adjust the speaker volume only when the telephone line is connected.

1. Press **On Hook Dial**. A dial tone sounds from the speaker.
2. Press the left/right arrow until you hear the volume you want.
3. Press **Stop/Clear** to save the change and return to ready mode.

Entering characters using the number keypad

As you perform various tasks, you may need to enter names and numbers. For example, when you set up your printer, you enter your name or your company's name, and the fax number. When you store fax numbers or email addresses in memory, you may also enter the corresponding names.

Entering alphanumeric characters

1. When you are prompted to enter a letter, locate the button labeled with the character you want. Press the button until the correct letter appears on the display.
For example, to enter the letter **O**, press **6**, labeled with **MNO**. Each time you press **6**, the display shows a different letter, **M**, **N**, **O**, **m**, **n**, **o** and finally **6**. You can enter special characters, such as space, plus sign, and etc. For details, see the below section.
2. To enter additional letters, repeat step 1.
If the next letter is printed on the same button, move the cursor by pressing the left/right arrow button and then press the button labeled with the letter you want. The cursor will move to the right and the next letter will appear on the display.
You can enter a space by pressing **1** twice.
3. When you have finished entering letters, press **OK**.

Keypad letters and numbers

KEY	ASSIGNED NUMBERS, LETTERS, OR CHARACTERS
1	@ / . ' 1

KEY	ASSIGNED NUMBERS, LETTERS, OR CHARACTERS
2	A B C a b c 2
3	D E F d e f 3
4	G H I g h i 4
5	J K L j k l 5
6	M N O m n o 6
7	P Q R S p q r s 7
8	T U V t u v 8
9	W X Y Z w x y z 9
0	+ - , & 0
*	*
#	#

Correcting numbers or names

If you make a mistake while entering a number or name, press the left/right arrow button to delete the last digit or character. Then enter the correct number or character.

Inserting a pause

With some telephone systems, you must dial an access code (9, for example) and listen for a second dial tone. In such cases, you must insert a pause in the telephone number. You can insert a pause while you are setting up speed dial numbers.

To insert a pause, press **Redial/Pause** at the appropriate place while entering the telephone number. A - appears on the display at the corresponding location.

Using the save modes

Power Save mode

Power Save mode allows your printer to reduce power consumption when it is not in actual use. You can turn this mode on and select a length of time for which the printer waits after a job is printed before it switches to a reduced power state.

1. Press **Menu** until **System Setup** appears on the bottom line of the display and press **OK**.
2. Press **OK** when **Machine Setup** appears.
3. Press the left/right arrow until **Power Save** appears and press **OK**.
4. Press the left/right arrow until the time setting you want appears and press **OK**.
5. Press **Stop/Clear** to return to ready mode.

Auto continue

This option allows you to set the printer to continue printing or not, in case the paper size you have set and the paper within the tray mismatches.

1. Press **Menu** until **System Setup** appears on the bottom line of the display and press **OK**.
2. Press **OK** when **Machine Setup** appears.
3. Press the left/right arrow until **Auto Continue** appears and press **OK**.
4. Press the left/right arrow until the binding option you want appears.
 - **On:** Automatically prints after set time passes, when the paper size

mismatches the tray paper size.

- **Off:** Waits until you press **Black Start** or **Color Start** on the control panel, when the paper size mismatches the tray paper size.
5. Press **OK** to save your selection.
 6. Press **Stop/Clear** to return to ready mode.

loading originals and print media

This chapter introduces you to loading originals and print media into your printer.

This chapter includes:

- Loading originals
- Selecting print media
- Changing the size of the paper in the paper tray

LOADING ORIGINALS

You can use the scanner glass or ADF to load an original for copying, scanning, and sending a fax.

On the scanner glass

Ensure that no originals are in the ADF. If an original is detected in the ADF, the printer gives it priority over the original on the scanner glass. To get the best scan quality, especially for colored or gray-scaled images, use the scanner glass.

1. Lift and open the scanner lid.

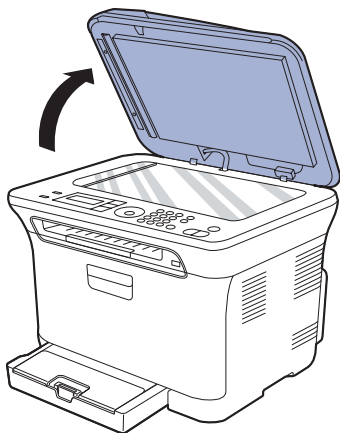

2. Place the original face down on the scanner glass and align it with the registration guide at the top left corner of the glass.

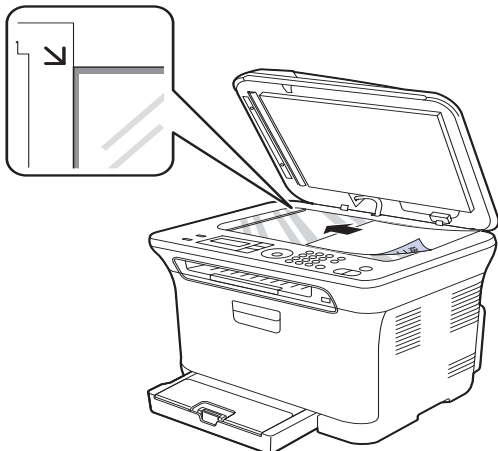

- Printing on special print materials
- Setting the paper size and type

3. Close the scanner lid.

- ⚠ Be careful not to break the scan glass. You may get hurt.
- Be careful not to let the scan cover fall over your hands. You may get hurt.
- When scanning or copying, do not look at the light inside the scanner. It is harmful for your eyes and it can be dangerous.
- 📄 Leaving the scanner lid open while copying may affect copy quality and toner consumption.
- Dust on the scanner glass may cause black spots on the printout. Always keep the scanner glass clean.
- If you are copying a page from a book or magazine, lift the scanner lid until its hinges are caught by the stopper and then close the lid. If the book or magazine is thicker than 30 mm, start copying with the lid open.

In the ADF

Using the ADF, you can load up to 15 sheets of paper (75 g/m², 20 lb bond) for one job.

When you use the ADF:

- In the ADF: Do not load paper smaller than 142 x 148 mm (5.6 x 5.8 inches) or larger than 216 x 356 mm (8.5 x 14 inches).
 - Do not attempt to load the following types of paper:
 - carbon-paper or carbon-backed paper
 - coated paper
 - onion skin or thin paper
 - wrinkled or creased paper
 - curled or rolled paper
 - torn paper
 - Remove all staples and paper clips before loading.
 - Ensure any glue, ink, or correction fluid on the paper is completely dry before loading.
 - Do not load originals that include different sizes or weights of paper.
 - Do not load booklets, pamphlets, transparencies, or documents having other unusual characteristics.
1. Flex or fan the edge of the paper stack to separate the pages before loading originals.

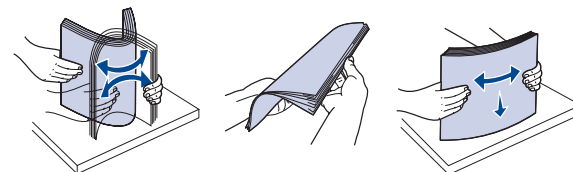

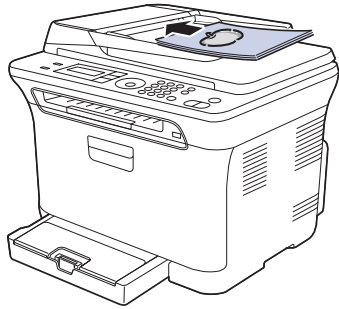

2. Load the original face up into the ADF. Ensure that the bottom of the original stack matches the paper size marked on the document input tray.

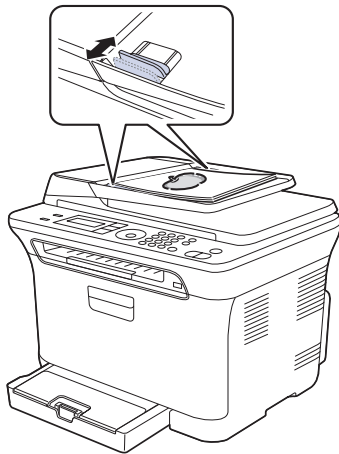

3. Adjust the document width guides to the paper size.



 Dust on the ADF glass may cause black lines on the printout. Always keep the ADF glass clean.

 Be careful not to put your hands in the ADF roller. You may get hurt.

SELECTING PRINT MEDIA

You can print on a variety of print media, such as plain paper, envelopes, labels, and transparencies. Always use print media that meet the guidelines for use with your printer. Print media that does not meet the guidelines outlined in this user's guide may cause the following problems:

- Poor print quality
- Increased paper jams
- Premature wear on the printer.

Properties, such as weight, composition, grain, and moisture content, are important factors that affect the printer's performance and the output quality. When you choose print materials, consider the following:

- The type, size and weight of the print media for your printer are described later in this section.
- Desired outcome: The print media you choose should be appropriate for your project.
- Brightness: Some print media are whiter than others and produce sharper, more vibrant images.
- Surface smoothness: The smoothness of the print media affects how crisp the printing looks on the paper.
-  • Some print media may meet all of the guidelines in this section and still not produce satisfactory results. This may be the result of improper handling, unacceptable temperature and humidity levels, or other variables over which Dell has no control.
- Before purchasing large quantities of print media, ensure that it meets the requirements specified in this user's guide.

 Using print media that does not meet these specifications may cause problems, requiring repairs. Such repairs are not covered by Dell's warranty or service agreements.

 Ensure that you do not use the inkjet photo paper with this printer. It could cause damage to the printer.

Specifications on print media

TYPE	SIZE	DIMENSIONS	WEIGHT ^A	CAPACITY ^B
Plain paper	Letter	216 x 279 mm (8.5 x 11 inches)	60 to 105 g/m ² (16 to 28 lb bond)	<ul style="list-style-type: none"> 150 sheets of 75 g/m² (20 lb bond) paper for the tray
	Legal	216 x 356 mm (8.5 x 14 inches)		
	US Folio	216 x 330 mm (8.5 x 13 inches)		
	A4	210 x 297 mm (8.26 x 11.69 inches)		
	Oficio	216 x 343 mm (8.5 x 13.5 inches)		
	JIS B5	182 x 257 mm (7.16 x 10.11 inches)		
	ISO B5	176 x 250 mm (6.93 x 9.84 inches)		
	Executive	184 x 267 mm (7.25 x 10.5 inches)		
	Statement	140 x 216 mm (5.5 x 8.5 inches)		
	A5	148 x 210 mm (5.82 x 8.26 inches)		
	A6	105 x 148 mm (4.13 x 5.82 inches)		
Envelope	Envelope Monarch	98 x 191 mm (3.87 x 7.5 inches)	75 to 90 g/m ² (20 to 24 lb bond)	5 sheet for manual feeding in the tray
	Envelope 6 3/4	92 x 165 mm (3.62 x 6.5 inches)		
	Envelope No. 10	105 x 241 mm (4.12 x 9.5 inches)		
	Envelope No. 9	98 x 225 mm (3.87 x 8.87 inches)		
	Envelope DL	110 x 220 mm (4.33 x 8.66 inches)		
	Envelope C5	162 x 229 mm (6.37 x 9.01 inches)		
	Envelope C6	114 x 162 mm (4.48 x 6.38 inches)		
Thick paper	See to the Plain paper section	See to the Plain paper section	90 to 105 g/m ² (24 to 28 lb bond)	5 sheet for manual feeding in the tray
Thin paper	See to the Plain paper section	See to the Plain paper section	60 to 70 g/m ² (16 to 19 lb bond)	
Labels ^c	Letter, A4	See to the Plain paper section	120 to 150 g/m ² (37 to 40 lb bond)	
Card stock	Post card	101.6 x 152.4 mm (4 x 6 inches)	105 to 163 g/m ² (28 to 43 lb bond)	
Transparency ^d	Letter, A4	See to the Plain paper section	138 to 146 g/m ² (37 to 39 lb bond)	
Glossy paper	Letter, A4	See to the Plain paper section	160 g/m ² (44 lb bond)	1 sheet for manual feeding in the tray
Minimum size (custom)		76 x 160 mm (3 x 6.3 inches)	60 to 163 g/m ² (16 to 43 lb bond)	
Maximum size (custom)		216 x 356 mm (8.5 x 14 inches)		

a. If media weight is over 105 g/m² (28 lb bond), load a paper into the tray one by one.

b. Maximum capacity may differ depending on media weight, thickness, and environmental conditions.

c. Smoothness: 100 to 250 (sheffield)

d. Recommended media: Transparency for a Color Laser Printers by 3M such as PP2500.

Media sizes supported in each mode

MODE	SIZE	SOURCE
Copy mode	Letter, A4, Legal, Oficio, US Folio, Executive, JIS B5, A5, A6	tray 1
Print mode	All sizes supported by the printer	tray 1
Fax mode	Letter, A4, Legal	tray 1

Guidelines for special print media

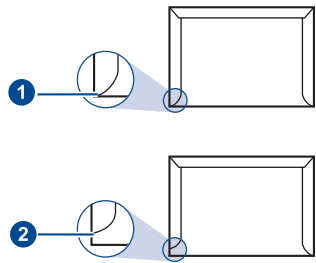
MEDIA TYPE	GUIDELINES
Envelopes	<ul style="list-style-type: none"> Successful printing on envelopes depends upon the quality of the envelopes. When selecting envelopes, consider the following factors: <ul style="list-style-type: none"> Weight: The weight of the envelope paper should not exceed 90 g/m² or jamming may occur. Construction: Prior to printing, envelopes should lie flat with less than 6 mm curl, and should not contain air. Condition: Envelopes should not be wrinkled, nicked, or otherwise damaged. Temperature: You should use envelopes that are compatible with the heat and pressure of the printer during operation. Use only well-constructed envelopes with sharp and well creased folds. Do not use stamped envelopes. Do not use envelopes with clasps, snaps, windows, coated lining, self-adhesive seals, or other synthetic materials. Do not use damaged or poorly made envelopes. Ensure that the seam at both ends of the envelope extends all the way to the corner of the envelope.  <p>1 Acceptable 2 Unacceptable</p>

MEDIA TYPE	GUIDELINES
Envelopes (Continued)	<ul style="list-style-type: none"> Envelopes with a peel-off adhesive strip or with more than one flap that folds over to seal must use adhesives compatible with the printer's fusing temperature for 0.1 second. Check your printer's specification to view the fusing temperature, see "Printer specifications" on page 73. The extra flaps and strips might cause wrinkling, creasing, or jams, and may even damage the fuser. For the best print quality, position margins no closer than 15 mm from the edges of the envelope. Avoid printing over the area where the envelope's seams meet.
Labels	<ul style="list-style-type: none"> To avoid damaging the printer, use only labels designed for use in laser printers. <ul style="list-style-type: none"> When selecting labels, consider the following factors: <ul style="list-style-type: none"> Adhesives: The adhesive material should be stable at your printer's fusing temperature. Check your printer's specification to know the fusing temperature, see "General specifications" on page 72. Arrangement: Only use labels with no exposed backing between them. Labels can peel off sheets that have spaces between the labels, causing serious jams. Curl: Prior to printing, labels must lie flat with no more than 13 mm of curl in any direction. Condition: Do not use labels with wrinkles, bubbles, or other indications of separation. Ensure that there is no exposed adhesive material between labels. Exposed areas can cause labels to peel off during printing, which can cause paper jams. Exposed adhesive can also cause damage to printer components. Do not run a sheet of labels through the printer more than once. The adhesive backing is designed for only a single pass through the printer. Do not use labels that are separating from the backing sheet or are wrinkled, bubbled, or otherwise damaged.
Card stock or custom-sized materials	<ul style="list-style-type: none"> Do not print on media smaller than 76 mm wide or 356 mm long. In the software application, set margins at least 6.4 mm away from the edges of the material.

MEDIA TYPE	GUIDELINES
Preprinted paper	<ul style="list-style-type: none"> • Letterhead must be printed with heat-resistant ink that will not melt, vaporize, or release hazardous emissions when subjected to the printer's fusing temperature for 0.1 second. Check your printer's specification to know the fusing temperature, see "General specifications" on page 72. • Letterhead ink must be non-flammable and should not adversely affect printer rollers. • Forms and letterhead should be sealed in a moisture-proof wrapping to prevent changes during storage. • Before you load preprinted paper, such as forms and letterhead, verify that the ink on the paper is dry. During the fusing process, wet ink can come off preprinted paper, reducing print quality.

 Using photographic paper or coated paper may cause problems, requiring repairs. Such repairs are not covered by Dell's warranty or service agreements.

CHANGING THE SIZE OF THE PAPER IN THE PAPER TRAY

To load longer sizes of paper, such as Legal-sized paper, you need to adjust the paper guides to extend the paper tray.

To change the tray 1 size to other size, you must adjust the paper length guide properly.

1. Pull the tray 1 out of the printer. Open the paper cover and remove paper from the tray 1 if necessary.
2. Pressing and unlatching the guide lock in the top of the tray, pull the tray out manually.

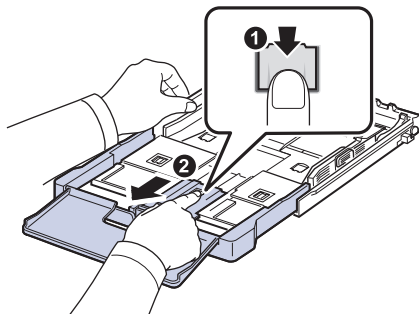

3. Load paper into the tray.

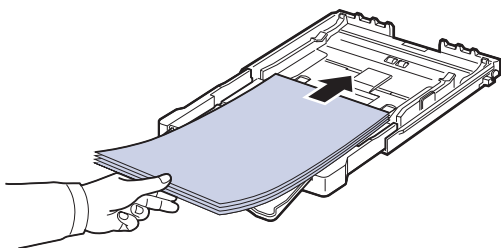

4. Slide the paper length guide until it lightly touches the end of the paper stack. Squeeze the paper width guide and slide it to the edge of the paper stack without causing it to bend.

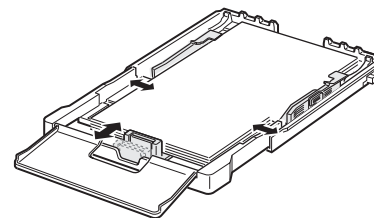

For paper smaller than Letter-sized, return the paper guides to their original positions and adjust the paper length guide and paper width guide.

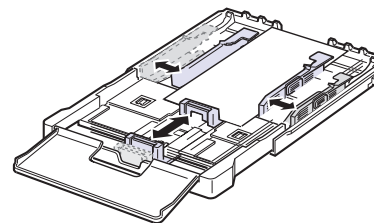

If the paper that you need to print is shorter than length 222 mm (8.74 inches), press and unlatch the guide lock in the tray, push the tray in manually. Adjust the paper length guide and paper width guide.

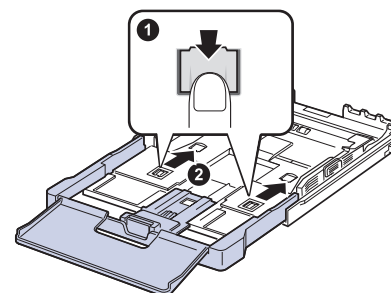

-  Do not push the paper width guides far enough to cause the materials to warp.
- If you do not adjust the paper width guides, it may cause paper jams.

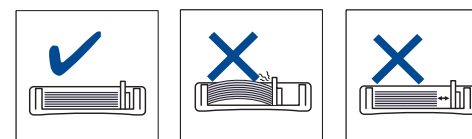

5. Close the paper cover.

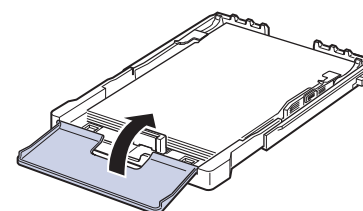

6. Slide the tray 1 back into the printer.
 7. After loading paper, set the paper type and size for the tray. See "Setting the paper size and type" on page 29.
- Due to insufficient paper in the tray, the paper length guide moves inward, load the tray with enough paper.
 - If you experience problems with paper feed, load a paper into the tray one by one.
 - You can load previously printed paper. The printed side should be facing up with an uncurled edge at the front. If you experience problems with paper feed, turn the paper around. Note that print quality is not guaranteed.

The tray is preset to Letter or A4 size, depending on your country. To change the size to A4 or Letter, you must adjust the lever and paper width guide properly.

- 1 Pull the tray out of the printer. Open the paper cover and remove paper from the tray if necessary.
- 2 If you want to change the size to Letter, hold the lever at the back of the tray, and rotate the lever clockwise.

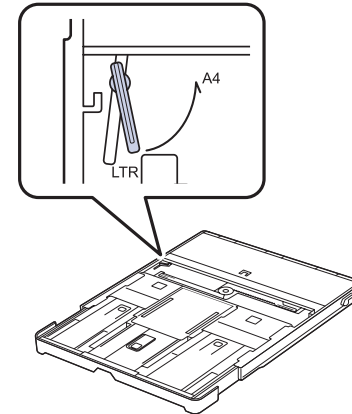

- 3 Squeeze the paper width guide and slide it to the edge of the lever.

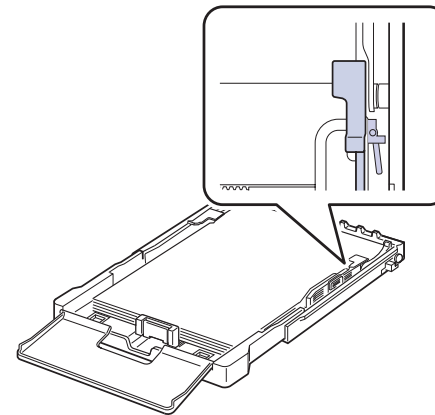



- If you want to change the size to A4, first move the paper width guide to left and rotate the lever counterclockwise. If you force the lever, it could damage the tray.

PRINTING ON SPECIAL PRINT MATERIALS

The printer can hold special sizes and types of print material, such as postcards, note cards, and envelopes. Especially, it is useful for single page printing on letterhead or colored paper.

Feeding the print material manually

- Load only one size of print media at a time in the tray.
 - To prevent paper jams, do not add paper when there is still paper in the tray. This also applies to other types of print media.
 - Print media should be loaded face up with the side you want to print, and the top edge going into the tray first. Place print materials in the center of the tray.
 - Always load only the specified print media to avoid paper jams and print quality problems. See "Selecting print media" on page 24.
 - Flatten any curl on postcards, envelopes, and labels before loading them into the tray.
1. Load the paper. See "Changing the size of the paper in the paper tray" on page 27.
-  Depending on the media type you are using, keep the following loading guidelines:
- Envelopes: Flap side down and with the stamp area on the top left side.
 - Labels: Print side up and top short edge entering the printer first.
 - Preprinted paper: Design side up with the top edge toward the printer.
 - Card stock: Print side up and the short edge entering the printer first.
 - Previously printed paper: Previously printed side down with an uncurled edge toward the printer.
2. When you print in an application, start the print menu.
 3. Before you print, open printer properties.
 4. Press the **Paper** tab in printer properties, and select an appropriate paper type.
-  If you want to use a label, set the paper type to **Label**.
5. Select **Manual Feeder** in paper source, then press **OK**.
 6. Start printing in the application.
 7. Press the **Color Start** or **Black Start** button on the printer to start feeding, then the printer starts printing.
-  • If you are printing multiple pages, load the next sheet after first page prints out, and press the **Color Start** or **Black Start** button. Repeat this step for every page to be printed.
- The settings you change remain in effect only while you are using the current application.

SETTING THE PAPER SIZE AND TYPE

After loading paper in the paper tray, you need to set the paper size and type using the control panel buttons. These settings will apply to Copy and Fax modes. For computer-printing, you need to select the paper size and type in the application you use on your computer.

1. Press **Menu** until **System Setup** appears on the bottom line of the display and press **OK**.
2. Press the left/right arrow until **Paper Setup** appears and press **OK**.
3. Press **OK** when **Paper Size** appears.
4. Press the left/right arrow until the paper size you are using appears and press **OK**.
5. Press the left/right arrow until **Paper Type** appears and press **OK**.
6. Press the left/right arrow until the paper type you are using appears and press **OK**.
7. Press **Stop/Clear** to return to ready mode.

 If you want to use special sized paper such as billing paper, select **Custom** in the **Paper** tab in the printer properties. See Software section.

copying

This chapter gives you step-by-step instructions for copying documents.

This chapter includes:

- Copying
- Changing the settings for each copy
- Changing the default copy settings

COPYING

1. Press **Copy**.
Ready to Copy appears on the top line of the display.
2. Load originals face up into the ADF, or place a single original face down on the scanner glass.
For details about loading an original. See "Loading originals" on page 23.
3. Enter the number of copies using the number keypad, if necessary.
4. If you want to customize the copy settings including copy size, darkness, and original type, by using the control panel buttons. See "Changing the settings for each copy" on page 30.
If necessary, you can use special copy features, such as 2-up or 4-up copying.
5. Press **Color Start** to begin color copying.
Or, press **Black Start** to begin black and white copying.

 You can cancel the copy job during an operation. Press **Stop/Clear**, and the copying will stop.

CHANGING THE SETTINGS FOR EACH COPY

Your printer provides default settings for copying so that you can quickly and easily make a copy. However, if you want to change the options for each copy, use the copy function buttons on the control panel.

 If you press **Stop/Clear** while setting the copy options, all of the options you have set for the current copy job will be canceled and returned to their default status. Or, they will automatically return to their default status after the printer completes the copy in progress.

Darkness

If you have an original containing faint markings and dark images, you can adjust the brightness to make a copy that is easier to read.

1. Press **Copy**.
2. Press **Menu** until **Copy Feature** appears on the bottom line of the display and press **OK**.
3. Press the left/right arrow until **Darkness** appears and press **OK**.
4. Press the left/right arrow until the contrast mode you want appears and press **OK**.
 - **Light:** Works well with dark print.
 - **Normal:** Works well with standard typed or printed originals.
 - **Dark:** Works well with light print.
5. Press **Stop/Clear** to return to ready mode.

- Using special copy features
- Setting copy timeout

Original Type

The original type setting is used to improve the copy quality by selecting the document type for the current copy job.

1. Press **Copy**.
2. Press **Menu** until **Copy Feature** appears on the bottom line of the display and press **OK**.
3. Press the left/right arrow until **Original Type** appears and press **OK**.
4. Press the left/right arrow until the image mode you want appears and press **OK**.
 - **Text:** Use for originals containing mostly text.
 - **Text/Photo:** Use for originals with mixed text and photographs.
 - **Photo:** Use when the originals are photographs.
 - **Magazine:** Use when the originals are magazines.
5. Press **Stop/Clear** to return to ready mode.

Reduced or enlarged copy

You can reduce or enlarge the size of a copied image from 25% to 400% when you copy original documents from the scanner glass, or from 25% to 100% from the ADF.

To select from the predefined copy sizes:

1. Press **Copy**.
2. Press **Menu** until **Copy Feature** appears on the bottom line of the display and press **OK**.
3. Press the left/right arrow until **Reduce/Enlarge** appears and press **OK**.
4. Press the left/right arrow until the size setting you want appears and press **OK**.

To scale the copy by directly entering the scale rate:

1. Press **Copy**.
2. Press **Menu** until **Copy Feature** appears on the bottom line of the display and press **OK**.
3. Press the left/right arrow until **Reduce/Enlarge** appears and press **OK**.
4. Press the left/right arrow until **Custom** appears and press **OK**.
5. Press the left/right arrow to enter the copy size you want. Pressing and holding the button allows you to quickly scroll to the number you want.
6. Press **OK** to save the selection.
7. Press **Stop/Clear** to return to ready mode.

 When you make a reduced copy, black lines may appear at the bottom of your copy.

CHANGING THE DEFAULT COPY SETTINGS

The copy options, including darkness, original type, copy size, and number of copies, can be set to those most frequently used. When you copy a document, the default settings are used unless they have been changed by using the corresponding buttons on the control panel.

1. Press **Copy**.
2. Press **Menu** until **Copy Setup** appears on the bottom line of the display and press **OK**.
3. Press **OK** when **Change Default** appears.
4. Press the left/right arrow until the setup option you want appears and press **OK**.
5. Press the left/right arrow until the setting you want appears and press **OK**.
6. Repeat steps 4 through 5, as needed.
7. Press **Stop/Clear** to return to ready mode.

 While you are setting copy options, pressing **Stop/Clear** cancels the changed settings and restores the defaults.

ID CARD COPYING

Your printer can print 2-sided originals on one sheet of A4-, Letter-, Legal-, Folio-, Oficio-, Executive-, B5-, A5-, or A6-sized paper.

The printer prints one side of the original on the upper half of the paper and the other side on the lower half without reducing the size of the original. This feature is helpful for copying a small-sized item, such as a business card.

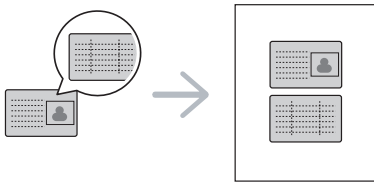

 The original must be placed on the scanner glass to use this feature.

1. Press **ID Copy**.
2. Place the front side of an original facing down on the scanner glass where arrows indicate as shown, and close the scanner lid.

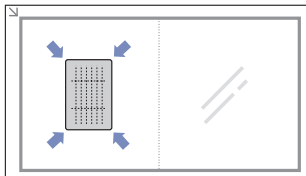

3. **Place Front Side and Press[Start]** appears on the display.
4. Press **Color Start** or **Black Start**.
Your printer begins scanning the front side and shows **Place Back Side and Press[Start]**

5. Turn the original over and place it on the scanner glass, where arrows indicate as shown. Then, close the scanner lid.

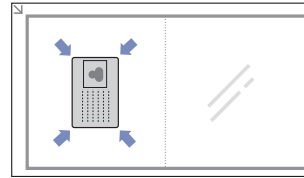

6. Press **Color Start** to begin color copying.
Or, press **Black Start** to begin black and white copying
-  If you do not press the **Color Start** or **Black Start** button, only the front side will be copied.
 - If the original is larger than the printable area, some portions may not be printed.
 - If you press **Stop/Clear** or if no buttons are pressed for approximately 30 seconds, the printer cancels the copy job and returns to ready mode.

USING SPECIAL COPY FEATURES

You can use the following copy features:

2-up or 4-up copying

Your printer can print 2 or 4 original images reduced to fit onto one sheet of paper.

1. Press **Copy**.
2. Press **Menu** until **Copy Feature** appears on the bottom line of the display and press **OK**.
3. Press the left/right arrow until **Layout** appears and press **OK**.
4. Press the left/right arrow until **2-Up** or **4-Up** appears and press **OK**.
5. Press **Stop/Clear** to return to ready mode.

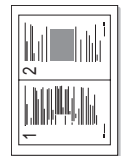

 You cannot adjust the copy size using the **Reduce/Enlarge** menu for making a 2- or 4-up copy.

Poster copying

Your printer can print an image onto 9 sheets of paper (3x3). You can paste the printed pages together to make one poster-sized document.

This copy feature is available only when you place originals on the scanner glass.

1. Press **Copy**.
2. Press **Menu** until **Copy Feature** appears on the bottom line of the display and press **OK**.
3. Press the left/right arrow until **Layout** appears and press **OK**.
4. Press the left/right arrow until **Poster Copy** appears and press **OK**.

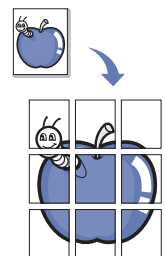

5. Press **Stop/Clear** to return to ready mode.

Your original is divided into 9 portions. Each portion is scanned and printed one by one in the following order:

1	2	3
4	5	6
7	8	9

Clone copying

Your printer can print multiple image copies from the original document on a single page. The number of images is automatically determined by the original image and paper size.

This copy feature is available only when you place originals on the scanner glass.

1. Press **Copy**.
2. Press **Menu** until **Copy Feature** appears on the bottom line of the display and press **OK**.
3. Press the left/right arrow until **Layout** appears and press **OK**.
4. Press the left/right arrow until **Clone Copy** appears and press **OK**.
5. Press **Stop/Clear** to return to ready mode.

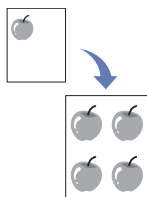

 You cannot adjust the copy size using the **Reduce/Enlarge** menu while making a clone copy.

Erasing background images

You can set the printer to print an image without its background. This copy feature removes the background color and can be helpful when copying an original containing color in the background, such as a newspaper or a catalog.

1. Press **Copy**.
2. Press **Menu** until **Copy Feature** appears on the bottom line of the display and press **OK**.
3. Press the left/right arrow until **Adjust Bkgd.** appears and press **OK**.
4. Press the left/right arrow until the binding option you want appears.
 - **Off:** Does not use this feature.
 - **Auto:** Optimizes the background.
 - **Enhance Lev. 1 ~ 2:** The higher the number is, the more vivid the background is.
 - **Erase Lev. 1 ~ 4:** The higher the number is, the lighter the background is.
5. Press **OK** to begin copying.
6. Press **Stop/Clear** to return to ready mode.

Gray enhance copying

When you copy the original in gray scale, use this feature for the better quality of copy-output. This feature is only for the copy in gray scale.

1. Press **Copy**.
2. Press **Menu** until **Copy Feature** appears on the bottom line of the display and press **OK**.
3. Press the left/right arrow until **Gray Enhance** appears and press **OK**.
4. Press the left/right arrow to select **On**.
5. Press **OK** to begin copying.
6. Press **Stop/Clear** to return to ready mode.

SETTING COPY TIMEOUT

You can set the time the printer waits before it restores the default copy settings, if you do not start copying after changing them on the control panel.

1. Press **Menu** until **System Setup** appears on the bottom line of the display and press **OK**.
2. Press **OK** when **Machine Setup** appears.
3. Press the left/right arrow until **Timeout** appears and press **OK**.
4. Press the left/right arrow until the time setting you want appears. Selecting **Off** means that the printer does not restore the default settings until you press **Black Start** or **Color Start** to begin copying, or **Stop/Clear** to cancel.
5. Press **OK** to save your selection.
6. Press **Stop/Clear** to return to ready mode.

scanning

Scanning with your printer lets you turn pictures and text into digital files that can be stored on your computer.

This chapter includes:

- Scanning basics
- Scanning from the control panel
- Scanning by a network connection

 The maximum resolution that can be achieved depends upon various factors, including computer speed, available disk space, memory, the size of the image being scanned, and bit depth settings. Thus, depending on your system and what you are scanning, you may not be able to scan at certain resolutions, especially using enhanced resolution.

SCANNING BASICS

You can scan the originals with your printer via an USB cable or the network.

- **Dell Scan Manager:** You just walk to the printer with the originals and scan them from the control panel then, the scanned data will be stored in the connected computer's **My Documents** folder. When the setup installation is completed, then you have installed the **Dell Scan Manager** on your computer already. This feature can be used via the USB connection or the network connection. See next section (Setting scan information in Dell Scan Manager.).
- **TWAIN:** TWAIN is the one of the preset imaging applications. Scanning an image launches the selected application, enabling you to control the scanning process. See *Software section*. This feature can be used via the USB connection or the network connection. See *Software section*.
- **SmarThru:** This feature is the accompanying software for your printer. You can use this program to scan images or documents, and this feature can be used via the USB connection or the network connection. See *Software section*.
- **WIA:** WIA stands for Windows Images Acquisition. To use this feature your computer must be connected directly to the printer with a USB cable. See *Software section*.
- **Email:** You can send the scanned image as an attachment to an email. See "Registering authorized users" on page 34.

- Changing the settings for each scan job
- Changing the default scan settings
- Setting up Address Book

SCANNING FROM THE CONTROL PANEL

Your printer offers you to scan from the control panel and easily send the scanned document to connected computer's **My Documents** folder. In order to use this function, your printer and computer must be connect by USB cable or by network.

Also, with the offered **Dell Scan Manager** program, scanned documents can be opened with the program you have setup previously. Such as Microsoft Paint, Email, SmarThru, OCR can be added to the application program. See "Setting scan information in Dell Scan Manager." on page 33.

Scanned images can be saved as BMP, JPEG, TIFF, or PDF files.

Setting scan information in Dell Scan Manager.





You can find out about **Dell Scan Manager** program information and installed scan driver's condition. Also, you can change scan settings and add or delete the folders where scanned documents to computer are saved by the **Dell Scan Manager** program.

 Scan Manager program can only be used in the Windows system.

1. Press **Start**→**Control Panel**→**Dell Scan Manager**.
Dell Scan Manager Administration appears.
2. Select the appropriate printer from the **Dell Scan Manager**.
3. Press **Properties**.
4. **Set Scan Button** allows you to change the saving destination and scan settings, add or delete application program and format files.
You can change the scanning printer by using **Change Port**. (Local or Network)
5. Press **OK** after setting is done.

Scanning to application programs

1. Ensure that your printer and computer are turned on and properly connected to each other.
2. Load originals face up into the ADF, or place a single original face down on the scanner glass.
For details about loading an original. See "Loading originals" on page 23.
3. Press **Scan/Email**.
Ready to Scan appears on the top line of the display.
4. Press the left/right arrow until **Scan to PC** appears on the bottom line of the display and press **OK**.

5. Press the left/right arrow until **Local PC** appears on the bottom line of the display and press **OK**. If the printer connected to a network, select **Network PC** and press **OK**.
 -  If you see a **Not Available** message, check the port connection.
 -  If you selected **Network PC**, select your registered user ID and enter the PIN. Press **OK**.
 - ID is the same ID as the registered ID for **Dell Scan Manager**.
 - PIN is the 4 digit number registered for **Dell Scan Manager**.
6. From **Scan Destination**, press the left/right arrow until the application program you want appears, then press **OK**. Default setting is **My Documents**.
 -  To add or delete the folder where the scanned file is saved, add or delete the application program in **Dell Scan Manager**→**Set Scan Button**.
7. Press the left/right button until the setting you want appears then press **OK**.
 - **Resolution**: Sets the image resolution.
 - **Scan Color**: Sets the color mode.
 - **Scan Format**: Sets the file format in which the image is to be saved.
 - **Scan Size**: Sets the image size.
 -  • **Scan Format** appears only when you selected the **Scan Destination to My Documents**.
 - If you want to scan from the default setting, press **Color Start** or **Black Start**.
8. Scanning begins.
 -  • Scanned image is saved in computer's **My Documents**→**My Pictures**→**Dell** folder.
 - You can use Twain driver to scan quickly in **Dell Scan Manager** program.
 - You can also scan by pressing Window's **Start**→**Control Panel**→**Dell Scan Manager**→**Quick Scan**.

SCANNING BY A NETWORK CONNECTION

If you have connected your printer to a network and set up network parameters correctly, you can scan and send images over the network.

Setting up an e-mail account

To scan and send an image as an email attachment, you need to set up network parameters using Embedded Web Service.

1. Enter your printer's IP address as the URL in a browser and click **Go** to access the web site of your printer.
2. Click **Machine Settings** and **E-mail Setup**.
3. Select **IP Address** or **Host Name**.
4. Enter the IP address in dotted decimal notation or as a host name.
5. Enter the server port number, from 1 to 65535. The default port number is 25.
6. Check the box next to **SMTP Requires Authentication** to require authentication.
7. Enter the SMTP server login name and password.

8. Click **Apply**.



If the authentication method of SMTP server is POP3 before SMTP, check the box next to **SMTP Requires POP3 Before SMTP Authentication**.

- a. Enter the IP address in dotted decimal notation or as a host name.
- b. Enter the server port number, from 1 to 65535. The default port number is 25.

Registering authorized users

1. Enter your printer's IP address as the URL in a browser and click **Go** to access the web site of your printer.
2. Click **Machine Settings** and **User Authentication**.
3. Click **Add**.
4. Select index number corresponding to the location for storing the entry, from 1 to 50.
5. Enter user name, auth ID, password and e-mail address. You need to enter the registered user ID and password in the printer when you start scanning to email from the control panel.
6. Click **Apply**.

Scanning to Email

You can scan and send an image as an email attachment. You first need to set up your email account in **Embedded Web Service**. See "Setting up an e-mail account" on page 34.

Before scanning, you can set the scan options for your scan job. See "Changing the settings for each scan job" on page 35.

1. Ensure that your printer is connected to a network.
2. Place a single document face down on the document glass. OR load the document(s) face up into the ADF. For details about loading an original. See "Loading originals" on page 23.
3. Press **Scan/Email**.
4. Press the left/right arrow until **Scan to Email** appears on the bottom line of the display and press **OK**.



If you registered **Auth Id, Password** and checked **Enable Auth User** in **User Authentication** on **Embedded Web Service**, **My Log in ID** and **Password** appear. Enter the Auth Id and Password for your printer. Go to step 6.

5. When **From** appears on the top line of the display, enter the sender's email address and press **OK**.
6. When **DestinationEmail** appears on the top line of the display, enter the recipient's email address and press **OK**. If you have set up Address Book, you can use a speed button or a speed email or group email number to retrieve an address from memory. See "Setting up Address Book" on page 35.
7. To enter additional addresses, press **OK** when **Yes** appears and repeat step 6. To continue to the next step, press the left/right arrow to select **No** and press **OK**.
8. If the display asks if you want to send the email to your account, press the left/right arrow to select **Yes** or **No** and press **OK**.



This prompt does not appear if you have activated the Auto Send To Self option in the email account setup.

9. Enter an email subject and press **OK**.

10. Press the left/right arrow until the file format you want appears and press **OK** or **Start**.
The printer begins scanning and then sends the email.
11. If the printer asks if you want to log off your account, press the left/right arrow to select **Yes** or **No** and press **OK**.
12. Press **Stop/Clear** to return to ready mode.

CHANGING THE SETTINGS FOR EACH SCAN JOB

Your printer provides you with the following setting options to allow you to customize your scan jobs.

- **Scan Size:** Sets the image size.
- **Original Type:** Sets the original document's type.
- **Resolution:** Sets the image resolution.
- **Scan Color:** Sets the color mode.
- **Scan Format:** Sets the file format in which the image is to be saved. If you select TIFF or PDF, you can select to scan multiple pages.
Depending on the selected scan type, this option may not appear.

To customize the settings before starting a scan job:

1. Press **Scan/Email**.
2. Press **Menu** until **Scan Feature** appears on the bottom line of the display and press **OK**.
3. Press the left/right arrow until the scan type you want appears and press **OK**.
4. Press the left/right arrow until the scan setting option you want appears and press **OK**.
5. Press the left/right arrow until the desired status appears and press **OK**.
6. Repeat steps 4 and 5 to set other setting options.
7. When you have finished, press **Stop/Clear** to return to ready mode.

CHANGING THE DEFAULT SCAN SETTINGS

To avoid having to customize the scan settings for each job, you can set up default scan settings for each scan type.

1. Press **Scan/Email**.
2. Press **Menu** until **Scan Setup** appears on the bottom line of the display and press **OK**.
3. Press **OK** when **Change Default** appears.
4. Press the left/right arrow until the scan type you want appears and press **OK**.
5. Press the left/right arrow until the scan setting option you want appears and press **OK**.
6. Press the left/right arrow until the desired status appears and press **OK**.
7. Repeat steps 5 and 6 to change other settings.
8. To change the default settings for other scan types, press **Back** and repeat from step 4.
9. Press **Stop/Clear** to return to ready mode.

SETTING UP ADDRESS BOOK

You can set up **Address Book** with the email addresses you use frequently via Embedded Web Service and then easily and quickly enter email addresses by entering the location numbers assigned to them in **Address Book**.

Registering speed email numbers

1. Enter your printer's IP address as the URL in a browser and click **Go** to access the web site of your printer.
2. Click **Machine Settings** and **E-mail Setup**.
3. Click **Local Address Book** and **Add**.
4. Select a location number and enter the user name and e-mail address you want.
5. Click **Apply**.



You can also click **Import** and obtain your address book from your computer.

Configuring group email numbers

Enter your printer's IP address as the URL in a browser and click **Go** to access the web site of your printer.

1. Click **Machine Settings** and **E-mail Setup**.
2. Click **Group Address Book** and **Add**.
3. Select a group number and enter the group name you want.
4. Select speed email numbers that will be included in the group.
5. Click **Apply**.

Using Address Book entries

To retrieve an email address, use the following ways:

Speed email numbers

When you are prompted to enter a destination address while sending an email, enter the speed email number at which you stored the address you want.

- For a one-digit speed email location, press and hold the corresponding digit button from the number keypad.
- For a two- or three-digit speed email location, press the first digit button(s) and then hold down the last digit button.

You can search through memory for an entry by pressing **Address Book**. See "Searching Address Book for an entry" on page 35.

Group email numbers

To use a group email entry, you need to search for and select it from memory.

When you are prompted to enter a destination address while sending an email, press **Address Book**. See "Searching Address Book for an entry" on page 35.

Searching Address Book for an entry

There are two ways to search for an address in memory. You can either scan from A to Z sequentially or search by entering the first letters of the name associated with the address.

Searching sequentially through memory

1. If necessary, press **Scan/Email**.
2. Press **Address Book** until **Search & Send** appears on the bottom line of the display and press **OK**.
3. Press the left/right arrow until the number category you want appears and press **OK**.
4. Press **OK** when **All** appears.
5. Press the left/right arrow until the name and address you want appears. You can search upwards or downwards through the entire memory in alphabetical order.

Searching with a particular first letter

1. If necessary, press **Scan/Email**.
2. Press **Address Book** until **Search & Send** appears on the bottom line of the display and press **OK**.
3. Press the left/right arrow until the number category you want appears and press **OK**.
4. Press the left/right arrow until **ID** appears and press **OK**.
5. Enter the first few letters of the name you want and press **OK**.
6. Press the left/right arrow until the name you want appears and press **OK**.

Printing Address Book

You can check your **Address Book** settings by printing a list.

1. Press **Address Book** until **Print** appears on the bottom line of the display.
2. Press **OK**.
3. Press the left/right arrow until the option you want appears and press **OK**.
4. Press **OK** when **Yes** appears to confirm printing.
The selected information prints out.

basic printing

This chapter explains common printing tasks.

This chapter includes:

- Printing a document
- Canceling a print job

PRINTING A DOCUMENT

Your printer allows you to print from various Windows, or Macintosh applications. The exact steps for printing a document may vary depending on the application you use.

For details about printing, see *Software section*.

CANCELING A PRINT JOB

If the print job is waiting in a print queue or print spooler, such as the printer group in Windows, delete the job as follows:

1. Click the Windows **Start** menu.
2. For Windows 2000, select **Settings** and then **Printers**.
For Windows XP/2003, select **Printers and Faxes**.
For Windows Vista, select **Control Panel** → **Hardware and Sound** → **Printers**.
3. Double-click the **Dell 1235cn Color Laser MFP** icon.
4. From the **Document** menu, select **Cancel**.

 You can also access this window by simply double-clicking the printer icon at the bottom right corner of the Windows desktop.

You can also cancel the current job by pressing **Stop/Clear** on the control panel.

This chapter gives you information about using your printer as a fax machine.

This chapter includes:

- Sending a fax
- Receiving a fax

 It is recommended that you to use traditional analog phone services (PSTN: public switched telephone network) when connecting telephone lines to use Fax. If you use other Internet services (DSL, ISDN, VoIP), you can improve the connection quality by using the Micro-filter. The Micro-filter eliminates unnecessary noise signals and improves connection quality or Internet quality. Since the DSL Micro-filter is not provided with the printer, contact your Internet Service provider for use on DSL Micro-filter.

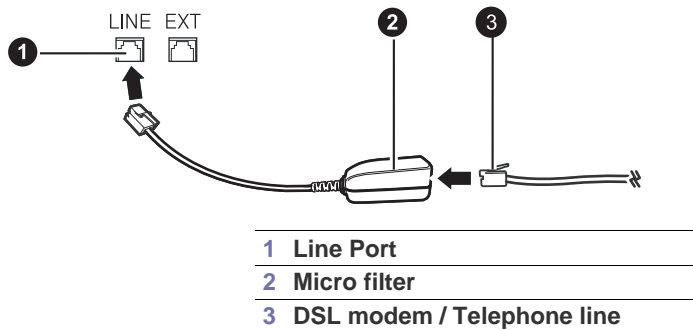

SENDING A FAX

Setting the fax header

In some countries, you are required by law to indicate your fax number on any fax you send. The printer ID, containing your telephone number and name or company name, will be printed at the top of each page sent from your printer.

1. Press **Menu** until **System Setup** appears on the bottom line of the display and press **OK**.
2. Press **OK** when **Machine Setup** appears.
3. Press **OK** when **Machine ID** appears.
4. Enter your name or the company name using the number keypad. You can enter alphanumeric characters using the number keypad, and include special symbols by pressing the **0** button. For details on how to enter alphanumeric characters, see "Entering characters using the number keypad" on page 21.
5. Press **OK** to save the ID.
6. Press the left/right arrow until **Machine Fax No.** appears and press **OK**.
7. Enter your fax number using the number keypad and press **OK**.
8. Press **Stop/Clear** to return to ready mode.

- Fax setup

Adjusting the document settings

Before starting to fax, change the following settings according to your original's status to get the best quality.

Resolution

The default document settings produce good results when using typical text-based originals. However, if you send originals that are of poor quality, or contain photographs, you can adjust the resolution to produce a higher quality Fax.

1. Press **Fax**.
2. Press **Menu**, and then **OK** when **Fax Feature** appears on the bottom line of the display.
3. Press **OK** when **Resolution** appears.
4. Press the left/right arrow until the option you want appears and press **OK**.
5. Press **Stop/Clear** to return to ready mode.

Recommended resolution settings for different original document types are described in the table below:

MODE	RECOMMENDED FOR:
Standard	Originals with normal sized characters.
Fine	Originals containing small characters or thin lines or originals printed using a dot-matrix printer.
Superfine	Originals containing extremely fine detail. Super Fine mode is enabled only if the printer with which you are communicating also supports the Super Fine resolution. <ul style="list-style-type: none">  For memory transmission, Superfine mode is not available. The resolution setting is automatically changed to Fine. When your printer is set to Superfine resolution and the fax machine with which you are communicating does not support Superfine resolution, the printer transmits using the highest resolution mode supported by the other fax machine.
Photo Fax	Originals containing shades of gray or photographs.

 The resolution setting is applied to the current fax job. To change the default setting, see "Changing the default document settings" on page 44.

Darkness

You can select the default contrast mode to fax your originals lighter or darker.

1. Press **Fax**.
2. Press **Menu**, and then **OK** when **Fax Feature** appears on the bottom line of the display.
3. Press **OK** when **Darkness** appears.
4. Press the left/right arrow until the option you want appears and press **OK**.
5. Press **Stop/Clear** to return to ready mode.

 The darkness setting is applied to the current fax job. To change the default setting, see "Changing the default document settings" on page 44.

Sending a fax automatically

1. Press **Fax**.
2. Load originals face up into the ADF, or place a single original face down on the scanner glass.
For details about loading an original. See "Loading originals" on page 23.
Ready to Fax appears on the top line of the display.
3. Adjust the resolution and the darkness to suit your fax needs.
See "Adjusting the document settings" on page 38.
4. Enter the receiving fax machine's number.
You can use speed dial numbers, or group dial numbers. For details about storing and searching for a number, see "Setting up Address Book" on page 44.
5. Press **Color Start** or **Black Start**.

 If an original is placed on the scanner glass, select **Yes** to add another page. Load another original and press **OK**.

6. When you have finished, select **No** at the **Another Page?** prompt.
After the number is dialed, the printer begins sending the fax when the receiving fax machine answers.

 When you want to cancel a fax job, press **Stop/Clear** at any time while sending.

Sending a fax manually

1. Press **Fax**.
2. Load originals face up into the ADF, or place a single original face down on the scanner glass.
For details about loading an original. See "Loading originals" on page 23.
3. Adjust the resolution and the darkness to suit your fax needs.
See "Adjusting the document settings" on page 38.
4. Press **On Hook Dial**. You hear a dial tone.
5. Enter the receiving fax machine's number.
You can use speed dial numbers, or group dial numbers. For details about storing and searching for a number, see "Setting up Address Book" on page 44.
6. Press **Color Start** or **Black Start** when you hear a high-pitched fax signal from the remote fax machine.

 When you want to cancel a fax job, press **Stop/Clear** at any time while sending.

Confirming a transmission

When the last page of your original has been sent successfully, the printer beeps and returns to ready mode.

When something goes wrong while sending your fax, an error message appears on the display. For a list of error messages and their meanings, see "Understanding display messages" on page 62. If you receive an error message, press **Stop/Clear** to clear the message and try to send the fax again.

You can set your printer to print a confirmation report automatically each time sending a fax is completed. For further details, see "Send Report" on page 43.

Automatic redialing

When the number you have dialed is busy or there is no answer when you send a fax, the printer automatically redials the number every three minutes, up to seven times according to the factory default settings.

When the display shows **Retry Redial?**, press **OK** to redial the number without waiting. To cancel the automatic redialing, press **Stop/Clear**.

To change the time interval between redials and the number of redial attempts. See "Sending options" on page 43.

Redialing the last number

To redial the number you called last:

1. Press **Redial/Pause**.
2. When an original is loaded in the ADF, the printer automatically begins to send.
If an original is placed on the scanner glass, select **Yes** to add another page. Load another original and press **OK**. When you have finished, select **No** at the **Another Page?** prompt.

Sending a fax to multiple destinations

You can use the Multiple Send feature, which allows you to send a fax to multiple locations. Originals are automatically stored in memory and sent to a remote station. After transmission, the originals are automatically erased from memory. You cannot send a color fax using this feature.



1. Press **Fax**.
2. Load originals face up into the ADF, or place a single original face down on the scanner glass.
For details about loading an original. See "Loading originals" on page 23.
3. Adjust the document resolution and darkness to suit your fax needs.
See "Adjusting the document settings" on page 38.
4. Press **Menu** until **Fax Feature** appears on the bottom line of the display and press **OK**.
5. Press the left/right arrow until **Multi Send** appears and press **OK**.
6. Enter the number of the first receiving fax machine and press **OK**.
You can press speed dial numbers or select Group Dial Number using **Address Book** Button. For details, see "Setting up Address Book" on page 44.
7. Enter the second fax number and press **OK**.
The display asks you to enter another fax number to send the document.
8. To enter more fax numbers, press **OK** when **Yes** appears and repeat steps 6 and 7. You can add up to 10 destinations.

 Once you entered a group dial number, you cannot enter another group dial numbers anymore.

9. When you have finished entering fax numbers, press the left/right arrow to select **No** at the **Another No.?** prompt and press **OK**.
The original is scanned into memory before transmission. The display shows memory capacity and the number of pages being stored in memory.
10. If an original is placed on the scanner glass, select **Yes** to add another page. Load another original and press **OK**.
When you have finished, select **No** at the **Another Page?** prompt.
The printer begins sending the fax to the numbers you entered in the order in which you entered them.

Sending a delayed fax

You can set your printer to send a fax at a later time when you will not be present. You cannot send a color fax using this feature.

1. Press **Fax**.
2. Load originals face up into the ADF, or place a single original face down on the scanner glass.
For details about loading an original. See "Loading originals" on page 23.
3. Adjust the document resolution and darkness to suit your fax needs.
See "Adjusting the document settings" on page 38.
4. Press **Menu** until **Fax Feature** appears on the bottom line of the display and press **OK**.
5. Press the left/right arrow until **Delay Send** appears and press **OK**.
6. Enter the number of the receiving printer using the number keypad.
You can press speed dial numbers or select Group Dial Number using **Address Book** Button. For details, see "Setting up Address Book" on page 44.
7. Press **OK** to confirm the number. The display asks you to enter another fax number to which to send the document.
8. To enter more fax numbers, press **OK** when **Yes** appears and repeat steps 6 and 7. You can add up to 10 destinations.
 Once you entered a group dial number, you cannot enter another group dial numbers anymore.
9. When you have finished entering fax numbers, press the left/right arrow to select **No** at the **Another No.?** prompt and press **OK**.
10. Enter the job name you want and press **OK**.
For details on how to enter alphanumeric characters, see "Entering characters using the number keypad" on page 21.
If you do not want to assign a name, skip this step.
11. Enter the time using the number keypad and press **OK**, or **Black Start**.
 If you set a time earlier than the current time, the fax will be sent at that time on the following day.

The original is scanned into memory before transmission. The display shows memory capacity and the number of pages being stored in memory.
12. If an original is placed on the scanner glass, select **Yes** to add another page. Load another original and press **OK**.
When you have finished, select **No** at the **Another Page?** prompt.
The printer returns to ready mode. The display reminds you that you are in ready mode and that a delayed fax is set.

Adding pages to a delayed fax

You can add pages to the delayed transmissions previously reserved in your printer's memory.

1. Load the originals to be added and adjust document settings.
2. Press **Menu** until **Fax Feature** appears on the bottom line of the display and press **OK**.

3. Press the left/right arrow until **Add Page** appears and press **OK**.
4. Press the left/right arrow until the fax job you want appears and press **OK**.
When you have finished, select **No** at the **Another Page?** prompt.
The printer scans the original into memory and shows the total number of pages and the number of the added pages.

Canceling a delayed fax

1. Press **Menu** until **Fax Feature** appears on the bottom line of the display and press **OK**.
2. Press the left/right arrow until **Cancel Job** appears and press **OK**.
3. Press the left/right arrow until the fax job you want appears and press **OK**.
4. Press **OK** when **Yes** appears.
The selected fax is deleted from memory.

Sending a priority fax

Using the Priority Fax feature, a high priority fax can be sent ahead of reserved operations. The original is scanned into memory and immediately transmitted when the current operation is finished. In addition, priority transmission will interrupt a Multiple Send operation between stations (i.e., when the transmission to station A ends, before transmission to station B begins) or between redial attempts.

1. Press **Fax**.
2. Load originals face up into the ADF, or place a single original face down on the scanner glass.
For details about loading an original. See "Loading originals" on page 23.
3. Adjust the document resolution and darkness to suit your fax needs.
See "Adjusting the document settings" on page 38.
4. Press **Menu** until **Fax Feature** appears on the bottom line of the display and press **OK**.
5. Press the left/right arrow until **Priority Send** appears and press **OK**.
6. Enter the number of the receiving printer.
You can use speed dial numbers, or group dial numbers.
For details, see "Setting up Address Book" on page 44.
7. Press **OK** to confirm the number.
8. Enter the job name you want and press **OK**.
The original is scanned into memory before transmission. The display shows memory capacity and the number of pages being stored in memory.
9. If an original is placed on the scanner glass, select **Yes** to add another page. Load another original and press **OK**.
When you have finished, select **No** at the **Another Page?** prompt.
The printer shows the number being dialed and begins sending the fax.

RECEIVING A FAX

Changing receiving modes

1. Press **Fax**.
2. Press **Menu** until **Fax Setup** appears on the bottom line of the display and press **OK**.
3. Press the left/right arrow until **Receiving** appears and press **OK**.
4. Press **OK** when **Receive Mode** appears.
5. Press the left/right arrow until the fax reception mode you want appears.
 - In **Fax** mode, the printer answers an incoming fax call and immediately goes into the fax reception mode.
 - In **Tel** mode, you can receive a fax by pressing **On Hook Dial** and then **Color Start** or **Black Start**. You can also pick up the handset of the extension phone and then press the remote receive code. See "Receiving manually using an extension telephone" on page 41.
 - In **Ans/Fax** mode, an answering printer attached to your printer answers an incoming call, and the caller can leave a message on the answering printer. If the fax machine senses a fax tone on the line, the printer automatically switches to **Fax** mode to receive the fax. See "Receiving automatically in Ans/Fax mode" on page 41.
 - In **DRPD** mode, you can receive a call using the Distinctive Ring Pattern Detection (DRPD) feature. Distinctive Ring is a telephone company service which enables an user to use a single telephone line to answer several different telephone numbers. For further details, see "Receiving faxes using DRPD mode" on page 41.
6. Press **OK** to save your selection.
7. Press **Stop/Clear** to return to ready mode.



- To use the **Ans/Fax** mode, attach an answering printer to the EXT socket on the back of your printer.
- If you do not want other people to view your received documents, you can use secure receiving mode. In this mode, all of the received faxes are stored in memory. For further details, see "Receiving in secure receiving mode" on page 42.

Receiving automatically in Fax mode

Your printer is preset to **Fax** mode at the factory. When you receive a fax, the printer answers the call on a specified number of rings and automatically receives the fax.

To change the number of rings, see "Ring to Answer" on page 43.

Receiving manually in Tel mode

You can receive a fax call by pressing **On Hook Dial** and then pressing **Black Start** or **Color Start** when you hear a fax tone from the remote printer.

The printer begins receiving a fax and returns to ready mode when the reception is completed.

Receiving manually using an extension telephone

This feature works best when you are using an extension telephone connected to the EXT socket on the back of your printer. You can receive a fax from someone you are talking to on the extension telephone without going to the fax machine.

When you receive a call on the extension phone and hear fax tones, press the keys ***9*** on the extension phone. The printer receives the fax.

Press the buttons slowly in sequence. If you still hear the fax tone from the remote printer, try pressing ***9*** once again.

9 is the remote receive code preset at the factory. The first and the last asterisks are fixed, but you can change the middle number to whatever you wish. For details about changing the code, see "Rcv Start Code" on page 43.

Receiving automatically in Ans/Fax mode

To use this mode, you must attach an answering printer to the EXT socket on the back of your printer.

If the caller leaves a message, the answering printer stores the message as it would normally. If your printer detects a fax tone on the line, it automatically starts to receive the fax.



- If you have set your printer to **Ans/Fax** mode and your answering printer is switched off, or no answering printer is connected to EXT socket, your printer automatically goes into **Fax** mode after a predefined number of rings.
- If your answering printer has a user-selectable ring counter, set the printer to answer incoming calls within 1 ring.
- If you are in **Tel** mode (manual reception) when the answering printer is connected to your printer, you must switch off the answering printer, or the outgoing message from the answering printer will interrupt your phone conversation.

Receiving faxes using DRPD mode

Distinctive Ring is a telephone company service which enables an user to use a single telephone line to answer several different telephone numbers. The particular number someone uses to call you is identified by different ringing patterns, which consist of various combinations of long and short ringing sounds. This feature is often used by answering services who answer telephones for many different clients and need to know which number someone is calling in on to properly answer the phone.

Using the Distinctive Ring Pattern Detection (DRPD) feature, your fax machine can learn the ring pattern you designate to be answered by the fax machine. Unless you change it, this ringing pattern will continue to be recognized and answered as a fax call, and all other ringing patterns will be forwarded to the extension telephone or answering printer plugged into the EXT socket. You can easily suspend or change DRPD at any time.

Before using the DRPD option, Distinctive Ring service must be installed on your telephone line by the telephone company. To set up DRPD, you will need another telephone line at your location, or someone available to dial your fax number from outside.

To set up the **DRPD** mode:

1. Press **Fax**.
2. Press **Menu** until **Fax Setup** appears on the bottom line of the display and press **OK**.
3. Press the left/right arrow until **Receiving** appears and press **OK**.
4. Press the left/right arrow until **DRPD Mode** appears and press **OK**. **Waiting Ring** appears on the display.
5. Call your fax number from another telephone. It is not necessary to place the call from a fax machine.

- When your printer begins to ring, do not answer the call. The printer requires several rings to learn the pattern.

When the printer completes learning, the display shows **Completed DRPD Setup**. If the DRPD setup fails, **Error DRPD Ring** appears. Press **OK** when **DRPD Mode** appears and start over from step 4.

- Press **Stop/Clear** to return to ready mode.



- DRPD must be set up again if you re-assign your fax number, or connect the printer to another telephone line.
- After DRPD has been set up, call your fax number again to verify that the printer answers with a fax tone. Then have a call placed to a different number assigned to that same line to be sure the call is forwarded to the extension telephone or answering printer plugged into the EXT socket.

Receiving in secure receiving mode

You may need to prevent your received faxes from being accessed by unauthorized people. You can turn on secure receiving mode to restrict printing of received faxes when the printer is unattended. In secure receiving mode, all incoming faxes go into memory. When the mode is deactivated, any stored faxes are printed.

Activating secure receiving mode

- Press **Fax**.
- Press **Menu** and then press **OK** when **Fax Feature** appears on the bottom line of the display.
- Press the left/right arrow until **Secure Receive** appears and press **OK**.
- Press the left/right arrow until **On** appears and press **OK**.
- Enter a four-digit password you want to use and press **OK**.
- Re-enter the password to confirm it and press **OK**.
- Press **Stop/Clear** to return to ready mode.

When a fax is received in secure receiving mode, your printer stores it in memory and shows **Secure Receive** to let you know that there is a fax received.

Printing received faxes

- Access the **Secure Receive** menu by following steps 1 through 3 in "Activating secure receiving mode."
- Press the left/right arrow until **Print** appears and press **OK**.
- Enter the four-digit password and press **OK**.
The printer prints all of the faxes stored in memory.

Deactivating secure receiving mode

- Access the **Secure Receive** menu by following steps 1 through 3 in "Activating secure receiving mode."
- Press the left/right arrow until **Off** appears and press **OK**.
- Enter the four-digit password and press **OK**.
The mode is deactivated and the printer prints all faxes stored in memory.
- Press **Stop/Clear** to return to ready mode.

Receiving faxes in memory

Since your printer is a multi-tasking device, it can receive faxes while you are making copies or printing. If you receive a fax while you are copying or printing, your printer stores incoming faxes in its memory. Then, as soon as you finish copying or printing, the printer automatically prints the fax.

Also, your printer receives faxes and stores them in its memory when there is no paper in the tray or no toner in the installed toner cartridge.

Forwarding faxes

You can forward your incoming and outgoing faxes to another fax machine or email address.

Forwarding sent faxes to another fax machine

You can set the printer to send copies of all outgoing faxes to a specified destination, in addition to the fax numbers you entered.

- Press **Fax**.
- Press **Menu** until **Fax Feature** appears on the bottom line of the display and press **OK**.
- Press the left/right arrow until **Forward** appears and press **OK**.
- Press **OK** when **Fax** appears.
- Press the left/right arrow until **Send Forward** appears and press **OK**.
- Press the left/right arrow to select **On** and press **OK**.
- Enter the number of the fax machine to which faxes are to be sent and press **OK**.
- Press **Stop/Clear** to return to ready mode.
Subsequent sent faxes will be forwarded to the specified fax machine.

Forwarding sent faxes to email address

You can set the printer to send copies of all outgoing faxes to a specified destination, in addition to the email address you entered.

- Press **Fax**.
- Press **Menu** until **Fax Feature** appears on the bottom line of the display and press **OK**.
- Press the left/right arrow until **Forward** appears and press **OK**.
- Press the left/right arrow until **E-mail** appears and press **OK**.
- Press the left/right arrow until **Send Forward** appears and press **OK**.
- Press the left/right arrow to select **On** and press **OK**.
- Enter your email address and press **OK**.
- Enter the email address to which faxes are to be sent and press **OK**.
- Press **Stop/Clear** to return to ready mode.
Subsequent sent faxes will be forwarded to the specified email address.

Forwarding received faxes to another fax machine

You can set your printer to forward incoming faxes to another fax number during a specified time period. When a fax arrives at your printer, it is stored in memory. Then, the printer dials the fax number that you have specified and sends the fax.

- Press **Fax**.
- Press **Menu** until **Fax Feature** appears on the bottom line of the display and press **OK**.
- Press the left/right arrow until **Forward** appears and press **OK**.
- Press **OK** when **Fax** appears.
- Press the left/right arrow until **Rcv. Forward** appears and press **OK**.
- Press the left/right arrow until **Forward** appears and press **OK**.
To set the printer to print out a fax when fax forwarding has been completed, select **Forward&Print**.
- Enter the number of the fax machine to which faxes are to be sent and press **OK**.
- Enter the starting time and press **OK**.
- Enter the ending time and press **OK**.
- Press **Stop/Clear** to return to ready mode.
Subsequent received faxes will be forwarded to the specified fax machine.

Forwarding received faxes to email address

You can set your printer to forward incoming faxes to the email address you entered.

1. Press **Fax**.
2. Press **Menu** until **Fax Feature** appears on the bottom line of the display and press **OK**.
3. Press the left/right arrow until **Forward** appears and press **OK**.
4. Press the left/right arrow until **E-mail** appears and press **OK**.
5. Press the left/right arrow until **Rcv. Forward** appears and press **OK**.
6. Press the left/right arrow until **Forward** appears and press **OK**.
To set the printer to print out a fax when fax forwarding has been completed, select **Forward&Print**.
7. Enter your email address and press **OK**.
8. Enter the email address to which faxes are to be sent and press **OK**.
9. Press **Stop/Clear** to return to ready mode.
Subsequent sent faxes will be forwarded to the specified email address.

FAX SETUP

Changing the fax setup options

Your printer provides you with various user-selectable options for setting up the fax system. You can change the default settings for your preferences and needs.

To change the fax setup options:

1. Press **Fax**.
2. Press **Menu** until **Fax Setup** appears on the bottom line of the display and press **OK**.
3. Press the left/right arrow to select **Sending** or **Receiving** and press **OK**.
4. Press the left/right arrow until the menu item you want appears and press **OK**.
5. Press the left/right arrow until the desired status appears or enter the value for the option you have selected, and press **OK**.
6. If necessary, repeat steps 4 through 5.
7. Press **Stop/Clear** to return to ready mode.

Sending options

OPTION	DESCRIPTION
Redial Times	You can specify the number of redial attempts. If you enter 0 , the printer will not redial.
Redial Term	Your printer can automatically redial a remote fax machine if it was busy. You can set an interval between attempts.
Prefix Dial	You can set a prefix of up to five digits. This number dials before any automatic dial number is started. It is useful for accessing a PABX exchange.
ECM Mode	This mode helps with poor line quality and makes sure any faxes you send are sent smoothly to any other ECM-equipped fax machine. Sending a fax using ECM may take more time.

OPTION	DESCRIPTION
Send Report	You can set your printer to print a confirmation report showing whether a transmission was successful, how many pages were sent, and more. The available options are On , Off , and On-Error , which prints only when a transmission is not successful.
Image TCR	This function allows users to know what fax messages have been sent by showing sent messages in the transmission report. The first page of the message is turned into an image file than is printed on the transmission report so the users can see what messages have been sent. However, you cannot use this function when sending fax without saving the data in the memory.
Dial Mode	This setting may not be available depending on your country. If you cannot reach this option, your printer does not support this feature. You can set the dial mode for your printer to either tone dialling or pulse dialling. If you have a public telephone system or a private branch exchange(PBX) system, you may need to select Pulse . Contact your local telephone company if you are not sure which dial mode to use. If you select Pulse , some phone system features might not be available. It can also take longer to dial a fax or phone number.

Receiving options

OPTION	DESCRIPTION
Receive Mode	You can select the default fax receiving mode. For details on receiving faxes in each mode, see "Changing receiving modes" on page 41.
Ring to Answer	You can specify the number of times the printer rings before answering an incoming call.
Stamp Rcv Name	This option allows the printer to automatically print the page number, and the date and time of reception at the bottom of each page of a received fax.
Rcv Start Code	This code allows you to initiate fax reception from an extension phone plugged into the EXT socket on the back of the printer. If you pick up the extension phone and hear fax tones, enter the code. It is preset to *9* at the factory.
Auto Reduction	When receiving a fax containing pages as long as or longer than the paper loaded in the paper tray, the printer can reduce the size of the original to fit the size of the paper loaded in the printer. Turn on this feature if you want to automatically reduce an incoming page. With this feature set to Off , the printer cannot reduce the original to fit onto one page. The original will be divided and printed in actual size on two or more pages.

OPTION	DESCRIPTION
Discard Size	<p>When receiving a fax containing pages as long as or longer than the paper in your printer, you can set the printer to discard a specific length from the end of the received fax. The printer will print the received fax on one or more sheets of paper, minus the data that would have been on the specified discard segment.</p> <p>When the received fax contains pages larger than the paper in your printer, and Auto Reduction has been turned on, the printer will reduce the fax to fit on the existing paper, and nothing will be discarded.</p>
Junk Fax Setup	<p>This setting may not be available depending on your country. Using this feature, the system will not accept faxes sent from remote stations whose numbers are stored in the memory as junk fax numbers. This feature is useful for blocking any unwanted faxes.</p> <p>When you turn on this feature, you can access the following options to set junk fax numbers.</p> <ul style="list-style-type: none"> • Add: Allows you to set up to 10 fax numbers. • Delete: Allows you to delete the desired junk fax number. If you select Delete All, Allows you to delete all junk fax numbers.
DRPD Mode	<p>This mode enables a user to use a single telephone line to answer several different telephone numbers. In this menu, you can set the printer to recognize which ring patterns to answer. For details about this feature, see "Receiving faxes using DRPD mode" on page 41.</p>

Changing the default document settings

The fax options, including resolution and darkness, can be set to the most frequently used modes. When you send a fax, the default settings are used if they are not changed by using the corresponding button and menu.

1. Press **Fax**.
2. Press **Menu** until **Fax Setup** appears on the bottom line of the display and press **OK**.
3. Press the left/right arrow until **Change Default** appears and press **OK**.
4. Press **OK** when **Resolution** appears.
5. Press the left/right arrow until the resolution you want appears and press **OK**.
6. Press the left/right arrow until **Darkness** appears and press **OK**.
7. Press the left/right arrow until the darkness you want appears and press **OK**.
8. Press **Stop/Clear** to return to ready mode.

Printing sent fax report automatically

You can set the printer to print a report with detailed information about the previous 50 communication operations, including time and dates.

1. Press **Fax**.
2. Press **Menu** until **Fax Setup** appears on the bottom line of the display and press **OK**.
3. Press the left/right arrow until **Auto Report** appears and press **OK**.
4. Press the left/right arrow until **On** appears and press **OK**.
5. Press **Stop/Clear** to return to ready mode.

Setting up Address Book

You can set up **Address Book** with the fax numbers you use most frequently. Your printer provides you with the following features for setting up **Address Book**:

- Speed/Group dial numbers

 Before beginning to store fax numbers, ensure that your printer is in Fax mode.

Speed dial numbers

You can store up to 240 frequently-used fax numbers in speed dial numbers.

Registering a speed dial number

1. Press **Fax**.
2. Press **Address Book** until **New & Edit** appears on the bottom line of the display and press **OK**.
3. Press **OK** when **Speed Dial** appears.
4. Enter a speed dial number between 0 and 239 and press **OK**.
If an entry is already stored in the number you choose, the display shows the name to allow you to change it. To start over with another speed dial number, press **Back**.
5. Enter the name you want and press **OK**.
For details on how to enter alphanumeric characters, see "Entering characters using the number keypad" on page 21.
6. Enter the fax number you want and press **OK**.
7. Press **Stop/Clear** to return to ready mode.

Editing speed dial numbers

1. Press **Address Book** until **New & Edit** appears on the bottom line of the display and press **OK**.
2. Press **OK** when **Speed Dial** appears.
3. Enter the speed dial number you want to edit and press **OK**.
4. Change the name and press **OK**.
5. Change the fax number and press **OK**.
6. Press **Stop/Clear** to return to ready mode.

Using speed dial numbers

When you are prompted to enter a destination number while sending a fax, enter the speed dial number at which you stored the number you want.

- For a one-digit (0-9) speed dial number, press and hold the corresponding digit button on the number keypad.
- For a two- or three-digit speed dial number, press the first digit button(s) and then hold down the last digit button.

You can also search through memory for an entry by pressing **Address Book**. See "Searching Address Book for an entry" on page 45.

Group dial numbers

If you frequently send the same document to several destinations, you can group these destinations and set them under a group dial number. You can then use a group dial number to send a document to all of the destinations within the group. You can set up to 200 (0 through 199) group dial numbers using the destination's existing speed dial numbers.

Registering a group dial number

1. Press **Fax**.
2. Press **Address Book** until **New & Edit** appears on the bottom line of the display and press **OK**.
3. Press the left/right arrow until **Group Dial** appears and press **OK**.
4. Enter a group dial number between 0 and 199 and press **OK**.
5. Enter the name you want and press **OK**.

6. Enter a speed dial number and press **OK**.
7. Press **OK** when speed dial information appears correctly.
8. Press **OK** when **Yes** appears.
9. Repeat steps 5 and 6 to include other speed dial numbers into the group.
10. When you have finished, press the left/right arrow to select **No** at the **Another No.?** prompt and press **OK**.
11. Press **Stop/Clear** to return to ready mode.

Editing a group dial number

You can delete a specific entry from a group or add a new number to the selected group.

1. Press **Address Book** until **New & Edit** appears on the bottom line of the display and press **OK**.
2. Press the left/right arrow until **Group Dial** appears and press **OK**.
3. Enter the group dial number you want to edit and press **OK**.
4. Enter the name you want to edit and press **OK**.
5. Enter the speed dial number you want to add or delete and press **OK**.
If you entered a new speed dial number, **Add?** appears.
If you enter a speed dial number stored in the group, **Delete?** appears.
6. Press **OK** to add or delete the number.
7. Press **OK** when **Yes** appears to add or delete more numbers and repeat steps 4 and 5.
8. When you have finished, press the left/right arrow to select **No** at the **Another No.?** prompt and press **OK**.
9. Press **Stop/Clear** to return to ready mode.

Using group dial numbers

To use a group dial entry, you need to search for and select it from memory.

When you are prompted to enter a fax number while sending a fax, press **Address Book**. See below.

Searching Address Book for an entry

There are two ways to search for a number in memory. You can either scan from A to Z sequentially, or you can search by entering the first letters of the name associated with the number.

Searching sequentially through the memory

1. If necessary, press **Fax**.
2. Press **Address Book** until **Search & Dial** appears on the bottom line of the display and press **OK**.
3. Press the left/right arrow until the number category you want appears and press **OK**.
4. Press **OK** when **All** appears.
5. Press the left/right arrow until the name and number you want appears. You can search upwards or downwards through the entire memory in alphabetical order.

Searching with a particular first letter

1. If necessary, press **Fax**.
2. Press **Address Book** until **Search & Dial** appears on the bottom line of the display and press **OK**.
3. Press the left/right arrow until the number category you want appears and press **OK**.
4. Press the left/right arrow until **ID** appears and press **OK**.
5. Enter the first few letters of the name you want and press **OK**.

6. Press the left/right arrow until the name you want appears and press **OK**.

Deleting a Address Book entry

You can delete entries in **Address Book** one by one.

1. Press **Address Book** until **Delete** appears on the bottom line of the display and press **OK**.
2. Press the left/right arrow until the number category you want appears and press **OK**.
3. Press the left/right arrow until the searching method you want appears and press **OK**.
Select **Search All** to search for an entry by scanning through all entries in **Address Book**.
Select **Search ID** to search for an entry by the first few letters of the name.
4. Press the left/right arrow until the name you want appears and press **OK**.
Or, enter the first letters and press **OK**. Press the left/right arrow until the name you want appears and press **OK**.
5. Press **OK**.
6. Press **OK** when **Yes** appears to confirm the deletion.
7. Press **Stop/Clear** to return to ready mode.

Printing Address Book

1. You can check your **Address Book** settings by printing a list.
1. Press **Address Book** until **Print** appears on the bottom line of the display.
2. Press **OK**. A list showing your speed button settings, and speed dial and group dial entries prints out.

using USB memory device

This chapter explains how to use a USB memory device with your printer.

This chapter includes:

- About USB memory
- Plugging in a USB memory device
- Scanning to a USB memory device
- Printing from a USB memory device

ABOUT USB MEMORY

USB memory devices are available with a variety of memory capacities to give you more room for storing documents, presentations, downloaded music and videos, high resolution photographs, or whatever other files you want to store or move.

You can do the following on your printer using a USB memory device:

- Scan documents and save them on a USB memory device.
- Print data stored on a USB memory device.
- Back up **Address Book/ Phone Book** entries and the system settings of your printer.
- Restore backup files to the printer's memory.
- Format the USB memory device.
- Check the available memory space.

PLUGGING IN A USB MEMORY DEVICE

The USB connector on the front of your printer is designed for USB V1.1 and USB V2.0 memory devices. Your printer supports USB memory devices with FAT16/FAT32 and sector size of 512 bytes.

Check your USB memory device's file system from your dealer.

You must use only an authorized USB memory device with an A plug type connector.

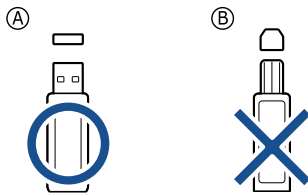

Use only a metal-shielded USB memory device.

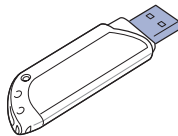

- Backing up data
- Managing USB memory
- Printing directly from a digital camera

Insert a USB memory device into the USB connector on the front of your printer.

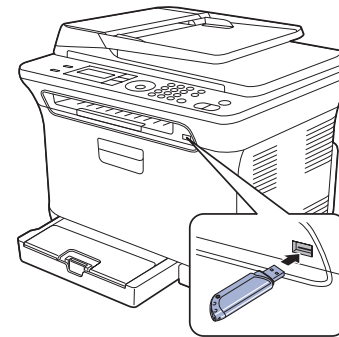

- Do not remove the USB memory device while the printer is in operation, or writing to or reading from USB memory. The printer warranty does not cover damage caused by user's misuse.
- If your USB memory device has certain features, such as security settings and password settings, your printer may not automatically detect it. For details about these features, see the documentation that came with your device.

SCANNING TO A USB MEMORY DEVICE

You can scan a document and save the scanned image onto a USB memory device. There are two ways of doing this: you can scan to the device using the default settings, or you can customize your own scan settings.

Scanning

1. Insert a USB memory device into the USB connector on your printer.
2. Load originals face up into the ADF, or place a single original face down on the scanner glass.
For details about loading an original. See "Loading originals" on page 23.
3. Press **Scan/Email**.
4. Press **OK** when **Scan to USB** appears on the bottom line of the display.
5. Press **Color Start** or **Black Start** when **Ready to Scan to USB** appears.

Regardless of the button you press, the color mode is decided as customized. See "Customizing Scan to USB" on page 47.

Your printer begins scanning the original, and then asks if you want to scan another page.

6. Press **OK** when **Yes** appears to scan more pages. Load an original and press **Color Start** or **Black Start**.
Regardless of the button you press, the color mode is decided as customized. See "Customizing Scan to USB" on page 47.
Otherwise, press the left/right arrow to select **No** and press **OK**.

After scanning is complete, you can remove the USB memory device from the printer.

Customizing Scan to USB

You can specify image size, file format, or color mode for each scanning to USB job.

1. Press **Scan/Email**.
2. Press **Menu** until **Scan Feature** appears on the bottom line of the display and press **OK**.
3. Press **OK** when **USB Feature** appears.
4. Press the left/right arrow until the setting option you want appears and press **OK**.

You can set the following options:

- **Scan Size:** Sets the image size.
 - **Original Type:** Sets the original document's type.
 - **Resolution:** Sets the image resolution.
 - **Scan Color:** Sets the color mode. If you select Mono in this option, you cannot select JPEG in **Scan Format**.
 - **Scan Format:** Sets the file format in which the image is to be saved. When you select TIFF or PDF, you can select to scan multiple pages. If you select JPEG in this option, you cannot select Mono in **Scan Color**.
5. Press the left/right arrow until the desired status appears and press **OK**.
 6. Repeat steps 4 and 5 to set other setting options.
 7. When you have finished, press **Stop/Clear** to return to ready mode.

You can change the default scan settings. For details, see "Changing the default scan settings" on page 35.

PRINTING FROM A USB MEMORY DEVICE

You can directly print files stored on a USB memory device. You can print TIFF, BMP, JPEG, and PRN files.

Direct Print option supported file types:

- PRN: Only files created by provided driver with your printer are compatible.
- PRN files can be created by selecting the Print to file check box when you print a document. The document will be saved as a PRN file, rather than printed on paper. Only PRN files created in this fashion can be printed directly from USB memory. See *Software section* to learn how to create a PRN file.
- BMP: BMP Uncompressed
- TIFF: TIFF 6.0 Baseline
- JPEG: JPEG Baseline

To print a document from a USB memory device:

1. Insert a USB memory device into the USB connector on your printer. If one has already been inserted, press **Direct USB**.
2. Press **OK** when **USB Print** appears.
Your printer automatically detects the device and reads data stored on it.
3. Press the left/right arrow until the folder or file you want appears and press **OK**.
If you see **D** in the front of a folder name, there are one or more files or folders in the selected folder.

4. If you selected a file, skip to the next step.
If you selected a folder, press the left/right arrow until the file you want appears.
5. Press the left/right arrow to select the number of copies to be printed or enter the number.
6. Press **OK**, **Color Start** or **Black Start** to start printing the selected file.
There are two types of mode as following:
 - **OK or Color Start:** Color print
 - **Black Start:** Black and White printAfter printing the file, the display asks if you want to print another job.
7. Press **OK** when **Yes** appears to print another job, and repeat from step 2.
Otherwise, press the left/right arrow to select **No** and press **OK**.
8. Press **Stop/Clear** to return to ready mode.

BACKING UP DATA

Data in the printer's memory can be accidentally erased due to power failure or storage failure. Backup helps you protect your **Address Book** entries and the system settings by storing them as backup files on a USB memory device.

Backing up data

1. Insert the USB memory device into the USB connector on your printer.
2. Press **Menu** until **System Setup** appears on the bottom line of the display and press **OK**.
3. Press **OK** when **Machine Setup** appears.
4. Press the left/right arrow until **Export Setting** appears and press **OK**.
5. Press the left/right arrow until the option you want appears.
 - **Address Book:** Backs up all **Address Book** entries.
 - **Setup Data:** Backs up all system settings.
6. Press **OK** to begin backing up the data.
The data is backed up to the USB memory.
7. Press **Stop/Clear** to return to ready mode.

Restoring data

1. Insert the USB memory device on which the backup data is stored in to the USB connector.
2. Press **Menu** until **System Setup** appears on the bottom line of the display and press **OK**.
3. Press **OK** when **Machine Setup** appears.
4. Press the left/right arrow until **Import Setting** appears and press **OK**.
5. Press the left/right arrow until the data type you want appears and press **OK**.
6. Press the left/right arrow until the file containing the data you want to restore appears and press **OK**.
7. Press **OK** when **Yes** appears to restore the backup file to the printer.
8. Press **Stop/Clear** to return to ready mode.

MANAGING USB MEMORY

You can delete image files stored on a USB memory device one by one or all at once by reformatting the device.

 After deleting files or reformatting a USB memory device, files cannot be restored. Therefore, confirm that you no longer need the data before deleting it.

Deleting an image file

1. Insert the USB memory device into the USB connector on your printer.
2. Press **Direct USB**.
3. Press the left/right arrow until **File Manage** appears and press **OK**.
4. Press **OK** when **Delete** appears.
5. Press the left/right arrow until the folder or file you want appears and press **OK**.

 If you see **D** in the front of a folder name, there are one or more files or folders in the selected folder.

If you selected a file, the display shows the size of the file for about 2 seconds. Go to the next step.

If you selected a folder, press the left/right arrow until the file you want to delete appears and press **OK**.

6. Press **OK** when **Yes** appears to confirm your selection.
7. Press **Stop/Clear** to return to ready mode.

Formatting a USB memory device

1. Insert the USB memory device into the USB connector on your printer.
2. Press **Direct USB**.
3. Press the left/right arrow until **File Manage** appears and press **OK**.
4. Press the left/right arrow until **Format** appears and press **OK**.
5. Press **OK** when **Yes** appears to confirm your selection.
6. Press **Stop/Clear** to return to ready mode.

Viewing the USB memory status

You can check the amount of memory space available for scanning and saving documents.

1. Insert the USB memory device into the USB connector on your printer.
2. Press **Direct USB**.
3. Press the left/right arrow until **Check Space** appears and press **OK**.
The available memory space appears on the display.
4. Press **Stop/Clear** to return to the ready mode.

PRINTING DIRECTLY FROM A DIGITAL CAMERA

This printer supports the PictBridge feature. You can print images directly from any PictBridge-compatible device, such as a digital camera, camera phone, and camcorder. You do not need to connect it to a computer.

1. Turn on the printer.
2. Connect your PictBridge-compatible device to the USB connector on the front of the printer using the USB cable supplied with the device.
3. Send an order to print images from the PictBridge-compatible device.



- Detailed information on how to print an image from a camera with PictBridge feature, see to the manual provided with your camera.
- Index print not support.
- Date or file name printing is not supported.

maintenance

This chapter provides information for maintaining your printer and the toner cartridge.

This chapter includes:

- Printing reports
- Clearing memory
- Cleaning your printer
- Maintaining the cartridge
- Replacing the toner cartridge

PRINTING REPORTS

Your printer can provide various reports with useful information you will need. The following reports are available:

 Some reports may not appear in the display depending on options or models. If so, it is not applicable to your printer.

REPORT/LIST	DESCRIPTION
Configuration	This list shows the status of the user-selectable options. You may print this list to confirm your changes after changing settings.
Supplies Info	This list shows the current status of consumables in your printer.
Address Book	This list shows all of the fax numbers and email addresses currently stored in the printer's memory.
Send Report	This report shows the fax number, the number of pages, the elapsed time of the job, the communication mode, and the communication results for a particular fax job. You can set up your printer to automatically print a transmission confirmation report after each fax job. See "Sending options" on page 43.
Sent Report	This report shows information on the faxes and emails you have recently sent. You can set the printer to automatically print this report for every 50 communications. See "Sending options" on page 43.
Fax RCV Report	This report shows information on the faxes you have recently received.
Schedule Jobs	This list shows the documents currently stored for delayed faxes along with the starting time and type of each operation.
Junk Fax Report	This list shows the fax numbers specified as junk fax numbers. To add or delete numbers to or from this list, access the Junk Fax Setup menu. See "Receiving options" on page 43.
Network Info.	This list shows information on your printer's network connection and configuration.
User Auth List	This list shows authorized users who are allowed to use the email function.

- Replacing the imaging unit
- Replacing the waste toner container
- Maintenance parts
- Managing your printer from the website
- Checking the printer's serial number

Printing a report

1. Press **Menu** until **System Setup** appears on the bottom line of the display and press **OK**.
2. Press the left/right arrow until **Report** appears and press **OK**.
3. Press the left/right arrow until the report or list you want to print appears and press **OK**.
To print all reports and lists, select **All Report**.
4. Press **OK** when **Yes** appears to confirm printing.
The selected information prints out.

ADJUSTING THE COLOR CONTRAST

Color menu allows you to adjust the color setting.

1. Press **Menu** until **System Setup** appears on the bottom line of the display and press **OK**.
 2. Press **OK** when **Maintenance** appears.
 3. Press the left/right arrow until **Color** appears and press **OK**.
 4. Press **OK** when **Custom Color** appears.
 5. Press the left/right arrow until the color menu you want appears on display and press **OK**.
Default optimizes color automatically. **Manual Adjust** allows you to manually adjust the color contrast for each cartridge. **Default** setting is recommended for getting best color quality.
-  If you have moved the printer, it is strongly recommended to operate this menu manually.
6. Press **Stop/Clear** to return to ready mode.

CLEARING MEMORY

You can selectively clear information stored in your printer's memory.

 Before clearing the memory, ensure that all fax jobs have been completed, or you will lose those jobs.

1. Press **Menu** until **System Setup** appears on the bottom line of the display and press **OK**.
2. Press the left/right arrow until **Clear Setting** appears and press **OK**.
3. Press the left/right arrow until the item you want to clear appears.

 Some menus may not appear in the display depending on options or models. If so, it is not applicable to your printer.

OPTIONS	DESCRIPTION
All Settings	Clears all of the data stored in memory and resets all of your settings to the factory default.
Fax Setup	Restores all of the fax options to the factory default.
Copy Setup	Restores all of the copy options to the factory default.
Scan Setup	Restores all of the scan options to the factory default.
System Setup	Restores all of the system options to the factory default.
Network Setup	Restores all of the network options to the factory default.
Address Book	Clears all of the fax number and email address entries stored in memory.
Sent Report	Clears all records of sent faxes and emails.
Fax RCV Report	Clears all records of received faxes.

4. Press **OK** when **Yes** appears.
5. Press **OK** again to confirm clearing.
6. Repeat steps 3 through 5 to clear another item.
7. Press **Stop/Clear** to return to ready mode.

CLEANING YOUR PRINTER

To maintain print and scan quality, follow the cleaning procedures below each time the toner cartridge is replaced or if print and scan quality problems occur.

-  Cleaning the cabinet of the printer with cleaning materials containing large amounts of alcohol, solvent, or other strong substances can discolor or distort the cabinet.
- If your printer or its surrounding is contaminated with toner, it is recommended that you to use cloth or tissue dampened with water to clean it. If you use a vacuum cleaner, toner blown into the air may be harmful.

Cleaning the outside

Clean the cabinet of the printer with a soft lint-free cloth. You can dampen the cloth slightly with water, but be careful not to let any water drip onto or into the printer.

Cleaning the inside

During the printing process, paper, toner, and dust particles can accumulate inside the printer. This buildup can cause print quality problems, such as toner specks or smearing. Cleaning the inside of the printer clears or reduces these problems.

1. Turn the printer off and unplug the power cord. Wait for the printer to cool down.
2. Using the handle, completely open the front cover.

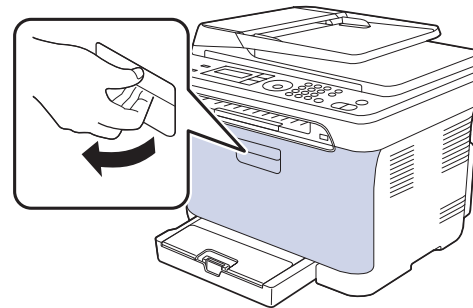

3. Grasp the handles on the toner cartridge and pull to remove the four cartridges from the printer.

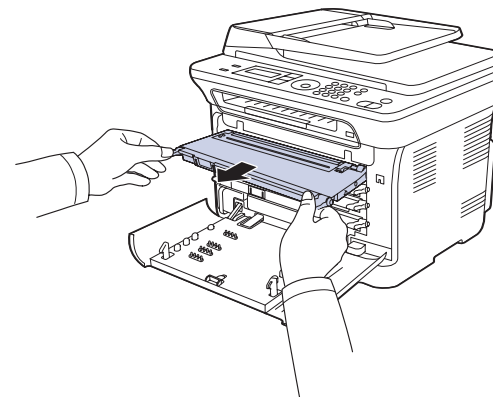

4. Pull the waste toner container out of the printer using its handle.

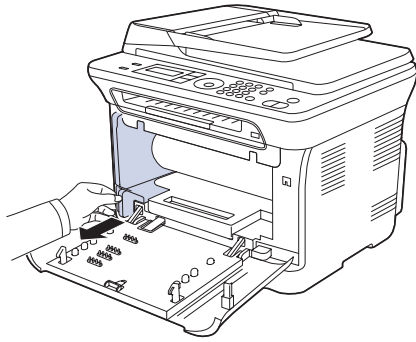

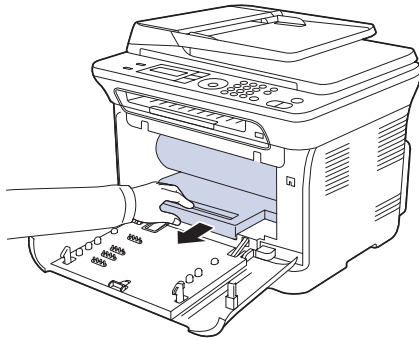

5. Pull the imaging unit out of the printer using the groove on the front of the imaging unit.

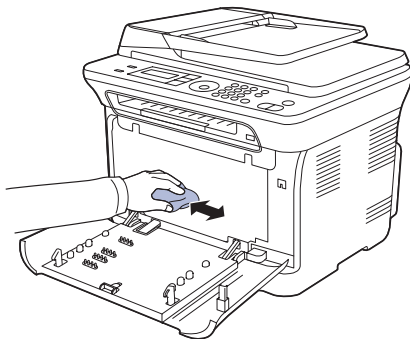

-  Do not touch the green surface, the imaging unit with your hands or any other material.
- Be careful not to scratch the surface of the imaging unit
 - If you leave the front cover open for more than a few minutes, the imaging unit can be exposed to light. This will cause damage to the imaging unit. Close the front cover if the installation needs to be halted for any reason.

6. With a dry lint-free cloth, wipe away any dust and spilled toner from the toner cartridges area and their cavities.



-  If toner gets on your clothing, wipe it off with a dry cloth and wash it in cold water. Do not use hot water as it sets the toner onto the fabric.
- If your printer or its surrounding is contaminated with toner, it is recommend that you use a cloth or tissue dampened with water to clean it. If you use a vacuum cleaner, toner blown into the air might be harmful to you.

 After cleaning, let the printer to dry completely.

7. Holding the groove on the front of the imaging unit, push the imaging unit in to the printer.

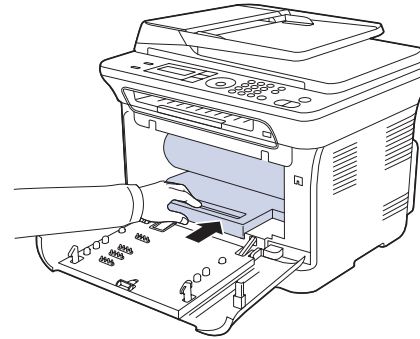

8. Insert the waste toner container into position and then push it to ensure that it is firmly seated in place.

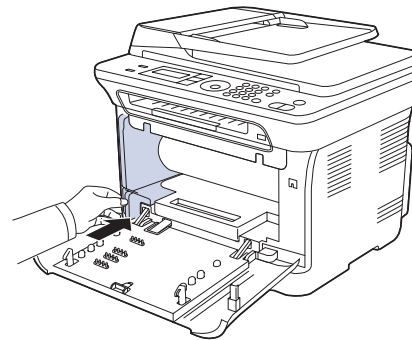

9. Slide the four toner cartridges back into the printer.

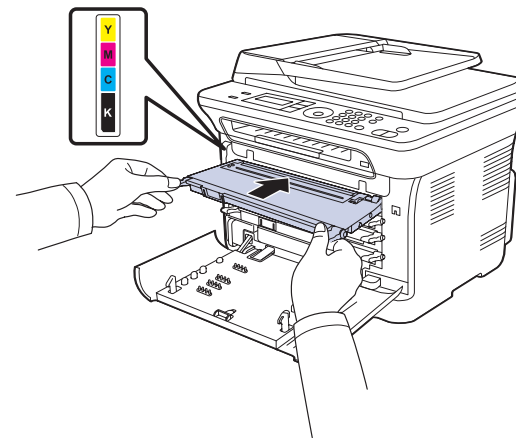

10. Reinstall all the compartments into the printer, and close the front cover.

 If the front cover is not completely closed, the printer will not operate.

11. Plug in the power cord and turn the printer on

Cleaning the scan unit

Keeping the scan unit clean helps ensure the best possible copies. It is recommended that you clean the scan unit at the start of each day and during the day, as needed.

1. Slightly dampen a soft lint-free cloth or paper towel with water.
2. Open the scanner lid.
3. Wipe the surface of the scanner glass until it is clean and dry.

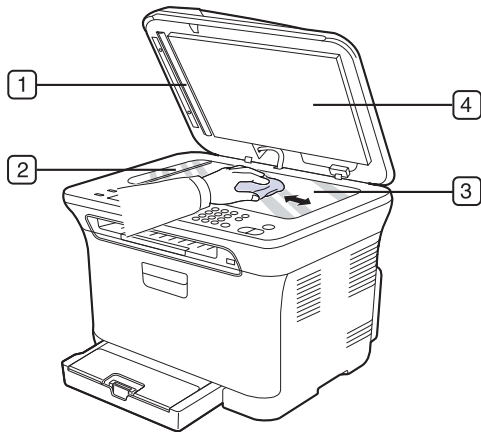

- | | |
|---|---------------|
| 1 | White sheet |
| 2 | ADF Sheet |
| 3 | Scanner glass |
| 4 | Scanner lid |

4. Wipe the underside of the scanner lid and white sheet until it is clean and dry.
5. Push the ADF sheet with any tool such as tweezers carefully.

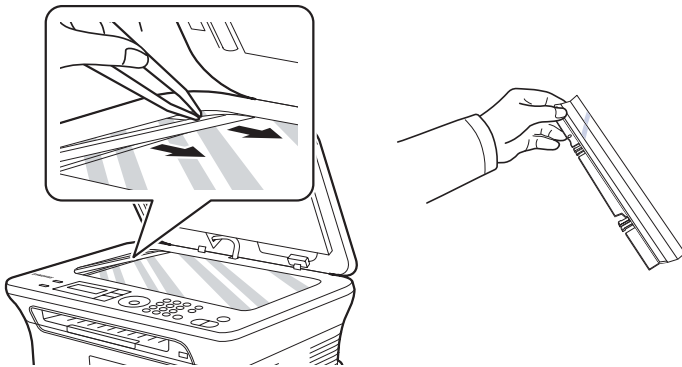

6. Hold the edge of the ADF sheet, and wipe both sides of the ADF sheet until it is clean and dry.

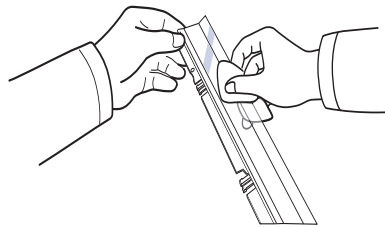

7. Push the ADF sheet back into the printer smoothly.

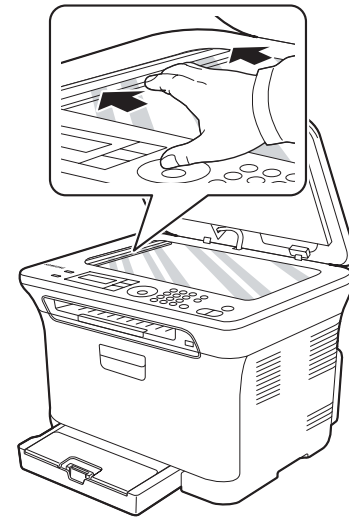

8. Close the scanner lid.

MAINTAINING THE CARTRIDGE

Toner cartridge storage

To get the most from the toner cartridge, keep the following guidelines in mind:

- Do not remove the toner cartridge from its package until it is ready for use.
- Do not refill the toner cartridge. The printer warranty does not cover damage caused by using a refilled cartridge.
- Store toner cartridges in the same environment as your printer.

Expected cartridge life

The life of the toner cartridge yield depends on the amount of toner that print jobs require. The actual number may also be different depending on the print density of the pages you print on, and the number of pages may be affected by operating environment, printing interval, media type, and media size. If you print a lot of graphics, you may need to change the cartridge more often.

Redistributing toner

When a toner is low, faded or light areas may appear. It is possible that colored images may be printed with incorrect colors due to flawed mixing of toner colors when one of the colored toner cartridges is low on toner. You can temporarily improve print quality by redistributing the toner.

- The toner-related message saying that the toner is low may appear on the display.

1. Using the handle, completely open the front cover.

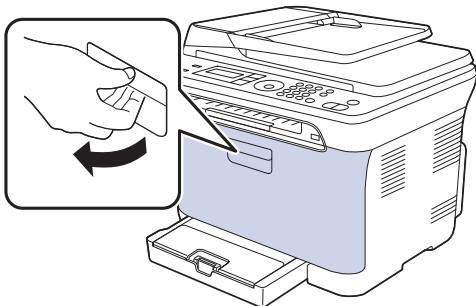

2. Grasp the handles on the toner cartridge and pull to remove the four cartridges from the printer.

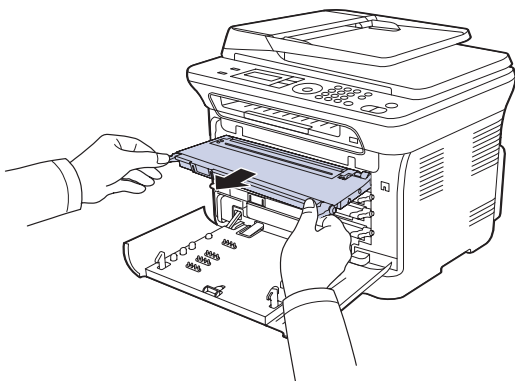

3. Holding both handles on the toner cartridge, thoroughly rock it from side to side to evenly distribute the toner.

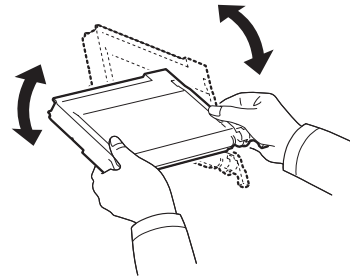

- ☞ If toner gets on your clothing, wipe it off with a dry cloth and wash it in cold water. Do not use hot water as it sets the toner onto the fabric.

4. Slide the four toner cartridges back into the printer.

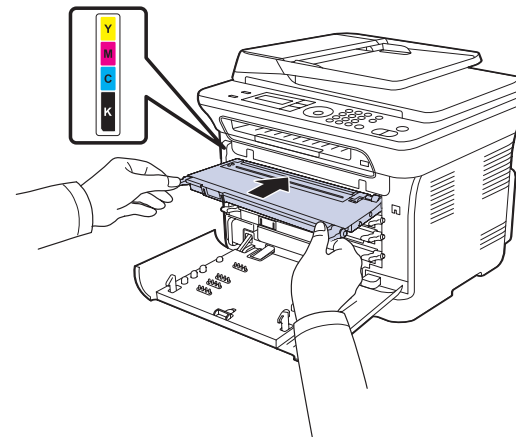

5. Close the front cover. Ensure that the cover is securely latched.

- ⚠ If the front cover is not completely closed, the printer will not operate.

REPLACING THE TONER CARTRIDGE

The printer uses four colors and has a different toner cartridge for each one: yellow (Y), magenta (M), cyan (C), and black (K).

- The status LED and the toner-related message on the display indicates which toner cartridge should be replaced.
- Incoming faxes are saved in memory.

Also, the Dell Toner Management System™ program window appears on the computer indicating you to replace the cartridge.

At this stage, the toner cartridge needs to be replaced. Check the type of toner cartridge for your printer. (See "Ordering supplies" on page 71.)

1. Turn the printer off, then wait a few minutes for the printer to cool.
2. Using the handle, completely open the front cover.

3. Grasp the handles on the toner cartridge and pull to remove the cartridge from the printer.

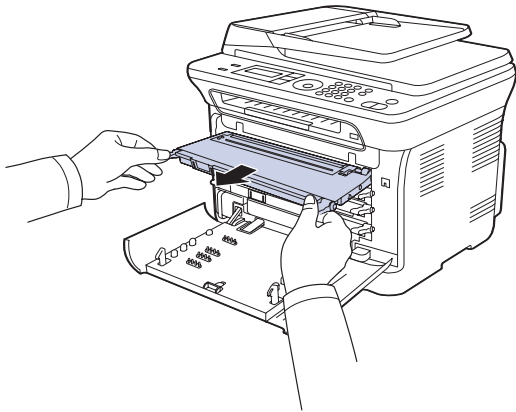

4. Take a new toner cartridge out of its package.

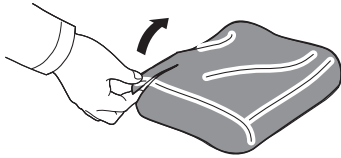

- ⚠ Do not use sharp objects, such as a knife or scissors, to open the toner cartridge package. You could damage the surface of the toner cartridge.

5. Holding both handles on the toner cartridge, thoroughly rock it from side to side to evenly distribute the toner.

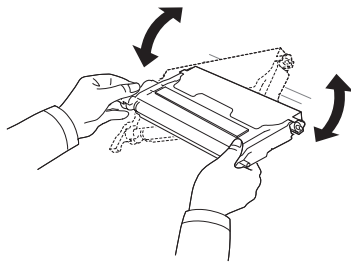

6. Place the toner cartridge on a flat surface, as shown, and remove the protecting cover.

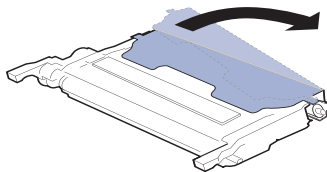

- ⚠ If toner gets on your clothing, wipe it off with a dry cloth and wash it in cold water. Do not use hot water as it sets the toner onto the fabric.

7. Ensure that the color of the toner cartridge matches the color slot and then grasp the handles on the toner cartridge. Insert the cartridge until it clicks into place.

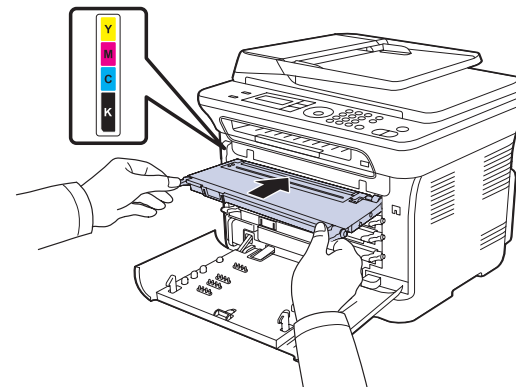

8. Close the front cover. Ensure the cover is securely latched, and then turn the printer on.

- ⚠ If the front cover is not completely closed, the printer will not operate.

REPLACING THE IMAGING UNIT

When the life span of the imaging unit has expired, the Dell Toner Management System™ program window appears on the computer, indicating the imaging unit needs to be replaced. If the imaging unit is not replaced, your printer fails to print.

1. Turn the printer off, then wait a few minutes for the printer to cool.
2. Using the handle, completely open the front cover.

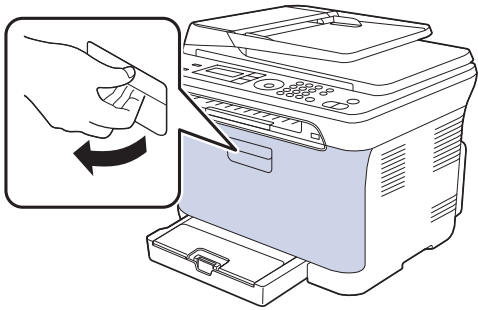

3. Grasp the handles on the toner cartridge and pull to remove the four cartridges from the printer.

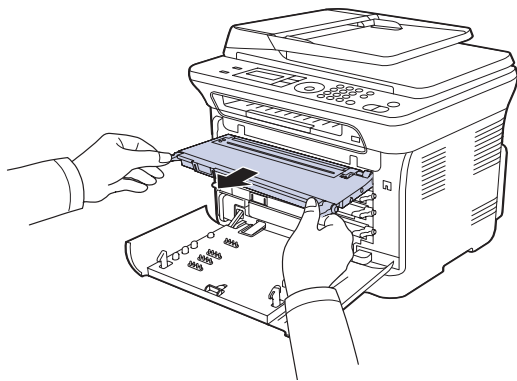

4. Pull the waste toner container out of the printer using its handle.

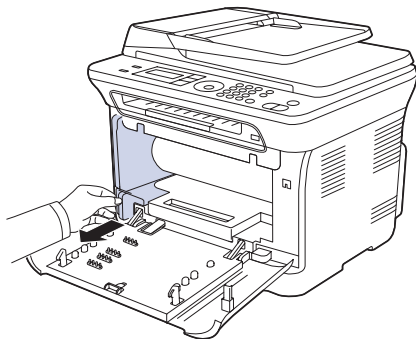

5. Pull the imaging unit out of the printer using the groove on the front of the imaging unit.

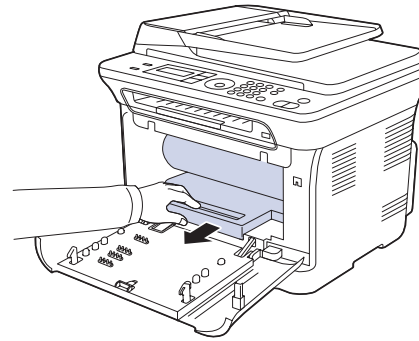

6. Take a new imaging unit out of its package. Remove the protective devices on both sides of the imaging unit and the paper protecting the surface of the imaging unit.

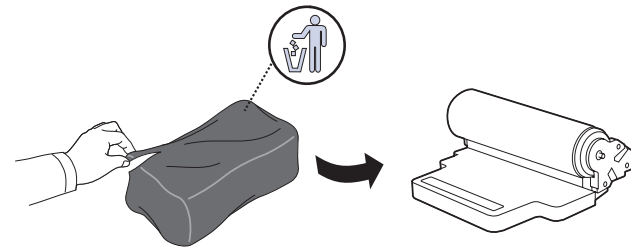

- Do not use sharp objects, such as a knife or scissors, to open the imaging unit package. You could damage the surface of the imaging unit.
- Be careful not to scratch the surface of the imaging unit.
- To prevent damage, do not expose the imaging unit to light for more than a few minutes. Cover it with a piece of paper to protect it if necessary.

7. Holding the groove on the front of the imaging unit, push imaging unit into the printer.

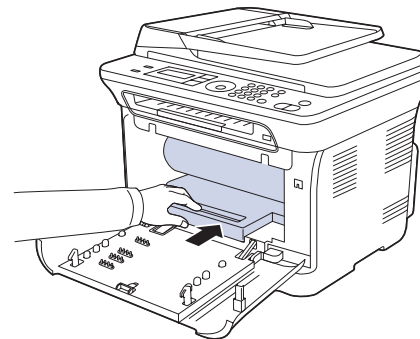

8. Insert the waste toner container into position and then push it to ensure that it is firmly seated in place.

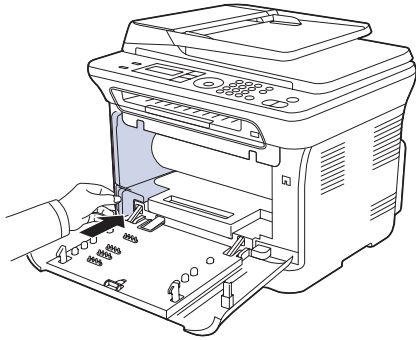

9. Slide the four toner cartridges back into the printer.

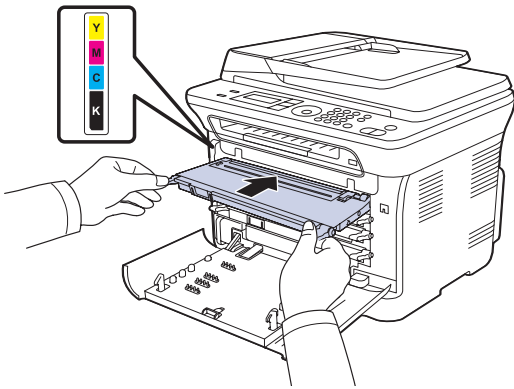

10. Close the front cover firmly.

 If the front cover is not completely closed, the printer will not operate. Please ensure all toner cartridges are installed properly. If any toner cartridge is installed improperly, the front cover does not close.

11. Turn the printer on.

 It may take a few minutes for your printer to get ready.

REPLACING THE WASTE TONER CONTAINER

When the life span of the waste toner container has expired, the Dell Toner Management System™ program window appears on the computer, indicating the waste toner container needs to be replaced. If the waste toner container is not replaced, your printer fails to print.

1. Turn the printer off, then wait a few minutes for the printer to cool.
2. Using the handle, completely open the front cover.

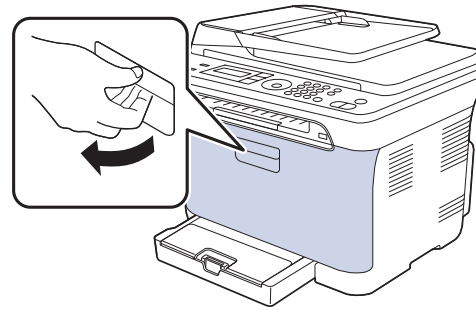

3. Pull the waste toner container out of the printer using its handle.

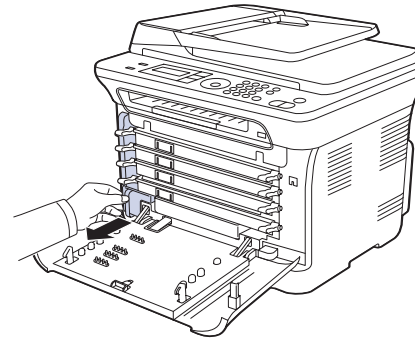

 Ensure that you lay the waste toner container on a flat surface so that the toner does not spill.

4. Remove the container's cap from the container as shown below, and use it to close the waste toner container opening.

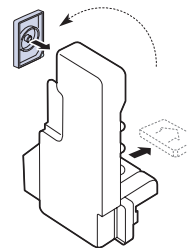

 Do not tilt or turn over the container.

5. Take a new waste toner container out of its package.

6. Insert the new container into position and then push it to ensure that it is firmly seated in place.

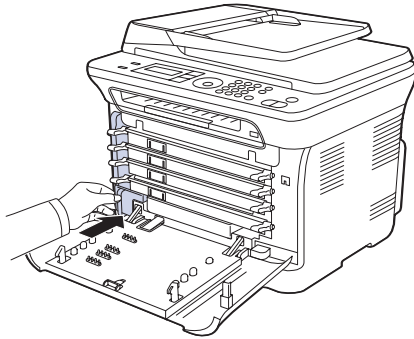

7. Close the front cover firmly.

 If the front cover is not completely closed, the printer will not operate.

8. Turn the printer on.

MAINTENANCE PARTS

To avoid print quality and paper feed problems resulting from worn parts, and to maintain your printer in top working condition, the following items will need to be replaced after the specified number of pages, or when the life span of each item has expired.

ITEMS	YIELD (AVERAGE)
Fuser unit	Approx. 100,000 black pages or 25,000 color pages
Transfer roller	Approx. 100,000 pages
Transfer unit (ITB)	Approx. 100,000 black pages or 25,000 color pages
Pick-up roller	Approx. 50,000 pages

It is highly recommended that this maintenance be performed by an authorized service provider, dealer, or the retailer where you purchased the printer. The warranty does not cover the replacement of the maintenance parts after their lifespan.

 The battery inside the printer is a service component. Do not change it by yourself.
There is a risk of explosion if battery is replaced by an incorrect type.
Dispose used batteries according to the instructions.

Checking replaceables

If you experience frequent paper jams or printing problems, check the number of pages the printer has printed or scanned. Replace the corresponding parts, if necessary.

1. Press **Menu** until **System Setup** appears on the bottom line of the display and press **OK**.
2. Press the left/right arrow until **Maintenance** appears and press **OK**.
3. Press the left/right arrow until **Supplies Life** appears and press **OK**.
4. Press the left/right arrow until the item you want appears and press **OK**.
 - **Supplies Info:** Prints the supply information page.
 - **Total:** Displays the total number of pages printed.

- **ADF Scan:** Displays the number of pages scanned using the ADF.
 - **Platen Scan:** Displays the number of pages scanned using the scanner glass.
 - **Imaging Unit, Transfer Belt, Fuser, TransferRoller, Tray1 Roller:** displays the number of pages printed each item.
5. If you selected to print a supply information page, press **OK** to confirm.
 6. Press **Stop/Clear** to return to ready mode.

MANAGING YOUR PRINTER FROM THE WEBSITE

If you have connected your printer to a network and set up TCP/IP network parameters correctly, you can manage the printer via Dell's **Embedded Web Service**, an embedded web server. Use **Embedded Web Service** to:

- View the printer's device information and check its current status.
- Change TCP/IP parameters and set up other network parameters.
- Change the printer properties.
- Set the printer to send email notifications to let you know the printer's status.
- Get support for using the printer.

To access Embedded Web Service:

1. Start a web browser, such as Internet Explorer, from Windows.
2. Enter the printer's IP address (<http://xxx.xxx.xxx.xxx>) in the address field and press the **Enter** key or click **Go**.
Your printer's embedded website opens.

CHECKING THE PRINTER'S SERIAL NUMBER

When you call for service or register as a user on the Dell website, the printer's serial number may be required.

You can identify the serial number by taking the following steps:

1. Press **Menu** until **System Setup** appears on the bottom line of the display and press **OK**.
2. Press the left/right arrow until **Maintenance** appears and press **OK**.
3. Press the left/right arrow until **Serial Number** appears and press **OK**.
4. Your printer's serial number appears.
5. Press **Stop/Clear** to return to ready mode.

troubleshooting

This chapter gives helpful information about what to do if you encounter an error.

This chapter includes:

- Tips for avoiding paper jams
- Clearing document jams
- Clearing paper jams

TIPS FOR AVOIDING PAPER JAMS

By selecting the correct media types, most paper jams can be avoided. When a paper jam occurs, follow the steps outlined on page 58.

- Follow the procedures on page 28. Ensure that the adjustable guides are positioned correctly.
- Do not overload the tray. Ensure that the paper level is below the paper capacity mark on the inside of the tray.
- Do not remove paper from the tray while your printer is printing.
- Flex, fan, and straighten paper before loading.
- Do not use creased, damp, or highly curled paper.
- Do not mix paper types in a tray.
- Use only recommended print media. (See "Setting the paper size and type" on page 29.)
- Ensure that the recommended side of the print media is facing up in the tray and manual feeder.

CLEARING DOCUMENT JAMS

When an original jams while passing through the ADF, **[Document Jam]** appears on the display.

1. Remove any remaining pages from the ADF.
2. Open the ADF cover.

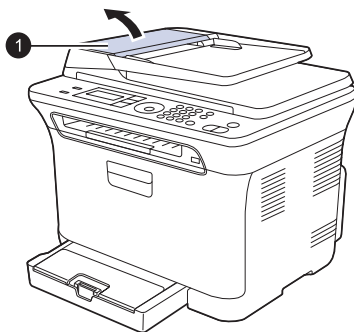

1 ADF cover

- Understanding display messages
- Solving other problems

3. Pull the jammed paper gently out of the ADF.

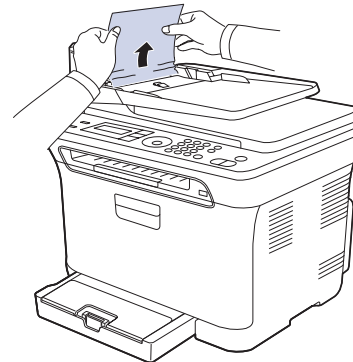

 This illustration may differ from your printer depending on its model.

4. Close the ADF cover. Then load the removed page(s), if any, back into the ADF.

 To prevent document jams, use the scanner glass for thick, thin, or mixed paper-type originals.

Exit misfeed

1. Remove any remaining pages from the ADF.
2. Seize the misfeed paper, and remove the paper from the document output tray by carefully pulling it to the right using both hands.

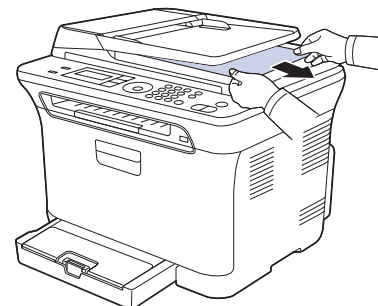

3. Load the removed pages back into the ADF.

Roller misfeed

1. Open the scanner lid.
2. Seize the misfeed paper, and remove the paper from the feed area by carefully pulling it to the right using both hands.

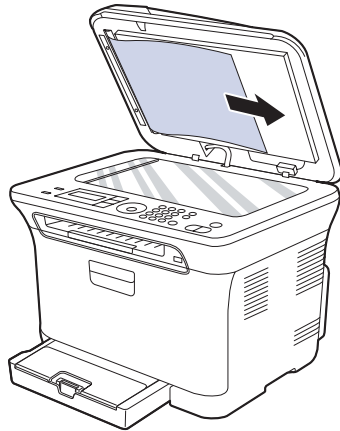



3. Close the scanner lid. Then load the removed pages back into the ADF.

CLEARING PAPER JAMS

When a paper jam occurs, the warning message appears on the display screen. Refer to the table below to locate and clear the paper jam.

MESSAGE	LOCATION OF JAM	GO TO
Paper Jam 0 Open/Close Door	In the paper feed area and inside the printer	See "In the tray 1" on page 59, "In the fuser unit area" on page 59.
Paper Jam 1 Check Inside	Inside the printer	See "In the tray 1" on page 59, "In the fuser unit area" on page 59.
Paper Jam 2 Check Inside	Inside the printer and in the fuser area	See "In the tray 1" on page 59, "In the fuser unit area" on page 59.

 Some messages may not appear in the display depending on options or models.

 To avoid tearing the paper, pull the jammed paper out gently and slowly. Follow the instructions in the following sections to clear the jam.

In the tray 1

1. Open and close the front cover. The jammed paper is automatically ejected from the printer.
If the paper does not exit, go to the next step.
2. Pull the tray 1 out of the printer.

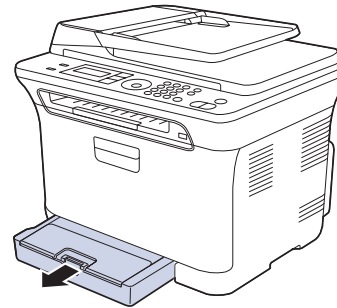

3. Remove the jammed paper by gently pulling it straight out.

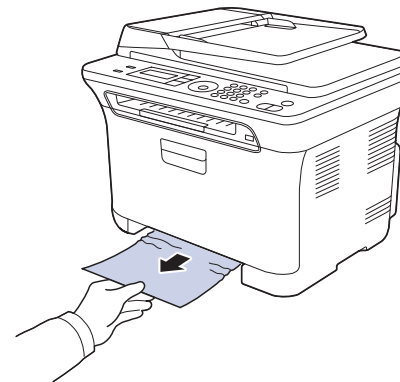

If the paper does not move when you pull, or if you do not see the paper in this area, check the paper exit area. See "In the paper exit area" on page 60.

4. Insert the tray 1 into the printer until it snaps into place. Printing automatically resumes.

In the fuser unit area

If paper is jammed in the fuser unit area, perform the following steps to release the jammed paper.

1. Open the scan unit.

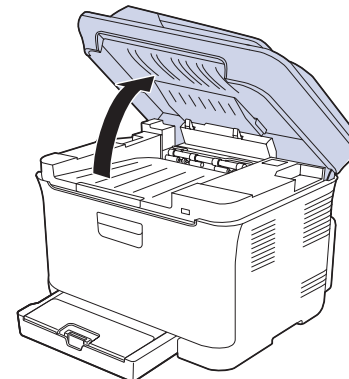

2. Open the inner cover.

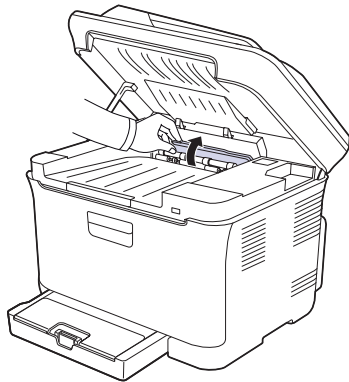

3. Carefully take the jammed paper out of the printer.

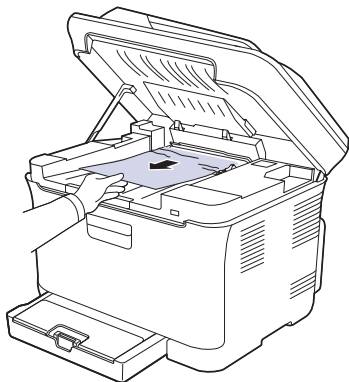

! Do not touch the fuser inside the inner cover. It is hot and could cause burns! The fuser's operating temperature is 180°C (356°F). Take care when removing paper from the printer.

4. Close the inner cover.
5. Lower down the scan unit gently and slowly until it is completely closed. Ensure that it is securely latched. Be careful not to pinch your fingers!

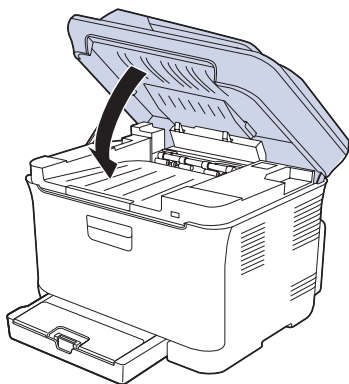

! If the scan unit is not completely closed, the printer will not operate.

In the paper exit area

1. Open and close the front cover. The jammed paper is automatically ejected from the printer.
2. Gently pull the paper out of the output tray.

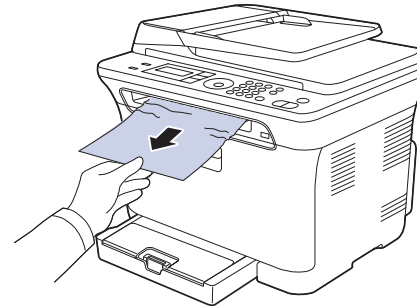

If you do not see the jammed paper or if there is any resistance when you pull, stop and go to the next step.

3. Open the rear cover.
4. If you see the jammed paper, pull it straight up. Skip to step 8.

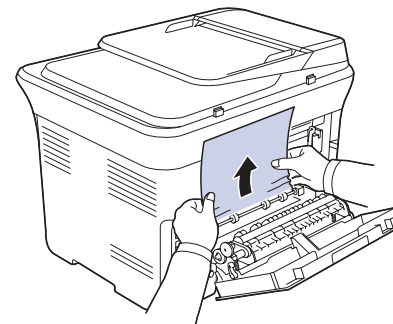

If you still do not see the paper, go to the next step.

5. Pull up the fuser lever.

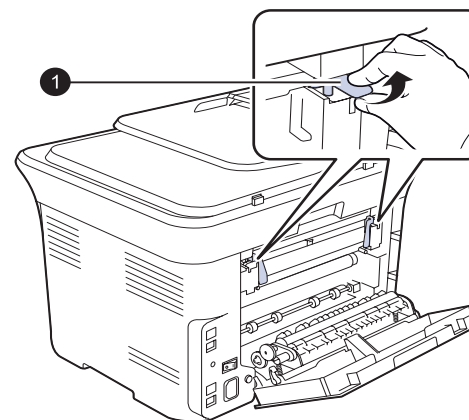

1 fuser lever

6. Open the scan unit.

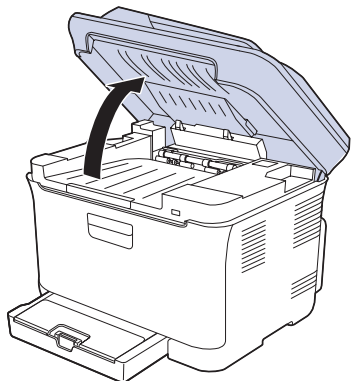

7. Carefully take the jammed paper out of the printer.

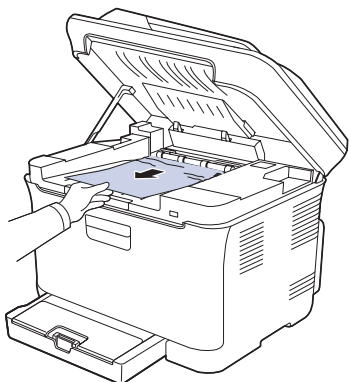

8. Lower down the scan unit gently and slowly until it is completely closed. Ensure that it is securely latched. Be careful not to pinch your fingers!

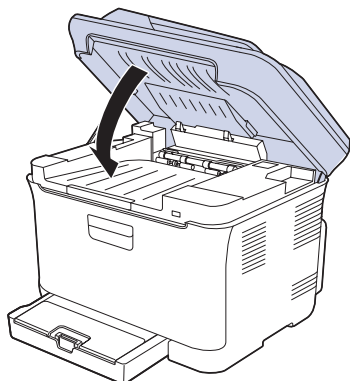

9. Pull down the fuser lever.

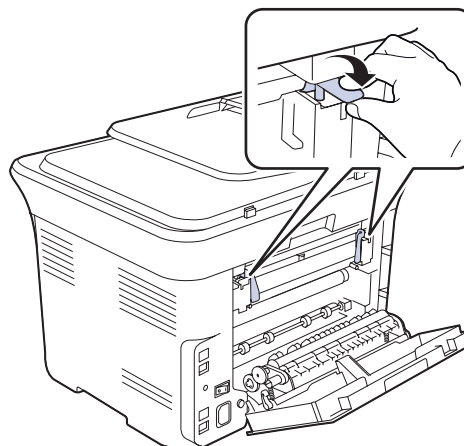

10. Close the rear cover. Printing automatically resumes.

UNDERSTANDING DISPLAY MESSAGES

Messages appear on the control panel display to indicate the printer's status or errors. Refer to the tables below to understand the messages' meaning and correct the problem if necessary. Messages and their meanings are listed in alphabetical order.



- If the message is not in the table, cycle the power and try the job again. If the problem persists, call for service.
- When you call for service, it is very convenient to provide the service representative with the contents of display message.
- xxx indicates the media type.

MESSAGE	MEANING	SUGGESTED SOLUTIONS
ADC Not Confirm Error	A problem has occurred in the ADC in the printer.	Turn the power switch off and on. If the problem persists, call for service.
Cancel? ◀ Yes ▶	Your printer's memory has become full while trying to store an original into memory.	To cancel the fax job, press the OK button to accept Yes . If you want to send those pages that have been successfully stored, press the OK button to accept No . You should send the remaining pages later, when memory is available.
[COMM. Error]	The printer has a communication problem.	Ask the sender to try again.
Connection Error	Connection with the SMTP server failed.	Check the server settings and the network cable.
Data Read Fail Check USB Mem.	Time expired while reading data.	Try again.
Data Write Fail Check USB Mem.	Storing to the USB memory failed.	Check the available USB memory space.
Deve Home Sensor Error	There is a problem in the fuser unit.	Turn the power switch off and on. If the problem persists, call for service.
[Document Jam]	The loaded original has jammed in the ADF.	Clear the jam. See "Clearing document jams" on page 58.
Door Open	The front cover or rear cover is not securely latched.	Close the cover until it locks into place.
Enter Again	You entered an unavailable item.	Enter the correct item again.
File Format Not Supported	The selected file format is not supported.	Use the correct file format.

MESSAGE	MEANING	SUGGESTED SOLUTIONS
Group Not Available	You have tried to select a group location number where only a single location number can be used, such as when adding locations for a Multiple Send operation.	Use a speed dial number or dial a number manually using the number keypad.
Install Imaging Unit	The imaging unit is not installed.	Install the imaging unit.
Install Toner ▼	The toner cartridge is not installed.	Install the toner cartridge.
Invalid Toner ▼	The toner cartridge you have installed is not for your printer.	Install the a Dell-genuine toner cartridge designed for your printer.
[Incompatible]	The printer has received a fax from a source which is registered as a junk fax.	The received fax data will be deleted. Reconfirm junk fax setup. See "Receiving options" on page 43.
IP Conflict	The network IP address you have set is being used by someone else.	Check the IP address and reset it if necessary. See "Setting up the network" on page 18.
Line Busy	The receiving fax machine did not answer or the line is already engaged.	Try again after a few minutes.
[Line Error]	Your printer cannot connect with the receiving fax machine or has lost contact because of a problem with the phone line.	Try again. If the problem persists, wait an hour or so for the line to clear and try again. Or, turn the ECM mode on. See "Sending options" on page 43.
Low Heat Error Cycle Power	There is a problem in the fuser unit.	Turn the power switch off and on. If the problem persists, call for service.
LSU Motor Error Cycle Power	A problem has occurred in the LSU (Laser Scanning Unit.)	Turn the power switch off and on. If the problem persists, call for service.
LSU Hsync Error Cycle Power	A problem has occurred in the LSU (Laser Scanning Unit.)	Turn the power switch off and on. If the problem persists, call for service.
Mail Exceeds Server Support	The mail size is larger than the supported size by SMTP server.	Divide your mail or reduce the resolution.
Main Motor Locked	There is a problem in the main motor.	Open and then close the front cover.

MESSAGE	MEANING	SUGGESTED SOLUTIONS
Memory Full	The memory is full.	Delete unnecessary fax jobs and retransmit after more memory becomes available. Alternatively, split the transmission into more than one operation.
Network Error	There is a problem with the network.	Contact your network administrator.
[No Answer]	The receiving fax machine has not answered after several redial attempts.	Try again. Ensure that the receiving printer is operational.
NonDELL Toner ▼	The toner cartridge which the arrow indicates is not a Dell-genuine cartridge. Press OK to toggle the message to Stop or Continue . ◀ Stop ▶	You can select either Stop or Continue with the left/right arrow. If you select Stop by pressing OK on the control panel, the printer stops printing. If you select Continue , the printer keeps printing, but the quality cannot be guaranteed. If you do not select any, the printer will work as Stop is selected. Replace the corresponding toner cartridge with a Dell-genuine cartridge. See "Replacing the toner cartridge" on page 53.
Not Assigned	The speed button or speed dial number you tried to use has no number assigned to it.	Enter the number manually using the number keypad or store the number or address.
One Page is Too Large	Single page data exceeds the configured mail size.	Reduce the resolution and try again.
Open Heat Error Cycle Power	There is a problem in the fuser unit.	Turn the power switch off and on. If the problem persists, call for service.
Operation Not Assigned	You are in the Add Page/Cancel Job operation, but there are no jobs stored.	Check the display to see if there are any scheduled jobs.
Out-Bin Full	The output tray of the printer is full of paper.	Remove paper.
Over Heat Error Cycle Power	There is a problem in the fuser unit.	Turn the power switch off and on. If the problem persists, call for service.

MESSAGE	MEANING	SUGGESTED SOLUTIONS
Paper Jam 0 Open/Close Door	Paper has jammed in the feeding area of the tray.	Clear the jam. See "In the tray 1" on page 59.
Paper Jam 1 Check Inside	Paper has jammed in the paper exit area.	Clear the jam. See "In the fuser unit area" on page 59.
Paper Jam 2 Check Inside	Paper has jammed In the fuser area or around the toner cartridge	Clear the jam. See "In the paper exit area" on page 60.
Refilled Toner ▼	The toner cartridge you have installed is not genuine or refilled. The arrow indicates which color toner cartridge.	The print quality may get poor if the refilled toner cartridge is installed, since its characteristics may significantly differ from the genuine. It is recommended to use Dell-genuine color toner cartridge.
Replace Toner ▼	This message appears between Toner Empty and Toner Low status.	Replace the toner cartridge with a new one. See "Replacing the toner cartridge" on page 53.
Replace [xxx]	The life of the part expires totally.	Replace the part with a new one. Call for service.
Replace [xxx] Soon	The life of the part expires soon.	See "Checking replaceables" on page 57 and call for service.
Replace/Install Toner Waste Bin	The life span of the waste toner tank has expired and the printer will stop printing until the waste toner tank is replaced.	Replace the waste toner bank with a new one. See "Replacing the waste toner container" on page 56.
Retry Redial?	The printer is waiting for a specified time interval to redial a previously busy station.	You can press OK to immediately redial, or Stop/Clear to cancel the redial operation.
Scan Unit Open	The scan unit is not securely latched.	Close the scan unit until it locks into place.
Scanner locked	The scanner module is locked	Turn the power switch off and on. If the problem persists, call for service.
Send Error (AUTH)	There is a problem in SMTP authentication.	Configure the authentication setting.
Send Error (DNS)	There is a problem in DNS.	Configure the DNS setting.
Send Error (POP3)	There is a problem in POP3.	Configure the POP3 setting.

MESSAGE	MEANING	SUGGESTED SOLUTIONS
Send Error (SMTP)	There is a problem in SMTP.	Change to the available server.
Send Error (Wrong Config)	There is a problem on the network interface card.	Configure your network interface card correctly.
[Stop Pressed]	Stop/Clear has been pressed during an operation.	Try again.
Toner Empty ▼	<p>The toner cartridge has run out. The printer stops printing. Press OK to toggle the message to Stop or Continue or Black Only.</p> <p>◀ Stop ▶</p> <p> If the black toner cartridge is empty, Black Only message does not appear.</p>	<p>You can select the option among Stop, Continue or Black Only with the left/right arrow. If you select Stop by pressing OK on the control panel, the printer stops printing. If you select Continue, the printer keeps printing, but the quality cannot be guaranteed. If you select Black Only, the printer prints the data in black. In this case, the mono printing feature is preset in the printer properties. When you copy, the Black Start button will be activated only with this condition. If you do not select any, the printer will work as Stop is selected. Replace the toner cartridge with a new one. See "Replacing the toner cartridge" on page 53.</p>
Toner Exhausted ▼	The lifespan of the toner cartridge which the arrow indicates is reached.	This message appears when the toner is completely empty, and your printer stops printing. Replace the corresponding toner cartridge with a Dell-genuine cartridge. See "Replacing the toner cartridge" on page 53.
Toner Low ▼	The corresponding toner cartridge is almost empty.	Take out the toner cartridge and thoroughly shake it. By doing this, you can temporarily reestablish printing operations.

MESSAGE	MEANING	SUGGESTED SOLUTIONS
Transfer Belt Error	A problem has occurred in the transfer belt in the printer.	Turn the power switch off and on. If the problem persists, call for service.
Tray Paper Empty	There is no paper in the tray.	Load paper in the tray.
Tray Paper Mismatch	The paper size specified in the printer properties does not match the paper you are loading.	Load the correct paper in the tray.

SOLVING OTHER PROBLEMS

The following chart lists some conditions that may occur and the recommended solutions. Follow the suggested solutions until the problem is resolved. If the problem persists, call for service

Paper feeding

CONDITION	SUGGESTED SOLUTIONS
Paper is jammed during printing	Clear the paper jam. See "Tips for avoiding paper jams" on page 58.
Paper sticks together	<ul style="list-style-type: none"> Ensure there is not too much paper in the tray. The tray can hold up to 150 sheets of paper, depending on the thickness of your paper. Ensure that you are using the correct type of paper. See "Setting the paper size and type" on page 29. Remove paper from the tray and flex or fan the paper. Humid conditions may cause some paper to stick together.
Multiple sheets of paper do not feed	<ul style="list-style-type: none"> Different types of paper may be stacked in the tray. Load paper of only one type, size, and weight. If multiple sheets have caused a paper jam, clear the paper jam. See "Tips for avoiding paper jams" on page 58.
Paper does not feed into the printer	<ul style="list-style-type: none"> Remove any obstructions from inside the printer. Paper has not been loaded correctly. Remove paper from the tray and reload it correctly. There is too much paper in the tray. Remove excess paper from the tray. The paper is too thick. Use only paper that meets the specifications required by the printer. See "Selecting print media" on page 24. If an original does not feed into the printer, the ADF rubber pad may require to be replaced. Contact a service representative.
The paper keeps jamming	<ul style="list-style-type: none"> There is too much paper in the tray. Remove excess paper from the tray. If you are printing on special materials, use the manual feeder. An incorrect type of paper is being used. Use only paper that meets the specifications required by the printer. See "Selecting print media" on page 24. There may be debris inside the printer. Open the front cover and remove the debris. If an original does not feed into the printer, the ADF rubber pad may require to be replaced. Contact a service representative.
Envelopes skew or fail to feed correctly	Ensure the paper guides are against both sides of the envelopes.

Printing problems

CONDITION	POSSIBLE CAUSE	SUGGESTED SOLUTIONS
The printer does not print	The printer is not receiving power.	Check the power cord connections. Check the power switch and the power source.
	The printer is not selected as the default printer.	Select Dell 1235cn Color Laser MFP as your default printer in Windows.
	Check the printer for the following: <ul style="list-style-type: none"> The front cover or rear cover is not closed. Close the cover. Paper is jammed. Clear the paper jam. See "Clearing paper jams" on page 59. No paper is loaded. Load paper. The toner cartridge is not installed. Install the toner cartridge. If a system error occurs, contact your service representative. 	
	The connection cable between the computer and the printer is not connected properly.	Disconnect the printer cable and reconnect it.
	The connection cable between the computer and the printer is defective.	If possible, attach the cable to another computer that is working properly and print a job. You can also try using a different printer cable.
	The port setting is incorrect.	Check the Windows printer setting to ensure that the print job is sent to the correct port. If the computer has more than one port, ensure that the printer is attached to the correct one.
	The printer may be configured incorrectly.	Check the printer properties to ensure that all of the print settings are correct.
	The printer driver may be incorrectly installed.	Reinstall the printer software. See <i>Software section</i> .
	The printer is malfunctioning.	Check the display message on the control panel to see if the printer is indicating a system error.
	The document size is so big that the hard disk space of the computer is not enough to access the print job.	Get more hard disk space and print the document again.





CONDITION	POSSIBLE CAUSE	SUGGESTED SOLUTIONS
The printer selects print materials from the wrong paper source	The paper source selection in the printer properties may be incorrect.	For many software applications, the paper source selection is found under the Thin Paper tab within the printer properties. Select the correct paper source. See the printer driver help screen.
A print job is extremely slow	The job may be very complex.	Reduce the complexity of the page or try adjusting the print quality settings.
Half of the page is blank	The page orientation setting may be incorrect.	Change the page orientation in your application. See the printer driver help screen.
	The paper size and the paper size settings do not match.	Ensure that the paper size in the printer driver settings matches the paper in the tray. Or, ensure that the paper size in the printer driver settings matches the paper selection in the software application settings you use.
The printer prints, but the text is wrong, garbled, or incomplete	The printer cable is loose or defective.	Disconnect the printer cable and reconnect. Try a print job that you have already printed successfully. If possible, attach the cable and the printer to another computer and try a print job that you know works. Finally, try a new printer cable.
	The wrong printer driver was selected.	Check the application's printer selection menu to ensure that your printer is selected.
	The software application is malfunctioning.	Try printing a job from another application.
	The operating system is malfunctioning.	Exit Windows and reboot the computer. Turn the printer off and then back on again.
Pages print, but are blank	The toner cartridge is defective or out of toner.	Redistribute the toner, if necessary. See "Redistributing toner" on page 53. If necessary, replace the toner cartridge.
	The file may have blank pages.	Check the file to ensure that it does not contain blank pages.
	Some parts, such as the controller or the board, may be defective.	Contact a service representative.

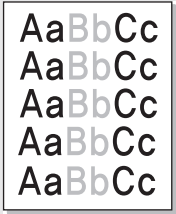
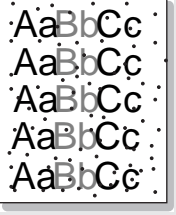

CONDITION	POSSIBLE CAUSE	SUGGESTED SOLUTIONS
The printer does not print PDF file correctly. Some parts of graphics, text, or illustrations are missing	Incompatibility between the PDF file and the Acrobat products.	Printing the PDF file as an image may solve this problem. Turn on Print As Image from the Acrobat printing options.  It will take longer to print when you print a PDF file as an image.
The print quality of photos is not good. Images are not clear	The resolution of the photo is very low.	Reduce the photo size. If you increase the photo size in the software application, the resolution will be reduced.
Before printing, the printer emits vapor near the output tray	Using damp paper can cause vapor during printing.	This is not a problem. Just keep printing.

Printing quality problems

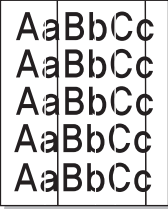
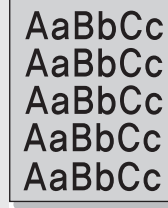
If the inside of the printer is dirty or paper has been loaded improperly, you may notice a reduction in print quality. See the table below to clear the problem.

CONDITION	SUGGESTED SOLUTIONS
Light or faded print 	<p>If a vertical white streak or faded area appears on the page:</p> <ul style="list-style-type: none"> The toner supply is low. You may be able to temporarily extend the toner cartridge life. See "Replacing the toner cartridge" on page 53. If this does not improve the print quality, install a new toner cartridge. The paper may not meet paper specifications; for example, the paper is too moist or too rough. See "Selecting print media" on page 24. If the entire page is light, the print resolution setting is too low. Adjust the print resolution. See the help screen of the printer driver. A combination of faded or smeared defects may indicate that the toner cartridge needs cleaning. The surface of the LSU part inside the printer may be dirty. Clean the LSU, contact a service representative.
Toner specks 	<ul style="list-style-type: none"> The paper may not meet specifications; for example, the paper is too moist or too rough. See "Selecting print media" on page 24. The paper path may need cleaning. See "Cleaning the inside" on page 50.

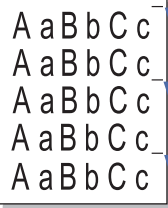
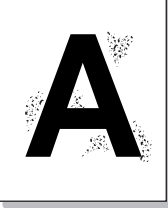
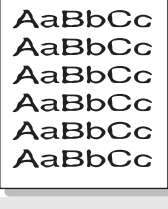
CONDITION	SUGGESTED SOLUTIONS
Dropouts 	<p>If faded areas, generally rounded, occur randomly on the page:</p> <ul style="list-style-type: none"> A single sheet of paper may be defective. Try reprinting the job. The moisture content of the paper is uneven or the paper has moist spots on its surface. Try a different brand of paper. See "Selecting print media" on page 24. The paper lot is bad. The manufacturing processes can cause some areas to reject toner. Try a different kind or brand of paper. Change the printer option and try again. Go to printer properties, click Paper tab, and set type to Thick Paper. Refer to the <i>Software section</i> for details. <p>If these steps do not correct the problem, contact a service representative.</p>
White Spots 	<p>White spots appear on the page:</p> <ul style="list-style-type: none"> The paper is too rough and a lot of dirt from the paper falls to the inner devices within the printer, which means the transfer belt may be dirty. Clean the inside of your printer. Contact a service representative. The paper path may need cleaning. Contact a service representative.
Vertical lines 	<p>If black vertical streaks appear on the page:</p> <ul style="list-style-type: none"> The drum inside the toner cartridge has probably been scratched. Remove the toner cartridge and install a new one. See "Replacing the toner cartridge" on page 53. <p>If white vertical streaks appear on the page:</p> <ul style="list-style-type: none"> The surface of the LSU part inside the printer may be dirty. Clean the LSU, contact a service representative.
Color or Black background 	<p>If the amount of background shading becomes unacceptable:</p> <ul style="list-style-type: none"> Change to a lighter weight paper. See "Selecting print media" on page 24. Check the printer's environment: very dry (low humidity) or high humidity (higher than 80% RH) conditions can increase the amount of background shading. Remove the old toner cartridge and install a new one. See "Replacing the toner cartridge" on page 53.
Toner smear 	<ul style="list-style-type: none"> Clean the inside of the printer. See "Cleaning the inside" on page 50. Check the paper type and quality. See "Selecting print media" on page 24. Remove the toner cartridge and install a new one. See "Replacing the toner cartridge" on page 53.

CONDITION	SUGGESTED SOLUTIONS
Vertical repetitive defects 	<p>If marks repeatedly appear on the printed side of the page at even intervals:</p> <ul style="list-style-type: none"> The toner cartridge may be damaged. If a repetitive mark occurs on the page, print a cleaning sheet several times to clean the cartridge. After the printout, if you still have the same problems, remove the toner cartridge and install a new one. See "Replacing the toner cartridge" on page 53. Parts of the printer may have toner on them. If the defects occur on the back of the page, the problem will likely correct itself after a few more pages. The fusing assembly may be damaged. Contact a service representative.
Background scatter 	<p>Background scatter results from bits of toner randomly distributed on the printed page.</p> <ul style="list-style-type: none"> The paper may be too damp. Try printing with a different batch of paper. Do not open packages of paper until necessary so that the paper does not absorb too much moisture. If background scatter occurs on an envelope, change the printing layout to avoid printing over areas that have overlapping seams on the reverse side. Printing on seams can cause problems. If background scatter covers the entire surface area of a printed page, adjust the print resolution through your software application or the printer properties.
Misformed characters 	<ul style="list-style-type: none"> If characters are improperly formed and producing hollow images, the paper stock may be too slick. Try a different paper. See "Selecting print media" on page 24. If characters are improperly formed and producing a wavy effect, the scanner unit may need service. For service, contact a service representative.
Page skew 	<ul style="list-style-type: none"> Ensure that the paper is loaded properly. Check the paper type and quality. See "Selecting print media" on page 24. Ensure that the paper or other material is loaded correctly and the guides are not too tight or too loose against the paper stack.

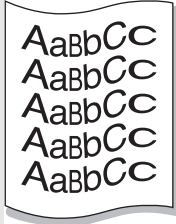
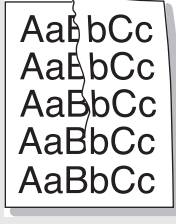
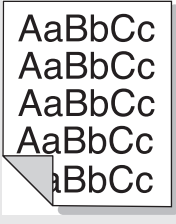
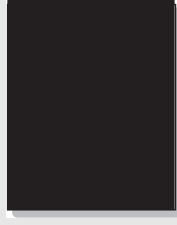
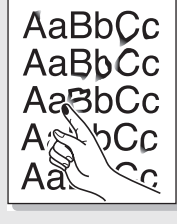
CONDITION	SUGGESTED SOLUTIONS
Curl or wave 	<ul style="list-style-type: none"> Ensure that the paper is loaded properly. Check the paper type and quality. Both high temperature and humidity can cause paper curl. See "Selecting print media" on page 24. Turn over the stack of paper in the tray. Also try rotating the paper 180° in the tray.
Wrinkles or creases 	<ul style="list-style-type: none"> Ensure that the paper is loaded properly. Check the paper type and quality. See "Selecting print media" on page 24. Turn over the stack of paper in the tray. Also try rotating the paper 180° in the tray.
Back of printouts are dirty 	<ul style="list-style-type: none"> Check for leaking toner. Clean the inside of the printer. See "Cleaning the inside" on page 50.
Solid Color or Black pages 	<ul style="list-style-type: none"> The toner cartridge may not be installed properly. Remove the cartridge and reinsert it. The toner cartridge may be defective and need replacing. Remove the toner cartridge and install a new one. See "Replacing the toner cartridge" on page 53. The printer may require repair. Contact a service representative.
Loose toner 	<ul style="list-style-type: none"> Clean the inside of the printer. See "Cleaning the inside" on page 50. Check the paper type and quality. See "Selecting print media" on page 24. Remove the toner cartridge and install a new one. See "Replacing the toner cartridge" on page 53. If the problem persists, the printer may require repair. Contact a service representative.

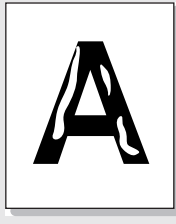
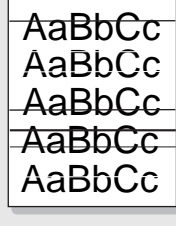
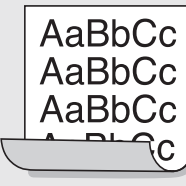
CONDITION	SUGGESTED SOLUTIONS
Character Voids 	<p>Character voids are white areas within parts of characters that should be solid black:</p> <ul style="list-style-type: none"> If you are using transparencies, try another type of transparency. Because of the composition of transparencies, some character voids are normal. You may be printing on the wrong surface of the paper. Remove the paper and turn it around. The paper may not meet paper specifications. See "Selecting print media" on page 24.
Horizontal stripes 	<p>If horizontally aligned black streaks or smears appear:</p> <ul style="list-style-type: none"> The toner cartridge may be installed improperly. Remove the cartridge and reinsert it. The toner cartridge may be defective. Remove the toner cartridge and install a new one. See "Replacing the toner cartridge" on page 53. If the problem persists, the printer may require repair. Contact a service representative.
Curl 	<p>If the printed paper is curled or paper does not feed into the printer:</p> <ul style="list-style-type: none"> Turn over the stack of paper in the tray. Also try rotating the paper 180° in the tray. Change the printer option and try again. Go to printer properties, click Paper tab, and set type to Thin Paper. Refer to the <i>Software section</i> for details.
An unknown image repetitively appears on a next few sheets or loose toner, light print, or contamination occurs.	<p>Your printer is probably being used at an altitude of 1,000 m (3,281 ft) or above. The high altitude may affect the print quality such as loose toner or light imaging. You can set this option through Printer Settings Utility or Printer tab in printer driver's properties. See "Altitude adjustment" on page 20.</p>

Copying problems

CONDITION	SUGGESTED SOLUTIONS
Copies are too light or too dark	<p>Use Darkness to darken or lighten the background of the copies.</p>
Smears, lines, marks, or spots appears on copies	<ul style="list-style-type: none"> If defects are on the original, press Darkness to lighten the background of your copies. If no defects are on the original, clean the scan unit. See "Cleaning the scan unit" on page 52.
Copy image is skewed	<ul style="list-style-type: none"> Ensure that the original is face down on the scanner glass or face up in the ADF. Check that the copy paper is loaded correctly.

CONDITION	SUGGESTED SOLUTIONS
Blank copies print out	Ensure that the original is face down on the scanner glass or face up in the ADF.
Image rubs off the copy easily	<ul style="list-style-type: none"> Replace the paper in the tray with paper from a new package. In high humidity areas, do not leave paper in the printer for extended periods of time.
Frequent copy paper jams occur	<ul style="list-style-type: none"> Fan the stack of paper, then turn it over in the tray. Replace the paper in the tray with a fresh supply. Check/adjust the paper guides, if necessary. Ensure that the paper is the proper paper weight. 75 g/m² (20 lb bond) paper is recommended. Check for copy paper or pieces of copy paper remaining in the printer after a paper jam has been cleared.
Toner cartridge produces fewer copies than expected before running out of toner	<ul style="list-style-type: none"> Your originals may contain pictures, solids, or heavy lines. For example, your originals may be forms, newsletters, books, or other documents that use more toner. The printer may be turned on and off frequently. The scanner lid may be left open while copies are being made.

Scanning problems

CONDITION	SUGGESTED SOLUTIONS
The scanner does not work	<ul style="list-style-type: none"> Ensure that you place the original to be scanned face down on the scanner glass, or face up in the ADF. There may not be enough available memory to hold the document you want to scan. Try the Prescan function to see if that works. Try lowering the scan resolution rate. Check that the USB cable is connected properly. Ensure that the USB cable is not defective. Switch the cable with a known good cable. If necessary, replace the cable. Check that the scanner is configured correctly. Check scan setting in the SmartThru Configuration or the application you want to use to make certain that the scanner job is being sent to the correct port.
The unit scans very slowly	<ul style="list-style-type: none"> Check if the printer is printing received data. If so, scan the document after the received data has been printed. Graphics are scanned more slowly than text. Communication speed slows in scan mode because of the large amount of memory required to analyze and reproduce the scanned image. Set your computer to the ECP printer mode through BIOS setting. It will help to increase the speed. For details about how to set BIOS, refer to your computer user's guide.
Message appears on your computer screen: <ul style="list-style-type: none"> "Device can't be set to the H/W mode you want." "Port is being used by another program." "Port is Disabled." "Scanner is busy receiving or printing data. When the current job is completed, try again." "Invalid handle." "Scanning has failed." 	<ul style="list-style-type: none"> There may be a copying or printing job in progress. When that job is complete, try your job again. The Selected port is currently being used. Restart your computer and try again. The printer cable may be improperly connected or the power may be off. The scanner driver is not installed or the operating environment is not set up properly. Ensure that the printer is properly connected and the power is on, Then restart your computer. The USB cable may be improperly connected or the power may be off.

Dell Scan Manager problems

CONDITION	SUGGESTED SOLUTIONS
I cannot use the Dell Scan Manager	Check your operating system. Supporting operating systems are Windows 2000/XP/Vista.

Fax problems

CONDITION	SUGGESTED SOLUTIONS
The printer is not working, there is no display and the buttons are not working	<ul style="list-style-type: none"> Unplug the power cord and plug it in again. Ensure that there is power to the electrical outlet.
No dial tone sounds	<ul style="list-style-type: none"> Check that the phone line is connected properly. Check that the phone socket in the wall is working by plugging in another phone.
The numbers stored in memory do not dial correctly	Ensure that the numbers are stored in memory correctly. Print a Address Book list, referring to page 45.
The original does not feed into the printer	<ul style="list-style-type: none"> Ensure that the paper is not wrinkled and you are putting it in correctly. Check that the original is the right size, not too thick or thin Ensure that the ADF is firmly closed. The ADF rubber pad may need to be replaced. Contact a service representative.
Faxes are not received automatically	<ul style="list-style-type: none"> The receiving mode should be set to Fax. Ensure that there is paper in the tray. Check to see if the display shows any error message. If it does, clear the problem.
The printer does not send	<ul style="list-style-type: none"> Ensure that the original is loaded in the ADF or on the scanner glass. Sending should show up on the display. Check the fax machine you are sending to, to see if it can receive your fax.
The incoming fax has blank spaces or is of poor-quality	<ul style="list-style-type: none"> The fax machine sending you the fax may be faulty. A noisy phone line can cause line errors. Check your printer by making a copy. The toner cartridge may be empty. Replace the toner cartridge, referring to page 53.
Some of the words on an incoming fax are stretched	The fax machine sending you the fax had a temporary document jam.
There are lines on the originals you send	Check your scan unit for marks and clean it. See "Cleaning the scan unit" on page 52.
The printer dials a number, but a connection with the other fax machine fails	The other fax machine may be turned off, out of paper, or cannot answer incoming calls. Speak with the other printer operator and ask her/him to sort out the problem.
Faxes do not store in memory	There may not be enough memory space to store the fax. If the display shows the Memory Full message, delete from memory any faxes you no longer need and then try again to store the fax.

CONDITION	SUGGESTED SOLUTIONS
Blank areas appear at the bottom of each page or on other pages, with a small strip of text at the top.	You may have chosen the wrong paper settings in the user option setting. For details about paper settings, see "Selecting print media" on page 24.

Common Windows problems

CONDITION	SUGGESTED SOLUTIONS
"File in Use" message appears during installation	Exit all software applications. Remove all software from the StartUp Group, then restart Windows. Reinstall the printer driver.
"General Protection Fault", "Exception OE", "Spool32", or "Illegal Operation" messages appear	Close all other applications, reboot Windows and try printing again.
"Fail To Print", "A printer timeout error occurred." messages appear	These messages may appear during printing. Just keep waiting until the printer finishes printing. If the message appears in ready mode or after printing has been completed, check the connection and/or whether an error has occurred.

 Refer to the Microsoft Windows documentation that came with your computer for further information on Windows error messages.

Common Macintosh problems

CONDITION	SUGGESTED SOLUTIONS
The printer does not print PDF file correctly. Some parts of graphics, text, or illustrations are missing	<p>Incompatibility between the PDF file and the Acrobat products: Printing the PDF file as an image may solve this problem. Turn on Print As Image from the Acrobat printing options.</p> <p> It will take longer to print when you print a PDF file as an image.</p>
The document has printed, but the print job has not disappeared from the spooler in Mac OS 10.3.2	Update your Mac OS to OS 10.3.3. or higher.
Some letters are not displayed normally during the Cover page printing	This problem is caused because Mac OS cannot create the font during the Cover page printing. English alphabet and numbers are displayed normally at the Cover page.

 Refer to Mac OS User's Guide that came with your computer for further information on Mac OS error messages.

ordering supplies

This chapter provides information on purchasing cartridges and accessories available for your printer.

This chapter includes:

- Supplies



The optional parts or features may differ by countries. Contact your sales representatives whether the part you want is available in your country.

SUPPLIES

When the toner runs out, you can order the following type of toner cartridge for your printer:

TYPE	AVERAGE YIELD ^a	PART NUMBER
Standard yield toner cartridge	<ul style="list-style-type: none">• Average continuous black cartridge yield: 1,500 standard pages (Black)• Average continuous colored cartridge yield: 1,000 standard pages (Yellow/Magenta/Cyan)	Y924J (Black) C815K (Cyan) D593K (Magenta) F479K (Yellow)
Imaging unit	Approx. 24,000 images ^b	C920K
Waste toner container	Approx. 10,000 images ^b (Full color 5% image)	F562K

a. Declared yield value in accordance with ISO/IEC 19798.

b. Image counts based on one color on each page. If you print documents in full color (Cyan, Magenta, Yellow, Black), the life of this item will be reduced by 25%.



When purchasing new print cartridges or other supplies, these must be purchased in the same country where the printer was purchased. Otherwise, print cartridges or other supplies will be incompatible with your printer, as configurations of print cartridges and other supplies vary, depending on the specific country.

- How to purchase

HOW TO PURCHASE

To order Dell-authorized supplies or accessories, contact your local Dell dealer or the retailer where you purchased your printer, or visit www.dell.com and support.dell.com and select your country/region to obtain information on calling for technical support.

specifications

This chapter guides you about this printer's specifications such as various features.

This chapter include:

- General specifications
- Printer specifications
- Scanner specifications
- Copier specifications
- Facsimile specifications

GENERAL SPECIFICATIONS

 The symbol * optional feature depending on printers.

ITEM	DESCRIPTION
ADF Capacity	Up to 15 sheets 75 g/m ² (20 lb bond)
ADF document size	<ul style="list-style-type: none">• Width: 5 to 8.5 inches (127 to 216 mm)• Length: 5.8 to 14 inches (148 to 356 mm)
Paper input capacity	Tray: 150 sheets for plain paper, 75 g/m ² (20 lb bond)
Paper output capacity	Face down: 80 sheets 75 g/m ² (20 lb bond)
Power rating	AC 110 - 127V or AC 220 - 240 V See the Rating label on the printer for the correct voltage, frequency (hertz) and type of current for your printer.
Power consumption	<ul style="list-style-type: none">• Average operating mode: Less than 350 W• Ready mode: Less than 80 W• Power Save mode: Less than 15 W
Noise Level^a	<ul style="list-style-type: none">• Ready mode: Background noise level• Printing mode: Less than 48 dBA• Copying mode: Less than 52 dBA
Boot-up time	Less than 35 seconds
Operating environment	Temperature: 10 to 32 °C (59 to 89.6 °F) Humidity: 20 to 80% RH
Display	16 characters x 2 lines
Toner cartridge life^b	Black Average continuous black cartridge yield: 1,500 standard pages (Shipped with 1,000 pages Starter toner cartridge.)
	Color (Yellow/Magenta/Cyan) Average continuous colored cartridge yield: 1,000 standard pages (Shipped with 700 pages Starter toner cartridge.)
Imaging unit yield^{c,d}	Approx. 24,000 images
Waste toner container^{c,d}	Approx. 10,000 images

ITEM	DESCRIPTION
Memory	128 MB (Non extendable)
External dimension (W x D x H)	415 x 373 x 342 mm (16.3 x 14.7 x 13.5 inches)
Weight (Including consumables)	15.4 Kg (33.95 lbs)
Package weight	<ul style="list-style-type: none">• Paper: 2.0 Kg (4.41 lbs)• Plastic: 0.4 Kg (0.88 lbs)
Duty cycle	Up to 20,000 images ^d (Monthly)
Fusing temperature	180 °C (356 °F)

a. Sound Pressure Level, ISO 7779

b. Declared yield value in accordance with ISO/IEC 19798. The number of pages may be affected by operating environment, printing interval, media type, and media size.

c. May be affected by operating environment, optional, printing interval, media type and media size.

d. Image counts based on one color on each page. If you print documents in full color (Black, Cyan, Magenta, Yellow), the life of this item will be reduced by 25%.

PRINTER SPECIFICATIONS

ITEM	DESCRIPTION	
Printing method	Color laser beam printing	
Printing speed^a	<ul style="list-style-type: none"> Black & White: Up to 16 ppm (A4), 17 ppm (Letter) Color: Up to 4 ppm (A4), 4 ppm (Letter) 	
First print out time	Black & White	<ul style="list-style-type: none"> From ready: Less than 14 seconds From coldboot: Less than 45 seconds
	Color	<ul style="list-style-type: none"> From ready: Less than 26 seconds From coldboot: Less than 57 seconds
Print resolution	Max. 2,400 x 600 dpi class	
Printer language	GDI	
OS compatibility^b	<ul style="list-style-type: none"> Windows: 2000/XP/2003/Vista Macintosh: Mac OS X 10.3~10.5, Universal Mac 	
Interface	<ul style="list-style-type: none"> High speed USB 2.0 Ethernet 10/100 Base TX (embedded type) 	

a. It will be affected by operating system used, computing performance, application software, connecting method, media type, media size and job complexity.

b. Visit www.dell.com or support.dell.com to download the latest software version.

SCANNER SPECIFICATIONS

ITEM	DESCRIPTION	
Compatibility	TWAIN standard/WIA standard	
Scanning method	Color CIS	
Resolution^a	TWAIN standard	1,200 x 1,200 dpi (Up to 4,800 x 4,800 dpi)
	WIA standard	Up to 1,200 x 1,200 dpi
	Scan to USB	100, 200, 300 dpi
	Scan to E-mail	100, 200, 300 dpi
	Scan to PC	75, 150, 200, 300, 600 dpi
Network Scan File format	PDF, BMP, TIFF, JPEG ^b	
Effective scanning length	Max. 289 mm (11.4 inches)	
Effective scanning width	Max. 208 mm (8.2 inches)	
Color bit depth	24 bit	
Mono bit depth	1 bit for black & white mode 8 bit for gray scale	

a. Due to the applications for scanning, the maximum resolution might differ.

b. JPEG is not available when you select the mono mode in scan color.

COPIER SPECIFICATIONS

ITEM	DESCRIPTION	
Copy Speed^a	<ul style="list-style-type: none"> Black & White: Up to 16 cpm (A4), 17 cpm (Letter) Color: Up to 4 cpm (A4), 4 cpm (Letter) 	
Copy resolution	Scan glass	up to 600 x 600 (text, text/photo, magazine) up to 1200 x 1200 (photo)
	ADF	up to 600 x 600 (text, text/photo, photo, magazine)
Zoom range	<ul style="list-style-type: none"> Scanner glass: 25% to 400% ADF: 25% to 100% 	

a. Copy speed is based on Single Document Multiple Copy.

FACSIMILE SPECIFICATIONS

 The fax feature may not be supported depending on printers.

ITEM	DESCRIPTION	
Compatibility	ITU-T G3	
Applicable line	Public Switched Telephone Network (PSTN) or behind PABX	
Data coding	MH/MR/MMR/JBIG/JPEG	
Modem speed	33.6 Kbps	
Transmission speed	Up to 3 seconds/page ^a	
Maximum document length	356 mm (14 inches)	
Resolution	Mono	Standard: 203 x 98 dpi Fine: 203 x 196 dpi Super Fine ^b : 300 x 300 dpi
	Color	200 x 200 dpi only
Memory	2MB	
Halftone	256 levels	
Auto dialer	Speed dialing (up to 240 numbers)	

a. Standard resolution, MMR(JBIG), Maximum modem speed, Phase "C" by ITU-T No. 1 chart, Memory Tx, ECM.

b. Transmission resolution in Super fine is different depending on kinds of receiver's printer.

glossary

 The following glossary helps you get familiar with the product by understanding the terminologies commonly used with printing as well as mentioned in this user's guide.

ADF

An Automatic Document Feeder (ADF) is a mechanism that will automatically feed an original sheet of paper so that the printer can scan some amount of the paper at once.

AppleTalk

AppleTalk is a proprietary suite of protocols developed by Apple, Inc for computer networking. It was included in the original Macintosh (1984) and is now deprecated by Apple in favor of TCP/IP networking.

BIT Depth

A computer graphics term describing the number of bits used to represent the color of a single pixel in a bitmapped image. Higher color depth gives a broader range of distinct colors. As the number of bits increases, the number of possible colors becomes impractically large for a color map. 1-bit color is commonly called as monochrome or black and white.

BMP

A bitmapped graphics format used internally by the Microsoft Windows graphics subsystem (GDI), and used commonly as a simple graphics file format on that platform.

BOOTP

Bootstrap Protocol. A network protocol used by a network client to obtain its IP address automatically. This is usually done in the bootstrap process of computers or operating systems running on them. The BOOTP servers assign the IP address from a pool of addresses to each client. BOOTP enables 'diskless workstation' computers to obtain an IP address prior to loading any advanced operating system.

CCD

Charge Coupled Device (CCD) is a hardware which enables the scan job. CCD Locking mechanism is also used to hold the CCD module to prevent any damage when you move the printer.

Collation

Collation is a process of printing a multiple-copy job in sets. When collation is selected, the device prints an entire set before printing additional copies.

Control Panel

A control panel is a flat, typically vertical, area where control or monitoring instruments are displayed. They are typically found in front of the printer.

Coverage

It is the printing term used for a toner usage measurement on printing. For example, 5% coverage means that an A4 sided paper has about 5% image or text on it. So, if the paper or original has complicated images or lots of text on it, the coverage will be higher and at the same time, a toner usage will be as much as the coverage.

CSV

Comma Separated Values (CSV). A type of file format, CSV is used to exchange data between disparate applications. The file format, as it is used in Microsoft Excel, has become a pseudo standard throughout the industry, even among non-Microsoft platforms.

DADF

A Duplex Automatic Document Feeder (DADF) is a mechanism that will automatically feed and flip over an original sheet of paper so that the printer can scan on both sides of the paper.

Default

The value or setting that is in effect when taking a printer out of its box state, reset, or initialized.

DHCP

A Dynamic Host Configuration Protocol (DHCP) is a client-server networking protocol. A DHCP server provides configuration parameters specific to the DHCP client host requesting, generally, information required by the client host to participate on an IP network. DHCP also provides a mechanism for allocation of IP addresses to client hosts.

DIMM

Dual Inline Memory Module (DIMM), a small circuit board that holds memory. DIMM stores all the data within the printer like printing data, received fax data.

DNS

The Domain Name Server (DNS) is a system that stores information associated with domain names in a distributed database on networks, such as the Internet.

Dot Matrix Printer

A dot matrix printer refers to a type of computer printer with a print head that runs back and forth on the page and prints by impact, striking an ink-soaked cloth ribbon against the paper, much like a typewriter.

DPI

Dots Per Inch (DPI) is a measurement of resolution that is used for scanning and printing. Generally, higher DPI results in a higher resolution, more visible detail in the image, and a larger file size.

DRPD

Distinctive Ring Pattern Detection. Distinctive Ring is a telephone company service which enables a user to use a single telephone line to answer several different telephone numbers.

Duplex

A mechanism that will automatically flip over a sheet of paper so that the printer can print (or scan) on both sides of the paper. A printer equipped with a Duplex can print double-sided of paper.

Duty Cycle

Duty cycle is the page quantity which does not affect printer performance for a month. Generally the printer has the lifespan limitation such as pages per year. The lifespan means the average capacity of print-outs, usually within the warranty period. For example, if the duty cycle is 48,000 pages per month assuming 20 working days, a printer limits 2,400 pages a day.

ECM

Error Correction Mode (ECM) is an optional transmission mode built into Class 1 fax machines or fax modems. It automatically detects and corrects errors in the fax transmission process that are sometimes caused by telephone line noise.

Emulation

Emulation is a technique of one printer obtaining the same results as another.

An emulator duplicates the functions of one system with a different system, so that the second system behaves like the first system. Emulation focuses on exact reproduction of external behavior, which is in contrast to simulation, which concerns an abstract model of the system being simulated, often considering its internal state.

Ethernet

Ethernet is a frame-based computer networking technology for local area networks (LANs). It defines wiring and signaling for the physical layer, and frame formats and protocols for the media access control (MAC)/data link layer of the OSI model. Ethernet is mostly standardized as IEEE 802.3. It has become the most widespread LAN technology in use during the 1990s to the present.

EtherTalk

A suite of protocols developed by Apple Computer for computer networking. It was included in the original Macintosh (1984) and is now deprecated by Apple in favor of TCP/IP networking.

FDI

Foreign Device Interface (FDI) is a card installed inside the printer to allow a third party device such as a coin operated device or a card reader. Those devices allow the pay-for-print service on your printer.

FTP

A File Transfer Protocol (FTP) is a commonly used protocol for exchanging files over any network that supports the TCP/IP protocol (such as the Internet or an intranet).

Fuser Unit

The part of a laser printer that melts the toner onto the print media. It consists of a hot roller and a back-up roller. After toner is transferred onto the paper, the fuser unit applies heat and pressure to ensure that the toner stays on the paper permanently, which is why paper is warm when it comes out of a laser printer.

Gateway

A connection between computer networks, or between a computer network and a telephone line. It is very popular, as it is a computer or a network that allows access to another computer or network.

Grayscale

A shades of gray that represent light and dark portions of an image when color images are converted to grayscale; colors are represented by various shades of gray.

Halftone

An image type that simulates grayscale by varying the number of dots. Highly colored areas consist of a large number of dots, while lighter areas consist of a smaller number of dots.

HDD

Hard Disk Drive (HDD), commonly referred to as a hard drive or hard disk, is a non-volatile storage device which stores digitally-encoded data on rapidly rotating platters with magnetic surfaces.

IEEE

The Institute of Electrical and Electronics Engineers (IEEE) is an international non-profit, professional organization for the advancement of technology related to electricity.

IEEE 1284

The 1284 parallel port standard was developed by the Institute of Electrical and Electronics Engineers (IEEE). The term "1284-B" refers to a specific connector type on the end of the parallel cable that attaches to the peripheral (for example, a printer).

Intranet

A private network that uses Internet Protocols, network connectivity, and possibly the public telecommunication system to securely share part of an organization's information or operations with its employees. Sometimes the term refers only to the most visible service, the internal website.

IP address

An Internet Protocol (IP) address is a unique number that devices use in order to identify and communicate with each other on a network utilizing the Internet Protocol standard.

IPM

The Images Per Minute (IPM) is a way of measuring the speed of a printer. An IPM rate indicates the number of single-sided sheets a printer can complete within one minute.

IPP

The Internet Printing Protocol (IPP) defines a standard protocol for printing as well as managing print jobs, media size, resolution, and so forth. IPP can be used locally or over the Internet to hundreds of printers, and also supports access control, authentication, and encryption, making it a much more capable and secure printing solution than older ones.

IPX/SPX

IPX/SPX stands for Internet Packet Exchange/Sequenced Packet Exchange. It is a networking protocol used by the Novell NetWare operating systems. IPX and SPX both provide connection services similar to TCP/IP, with the IPX protocol having similarities to IP, and SPX having similarities to TCP. IPX/SPX was primarily designed for local area networks (LANs), and is a very efficient protocol for this purpose (typically its performance exceeds that of TCP/IP on a LAN).

ISO

The International Organization for Standardization (ISO) is an international standard-setting body composed of representatives from national standards bodies. It produces world-wide industrial and commercial standards.

ITU-T

The International Telecommunication Union is an international organization established to standardize and regulate international radio and telecommunications. Its main tasks include standardization, allocation of the radio spectrum, and organizing interconnection arrangements between different countries to allow international phone calls. A -T out of ITU-T indicates telecommunication.

ITU-T No. 1 chart

Standardized test chart published by ITU-T for document facsimile transmissions.

JBIG

Joint Bi-level Image Experts Group (JBIG) is an image compression standard with no loss of accuracy or quality, which was designed for compression of binary images, particularly for faxes, but can also be used on other images.

JPEG

Joint Photographic Experts Group (JPEG) is a most commonly used standard method of lossy compression for photographic images. It is the format used for storing and transmitting photographs on the World Wide Web.

LDAP

The Lightweight Directory Access Protocol (LDAP) is a networking protocol for querying and modifying directory services running over TCP/IP.

LED

A Light-Emitting Diode (LED) is a semiconductor device that indicates the status of a printer.

MAC address

Media Access Control (MAC) address is a unique identifier associated with a network adapter. MAC address is a unique 48-bit identifier usually written as 12 hexadecimal characters grouped in pairs (e. g., 00-00-0c-34-11-4e). This address is usually hard-coded into a Network Interface Card (NIC) by its manufacturer, and used as an aid for routers trying to locate printers on large networks.

MFP

Multi Function Peripheral (MFP) is an office printer that includes the following functionality in one physical body, so as to have a printer, a copier, a fax, a scanner and etc.

MH

Modified Huffman (MH) is a compression method for decreasing the amount of data that needs to be transmitted between the fax machines to transfer the image recommended by ITU-T T.4. MH is a codebook-based run-length encoding scheme optimized to efficiently compress white space. As most faxes consist mostly of white space, this minimizes the transmission time of most faxes.

MMR

Modified Modified READ (MMR) is a compression method recommended by ITU-T T.6.

Modem

A device that modulates a carrier signal to encode digital information, and also demodulates such a carrier signal to decode transmitted information.

MR

Modified Read (MR) is a compression method recommended by ITU-T T.4. MR encodes the first scanned line using MH. The next line is compared to the first, the differences determined, and then the differences are encoded and transmitted.

NetWare

A network operating system developed by Novell, Inc. It initially used cooperative multitasking to run various services on a computer, and the network protocols were based on the archetypal Xerox XNS stack. Today NetWare supports TCP/IP as well as IPX/SPX.

OPC

Organic Photo Conductor (OPC) is a mechanism that makes a virtual image for print using a laser beam emitted from a laser printer, and it is usually green or gray colored and a cylinder shaped.

An exposing unit of a drum is slowly worn away by its usage of the printer, and it should be replaced appropriately since it gets scratches from grits of a paper.

Originals

The first example of something, such as a document, photograph or text, etc, which is copied, reproduced or translated to produce others, but which is not itself copied or derived from something else.

OSI

Open Systems Interconnection (OSI) is a model developed by the International Organization for Standardization (ISO) for communications. OSI offers a standard, modular approach to network design that divides the required set of complex functions into manageable, self-contained, functional layers. The layers are, from top to bottom, Application, Presentation, Session, Transport, Network, Data Link and Physical.

PABX

A private automatic branch exchange (PABX) is an automatic telephone switching system within a private enterprise.

PCL

Printer Command Language (PCL) is a Page Description Language (PDL) developed by HP as a printer protocol and has become an industry standard. Originally developed for early inkjet printers, PCL has been released in varying levels for thermal, matrix printer, and page printers.

PDF

Portable Document Format (PDF) is a proprietary file format developed by Adobe Systems for representing two dimensional documents in a device independent and resolution independent format.

PostScript

PostScript (PS) is a page description language and programming language used primarily in the electronic and desktop publishing areas. - that is run in an interpreter to generate an image.

Printer Driver

A program used to send commands and transfer data from the computer to the printer.

Print Media

The media like paper, envelopes, labels, and transparencies which can be used on a printer, a scanner, a fax or, a copier.

PPM

Pages Per Minute (PPM) is a method of measurement for determining how fast a printer works, meaning the number of pages a printer can produce in one minute.

PRN file

An interface for a device driver, this allows software to interact with the device driver using standard input/output system calls, which simplifies many tasks.

Protocol

A convention or standard that controls or enables the connection, communication, and data transfer between two computing endpoints.

PS

See PostScript.

PSTN

The Public-Switched Telephone Network (PSTN) is the network of the world's public circuit-switched telephone networks which, on industrial premises, is usually routed through the switchboard.

Resolution

The sharpness of an image, measured in Dots Per Inch (DPI). The higher the dpi, the greater the resolution.

SMB

Server Message Block (SMB) is a network protocol mainly applied to share files, printers, serial ports, and miscellaneous communications between nodes on a network. It also provides an authenticated Inter-process communication mechanism.

SMTP

Simple Mail Transfer Protocol (SMTP) is the standard for e-mail transmissions across the Internet. SMTP is a relatively simple, text-based protocol, where one or more recipients of a message are specified, and then the message text is transferred. It is a client-server protocol, where the client transmits an email message to the server.

Subnet Mask

The subnet mask is used in conjunction with the network address to determine which part of the address is the network address and which part is the host address.

TCP/IP

The Transmission Control Protocol (TCP) and the Internet Protocol (IP); the set of communications protocols that implement the protocol stack on which the Internet and most commercial networks run.

TCR

Transmission Confirmation Report (TCR) provides details of each transmission such as job status, transmission result and number of pages sent. This report can be set to print after each job or only after failed transmissions.

TIFF

Tagged Image File Format (TIFF) is a variable-resolution bitmapped image format. TIFF describes image data that typically come from scanners. TIFF images make use of tags, keywords defining the characteristics of the image that is included in the file. This flexible and platform-independent format can be used for pictures that have been made by various image processing applications.

Toner Cartridge

A kind of bottle within a printer like printer which contains toner. Toner is a powder used in laser printers and photocopiers, which forms the text and images on the printed paper. Toner can be melted by the heat of the fuser, causing it to bind to the fibers in the paper.

TWAIN

An industry standard for scanners and software. By using a TWAIN-compliant scanner with a TWAIN-compliant program, a scan can be initiated from within the program.; an image capture API for Microsoft Windows and Apple Macintosh operating systems.

UNC Path

Uniform Naming Convention (UNC) is a standard way to access network shares in Window NT and other Microsoft products. The format of a UNC path is: \\<servername>\<sharename>\<Additional directory>

URL

Uniform Resource Locator (URL) is the global address of documents and resources on the Internet. The first part of the address indicates what protocol to use, the second part specifies the IP address or the domain name where the resource is located.

USB

Universal Serial Bus (USB) is a standard that was developed by the USB Implementers Forum, Inc., to connect computers and peripherals. Unlike the parallel port, USB is designed to concurrently connect a single computer USB port to multiple peripherals.

Watermark

A watermark is a recognizable image or pattern in paper that appears lighter when viewed by transmitted light. Watermarks were first introduced in Bologna, Italy in 1282; they have been used by papermakers to identify their product, and also on postage stamps, currency, and other government documents to discourage counterfeiting.

WIA

Windows Imaging Architecture (WIA) is an imaging architecture that is originally introduced in Windows Me and Windows XP. A scan can be initiated from within these operating systems by using a WIA-compliant scanner.

A

- Address Book
 - group dial numbers 44
 - speed dial numbers 44
- Address Book, use 35
- ADF 11
- ADF, load 23
- adjustment
 - altitude 20
- alarm sound 21
- Ans/Fax mode, receiving mode 41

B

- background image, adjust 32

C

- characters, enter 21
- cleaning
 - inside 50
 - outside 50
 - scan unit 52
- clock mode 20
- control panel 12
- copying
 - 2-up, 4-up 31
 - clone 32
 - darkness 30, 31
 - erasing background 32
 - ID card copy 31
 - original type 30
 - poster 31
 - time out, set 32

D

- date and time, set 20
- default mode, change 20
- delayed fax 40
- display language, change 20
- DRPD (Distinctive Ring Pattern Detection)
41

E

- Erasing background, special copy 32

F

- fax header, set 38
- Fax mode, receiving mode 41
- fax number, set 38
- faxing
 - default settings, change 44, 40
 - fax setup 43, 42
 - Multiple Send faxes 39
 - priority faxes 40
 - receiving faxes 41
 - sending faxes 39

- forwarding faxes 42

G

- Group dial numbers, set 44

I

- ID card, special copy 31
- ID copy 12

J

- jam
 - tips for avoiding paper jams 58
- jam, clear
 - document 58

K

- key sound 21

L

- LED
 - Status 13
- loading originals
 - ADF 23
 - scanner glass 23

M

- machine ID, set 38
- Maintenance
 - maintenance parts 57
 - toner cartridge 53
- memory, clear 50
- Multiple Send faxes 39

N

- network
 - setting up 18

O

- originals
 - jam, clear 58
 - loading 23

P

- paper
 - changing the size 27, 59
- paper jam, clear
 - tray 1 59
- paper type
 - setting 29
- power save mode 21
- print quality problems, solve 66
- printing
 - reports 49
 - USB memory 47
- priority fax 40
- problem, solve
 - copying 68
 - faxing 70
 - Network Scan 69
 - paper feeding 65, 66
 - scanning 69
 - Windows 70

R

- receiving a fax
 - in Ans/Fax mode 41, 42, 41

receiving modes 41

redialing

- automatically 39
- manually 39

replacing components

- toner cartridge 53

reports, print 49

ringer 21

S

scanner glass

- cleaning 52
- loading documents 23

scanning

- default setting, change 35
- to email 34
- USB flash memory 46

secure receiving mode 42

sending a fax

- automatically 39

sounds, set 20

speaker sound 21

speaker volume 21

special copy features 31

speed dial numbers, set 44

supplies

- checking life 57
- expected toner cartridge life 53

T

Tel mode, receiving mode 41

tray

- adjusting the width and length 27

U

USB flash memory

- data backup 47
- managing 48
- printing 47
- scanning 46

V

volume, adjust

- ringer 21
- speaker 21

W

Windows problems 70

Information in this document is subject to change without notice.

© 2008 Dell Inc. All rights reserved.

Reproduction of these materials in any manner whatsoever without the written permission of Dell Inc. is strictly forbidden. Trademarks used in this text: Dell, the DELL logo, and Dell Toner Management System are trademarks of Dell Inc.; Microsoft, Windows, and Windows Vista are either trademarks or registered trademarks of Microsoft Corporation in the United States and/or other countries; UFST and MicroType are registered trademarks of Monotype Imaging Inc.; TrueType, Laser-Writer and Macintosh are trademarks of Apple Computer, Inc.

Other trademarks and trade names may be used in this document to refer to either the entities claiming the marks and names or their products. Dell Inc. disclaims any proprietary interest in trademarks and trade names other than its own.



Software section

SOFTWARE SECTION

CONTENTS

Chapter 1: **INSTALLING PRINTER SOFTWARE IN WINDOWS**

Installing Printer Software	4
Installing Software for Local Printing	4
Installing Software for Network Printing	7
Reinstalling Printer Software	9
Removing Printer Software	10

Chapter 2: **BASIC PRINTING**

Printing a Document	11
Printing to a file (PRN)	12
Printer Settings	12
Layout Tab	13
Paper Tab	13
Graphic Tab	14
Other Options Tab	15
About Tab	15
Using a Favorite Setting	15
Using Help	15

Chapter 3: **ADVANCED PRINTING**

Printing Multiple Pages on One Sheet of Paper (N-Up Printing)	16
Printing Posters	17
Printing Booklets	17
Printing on Both Sides of Paper	18
Printing a Reduced or Enlarged Document	18
Fitting Your Document to a Selected Paper Size	18

Using Watermarks	19
Using an Existing Watermark	19
Creating a Watermark	19
Editing a Watermark	19
Deleting a Watermark	19
Using Overlays	20
What is an Overlay?	20
Creating a New Page Overlay	20
Using a Page Overlay	20
Deleting a Page Overlay	20

Chapter 4: SHARING THE PRINTER LOCALLY

Setting Up a Host Computer	21
Setting Up a Client Computer	21

Chapter 5: SCANNING

Smarthru Office	22
Starting SmarThru Office	22
Quick Start Guide	22
Using SmarThru Office	22
Scanning Process with TWAIN-enabled Software	24
Scanning Using the WIA Driver	24
Windows XP	24
Windows Vista	24

Chapter 6: USING OTHER SOFTWARE

Printer Status Monitor	25
Printer Settings Utility	25
Dell Toner Re-order application	26
Firmware Update Utility	26

Chapter 7: USING YOUR PRINTER WITH A MACINTOSH

Installing Software	27
Uninstalling software	27
Setting Up the Printer	28
For a Network-connected	28
For a USB-connected	28
Printing	29
Printing a Document	29
Changing Printer Settings	29
Printing Multiple Pages on One Sheet of Paper	30
Scanning	31
Scanning with USB	31

1 Installing Printer Software in Windows

This chapter includes:

- **Installing Printer Software**
- **Reinstalling Printer Software**
- **Removing Printer Software**

NOTE: The following procedure is based on Microsoft® Windows® XP, for other operating systems, refer to the corresponding Windows user's guide or online help.

Installing Printer Software

You can install the printer software for local printing or network printing. To install the printer software on the computer, perform the appropriate installation procedure depending on the printer in use.

A printer driver is software that allows your computer to communicate with your printer. The procedure to install drivers may differ depending on the operating system you are using.

All applications should be closed on your computer before beginning installation.

Installing Software for Local Printing

A local printer is a printer directly attached to your computer using the printer cable supplied with your printer, such as a USB or parallel cable. If your printer is attached to a network, skip this step and go to "Installing Software for Network Printing" on page 7.

You can install the printer software using the typical or custom method.

NOTE: If the "New Hardware Wizard" window appears during the installation procedure, click  in the upper right corner of the window to close the window, or click **Cancel**.

Typical Installation

This is recommended for most users. All components necessary for printer operations will be installed.

- 1 Ensure that the printer is connected to your computer and powered on.

- 2 Insert the *Drivers and Utilities* CD into your computer's optical drive.

The CD should automatically run, and an installation window appears.

If the installation window does not appear, click **Start** and then **Run**. Type **X:\Setup.exe**, replacing "X" with the letter which represents your drive and click **OK**.

If you use Windows Vista®, click **Start** → **All programs** → **Accessories** → **Run**, and type **X:\Setup.exe**.

If the **AutoPlay** window appears in Windows Vista, click **Run Setup.exe** in **Install or run program** field, and click **Continue** in the **User Account Control** window.

- 3 Click **Next**.

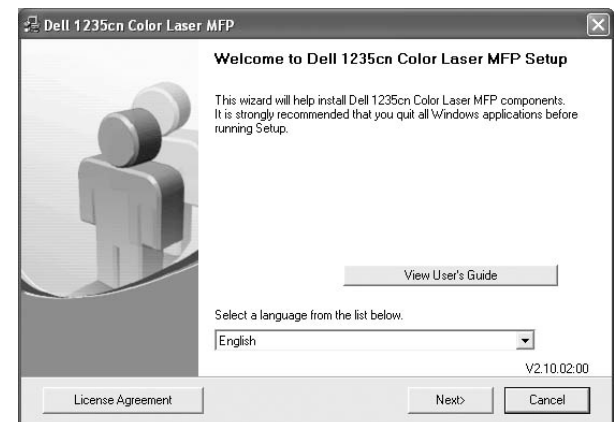

- If necessary, select a language from the drop-down list.
- **View User's Guide:** Allows you to view the User's Guide. If your computer does not have Adobe® Acrobat®, click on this option and it will automatically install Adobe® Acrobat® Reader for you.

- 4 Select **Typical installation for a local printer**. Click **Next**.

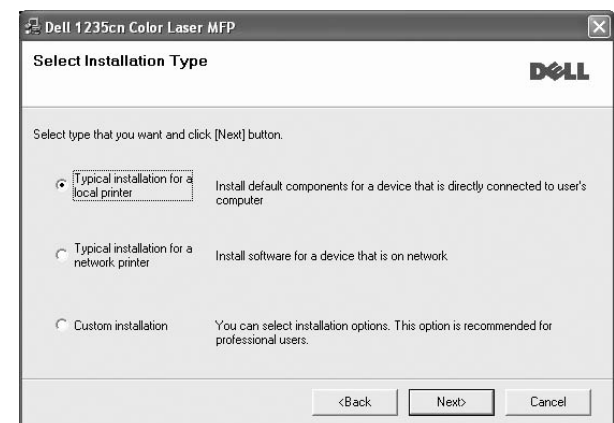

NOTE: If your printer is not already connected to the computer, the following window will appear.

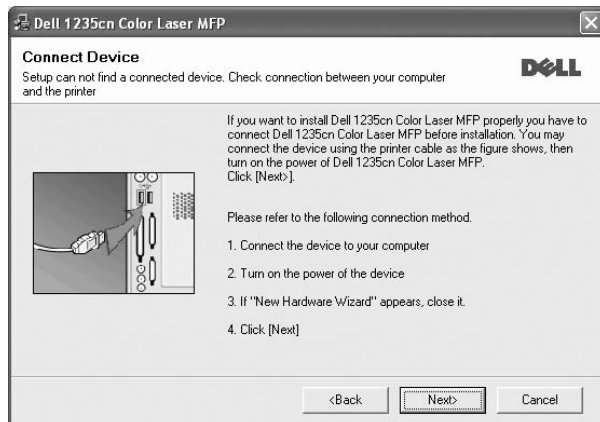

- After connecting the printer, click **Next**.
- If you do not want to connect the printer at this time, click **Next**, and **No** on the following screen. Then the installation will start and a test page will not be printed at the end of the installation.
- *The installation window that appears in this User's Guide may differ depending on the printer and interface in use.*

5 After the installation is finished, a window asking you to print a test page appears. If you choose to print a test page, select the checkbox and click **Next**.

Otherwise, just click **Next** and skip to step 6.

6 If the test page prints out correctly, click **Yes**.

If not, click **No** to reprint it.

7 Click **Finish**.

NOTE: After setup is complete, if your printer driver does not work properly, reinstall the printer driver. See "Reinstalling Printer Software" on page 9.

Custom Installation

You can choose individual components to install.

1 Ensure that the printer is connected to your computer and powered on.

2 Insert the supplied *Drivers and Utilities* CD into your computer's optical drive.

The CD should automatically run, and an installation window appears.

If the installation window does not appear, click **Start** and then **Run**. Type **X:\Setup.exe**, replacing "**X**" with the letter which represents your drive and click **OK**.

If you use Windows Vista, click **Start** → **All programs** → **Accessories** → **Run**, and type **X:\Setup.exe**.

If the **AutoPlay** window appears in Windows Vista, click **Run Setup.exe** in **Install or run program** field, and click **Continue** in the **User Account Control** window.

3 Click **Next**.

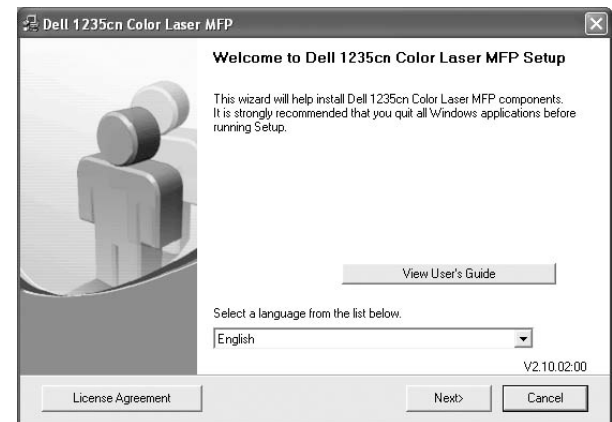

- If necessary, select a language from the drop-down list.
- **View User's Guide:** Allows you to view the User's Guide. If your computer does not have Adobe® Acrobat®, click on this option and it will automatically install Adobe® Acrobat® Reader for you.

4 Select **Custom installation**. Click **Next**.

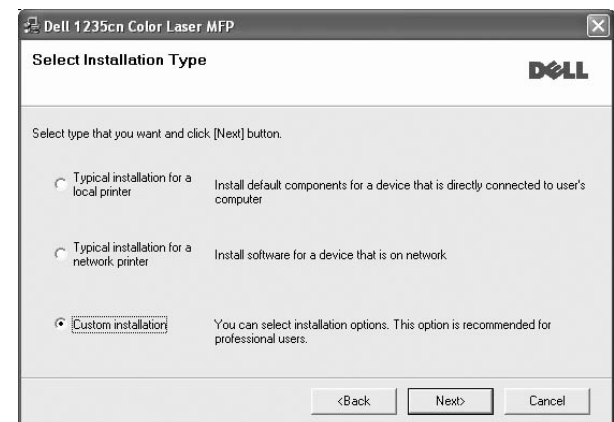

- 5 Select your printer and click **Next**.

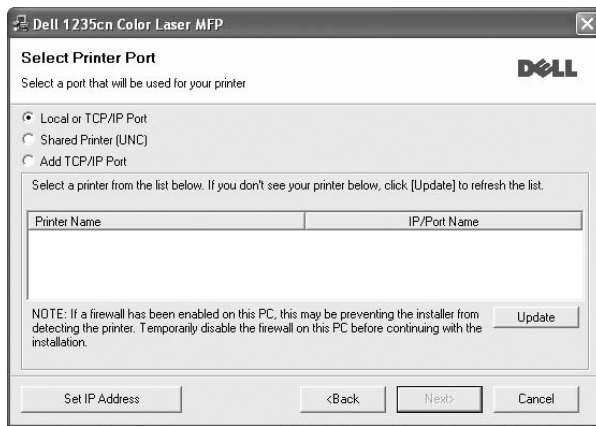

NOTE: If your printer is not already connected to the computer, the following window will appear.

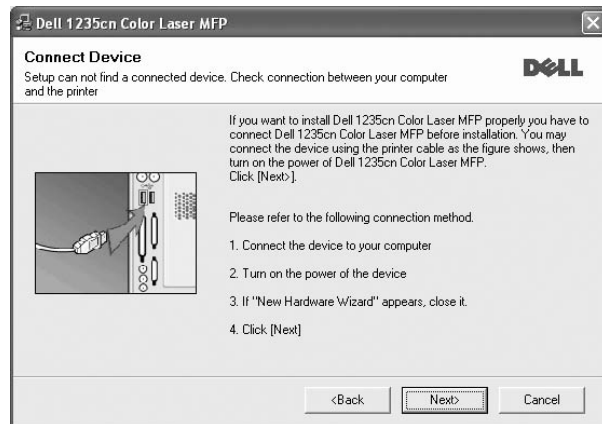

- After connecting the printer, click **Next**.
- If you do not want to connect the printer at this time, click **Next**, and **No** on the following screen. Then the installation will start and a test page will not be printed at the end of the installation.
- *The installation window that appears in this User's Guide may differ depending on the printer and interface in use.*

- 6 Select the components to be installed and click **Next**.

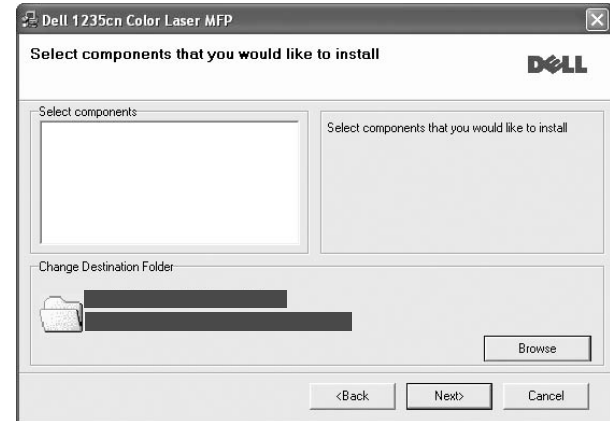

NOTE: You can change the desired installation folder by clicking [**Browse**].

- 7 After the installation is finished, a window asking you to print a test page appears. If you choose to print a test page, select the checkbox and click **Next**. Otherwise, just click **Next** and skip to step 8.
- 8 If the test page prints out correctly, click **Yes**. If not, click **No** to reprint it.
- 9 Click **Finish**.

Installing Software for Network Printing

When you connect your printer to a network, you must first configure the TCP/IP settings for the printer. After you have assigned and verified the TCP/IP settings, you are ready to install the software on each computer on the network.

You can install the printer software using the typical or custom method.

Typical Installation

This is recommended for most users. All components necessary for printer operations will be installed.

- 1 Ensure that the printer is connected to your network and powered on. For details about connecting to the network, see the Getting started chapter.
- 2 Insert the supplied *Drivers and Utilities* CD into your computer's optical drive.
The CD should automatically run, and an installation window appears.
If the installation window does not appear, click **Start** and then **Run**. Type **X:\Setup.exe**, replacing "X" with the letter which represents your drive and click **OK**.
If you use Windows Vista, click **Start** → **All programs** → **Accessories** → **Run**, and type **X:\Setup.exe**.
If the **AutoPlay** window appears in Windows Vista, click **Run Setup.exe** in **Install or run program** field, and click **Continue** in the **User Account Control** window.
- 3 Click **Next**.

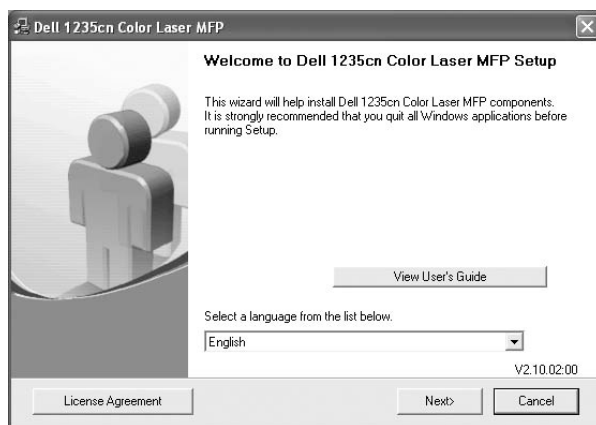

- If necessary, select a language from the drop-down list.
- **View User's Guide:** Allows you to view the User's Guide. If your computer does not have Adobe® Acrobat®, click on this option and it will automatically install Adobe® Acrobat® Reader for you.

- 4 Select **Typical installation for a network printer**. Click **Next**.

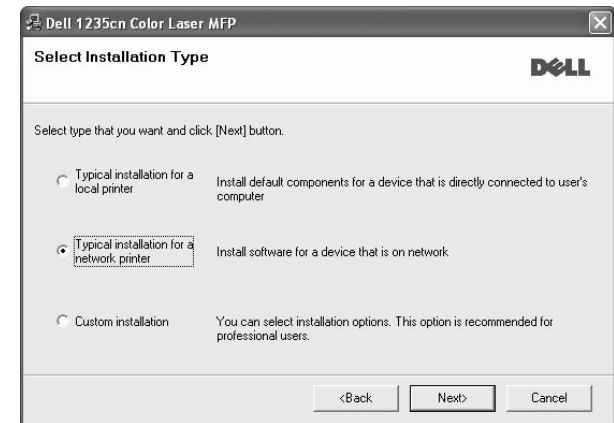

- 5 The list of printers available on the network appears. Select the printer you want to install from the list and then click **Next**.



- If you do not see your printer on the list, click **Update** to refresh the list, or select **Add TCP/IP Port** to add your printer to the network. To add the printer to the network, enter the port name and the IP address for the printer.

To verify your printer's IP address or the MAC address, print a Network Configuration page.

- To find a shared network printer (UNC Path), select **Shared Printer [UNC]** and enter the shared name manually or find a shared printer by clicking the **Browse** button.

NOTE: If you cannot find your machine in the network, turn off the firewall and click **Update**.

For Windows operating system, click **Start** → **Control Panel** and start windows firewall, and set this option unactivated. For other operating system, refer to its on-line guide.

- 6 After the installation is finished, a window appears asking you to print a test page appears. If you wish to do so, select the corresponding checkbox(es) and click **Finish**.

NOTE: After setup is complete, if your printer driver does not work properly, reinstall the printer driver. See "Reinstalling Printer Software" on page 9.

Custom Installation

You can choose individual components to install and set a specific IP address.

- 1 Ensure that the printer is connected to your network and powered on. For details about connecting to the network, see the Getting started chapter.
- 2 Insert the supplied *Drivers and Utilities* CD into your computer's optical drive.
The CD should automatically run, and an installation window appears.
If the installation window does not appear, click **Start** and then **Run**. Type **X:\Setup.exe**, replacing "X" with the letter which represents your drive and click **OK**.
If you use Windows Vista, click **Start** → **All programs** → **Accessories** → **Run**, and type **X:\Setup.exe**.
If the **AutoPlay** window appears in Windows Vista, click **Run Setup.exe** in **Install or run program** field, and click **Continue** in the **User Account Control** window.
- 3 Click **Next**.

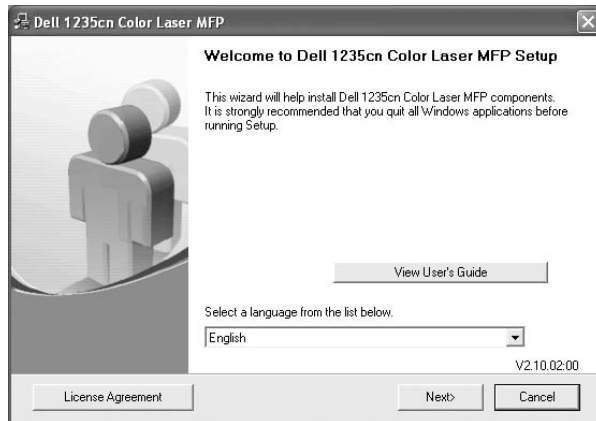

- If necessary, select a language from the drop-down list.
- **View User's Guide:** Allows you to view the User's Guide. If your computer does not have Adobe® Acrobat®, click on this option and it will automatically install Adobe® Acrobat® Reader for you.

- 4 Select **Custom installation**. Click **Next**.

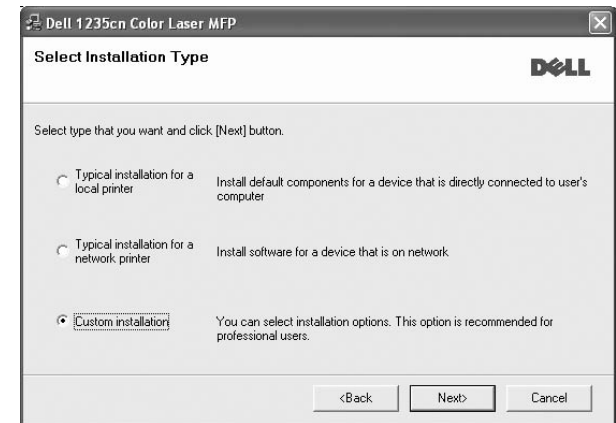

- 5 The list of printers available on the network appears. Select the printer you want to install from the list and then click **Next**.

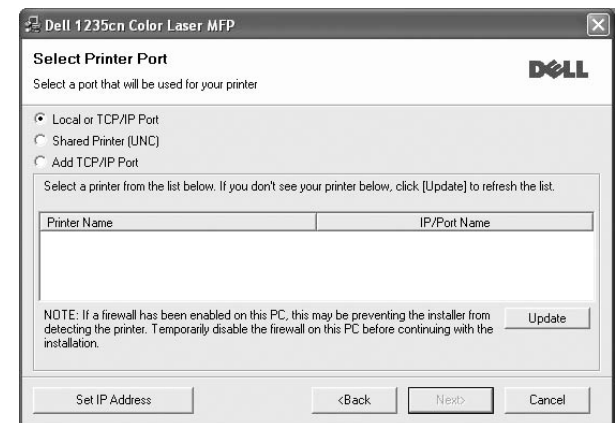

- If you do not see your printer on the list, click **Update** to refresh the list, or select **Add TCP/IP Port** to add your printer to the network. To add the printer to the network, enter the port name and the IP address for the printer.

To verify your printer's IP address or the MAC address, print a Network Configuration page.

- To find a shared network printer (UNC Path), select **Shared Printer [UNC]** and enter the shared name manually or find a shared printer by clicking the **Browse** button.

NOTE: If you cannot find your machine in network, please turn off the firewall and click **Update**.

For Windows operating system, click **Start** → **Control Panel** and start windows firewall, and set this option unactivated. For other operating system, refer to its on-line guide.

TIP: If you want to set a specific IP address on a specific network printer, click the **Set IP Address** button. The Set IP Address window appears. Do as follows:

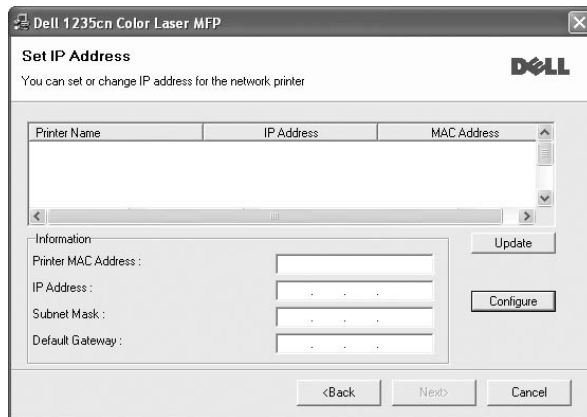

- a. Select a printer to be set with a specific IP address from the list.
- b. Configure an IP address, subnet mask, and gateway for the printer manually and click **Configure** to set the specific IP address for the network printer.
- c. Click **Next**.

- 6 Select the components to be installed. After selecting the components, the following window appears. You can also change the printer name, set the printer to be shared on the network, set the printer as the default printer, and change the port name of each printer. Click **Next**.

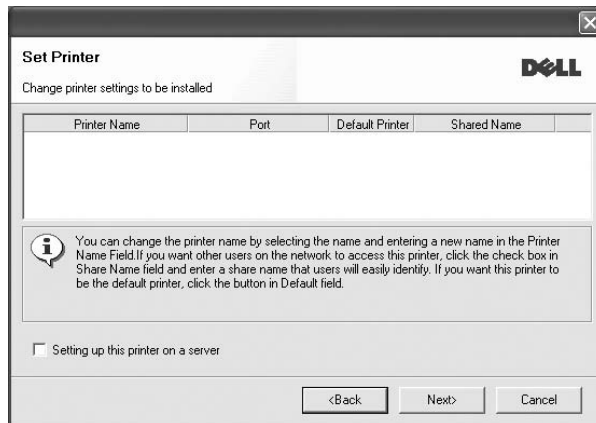

To install this software on a server, select the **Setting up this printer on a server** checkbox.

- 7 After the installation is finished, a window appears asking you to print a test page appears. If you wish to do so, select the corresponding checkbox(es) and click **Finish**.

NOTE: After setup is complete, if your printer driver does not work properly, reinstall the printer driver. See "Reinstalling Printer Software" on page 9.

Reinstalling Printer Software

You can reinstall the software if installation fails.

- 1 Start Windows.
- 2 From the **Start** menu select **Programs** or **All Programs** → **Dell** → **Dell Printers** → **your printer driver name** → **Maintenance**.
- 3 Select **Repair** and click **Next**.
- 4 The list of printers available on the local or network appears. Select the printer you want to install from the list and then click **Next**.

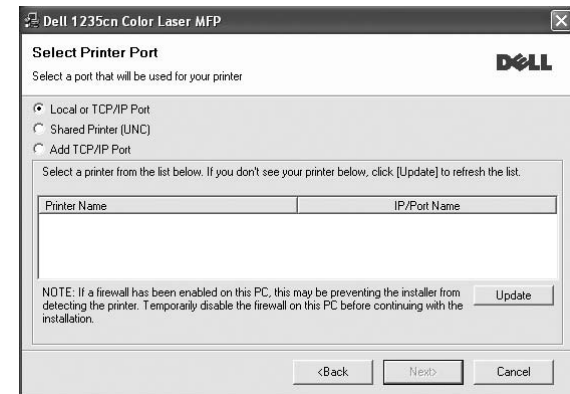

- If you do not see your printer on the list, click **Update** to refresh the list, or select **Add TCP/IP Port** to add your printer to the network. To add the printer to the network, enter the port name and the IP address for the printer.
- To find a shared network printer (UNC Path), select **Shared Printer [UNC]** and enter the shared name manually or find a shared printer by clicking the **Browse** button.

You will see a component list so that you can reinstall any item individually.

NOTE: If your printer is not already connected to the computer, the following window will appear.

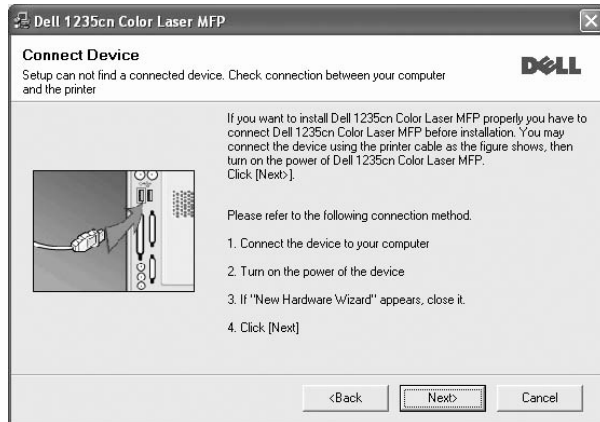

- After connecting the printer, click **Next**.
- If you do not want to connect the printer at this time, click **Next**, and **No** on the following screen. Then the installation will start and a test page will not be printed at the end of the installation.
- *The reinstallation window that appears in this User's Guide may differ depending on the printer and interface in use.*

- 5 Select the components you want to reinstall and click **Next**.

If you installed the printer software for local printing and you select **your printer driver name**, the window asking you to print a test page appears. Do as follows:

- a. To print a test page, select the check box and click **Next**.
 - b. If the test page prints out correctly, click **Yes**.
If it does not, click **No** to reprint it.
- 6 When the reinstallation is done, click **Finish**.

Removing Printer Software

- 1 Start Windows.
- 2 From the **Start** menu select **Programs** or **All Programs** → **Dell** → **Dell Printers** → **your printer driver name** → **Maintenance**.
- 3 Select **Remove** and click **Next**.
You will see a component list so that you can remove any item individually.
- 4 Select the components you want to remove and then click **Next**.
- 5 When your computer asks you to confirm your selection, click **Yes**.
The selected driver and all of its components are removed from your computer.
- 6 After the software is removed, click **Finish**.

2 Basic Printing



this chapter explains the printing options and common printing tasks in windows.

This chapter includes:

- **Printing a Document**
- **Printing to a file (PRN)**
- **Printer Settings**
 - **Layout Tab**
 - **Paper Tab**
 - **Graphic Tab**
 - **Other Options Tab**
 - **About Tab**
 - **Using a Favorite Setting**
 - **Using Help**

Printing a Document

NOTES:

- Your printer driver **Properties** window that appears in this User's Guide may differ depending on the printer in use. However the composition of the printer properties window is similar.
- **Check the Operating System(s) that are compatible with your printer. Please refer to the OS Compatibility section of Printer Specifications in the Getting started chapter.**
- If you need to know the exact name of your printer, you can check the supplied Drivers and Utilities CD.
- When you select an option in printer properties, you may see an exclamation mark  or  mark. An exclamation mark means you can select that certain option but it is not recommended, and  mark means you cannot select that option due to the printer's setting or environment.

The following procedure describes the general steps required for printing from various Windows applications. The exact steps for printing a document may vary depending on the application program you are using. See the User's Guide of your software application for the exact printing procedure.

- 1 Open the document you want to print.
- 2 Select **Print** from the **File** menu. The Print window is displayed. It may look slightly different depending on your application.

The basic print settings are selected within the Print window. These settings include the number of copies and print range.

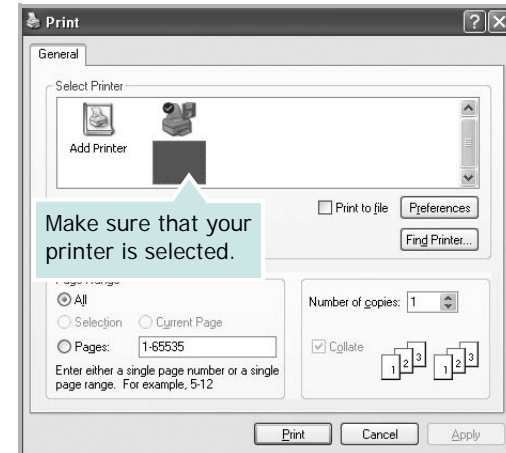

- 3 Select **your printer driver** from the **Name** drop-down list.
To take advantage of the printer features provided by your printer driver, click **Properties** or **Preferences** in the application's Print window. For details, see "Printer Settings" on page 12.
If you see **Setup**, **Printer**, or **Options** in your Print window, click it instead. Then click **Properties** on the next screen.
Click **OK** to close the printer properties window.
- 4 To start the print job, click **OK** or **Print** in the Print window.

Printing to a file (PRN)

You will sometimes need to save the print data as a file for your purpose.

To create a file:

- 1 Check the **Print to file** box in the **Print** window.

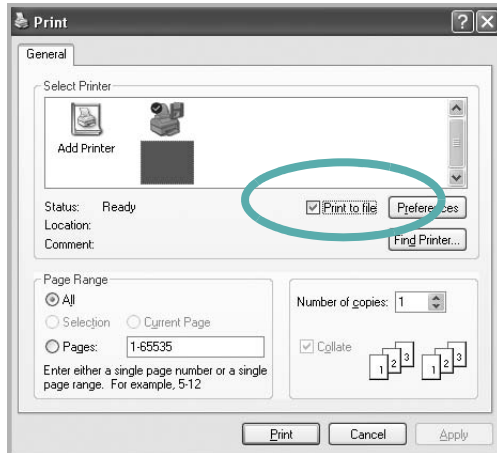

- 2 Click **Print**.
- 3 Enter the folder name and assign a name of the file and then click OK.

Printer Settings

You can use the printer properties window, which allows you to access all of the printer options you need when using your printer. When the printer properties are displayed, you can review and change the settings needed for your print job.

Your printer properties window may differ, depending on your operating system. This Software User's Guide shows the Properties window for Windows XP.

Your printer driver **Properties** window that appears in this User's Guide may differ depending on the printer in use.

NOTES:

- Most Windows applications will override settings you specify in the printer driver. Change all print settings available in the software application first, and change any remaining settings using the printer driver.
 - The settings you change remain in effect only while you are using the current program. **To make your changes permanent**, make them in the Printers folder.
 - The following procedure is for Windows XP. For other Windows operating systems, see the corresponding Windows User's Guide or online help.
 1. Click the Windows **Start** button.
 2. Select **Printers and Faxes**.
 3. Select **your printer driver icon**.
 4. Right-click on the printer driver icon and select **Printing Preferences**.
 5. Change the settings on each tab, click OK.
-

Layout Tab

The **Layout** tab provides options to adjust how the document appears on the printed page. The **Layout Options** includes **Multiple Pages per Side**, **Poster Printing**, and **Booklet Printing**. See “Printing a Document” on page 11 for more information on accessing printer properties.

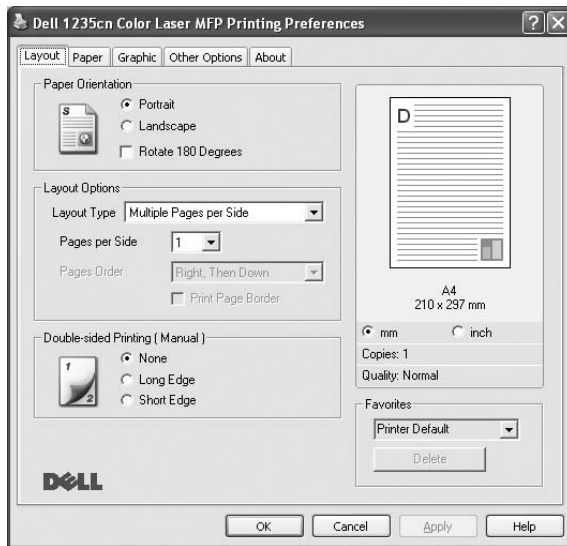

Paper Orientation

Paper Orientation allows you to select the direction in which information is printed on a page.

- **Portrait** prints across the width of the page, letter style.
- **Landscape** prints across the length of the page, spreadsheet style.
- **Rotate 180 Degrees** allows you to rotate the page, 180 degrees.

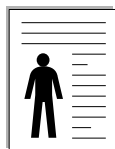

▲ Portrait



▲ Landscape

Layout Options

Layout Options allows you to select advanced printing options. You can choose **Multiple Pages per Side** and **Poster Printing**.

- For details, see “Printing Multiple Pages on One Sheet of Paper (N-Up Printing)” on page 16.
- For details, see “Printing Posters” on page 17
- For details, see “Printing Booklets” on page 17

Double-sided Printing (Manual)

Double-sided Printing allows you to print on both sides of paper.

- For details, see “Printing on Both Sides of Paper” on page 18.

Paper Tab

Use the following options to set the basic paper handling specifications when you access the printer properties. See “Printing a Document” on page 11 for more information on accessing printer properties.

Click the **Paper** tab to access various paper properties.

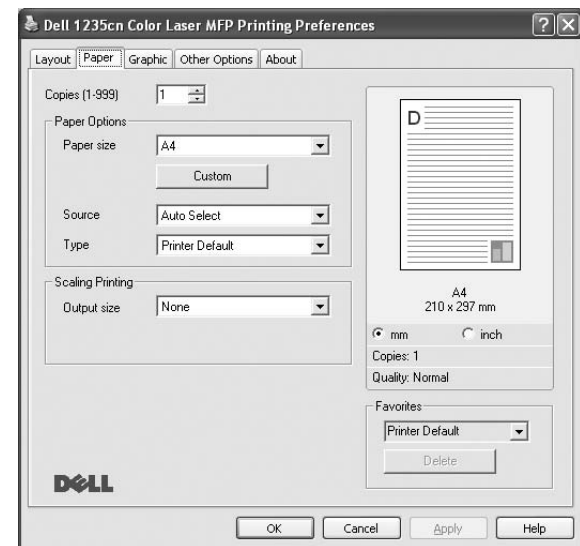

Copies

Copies allows you to choose the number of copies to be printed. You can select 1 to 999 copies.

Paper Options

Size

Size allows you to set the size of paper you loaded in the tray. If the required size is not listed in the **Size** box, click **Custom**. When the **Custom Paper Setting** window appears, set the paper size and click **OK**. The setting appears in the list so that you can select it.

Source

Ensure that **Source** is set to the corresponding paper tray. Use **Manual Feeder** when printing on special materials like envelopes and transparencies.

Type

Set **Type** to correspond to the paper loaded in the tray from which you want to print. This will let you get the best quality printout. If not, print quality may not be achieved as you want.

Thick Paper: 24 lb to 28 lb (90~105 g/m²) thick paper.

Thin Paper: 16 lb to 19 lb (60~70 g/m²) thin paper.

Cotton: 20 lb to 24 lb (75~90 g/m²) cotton paper such as Gilbert 25 % and Gilbert 100 %.

Plain Paper: Normal plain paper. Select this type if your printer is monochrome and printing on the 16 lb (60 g/m²) cotton paper.

Recycled Paper: 20 lb to 24 lb (75~90 g/m²) recycled paper.

Color Paper: 20 lb to 24 lb (75~90 g/m²) color-backgrounded paper.

Archive Paper: If you need to keep print-out for a long period time such as archives, select this option.

Scaling Printing

Scaling Printing allows you to automatically or manually scale your print job on a page. You can choose from **None**, **Reduce/Enlarge**, and **Fit to Page**.

- For details, see “Printing a Reduced or Enlarged Document” on page 18.
- For details, see “Fitting Your Document to a Selected Paper Size” on page 18.

Graphic Tab

Use the following Graphic options to adjust the print quality for your specific printing needs. See “Printing a Document” on page 11 for more information on accessing printer properties.

Click the **Graphic** tab to display the properties shown below.

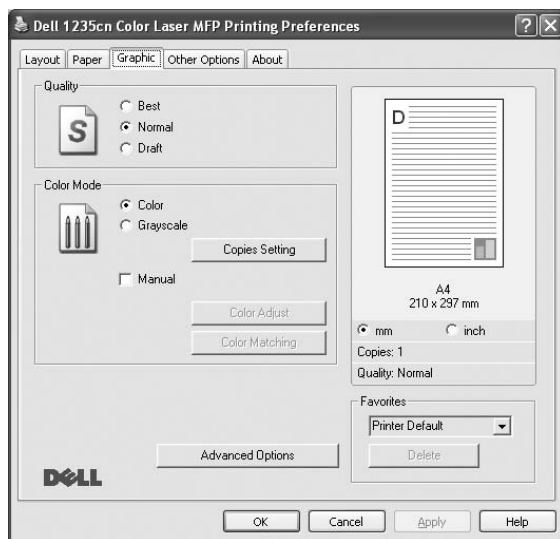

Quality

The Quality options you can select may vary depending on your printer model. The higher the setting, the sharper the clarity of printed characters and graphics. The higher setting also may increase the time it takes to print a document.

Color Mode

You can choose color options. Setting to **Color** typically produces the best possible print quality for color documents. If you want to print a color document in grayscale, select **Grayscale**. If you want to adjust the color options manually, select **Manual** and click the **Color Adjust** or **Color Matching** button.

- **Copies Setting** : In order to use this option, first you need to set total number of copies from **Paper** tab. When you make several copies, and if you want to print some copies in color and some in grayscale, use this option and select the number of copies in grayscale.

- **Color Adjust** : You can adjust the appearance of images by changing the settings in the **Levels** option.
- **Color Matching** : You can adjust the appearance of images by changing the settings in the **Settings** option.

Advanced Options

You can set advanced settings by clicking the **Advanced Options** button.

- **Print All Text To Black**: When the **Print All Text To Black** option is checked, all text in your document prints solid black, regardless of the color it appears on the screen.
- **Print All Text To Darken**: When the **Print All Text To Darken** option is checked, all text in your document is allowed to print darker than on a normal document.
- **Grayscale Enhancement**: Press the **Smart Color** tab. It allows users to preserve the details of nature photos, and improve contrast and readability among grayscale colors, when printing color documents in grayscale.
- **Fine Edge**: Press the **Smart Color** tab. It allows users to emphasize edges of texts and fine lines for improving readability and align each color channel registration in color printing mode.

Other Options Tab

You can select output options for your document. See "Printing a Document" on page 11 for more information about accessing the printer properties.

Click the **Other Options** tab to access the following feature:

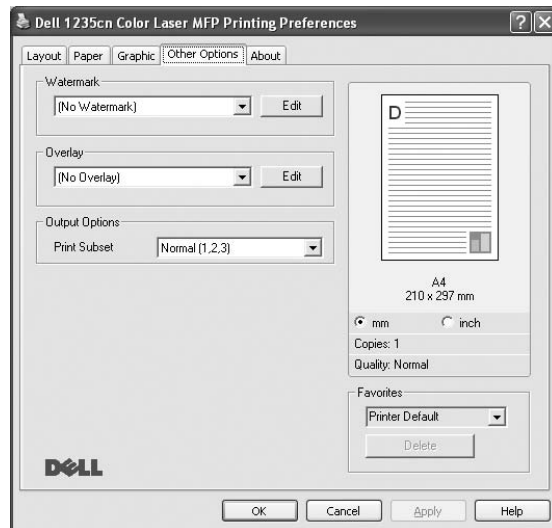

Watermark

You can create a background text image to be printed on each page of your document. For details, see "Using Watermarks" on page 19.

Overlay

Overlays are often used to take the place of preprinted forms and letterhead paper. For details, see "Using Overlays" on page 20.

Output Options

- **Print Subset:** You can set the sequence in which the pages print. Select the print order from the drop-down list.
 - **Normal (1,2,3):** Your printer prints all pages from the first page to the last page.
 - **Reverse All Pages (3,2,1):** Your printer prints all pages from the last page to the first page.
 - **Print Odd Pages:** Your printer prints only the odd numbered pages of the document.
 - **Print Even Pages:** Your printer prints only the even numbered pages of the document.

About Tab

Use the **About** tab to display the copyright notice and the version number of the driver. If you have an Internet browser, you can connect to the Internet by clicking on the web site icon. See "Printing a Document" on page 11 for more information about accessing printer properties.

Using a Favorite Setting

The **Favorites** option, which is visible on each properties tab, allows you to save the current properties settings for future use.

To save a **Favorites** item:

- 1 Change the settings as needed on each tab.
- 2 Enter a name for the item in the **Favorites** input box.

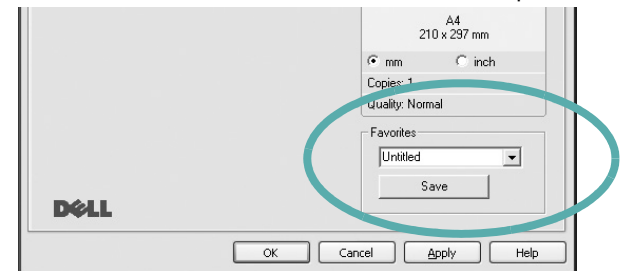

- 3 Click **Save**.

When you save **Favorites**, all current driver settings are saved.

To use a saved setting, select the item from the **Favorites** drop down list. The printer is now set to print according to the Favorites setting you selected.

To delete a Favorites item, select it from the list and click **Delete**.

You can also restore the printer driver's default settings by selecting **Printer Default** from the list.

Using Help

Your printer has a help screen that can be activated by clicking the **Help** button in the printer properties window. These help screens give detailed information about the printer features provided by the printer driver.

You can also click  from the upper right corner of the window, and then click on any setting.

3 Advanced Printing

This chapter explains printing options and advanced printing tasks.

NOTE:

- Your printer driver **Properties** window that appears in this User's Guide may differ depending on the printer in use. However the composition of the printer properties window is similar.
 - If you need to know the exact name of your printer, you can check the supplied Drivers and Utilities CD.
-

This chapter includes:

- **Printing Multiple Pages on One Sheet of Paper (N-Up Printing)**
- **Printing Posters**
- **Printing Booklets**
- **Printing on Both Sides of Paper**
- **Printing a Reduced or Enlarged Document**
- **Fitting Your Document to a Selected Paper Size**
- **Using Watermarks**
- **Using Overlays**

Printing Multiple Pages on One Sheet of Paper (N-Up Printing)

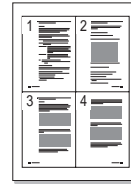

You can select the number of pages to print on a single sheet of paper. To print more than one page per sheet, the pages will be reduced in size and arranged in the order you specify. You can print up to 16 pages on one sheet.

- 1** To change the print settings from your software application, access printer properties. See "Printing a Document" on page 11.
- 2** From the **Layout** tab, choose **Multiple Pages per Side** in the **Layout Type** drop-down list.
- 3** Select the number of pages you want to print per sheet (1, 2, 4, 6, 9, or 16) in the **Pages per Side** drop-down list.
- 4** Select the page order from the **Page Order** drop-down list, if necessary.
Check **Print Page Border** to print a border around each page on the sheet.
- 5** Click the **Paper** tab, select the paper source, size, and type.
- 6** Click **OK** and print the document.

Printing Posters

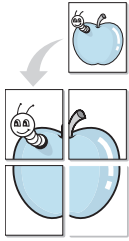

This feature allows you to print a single-page document onto 4, 9, or 16 sheets of paper, for the purpose of pasting the sheets together to form one poster-size document.

- 1 To change the print settings from your software application, access printer properties. See “Printing a Document” on page 11.
- 2 Click the **Layout** tab, select **Poster Printing** in the **Layout Type** drop-down list.
- 3 Configure the poster option:
You can select the page layout from **Poster<2x2>**, **Poster<3x3>**, **Poster<4x4>** or **Custom**. If you select **Poster<2x2>**, the output will be automatically stretched to cover 4 physical pages. If the option is set to Custom, you can enlarge the original from 150% to 400%. Depending on the level of the enlargement, the page layout is automatically adjusted to **Poster<2x2>**, **Poster<3x3>**, **Poster<4x4>**.

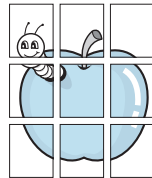
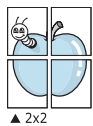

Specify an overlap in millimeters or inches to make it easier to pasting the sheets together.

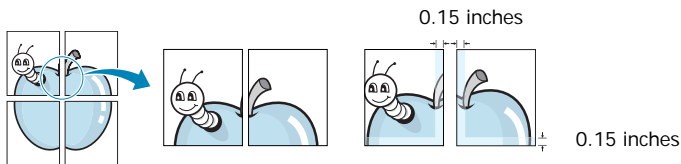

- 4 Click the **Paper** tab, select the paper source, size, and type.
- 5 Click **OK** and print the document. You can complete the poster by pasting the sheets together.

Printing Booklets

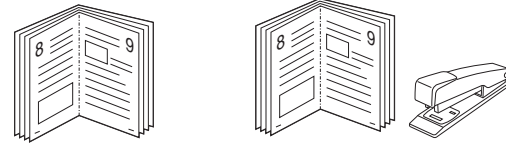

This printer feature allows you to print your document on both sides of the paper and arranges the pages so that the paper can be folded in half after printing to produce a booklet.

- 1 To change the print settings from your software application, access the printer properties. See “Printing a Document” on page 11.
- 2 From the **Layout** tab, choose **Booklet Printing** from the **Layout Type** drop-down list.

NOTE: The **Booklet Printing** option is not available for all paper sizes. In order to find out the available paper size for this feature, select the paper size in the **Size** option on the **Paper** tab, then check if the **Booklet Printing** in a **Layout Type** drop-down list on the **Layout** tab is activated.

- 3 Click the **Paper** tab, and select the paper source, size, and type.
- 4 Click **OK** and print the document.
- 5 After printing, fold and staple the pages.

Printing on Both Sides of Paper

You can print on both sides of a sheet of paper. Before printing, decide how you want your document oriented.

The options are:

- **None**
- **Long Edge**, which is the conventional layout used in book binding.
- **Short Edge**, which is the type often used with calendars.

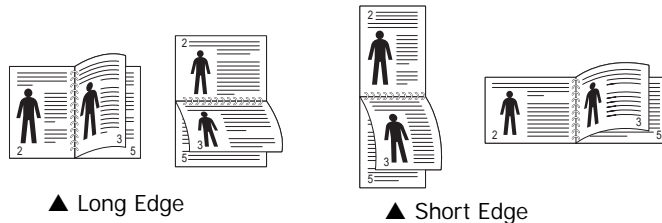

NOTE: Do not print on both sides of labels, transparencies, envelopes, or thick paper. Paper jamming and damage to the printer may result.

- 1 To change the print settings from your software application, access printer properties. See "Printing a Document" on page 11.
- 2 From the **Layout** tab, select the paper orientation.
- 3 From the **Double-sided Printing** section, select the binding option you want.
- 4 Click the **Paper** tab and select the paper source, size, and type.
- 5 Click **OK** and print the document.

NOTE: If your printer does not have a duplex unit, you should complete the printing job manually. The printer prints every other page of the document first. After printing the first side of your job, the Printing Tip window appears. Follow the on-screen instructions to complete the printing job.

Printing a Reduced or Enlarged Document

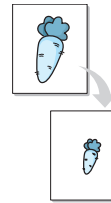

You can change the size of a page's content to appear larger or smaller on the printed page.

- 1 To change the print settings from your software application, access printer properties. See "Printing a Document" on page 11.
- 2 From the **Paper** tab, select **Reduce/Enlarge** in the **Printing Type** drop-down list.
- 3 Enter the scaling rate in the **Percentage** input box. You can also click the ▼ or ▲ button.
- 4 Select the paper source, size, and type in **Paper Options**.
- 5 Click **OK** and print the document.

Fitting Your Document to a Selected Paper Size

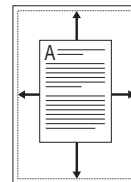

This printer feature allows you to scale your print job to any selected paper size regardless of the digital document size. This can be useful when you want to check fine details on a small document.

- 1 To change the print settings from your software application, access printer properties. See "Printing a Document" on page 11.
- 2 From the **Paper** tab, select **Fit to Page** in the **Printing Type** drop-down list.
- 3 Select the correct size from the **Output size** drop-down list.
- 4 Select the paper source, size, and type in **Paper Options**.
- 5 Click **OK** and print the document.

Using Watermarks

The Watermark option allows you to print text over an existing document. For example, you may want to have large gray letters reading "DRAFT" or "CONFIDENTIAL" printed diagonally across the first page or all pages of a document.

There are several predefined watermarks that come with the printer, and they can be modified, or you can add new ones to the list.

Using an Existing Watermark

- 1 To change the print settings from your software application, access printer properties. See "Printing a Document" on page 11.
- 2 Click the **Other Options** tab, and select the desired watermark from the **Watermark** drop-down list. You will see the selected watermark in the preview image.
- 3 Click **OK** and start printing.

NOTE: The preview image shows how the page will look when it is printed.

Creating a Watermark

- 1 To change the print settings from your software application, access printer properties. See "Printing a Document" on page 11.
- 2 Click the **Other Options** tab, and click the **Edit** button in the **Watermark** section. The **Edit Watermark** window appears.
- 3 Enter a text message in the **Watermark Message** box. You can enter up to 40 characters. The message displays in the preview window.
When the **First Page Only** box is checked, the watermark prints on the first page only.
- 4 Select watermark options.
You can select the font name, style, size, or grayscale level from the **Font Attributes** section and set the angle of the watermark from the **Message Angle** section.
- 5 Click **Add** to add a new watermark to the list.
- 6 When you have finished editing, click **OK** and start printing.

To stop printing the watermark, select **(No Watermark)** from the **Watermark** drop-down list.

Editing a Watermark

- 1 To change the print settings from your software application, access printer properties. See "Printing a Document" on page 11.
- 2 Click the **Other Options** tab and click the **Edit** button in the **Watermark** section. The **Edit Watermark** window appears.
- 3 Select the watermark you want to edit from the **Current Watermarks** list and change the watermark message and options.
- 4 Click **Update** to save the changes.
- 5 Click **OK** until you exit the Print window.

Deleting a Watermark

- 1 To change the print settings from your software application, access printer properties. See "Printing a Document" on page 11.
- 2 From the **Other Options** tab, click the **Edit** button in the **Watermark** section. The **Edit Watermark** window appears.
- 3 Select the watermark you want to delete from the **Current Watermarks** list and click **Delete**.
- 4 Click **OK** until you exit the Print window.

Using Overlays

What is an Overlay?



An overlay is text and/or images stored in the computer's hard disk drive (HDD) as a special file format that can be printed on any document. Overlays are often used to take the place of preprinted forms and letterhead paper. Rather than using preprinted letterhead, you can create an overlay containing the exact same information that is currently on your letterhead. To print a letter with your company's letterhead, you do not need to load preprinted letterhead paper in the printer. You can use your printer to print the letterhead overlay on your document.

Creating a New Page Overlay

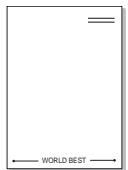

To use a page overlay, you must create a new page overlay containing your logo or image.

- 1 Create or open a document containing text or an image for use in a new page overlay. Position the items exactly as you wish them to appear when printed as an overlay.
- 2 To save the document as an overlay, access printer properties. See "Printing a Document" on page 11.
- 3 Click the **Other Options** tab, and click **Edit** button in the **Overlay** section.
- 4 In the **Edit Overlay** window, click **Create Overlay**.
- 5 In the **Create Overlay** window, type a name of up to eight characters in the **File name** box. Select the destination path, if necessary. (The default is C:\Formover).
- 6 Click **Save**. The name appears on the **Overlay List** box.
- 7 Click **OK** or **Yes** to finish creating.
The file is not printed. Instead it is stored on your computer's hard disk drive.

NOTE: The overlay document size must be the same as the documents you print with the overlay. Do not create an overlay with a watermark.

Using a Page Overlay

After an overlay has been created, it is ready to be printed with your document. To print an overlay with a document:

- 1 Create or open the document you want to print.
- 2 To change the print settings from your software application, access printer properties. See "Printing a Document" on page 11.
- 3 Click the **Other Options** tab.
- 4 Select the desired overlay from the **Overlay** drop-down list box.
- 5 If the overlay file you want does not appear in the **Overlay** list, click **Edit** button and **Load Overlay**, and select the overlay file.
If you have stored the overlay file you want to use in an external source, you can also load the file when you access the **Load Overlay** window.
After you select the file, click **Open**. The file appears in the **Overlay List** box and is available for printing. Select the overlay from the **Overlay List** box.
- 6 If necessary, click **Confirm Page Overlay When Printing**. If this box is checked, a message window appears each time you submit a document for printing, asking you to confirm your wish to print an overlay on your document.
If this box is not checked and an overlay has been selected, the overlay automatically prints with your document.
- 7 Click **OK** or **Yes** until printing begins.
The selected overlay downloads with your print job and prints on your document.

NOTE: The resolution of the overlay document must be the same as that of the document you will print with the overlay.

Deleting a Page Overlay

You can delete page overlays that you no longer use.

- 1 In the printer properties window, click the **Other Options** tab.
- 2 Click the **Edit** button in the **Overlay** section.
- 3 Select the overlay you want to delete from the **Overlay List** box.
- 4 Click **Delete Overlay**.
- 5 When a confirming message window appears, click **Yes**.
- 6 Click **OK** until you exit the Print window.

4 Sharing the Printer Locally

You can connect the printer directly to a selected computer, which is called "host computer," on the network.

The following procedure is for Microsoft® Windows® XP. For other Windows operating systems, see the corresponding Windows User's Guide or online help.

NOTES:

- Check the operating system(s) that are compatible with your printer. Please refer to the OS Compatibility section of Printer Specifications in the Getting started chapter.
 - If you need to know the exact name of your printer, you can check the supplied Drivers and Utilities CD.
-

Setting Up a Host Computer

- 1 Start Windows.
- 2 From the **Start** menu select **Printers and Faxes**.
- 3 Double-click **your printer driver icon**.
- 4 From the **Printer** menu, select **Sharing**.
- 5 Check the **Share this printer** box.
- 6 Fill in the **Shared Name** field, and then click **OK**.

Setting Up a Client Computer

- 1 Right-click the Windows **Start** button and select **Explore**.
- 2 Select **My Network Places** and then right-click **Search for Computers**.
- 3 Enter the IP address of host computer in **Computer name** field, and click **Search**. (In case host computer requires **User name** and **Password**, enter User ID and password of host computer account.)
- 4 Double-click **Printers and Faxes**.
- 5 Right-click printer driver icon, select **Connect**.
- 6 Click **Yes**, if the installation confirm message appears.

5 Scanning

Scanning with your machine lets you turn pictures and text into digital files on your computer. Then you can fax or e-mail the files, display them on your web site or use them to create projects that you can print using SmarThru software or the WIA driver.

This chapter includes:

- **Smarthru Office**
- **Scanning Process with TWAIN-enabled Software**
- **Scanning Using the WIA Driver**

NOTES:

- *Check the Operating System(s) that are compatible with your printer. Please refer to the OS Compatibility section of Printer Specifications in the Getting started chapter.*
- *You can check your printer name in the supplied Drivers and Utilities CD.*
- *The maximum resolution that can be achieved depends upon various factors, including computer speed, available disk space, memory, the size of the image being scanned, and bit depth settings. Thus, depending on your system and what you are scanning, you may not be able to scan at certain resolutions, especially using enhanced dpi.*

Smarthru Office

The supplied *Drivers and Utilities* CD provides you with SmarThru Office. SmarThru Office offers you convenient features to use with your machine.

Starting SmarThru Office

Follow the steps below to start SmarThru Office:

- 1 Ensure that your printer and computer are turned on and properly connected to each other.
- 2 Once you have installed SmarThru Office, you will see the SmarThru Office icon on your desktop.
- 3 Double-click the SmarThru Office icon.



- 4 The SmarThru Office starts.
For more information, click **Help > SmarThru Office help**.

Quick Start Guide

This menu displays direct buttons for some features. The direct buttons include: **Categories**, **Binder**, **Life Cycle**, **Scan and OCR**, **Fix and Enhance**, and **Dell Website**. You can disable this menu by checking "**Do not show this dialog again**".



Using SmarThru Office

Scanning

- 1 Click scan icon.

NOTES:

- In Microsoft® Windows® XP operating system, you can use SmarThru Office launcher, which is on the right end of taskbar, to easily open the **Scan Setting** window.



- In other operating systems beside Windows XP, click the SmarThru icon  in the tray area of the windows taskbar to activate the SmarThru Office launcher.



2 Scan Setting window opens.

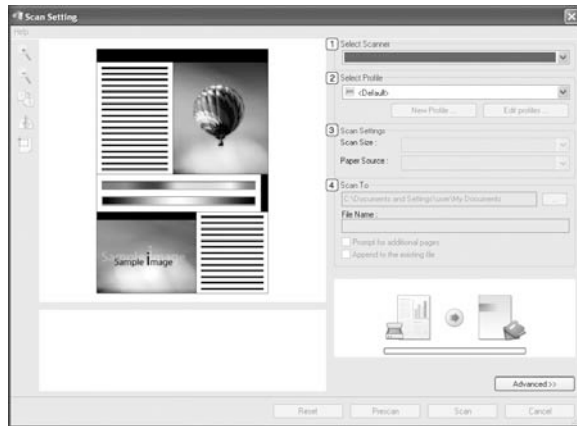

1	Select Scanner	Allows you to select between the Local or Network scanner.
2	Select Profile	Allows you to save settings frequently used for future use. Click New Profile to save the setting.
3	Scan Settings	Allows you to customize settings for Scan Size and Paper Source.
4	Scan To	Allows you to customize settings for File Name and location to send scanned data.

NOTE: Click **Advanced** button to set more scan options.

3 Set scan settings and click **Scan**. For more information, click **Help > SmarThru Office help**.

Send to

Email

You can send email while working on SmarThru Office.

NOTE: You need an email client program, such as Outlook Express, to send email in SmarThru Office. Procedure for sending email may differ depending on email client program you are using.

- 1 Select **File > Send to > Send By E-mail**.
- 2 An email client opens.
- 3 Type in necessary information and send your email.

Fax

You can send fax while working on SmarThru Office.

- 1 Select **File > Send to > Send By Fax**.
- 2 Send Fax window opens.
- 3 Type in necessary information and click **Send Fax**.

NOTE: For more information about SmarThru Office, click **Help > SmarThru Office help**. The **SmarThru Office Help** window appears; you can view on screen help supplied on the SmarThru program.

Follow the steps below to uninstall SmarThru Office. Before you begin the uninstall, ensure that all applications are closed on your computer.

- a) From the **Start** menu, select **Programs** or **All Programs**.
- b) Select **SmarThru Office**, and then select **Uninstall SmarThru Office**.
- c) When your computer asks you to confirm your selection, read the statement and click **OK**.
- d) Click **Finish**.

Scanning Process with TWAIN-enabled Software

If you want to scan documents using other software, you will need to use TWAIN-compliant software, such as Adobe® Photoshop®. The first time you scan with your machine, select it as your TWAIN source in the application you use.

The basic scanning process involves a number of steps:

- 1 Ensure that your printer and computer are turned on and properly connected to each other.
- 2 Place a single document face down on the document glass. OR load the document(s) face up into the ADF (or DADF).
- 3 Open an application, such as Photoshop.
- 4 Open the TWAIN window and set the scan options.
- 5 Scan and save your scanned image.

NOTE: You need to follow the program's instructions for acquiring an image. See the user's guide of the application.

Scanning Using the WIA Driver

Your machine also supports the Windows Image Acquisition (WIA) driver for scanning images. WIA is one of the standard components provided by Microsoft® Windows® XP and works with digital cameras and scanners. Unlike the TWAIN driver, the WIA driver allows you to scan and easily manipulate images without using additional software.

NOTE: The WIA driver works only on Windows XP/2003/Vista with USB port.

Windows XP

- 1 Place a single document face down on the document glass. OR load the document(s) face up into the ADF (or DADF).
- 2 From the **Start** menu on your desktop window, select **Settings, Control Panel**, and then **Scanners and Cameras**.
- 3 Double click **your scanner driver** icon. The Scanner and Camera Wizard launches.
- 4 Choose your scanning preferences and click **Preview** to see how your preferences affect the picture.

- 5 Click **Next**.
- 6 Enter a picture name, and select a file format and destination to save the picture.
- 7 Follow the on-screen instructions to edit the picture after it is copied to your computer.

Windows Vista

- 1 Place a single document face down on the document glass. OR load the document(s) face up into the ADF (or DADF).
- 2 Click **Start** → **Control Panel** → **Hardware and Sound** → **Scanners and Cameras**.
- 3 Click on **Scan a document or picture**. Then **Windows Fax and Scan** application is opened automatically.

NOTE: To view scanners, user can click on **View scanners and cameras**.

- 4 Click **Scan** and then scan driver is opened.
- 5 Choose your scanning preferences and click **Preview** to see your preferences affect the picture.
- 6 Click **Scan**.

NOTE: If you want to cancel the scan job, press the Cancel button on the Scanner and Camera Wizard.

6 Using other software

This chapter includes:

- **Printer Status Monitor**
- **Printer Settings Utility**
- **Dell Toner Re-order application**
- **Firmware Update Utility**

Printer Status Monitor

The printer status monitor screen launches when you send a print job to the printer. This only appears on the computer screen. Depending on the remaining toner level, the launched printer status monitor screen is different.

If you are a Windows user, from the **Start** menu, select **Programs** or **All Programs** → **Dell** → **Dell Printers** → **Dell 1235cn Color Laser MFP** → **Printer Status Monitor**.

The **Printer Status Monitor** program displays the current status of the printer, the level of toner remaining in the toner cartridge(s) and various other information. You can also change settings.

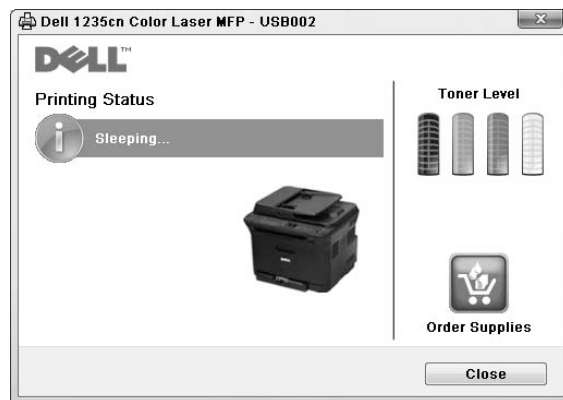

- **Printing Status:** The Printer Status Monitor displays the current status of the printer.
- **Toner Level:** You can view the level of toner remaining in the toner cartridge(s).
- **Order Supplies:** Click to order replacement toner cartridges online.
- **User's Guide:** Allows you to view the **Dell 1235cn Color Laser MFP User's Guide**.

Printer Settings Utility

When you install the Dell software, the Printer Settings Utility is automatically installed.

To open the Printer Settings Utility.

- 1 Click **Start** → **Programs** or **All Programs** → **Dell** → **Dell Printers** → **Dell 1235cn Color Laser MFP** → **Printer Settings Utility**.
The Printer Settings Utility window opens.

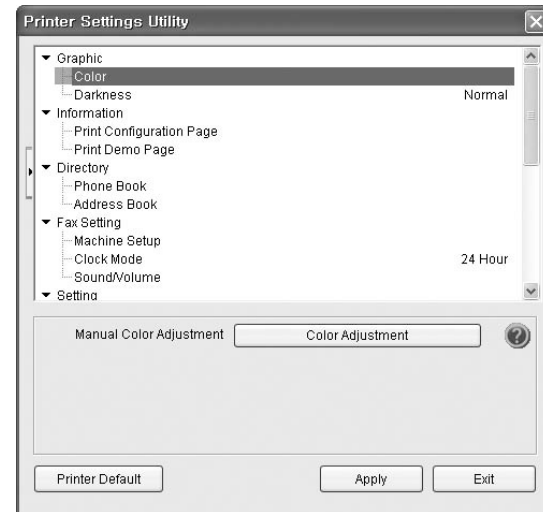

- 2 The Printer Settings Utility window provides several features.

For more information, click the  button.

To use the default settings, click the **Printer Default** button and click **Apply** button.

To exit, click the **Exit** button at the bottom of the window.

Dell Toner Re-order application

To order replacement toner cartridges or supplies from **Dell**:

- 1 Double-click the Dell Toner Reorder Program icon on your desktop.



or

Click **Start** → **Programs** or **All Programs** → **Dell** → **Dell Printers** → **Dell 1235cn Color Laser MFP** → **Dell 1235cn MFP Toner Reorder**.

- 2 The Dell 1235cn MFP Toner Reorder window opens.



Firmware Update Utility

You can update the printer firmware using **Firmware Update Utility**.

- 1 Click **Start** → **Programs** or **All Programs** → **Dell** → **Dell Printers** → **Dell 1235cn Color Laser MFP** → **Firmware Update Utility**.

The **Firmware Update Utility** window opens.

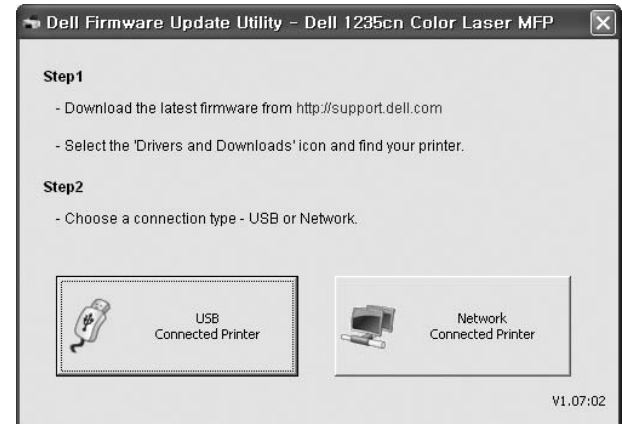

Follow the on screen instructions to complete the firmware update.

7 Using Your Printer with a Macintosh

Your printer supports Macintosh systems with a built-in USB interface or 10/100 Base-TX network interface card. When you print a file from a Macintosh computer, you can use the CUPS driver by installing the PPD file.

NOTE: *Some printers do not support a network interface. Ensure that your printer supports a network interface by referring to Printer Specifications in the Specifications chapter.*

This chapter includes:

- **Installing Software**
- **Uninstalling software**
- **Setting Up the Printer**
- **Printing**
- **Scanning**

Installing Software

The *Drivers and Utilities* CD that came with your printer provides you with the PPD file that allows you to use the CUPS driver or Apple LaserWriter driver (*only available when you use a printer which supports the PostScript driver*), for printing on a Macintosh computer.

Also, it provides you with the Twain driver for scanning on a Macintosh computer.

- 1** Ensure that you connect your printer to the computer. Turn on your computer and printer.
- 2** Insert the *Drivers and Utilities* CD which came with your printer into the computer's optical drive.
- 3** Double-click **CD icon** that appears on your Macintosh desktop.
- 4** Double-click the **MAC_Installer** folder.
- 5** Double-click the **Installer OS X** icon.
- 6** Enter the password and click **OK**.
- 7** The Dell Installer window opens. Click **Continue**
- 8** Select **Easy Install** and click **Install**. **Easy Install** is recommended for most users. All components necessary for printer operations will be installed. If you select **Custom Install**, you can choose individual components to install.
- 9** Click **Continue**, when the message which warns that all application will close appears.

- 10** After the installation is finished, click **Quit**.

NOTE:

- If you have installed scan driver, click **Restart**.
 - After the installation is finished, see "Setting Up the Printer" on page 28
-

Uninstalling software

Uninstall is required if you are upgrading the software, or if installation fails.

- 1** Insert the *Drivers and Utilities* CD which came with your printer into the computer's optical drive.
- 2** Double-click **CD icon** that appears on your Macintosh desktop.
- 3** Double-click the **MAC_Installer** folder.
- 4** Double-click the **Installer OS X** icon.
- 5** Enter the password and click **OK**.
- 6** The Dell Installer window opens. Click **Continue**.
- 7** Select **Uninstall** and click **Uninstall**.
- 8** Click **Continue**, when the message which warns that all application will close appears.
- 9** When the uninstallation is done, click **Quit**.

Setting Up the Printer

Set up for your printer will be different depending on which cable you use to connect the printer to your computer—the network cable or the USB cable.

For a Network-connected

NOTE: *Some printers do not support a network interface. Before connecting your printer, ensure that your printer supports a network interface by referring to Printer Specifications in the Specifications chapter.*

- 1 Follow the instructions on “Installing Software” on page 27 to install the PPD and Filter files on your computer.
- 2 Open the **Applications** folder → **Utilities**, and **Print Setup Utility**.
 - For MAC OS 10.5, open **System Preferences** from the **Applications** folder, and click **Printer & Fax**.
- 3 Click **Add** on the **Printer List**.
 - For MAC OS 10.5, press the “+” icon then a display window will pop up.
- 4 For MAC OS 10.3, select the **IP Printing** tab.
 - For MAC OS 10.4, click **IP Printer**.
 - For MAC OS 10.5, click **IP**.
- 5 Select **Socket/HP Jet Direct** in **Printer Type**.
WHEN PRINTING A DOCUMENT CONTAINING MANY PAGES, PRINTING PERFORMANCE MAY BE ENHANCED BY CHOOSING SOCKET FOR PRINTER TYPE OPTION.
- 6 Enter the printer’s IP address in the **Printer Address** field.
- 7 Enter the queue name in the **Queue Name** field. If you cannot determine the queue name for your printer server, try using the default queue first.
- 8 For MAC OS 10.3, if Auto Select does not work properly, select **Dell** in **Printer Model** and **your printer name** in **Model Name**.
 - For MAC OS 10.4, if Auto Select does not work properly, select **Dell** in **Print Using** and **your printer name** in **Model**.
 - For MAC OS 10.5, if Auto Select does not work properly, select **Select a driver to use...** and **your printer name** in **Print Using**.

Your printer’s IP address appears on the **Printer List**, and is set as the default printer.
- 9 Click **Add**.

For a USB-connected

- 1 Follow the instructions on “Installing Software” on page 27 to install the PPD and Filter files on your computer.
- 2 Open the **Applications** folder → **Utilities**, and **Print Setup Utility**.
 - For MAC OS 10.5, open **System Preferences** from the **Applications** folder, and click **Printer & Fax**.
- 3 Click **Add** on the **Printer List**.
 - For MAC OS 10.5, press the “+” icon then a display window will pop up.
- 4 For MAC OS 10.3, select the **USB** tab.
 - For MAC OS 10.4, click **Default Browser** and find the USB connection.
 - For MAC OS 10.5, click **Default** and find the USB connection.
- 5 For MAC OS 10.3, if Auto Select does not work properly, select **Dell** in **Printer Model** and **your printer name** in **Model Name**.
 - For MAC OS 10.4, if Auto Select does not work properly, select **Dell** in **Print Using** and **your printer name** in **Model**.
 - For MAC OS 10.5, if Auto Select does not work properly, select **Select a driver to use...** and **your printer name** in **Print Using**.

Your printer appears on the **Printer List**, and is set as the default printer.
- 6 Click **Add**.

Printing

NOTES:

- The Macintosh printer's properties window that appears in this User's Guide may differ depending on the printer in use. However the composition of the printer properties window is similar.
- *You can check your printer name in the supplied Drivers and Utilities CD.*

Printing a Document

When you print with a Macintosh, you need to check the printer software setting in each application you use. Follow these steps to print from a Macintosh.

- 1 Open a Macintosh application and select the file you want to print.
- 2 Open the **File** menu and click **Page Setup (Document Setup** in some applications).
- 3 Choose your paper size, orientation, scaling, and other options and click **OK**.

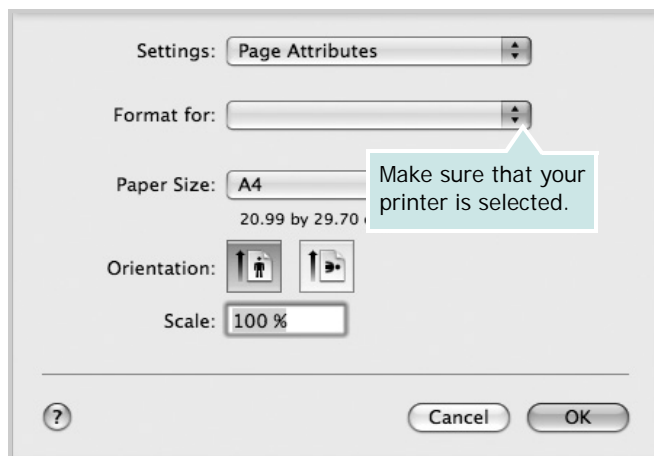

▲ Mac OS 10.5

- 4 Open the **File** menu and click **Print**.
- 5 Choose the number of copies you want and indicate which pages you want to print.
- 6 Click **Print** when you finish setting the options.

Changing Printer Settings

You can use advanced printing features when using your printer.

From your Macintosh application, select **Print** from the **File** menu. The printer name which appears in the printer properties window may differ depending on the printer in use. Except for the name, the composition of the printer properties window is similar.

NOTES: The setting options may differ depending on printers and Macintosh OS version.

Layout

The **Layout** tab provides options to adjust how the document appears on the printed page. You can print multiple pages on one sheet of paper. Select **Layout** from the **Presets** drop-down list to access the following features.

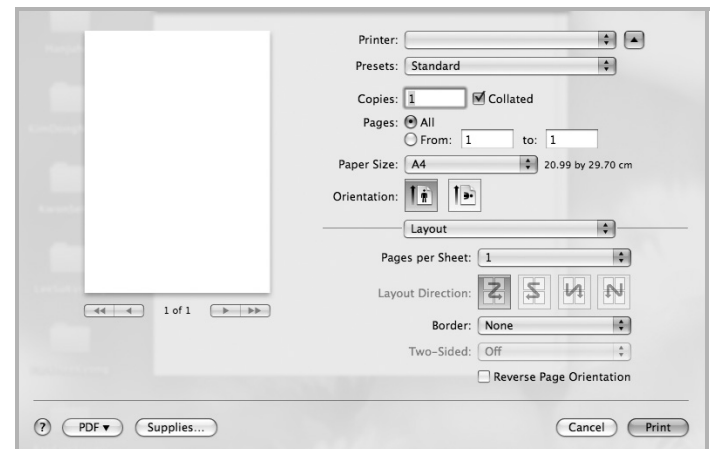

▲ Mac OS 10.5

- **Pages per Sheet:** This feature determines how many pages printed on one page. For details, see "Printing Multiple Pages on One Sheet of Paper" on the next column.
- **Layout Direction:** You can select the printing direction on a page as like the examples on UI.

Graphics

The **Graphics** tab provides options for selecting **Quality** and **Color Mode**. Select **Graphics** from the **Presets**' drop-down list to access the graphic features.

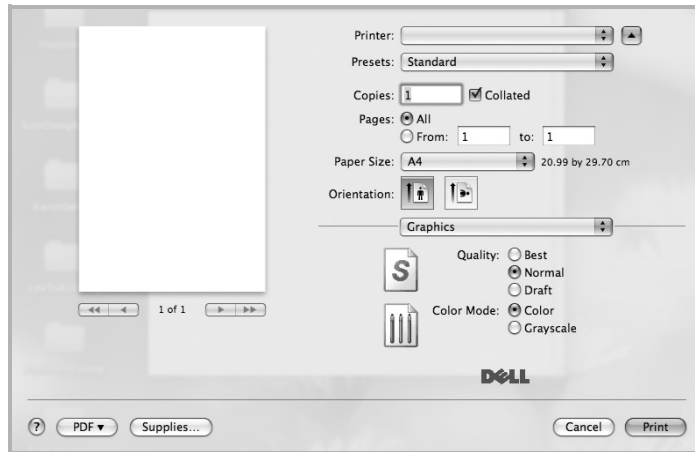

▲ Mac OS 10.5

- **Quality:** You can select the printing resolution. The higher the setting, the sharper the clarity of printed characters and graphics. The higher setting also may increase the time it takes to print a document.
- **Color Mode:** You can set the color options. Setting to **Color** typically produces the best possible print quality for color documents. If you want to print a color document in grayscale, select **Grayscale**.

Paper

Set **Paper Type** to correspond to the paper loaded in the tray from which you want to print. This will let you get the best quality printout. If you load a different type of print material, select the corresponding paper type.

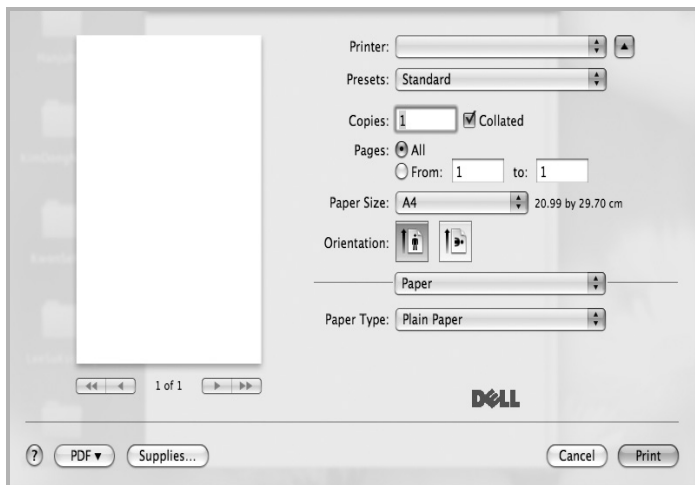

▲ Mac OS 10.5

Printing Multiple Pages on One Sheet of Paper

You can print more than one page on a single sheet of paper. This feature provides a cost-effective way to print draft pages.

- 1 From your Macintosh application, select **Print** from the **File** menu.
- 2 Select **Layout**.

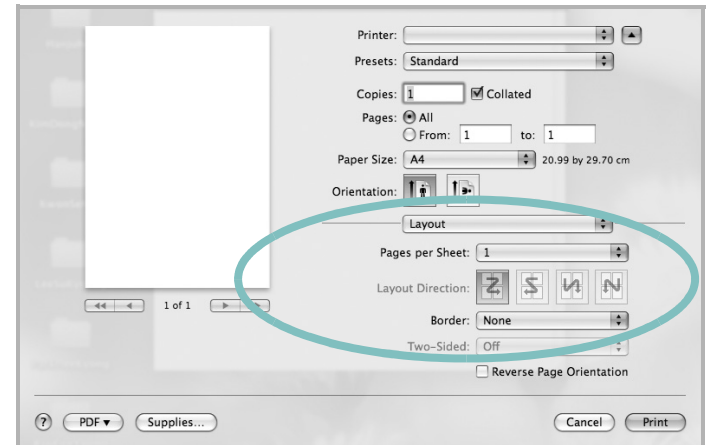

▲ Mac OS 10.5

- 3 Select the number of pages you want to print on one sheet of paper on the **Pages per Sheet** drop-down list.
- 4 Select the page order from the **Layout Direction** option. To print a border around each page on the sheet, select the option you want from the **Border** drop-down list.
- 5 Click **Print**, and the printer prints the selected number of pages on one side of each page.

Scanning

You can scan documents using **Image Capture** program. Macintosh OS offers **Image Capture** program.

Scanning with USB

- 1 Ensure that your machine and computer are turned on and properly connected to each other.
- 2 Place a single document face down on the document glass. OR load the document(s) face up into the ADF (or DADF).
- 3 Start **Applications** and click **Image Capture**.

NOTE: If **No Image Capture device connected** message appears, disconnect the USB cable and reconnect it. If the problem persists, please refer to the **Image Capture's** help.

- 4 Set the scan options on this program.
- 5 Scan and save your scanned image.

NOTE:

- For more information about using **Image Capture**, please refer to the **Image Capture's** help.
 - If you want to scan via the DADF, use TWAIN-compliant softwares.
 - You can also scan using TWAIN-compliant softwares, such as Adobe® Photoshop®.
 - Scan process differ according to TWAIN-compliant softwares. Please refer to the user's guide of the software.
 - If scanning does not operate in **Image Capture**, update Mac OS to the latest version. **Image Capture** operates properly in Mac OS X 10.3.9 or higher and Mac OS X 10.4.7 or higher.
-

SOFTWARE SECTION

INDEX

A

advanced printing, use 16

B

booklet printing 17

C

canceling
scan 24

D

document, print
Macintosh 29
Windows 11
double-sided printing 18

F

favorites settings, use 15

G

Graphics properties, set 14

H

help, use 15

I

install
printer driver
Macintosh 27
Windows 4

L

Layout properties, set
Windows 13

M

Macintosh
driver
install 27
uninstall 27
printing 29
scanning 31
setting up the printer 28

N

n-up printing
Macintosh 30
Windows 16

O

orientation, print
Windows 13
overlay
create 20
delete 20
print 20

P

Paper properties, set 13
paper size, set 13
paper source, set
Windows 13
poster, print 17
print
document 11
fit to page 18
from Macintosh 29
from Windows 11
N-up
Macintosh 30
Windows 16
overlay 20
poster 19
PRN 12
scaling 18
watermark 19

printer properties, set
Macintosh 29
Windows 12
printer resolution, set
Windows 14
printer software
install
Macintosh 27
Windows 4
uninstall
Macintosh 27
Windows 10
printing
booklets 17
double-sided 18

S

scanning
TWAIN 24
WIA driver 24
scanning from Macintosh 31
setting
darkness 14
favorites 15
image mode 14
resolution
Windows 14
toner save 14
true-type option 14
software
install
Macintosh 27
Windows 4
reinstall
Windows 9
system requirements
Macintosh 27
uninstall
Macintosh 27
Windows 10
status monitor, use 25

T

toner save, set 14

TWAIN, scan 24

U

uninstall, software
 Macintosh 27
 Windows 10

W

watermark
 create 19
 delete 19
 edit 19
 print 19
WIA, scan 24

REV 1.01

Free Manuals Download Website

<http://myh66.com>

<http://usermanuals.us>

<http://www.somanuals.com>

<http://www.4manuals.cc>

<http://www.manual-lib.com>

<http://www.404manual.com>

<http://www.luxmanual.com>

<http://aubethermostatmanual.com>

Golf course search by state

<http://golfingnear.com>

Email search by domain

<http://emailbydomain.com>

Auto manuals search

<http://auto.somanuals.com>

TV manuals search

<http://tv.somanuals.com>