

Dell™ 2150cn/2150cdn Color Printer User's Guide

Contents

Dell™ 2150cn/2150cdn Color Printer 1 User's Guide 1 Before Beginning 17

A	Notes, Notices, and Cautions	19
1	Dell™ 2150cn/2150cdn Color Printer User's Guide	21
2	Finding Information	23
3	Product Features	27
4	About the Printer	29
	Front and Rear View	29
	Front View	29
	Rear View	30
	Space Requirements	30
	Operator Panel	31
	Securing the Printer	31
	Ordering Supplies	32
	Setting up the Printer (Printer Setup)	35

5	Preparing Printer Hardware	37
	Removing Tape	37
	Removing the Print Head Device (PHD) Ribbons	38
	Installing the Toner Cartridges	38
6	Installing Optional Accessories	41
	Installing the Optional Memory Module	41
	Printing Printer Settings Report	44
	Updating Your Driver to Detect Memory Module	45
	Installing the Optional 250-Sheet Feeder	46
	Printing Printer Settings Report	49
	Updating Your Driver to Detect 250-Sheet Feeder	50
	Installing the Optional Wireless Adapter	51
	Verifying the Contents of the Box	52
	Installing the Wireless Adapter Using Video Instructions (Recommended)	52
	Installing the Optional Wireless Adapter	53
	Printing Printer Settings Report	54
	Determining the Wireless Network Settings	55
	Configuring the Optional Wireless Adapter	56
	Using Wizard Setup to Configure a Wireless Adapter	57
	Using Advanced Setup to Configure a Wireless Adapter	59
	Constructing a New Wireless Network Environment for Your Computer	66
7	Connecting Your Printer	79
	Connecting Printer to Computer or Network	80

Direct Connection	80
Network Connection	81
Turning on the Printer	82
8 Setting the IP Address	83
Assigning an IP Address	83
When Using the Easy Setup Navigator	83
When Using the Operator Panel	84
When Using the Tool Box	85
Verifying the IP Settings	86
Verifying the Settings Using Printer Settings Report	86
Verifying the Settings Using Ping Command	87
9 Loading Paper	89
10 Installing Printer Drivers on the Windows Computers 93	
Identifying Printer Driver Pre-install Status	93
When Using the Operator Panel	93
When Using the Tool Box	93
Disabling Firewall Before Installing Printer Software	94
Inserting the Drivers and Utility CD	94
Direct Connection Setup	95
Network Connection Setup	98
Network Printer Setup on a Local Network	98
Network Printer Setup on a Remote Network	104

Setting Up for Shared Printing	111
Point and Print	113
Peer-to-Peer	115

11 Installing Printer Drivers on the Macintosh Computers 121

Installing the Drivers and Software	121
Adding a Printer on Mac OS X 10.5 or 10.6	121
Adding a Printer on Mac OS X 10.4.11	123
Adding a Printer on Mac OS X 10.3.9	124
Configuring Settings	126

12 Installing Printer Drivers on the Linux Computers (CUPS) 127

Operation on Red Hat Enterprise Linux 4 WS/5 Client	127
Setup Overview	127
Installing the Printer Driver	127
Setting Up the Queue	128
Setting the Default Queue	129
Specifying the Printing Options	129
Uninstalling the Printer Driver	129
Operation on SUSE Linux Enterprise Desktop 10	130
Setup Overview	130
Installing the Printer Driver	130
Setting Up the Queue	131
Setting the Default Queue	132
Specifying the Printing Options	132
Setting the Password for Authority as the Printer Administrator	133
Uninstalling the Printer Driver	133

Operation on SUSE Linux Enterprise Desktop 11	134
Setup Overview	134
Installing the Printer Driver	134
Setting Up the Queue	134
Setting the Default Queue	136
Specifying the Printing Options	136
Setting the Password for Authority as the Printer Administrator 137	
Uninstalling the Printer Driver	137
Using Your Printer	139

13 Dell Printer Configuration Web Tool . . 141

Overview	141
When Using the Operator Panel	142
When Using the Tool Box	142
Using the Dell Printer Configuration Web Tool	143
Printer Status	143
Printer Jobs	143
Printer Settings	143
Print Server Settings	144
Copy Printer Settings	144
Print Volume	144
Printer Information	144
Tray Settings	144
E-Mail Alert	144
Set Password	144
Online Help	145
Order Supplies at:	145
Contact Dell Support at:	145
Setting Up the Dell Printer Configuration Web Tool	145

Setting Up From Web Browser	145
Setting Up From Operator Panel	148
Page Display Format	148
Top Frame	148
Left Frame	150
Right Frame	151
Changing the Settings of the Menu Items	152
Details of the Menu Items	152
Printer Status	154
Printer Jobs	156
Printer Settings	158
Print Server Settings	175
Copy Printer Settings	204
Print Volume	204
Tray Settings	207

14 Print Media Guidelines 209

Paper	209
Paper Characteristics	209
Recommended Paper	210
Unacceptable Paper	211
Selecting Paper	211
Selecting Pre-Printed Media and Letterheads	212
Selecting Pre-Punched Paper	212
Printing on a Letterhead (Pre-Printed and Pre-Punched Paper)	213
Envelopes	215
Labels	216
Storing Print Media	217

Identifying Print Media and Specifications	218
Supported Paper Sizes	218
Supported Paper Types	219
Paper Type Specifications	219
15 Loading Print Media	221
Capacity	221
Print Media Dimensions	221
Loading Print Media in the Standard 250-Sheet Tray and the Optional 250-Sheet Feeder	221
Loading Envelopes in the Standard 250-Sheet Tray and Optional 250-Sheet Feeder	224
Loading Letterhead (Pre-Printed and Pre-Punched Paper)	226
Loading Print Media in the SSF	228
Loading an Envelope in the SSF	229
Using the SSF	231
Linking Trays	232
16 Operator Panel	233
Using the Operator Panel Buttons	233
Printing a Panel Settings Page	234
When Using the Operator Panel	234
When Using the Tool Box	234
Printing 237	

17 Printing	239
Tips for Successful Printing	239
Tips on Storing Print Media	239
Avoiding Paper Jams	239
Sending a Job to Print	240
Canceling a Print Job	240
Canceling a Job From the Operator Panel	240
Canceling a Job From a Computer Running Windows	241
Duplex Printing	241
Duplex Printing With Duplexer (Dell 2150cdn Color Printer Only)	241
Duplex Printing Without Duplexer (Dell 2150cn Color Printer Only)	242
Using Booklet Print (Dell 2150cn and 2150cdn Models)	244
Using the Stored Print Function	245
Secure Print	246
Private MailBox Print	246
Public MailBox Print	246
Proof Print	246
Storing Print Jobs	247
Printing the Stored Jobs	247
Specifying Your Password on the Operator Panel (Secure Print/Private MailBox Print)	247
Deleting Stored Jobs	248
Printing a Report Page	248
Printing Printer Settings Report	248
Printing Font Sample List	249
Printer Settings	250
Printing Printer Settings Report	250

Using the Operator Panel to Change the Printer Settings	251
Using the Dell Printer Configuration Web Tool to Change the Printer Settings	252
Resetting Defaults	254
Adjusting the Language	255

Know Your Printer 257

18 Understanding the Tool Box Menus . . . 259

Printer Settings Report	259
Printer Information	259
Menu Settings	260
Reports	263
TCP/IP Settings	264
Printer Maintenance	264
System Settings	265
Date & Time	269
Paper Density	270
Color Registration Adjustment	270
Adjust Altitude	272
Reset Defaults	272
Non-Dell Toner	272
Initialize Print Meter	273
Tray Settings	273
TCP/IP Settings	276
Network Settings	277
Diagnosis	277
Chart Print	278
Machine Check	278
Paper Wrinkle Check Mode	279
Environment Sensor Info	280
Clean Developer	281

Refresh Mode	281
Resetting Defaults	281
When Using the Tool Box	281
19 Understanding the Printer Menus	283
Report / List	283
Printer Setting	283
Panel Settings	283
PCL Fonts List	283
PCL Macro List	283
Job History	284
Error History	284
Print Meter	284
Color Test Page	284
Stored Documents	284
Admin Menu	284
Print Language	284
Network	293
USB Settings	301
System Settings	301
Maintenance	310
Secure Settings	317
Tray Settings	318
Panel Language	322
Print Menu	322
Secure Print	322
Private Mail Box	323
Public Mail Box	324
Proof Print	325

Panel Lock	326
Enabling the Panel Lock	326
Disabling the Panel Lock	327
Resetting Defaults	327
When Using the Operator Panel	327

20 Understanding Your Printer Software . 329

Printer Settings Utility	331
Status Window	331
Tool Box	331
Updater	332
Troubleshooting	332
Status Monitor Widget for Macintosh	332
Status Monitor Widget Feature	332
Before Installing the Status Monitor Widget	332
Installing the Status Monitor Widget	333
Opening and Closing the Status Monitor Widget	333
Printer Status Window	334
Order Window	336
Preferences	337
Status Monitor Console for Linux	338
Status Monitor Console Feature	338
Before Installing the Status Monitor Console	338
Installing the Status Monitor Console	339
Starting the Status Monitor Console	339
Printer Selection Window	340
Printer Status Window	341
Dell Supplies Management System Window	342
Service Tag Window	344
Settings Window	344

21 Understanding Fonts	347
Typefaces and Fonts	347
Weight and Style	347
Pitch and Point Size	348
Bitmapped and Scalable Fonts	349
Resident Fonts	351
Symbol Sets	352
Symbol Sets for PCL 5/PCL 6	352
22 Understanding Printer Messages	355
23 Printing With Web Services on Devices (WSD)	
361	
Adding Roles of Printer Services	361
Printer Setup	362
Installing a Printer Driver Using the Add Printer Wizard	362
24 Specifications	365
Operating System Compatibility	365
Power Supply	365
Dimensions	365
Memory	365
Page Description Language (PDL)/Emulation, Operating System, and Interface	366

MIB Compatibility	366
Environment	366
Operation	366
Print Quality Guarantee	366
Storage	367
Altitude	367
Cables	367
Maintaining Your Printer	369

25 Maintaining Your Printer 371

Determining the Status of Supplies	371
Conserving Supplies	371
Ordering Supplies	372
Storing Print Media	372
Storing Consumables	373
Replacing the Toner Cartridges	373
Removing the Toner Cartridge	374
Installing a Toner Cartridge	375
Replacing the Print Head Device (PHD) Unit	377
Removing the PHD Unit	377
Installing a PHD Unit	379
Replacing the Retard Roller	384
Removing the Retard Roller in the Standard 250-Sheet Tray	385
Installing a Retard Roller in the Standard 250-Sheet Tray	386
Cleaning Inside the Printer	387

Cleaning the Feed Roller	387
Cleaning the CTD Sensor	392
Adjusting Color Registration	396
Printing the Color Registration Chart	396
Determining Values	397
Entering Values	399
26 Removing Options	403
Removing the Optional Memory Module	403
Removing the Optional 250-Sheet Feeder	406
Removing the Optional Wireless Adapter	408
27 Clearing Jams	411
Avoiding Jams	411
Identifying the Location of Paper Jams	412
Clearing Paper Jams From the SSF	413
Clearing Paper Jams From the Standard 250-Sheet Tray	416
Clearing Paper Jams From the Fuser	420
Clearing Paper Jams From the Duplexer	423
Clearing Paper Jams From the Optional 250-Sheet Feeder	425

Troubleshooting 429

28 Troubleshooting Guide	431
Basic Printer Problems	431

Display Problems	431
Printing Problems	432
Print Quality Problems	434
The output is too light	435
Toner smears or print comes off	438
Random spots/Blurred images	439
The entire output is blank	440
Streaks appear on the output	442
Part or the entire output is black	443
Pitched color dots	444
Vertical blanks	445
Ghosting	446
Light-induced fatigue	448
Fog	449
Bead-Carry-Out (BCO)	449
Jagged characters	450
Banding	451
Auger mark	452
Wrinkled/Stained paper	453
Damage on the leading edge of paper	455
Jam/Alignment Problems	455
The top and side margins are incorrect	456
Color registration is out of alignment	456
Images are skewed	458
Standard 250-Sheet Tray Misfeed Jam	458
SSF Misfeed Jam	460
Optional 250-Sheet Feeder Misfeed Jam	462
Regi Jam (Exit Sensor On JAM)	463
Exit Jam (Exit Sensor Off JAM)	463
Standard 250-Sheet Tray/Optional 250-Sheet Feeder Multi-feed Jam	464
SSF Multi-feed Jam	464

Noise	465
Problems With Installed Optional Accessories	467
Other Problems	467
Contacting Service	470

Appendix 475

B Appendix	477
Dell™ Technical Support Policy	477
Online Services	477
Warranty and Return Policy	478
Recycling Information	478
Contacting Dell	478

Before Beginning

Notes, Notices, and Cautions



NOTE: A **NOTE** indicates important information that helps you make better use of your printer.



NOTICE: A **NOTICE** indicates either potential damage to hardware or loss of data and tells you how to avoid the problem.



CAUTION: A **CAUTION** indicates a potential for property damage, personal injury, or death.

Information in this document is subject to change without notice.

© 2010 Dell Inc. All rights reserved.

Reproduction of these materials in any manner whatsoever without the written permission of Dell Inc. is strictly forbidden.

Trademarks used in this text: *Dell*, the *DELL* logo are trademarks of Dell Inc.; *Microsoft*, *Windows*, *Windows Server*, *Windows Vista*, and *Active Directory* are either trademarks or registered trademarks of Microsoft Corporation in the United States and/or other countries; *Adobe* and *Photoshop* are either registered trademarks or trademarks of Adobe Systems Incorporated in the United States and/or other countries; *Wi-Fi* is a registered trademarks of the Wi-Fi Alliance; *Red Hat* and *Red Hat Enterprise Linux* are registered trademarks of Red Hat, Inc. in the U.S. and other countries; *SUSE* is a registered trademark of Novell, Inc., in the United States and other countries.

XML Paper Specification (XPS): This product may incorporate intellectual property owned by Microsoft Corporation. The terms and conditions upon which Microsoft is licensing such intellectual property may be found at <http://go.microsoft.com/fwlink/?LinkId=52369>; *DES*: This product includes software developed by Eric Young (ey@mincom.oz.au); *AES*: Copyright (c) 2003, Dr Brian Gladman, Worcester, UK. All rights reserved. This product uses published AES software provided by Dr Brian Gladman under BSD licensing terms; *TIFF (libtiff)*: Copyright (c) 1988-1997 Sam Leffler and Copyright (c) 1991-1997 Silicon Graphics, Inc.; *ICC Profile (Little cms)*: Copyright (c) 1998-2004 Marti Maria.

Other trademarks and trade names may be used in this document to refer to either the entities claiming the marks and names or their products. Dell Inc. disclaims any proprietary interest in trademarks and trade names other than its own.

Our printer software uses some of the codes defined by the Independent JPEG Group.

As for RSA BSAFE



RSA BSAFE software, produced by RSA Security Inc., has been installed on this printer.

UNITED STATES GOVERNMENT RESTRICTED RIGHTS

This software and documentation are provided with RESTRICTED RIGHTS. Use, duplication or disclosure by the Government is subject to restrictions as set forth in subparagraph (c)(1)(ii) of the Rights in Technical Data and Computer Software clause at DFARS 252.227-7013 and in applicable FAR provisions: Dell Inc., One Dell Way, Round Rock, Texas, 78682, USA.

September 2010 Rev. A01

Dell™ 2150cn/2150cdn Color Printer User's Guide

Click the links to the left for information on the features, options, and operation of your printer. For information on other documentation included with your printer, see "Finding Information."

To order replacement toner cartridges or supplies from Dell:



NOTE: For Macintosh, start the Status Monitor Widget, and then select **Order Supplies** button to open **Order** window.

- 1 Double-click the icon on your desktop.



If you cannot find the icon on your desktop, follow the procedure below.

- a Click **DLRMM.EXE** under `x:\abc\Dell Printers\Additional Color Laser Software\Reorder`, where `x:\abc` is the location where the printer software is installed.
- b Click **File** on the toolbar, and click **Create Shortcut** on the drop-down menu.
- c Right-click the shortcut icon.
- d Choose **Send To** from the drop-down menu, and then click **Desktop (create shortcut)** on the submenu.

The **Dell Supplies Management System** window appears.

You can also launch the Dell Supplies Management System by clicking **Start** → **All Programs** → **Dell Printers** → **Additional Color Laser Software** → **Dell Supplies Management System**.

- 2 Click the **Visit Dell printer supplies ordering web site** link (www.dell.com/supplies), or order Dell printer supplies by phone.

To ensure that you get the best service, have your Dell printer Service Tag ready.

For information regarding locating your Service Tag number, see "Express Service Code and Service Tag."

Finding Information



NOTE: The following are the optional accessories that you can buy separately.

- Additional memory (512 MB)
- 250-sheet feeder
- Wireless adapter
- USB cable
- Ethernet cable

What are you looking for?

Find it here

- Drivers for my printer
- My *User's Guide*

Drivers and Utilities CD



The *Drivers and Utilities CD* contains setup video, documentation, and drivers for your printer. You can use the CD to install drivers or access your setup video and documentation.

Readme files may be included on your CD to provide last-minute updates about technical changes to your printer or advanced technical reference material for experienced users or technicians.

What are you looking for?

Find it here

- How to use my printer

Quick Reference Guide

Dell™ 2100n Color Printer
Quick Reference Guide



About Your Printer

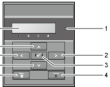
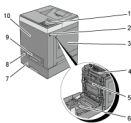

1 Operator Panel	6 Display (2100n only)
2 Ink Meter	7 Operational LED (Ready)
3 Front Access Cover (Open cartridge access)	8 Standard 250 Sheet Tray
4 Fuser	9 Single Sheet Feeder (SSF)
5 Roll Cover	10 Ink Cartridge

NOTE: You can open the front cover by sliding the Roll Cover.



Service Tag

September 2015

1 Ready / Error LED	Light glows when the printer is ready to accept and print a page (also a long period). Glows LED
2 Error LED	Light glows when an error occurs and blinks when an unrecoverable print error occurs. Error LED
3 Ink Meter	In the Meter mode, shows ink volume or setting values.
4 X (Cancel) button	In the Meter mode, displays the selected menu or item and advances the selected value.
5 M (Menu) button	On the top level of the Meter mode, switches to the Print mode.
6 V (View) button	In the Print mode, switches to the Meter mode.
7 L (LED) Panel	Displays status settings, notifications, and error messages.

NOTE: Moving to a different menu or category in a menu tree can take the current menu or setting back to the previous or "0" level to load the current menu or setting.

- Safety information
- Warranty information

Product Information Guide



CAUTION: Read and follow all safety instructions in your *Product Information Guide* prior to setting up and operating your printer.

What are you looking for? Find it here

- How to set up my printer *Setup diagram*

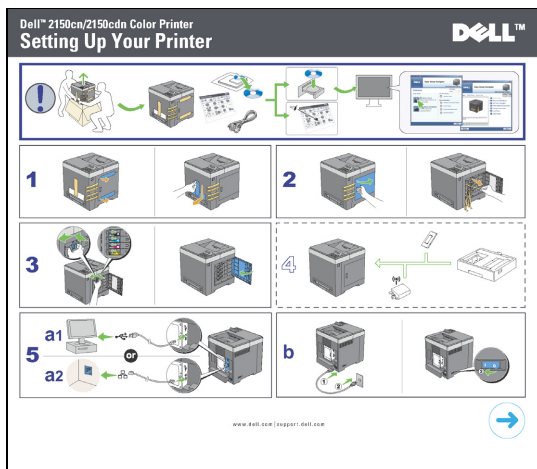

- Express Service Code and Service Tag

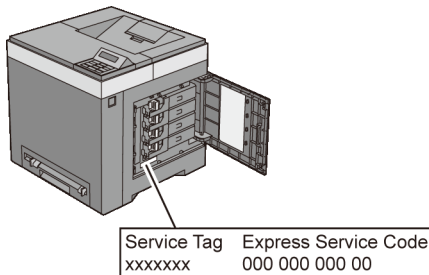

The Express Service Code and Service Tag are located inside the toner access cover of your printer.

- Latest drivers for my printer Go to **support.dell.com**.
- Documentation for my printer

What are you looking for?

Find it here

- Answers to technical service and support questions

support.dell.com provides several online tools, including:

- Solutions — Troubleshooting hints and tips, articles from technicians, and online courses
- Upgrades — Upgrade information for components, such as the printer drivers
- Customer Care — Contact information, order status, warranty, and repair information
- Downloads — Drivers
- Manuals— Printer documentation and product specifications

Go to **support.dell.com**. Select your region, and fill in the requested details to access help tools and information.

Product Features

This chapter describes the product features and indicates their links.

Duplex Printing (Duplex Print)

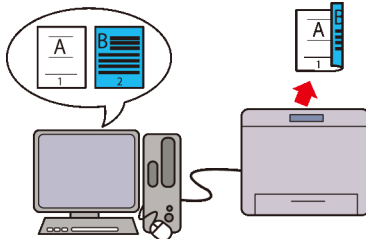

You can print two or more pages on both sides of a sheet of paper. For models with the duplexer (2150cdn Color Printer), automatic duplex printing is available. Manual duplex printing is available for models without the duplexer (2150cn Color Printer).

Using the Stored Print Function (Stored Print)

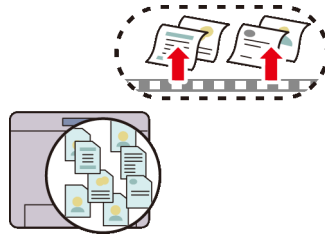

The Stored Print feature allows you to temporarily store your print data in the printer memory and output it later. You can effectively manage your time when you print confidential data or large-volume data at off-peak hours.

Multiple Up in the Layout tab (N-up Print)

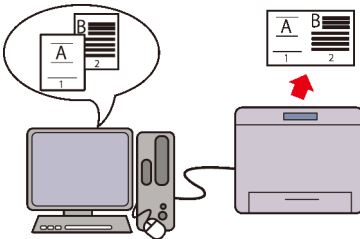

The Multiple Up feature enables you to print documents as reduced-size documents containing 2, 4, 8, 16, or 32 pages on a single sheet of paper by setting from the printer driver. This feature helps save paper.

Installing the Optional Wireless Adapter (Wireless Print)

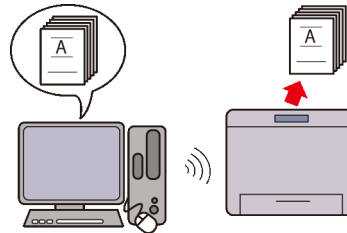

With wireless LAN in the printer, you can install the printer wherever you like, and print without connecting the printer to your computer directly.

About the Printer

This chapter provides an overview of your Dell™ 2150cn/2150cdn Color Printer.

 NOTE: In this manual, Dell 2150cn Color Printer is referred to as the "printer".

 NOTE: The images used and procedures described in this manual are those of Dell 2150cn Color Printer.

Front and Rear View

Front View

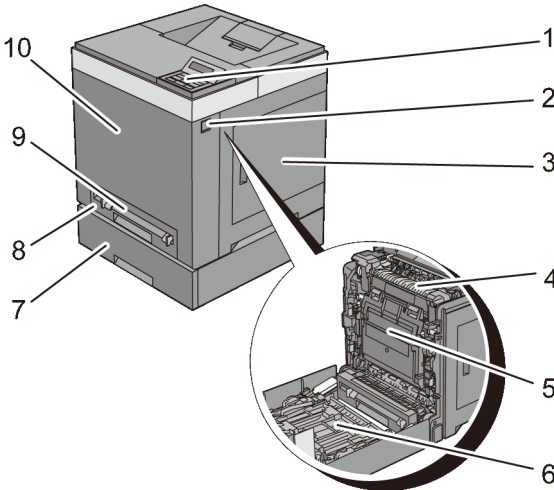

1	Operator Panel	6	Duplexer (2150cdn only)
2	Side Button	7	Optional 250-Sheet Feeder
3	Toner Access Cover (toner cartridges inside)	8	Standard 250-Sheet Tray
4	Fuser	9	Single Sheet Feeder (SSF)

5 Belt Unit

10 Front Cover

NOTE: You can open the front cover by pushing the side button (2).

➔ NOTICE: To avoid irregular screen image or malfunctioning of your printer, avoid placing the printer in direct sunlight with the single sheet feeder opened.

Rear View

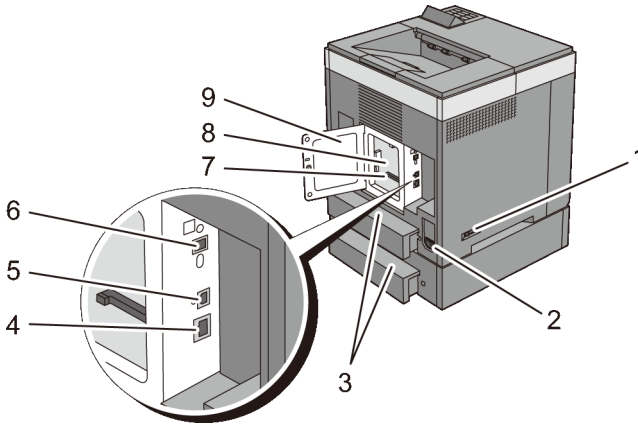

1 Power Switch

6 Wireless Adapter Socket

2 Power Connector

7 Memory Slot

3 Tray Rear Cover

8 Control Board

4 Ethernet Port

9 Control Board Cover

5 USB Port

Space Requirements

Provide enough room to open the printer trays, covers, and optional accessories, and for proper ventilation.

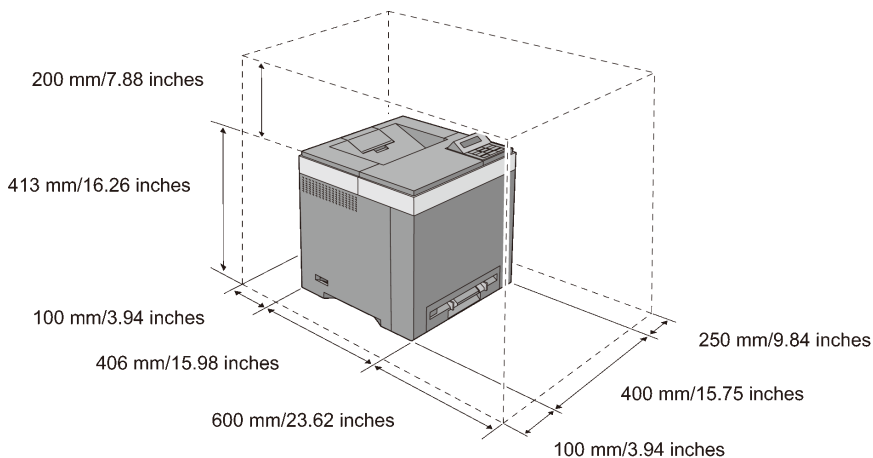

Operator Panel



For more information on the operator panel, see "Using the Operator Panel Buttons."

Securing the Printer

To protect your printer from theft, you can use the optional Kensington lock. Attach the Kensington lock to the security slot on your printer.

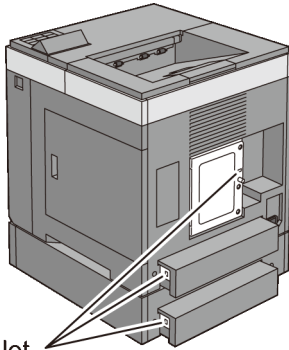

Security Slot

For details, see the operating instructions supplied with the Kensington lock.

Ordering Supplies

You can order consumables from Dell online when using a networked printer. Enter the IP address of your printer in your web browser, launch the Dell Printer Configuration Web Tool, and click the web address under **Order Supplies at:** to order toner or supplies for your printer.

You can also order replacement toner cartridges or supplies from Dell:

 **NOTE:** For Macintosh, start the Status Monitor Widget, and then select **Order Supplies** button to open **Order** window.

- 1 Double-click the icon on your desktop.



If you cannot find the icon on your desktop:

- a Click **DLRMM.EXE** under `x:\abc\Dell Printers\Additional Color Laser Software\Reorder`, where `x:\abc` is the location where the printer software is installed.
- b Click **File** on the toolbar, and then **Create Shortcut** on the drop-down menu.
- c Right-click on the shortcut icon.

- d Choose **Send To** from the drop-down menu, and then click **Desktop (create shortcut)** on the submenu.

The **Dell Supplies Management System** window appears.

You can also launch the Dell Supplies Management System by clicking **Start → All Programs → Dell Printers → Additional Color Laser Software → Dell Supplies Management System**.

- 2 Click the **Visit Dell printer supplies ordering web site** link (www.dell.com/supplies), or order Dell printer supplies by phone.

To ensure that you get the best service, have your Dell printer's Service Tag ready.

For information regarding locating your Service Tag, see "Express Service Code and Service Tag."

Setting up the Printer (Printer Setup)

Preparing Printer Hardware

Removing Tape

- 1 Remove tapes and packaging material from the printer.

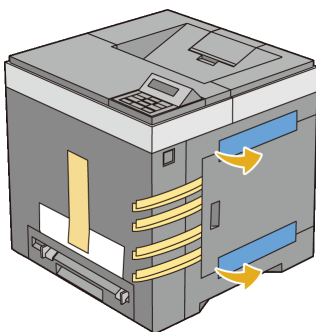

- 2 Pull the protective sheet out of the printer.

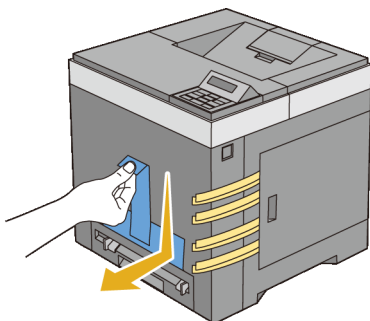

⚠ CAUTION: Before performing any of the following procedures, read and follow the safety instructions in your *Product Information Guide*.

Removing the Print Head Device (PHD) Ribbons

- 1 Open the toner access cover.

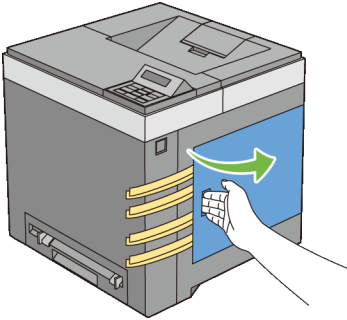

- 2 Completely pull out the eight yellow ribbons.

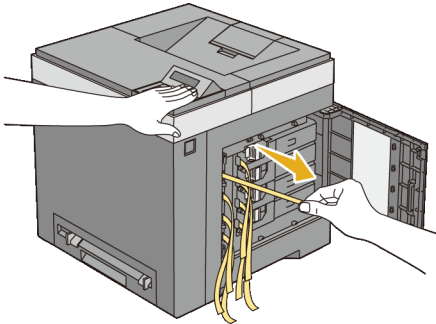

Installing the Toner Cartridges

- 1 Press and slide the blue latches of the four toner cartridges to the locked position.

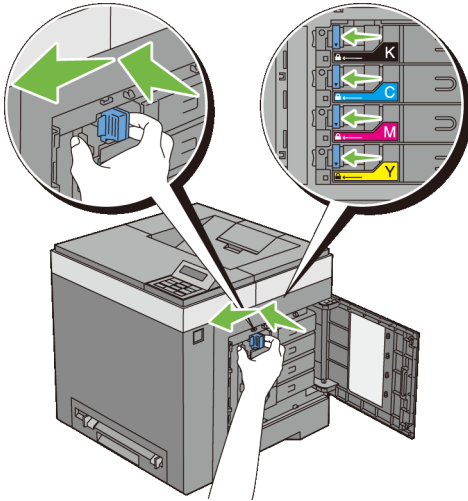

2 Close the toner access cover.

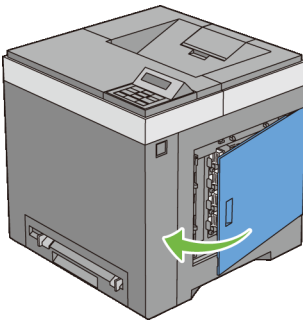

Installing Optional Accessories

You can make the printer more functional by installing the optional accessories. This chapter describes how to install the printer's options such as the memory module and optional 250-sheet feeder.

 **NOTE:** The images used and procedures described in this manual are those of Dell™ 2150cn Color Printer.

Installing the Optional Memory Module

 **NOTE:** Your printer supports additional 512 MB memory module.

- 1 Ensure that the printer is turned off.
- 2 Turn the screw on the control board cover counterclockwise and open the cover.

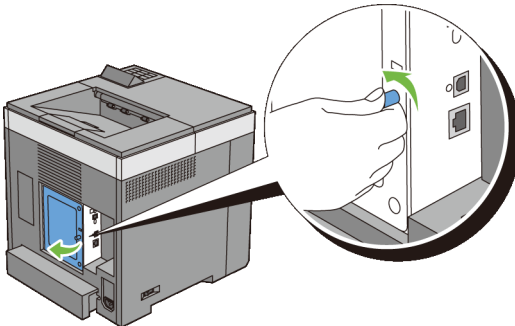

- 3 Remove the control board cover.

 **NOTE:** Remove the control board cover by pulling it upward until the lower hinge is out of the slit, and then pull the cover towards you and remove it.

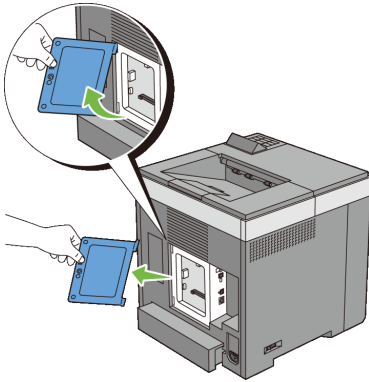

- 4 Align the connector of the memory module with the slot, and insert the memory module into the slot.

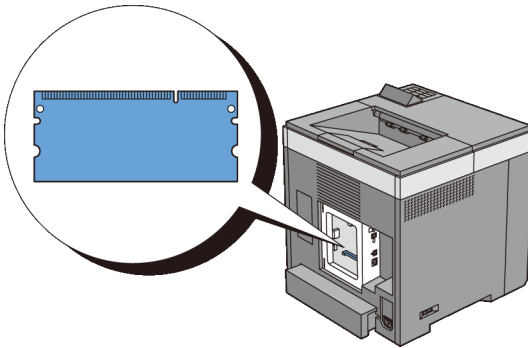

- 5 Push the memory module firmly into the slot.

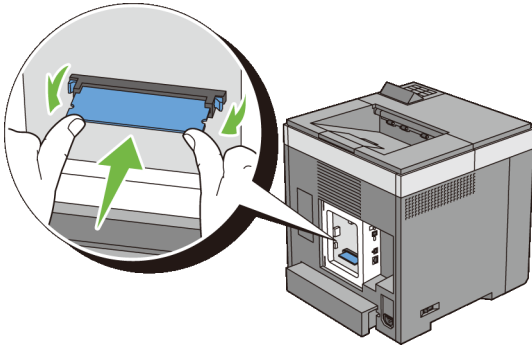

 **NOTE:** Ensure that the memory module is firmly fixed in the slot and does not move easily.

6 Install the control board cover.

 **NOTE:** Insert the upper hinge of the control board cover into the upper slit on the printer. Next, insert the lower hinge of the control board cover into the lower slit of the printer.

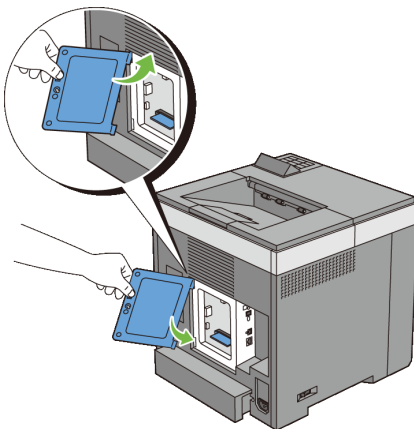

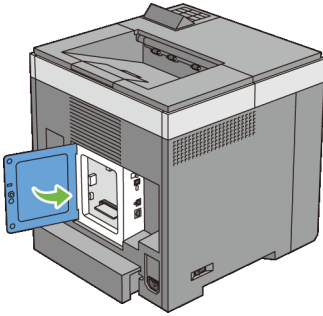

7 Close the control board cover and turn the screw clockwise.



- 8 Turn on the printer.
- 9 Print the printer settings report to confirm that the newly installed memory is detected by the printer.

Printing Printer Settings Report

When Using the Operator Panel

- a Press the  (**Menu**) button.
- b Ensure that **Report/List** is displayed, and then press the  (**Set**) button.
- c Ensure that **Printer Setting** is displayed, and then press the  (**Set**) button.

The printer settings report is printed.

When Using the Tool Box



NOTE:

- a Click **Start** → **All Programs** → **Dell Printers** → **Dell 2150 Color Printer** → **Tool Box**.



NOTE: The **Select Printer** dialog box opens in this step when multiple printer drivers are installed on your computer. In this case, click the name of this printer listed in **Printer Names**, and then click **OK**.

The **Tool Box** opens.

- b Ensure that the **Printer Settings Report** tab is open.
- c Select **Reports** from the list at the left side of the page.

The **Reports** page appears.

- d Click the **Printer Settings** button.

The printer settings report is printed.

- 10 Confirm the amount of **Memory Capacity** listed in the printer settings report under **General**.

If the memory capacity has not increased, turn off the printer, unplug the power cable, and re-install the memory module.

- 11 If you installed the optional memory module after installing the printer driver, update your driver by following the instructions for the operating system you are using. If the printer is on a network, update the driver for each client.

Updating Your Driver to Detect Memory Module

Microsoft® Windows® 7/Windows 7 x64/ Windows Server® 2008 R2 x64	<ol style="list-style-type: none">1 Click Start → Devices and Printers.2 Right-click the printer icon of the Dell 2150cn Color Printer and select Printer properties.3 Click the Options tab, and then select Get Information from Printer.4 Click Apply, and then click OK.5 Close the Devices and Printers dialog box.
Windows Vista®/ Vista x64	<ol style="list-style-type: none">1 Click Start → Control Panel → Hardware and Sound → Printers.2 Right-click the printer icon of the Dell 2150cn Color Printer and select Properties.3 Click the Options tab, and then select Get Information from Printer.4 Click Apply, and then click OK.5 Close the Printers dialog box.

-
- | | |
|---|---|
| Windows Server 2008/
Server 2008 x64 | <ol style="list-style-type: none">1 Click Start → Control Panel → Printers.2 Right-click the printer icon of the Dell 2150cn Color Printer and select Properties.3 Click the Options tab, and then select Get Information from Printer.4 Click Apply, and then click OK.5 Close the Printers dialog box. |
|---|---|
-

- | | |
|--|--|
| Windows XP/XP x64/
Windows Server 2003/
Windows Server 2003
x64 | <ol style="list-style-type: none">1 Click start → Printers and Faxes.2 Right-click the printer icon of the Dell 2150cn Color Printer and select Properties.3 Click the Options tab, and then select Get Information from Printer.4 Click Apply, and then click OK.5 Close the Printers and Faxes dialog box. |
|--|--|
-

If the printer information is not updated automatically after clicking **Get Information from Printer**, follow these steps:

- 1 Click the **Options** tab, and then select **Memory Capacity** in the **Items** list box.
- 2 Select the total amount of the installed printer memory for the memory capacity setting.
- 3 Click **Apply**, and then click **OK**.
- 4 Close the **Printers and Faxes**(, **Printers**, or **Devices and Printers**) dialog box.

Installing the Optional 250-Sheet Feeder



CAUTION: If you install the optional 250-sheet feeder after setting up the printer, be sure to turn off the printer, unplug the power cable, and disconnect all cables from the back of the printer before starting this task.

- 1 Ensure that the printer is turned off, and then disconnect all cables from the back of the printer.
- 2 Remove all packaging from the optional 250-sheet feeder.
- 3 Place the optional 250-sheet feeder in the location that the printer is located.

- 4 Pull the standard 250-sheet tray out of the printer about 200 mm. Hold the standard 250-sheet tray with both hands, and remove it from the printer.

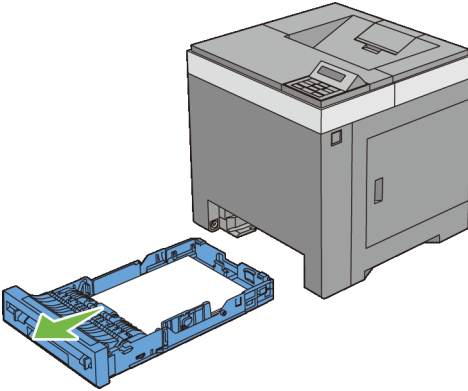

- 5 Lift the printer and align the five guide pins of the optional 250-sheet feeder with the holes at the bottom of the printer. Gently lower the printer onto the optional 250-sheet feeder.



CAUTION: Two people are required to lift the printer. The printer should be lifted holding the front and back. Never lift the printer from its sides.

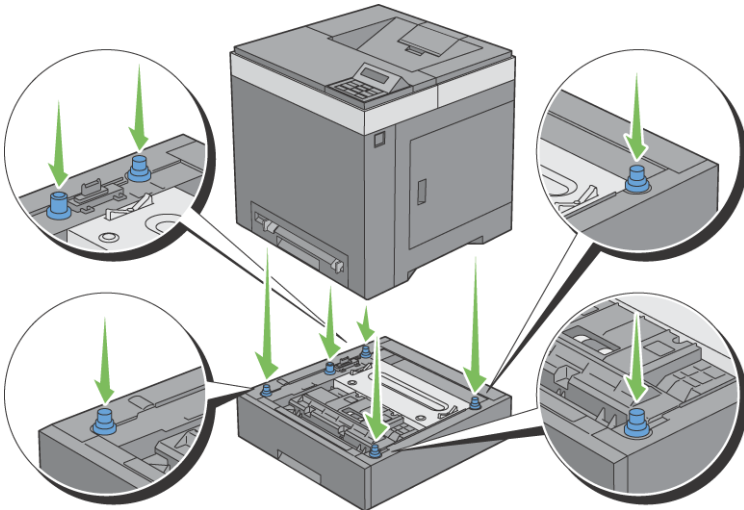

⚠ CAUTION: Be careful not to pinch your fingers when lowering the printer onto the optional 250-sheet feeder.

- 6 Secure the optional 250-sheet feeder to the printer by tightening the two screws provided with the feeder, with a coin or similar object.

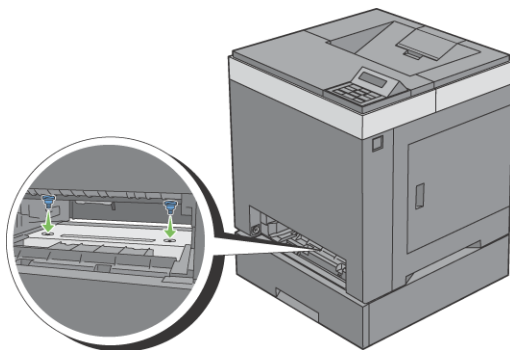

✍ NOTE: The screw hole is located in 216 mm recess from the front of the printer.

- 7 Insert the standard 250-sheet tray into the printer, and push until it stops.

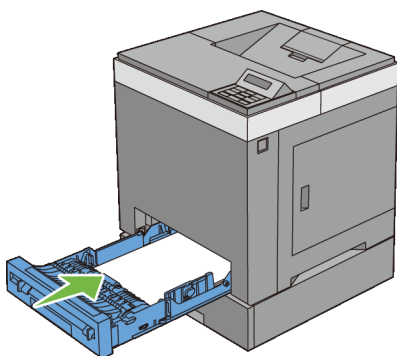



- 8 Re-connect all cables into the back of the printer, and turn on the printer.

✍ NOTE: The printer will automatically detect the attached tray but will not detect the paper type.

- 9 Print the printer settings report to confirm the optional 250-sheet feeder is installed correctly.

Printing Printer Settings Report

When Using the Operator Panel

- a Press the  (**Menu**) button.
- b Ensure that **Report/List** is displayed, and then press the  (**Set**) button.
- c Ensure that **Printer Setting** is displayed, and then press the  (**Set**) button.

The printer settings report is printed.

When Using the Tool Box

 **NOTE:**

- a Click **Start**→ **All Programs**→ **Dell Printers**→ **Dell 2150 Color Printer**→ **Tool Box**.

 **NOTE:** The **Select Printer** dialog box opens in this step when multiple printer drivers are installed on your computer. In this case, click the name of this printer listed in **Printer Names**, and then click **OK**.



The **Tool Box** opens.







- b Ensure that the **Printer Settings Report** tab is open.
- c Select **Reports** from the list at the left side of the page.
The **Reports** page appears.
- d Click the **Printer Settings** button.

The printer settings report is printed.

- 10 Confirm **Tray 2 (250 Sheet Feeder)** is listed in the printer settings report under **Printer Options**.

If the feeder is not listed, turn off the printer, unplug the power cable, and re-install the optional 250-sheet feeder.

- 11 After loading paper in the optional 250-sheet feeder, specify the paper type from the printer operator panel.
 - a Press the  (**Menu**) button.
 - b Press  button until **Tray Settings** appears, and then press the  (**Set**) button.

- c Press  button until Tray 2 appears, and then press the  (**Set**) button.
 - d Press  button until Paper Type appears, and then press the  (**Set**) button.
 - e Press  button until the paper type for the optional 250-sheet feeder appears, and then press the  (**Set**) button.
 - f Confirm that the selected paper type is displayed, and then press the  (**Menu**) button.
- 12 If you installed the optional 250-sheet feeder after installing the printer driver, update your driver by following the instructions for each operating system. If the printer is on a network, update the driver for each client.

Updating Your Driver to Detect 250-Sheet Feeder

Microsoft Windows 7/ Windows 7 x64/ Windows Server 2008 R2 x64	<ol style="list-style-type: none"> 1 Click Start → Devices and Printers. 2 Right-click the printer icon of the Dell 2150cn Color Printer and select Printer properties. 3 Click the Options tab, and then select Get Information from Printer. 4 Click Apply, and then click OK. 5 Close the Devices and Printers dialog box.
Windows Vista/Vista x64	<ol style="list-style-type: none"> 1 Click Start → Control Panel → Hardware and Sound → Printers. 2 Right-click the printer icon of the Dell 2150cn Color Printer and select Properties. 3 Click the Options tab, and then select Get Information from Printer. 4 Click Apply, and then click OK. 5 Close the Printers dialog box.
Windows Server 2008/ Server 2008 x64	<ol style="list-style-type: none"> 1 Click Start → Control Panel → Printers. 2 Right-click the printer icon of the Dell 2150cn Color Printer and select Properties. 3 Click the Options tab, and then select Get Information from Printer. 4 Click Apply, and then click OK. 5 Close the Printers dialog box.

Windows XP/XP x64/	1 Click start → Printers and Faxes .
Windows Server 2003/	2 Right-click the printer icon of the Dell 2150cn Color Printer
Windows Server 2003	and select Properties .
x64	3 Click the Options tab, and then select Get Information from Printer .
	4 Click Apply , and then click OK .
	5 Close the Printers and Faxes dialog box.

If the printer information is not updated automatically after clicking **Get Information from Printer**, follow these steps:

- 1 Click the **Options** tab, and then select **250 Sheet Feeder** on the **Items** list box.
- 2 Select **Available** for the optional 250-sheet feeder setting.
- 3 Click **Apply**, and then click **OK**.
- 4 Close the **Printers and Faxes**(, **Printers**, or **Devices and Printers**) dialog box.

Installing the Optional Wireless Adapter

The wireless adapter allows you to use the printer with wireless network connection.

The specifications of the wireless adapter are described below.

Item	Specification
Connectivity Technology	Wireless
Compliant Standards	802.11b, 802.11g, and 802.11n
Bandwidth	2.4 GHz
Data Transfer Rate	802.11n: 65 Mbps 802.11g: 54, 48, 36, 24, 18, 12, 9, and 6 Mbps 802.11b: 11, 5.5, 2, and 1 Mbps
Security	64 (40-bit key)/128 (104-bit key) WEP, WPA- PSK (TKIP, AES), WPA2-PSK (AES) (IEEE 802.1x attestation function of WPA 1x non-corresponds)

Item	Specification
Wi-Fi [®] Protected Setup (WPS)	Push-Button Configuration (PBC), Personal Identification Number (PIN)

 **NOTE:** When the wireless adapter is installed, you cannot use IEEE 802.1x authentication and/or the Ethernet port for a wired connection.

Verifying the Contents of the Box

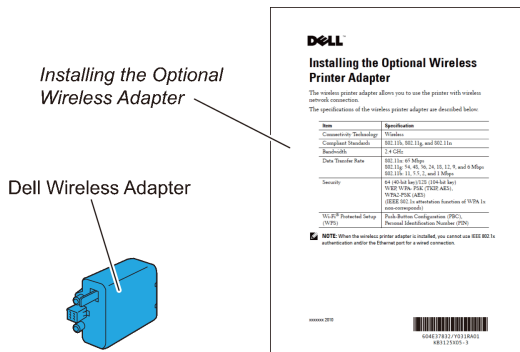

 **NOTE:** To complete wireless installation, you require the corresponding *Drivers and Utilities* CD that comes with your printer, which can also be downloaded from support.dell.com.

Installing the Wireless Adapter Using Video Instructions (Recommended)

To install the Dell wireless adapter, perform the following method.

- 1 Insert the *Drivers and Utilities* CD in your computer. The **Easy Setup Navigator** file launches automatically.
- 2 Select **Optional Accessories Setup** on the **Easy Setup Navigator** window.

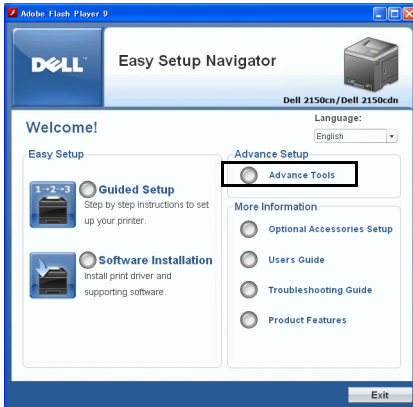

3 Click **Wireless adapter**.

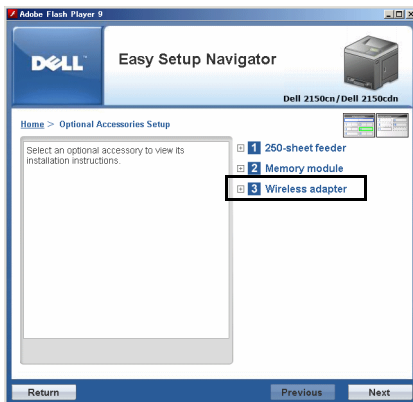

The instruction video starts.

Follow the on-screen instructions to configure wireless settings.

Installing the Optional Wireless Adapter



NOTE: You can also install the Dell wireless adapter by following the instructions described in *Installing the Optional Wireless Adapter* provided with the wireless adapter.

1 Ensure that the printer is turned off.

- 2 Align the connector and the three protrusions of the wireless adapter with the four holes and insert the adapter.

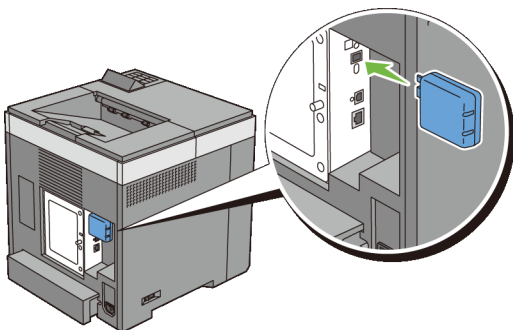



 **NOTE:** Ensure that the adapter is fully inserted and secured.

- 3 Turn on the printer.
- 4 Print the printer settings report to confirm that the wireless adapter is installed correctly.

Printing Printer Settings Report

When Using the Operator panel

- a Press the  (**Menu**) button.
- b Ensure that **Report/List** is displayed, and then press the  (**Set**) button.
- c Ensure that **Printer Settings** is displayed, and then press the  (**Set**) button.

The printer settings report is printed.

When Using the Tool Box

 **NOTE:**

- a Click **Start** → **All Programs** → **Dell Printers** → **Dell 2150 Color Printer** → **Tool Box**.

 **NOTE:** The **Select Printer** dialog box opens in this step when multiple printer drivers are installed on your computer. In this case, click the name of this printer listed in **Printer Names**, and then click **OK**.

Wireless Settings	SSID	Specifies the name that identifies the wireless network with up to 32 alphanumeric characters.
	Network Type	Specifies the network type from Ad-hoc or Infrastructure.
Security Settings	Security	Selects the security method from No security, WEP, WPA-PSK TKIP, and WPA2-PSK-AES/WPA-PSK-AES.
	Transmit Key	Specifies the transmit key from the list.
	WEP Key	Specifies the WEP key set used through the wireless network only when WEP is selected for Security.
	Pass Phrase	Specifies the pass phrase of alphanumeric characters from 8 to 63 bytes long only when WPA-PSK is selected for Encryption.

Configuring the Optional Wireless Adapter

This section describes how to configure a wireless adapter through Easy Setup Navigator.

You can select a method to configure a wireless adapter from the following:

Wizard Setup through USB connection

Advanced Setup through

Network (Ethernet) connection

WPS-PIN*¹

WPS-PBC*²

Operator Panel

Dell Printer Configuration Web Tool

*1 WPS-PIN (Wi-Fi Protected setup-Personal Identification Number) is a method to authenticate and register devices required for wireless configuration, by entering PIN assignments in the printer and computer. This setting, performed through access point, is available only when the access points of your wireless router supports WPS.

*2 WPS-PBC (Wi-Fi Protected Setup-Push Button Configuration) is a method to authenticate and register devices required for wireless configuration, by pressing the button provided on the access point via wireless routers, and then performing WPS-PBC setting on the operator panel. This setting is available only when the access point supports WPS.



NOTE: The optional wireless adapter must be installed on the printer.



NOTE: For information on how to install a wireless adapter, see "Installing the Optional Wireless Adapter."

Using Wizard Setup to Configure a Wireless Adapter

- 1 Insert the *Drivers and Utilities* CD provided with the printer in your computer. The **Easy Setup Navigator** file launches automatically.

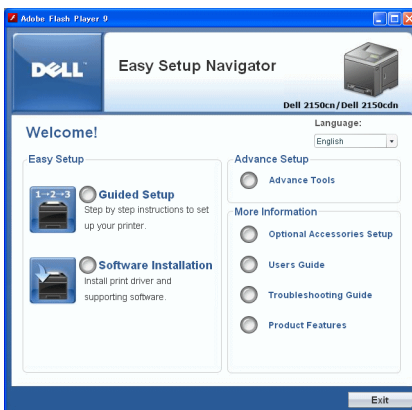

- 2 Click **Guided Setup**.

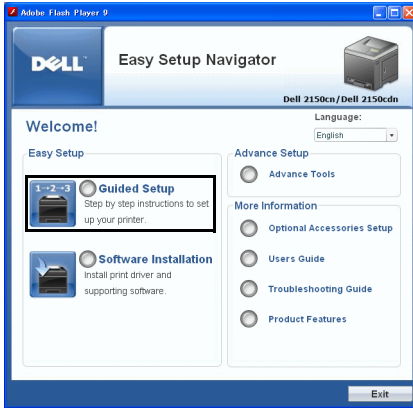

3 Click **Connect Your Printer**.

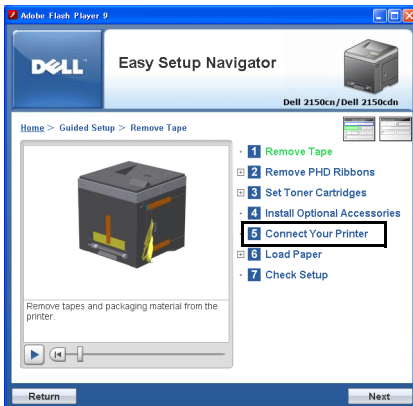

4 Select **Wireless Connection**, and then click the **Next** button.

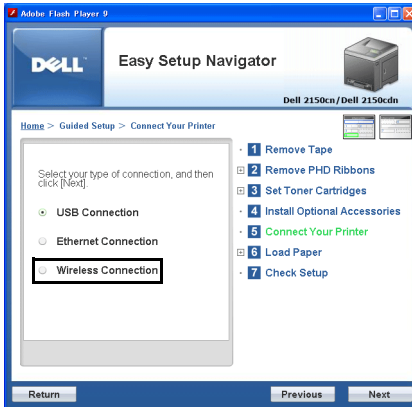

The **Wireless Connection** window appears.

- 5 Select **Wizard**, and then click the **Next** button.

The instruction video starts.

Follow the on-screen instructions to configure wireless settings.

Using Advanced Setup to Configure a Wireless Adapter

You can configure the wireless adapter with the following connection methods:

- Network Cable
- WPS-PIN
- WPS-PBC
- Operator Panel
- Dell Printer Configuration Web Tool

- 1 Insert the *Drivers and Utilities* CD provided with the printer in your computer. The **Easy Setup Navigator** file launches automatically.



2 Click **Guided Setup**.

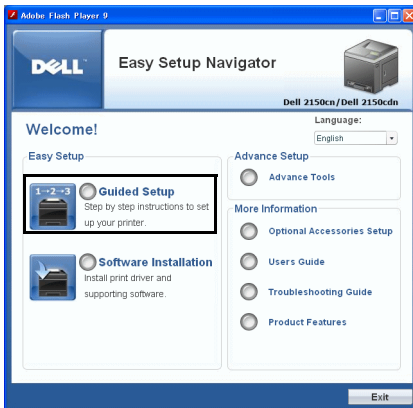

3 Click **Connect Your Printer**.

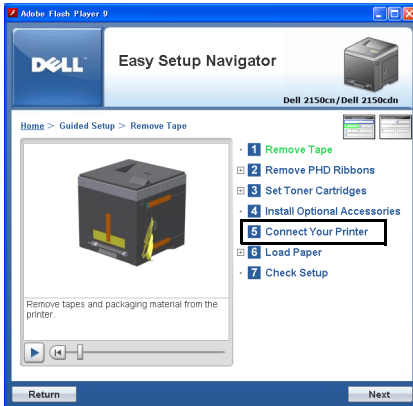

4 Select **Wireless Connection**, and then click the **Next** button.

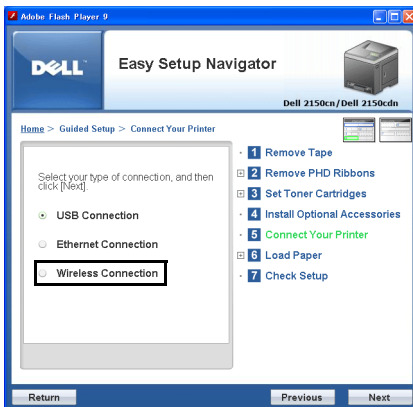

The **Wireless Connection** window appears.

For **Network**, follow the on-screen instructions to configure wireless settings.

1 Select **Network Cable**, and then click the **Next** button.

The instruction video starts.

Follow the on-screen instructions to configure wireless settings, and then click the **Next** button.

The **Advanced Configuration Tool** starts.

- 2 Select the printer, and then click the **Next** button.

Wireless Network Settings screen appears.



NOTE: If the printer cannot detect your printer and your printer is not listed, click **Enter IP Address** button and enter the IP address of your printer, and then click the **OK** button.

- 3 Set the wireless network settings, and then click the **Next** button.

IP Address Settings screen appears.



NOTE: For details on each item, see "Assigning an IP Address."

- 4 Set the IP address of the printer, and then click the **Next** button.

Confirm the settings screen appears.

- 5 Confirm the settings, and then click the **Apply** button.

Complete configuration screen appears.

- 6 Click the **Next** button.

For **WPS-PIN**, **WPS-PBC**, **Operator Panel**, and **Dell Printer Configuration Web Tool**, follow the on-screen instructions to configure wireless settings.







To configure wireless settings without using the video instructions, follow the following instructions.



WPS-PIN

The PIN code of WPS-PIN can only be configured from the operator panel.



NOTE: WPS-PIN (Wi-Fi Protected setup-Personal Identification Number) is a method to authenticate and register devices required for wireless configuration, by entering PIN assignments to a printer and computer. This setting, performed through access point, is available only when the access points of your wireless router supports WPS.





- 1 Press the  (**Menu**) button.
- 2 Press  button until **Admin Menu** appears, and then press the  (**Set**) button.
- 3 Press  button until **Network** appears, and then press the  (**Set**) button.
- 4 Press  button until **Wireless Setup** appears, and then press the  (**Set**) button.



- 5 Ensure that WPS is displayed, and then press the ✓ (Set) button.
- 6 Press  button until PIN Code appears, and then press the ✓ (Set) button.
- 7 Write down the 8-digit PIN code displayed on the panel or press  button until Print PIN Code appears, and then press the ✓ (Set) button.
The PIN code is printed.
- 8 Ensure that Start Config. is displayed, and then press the ✓ (Set) button.
- 9 Ensure that the message Please wait Wireless Setting is displayed, and enter the PIN code displayed on the step 7 into the wireless LAN access point (Registrar).
 NOTE: For WPS operation on the wireless LAN access point, refer to the manual supplied with the wireless LAN access point.
- 10 When the WPS operation is successful and the printer is rebooted, wireless LAN connection setting is completed.

WPS-PBC













You can start Push Button Control only from the operator panel.

 NOTE: WPS-PBC (Wi-Fi Protected Setup-Push Button Configuration) is a method to authenticate and register devices required for wireless configuration, by pressing the button provided on the access point via wireless routers, and then performing WPS-PBC setting on the operator panel. This setting is available only when the access point supports WPS.

- 1 Press the  (Menu) button.
- 2 Press  button until Admin Menu appears, and then press the ✓ (Set) button.
- 3 Press  button until Network appears, and then press the ✓ (Set) button.
- 4 Press  button until Wireless Setup appears, and then press the ✓ (Set) button.
- 5 Ensure that WPS is displayed, and then press the ✓ (Set) button.
- 6 Ensure that Push Btn. Ctrl is displayed, and then press the ✓ (Set) button.



- 7 Press  button until `Start` appears, and then press the  **(Set)** button.
 - 8 Ensure that the message `Please wait Wireless Setting` is displayed, and start the WPS-PBC on the wireless LAN access point (Registrar), within two minutes of the step 7 operation.
-  **NOTE:** For WPS operation on the wireless LAN access point, refer to the manual supplied with the wireless LAN access point.
- 9 When the WPS operation is successful and the printer is rebooted, wireless LAN connection setting is completed.

Operator Panel

- 1 Press the  **(Menu)** button.
- 2 Press  button until `Admin Menu` appears, and then press the  **(Set)** button.
- 3 Press  button until `Network` appears, and then press the  **(Set)** button.
- 4 Press  button until `Wireless Setup` appears, and then press the  **(Set)** button.
- 5 Ensure that `Manual Setup` is displayed, and then press the  **(Set)** button.
- 6 Enter the SSID, and then press the  **(Set)** button.
- 7 Select the network mode from `Infrastructure` and `Ad-hoc` depending on your environment.
When you select `Infrastructure`, proceed to step 8.
When you select `Ad-hoc`, proceed to step 9.
- 8 Select the encryption type from `No Security`, `WEP (64Bit)`, and `WEP (128Bit)`.
When you do not set security for your wireless network:
 - a Ensure that `No Security` is displayed, and then press the  **(Set)** button.
 To use 64 bit or 128 bit WEP encryption:
 - a Press  button until `WEP (64Bit)` or `WEP (128Bit)` appears, and then press the  **(Set)** button.
 - b Enter the WEP key, and then press the  **(Set)** button.

- c Select the transmit key from WEP Key 1 to WEP Key 4.

To use WPA-PSK-TKIP or WPA-PSK-AES encryption:



- a Press  button until WPA-PSK-TKIP or WPA-PSK-AES appears, and then press the  (Set) button.
- b Enter the passphrase, and then press the  (Set) button.

- 9 Select the encryption type from No Security, WEP (64Bit), and WEP (128Bit).

When you do not set security for your wireless network:

- a Ensure that No Security is displayed, and then press the  (Set) button.

To use 64 bit or 128 bit WEP encryption:

- a Press  button until WEP (64Bit) or WEP (128Bit) appears, and then press the  (Set) button.
- b Enter the WEP key, and then press the  (Set) button.
- c Select the transmit key from WEP Key 1 to WEP Key 4.

- 10 When the operation is successful and the printer is rebooted, wireless LAN connection setting is completed.

Dell Printer Configuration Web Tool

- 1 Launch the **Dell Printer Configuration Web Tool** by entering the IP address of the printer in your web browser.
- 2 Click **Print Server Settings**.
- 3 Click **Print Server Settings** tab.
- 4 Click **Wireless LAN**, and then enter the SSID.
- 5 Select the network type from **Infrastructure** and **Ad-Hoc**.
- 6 Select the encryption type from **No Security**, **WEP**, **WPA-PSK-AES**, and **WPA-PSK-TKIP**, and then set each item for the encryption type selected.



NOTE: For details on each item, see "Dell Printer Configuration Web Tool."

- 7 Click the **Apply New Settings** button to apply the settings.
- 8 When the operation is successful and the printer is rebooted, wireless LAN connection setting is completed.

Constructing a New Wireless Network Environment for Your Computer

When you setup your wireless connection first time, the following settings are required on your computer.

For DHCP network:

- 1 Setting up your computer for wireless connectivity:



NOTE: If your computer provides a wireless adapter tool, change the wireless settings using this tool. Or you can change the wireless settings using the tool provided with the operating system. See the instructions below.

For Windows XP and Windows Server 2003:

- a Select **Network Connections** from Control Panel.
- b Right-click **Wireless Network Connection** and select **Properties**.
- c Select the **Wireless Networks** tab.
- d Ensure the check box for **Use Windows to configure my wireless network settings** is checked.



NOTE: Be sure to write down the current wireless computer settings in step e and step g so that you can restore them later.

- e Click the **Advanced** button.
- f Select **Computer to Computer** (ad hoc) networks only and close the **Advanced** dialog box.
- g Click the **Add** button to display **Wireless network properties**.
- h Under the **Association** tab, enter the following information and click **OK**.

Network name (SSID): dell_device

Network Authentication: Open

Data encryption: Disabled

Ad hoc network: checked

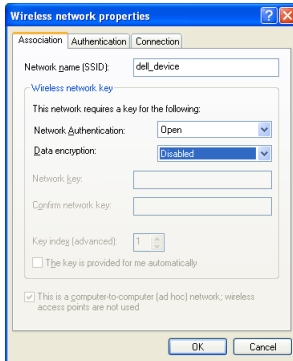

- i Click the **Move up** button to move the newly added SSID to the top of the list.
- j Click **OK** to close the **Property** dialog box.

For Windows Vista:









- a Open **Control Panel**.
- b Select **Network and Internet**.
- c Select **Network and Sharing Center**.
- d Select **Connect to a network**.
- e Select **dell_device** from the network items listed in **Connect to a network**.
- f Select **Connect Anyway** in the warning dialog box indicating you are entering an unsecured area.
- g Click **Close** in the dialog box after confirming the connection is a success.

For Windows Server 2008:

- a Open **Control Panel**.
- b Select **Network and Sharing Center**.
- c Select **Connect to a network**.
- d Select **dell_device** from the network items listed in **Connect to a network**.

- e Select **Connect Anyway** in the warning dialog box indicating you are entering an unsecured area.
- f Click **Close** in the dialog box after confirming the connection is a success.

For Windows Server 2008 R2 and Windows 7:

- a Open **Control Panel**.
 - b Select **Network and Internet**.
 - c Select **Network and Sharing Center**.
 - d Select **Connect to a network**.
 - e Select **dell_device** from the network items listed in the available network list, and click **Connect**.
- 2 Check the IP address assigned by AutoIP on the printer.
- a Press the  (**Menu**) button.
 - b Press  button until **Admin Menu** appears, and then press the  (**Set**) button.
 - c Press  button until **Network** appears, and then press the  (**Set**) button.
 - d Press  button until **TCP/IP** appears, and then press the  (**Set**) button.
 - e Press  button until **IPv4** appears, and then press the  (**Set**) button.
Check the IP address displayed on the operator panel.
- 3 Check that the IP address on your computer is assigned by DHCP.

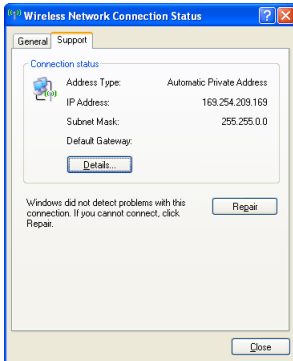

4 Open **Dell Printer Configuration Web Tool** using the WEB browser.

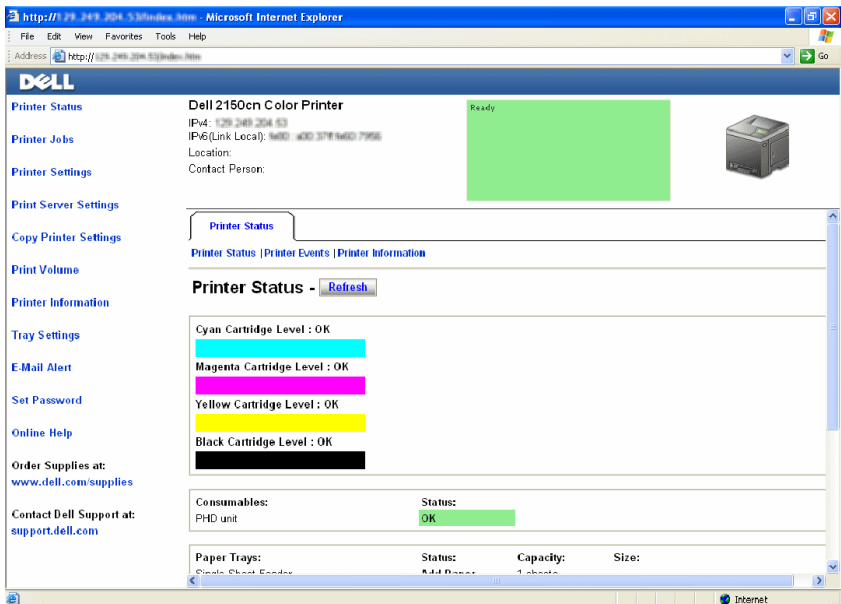

- 5 Create wireless setting of the printer on **Dell Printer Configuration Web Tool**.
- 6 Reboot the printer.
- 7 Restore the wireless settings on your computer.



NOTE: If your computer provides a wireless adapter tool, change the wireless settings using this tool. Or you can change the wireless settings using the tool provided with the operating system. See the instructions below.

For Windows XP and Windows Server 2003:

- a Select **Network Connections** from **Control Panel**.
- b Right-click **Wireless Network Connection** and select **Properties**.
- c Select **Wireless Network** tab.
- d Ensure the check box for **Use Windows to configure my wireless network settings** is checked.
- e Click **Advanced**.
- f Do either of the following:

When wireless ad-hoc mode is set to the printer:

Select **Computer to Computer** (ad hoc) networks only and close the **Advanced** dialog box.

When wireless infrastructure mode is set to the printer:

Select **Access point (Infrastructure) networks only** and close the **Advanced** dialog box.

- g Click **Add** to display **Wireless network properties**.
- h Enter the setting that you will send to the printer and click **OK**.
- i Click **Move up** to move the setting to the top of the list.
- j Click **OK** to close the **Property** dialog box.

For Windows Vista:

- a Open **Control Panel**.
- b Select **Network and Internet**.
- c Select **Network and Sharing Center**.
- d Select **Connect to a network**.
- e Select the setting you send to the printer from the network items listed in **Connect to a network**.
- f Select **Connect Anyway** in the warning dialog box indicating you are entering an unsecured area.

- g Click **Close** in the dialog box after confirming the connection is a success.

For Windows Server 2008:

- a Open **Control Panel**.
- b Select **Network and Sharing Center**.
- c Select **Connect to a network**.
- d Select the setting you send to the printer from the network items listed in **Connect to a network**.
- e Select **Connect Anyway** in the warning dialog box indicating you are entering an unsecured area.
- f Click **Close** in the dialog box after confirming the connection is a success.

For Windows Server 2008 R2 and Windows 7:

- a Open **Control Panel**.
- b Select **Network and Internet**.
- c Select **Network and Sharing Center**.
- d Select **Connect to a network**.
- e Select the setting you send to the printer from the network items listed in the available network list, and click **Connect**.
- f Enter the **Security key** and click **OK**, if necessary.

For Fixed IP networks:

- 1 Setting up your computer for wireless connectivity:



NOTE: If your computer provides a wireless adapter tool, change the wireless settings using this tool. Or you can change the wireless settings using the tool provided with the operating system. See the instructions below.

For Windows XP and Windows Server 2003:

- a Select **Network Connections** from Control Panel.
- b Right-click **Wireless Network Connection** and select **Properties**.
- c Select the **Wireless Networks** tab.

- d Ensure the check box for **Use Windows to configure my wireless network settings** is checked.

 **NOTE:** Be sure to write down the current wireless computer settings in step d and step f so that you can restore them later.

- e Click the **Advanced** button.
- f Select **Computer to Computer (ad hoc) networks only** and close the **Advanced** dialog box.
- g Click the **Add** button to display **Wireless network properties**.
- h Under the **Association** tab, enter the following information and click **OK**.

Network name (SSID): dell_device

Network Authentication: Open

Data encryption: Disabled

Ad hoc network: checked

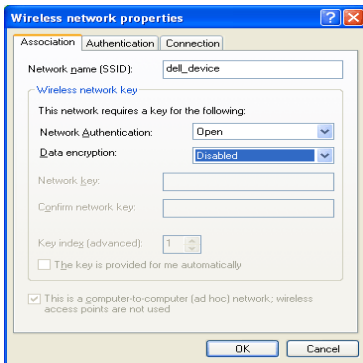

- i Click the **Move up** button to move the newly added SSID to the top of the list.
- j Click **OK** to close the **Property** dialog box.

For Windows Vista:

- a Open Control Panel.
- b Select **Network and Internet**.

- c Select **Network and Sharing Center**.
- d Select **Connect to a network**.
- e Select **dell_device** from the network items listed in **Connect to a network**.
- f Select **Connect Anyway** in the warning dialog box indicating you are entering an unsecured area.
- g Click **Close** in the dialog box after confirming the connection is a success.









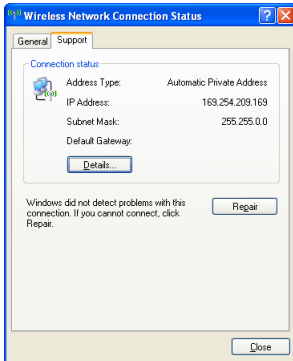









For Windows Server 2008:

- a Open **Control Panel**.
- b Select **Network and Sharing Center**.
- c Select **Connect to a network**.
- d Select **dell_device** from the network items listed in **Connect to a network**.
- e Select **Connect Anyway** in the warning dialog box indicating you are entering an unsecured area.
- f Click **Close** in the dialog box after confirming the connection is a success.

For Windows Server 2008 R2 and Windows 7:

- a Open **Control Panel**.
 - b Select **Network and Internet**.
 - c Select **Network and Sharing Center**.
 - d Select **Connect to a network**.
 - e Select **dell_device** from the network items listed in the available network list, and click **Connect**.
- 2 Check the IP address on your computer.



- 3 Set the IP address on the printer.
 - a Press the  (**Menu**) button.
 - b Press  button until **Admin** menu appears, and then press the  (**Set**) button.
 - c Press  button until **Network** appears, and then press the  (**Set**) button.
 - d Press  button until **TCP/IP** appears, and then press the  (**Set**) button.
 - e Press  button until **IPv4** appears, and then press the  (**Set**) button.
 - f Ensure that **Get IP Address** is displayed, and then press the  (**Set**) button.
 - g Press  button until **Panel** appears, and then press the  (**Set**) button.
 - h Press  button until **IP Address** appears, and then press the  (**Set**) button.
 - i Manually enter the IP address using , , and  buttons on the operator panel, and then press the  (**Set**) button.
- 4 Open **Dell Printer Configuration Web Tool** using the WEB browser.

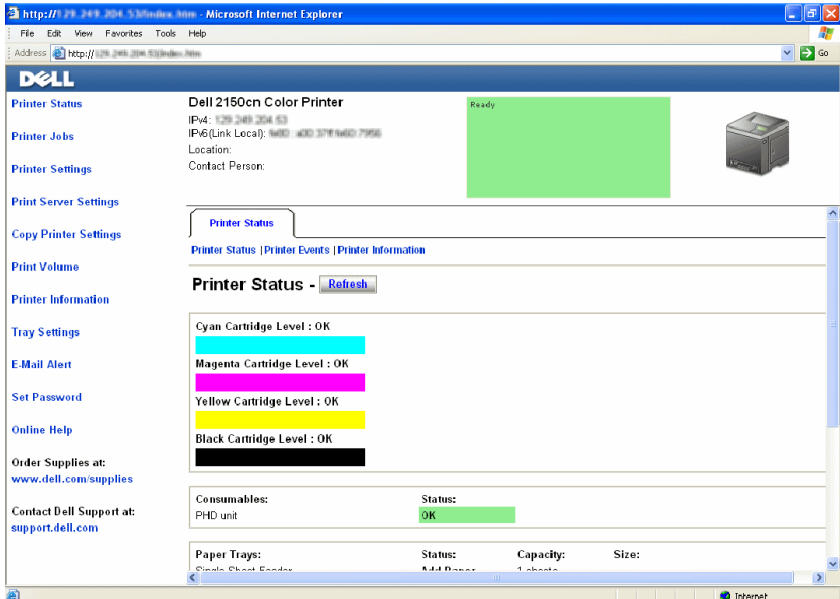

- 5 Change the wireless setting of the printer on **Dell Printer Configuration Web Tool**.
- 6 Reboot the printer.
- 7 Restore the wireless settings on your computer.



NOTE: If your computer provides a wireless adapter tool, change the wireless settings using this tool. Or you can change the wireless settings using the tool provided with the operating system. See the instructions below.

- a For Windows XP and Windows Server 2003:
 - b Select **Network Connections** from Control Panel.
 - c Right-click **Wireless Network Connection** and select **Properties**.
 - d Select **Wireless Network** tab.
 - e Ensure the check box for Use **Windows to configure my wireless network settings** is checked.
 - f Click **Advanced**.
 - g Do either of the following:

When wireless ad-hoc mode is set to the printer:

Select Computer to Computer (ad hoc) networks only and close the Advanced dialog box.

When wireless infrastructure mode is set to the printer:

Select Access point (Infrastructure) networks only and close the Advanced dialog box.

- h Click **Add** to display **Wireless network properties**.
- i Enter the setting that you will send to the printer and click **OK**.
- j Click **Move up** to move the setting to the top of the list.
- k Click **OK** to close the **Property** dialog box.

For Windows Vista:

- a Open **Control Panel**.
- b Select **Network and Internet**.
- c Select **Network and Sharing Center**.
- d Select **Connect to a network**.
- e Select the setting you send to the printer from the network items listed in **Connect to a network**.
- f Select **Connect Anyway** in the warning dialog box indicating you are entering an unsecured area.
- g Click **Close** in the dialog box after confirming the connection is a success.

For Windows Server 2008:

- a Open **Control Panel**.
- b Select **Network and Sharing Center**.
- c Select **Connect to a network**.
- d Select the setting you send to the printer from the network items listed in **Connect to a network**.
- e Select **Connect Anyway** in the warning dialog box indicating you are entering an unsecured area.

- f Click **Close** in the dialog box after confirming the connection is a success.

For Windows Server 2008 R2 and Windows 7:

- a Open **Control Panel**.
- b Select **Network and Internet**.
- c Select **Network and Sharing Center**.
- d Select **Connect to a network**.
- e Select the setting you send to the printer from the network items listed in the available network list, and click **Connect**.
- f Enter the **Security key** and click **OK**, if necessary.

Connecting Your Printer

Your Dell™ 2150cn/2150cdn Color Printer interconnection cable must meet the following requirements:



NOTE: The images used and procedures described in this manual are those of Dell 2150cn Color Printer.

Connection type	Connection specifications
USB	USB 2.0
Ethernet	10 Base-T/100 Base-TX/1000 Base-T
Wireless (optional)	IEEE 802.11b/802.11g/802.11n

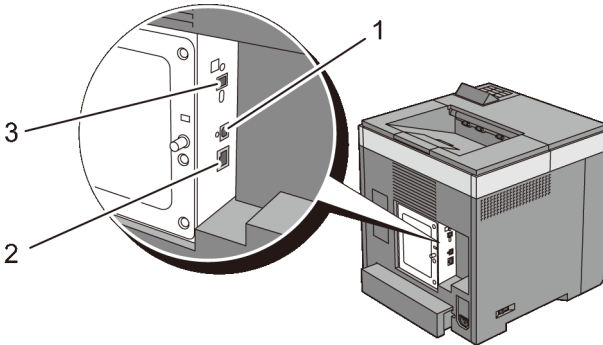

1 USB port



2 Ethernet port



3 Wireless adapter socket



Connecting Printer to Computer or Network

Direct Connection

A local printer is a printer which is directly connected to your computer using the USB cable. If your printer is connected to a network instead of your computer, skip this section and go to "Network Connection."

The following operating systems support USB connection:

- Microsoft® Windows® XP
- Windows XP 64-bit Edition
- Windows Server® 2003
- Windows Server 2003 x64 Edition
- Windows Server 2008
- Windows Server 2008 64-bit Edition
- Windows Server 2008 R2 64-bit Edition
- Windows Vista®
- Windows Vista 64-bit Edition
- Windows 7
- Windows 7 64-bit Edition
- Mac OS X 10.3.9/10.4.11/10.5/10.6
- Red Hat® Enterprise Linux® 4 WS/5 Client (x86)
- SUSE® Linux Enterprise Desktop 10/11 (x86)

To connect the printer to a computer:

- 1 Connect the smaller USB connector into the USB port at the back of the printer.

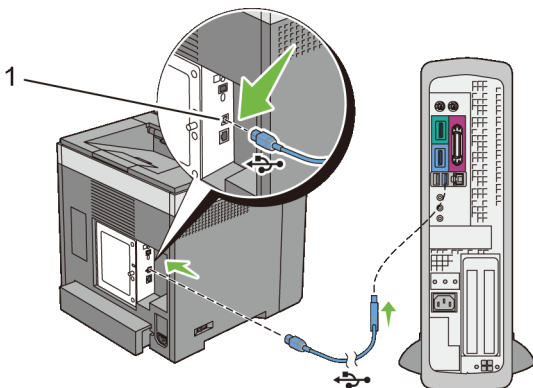

1 USB port



NOTE: Ensure that you match the USB symbol on the cable to the USB symbol on the printer.

2 Connect the other end of the cable into a USB port of the computer.



NOTICE: Do not connect the printer USB cable to the USB port available on the keyboard.

Network Connection

To connect the printer to a network:

1 Connect the network cable.

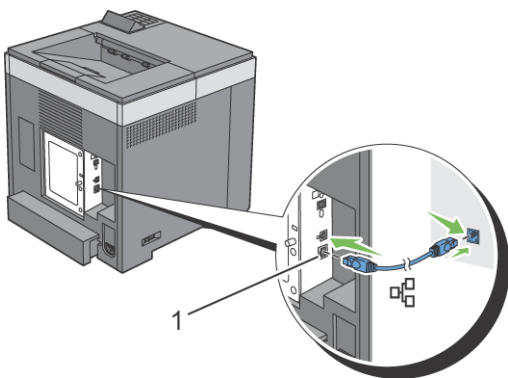

1 Ethernet port

To connect the printer to the network, connect one end of an Ethernet cable into the Ethernet port on the rear of the printer, and the other end to a LAN drop or hub. To setup a wireless connection, insert the wireless adapter into the wireless adapter socket on the back of the printer.

For a wireless connection, see "Installing the Optional Wireless Adapter."

 **NOTE:** To use the wireless adapter, be sure to disconnect the network cable.

Turning on the Printer

 **CAUTION:** Do not use extension cords or power strips.

 **CAUTION:** The printer should not be plugged into a UPS (Uninterruptible Power Supply) system.

- 1 Connect the power cable to the power connector on the rear of the printer, and then to a power source.

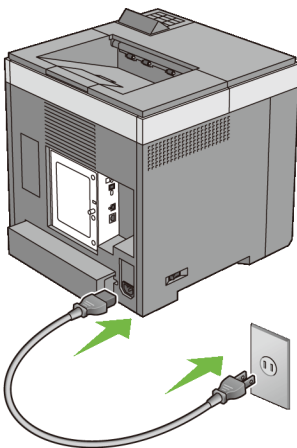

- 2 Turn on the printer. When the printer is connected via a USB cable, the USB driver is automatically installed.

Setting the IP Address



NOTE: The images used and procedures described in this manual are those of Dell™ 2150cn Color Printer.

Assigning an IP Address

An IP address is a unique number that consists of four sections that are delimited by a period and can include up to three digits in each section, for example, 111.222.33.44.

You can select the IP mode from Dual Stack, IPv4, and IPv6. If your network supports both IPv4 and IPv6, select Dual Stack.

Select the IP mode of your environment, and then set IP address, subnet mask (for IPv4 only), and gateway address.



NOTICE: Assigning an IP address that is already in use can cause network performance issues.



NOTE: Assigning an IP address is considered as an advanced function and is normally done by a system administrator.

When Using the Easy Setup Navigator



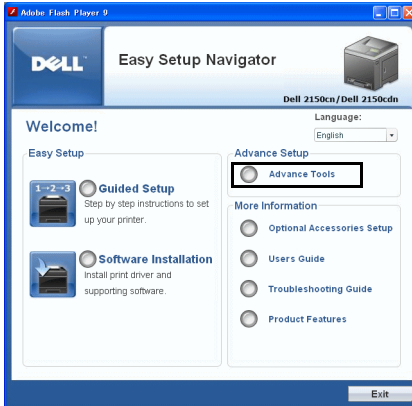











- 1 Insert the *Drivers and Utilities* CD provided with the printer in your computer. The **Easy Setup Navigator** file launches automatically.
- 2 Click **Advanced Tools** on the **Easy Setup Navigator** window. The **Advanced Tools** window opens.





- 3 Click **IP Configuration**.
- 4 Follow the instructions displayed on the screen.

When Using the Operator Panel



For more information on using the operator panel, see "Operator Panel."









- 1 Turn on the printer.
- 2 Press the  (**Menu**) button.
- 3 Press  button until **Admin Menu** appears, and then press the  (**Set**) button.
- 4 Press  button until **Network** appears, and then press the  (**Set**) button.
- 5 Press  button until **TCP/IP** appears, and then press the  (**Set**) button.
- 6 Press  button until **IPv4** appears, and then press the  (**Set**) button.
- 7 Ensure that **Get IP Address** is displayed, and then press the  (**Set**) button.
- 8 Press  button until **Panel** appears, and then press the  (**Set**) button.
- 9 Press  and  buttons until **IP Address** appears, and then press the  (**Set**) button.

The cursor is located at the first octet of the IP address.

- 10 Use  and  buttons to enter the first octet of the IP address, and then press  button.

The cursor moves to the next digit.

 **NOTE:** You can only enter one octet at a time and must press  button after entering each octet.

- 11 Enter the rest of the octets, and then press the  (**Set**) button.
- 12 Press  and  buttons until `Subnet Mask` appears, and then press the  (**Set**) button.
- 13 Repeat steps 10 and 11 to set Subnet Mask, and then press the  (**Set**) button.
- 14 Press  and  buttons until `Gateway Address` appears, and then press the  (**Set**) button.
- 15 Repeat steps 10 and 11 to set the Gateway Address, and then press the  (**Set**) button.
- 16 Turn off the printer, and then turn it on again.

When Using the Tool Box

 **NOTE:**

- 1 Click **Start**→ **All Programs**→ **Dell Printers**→ **Dell 2150 Color Printer**→ **Tool Box**.

 **NOTE:** The **Select Printer** window appears in this step when multiple printer drivers are installed on your computer. In this case, click the name of this printer listed in **Printer Names**, and then click **OK**.

The **Tool Box** opens.

- 2 Click the **Printer Maintenance** tab.
- 3 Select **TCP/IP Settings** from the list at the left side of the page.

The **TCP/IP Settings** page appears.

- 4 Select the mode from **IP Address Mode**, and then enter the values in IP Address, Subnet Mask, and Gateway Address.
- 5 Press the **Apply New Settings** button to take effect.

You can also assign the IP address to the printer when installing the printer drivers with the installer. When you use the **Network Installation** feature, and the **Get IP Address** is set to **AutoIP** or **DHCP** on the operator panel menu, you can set the IP address from 0.0.0.0 to the desired IP address on the printer selection window.



Verifying the IP Settings

You can confirm the settings by printing the printer settings report or using the ping command.

Verifying the Settings Using Printer Settings Report

- 1 Print the printer settings report.

When Using the Operator Panel

- a Press the  (**Menu**) button.
- b Ensure that **Report/List** is displayed, and then press the  (**Set**) button.
- c Ensure that **Printer Settings** is displayed, and then press the  (**Set**) button.

The printer settings report is printed.

When Using the Tool Box

 **NOTE:**

- a Click **Start**→ **All Programs**→ **Dell Printers**→ **Dell 2150 Color Printer**→ **Tool Box**.

 **NOTE:** The **Select Printer** window appears in this step when multiple printer drivers are installed on your computer. In this case, click the name of this printer listed in **Printer Names**, and then click **OK**.

The **Tool Box** opens.

- b Ensure that the **Printer Settings Report** tab is open.
- c Select **Reports** from the list at the left side of the page.

The **Reports** page appears.

- d Click the **Printer Settings** button.

The printer settings report is printed

- 2 Verify the correct IP address, subnet mask, and gateway address are listed in the printer settings report under **Network (Wired)**.

Verifying the Settings Using Ping Command

Ping the printer and verify that it responds. For example, at a command prompt on a network computer, type ping followed by the new IP address (for example, 192.168.0.11):

```
ping 192.168.0.11
```

If the printer is active on the network, you will receive a reply.

Loading Paper

 NOTE: To avoid paper jams, do not remove the tray while printing is in progress.

 NOTE: Use only laser print media. Do not use ink jet paper in your printer.

- 1 Pull the tray out of the printer about 200 mm. Hold the tray with both hands, and remove it from the printer.

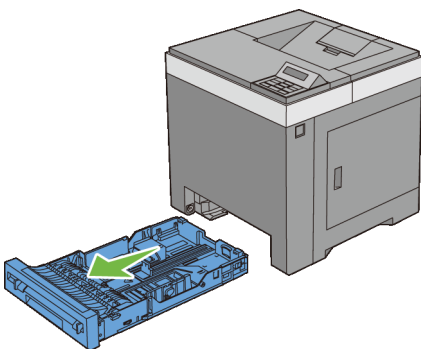

- 2 Adjust the paper guides.

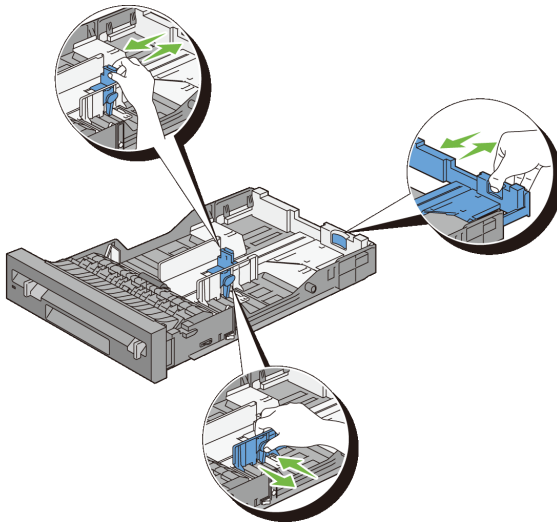

 **NOTE:** Extend the rear side of the tray when you load Legal size paper.

- 3 Before loading the print media, flex the sheets and fan them. Straighten the edges of the stack on a level surface.

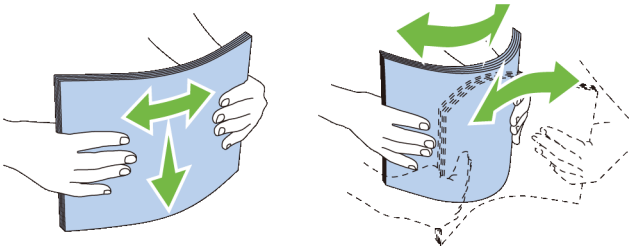

- 4 Load the print media into the tray with the recommended print side facing up.

 **NOTE:** Do not exceed the maximum fill line in the tray. Overfilling the tray may cause paper jams.

- 5 Align the width guides against the edges of the paper.

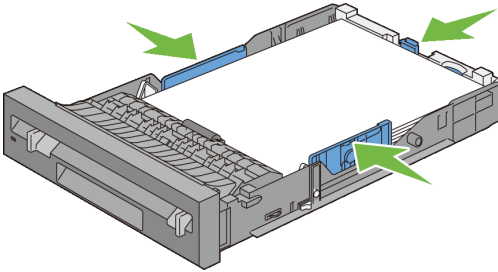

 **NOTE:** When loading user-specified print media, adjust the width guides and slide the extendable part of the tray by pinching the length guide and sliding it until it rests lightly against the edge of the paper.

- 6 After confirming that the guides are securely adjusted, insert the tray into the printer.

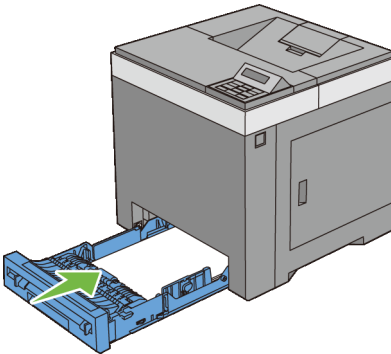

 **NOTE:** Select the paper type from the operator panel if the loaded print media is not standard plain paper.

Installing Printer Drivers on the Windows Computers

Identifying Printer Driver Pre-install Status



Before installing the printer driver on your computer, check the IP address of your printer by performing one of the following procedures.



NOTE: The images used and procedures described in this manual are those of Dell™ 2150cn Color Printer.

- When Using the Operator Panel
- When Using the Tool Box

When Using the Operator Panel

- 1 Press the  (**Menu**) button.
- 2 Ensure that **Report/List** is displayed, and then press the  (**Set**) button.
- 3 Ensure that **Printer Setting** is displayed, and then press the  (**Set**) button.

The printer settings report is printed.

- 4 Look under the **TCP/IP** heading on the printer setting report.

If the IP address shows 0 . 0 . 0 . 0 (the factory default), an IP address has not been assigned. To assign one for your printer, see "Assigning an IP Address."

When Using the Tool Box



NOTE:

- 1 Click **Start** → **All Programs** → **Dell Printers** → **Dell 2150 Color Printer** → **Tool Box**.



NOTE: The **Select Printer** window appears in this step when multiple printer drivers are installed on your computer. In this case, click the name of this printer listed in **Printer Name**, and then click **OK**.

The **Tool Box** opens.

- 2 Ensure that the **Printer Settings Report** tab is open.
- 3 Select **TCP/IP Settings** from the list at the left side of the page.

The **TCP/IP Settings** page appears.

If the IP address shows 0 . 0 . 0 . 0 (the factory default), an IP address has not been assigned. To assign one for your printer, see "Assigning an IP Address."

Disabling Firewall Before Installing Printer Software



NOTE: This step is necessary if you have Windows XP Service Pack 2 or 3 installed.

If your printer is connected directly to a network, and the Windows XP, Windows Vista, Windows Server 2008, Windows Server 2008 R2, or Windows 7 firewall is enabled, you cannot view your networked printer(s) when you run the Dell printer installation software. To prevent this situation, disable this firewall before you install the Dell printer software. To disable or enable your Windows XP, Windows Vista, Windows Server 2008, Windows Server 2008 R2, or Windows 7 firewall, perform the following steps.

- 1 Click **Start** and click **Help and Support**.



NOTE: For Windows Server 2008 R2 and Windows 7, if you use **Online Help**, switch to **Offline Help** on **Windows Help and Support** window.

- 2 In the **Search** box, type `firewall`, and then press the **Enter** key.

In the list, click **Turn Windows Firewall on or off**, and then follow the instructions on the screen.

Inserting the Drivers and Utility CD

- 1 Insert the *Drivers and Utilities* CD into your computer and click `setup_assist.exe` to start **Easy Setup Navigator**.



NOTE: If the CD does not launch automatically launch, follow the procedure below.

For Windows XP, Windows Server 2008, and Windows Server 2008 R2

Click **start**→**Run**, enter `D:\setup_assist.exe` (where D is the CD drive letter) in the Run dialog box, and then click **OK**.

For Windows Vista and Windows 7

Click **Start** → **All Programs** → **Accessories** → **Run**, enter
D:\setup_assist.exe (where D is the CD drive letter) in the Run dialog
box, and then click **OK**.

Direct Connection Setup

For installing PCL printer driver

- 1 In the **Easy Setup Navigator** window, click **Software Installation** to launch the installation software.
- 2 Select **Personal Installation**, and then click **Next**.
- 3 Select the model name of your printer, and then click **Next**.
- 4 Follow the on-screen instructions to connect the computer and the printer with a USB cable, and then turn the printer on.

The Plug and Play installation starts and the installation software proceeds to the next page automatically.



NOTE: If the installation software does not automatically proceed to the next page, click **Install**.

- 5 Select either **Typical Installation** or **Custom Installation** from the installation wizard, and then click **Install**. If you select **Custom Installation**, you can select the specific software you want to install.
- 6 Click **Finish** to exit the wizard when the **Congratulations!** screen appears.
To print a test page, click **Print Test Page**.

USB Printing

A personal printer is a printer connected to your computer or a print server using a USB. If your printer is connected to a network and not your computer, see "Network Connection Setup."

For installing XML Paper Specification (XPS) printer driver



NOTE: XPS driver is supported on the following operating systems: Windows Vista, Windows Vista 64-bit Edition, Windows Server 2008, Windows Server 2008 64-bit Edition, Windows Server 2008 R2, Windows 7, and Windows 7 64-bit Edition.

Windows Vista or Windows Vista 64-bit Edition

- 1 Extract the following zip file to your desired location.
D:\Drivers\XPS\Win_7Vista\XPS_2150.zip (where D is the CD drive letter)
- 2 Click **Start**→ **Control Panel**→ **Hardware and Sound**→ **Printers**.
- 3 Click **Add a printer**.
- 4 Click **Add a local printer**.
- 5 Select the port connected to this product, and then click **Next**.
- 6 Click **Have Disk** to display the **Install From Disk** dialog box.
- 7 Click **Browse**, and then select the extracted folder in step 1.
- 8 Click **OK**.
- 9 Select your printer name and click **Next**.
- 10 To change the printer name, enter the printer name in the **Printer name** box, and then click **Next**. To use this printer as the default printer, select the check box displayed under the **Printer name**, and then click **Next**.

Installation starts.

If the **User Account Control** dialog box appears, click **Continue**.



NOTE: If you are an administrator on the computer, click **Continue**; otherwise, contact your administrator to continue the desired action.

- 11 As the driver installation is completed, click **Print a test page** to print a test page.
- 12 Click **Finish**.

Windows Server 2008 or Windows Server 2008 64-bit Edition



NOTE: You must log in as an administrator.

- 1 Extract the following zip file to your desired location.
D:\Drivers\XPS\Win_7Vista\XPS_2150.zip (where D is the CD drive letter)
- 2 Click **Start**→ **Control Panel**→ **Hardware and Sound**→ **Printers**.
- 3 Click **Add a printer**.
- 4 Click **Add a local printer**.
- 5 Select the port connected to this product, and then click **Next**.



- 6 Click **Have Disk** to display the **Install From Disk** dialog box.
- 7 Click **Browse**, and then select the extracted folder in step 1.
- 8 Click **OK**.
- 9 Select your printer name and click **Next**.
- 10 To change the printer name, enter the printer name in the **Printer name** box, and then click **Next**.
To use this printer as the default printer, select the **Set as the default printer** check box, and then click **Next**.
- 11 If you do not share your printer, select **Do not share this printer**. If you share your printer, select **Share this printer so that others on your network can find and use it**.
- 12 Click **Next**.
Installation starts.
- 13 As the driver installation is completed, click **Print a test page** to print a test page.
- 14 Click **Finish**.

Windows 7, Windows 7 64-bit Edition, or Windows Server 2008 R2

- 1 Extract the following zip file to your desired location.
D:\Drivers\XPS\Win_7Vista\XPS_2150.zip (where D is the CD drive letter)
- 2 Click **Start**→ **Devices and Printers**.
- 3 Click **Add a printer**.
When you use Windows Server 2008 R2, click **Add a local or network printer as an administrator**.
If the **User Account Control** dialog box appears, click **Yes**.
-  **NOTE:** If you are an administrator on the computer, click **Yes**; otherwise, contact your administrator to continue the desired action.
- 4 Click **Add a local printer**.
- 5 Select the port connected to this product, and then click **Next**.
- 6 Click **Have Disk** to display the **Install From Disk** dialog box.
- 7 Click **Browse**, and then select the extracted folder in step 1.

- 8 Click **OK**.
- 9 Select your printer name and click **Next**.
- 10 To change the printer name, enter the printer name in the **Printer name** box, and then click **Next**.
To use this printer as the default printer, select the **Set as the default printer** check box, and then click **Next**.
- 11 If you do not share your printer, select **Do not share this printer**. If you share your printer, select **Share this printer so that others on your network can find and use it**.
- 12 Click **Next**.
Installation starts.
- 13 As the driver installation is completed, click **Print a test page** to print a test page.
- 14 Click **Finish**.

Network Connection Setup

-  NOTE: To use this printer in a Linux environment, you need to install a Linux driver. For more information on how to install and use these, see "Installing Printer Drivers on the Linux Computers (CUPS)."
-  NOTE: When using a CD drive in a Linux environment, you need to mount the CD according to your system environment. The command strings are `mount/media/CD-ROM`.

Network Printer Setup on a Local Network

For installing PCL printer driver

- 1 In the **Easy Setup Navigator** window, click **Software Installation** to launch the installation software.
- 2 Select **Network Installation**, and then click **Next**.
- 3 Select the model name of your printer, and then click **Next**.
- 4 Select **Local Installation**, and then click **Next**.

- 5 Select the printer you want to install from the printer list, and then click **Next**. If the target printer is not displayed on the list, click **Refresh** to refresh the list or click **Add Printer** to add a printer to the list manually. You may specify the IP address and port name at this point.

If you have installed this printer on the server computer, select the **I am setting up this printer on a server** check box.

 **NOTE:** When using AutoIP, **0.0.0.0** is displayed in the installer. Before you can continue, you must enter a valid IP address.

 **NOTE:** In some cases, **Windows Security Alert** is displayed in this step when you use Windows Vista, Windows Vista 64-bit Edition, Windows Server 2008, Windows Server 2008 64-bit Edition, Windows Server 2008 R2, Windows 7, or Windows 7 64-bit Edition. In this case, select **Unblock** (Allow access for Windows Server 2008 R2 and Windows 7), and then continue the procedure.

- 6 Specify the printer settings, and then click **Next**.
 - a Enter the printer name.
 - b If you want other users on the network to access the printer, select **Share this printer with other computers on the network**, and then enter a share name that users can identify.
 - c If you want to set the printer as the default printer, select the **Set this printer as default** check box.
 - d If you want to restrict color printing, select the appropriate **Dell ColorTrack** option. Enter the password when **Color-Password Enabled** is selected for **Dell ColorTrack**.
- 7 Select the software and documentation you want to install, and then click **Install**. If you want to change the installation destination, click **Browse** and specify a new location.
- 8 Click **Finish** to exit the wizard when the **Congratulations!** screen appears.
To print a test page, click **Print Test Page**.

For installing XML Paper Specification (XPS) printer driver

 **NOTE:** XPS driver is supported on the following operating systems: Windows Vista, Windows Vista 64-bit Edition, Windows Server 2008, Windows Server 2008 64-bit Edition, Windows Server 2008 R2, Windows 7, and Windows 7 64-bit Edition.

Windows Vista or Windows Vista 64-bit Edition

- 1 Extract the following zip file to your desired location.
D:\Drivers\XPS\Win_7Vista\XPS_2150.zip (where D is the CD drive letter)
- 2 Click **Start**→ **Control Panel**→ **Hardware and Sound**→ **Printers**.
- 3 Click **Add a printer**.
- 4 Click **Add a network, wireless or Bluetooth printer**.
- 5 Select printer or click **The printer that I want isn't listed**.
- 6 Select **Add a printer using a TCP/IP address or host name**, and then click **Next**.
- 7 Select **TCP/IP Device** from **Device type**, and enter the IP address for **Hostname or IP address**, and then click **Next**.

If the **User Account Control** dialog box appears, click **Continue**.



NOTE: If you are an administrator on the computer, click **Continue**; otherwise, contact your administrator to continue the desired action.

- 8 Click **Have Disk** to display the **Install From Disk** dialog box.
- 9 Click **Browse**, and then select the extracted folder in step 1.
- 10 Click **OK**.
- 11 Select your printer name and click **Next**.
- 12 To change the printer name, enter the printer name in the **Printer name** box, and then click **Next**.

To use this printer as the default printer, select the **Set as the default printer** check box, and then click **Next**.

Installation starts.

- 13 As the driver installation is completed, click **Print a test page** to print a test page.
- 14 Click **Finish**.

Windows Server 2008 or Windows Server 2008 64-bit Edition



NOTE: You must log in as an administrator.

- 1 Extract the following zip file to your desired location.

D:\Drivers\XPS\Win_7Vista\XPS_2150.zip (where D is the CD drive letter)

2 Click **Start**→ **Control Panel**→ **Hardware and Sound**→ **Printers**.

3 Click **Add a printer**.

4 Click **Add a network, wireless or Bluetooth printer**.

5 Select printer or click **The printer that I want isn't listed**.

When you select your printer, go to step 8.

When you click **The printer that I want isn't listed**, go to step 6.

6 Select **Add a printer using a TCP/IP address or host name**, and then click **Next**.

7 Select **TCP/IP Device** from **Device type**, and enter the IP address for **Hostname or IP address**, and then click **Next**.

If the **User Account Control** dialog box appears, click **Continue**.

 **NOTE:** If you are an administrator on the computer, click **Continue**; otherwise, contact your administrator to continue the desired action.

8 Click **Have Disk** to display the **Install From Disk** dialog box.

9 Click **Browse**, and then select the extracted folder in step 1.

10 Click **OK**.

11 Select your printer name and click **Next**.

12 To change the printer name, enter the printer name in the **Printer name** box, and then click **Next**.

To use this printer as the default printer, select the **Set as the default printer** check box, and then click **Next**.

13 If you do not share your printer, select **Do not share this printer**. If you share your printer, select **Share this printer so that others on your network can find and use it**.

14 Click **Next**.

Installation starts.

15 As the driver installation is completed, click **Print a test page** to print a test page.

16 Click **Finish**.

Windows Server 2008 R2

- 1 Extract the following zip file to your desired location.
D:\Drivers\XPS\Win_7Vista\XPS_2150.zip (where D is the CD drive letter)

- 2 Click **Start** → **Devices and Printers**.
- 3 Click **Add a printer**.
- 4 Click **Add a network, wireless or Bluetooth printer**.
- 5 Select printer or click **The printer that I want isn't listed**.



NOTE: When you click **The printer that I want isn't listed**, **Find a printer by name or TCP/IP address** screen appears. Find your printer on the screen.

If the **User Account Control** dialog box appears, click **Continue**.



NOTE: If you are an administrator on the computer, click **Continue**; otherwise, contact your administrator to continue the desired action.

- 6 Click **Have Disk** to display the **Install From Disk** dialog box.
- 7 Click **Browse**, and then select the extracted folder in step 1.
- 8 Click **OK**.
- 9 Select your printer name and click **Next**.
- 10 To change the printer name, enter the printer name in the **Printer name** box, and then click **Next**.
To use this printer as the default printer, select the **Set as the default printer** check box, and then click **Next**.
- 11 If you do not share your printer, select **Do not share this printer**. If you share your printer, select **Share this printer so that others on your network can find and use it**.
- 12 Click **Next**.
Installation starts.
- 13 As the driver installation is completed, click **Print a test page** to print a test page.
- 14 Click **Finish**.

Windows 7 or Windows 7 64-bit Edition

- 1 Extract the following zip file to your desired location.

D:\Drivers\XPS\Win_7Vista\XPS_2150.zip (where D is the CD drive letter)

2 Click **Start**→ **Devices and Printers**.

3 Click **Add a printer**.

4 Click **Add a network, wireless or Bluetooth printer**.

5 Select printer or click **The printer that I want isn't listed**.

When you select your printer, go to step 8.

When you click **The printer that I want isn't listed**, go to step 6.

6 Select **Add a printer using a TCP/IP address or host name**, and then click **Next**.

7 Select **TCP/IP Device** from **Device type**, and enter the IP address for **Hostname or IP address**, and then click **Next**.

If the **User Account Control** dialog box appears, click **Yes**.



NOTE: If you are an administrator on the computer, click **Yes**; otherwise, contact your administrator to continue the desired action.

8 Click **Have Disk** to display the **Install From Disk** dialog box.

9 Click **Browse**, and then select the extracted folder in step 1.

10 Click **OK**.

11 Select your printer name and click **Next**.

12 To change the printer name, enter the printer name in the **Printer name** box, and then click **Next**.

To use this printer as the default printer, select the **Set as the default printer** check box.

13 If you do not share your printer, select **Do not share this printer**. If you share your printer, select **Share this printer so that others on your network can find and use it**.

14 Click **Next**.

Installation starts.

15 As the driver installation is completed, click **Print a test page** to print a test page.

16 Click **Finish**.

Use the **Dell Printer Configuration Web Tool** to monitor the status of your network printer without leaving your desk. You can view and/or change the printer settings, monitor toner level, and acknowledge the timing of ordering replacement consumables. You can click the Dell supplies link for ordering supplies.

 **NOTE:** The **Dell Printer Configuration Web Tool** is not available when the printer is directly connected to a computer or a print server.

To launch the **Dell Printer Configuration Web Tool**, type the printer's IP address in your web browser. The printer configuration appears on the screen.

You can set up the **Dell Printer Configuration Web Tool** to send you an e-mail when the printer needs supplies or intervention.

To set up e-mail alerts:

- 1 Launch the **Dell Printer Configuration Web Tool**.
- 2 Click **E-Mail Alert** link.
- 3 Under **E-Mail Server Settings**, enter the **Primary SMTP Gateway, Reply Address**, and your or key operator's e-mail address in the e-mail list box.
- 4 Click **Apply New Settings**.

 **NOTE:** **Connection pending until printer sends an alert** is displayed on the SMTP server until an error occurs.

Network Printer Setup on a Remote Network

Before Installation

Before you start remote installation, perform the following procedures.

Allow Print Spooler to Accept Client Connections

 **NOTE:** This procedure is required for Windows XP 64-bit Edition, Windows Server 2003, Windows Server 2003 x64 Edition, Windows Vista, Windows Vista 64-bit Edition, Windows Server 2008, Windows Server 2008 64-bit Edition, Windows Server 2008 R2, Windows 7, and Windows 7 64-bit Edition.

For Windows XP, Windows Server 2003, Windows Vista, and Windows Server 2008:

- 1 Open the Run dialog box.

For Windows XP, Windows Server 2003, Windows Server 2008, click **start**→ **All Programs**→ **Accessories**→ **Run**.

For Windows Vista, click **Start**→ **Run**.

- 2 Type `gpedit.msc`, and then click **OK**.
- 3 Click **Computer Configuration**→ **Administrative Templates**→ **Printers**.
- 4 Right-click **Allow Print Spooler to accept client connections** and select **Properties**.
- 5 On the **Setting** tab, select **Enabled**, and then click **OK**.
- 6 Restart the computer.

For Windows Server 2008 R2 and Windows 7:

- 1 Open the Run dialog box.

For Windows Server 2008 R2, click **Start**→ **Run**.

For Windows 7, click **Start**→ **All Programs**→ **Accessories**→ **Run**.

- 2 Type `gpedit.msc`, and then click **OK**.
- 3 Click **Computer Configuration**→ **Administrative Templates**→ **Printers**.
- 4 Right-click **Allow Print Spooler to accept client connections** and select **Edit**.
- 5 Select **Enabled**, and then click **OK**.
- 6 Restart the computer.

Share the Firewall File and Printer



NOTE: This procedure is required for Windows XP, Windows XP 64-bit Edition, Windows Vista, Windows Vista 64-bit Edition, Windows Server 2008, Windows Server 2008 64-bit Edition, Windows Server 2008 R2, Windows 7, and Windows 7 64-bit Edition.

For Windows XP:

- 1 Click **start**→ **Control Panel**.
- 2 Select **Security Center**.
- 3 Click **Windows Firewall**.
- 4 On the **Exceptions** tab, select the **File and Printer Sharing** check box, and then click **OK**.

For Windows Vista:

- 1 Click **Start**→ **Control Panel**.
- 2 Select **Security**.
- 3 Click **Windows Firewall**.
- 4 Click **Change settings**.
- 5 Click **Continue**.
- 6 On the **Exceptions** tab, select the **File and Printer Sharing** check box, and then click **OK**.

For Windows Server 2008:

- 1 Click **Start**→ **Control Panel**.
- 2 Double-click **Windows Firewall**.
- 3 Click **Change settings**.
- 4 On the **Exceptions** tab, select the **File and Printer Sharing** check box, and then click **OK**.

For Windows Server 2008 R2 and Windows 7:

- 1 Click **Start**→ **Control Panel**.
- 2 Select **System and Security**.
- 3 Click **Windows Firewall**.
- 4 Click **Allow a program or feature through Windows Firewall**.
- 5 If the check boxes under **Allowed programs and features**: are dimmed, click **Change settings**.
- 6 Check the **File and Printer Sharing** check box. **Home/Work (Private)** or **Public** check box is automatically selected according to your settings.
If the **File and Printer Sharing Properties** dialog box appears, click **OK**.
- 7 Click **OK**.

Start Remote Registry



NOTE: This procedure is required for Windows Vista, Windows Vista 64-bit Edition, Windows 7, and Windows 7 64-bit Edition.

- 1 Click **Start**→ **Control Panel**.
- 2 Select **System and Maintenance** (System and Security for Windows 7).

- 3 Click **Administrative Tools**.
- 4 Double-click **Services**.
- 5 Click **Continue** (for Windows Vista only).
- 6 Right-click **Remote Registry** and select **Start**.
- 7 Right-click **Remote Registry** and select **Properties**.
- 8 Change **Startup type** to **Automatic**, and then click **OK**.

Disable User Account Control



NOTICE: Disabling the User Account Control might leave the system vulnerable to virus attacks.



NOTE: This procedure is required for Windows Vista, Windows Vista 64-bit Edition, Windows Server 2008, Windows Server 2008 64-bit Edition, Windows Server 2008 R2, Windows 7, and Windows 7 64-bit Edition.

For Windows Vista:

- 1 Click **Start** → **Control Panel**.
- 2 Select **User Accounts and Family Safety**.
- 3 Click **User Accounts**.
- 4 Click **Turn User Account Control on or off**.
- 5 Click **Continue**.
- 6 Clear the **Use User Account Control (UAC) to help protect your computer** check box.
- 7 Restart the computer.

For Windows Server 2008:

- 1 Click **Start** → **Control Panel**.
- 2 Double-click **User Accounts**.
- 3 Click **Turn User Account Control on or off**.
- 4 Clear the **Use User Account Control (UAC) to help protect your computer** check box.
- 5 Click **OK**.
- 6 Restart the computer.

For Windows Server 2008 R2:

- 1 Click **Start**→ **Control Panel**.
- 2 Select **User Accounts**.
- 3 Click **Change User Account Control Settings**.
- 4 Move the slider to the bottom, and then click **OK**.
- 5 Restart the computer.

For Windows 7:

- 1 Click **Start**→ **Control Panel**.
- 2 Select **User Accounts and Family Safety**.
- 3 Click **User Accounts**.
- 4 Click **Change User Account Control Settings**.
- 5 Move the slider to the bottom, and then click **OK**.
- 6 Click **Yes** in the **User Account Control** dialog box.
- 7 Restart the computer.

Enable Network Discovery and File Sharing for all Public Networks



NOTE: This procedure is required when you use Windows Vista, Windows Vista 64-bit Edition, Windows Server 2008, Windows Server 2008 64-bit Edition, Windows Server 2008 R2, Windows 7, and Windows 7 64-bit Edition for the server computer.

- 1 Click **Start**→ **Network** (**Start**→ your user name→ **Network** for Windows 7).
- 2 Click **Network discovery and file sharing are turned off**. Network computers and devices are not visible. Click to change.
- 3 Click **Turn on network discovery and file sharing**.
- 4 Click **Yes, turn on network discovery and file sharing for all public networks**.

Disable Simple File Sharing



NOTE: This procedure is required for Windows XP, and Windows XP 64-bit Edition.

- 1 Click **start**→ **Control Panel**.
- 2 Select **Appearance and Themes**.

- 3 Select **Folder Options**.
- 4 On the **View** tab, clear the **Use simple file sharing (Recommended)** check box, and then click **OK**.
- 5 Click **Start**→ **Control Panel**.
- 6 Select **Performance and Maintenance**.
- 7 Select **Administrative Tools**.
- 8 Click **Local Security Policy**.
- 9 Click **Local Policies**→ **Security Options**.
- 10 Right-click **Network access: Sharing and security model for local accounts** and select **Properties**.
- 11 Ensure **Classic - local users authenticate as themselves** is selected.

Installing the Printer Driver



NOTE: Installation is not supported on Windows XP Home Edition, Windows Vista Home Basic, Windows Vista Home Premium, Windows Vista Home Basic 64-bit Edition, Windows Vista Home Premium 64-bit Edition, Windows 7 Starter, Windows 7 Home Basic, Windows 7 Home Premium, Windows 7 Home Basic 64-bit Edition, and Windows 7 Home Premium 64-bit Edition.

- 1 In the **Easy Setup Navigator** window, click **Software Installation** to launch the installation software.
- 2 Select **Network Installation**, and then click **Next**.
- 3 Select the model name of your printer, and then click **Next**.
- 4 Select **Remote Installation**, and then click **Next**.
 - a Enter the computer name, user ID, and password, and then click **Add**.
 - b Click **Next**.



NOTE: **Windows Security Alert** may appear on Windows Vista, Windows Vista 64-bit Edition, Windows Server 2008, Windows Server 2008 64-bit Edition, Windows Server 2008 R2, Windows 7, or Windows 7 64-bit Edition. In this case, select **Unblock** (Allow access for Windows Server 2008 R2 and Windows 7), and then continue the procedure.

- 5 Select a printer from the printer list, and then click **Next**. If the target printer is not displayed on the list, click **Refresh** to refresh the list or click **Add Printer** to add a printer to the list manually. You may specify the IP address and port name at this point.



NOTE: When using AutoIP, 0.0.0.0 is displayed in the installer. Before you continue, you must enter a valid IP address.

- 6 Specify the printer settings, and then click **Next**.
 - a Enter the printer name.
 - b If you want other users on the network to access this printer, select the **Share this printer with other computers on the network**, and then enter a share name that users can identify.
 - c If you want to set the printer as default, select the **Set this printer as default** check box.
 - d If you want to restrict color printing, select the appropriate **Dell ColorTrack** option. Enter the password when **Color-Password Enabled** is selected for **Dell ColorTrack**.
- 7 Select the software and documentation you want to install, and then click **Install**.

If you want to change the installation destination, click **Input** and specify new location.
- 8 Click **Finish** to exit the wizard when the **Congratulations!** screen appears.

Use the **Dell Printer Configuration Web Tool** to monitor the status of your network printer without leaving your desk. You can view and/or change the printer settings, monitor toner level, and acknowledge the timing of ordering replacement consumables. You can click the Dell supplies link for ordering supplies.



NOTE: The **Dell Printer Configuration Web Tool** is not available when the printer is directly connected to a computer or a print server.

To launch the **Dell Printer Configuration Web Tool**, type the printer's IP address in your web browser. The printer configuration appears on the screen.

You can set up the **Dell Printer Configuration Web Tool** to send you an e-mail when the printer needs supplies or intervention.

To set up e-mail alerts:

- 1 Launch the **Dell Printer Configuration Web Tool**.
- 2 Click **E-Mail Alert** link.
- 3 Under **E-Mail Server Settings**, enter the **Primary SMTP Gateway, Reply Address**, and your or key operator's e-mail address in the e-mail list box.

- 4 Click **Apply New Settings**.



NOTE: Connection pending until printer sends an alert is displayed on the SMTP server until an error occurs.

Setting Up for Shared Printing

You can share your new printer on the network using the *Drivers and Utilities* CD that comes with your printer, or using Microsoft® point-and-print or peer-to-peer method. However, if you use one of the Microsoft methods, some features, such as the status monitor and other printer utilities, installed with the *Drivers and Utilities* CD, may not be available.

If you want to use the printer on a network, share the printer and install its drivers on all the computers on the network.



NOTE: You need to purchase an Ethernet cable for shared printing.

Windows XP, Windows XP 64-bit Edition, Windows Server 2003, or Windows Server 2003 x64 Edition

- 1 Click **start**→ **Printers and Faxes**.
- 2 Right-click the printer icon and select **Properties**.
- 3 On the **Sharing** tab, select the **Share this printer** check box, and then type a name in the **Share name** text box.
- 4 Click **Additional Drivers** and select the operating systems of all network clients that print to the printer.
- 5 Click **OK**.

If you are missing files, you are prompted to insert the server operating system CD.

Windows Vista or Windows Vista 64-bit Edition

- 1 Click **Start**→ **Control Panel**→ **Hardware and Sound**→ **Printers**.
- 2 Right-click the printer icon and select **Sharing**.
- 3 Click **Change sharing options**.

The message **Windows needs your permission to continue** appears.

- 4 Click **Continue**.

- 5 Select the **Share this printer** check box, and then type a name in the **Share name** text box.
- 6 Click **Additional Drivers** and select the operating systems of all network clients that print to the printer.
- 7 Click **OK**.

Windows Server 2008 or Windows Server 2008 64-bit Edition

- 1 Click **Start**→ **Control Panel**→ **Printers**.
- 2 Right-click the printer icon and select **Sharing**.
- 3 Click **Change Sharing Options** if exists.
- 4 Select the **Share this printer** check box, and then type a name in the **Share name** text box.
- 5 Click **Additional Drivers** and select the operating systems of all network clients that print to the printer.
- 6 Click **OK**.

Windows 7, Windows 7 64-bit Edition, or Windows Server 2008 R2

- 1 Click **Start**→ **Devices and Printers**.
- 2 Right-click the printer icon and select **Printer properties**.
- 3 On the **Sharing** tab, click **Change Sharing Options** if exists.
Check the **Share this printer** check box, and then type a name in the **Share name** text box.
- 4 Click **Additional Drivers** and select the operating systems of all network clients that print to the printer.
- 5 Click **Apply**, and then click **OK**.

To confirm that the printer is properly shared:

- Ensure that the printer object in the **Printers, Printers and Faxes**, or **Devices and Printers** folder is shared. The shared icon is shown under the printer icon.
- Browse **Network** or **My Network Places**. Find the host name of the server and the shared name you assigned to the printer.

Now that the printer is shared, you can install the printer on network clients using the point and print method or the peer-to-peer method.

Point and Print

Point and Print is a Microsoft Windows technology that allows you to connect to a remote printer. This feature automatically downloads and installs the printer driver.

Windows XP, Windows XP 64-bit Edition, Windows Server 2003, or Windows Server 2003 x64 Edition

- 1 On the Windows desktop of the client computer, double-click **My Network Places**.
- 2 Locate the host name of the server computer, and then double-click the host name.
- 3 Right-click the shared printer name, and then click **Connect**.

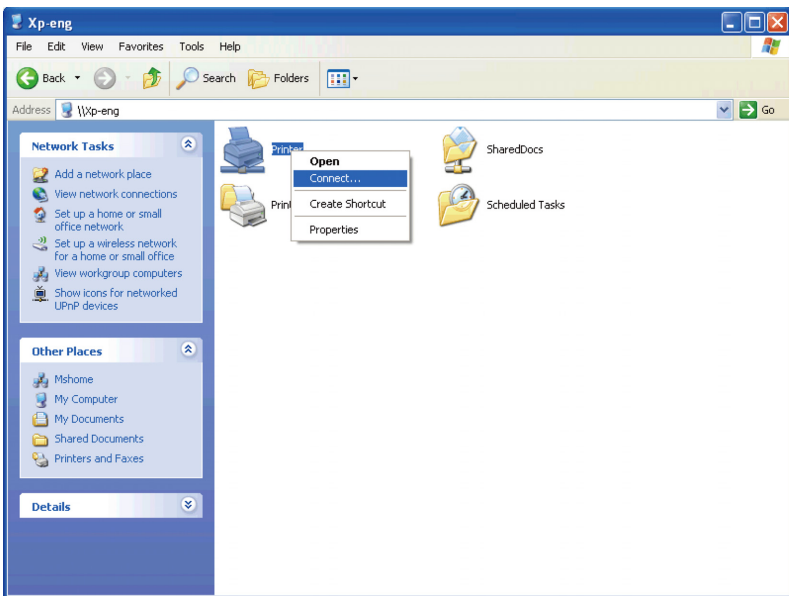

- 4 Wait for the driver information to be copied from the server computer to the client computer, and for a new printer object to be added to the **Printers and Faxes** folder. The copy time varies, based on network traffic and other factors.
- 5 Close **My Network Places**.

- 6 Print a test page to verify installation.
 - a Click **start**→ **Printers and Faxes**.
 - b Select the printer you just created.
 - c Click **File**→ **Properties**.
 - d On the **General** tab, click **Print Test Page**.

When a test page prints successfully, installation is complete.

Windows Vista or Windows Vista 64-bit Edition

- 1 On the Windows desktop of the client computer, click **Start**→ **Network**.
- 2 Locate the host name of the server computer, and then double-click the host name.
- 3 Right-click the shared printer name, and then click **Connect**.
- 4 Click **Install driver**.
- 5 Click **Continue** in the **User Account Control** dialog box.
- 6 Wait for the driver information to be copied from the server computer to the client computer, and for a new printer object to be added to the Printers folder. The time this takes varies, based on network traffic and other factors.
- 7 Print a test page to verify installation.
 - a Click **Start**→ **Control Panel**→ **Hardware and Sound**.
 - b Select **Printers**.
 - c Right-click the printer you just created and click **Properties**.
 - d On the **General** tab, click **Print Test Page**.

When a test page prints successfully, installation is complete.

Windows Server 2008 or Windows Server 2008 64-bit Edition

- 1 On the Windows desktop of the client computer, click **Start**→ **Network**.
- 2 Locate the host name of the server computer, and then double-click the host name.
- 3 Right-click the shared printer name, and then click **Connect**.
- 4 Click **Install driver**.

- 5 Wait for the driver information to be copied from the server computer to the client computer, and for a new printer object to be added to the **Printers** folder. The time this takes varies, based on network traffic and other factors.
- 6 Print a test page to verify installation.
 - a Click **Start**→ **Control Panel**.
 - b Select **Printers**.
 - c Right-click the printer you just created and select **Properties**.
 - d On the **General** tab, click **Print Test Page**.

When a test page prints successfully, installation is complete.

Windows 7, Windows 7 64-bit Edition, or Windows Server 2008 R2

- 1 On the Windows desktop of the client computer, click **Start**→ your user name→ **Network** (**Start**→ **Network** for Windows Server 2008 R2).
- 2 Locate the host name of the server computer, and then double-click the host name.
- 3 Right-click the shared printer name, and then click **Connect**.
- 4 Click **Install driver**.
- 5 Wait for the driver information to be copied from the server computer to the client computer, and for a new printer object to be added to the **Devices and Printers** folder. The time this takes varies, based on network traffic and other factors.
- 6 Print a test page to verify installation.
 - a Click **Start**→ **Devices and Printers**.
 - b Right-click the printer you just created and select **Printer properties**.
 - c On the **General** tab, click **Print Test Page**.

When a test page prints successfully, installation is complete.

Peer-to-Peer

If you use the peer-to-peer method, the printer driver is fully installed on each client computer. Network clients retain control of driver modifications. The client computer handles the print job processing.

Windows XP, Windows XP 64-bit Edition, Windows Server 2003, or Windows Server 2003 x64 Edition

- 1 Click **start**→ **Printers and Faxes**.
- 2 Click **Add a Printer**.
- 3 Click **Next**.
- 4 Select **A network printer, or a printer attached to another computer**, and then click **Next**. If the printer is not listed, type the path to the printer in the text box.

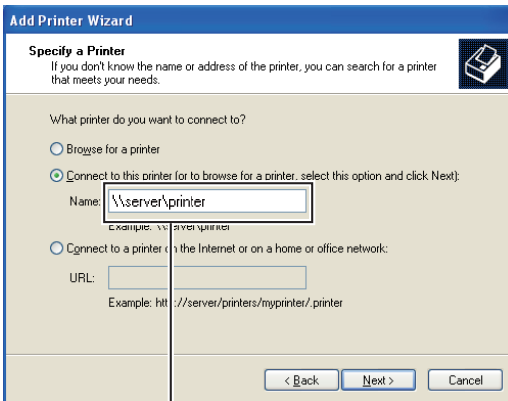

For example: \\<server host name>\<shared printer name>

The server host name is the name of the server computer that identifies it on the network. The shared printer name is the name assigned during the server installation process.

- 5 Click **Browse for a printer**, and then click **Next**.
If this is a new printer, you may be prompted to install a printer driver. If no system driver is available, you need to specify the path to available drivers.
- 6 Select **Yes** if you want this printer to be set as the default printer, and then click **Next**.
If you want to verify installation, click **Yes** to print a test page.
- 7 Click **Finish**.
When a test page prints successfully, installation is complete.

Windows Vista or Windows Vista 64-bit Edition

- 1 Click **Start**→ **Control Panel**→ **Hardware and Sound**→ **Printers**.
- 2 Click **Add a Printer** to launch the **Add Printer** wizard.
- 3 Select **Add a network, wireless or Bluetooth printer**, and then click **Next**. If the printer is listed, select the printer and click **Next**, or select **The printer that I want isn't listed** and type in the path of the printer in the **Select a shared printer by name** text box and click **Next**.

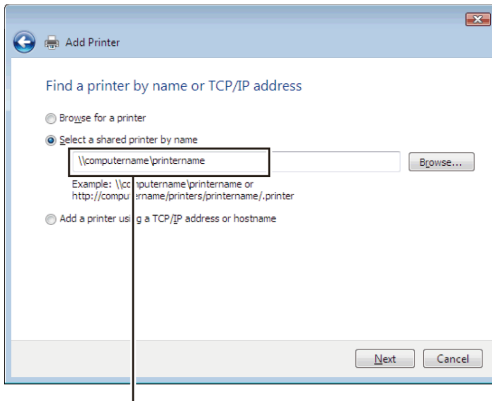

For example: \\<server host name>\<shared printer name>

The server host name is the name of the server computer that identifies it on the network. The shared printer name is the name assigned during the server installation process.

If this is a new printer, you may be prompted to install a printer driver. If no system driver is available, you need to specify the path to available drivers.

- 4 Select **Yes** if you want this printer to be set as the default printer, and then click **Next**.
- 5 If you want to verify installation, click **Print a test page**.
- 6 Click **Finish**.

When a test page prints successfully, installation is complete.

Windows Server 2008 or Windows Server 2008 64-bit Edition

- 1 Click **Start**→ **Control Panel**→ **Printers**.

- 2 Click **Add a Printer**.
- 3 Select **Add a network, wireless or Bluetooth printer**, and then click **Next**. If the printer is listed, select the printer and click **Next**, or select **The printer that I want isn't listed** and type the path to the printer in the **Select a shared printer by name** text box and click **Next**.

For example: \\<server host name>\<shared printer name>

The server host name is the name of the server computer that identifies it on the network. The shared printer name is the name assigned during the server installation process.

If this is a new printer, you may be prompted to install a printer driver. If no system driver is available, then you will need to provide a path to available drivers.

- 4 Select **Yes** if you want this printer to be set as the default printer, and then click **Next**.
- 5 Click **Print a test page** if you want to verify installation.
- 6 Click **Finish**.

When a test page prints successfully, installation is complete.

Windows 7, Windows 7 64-bit Edition, or Windows Server 2008 R2

- 1 Click **Start** → **Devices and Printers**.
- 2 Click **Add a Printer**.
- 3 Select **Add a network, wireless or Bluetooth printer**. If the printer is listed, select the printer and click **Next**, or select **The printer that I want isn't listed**. Click **Select a shared printer by name** and type in the path of the printer in the text box, and then click **Next**.

For example: \\<server host name>\<shared printer name>

The server host name is the name of the server computer that identifies it to the network. The shared printer name is the name assigned during the server installation process.

If this is a new printer, you may be prompted to install a printer driver. If no system driver is available, then you will need to provide the path to the available driver.

- 4 Confirm the printer name, and then click **Next**.
- 5 Select **Yes** if you want this printer to be set as the default printer, and then click **Next**.
- 6 Click **Print a test page** if you want to verify installation.
- 7 Click **Finish**.

When a test page prints successfully, installation is complete.

Installing Printer Drivers on the Macintosh Computers



NOTE: The images used and procedures described in this manual are those of Dell™ 2150cn Color Printer.

Installing the Drivers and Software

- 1 Run the *Drivers and Utilities* CD on the Macintosh computer.
- 2 Double-click the **Dell 2150 Installer** icon, and then click **Continue**.
- 3 When the popup dialog box prompts you for confirming the program included in the installation package, click **Continue**.
- 4 Click **Continue** on the **Welcome** screen.
- 5 After reading the Software License Agreement, click **Continue**.
- 6 If you agree to the terms of the Software License Agreement, click **Agree** to continue the installation process.
- 7 Click **Install** to perform the standard installation.

If you want to select a custom installation, click **Customize** to select items that you want to install.

- Dell 2150 Color Printer Driver
 - Dell Printer Status Monitor
- 8 Type the administrator's name and password, and then click **OK**.
 - 9 When the **Install Succeeded** screen appears, click **Close** to complete installation.

Adding a Printer on Mac OS X 10.5 or 10.6

When Using a USB connection

- 1 Turn on the printer.
- 2 Connect the USB cable between the printer and the Macintosh computer.

The printer is automatically added to your Macintosh computer.

When Using IP Printing

- 1 Turn on the printer.
- 2 Ensure that Macintosh computer and the printer are connected.
If you use wired connection, connect the LAN cable between the printer and the network.
If you use wireless connection, ensure that wireless connection is configured properly on your Macintosh computer and the printer.
- 3 Open the **System Preferences**, and click **Print & Fax**.
- 4 Click the Plus (+) sign, and click **IP**.
- 5 Select **Line Printer Daemon - LPD** for **Protocol**.
- 6 Type the IP address for the printer in the **Address** area.
- 7 Select **Dell 2150cn Color Printer** for **Print Using**.
 **NOTE:** When printing is set up using IP printing, the queue name is displayed as blank. You do not need to specify it.
- 8 Click **Add**.
- 9 Specify the options that have been installed on the printer, and then click **Continue**.
- 10 Confirm that the printer is displayed in the **Print & Fax** dialog box.

When Using Bonjour

- 1 Turn on the printer.
- 2 Ensure that Macintosh computer and the printer are connected.
If you use wired connection, connect the LAN cable between the printer and the network.
If you use wireless connection, ensure that wireless connection is configured properly on your Macintosh computer and the printer.
- 3 Open the **System Preferences**, and click **Print & Fax**.
- 4 Click the Plus (+) sign, and click **Default**.
- 5 Select the printer connected via Bonjour from the **Printer Name** list.

- 6 **Name** and **Print Using** are automatically entered.
- 7 Click **Add**.
- 8 Specify the options that have been installed on the printer, and then click **Continue**.
- 9 Confirm that the printer is displayed in the **Print & Fax** dialog box.

Adding a Printer on Mac OS X 10.4.11

When Using a USB Connection

- 1 Turn on the printer.
- 2 Connect the USB cable between the printer and the Macintosh computer.
- 3 Start **Printer Setup Utility**.
 **NOTE:** You can find **Printer Setup Utility** in the **Utilities folder** in **Applications**.
- 4 Click **Add**.
- 5 Click **Default Browser** in the **Printer Browser** dialog box.
- 6 Select the printer connected via USB from the Printer list.
- 7 **Name** and **Print Using** are automatically entered.
- 8 Click **Add**.

When Using IP Printing

- 1 Turn on the printer.
- 2 Ensure that Macintosh computer and the printer are connected.
If you use wired connection, connect the LAN cable between the printer and the network.
If you use wireless connection, ensure that wireless connection is configured properly on your Macintosh computer and the printer.
- 3 Start **Printer Setup Utility**.
 **NOTE:** You can find **Printer Setup Utility** in the **Utilities folder** in **Applications**.
- 4 Click **Add**.
- 5 Click **IP Printer** in the **Printer Browser** dialog box.

- 6 Select **Line Printer Daemon - LPD** for **Protocol**.
- 7 Type the IP address for the printer in the **Address** area.
- 8 Select **Dell 2150cn Color Printer** for **Print Using**.



NOTE: When printing is set up using IP printing, the queue name is displayed as blank. You do not need to specify it.



NOTE: Entry of Location is optional.

- 9 Click **Add**.

When Using Bonjour

- 1 Turn on the printer.
- 2 Ensure that Macintosh computer and the printer are connected.
If you use wired connection, connect the LAN cable between the printer and the network.
If you use wireless connection, ensure that wireless connection is configured properly on your Macintosh computer and the printer.
- 3 Start the **Printer Setup Utility**.



NOTE: You can find **Printer Setup Utility** in the **Utilities** folder in **Applications**.

- 4 Click **Add**.
- 5 Click **Default Browser** in the **Printer Browser** dialog box.
- 6 Select the printer connected via Bonjour from the **Printer Name** list.
- 7 **Name** and **Print Using** are automatically entered.
- 8 Click **Add**.
- 9 Specify the options installed to the printer, and then click **Continue**.
- 10 Confirm that the printer is displayed on the **Printer** list dialog box.

Adding a Printer on Mac OS X 10.3.9

When Using a USB connection

- 1 Turn on the printer.
- 2 Connect the USB cable between the printer and the Macintosh computer.

3 Start **Printer Setup Utility**.



NOTE: You can find **Printer Setup Utility** in the **Utilities folder** in **Applications**.

4 Click **Add**.

5 Select **USB** from the menu.

The **Printer Model** is automatically selected.

6 Click **Add**.

When Using IP Printing

1 Turn on the printer.

2 Ensure that Macintosh computer and the printer are connected.

If you use wired connection, connect the LAN cable between the printer and the network.

If you use wireless connection, ensure that wireless connection is configured properly on your Macintosh computer and the printer.

3 Start **Printer Setup Utility**.



NOTE: You can find **Printer Setup Utility** in the **Utilities folder** in **Applications**.

4 Click **Add** in the **Printer List** dialog box.

5 Select **IP Printing** from the menu.

6 Select **LPD/LPR** for **Printer Type**.

7 Type the IP address for the printer in the **Address** area.

8 Select **Dell** for **Printer Model**, and select **Dell 2150cn Color Printer**.



NOTE: When printing is set up using IP printing, the queue name is displayed as blank. You do not need to specify it.

9 Click **Add**.

When Using Rendezvous (Bonjour)

1 Turn on the printer.

2 Ensure that Macintosh computer and the printer are connected.

If you use wired connection, connect the LAN cable between the printer and the network.

If you use wireless connection, ensure that wireless connection is configured properly on your Macintosh computer and the printer.

3 Start **Printer Setup Utility**.



NOTE: You can find **Printer Setup Utility** in the **Utilities folder** in **Applications**.

4 Click **Add** in the **Printer List** dialog box.

5 Select **Rendezvous** from the menu.

6 Select **Dell** for **Printer Model**, and select **Dell 2150cn Color Printer**.

7 Click **Add**.

Configuring Settings

All the optional accessories are verified as installed.

Mac OS X 10.5 or 10.6

1 Open the **System Preferences**, and click **Print & Fax**.

2 Select the printer in the **Printer Name** list, and click **Options & Supplies**.

3 Select **Driver**, and select the options that have been installed in the printer, and then click **OK**.

Mac OS X 10.3.9 or 10.4.11

1 Start **Printer Setup Utility**.

2 Select the printer in the **Printer List** dialog box, and click **Show Info**.

3 Select **Installable Options**, and select the options that have been installed in the printer, and then click **Apply Changes**.

Installing Printer Drivers on the Linux Computers (CUPS)

This section provides information for installing or setting up the printer driver with CUPS (Common UNIX Printing System) on Red Hat® Enterprise Linux® 4 WS/5 Client or SUSE® Linux Enterprise Desktop 10/11.



NOTE: The images used and procedures described in this manual are those of Dell™ 2150cn Color Printer.

Operation on Red Hat Enterprise Linux 4 WS/5 Client

Setup Overview

Red Hat Enterprise Linux 4 WS/5 Client:

- 1 Install the printer driver.
- 2 Set up the print queue.
- 3 Specify the default queue.
- 4 Specify the printing options.

Installing the Printer Driver



NOTICE: Before you install the printer driver on Red Hat Enterprise Linux 4, confirm that Update 5 or higher is applied to your operating system. Consult your Linux distributor for the upgrade of your system.

- 1 Double-click **Dell-2150-Color-Printer-x.x-x.i686.rpm** in the *Drivers and Utilities* CD.
- 2 Type the administrator password.
- 3 Click **Continue** in the **Completed System Preparation** window.

Installation starts. When the installation is complete, the window is automatically closed.

Setting Up the Queue

To execute printing, you must set up the print queue on your workstation.

- 1 Open the URL "**http://localhost:631**" using a web browser.
- 2 Click **Administration**.
- 3 Type **root** as the user name, and type the administrator password.
- 4 Click **Add Printer**.

Type the name of the printer in the **Name** box in the **Add New Printer** window, and click **Continue**.

You can optionally specify the location and description of the printer for further information.

For network connections:

- a Select **LPD/LPR Host or Printer** from the **Device** menu, and click **Continue**.
- b Type the IP address of the printer in **Device URI**.
- c Format: `lpd://xxx.xxx.xxx.xxx` (the IP address of the printer)

For USB connections with Red Hat Enterprise Linux 4 WS:

- a Select **USB Printer #1** from the **Device** menu.

For USB connections with Red Hat Enterprise Linux 5 Client:

- a Select **Dell 2150cn Color Laser USB #1** or **Dell 2150cn Color Laser** from the **Device** menu.
- 5 Select **Dell** from the **Make** menu, and click **Continue**.
 - 6 Select **Dell 2150cn Color Printer** from the **Model** menu, and click **Continue**.

The message **Printer xxx has been added successfully**. appears.

The setup is complete.

Printing From the Applications

When you have finished setting up the queue you can print jobs from the applications. Start the print job from the application, and specify the queue in the print dialog box.

However, sometimes you can print only from the default queue depending on the application (for example Mozilla). In these cases, before you start printing, set queue you want to print to as the default queue. For information on specifying the default queue, see "Setting the Default Queue."

Setting the Default Queue

- 1 Select **Applications**→**System Tools**→**Terminal**.
- 2 Type the following command in the terminal window.

```
su
(Type the administrator password)
lpadmin -d (Type the queue name)
```

Specifying the Printing Options

You can specify the printing options such as color mode or double-sided printing.

- 1 Open the URL "**http://localhost:631**" using a web browser.
- 2 Click **Manage Printers**.
- 3 Click **Configure Printer** of the queue for which you want to specify the printing options.
- 4 Type **root** as the user name, and type the administrator password.
- 5 Specify the required settings, and click **Continue**.

The message **Printer xxx has been configured successfully**. appears.

The setting is complete.

Uninstalling the Printer Driver

- 1 Select **Applications**→**System Tools**→**Terminal**.
- 2 Type the following command in the terminal window to delete the print queue.

```
su
(Type the administrator password)
/usr/sbin/lpadmin -x (Type the print queue name)
```

- 3 Repeat the command above for all queues for the same model.
- 4 Type the following command in the terminal window.

```
su
(Type the administrator password)
rpm -e Dell-2150cn-Color-Printer
```

The printer driver is uninstalled.

Operation on SUSE Linux Enterprise Desktop 10

Setup Overview

SUSE Linux Enterprise Desktop 10:

- 1 Install the printer driver.
- 2 Set up the print queue.
- 3 Specify the default queue.
- 4 Specify the printing options.

Installing the Printer Driver

- 1 Double-click **Dell-2150-Color-Printer-x.x-x.i686.rpm** in the *Drivers and Utilities* CD.
- 2 Type the administrator password, and click **Install**.

Installation starts. When the installation is complete, the window is automatically closed.

Setting Up the Queue

To execute printing, you must set up the print queue on your workstation.

- 1 Select **Computer**→ **More Applications...** and select **YaST** on the Application Browser.
- 2 Type the administrator password.
YaST Control Center is activated.
- 3 Select **Hardware** on **YaST Control Center**, and select **Printer**.
- 4 **Printer setup: Autodetected printers** is activated.

For network connections:

- a Click **Add**.
- b Select **Network Printers** as **Printer Type**, and click **Next**.
- c Select the **Print via LPD-Style Network Server** as **Printer Type**, and click **Next**.
- d Type the IP address of the printer in **Host name of the printer server**.
- e Type the name of the printer queue in **Name of the remote queue**, and click **Next**.
- f Type the printer name in **Name for printing**.



NOTE: The **Description of Printer** and **Location of Printer** do not have to be specified.

- g Select the **Do Local Filtering** check box, and click **Next**.
- h Select **DELL** as **Select manufacturer**. Select **2150cn Color Laser** as **Select Model**, and click **Next**.
- i Confirm the settings in **Edit configuration**, and click **OK**.

For USB connections:

- a Select **Dell 2150cn Color Printer on USB** (**//Dell/2150cn%20Color%20Printer** or **/dev/usb/lp***) as **Available are**, and click **Configure....**
 - b Confirm the settings in **Edit configuration**, and click **OK**.
- 5 Click **Finish**.

Printing From the Applications

When you have finished setting up the queue you can print jobs from the applications. Start the print job from the application, and specify the queue in the print dialog box.

However, sometimes you can print only from the default queue depending on the application (for example Mozilla). In these cases, before you start printing, set queue you want to print to as the default queue. For information on specifying the default queue, see "Setting the Default Queue."

Setting the Default Queue

- 1 To activate the **Printer setup: Autodetected printers**, do the following.
 - a Select **Computer**→**More Applications...** and select **YaST** on the Application Browser.
 - b Type the administrator password.
YaST Control Center is activated.
 - c Select **Hardware** on **YaST Control Center**, and select **Printer**.
- 2 Select the printer you want to set to default on the **Printer Configuration**, and select **Set default** in **Other button menu**.
- 3 Click **Finish**.

Specifying the Printing Options

You can specify the printing options such as color mode or double-sided printing.

- 1 Open a web browser.
- 2 Type **http://localhost:631/admin** in **Location**, and press the <Enter> key.
- 3 Type **root** as the user name, and type the administrator password.

The **CUPS** window appears.



NOTE: Set the password for authority as the printer administrator before setting the printer queue. If you have not set it, go to "Setting the Password for Authority as the Printer Administrator."

- 4 Click **Manage Printers**.
- 5 Specify the required settings, and click **Continue**.

The message **Printer xxx has been configured successfully.** appears.

The setting is complete. Execute printing from the application.

Setting the Password for Authority as the Printer Administrator

You must set the password for authority as the printer administrator to do operations as the printer administrator.

- 1 Select **Computer**→**More Applications...** and select **Konsole** on the Application Browser.
- 2 Type the following command in the terminal window.

```
su
(Type the administrator password)
lppasswd -g sys -a root
(Type the password for authority as the printer administrator after the
Enter password prompt.)
(Retype the password for authority as the printer administrator after the
Enter password again prompt.)
```

Uninstalling the Printer Driver

- 1 Select **Computer**→**More Applications...** and select **Konsole** on the Application Browser.
- 2 Type the following command in the terminal window to delete the print queue.

```
su
(Type the administrator password)
/usr/sbin/lpadm -x (Type the printer queue name)
```

- 3 Repeat the command above for all queues for the same model.
- 4 Type the following command in the terminal window.

```
su
(Type the administrator password)
rpm -e Dell-2150cn-Color-Printer
```

The printer driver is uninstalled.

Operation on SUSE Linux Enterprise Desktop 11

Setup Overview

SUSE Linux Enterprise Desktop 11:

- 1 Install the printer driver.
- 2 Set up the print queue.
- 3 Specify the default queue.
- 4 Specify the printing options.

Installing the Printer Driver

- 1 Double-click **Dell-2150-Color-Printer-x.x-x.i686.rpm** in the *Drivers and Utilities* CD.
- 2 Type the administrator password, and click **Continue**.

Installation starts. When the installation is complete, the window is automatically closed.

Setting Up the Queue

To execute printing, you must set up the print queue on your workstation.

- 1 Select **Computer**→**More Applications...**, and select **YaST** on the Application Browser.
- 2 Type the administrator password.
YaST Control Center is activated.
- 3 Select **Hardware** on **YaST Control Center**, and select **Printer**.
The **Printer Configurations** dialog box opens.

For network connections:

- a Click **Add**.

The **Add New Printer Configuration** dialog box opens.

- b Click **Connection Wizard**.

The **Connection Wizard** dialog box opens.

- c Select **Line Printer Daemon (LPD) Protocol** from **Access Network Printer or Printserver Box via**.

- d Type the IP address of the printer in **IP Address or Host Name**:

- e Select **Dell** in the **Select the printer manufacturer**: drop-down menu.

- f Click **OK**.

The **Add New Printer Configuration** dialog box opens.

- g Select **Dell 2150cn Color Printer vx.x** [**Dell/Dell_2150cn_Color_Printer.ppd.gz**] from the **Search for Drivers**: list.



NOTE: You can specify the printer name in **Set Name**:

- h Confirm the settings, and click **OK**.

For USB connections:

- a Click **Add**.

The **Add New Printer Configuration** dialog box opens.

The printer name is displayed in the **Determine Connection** list.

- b Select **Dell 2150cn Color Printer vx.x** [**Dell/Dell_2150cn_Color_Printer.ppd.gz**] from the **Search for Drivers**: list.



NOTE: You can specify the printer name in **Set Name**:

Printing From the Applications

When you have finished setting up the queue, you can print jobs from the applications. Start the print job from the application, and specify the queue in the print dialog box.

However, sometimes you can print only from the default queue depending on the application (for example Mozilla). In these cases, before you start printing, set queue you want to print to as the default queue. For information on specifying the default queue, see "Setting the Default Queue."

Setting the Default Queue

You can set the default queue when you add the printer.

- 1 Select **Computer**→**More Applications...**, and select **YaST** on the Application Browser.
- 2 Type the administrator password.
YaST Control Center is activated.
- 3 Select **Hardware** on **YaST Control Center**, and select **Printer**.
The **Printer Configurations** dialog box opens.
- 4 Click **Edit**.
A dialog box to modify the specified print queue opens.
- 5 Confirm that the printer you want to set is selected in the **Connection** list.
- 6 Select the **Default Printer** check box.
- 7 Confirm the settings, and click **OK**.

Specifying the Printing Options

You can specify the printing options such as color mode or double-sided printing.

- 1 Open a web browser.
- 2 Type **http://localhost:631/admin** in **Location**, and press the <Enter> key.
- 3 Type **root** as the user name, and type the administrator password.
The **CUPS** window appears.



NOTE: Set the password for authority as the printer administrator before setting the printer queue. If you have not set it, go to "Setting the Password for Authority as the Printer Administrator."

- 4 Click **Manage Printers**.
- 5 Specify the required settings, and click **Continue**.

The message **Printer xxx has been configured successfully.** appears.

The setting is complete. Execute printing from the application.

Setting the Password for Authority as the Printer Administrator

You must set the password for authority as the printer administrator to do operations as the printer administrator.

- 1 Select **Computer**→**More Applications...** and select **GNOME Terminal** on the Application Browser.
- 2 Type the following command in the terminal window.

```
su
(Type the administrator password)
lppasswd -g sys -a root
(Type the password for authority as the printer administrator after the
Enter password prompt.)
(Retype the password for authority as the printer administrator after the
Enter password again prompt.)
```

Uninstalling the Printer Driver

- 1 Select **Computer**→**More Applications...** and select **GNOME Terminal** on the Application Browser.
- 2 Type the following command in the terminal window to delete the print queue.

```
su
(Type the administrator password)
/usr/sbin/lpadmin -x (Type the printer queue name)
```

- 3 Repeat the command above for all queues for the same model.
- 4 Type the following command in the terminal window.

```
su
```

```
(Type the administrator password)
```

```
rpm -e Dell-2150cn-Color-Printer
```



The printer driver is uninstalled.

Using Your Printer

13

Dell Printer Configuration Web Tool

Overview

-  NOTE: This web tool is not available unless the printer is connected to a network using a network cable or the wireless printer adapter.
-  NOTE: The images used and procedures described in this manual are those of Dell™ 2150cn Color Printer.

One of the features of the **Dell Printer Configuration Web Tool** is E-Mail Alert Setup, which sends e-mail to you or the key operator when the printer needs supplies or intervention.

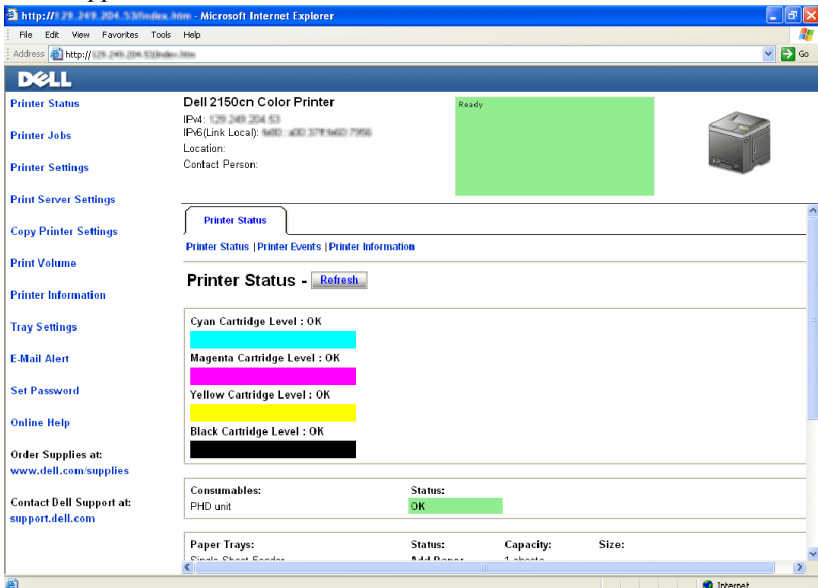

http://192.168.204.53/index.htm - Microsoft Internet Explorer

File Edit View Favorites Tools Help

Address http://192.168.204.53/index.htm Go

DELL

Printer Status Dell 2150cn Color Printer Ready 

Printer Jobs IP4: 129.249.204.53
IP6 (Link Local): fe80::403:37f:fe60:7956
Location:
Contact Person:

Printer Settings

Print Server Settings

Copy Printer Settings

Print Volume

Printer Information

Tray Settings

E-Mail Alert

Set Password

Online Help

Order Supplies at:
www.dell.com/supplies

Contact Dell Support at:
support.dell.com

Printer Status - Refresh

Printer Status | Printer Events | Printer Information

Printer Status

Cyan Cartridge Level : OK

Magenta Cartridge Level : OK

Yellow Cartridge Level : OK

Black Cartridge Level : OK

Consumables: PHD unit **Status:** OK

Paper Trays: Status: OK Capacity: 1 sheets Size: 8.5x11 inches



To fill out printer inventory reports requiring the asset tag number of all the printers in your area, use the **Printer Information** feature in the **Dell Printer Configuration Web Tool**. Enter the IP address of each printer on the network to display the asset tag number.

The **Dell Printer Configuration Web Tool** feature also allows you to change the printer settings and keep track of printing trends. If you are a network administrator, you can copy the printer settings to one or all printers on the network using your web browser.

To launch the **Dell Printer Configuration Web Tool**, enter the IP address of your printer in your web browser.

If you do not know the IP address of your printer, print the printer settings report or display the **TCP/IP Settings** page, which lists the IP address.

When Using the Operator Panel

- 1 Press the  (Menu) button.
- 2 Ensure that **Report/List** is displayed, and then press the  (**Set**) button.
- 3 Ensure that **Printer Setting** is displayed, and then press the  (**Set**) button.

The printer settings report is printed.

If the IP address shows 0 . 0 . 0 . 0 (the factory default), an IP address has not been assigned. To assign one for your printer, see "Assigning an IP Address."

When Using the Tool Box

 **NOTE:**

- 1 Click **Start**→ **All Programs**→ **Dell Printers**→ **Dell 2150 Color Printer**→ **Tool Box**.

 **NOTE:** The **Select Printer** window appears in this step when multiple printer drivers are installed on your computer. In this case, click the name of this printer listed in **Printer Names**, and then click **OK**.

The **Tool Box** opens.

- 2 Ensure that the **Printer Settings Report** tab is open.
- 3 Select **TCP/IP Settings** from the list at the left side of the page.
The **TCP/IP Settings** page appears.

If the IP address shows 0 . 0 . 0 . 0 (the factory default), an IP address has not been assigned. To assign one for your printer, see "Assigning an IP Address."

Using the Dell Printer Configuration Web Tool

The **Dell Printer Configuration Web Tool** consists of the following menus:

- Printer Status
- Printer Jobs
- Printer Settings
- Print Server Settings
- Copy Printer Settings
- Print Volume
- Printer Information
- Tray Settings
- E-Mail Alert
- Set Password
- Online Help
- Order Supplies at:
- Contact Dell Support at:

Printer Status

Use the **Printer Status** menu to get immediate feedback on the printer supply status. When a toner cartridge is running low, click the order supplies link on the first screen to order a new toner cartridge.

Printer Jobs

Use the **Printer Jobs** menu to contain information on the **Job List** page and **Completed Jobs** page.

These pages show the details of the status regarding each protocol or job.

Printer Settings

Use the **Printer Settings** menu to change the printer settings and to view the settings in the operator panel remotely.

Print Server Settings

Use the **Print Server Settings** menu to change the type of printer interface and the necessary conditions for communications.

Copy Printer Settings

Use the **Copy Printer Settings** menu to copy the printer settings to another printer or printers on the network by typing the IP address of each printer.



NOTE: You must log in as an administrator to use this feature.

Print Volume

Use the **Print Volume** menu to check the history of printing, such as paper usage, the types of jobs being printed, limit to which users can use the color mode, and the maximum number of pages they can print.

Printer Information

Use the **Printer Information** menu to get information on service calls, inventory reports, or the status of current memory and engine code levels.

Tray Settings

Use the **Tray Settings** menu to get information about the paper type and size for each tray.

E-Mail Alert

Use the **E-Mail Alert** menu to receive e-mail when the printer needs supplies or intervention. To be notified, type your name or the name of the key operator in the e-mail list box.

Set Password

Use the **Set Password** menu to lock the **Dell Printer Configuration Web Tool** with a password so that other users do not inadvertently change the printer settings that you have selected.



NOTE: You must log in as an administrator to use this feature.

Online Help

Click **Online Help** to visit the Dell Support website.

Order Supplies at:

www.dell.com/supplies

Contact Dell Support at:

support.dell.com

Setting Up the Dell Printer Configuration Web Tool

Ensure that you activate JavaScript in your browser before using the **Dell Printer Configuration Web Tool**.

It is recommended that you configure the environment settings of your web browser before using the **Dell Printer Configuration Web Tool**.



NOTE: The **Dell Printer Configuration Web Tool** pages may be displayed unreadable if the pages were configured by the language different from the language of your web browser.

Setting Up From Web Browser

It is recommended that you configure both the environment settings of your web browser and the operator panel before using the **Dell Printer Configuration Web Tool**.

For Internet Explorer® 6.0, Internet Explorer 7.0, Internet Explorer 8.0

Setting Up the Display Language

- 1 Select **Internet Options** from **Tools** on the menu bar.
- 2 Select **Languages** in the **General** tab.
- 3 Specify the display language in order of preference in the **Language** list.

For example:

- **Italian (Italy) [it-IT]**
- **Spanish (Traditional Sort) [es-ES tradnl]**

- **German (Germany)** [de-DE]
- **French (France)** [fr-FR]
- **English (United States)** [en-US]
- **Danish** [da-DK]
- **Dutch (Netherlands)** [nl-NL]
- **Norwegian (Bokmal)** [no]
- **Swedish** [sv-SE]

Setting the IP Address of the Printer to Non-Proxy

- 1 Select **Internet Options** from the **Tools** menu.
- 2 Click **LAN Settings** under **Local Area Network (LAN) Settings** in the **Connections** tab.
- 3 Do either of the following:
 - Clear the **Use a proxy server for your LAN** check box under **Proxy server**.
 - Click **Advanced**, and then specify the IP address of the printer in the **Do not use proxy server for addresses beginning with** field under **Exceptions**.

After setting the language and proxy, type `<http://nnn.nnn.nnn.nnn/>` (the IP address of the printer) in the URL entry field of the browser to activate the **Dell Printer Configuration Web Tool**.

For Firefox 2.0 or Later

Setting Up the Display Language

- 1 Select **Options** from the **Tools** menu.
- 2 Click **Advanced**.
- 3 If you are using Firefox 2.0, click **Choose** in the **General** tab. If you are using Firefox 3.0, click **Choose** in the **Content** tab.
- 4 Specify the display language in order of preference in the **Languages in order of preference** list.enu.

For example:

- **English** [en] or **English/United States** [en-us]

- **Italian [it]**
- **Spanish [es]**
- **German [de]**
- **French [fr]**
- **Dutch [nl]**
- **Norwegian [no]**
- **Swedish [sv]**
- **Danish [da]**

Setting the IP Address of the Printer to Non-Proxy

- 1 Select **Options** from the **Tools** menu
- 2 Click **Advanced** tab.
- 3 Click **Network** on the **Options** dialog box.
- 4 Click **Connection** → **Settings**.
- 5 If you are using Firefox 2.0, do one of the following:
 - Select the **Direct connection to the Internet** check box.
 - Select the **Auto-detect proxy settings for this network** check box.
 - Select the **Manual proxy configuration** check box, and then enter the IP address of the printer in the **No Proxy for** edit box.
 - Select the **Automatic proxy configuration URL** check box.

If you are using Firefox 3.0, do one of the following:

- Select the **No Proxy** check box, if you do not want to use a proxy.
- Select the **Auto-detect proxy settings for this network** check box.
- Select the **Manual proxy configuration** check box, and then enter a hostname and a port number if you have a list of one or more proxy servers. If you have an IP address that does not use a proxy, enter the IP address of the printer in the **No Proxy for** edit box.
- Select the **Automatic proxy configuration URL** check box.

After setting the language and proxy, type `<http://nnn.nnn.nnn.nnn/>` (the IP address of the printer) in the URL entry field of the browser to activate the **Dell Printer Configuration Web Tool**.

Setting Up From Operator Panel

You can launch the **Dell Printer Configuration Web Tool** only when **EWS** is set to **Enable** (the factory default) on the operator panel. Confirm the operator panel setting if you cannot launch the **Dell Printer Configuration Web Tool**. For more information, see "Understanding the Printer Menus."

Page Display Format

The layout of the page is divided into three sections listed below:

- Top Frame
- Left Frame
- Right Frame

Top Frame

The top frame is located at the top of all pages. When the **Dell Printer Configuration Web Tool** is activated, the current status and specifications of the printer are displayed in the top frame on every page.

The following items are displayed in the top frame.

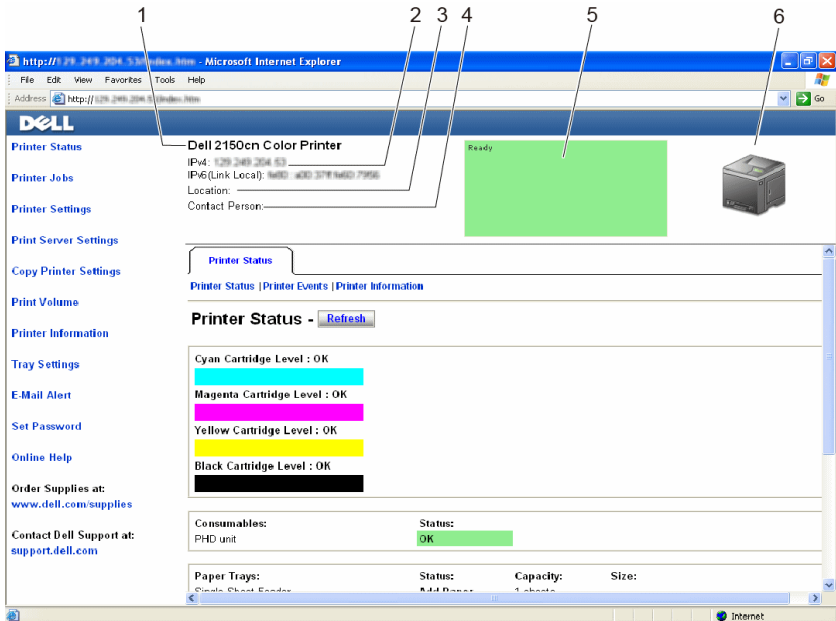

-
- | | |
|------------------------------------|---|
| 1 Dell 2150cn Color Printer | Displays the product name of the printer. |
|------------------------------------|---|
-
- | | |
|------------------------|---|
| 2 IPv4
IPv6 | Displays the IP address of the printer. |
|------------------------|---|
-
- | | |
|-------------------|---|
| 3 Location | Displays the location of the printer. The location can be changed in the Basic Information section on the Print Server Settings page. |
|-------------------|---|
-
- | | |
|-------------------------|---|
| 4 Contact Person | Displays the name of the printer administrator. The name can be changed in the Basic Information section on the Print Server Settings page. |
|-------------------------|---|
-
- | | |
|----------------------|--|
| 5 Event Panel | Displays the indicator for the condition of the printer. |
|----------------------|--|
-
- | | |
|------------------------|---|
| 6 Machine image | Shows the bitmap image of the printer. The Printer Status menu appears in the right frame when you click on the image. |
|------------------------|---|
-

Left Frame

The left frame is located on the left side of all the pages. The menu titles displayed in the left frame are linked to corresponding menus and pages. You can go to the corresponding page by clicking their characters.

The following menus are displayed in the left frame.

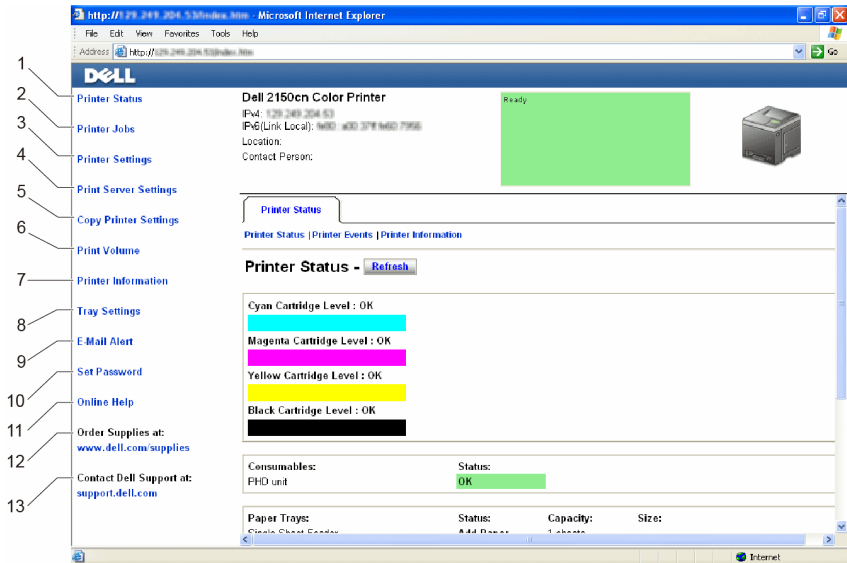

1 Printer Status	Links to the Printer Status menu.
2 Printer Jobs	Links to the Printer Jobs menu.
3 Printer Settings	Links to the Printer Settings Report menu.
4 Print Server Settings	Links to the Print Server Reports menu.
5 Copy Printer Settings	Links to the Copy Printer Settings menu.
6 Print Volume	Links to the Print Volume menu.
7 Printer Information	Links to the Printer Status menu.
8 Tray Settings	Links to the Tray Settings menu.

9 E-Mail Alert	Links to the Print Server Settings menu.
10 Set Password	Links to the Security menu.
11 Online Help	Links to the Dell Support website.
12 Order Supplies at:	Links to the Dell web page.
13 Contact Dell Support at:	Links to the Dell support page web address: http://support.dell.com/

Right Frame

The right frame is located on the right side of all the pages. The contents of the right frame correspond to the menu that you select in the left frame. For details on the items displayed in the right frame, see "Details of the Menu Items."

Buttons in the Right Frame

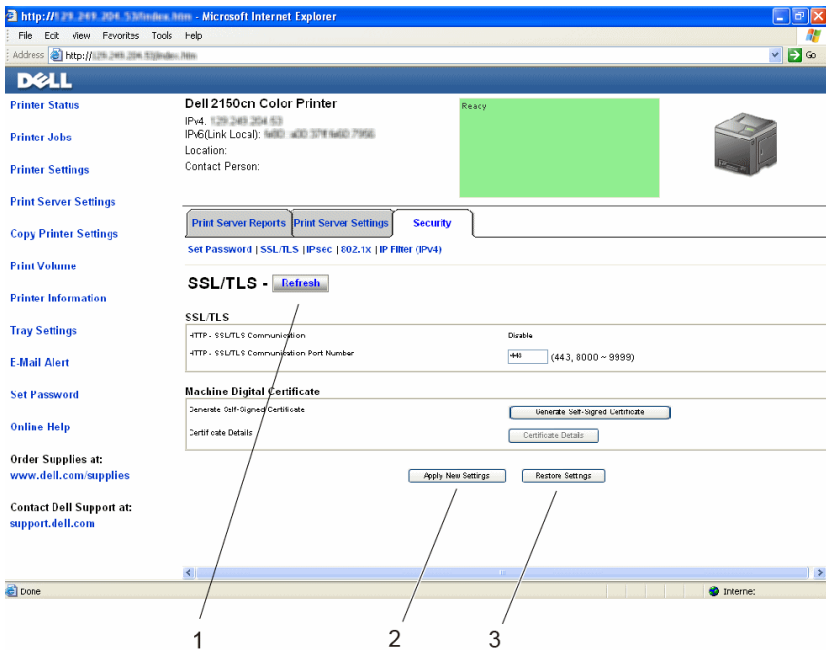

1 Refresh Button	Receives the current printer configuration and updates the latest information in the right frame.
2 Apply New Settings Button	Submits new settings made on the Dell Printer Configuration Web Tool to the printer. The new settings replace the old settings of the printer.
3 Restore Settings Button	Restores the old settings that existed before any changes were made. New settings will not be submitted to the printer.

Changing the Settings of the Menu Items

Some menus allow you to change the printer settings through the **Dell Printer Configuration Web Tool**. When you access these menus, the authentication window appears on the screen. Type a user name and password for the printer administrator by following the prompts displayed in the dialog box.

The default user name is **admin**, and the default password is left blank (NULL). You can change only the password in the **Set Password** page in the **Security** menu. The user name cannot be changed. See "Set Password" for more information.

Details of the Menu Items

"Printer Status"	"Printer Status"	"Printer Status"
		"Printer Events"
		"Printer Information"
"Printer Jobs"	"Printer Jobs"	"Job List"
		"Completed Jobs"

"Printer Settings"	"Printer Settings Report"	"Menu Settings"
		"Reports"
"Printer Settings"		"System Settings"
		"USB Settings"
		"PCL Settings"
		"Secure Settings"
"Printer Maintenance"		"Paper Density"
		"Adjust BTR"
		"Adjust Fuser"
		"Auto Registration Adjustment"
		"Color Registration Adjustments"
		"Clean Developer"
		"Reset Defaults"
		"Initialize PrintMeter"
		"Storage"*1
		"Non-Dell Toner"
		"Adjust Altitude"
		"Clock Settings"
		"Web Link Customization"

"Print Server Settings"	"Print Server Reports"	"Print Server Setup Page"
		"E-Mail Alert Setup Page"
	"Print Server Settings"	"Basic Information"
		"Port Settings"
		"TCP/IP"
		"SMB"
		"E-Mail Alert"
		"Bonjour (mDNS)"
		"SNMP"
		"LLTD"
		"Wireless LAN"*2
		"Reset Print Server"
	"Security"	"Set Password"
		"SSL/TLS"
	"IPsec"	
	"802.1x"*3	
	"IP Filter (IPv4)"	
"Copy Printer Settings"	"Copy Printer Settings"	"Copy Printer Settings"
		"Copy Printer Settings Report"
"Print Volume"	"Print Volume"	"Print Volume"
		"Dell ColorTrack"
"Tray Settings"	"Tray Settings"	
*1	This item is available only when RAM disk is enabled.	
*2	This item is available only when the printer is connected using the wireless network.	
*3	This item is available only when the printer is connected using LAN cable.	

Printer Status

Use the **Printer Status** menu to check the status of consumables, hardware, and specifications of the printer.

The following pages are displayed in the **Printer Status** menu.

Printer Status

Purpose:

To check the status of the consumables, trays, and covers.

Values:

Cyan Cartridge Level	OK	Indicates that there is enough amount of toner for use.
Magenta Cartridge Level		
Yellow Cartridge Level	Replace Soon	Indicates that the toner needs to be replaced soon.
Black Cartridge Level	Replace Now	Indicates that the toner needs to be replaced now.
Consumables	Status	OK Indicates that the status of PHD unit is OK for use.
		Replace Soon Indicates that the PHD unit needs to be replaced soon.
		Replace Now Indicates that the PHD unit needs to be replaced now.
Paper Trays	Status	OK Indicates that there is some paper in the tray but the quantity is unknown.
		Add Paper Indicates that there is no paper in the tray.
		Paper Low Indicates that paper is running low in the tray.
	Capacity	Displays the maximum capacity of the paper tray.
	Size	Displays the size of paper in the tray.
Output Tray	Status	OK Indicates that the tray is available.
		Full Indicates that the tray is not available.
	Capacity	Displays the maximum capacity of the paper tray.
Cover	Status	Closed Indicates that the cover is closed.
		Open Indicates that the cover is open.
Printer Type		Displays the type of the printer. Color Laser is displayed normally.

Printing Speed	Displays the printing speed.
-----------------------	------------------------------

Printer Events

Purpose:

When faults occur, such as *Out of Paper* or *Cover is Open*, the details of all alerts or indications of faults are displayed in the **Printer Events** page.

Values:

Location	Displays the location where a fault occurred.
Details	Displays the details of the fault.

Printer Information

Purpose:

To verify the printer details such as the hardware configuration and software version. This page can also be displayed by clicking on the **Printer Information** tab in the left frame.

Values:

Dell Service Tag Number	Displays Dell service tag number.
Express Service Code	Displays Dell express service code.
Asset Tag Number	Displays the asset tag number of the printer.
Printer Serial Number	Displays the serial number of the printer.
Memory Capacity	Displays the memory capacity.
Processor Speed	Displays the processing speed.
Printer Revision Levels	Firmware Version Displays the revision date (revision level).
	Network Firmware Version Displays the revision date (revision level).

Printer Jobs

The **Printer Jobs** menu contains information on the **Job List** and **Completed Jobs** pages. These pages show the details of the status regarding each protocol or the print jobs.

Job List

Purpose:

To confirm the print jobs that are being processed. Click the **Refresh** button to update the screen.

Values:

ID	Displays the job ID.
Job Name	Displays the file name of the job being printed.
Owner	Displays the name of job owner.
Host Name	Displays the name of the host computer.
Job Status	Displays the status of the job being printed.
Host I/F	Displays the status of the host interface.
Job Submitted Time	Displays the date when the print job was submitted.

Completed Jobs

Purpose:

To check the completed jobs. Up to the last 20 jobs are displayed. Click the **Refresh** button to update the screen.

Values:

ID	Displays the job ID.
Job Name	Displays the file name of the job.
Owner	Displays the name of job owner.
Host Name	Displays the name of the host computer.
Output Result	Displays the status of the job.
Impression Number	Displays the total number of pages for the job.
No. of Sheets	Displays the total number of sheets for the job.
Host I/F	Displays the status of the host interface.
Job Submitted Time	Displays the date when the job was submitted.

Printer Settings

Use the **Printer Settings** menu to display the **Printer Settings Report**, **Printer Settings**, and **Printer Maintenance** tabs and to configure the printer settings.

The following tabbed pages are displayed at the top of the right frame.

Printer Settings Report

The **Printer Settings Report** tab includes the **Menu Settings** and **Reports** pages.

Menu Settings

Purpose:

To display the current settings of the operator panel menus.

Values:

System Settings	Power Saver Time - Sleep	Displays the time taken by the printer to enter Sleep mode after it finishes a job.
	Power Saver Time - Deep Sleep	Displays the time taken by the printer to enter Deep Sleep mode after it has entered Sleep mode.
	Auto Reset	Displays the amount of time before the printer automatically resets the settings on the operator panel to the defaults when no additional settings are made.
	Fault Time-Out	Displays the amount of time the printer waits before canceling a job that stops abnormally.
	Job Time-Out	Displays the amount of time the printer waits for data to arrive from the computer.
	Control Panel Tone	Displays the volume of the tone that is emitted when the operator panel input is correct. Off indicates that the tone is disabled.
	Invalid Key Tone	Displays the volume of the tone that is emitted when the operator panel input is incorrect. Off indicates that the tone is disabled.

Machine Ready Tone	Displays the volume of the tone that is emitted when the printer becomes ready. Off indicates that the tone is disabled.
Job Completed Tone	Displays the volume of the tone that is emitted when a job is complete. Off indicates that the tone is disabled.
Fault Tone	Displays the volume of the tone that is emitted when a job ends abnormally. Off indicates that the tone is disabled.
Alert Tone	Displays the volume of the tone that is emitted when a problem occurs. Off indicates that the tone is disabled.
Out of Paper Tone	Displays the volume of the tone that is emitted when the printer runs out of paper. Off indicates that the tone is disabled.
Low Toner Alert Tone	Displays the volume of the tone that is emitted when the toner is low. Off indicates that the tone is disabled.
Auto Clear Alert Tone	Displays the volume of the tone that is emitted 5 seconds before the printer performs auto clear. Off indicates that the tone is disabled.
All Tones	Displays the volume of all the alert tones. Off indicates that all the tones are disabled.
mm / inch	Displays the measurement unit that is used on the operator panel screen.
Default Paper Size	Displays the default print paper size.
Auto Log Print	Displays whether to automatically print a job history report after every 20 jobs.
Print ID	Displays where to print a user ID on the output paper.
Print Text	Displays whether the printer outputs PDL (Page Description Language) data (which is not supported by the printer) as text when the printer receives it.
Banner Sheet Insert Position ^{*1}	Displays where to insert a banner sheet in the output paper.

Banner Sheet Specify Tray ^{*1}	Displays the tray to feed a banner sheet.
RAM Disk ^{*2}	Displays whether to allocate RAM for the file system for the Secure Print , and Proof Print features.
Substitute Tray	Displays if paper of another size has to be used when the paper that is loaded in the specified tray does not match the paper size setting for the current job.
Letterhead Duplex Mode ^{*3}	Displays whether to print both sides on letterhead.
Low Toner Alert Msg	Displays whether to show the alert message when the toner is low.
Panel Language	Displays the language used on the operator panel screen.
USB Settings	USB Port Displays whether to enable the USB interface.

PCL Settings	Paper Tray	Displays the paper input tray.
	Paper Size	Displays the paper size setting.
	Custom Size - Y	Displays the length of custom size paper.
	Custom Size - X	Displays the width of custom size paper.
	Orientation	Displays how text and graphics are oriented on the page.
	Font	Displays the selected font from the list of registered fonts.
	Symbol Set	Displays a symbol set for the specified font.
	Font Size	Displays the font size for scalable typographic fonts.
	Font Pitch	Displays the font pitch for scalable mono spaced fonts.
	Form Line	Displays the number of lines in a page.
	Quantity	Displays the number of copies to print.
	Image Enhancement	Displays whether to enable the Image Enhancement feature.
	Hex Dump	Displays whether to enable the Hex Dump feature.
	Draft Mode	Displays whether to print in the draft mode.
Line Termination	Displays whether to set the line termination.	
Default Color	Displays the color mode setting.	
Secure Settings	Panel Lock Set	Displays whether to lock Admin Menu with a password.
	Set Available Time	Displays whether to set the available time for the Print service.
	Start Time	Displays the start time of the available time for the Print service.
	End Time	Displays the end time of the available time for the Print service.
	Recurrence	Displays the day of the week to repeat the setting.
	Login Error - Attempts	Displays how many times an administrator can attempt to log in to Panel Lock .

Paper Density	Plain	Displays the paper density of plain paper.
	Label	Displays the paper density of labels.
Adjust BTR	Plain	Displays the voltage setting of the transfer roller (-6 to 6) for plain paper.
	Plain Thick	Displays the voltage setting of the transfer roller (-6 to 6) for thick plain paper.
	Covers	Displays the voltage setting of the transfer roller (-6 to 6) for cover paper.
	Covers Thick	Displays the voltage setting of the transfer roller (-6 to 6) for thick cover paper.
	Label	Displays the voltage setting of the transfer roller (-6 to 6) for labels.
	Coated	Displays the voltage setting of the transfer roller (-6 to 6) for coated paper.
	Coated Thick	Displays the voltage setting of the transfer roller (-6 to 6) for thick coated paper.
	Envelope	Displays the voltage setting of the transfer roller (-6 to 6) for envelopes.
	Recycled	Displays the voltage setting of the transfer roller (-6 to 6) for recycled paper.

Adjust Fuser	Plain	Displays the temperature setting of the fuser (-2 to 2) for plain paper.
	Plain Thick	Displays the temperature setting of the fuser (-2 to 2) for thick plain paper.
	Covers	Displays the temperature setting of the fuser (-2 to 2) for cover paper.
	Covers Thick	Displays the temperature setting of the fuser (-2 to 2) for thick cover paper.
	Label	Displays the temperature setting of the fuser (-2 to 2) for labels.
	Coated	Displays the temperature setting of the fuser (-2 to 2) for coated paper.
	Coated Thick	Displays the temperature setting of the fuser (-2 to 2) for thick coated paper.
	Envelope	Displays the temperature setting of the fuser (-2 to 2) for envelopes.
	Recycled	Displays the temperature setting of the fuser (-2 to 2) for recycled paper.
Auto Registration Adjustment	Displays whether to automatically perform color registration adjustment.	
Adjust Altitude	Displays the altitude of the location where the printer is installed.	
Non-Dell Toner	Displays whether to use toner cartridge of another manufacturer.	
Clock Settings	Date Format	Displays the default date format.
	Time Format	Displays the default time format; 24H or 12H.
	Time Zone	Displays the default time zone.
	Set Date	Displays the date setting.
	Set Time	Displays the time setting.

Web Link Customization	Select Reorder URL	Displays a link used for ordering consumables, which can be accessed from Order Supplies at: in the left frame.
	Regular	Displays the regular URL (http://accessories.us.dell.com/sna) that can be linked to Order Supplies at: .
	Premier	Displays the premier URL (http://premier.dell.com) that can be linked to Order Supplies at: .
Dell ColorTrack	ColorTrack Mode	Displays whether to enable the ColorTrack.
	No Account User Print	Displays whether to permit the printing of data without authentication information.
	ColorTrack Error Report	Displays whether to print the error report on the ColorTrack mode.
Tray Settings	Tray 1 Paper Size	Displays the paper size setting of the standard 250-sheet tray.
	Tray 1 Paper Type	Displays the paper type setting of the standard 250-sheet tray.
	Tray 1 Custom Size - Y	Displays the length of custom size paper loaded in the standard 250-sheet tray.
	Tray 1 Custom Size - X	Displays the width of custom size paper loaded in the standard 250-sheet tray.
	Tray 1 Display Popup	Displays whether to show a popup menu that prompts the user to set the paper size and type when the paper is loaded in the standard 250-sheet tray.
	Tray 2 Paper Size^{*4}	Displays the paper size setting of the optional 250-sheet feeder.
	Tray 2 Paper Type^{*4}	Displays the paper type setting of the optional 250-sheet feeder.
	Tray 2 Display Popup^{*4}	Displays whether to show a popup menu that prompts the user to set the paper size and type when the paper is loaded in the optional 250-sheet feeder.

-
- *1 This item is available only when the optional 250-sheet feeder is installed to Dell 2150cdn Color Printer.
 - *2 This item is available only when the optional 512 MB memory module is installed.
 - *3 This item is available only for Dell 2150cdn Color Printer.
 - *4 This item is available only when the optional 250-sheet feeder is installed.
-

Reports

Purpose:

To print various types of reports and lists.

Values:

Printer Settings	Click the Start button to print the Printer Settings page.
Panel Settings	Click the Start button to print the Panel Settings page.
PCL Fonts List	Click the Start button to print the PCL (Hewlett-Packard Printer Control Language) Fonts List.
PCL Macro List	Click the Start button to print the PCL Macro List.
Job History	Click the Start button to print the Job History report.
Error History	Click the Start button to print the Error History report.
Print Meter	Click the Start button to print the Print Meter report.
Color Test Page	Click the Start button to print the Color Test Page.
Stored Documents ^{*1}	Click the Start button to print the Stored Documents list.

-
- *1 This item is available only when RAM disk is enabled
-

Printer Settings

The **Printer Settings** tab includes **System Settings**, **USB Settings**, **PCL Settings**, and **Secure Settings** pages.

System Settings

Purpose:

To configure the basic printer settings.

Values:

Power Saver Time - Sleep	Sets the time taken by the printer to enter Sleep mode after it finishes a job.
Power Saver Time - Deep Sleep	Sets the time taken by the printer to enter Deep Sleep mode after it has entered Sleep mode.
Auto Reset	Sets the amount of time before the printer automatically resets the settings on the operator panel to the defaults when no additional settings are made.
Fault Time-Out	Sets the amount of time the printer waits before canceling a job that stops abnormally.
Job Time-Out	Sets the amount of time the printer waits for data to arrive from the computer.
Control Panel Tone	Sets the volume of the tone that is emitted when the operator panel input is correct, or disables the tone.
Invalid Key Tone	Sets the volume of the tone that is emitted when the operator panel input is incorrect, or disables the tone.
Machine Ready Tone	Sets the volume of the tone that is emitted when the printer becomes ready, or disables the tone.
Job Completed Tone	Sets the volume of the tone that is emitted when a job is complete, or disables the tone.
Fault Tone	Sets the volume of the tone that is emitted when a job ends abnormally, or disables the tone.
Alert Tone	Sets the volume of the tone that is emitted when a problem occurs, or disables the tone.
Out of Paper Tone	Sets the volume of the tone that is emitted when the printer runs out of paper, or disables the tone.
Low Toner Alert Tone	Sets the volume of the tone that is emitted when the toner is low, or disables the tone.
Auto Clear Alert Tone	Sets the volume of the tone that is emitted 5 seconds before the printer performs auto clear, or disables the tone.
All Tones	Sets the volume of all the alert tones, or disables all the tones.

mm / inch	Sets the measurement unit to be used on the operator panel screen as either mm or inches.
Default Paper Size	Sets the default print paper size.
Auto Log Print	Specifies if a job history needs to be printed after every 20 jobs.
Print ID	Sets where to print the user ID on the output paper.
Print Text	Sets whether the printer outputs PDL data (which is not supported by the printer) as text when the printer receives it.
Banner Sheet Insert Position ^{*1}	Sets where to insert a banner sheet in the output.
Banner Sheet Specify Tray ^{*1}	Sets from which tray a banner sheet is fed.
RAM Disk ^{*2}	Sets whether to allocate RAM for the file system for the Secure Print and Store Print features.
Substitute Tray	Sets whether to use another size paper when the paper that is loaded in the specified tray does not match the paper size settings for the current job.
Letterhead Duplex Mode ^{*3}	Sets whether to print on both sides of letterhead.
Low Toner Alert Msg	Alerts you if the toner is low.
Panel Language	Used to set the language on the operator panel.
<p>^{*1} This item is available only when the optional 250-sheet feeder is installed to Dell 2150cdn Color Printer.</p> <p>^{*2} This item is available only when the optional 512 MB memory module is installed.</p> <p>^{*3} This item is available only for Dell 2150cdn Color Printer.</p>	

USB Settings

Purpose:

To change USB settings on your printer.

Values:

USB Port Enables USB interface on your printer.

PCL Settings

Purpose:

To change the PCL settings.

Values:

Paper Tray	Sets the paper input tray.
Paper Size	Sets the paper size.
Custom Size - Y	Sets the length of custom size paper. The available range is from 127 mm (5.0 inch) to 355 mm (14.0 inch).
Custom Size - X	Sets the width of custom size paper. The available range is from 77 mm (3.0 inch) to 215 mm (8.5 inch).
Orientation	Sets how text and graphics are oriented on the page.
Font	Sets the font from the list of registered fonts.
Symbol Set	Sets a symbol set for the specified font.
Font Size	Sets the font size for scalable typographic fonts.
Font Pitch	Sets the font pitch for scalable mono spaced fonts.
Form Line	Sets the number of lines in a page.
Quantity	Sets the number of copies to print.
Image Enhancement	Sets whether to enable the Image Enhancement feature.
Hex Dump	Sets whether to help isolate the source of a print job problem. With Hex Dump selected, all data sent to the printer is printed in hexadecimal and character representation. Control codes are not executed.
Draft Mode	Sets whether to print in the draft mode.
Line Termination	Sets how to handle line terminations.
Default Color	Sets the print color mode as Color or Black . This setting is used for print jobs without a specified color print mode.

Secure Settings

Panel Lock

Purpose:

To set a limited access to Admin Menu with a password, and to set or change the password.

Set the password of the **Dell Printer Configuration Web Tool** from **Set Password** in **Print Server Settings**.

Values:

Panel Lock Set	Enables/Disables password protection for the Admin Menu.
New Password	Sets a password that is required to access the Admin Menu.
Re-enter Password	Confirms the set password.



NOTE: This menu sets a password to lock the operator panel. When you change the password for the **Dell Printer Configuration Web Tool**, click **Set Password** on the left frame and set the password.

Login Error

Purpose:

To specify how many times an administrator can attempt to log in to **Panel Lock**.

Values:

Login Attempts	Displays how many times an administrator can attempt to log in to Panel Lock .
-----------------------	---

Set Available Time

Purpose:

To specify the time to enable the secure setting for the Print service.

Values:

Set Available Time	Allows you to set the available time period for the Print service.
Start Time	Sets the start time of the available time period for the Print service.
End Time	Sets the end time of the available time period the Print service.
Recurrence	Sets the day of the week to repeat the setting.

Secure Job Expiration



NOTE: Secure Job Expiration feature is available only when the optional 512 MB memory module is installed.

Purpose:

To specify the date and time to delete the files stored as Secure Print in the RAM disk.

Values:

Expiration Mode	Allows you to set the date to delete the files stored as Secure Print in the optional 512 MB memory module.
Expiration Time	Sets the time to delete the files stored as Secure Print in the optional 512 MB memory module.
Recurrence	Sets the period to repeat the setting.
Weekly Settings	Sets the day of the week to repeat the setting.
Monthly Settings	Sets the day of the month to repeat the setting.

Printer Maintenance

The **Printer Maintenance** tab includes the **Paper Density, Adjust BTR, Adjust Fuser, Auto Registration Adjustment, Color Registration Adjustments, Clean Developer, Reset Defaults, Initialize PrintMeter, Storage, Non-Dell Toner, Adjust Altitude, Clock Settings, and Web Link Customization** pages.

Paper Density

Purpose:

To specify the paper density.

Values:

Plain	Sets the density of plain paper to Light or Normal .
Label	Sets the density of labels to Light or Normal .

Adjust BTR

Purpose:

To specify the reference voltage settings for the transfer roller.

Values:

Plain	Sets the reference voltage setting for the transfer roller for plain paper within the range of -6 to 6.
Plain Thick	Sets the reference voltage setting for the transfer roller for thick plain paper within the range of -6 to 6.
Covers	Sets the reference voltage setting for the transfer roller for cover paper within the range of -6 to 6.
Covers Thick	Sets the reference voltage setting for the transfer roller for thick cover paper within the range of -6 to 6.
Label	Sets the reference voltage setting for the transfer roller for labels within the range of -6 to 6.
Coated	Sets the reference voltage setting for the transfer roller for coated paper within the range of -6 to 6.
Coated Thick	Sets the reference voltage setting for the transfer roller for thick coated paper within the range of -6 to 6.
Envelope	Sets the reference voltage setting for the transfer roller for envelopes within the range of -6 to 6.
Recycled	Sets the reference voltage setting for the transfer roller for recycled paper within the range of -6 to 6.

Adjust Fuser

Purpose:

To specify the temperature settings value for the fuser.

Values:

Plain	Sets the temperature settings for the fuser for plain paper within the range of -2 to 2.
Plain Thick	Sets the temperature settings for the fuser for thick plain paper within the range of -2 to 2.

Covers	Sets the temperature settings for the fuser for cover paper within the range of -2 to 2.
Covers Thick	Sets the temperature settings for the fuser for thick cover paper within the range of -2 to 2.
Label	Sets the temperature settings for the fuser for labels within the range of -2 to 2.
Coated	Sets the temperature settings for the fuser for coated paper within the range of -2 to 2.
Coated Thick	Sets the temperature settings for the fuser for thick coated paper within the range of -2 to 2.
Envelope	Sets the temperature settings for the fuser for envelopes within the range of -2 to 2.
Recycled	Sets the temperature settings for the fuser for recycled paper within the range of -2 to 2.

Auto Registration Adjustment

Purpose:

To specify whether to automatically perform color registration adjustment.

Color Registration Adjustments

Purpose:

To specify whether to manually perform color registration adjustment.

Manual Color Registration Adjustments are required such as when the printer is initially installed and after the printer is moved.



NOTE: The **Color Registration Adjustments** feature can be configured when **Auto Registration Adjustment** is set to **Off**.

Values:

Auto Correct	Click the Start button to automatically perform color registration correction.
---------------------	---

Color Regi Chart	Click the Start button to print a color registration chart. The color registration chart prints a lattice pattern of yellow, magenta, and cyan lines. On the chart, look at the values on the right side that are next to the line that is perfectly straight for each of the three colors. If the value for the this line is 0, color registration adjustment is not required. If the value for this line is any value other than 0, specify the adjustment values under Color Registration Adjustments .
Color Registration Adjustments	Sets lateral (perpendicular to paper feed direction) and process (paper feed direction) color adjustment values individually for Yellow, Magenta, and Cyan within the range of -9 to 9.

Clean Developer

Purpose:

To clean each toner cartridge or PHD unit, or to stir the toner in a new toner cartridge.

Values:

Clean Developer	Stirs the toner in a new toner cartridge.
Yellow Toner Refresh	Cleans the toner in the yellow toner cartridge.
Magenta Toner Refresh	Cleans the toner in the magenta toner cartridge.
Cyan Toner Refresh	Cleans the toner in the cyan toner cartridge.
Black Toner Refresh	Cleans the toner in the black toner cartridge.
Drum Refresh	Cleans the surface of the PHD unit.

Reset Defaults

Purpose:

To initialize wired network data stored in non-volatile memory (NVM). After executing this function and rebooting the printer, all wired network settings are reset to their default values.

Reset Defaults and restart printer.	Click the Start button to reset the system parameters.
--	---

Initialize PrintMeter

Purpose:

To initialize the print meter of the printer. When the print meter is initialized, the meter count is reset to 0.

Storage



NOTE: Storage feature is available only when the optional 512 MB memory module is installed.

Purpose:

To clear all files stored in the optional 512 MB memory module.

Values:

Clear Storage	All Clear	Click the Start button to clear all files stored as Secure Print and Proof Print in the optional 512 MB memory module.
	Secure Document	Click the Start button to clear all files stored as Secure Print in the optional 512 MB memory module.
	Stored Document	Click the Start button to clear all files stored in the optional 512 MB memory module.

Non-Dell Toner

Purpose:

To use toner cartridge of another manufacturer.



NOTICE: Using a non-Dell toner cartridge may severely damage your printer. The warranty does not cover damages caused by using non-Dell toner cartridges.

Adjust Altitude

Purpose:

To specify the altitude of the location where the printer is installed.

The discharge phenomenon for charging the photo conductor varies with barometric pressure. Adjustments are performed by specifying the altitude of the location where the printer is being used.

Clock Settings

Purpose:

To specify the clock settings.

Values:

Date Format	Sets the date format; yy/mm/dd, mm/dd/yy, or dd/mm/yy.
Time Format	Sets the time format; 24H or 12H.
Time Zone	Sets the time zone.
Set Date	Sets the current date.
Set Time	Sets the current time.

Web Link Customization

Purpose:

To specify a link used for ordering consumables, which can be accessed from **Order Supplies at:** in the left frame.

Values:

Select Reorder URL	Sets a URL to be linked to Order Supplies at:
Regular	Displays the regular URL (http://accessories.us.dell.com/sna) that can be linked to Order Supplies at: .
Premier	Displays the premier URL (http://premier.dell.com) that can be linked to Order Supplies at: .

Print Server Settings

Use the **Print Server Settings** menu to set the type of printer interface and the necessary conditions for communication.

The following tabbed pages are displayed in the top of the right frame.

Print Server Reports

The **Print Server Reports** tab includes the **Print Server Setup Page** and the **E-Mail Alert Setup Page**.

Print Server Setup Page

Purpose:

To verify the current settings of TCP/IP (Transmission Control Protocol/Internet Protocol) protocol and printing ports. On this page, you can only verify the settings of items. If you want to change the settings, go to the pages in the **Print Server Settings** tab.

Values:

Ethernet ^{*1}	Ethernet Settings	Displays the current settings of Ethernet transmission rate and the duplex settings.
	Current Ethernet Settings	Displays the current Ethernet settings.
	MAC Address	Displays the Media Access Control Address (MAC) address of the printer.
Wireless Settings ^{*2}	SSID	Displays the MAC address of the printer.
	Network Type	Displays the name that identifies the network.
	MAC Address	Displays the network type from either the Ad-Hoc or Infrastructure mode.
	Link Channel	Displays the MAC address of the wireless printer adapter.
	Link Quality	Displays the channel number of the connection.

TCP/IP Settings	IP Mode	Displays the IP mode.	
	Host Name	Displays the host name.	
	IPv4^{*3}	IP Address Mode	Displays the IP address mode.
		IP Address	Displays the IP address.
		Subnet Mask	Displays the subnet mask.
		Gateway Address	Displays the gateway address.
	IPv6^{*4}	Enable Stateless Address	Displays whether to enable the stateless address.
		Use Manual Address	Displays whether to set the IP address manually.
		Manual Address^{*5}	Displays the IP address.
		Stateless Address 1-3^{*6}	Displays the stateless addresses.
		Link Local Address^{*6}	Displays the link local address.
		Manual Gateway Address^{*5}	Displays the gateway address.
		Auto Configure Gateway Address^{*6}	Displays the gateway address.

DNS	IPv4 ^{*3}	Get DNS Server Address from DHCP	Displays whether to automatically set the DNS server address via DHCP.
		Current DNS Server Address	Displays the current DNS server address.
		IPv6 ^{*4}	Get DNS Server Address from DHCPv6-lite
	Current DNS Server Address	Displays the current DNS server address.	
	Priority to IPv6 DNS Name Resolution ^{*7}	Displays whether to use the DNS Name Resolution feature.	
	WINS	WINS Mode	Displays whether to automatically set the primary and secondary WINS server addresses via DHCP.
WINS Primary Server		Displays the primary WINS server address.	
WINS Secondary Server		Displays the secondary WINS server address.	
LPD	Port Status	Displays the port status of the Line Printer Daemon (LPD) protocol.	
	Connection Time-Out	Displays the connection time-out period.	
Port9100	Port Status	Displays the port status.	
	Port Number	Displays the port number.	
	Connection Time-Out	Displays the connection time-out period.	

IPP	Port Status	Displays the port status.
	Printer URI	Displays the printer URI.
	Connection Time-Out	Displays the connection time-out period.
	Port Number	Displays the port number.
	Maximum Sessions	Displays the maximum number of connections received simultaneously by the client.
WSD	Port Status	Displays the WSD port status.
	Port Number	Displays the WSD port number.
	Receive Time-Out	Displays the receive time-out period.
	Notification Time-Out	Displays the notification time-out period.
	Maximum Number of TTL	Displays the maximum number of TTLs.
	Maximum Number of Notification	Displays the maximum number of notifications.
HTTP	Port Status	Displays the port status.
	Port Number	Displays the port number.
	Simultaneous Connections	Displays the maximum number of simultaneous connections.
	Connection Time-Out	Displays the connection time-out period.

SMB	Port Status	Displays the port status.
	Host Name	Displays the host name.
	Workgroup	Displays the workgroup.
	Maximum Sessions	Displays the maximum number of sessions.
	Unicode Support	Displays whether to notify the host name and workgroup name in Unicode characters during SMB transmission.
	Auto Master Mode	Displays whether to enable the Auto Master Mode.
	Encrypt Password	Displays whether to encrypt the password during SMB transmission.
	Job Time-Out	Displays the job time-out period.
	Connection Time-Out	Displays the connection time-out period.
Bonjour (mDNS)	Port Status	Displays the port status.
	Host Name	Displays the host name.
	Printer Name	Displays the printer name.
Telnet	Port Status	Displays the port status.
	Connection Time-Out	Displays the connection time-out period.
SNMP	Port Status	Displays the port status.
	Enable SNMP v1/v2c Protocol	Displays the status of the SNMP v1/v2c feature.
	Enable SNMP v3 Protocol	Displays the status of the SNMP v3 feature.
LLTD	Port Status	Displays the port status.
SSL/TLS	HTTP - SSL/TLS Communication	Displays the status of the HTTP - SSL/TLS Communication.
	HTTP - SSL/TLS Communication Port Number	Displays HTTP - SSL/TLS Communication Port Number.

IPsec Settings	Protocol	Displays the protocol status.
	IKE	Displays IKE authentication.
802.1x ^{*1}	Enable IEEE 802.1x	Displays the status of IEEE 802.1x.
	Authentication Method	Displays the setting of authentication method for IEEE 802.1x.
IP Filter (IPv4) ^{*8}	Access List	Displays the list of IP addresses that are permitted or denied access to the printer.

^{*1} This item is available only when the printer is connected using LAN cable.

^{*2} This item is available only when the printer is connected using the wireless network

^{*3} This item is displayed when IPv4 Mode is selected.

^{*4} This item is displayed when IPv6 Mode is selected.

^{*5} This item is displayed only when **Use Manual Address** is set to **Enable**.

^{*6} This item is displayed only when an IP address has been assigned.

^{*7} This item is available only when using IPv6 dual mode.

^{*8} This item is available only for **LPD** or **Port9100**.

E-Mail Alert Setup Page

Purpose:

To verify the current settings of SMTP/POP (Simple Mail Transfer Protocol/Post Office Protocol) used for the e-mail feature and E-Mail Alerts feature. In this page, you can only verify the settings of items. If you want to change the settings, go to the pages in the **Print Server Settings** tab.

Values:

E-Mail Server Settings	Port Status	Displays the port status.	
	Primary SMTP Gateway	Displays the primary SMTP (Simple Mail Transfer Protocol) gateway.	
	SMTP Port Number	Displays the SMTP port number.	
	E-Mail Send Authentication	Displays the authentication method for outgoing e-mail.	
	POP3 Server Address	Displays the POP3 (Post Office Protocol 3) server address.	
	POP3 Port Number	Displays the POP3 port number.	
	Reply Address	Displays the IP address of servers connected with SMTP protocol when data is incoming.	
	SMTP Server Connection	Displays the status of the SMTP server connection.	
E-Mail Alert Settings	E-Mail List 1	Displays the acceptable e-mail addresses for the E-Mail Alert feature specified in E-Mail List 1 .	
	Select Alerts for List 1	Supplies Alerts	Displays the e-mail alert receive status for consumables.
		Paper Handling Alerts	Displays the e-mail alert receive status for paper handling.
		Service Call	Displays the e-mail alert receive status for service calls.
	E-Mail List 2	Displays the acceptable e-mail addresses for the E-Mail Alert feature specified in E-Mail List 2 .	
	Select Alerts for List 2	Supplies Alerts	Displays the e-mail alert receive status for consumables.
		Paper Handling Alerts	Displays the e-mail alert receive status for paper handling.
		Service Call	Displays the e-mail alert receive status for service calls.

Print Server Settings

The **Print Server Settings** tab includes the **Basic Information**, **Port Settings**, **TCP/IP**, **SMB**, **E-Mail Alert**, **Bonjour (mDNS)**, **SNMP**, **LLTD**, **Wireless LAN**, and **Reset Print Server** pages.

Basic Information

Purpose:

To configure the basic information of the printer.

Values:

System Settings	Printer Name	Sets the name of the printer.
	Location	Sets the location of the printer.
	Contact Person	Sets the contact name, number, and other information of the printer administrator and service center.
	Administrator E-Mail Address	Sets the contact address of the printer administrator and service center.
	Asset Tag Number	Enters the asset tag number for the printer.
EWS Settings	Auto Refresh	Automatically refreshes the contents of the status display pages.
	Auto Refresh Interval	Sets the time interval for refreshing the contents of the status display pages automatically from 15 to 600 seconds.



NOTE: The **Auto Refresh** feature is effective for the contents of the top frame, **Printer Status** page, **Job List** page, and **Completed Jobs** page.

Port Settings

Purpose:

To enable or disable printing ports and management protocol features.

Values:

Ethernet ^{*1}	Ethernet Settings	Auto	Detects the Ethernet transmission rate and the duplex settings automatically.
		10BASE-T Half-Duplex	Selects 10Base-T Half-Duplex as the default value.
		10BASE-T Full-Duplex	Selects 10Base-T Full-Duplex as the default value.
		100BASE-TX Half-Duplex	Selects 100Base-TX Half-Duplex as the default value.
		100BASE-TX Full-Duplex	Selects 100Base-TX Full-Duplex as the default value.
		1000BASE-T Full-Duplex	Selects 1000Base-T Full-Duplex as the default value.
		Current Ethernet Settings	Displays the current settings of the Ethernet.
	MAC Address	Displays the MAC address of the printer.	
Port Status	LPD	Sets whether to enable LPD.	
	Port9100	Sets whether to enable Port9100.	
	IPP	Sets whether to enable IPP.	
	WSD	Sets whether to enable WSD.	
	SMB	Sets whether to enable SMB.	
	Bonjour (mDNS)	Sets whether to enable Bonjour (mDNS).	
	E-Mail Alert	Sets whether to enable E-Mail Alert.	
	Telnet	Sets whether to enable Telnet.	
	SNMP	Sets whether to enable SNMP.	
	LLTD	Sets whether to enable LLTD.	

^{*1} This item is available only when the printer is connected using LAN cable.



NOTE: The settings in the **Port Settings** page will be valid only when the printer is rebooted. When you change or configure the settings, click the **Apply New Settings** button to apply the new settings.

TCP/IP

Purpose:

To configure the IP address, subnet mask, and gateway address of the printer.

Values:

TCP/IP Settings	IP Mode	Sets the IP mode.	
	Host Name	Sets the host name.	
	IPv4	IP Address Mode	Sets the method for acquiring the IP address.
	Manual IP Address	When an IP address is being set manually, the IP is allocated to the printer using the format nnn.nnn.nnn.nnn. Each octet that makes up nnn.nnn.nnn.nnn is a value in the range of 0 to 254. 127 and any value in the range of 224 to 254 cannot be specified for the first octet of a gateway address.	
	Manual Subnet Mask	When an IP address is being set manually, the subnet mask is specified using the format nnn.nnn.nnn.nnn. Each octet that makes up nnn.nnn.nnn.nnn is a value in the range of 0 to 255. 255.255.255.255 cannot be specified as the subnet mask.	
Manual Gateway Address	When an IP address is being set manually, the gateway address is specified using the format nnn.nnn.nnn.nnn. Each octet that makes up nnn.nnn.nnn.nnn is a value in the range of 0 to 254. 127 and any value in the range of 224 to 254 cannot be specified for the first octet of a gateway address.		

IPv6	Enable Stateless Address	Select the check box to enable the stateless address.	
	Use Manual Address	Select the check box to set the IP address manually.	
	Manual Address	Sets the IP address. To specify an IPv6 address, enter the address followed by a slash (/) and then "64". For details, contact your system administrator.	
	Manual Gateway Address	Sets the gateway address.	
DNS	DNS Domain Name	Sets the DNS domain name.	
	IPv4	Get DNS Server Address from DHCP	Allows you to enable or disable the automatic setting of the DNS server address via DHCP.
		Manual DNS Server Address	Manually sets the DNS server address in xxx.xxx.xxx.xxx format when Get DNS Server Address from DHCP is not selected.
IPv6	Get DNS Server Address from DHCPv6-lite	Select the check box to get the DNS server address automatically from the DHCPv6-lite server.	
	Manual DNS Server Address	Sets the DNS server address.	
	Priority to IPv6 DNS Name Resolution	Select the check box to enable the DNS Name Resolution feature.	

WINS	WINS Mode	Allows you to enable or disable the automatic setting of the primary and secondary WINS server addresses via DHCP.
	WINS Primary Server	Manually sets the primary WINS server address in xxx.xxx.xxx.xxx format when WINS Mode is not selected.
	WINS Secondary Server	Manually sets the secondary (backup) WINS server address in xxx.xxx.xxx.xxx format when WINS Mode is not selected.
LPD	Connection Time-Out	Sets the connection time-out period from 1 to 1,000 seconds.
	IP Filter (IPv4)	Click IP Filter (IPv4) to set the IP Filter settings on the IP Filter (IPv4) page.
Port9100	Port Number	Sets the port number from 9,000 to 9,999.
	Connection Time-Out	Sets the connection time-out period between 1 and 1,000 seconds.
	IP Filter (IPv4)	Click IP Filter (IPv4) to set the IP filter settings on the IP Filter (IPv4) page.
IPP	Printer URI	Displays the printer URI.
	Connection Time-Out	Sets the connection time-out period from 1 to 1,000 seconds.
	Port Number	Displays the port number for receiving requests from the client.
	Maximum Sessions	Displays the maximum number of connections received simultaneously by the client.
WSD	Port Number	Sets the port number to 80 or from 8,000 to 9,999.
	Receive Time-Out	Sets the receive time-out period from 1 to 65,535 seconds.
	Notification Time-Out	Sets the notification time-out period from 1 to 60 seconds.
	Maximum Number of TTL	Sets the maximum number of TTL from 1 to 10.
	Maximum Number of Notification	Sets the maximum number of notifications from 10 to 20.

HTTP	Port Number	Sets the port number to 80 or from 8,000 to 9,999.
	Simultaneous Connections	Displays the maximum number of simultaneous connections.
	Connection Time-Out	Sets the connection time-out period from 1 to 255 seconds.
Telnet	Password	Sets the password for Telnet.
	Re-enter Password	Confirms the set password.
	Connection Time-Out	Sets the connection time-out period from 1 to 1,000 seconds.

To configure the IP Filter feature, enter an IP address to be filtered in the Address field and the Subnet Mask in the Address Mask field. Enter a numeric value between 0 and 255 in each field. "*" is appended to the current value.

IP Filter Setup Procedure

You can set up to a maximum of five items and the first item set takes priority. When setting multiple filters, enter the shortest address first followed by a slightly longer address, a longer address and so on.

Enabling Printing From a Specified User

The following describes the procedure to enable printing only from the "192.168.100.10" IP address.

- 1 Click the first column of the **Access List** row **1**.
- 2 Enter "192.168.100.10" in the **Address** field and "255.255.255.255" in the **Address Mask** field.
- 3 Select **Permit**.
- 4 Click **Apply New Settings**.

Disabling Printing From a Specified User

The following describes the procedure to disable printing only from the "192.168.100.10" IP address.

- 1 Click the first column of the **Access List** row **1**.
- 2 Enter "192.168.100.10" in the **Address** field and "255.255.255.255" in the **Address Mask** field.
- 3 Select **Reject**.

- 4 Click the first column of the **Access List** row **2**.
- 5 Enter "0.0.0.0" in the **Address** field and "0.0.0.0" in the **Address Mask** field.
- 6 Select **Permit**.
- 7 Click **Apply New Settings**.

Enabling and Disabling Printing from Network Addresses

You can enable printing from the "192.168" network address and disable printing from the "192.168.200" network address.

The example below describes how to enable printing from the "192.168.200.10" IP address.

- 1 Click the first column of the **Access List** row **1**.
- 2 Enter "192.168.200.10" in the **Address** field and "255.255.255.255" in the **Address Mask** field.
- 3 Select **Permit**.
- 4 Click the first column of the **Access List** row **2**.
- 5 Enter "192.168.200.0" in the **Address** field and "255.255.255.0" in the **Address Mask** field.
- 6 Select **Reject**.
- 7 Click the first column of the **Access List** row **3**.
- 8 Enter "192.168.0.0" in the **Address** field and "255.255.0.0" in the **Address Mask** field.
- 9 Select **Permit**.
- 10 Click **Apply New Settings**.

SMB

Purpose:

To specify the setting of the Server Message Block (SMB) protocol.

Values:

Host Name	Sets the host name of the server computer.
Workgroup	Sets the workgroup.

Maximum Sessions	Sets the maximum number of sessions.
Unicode Support	Sets whether to notify the host name and workgroup name in Unicode characters during SMB transmission.
Auto Master Mode	Sets whether to enable the Auto Master Mode.
Encrypt Password	Sets whether to encrypt the password.
Job Time-Out	Sets the job time-out period between 60 and 3,600 seconds.
Connection Time-Out	Sets the connection time-out period between 60 and 3,600 seconds.

E-Mail Alert

Purpose:

To configure detailed settings for the **E-Mail Alert**. This page can also be displayed by clicking the **E-Mail Alert** in the left frame.

Values:

E-Mail Server Settings	Primary SMTP Gateway	Sets the primary SMTP gateway.
	SMTP Port Number	Sets the SMTP port number. This must be 25, 587 or between 5,000 and 65,535.
	E-Mail Send Authentication	Sets the authentication method for outgoing e-mail.
	SMTP Login User	Sets the SMTP login user. Up to 63 alphanumeric characters, periods, hyphens, underscores, and at symbols (@) can be used. If specifying more than one address, separate them using commas.
	SMTP Login Password	Sets the SMTP account password using up to 31 alphanumeric characters.
	Re-enter SMTP Login Password	Confirms the set SMTP account password.
	POP3 Server Address*¹	Sets the POP3 server address in IP address format of "aaa.bbb.ccc.ddd" or as a DNS host name using up to 63 characters.
	POP3 Port Number*¹	Sets the POP3 server port number. This must be 110 or between 5,000 and 65,535.
	POP User Name*¹	Sets the POP3 account user name. Up to 63 alphanumeric characters, periods, hyphens, underscores, and at symbols (@) can be used. If specifying more than one address, separate them using commas.
	POP User Password*¹	Sets the POP3 account password using up to 31 alphanumeric characters.
	Re-enter POP User Password*¹	Confirms the set password.
	Reply Address	Designates the reply e-mail address sent with each E-mail Alert.
	SMTP Server Connection	Displays the status of the SMTP server connection.

E-Mail Alert Settings	E-Mail List 1	Sets acceptable e-mail addresses for the E-Mail Alert feature using up to 255 alphanumeric characters.
	Select Alerts for List 1	Supplies Alerts Select the check box to receive an E-Mail Alert for consumables.
		Paper Handling Alerts Select the check box to receive an E-Mail Alert for paper handling.
		Service Call Select the check box to receive an E-Mail Alert for Service Calls.
	E-Mail List 2	Sets acceptable e-mail addresses for the E-Mail Alert feature using up to 255 alphanumeric characters.
	Select Alerts for List 2	Supplies Alerts Select the check box to receive an E-Mail Alert for consumables.
		Paper Handling Alerts Select the check box to receive an E-Mail Alert for paper handling.
		Service Call Select the check box to receive an E-Mail Alert for Service Calls.

*1 This item is available only when **POP before SMTP (Plain)** or **POP before SMTP (APOP)** for **E-Mail Send Authentication** is selected.

Bonjour (mDNS)

Purpose:

To configure the detailed settings of Bonjour.

Host Name	Sets the host name up to 63 alphanumeric characters and "-" (dash). The original setting will remain valid if no input is made.
------------------	---

Printer Name	Sets the printer name up to 63 alphanumeric characters and symbol sets. The original setting will remain valid if no input is made.
---------------------	---

SNMP

Purpose:

To configure the detailed settings of SNMP.

Values:

SNMP Configuration	Enable SNMP v1/v2c Protocol	Select the check box to enable the SNMP v1/v2c protocol.
	Edit SNMP v1/v2c Properties	Click to display SNMP v1/v2c page and to edit the setting of SNMP v1/v2c protocol from the page.
	Enable SNMP v3 Protocol	Select the check box to enable the SNMP v3 protocol.
	Edit SNMP v3 Properties	Click to display SNMP v3 page and to edit the setting of SNMP v3 protocol from the page. You can click this item only when SSL communication is enabled.

SNMP v1/v2c

Purpose:

To edit the detailed settings of SNMP v1/v2 protocol.

To enter this page, click **Edit SNMP v1/v2 Properties** in the **SNMP** page.

Values:

Community Name	Community Name (Read only)^{*1}	Sets the community name to access (read only) data using up to 31 alphanumeric characters. The original setting will remain valid if no input is made. Characters entered for community name in the previous settings will not be displayed on the screen. The default Read Community is public.
-----------------------	--	--

Re-enter Community Name (Read only)*1	Enters the community name to access (read only) data again to confirm it.
Community Name (Read/Write)*1	Sets the community name to access (read and write) data using up to 31 alphanumeric characters. The original setting will remain valid if no input is made. Characters entered for community name in the previous settings will not be displayed on the screen. The default Read/Write Community is private.
Re-enter Community Name (Read/Write)*1	Enters the community name to access (read and write) data again to confirm it.
Community Name (Trap)*1	Sets the community name used for trap up to 31 alphanumeric characters. The original setting will remain valid if no input is made. Characters entered for Community Name (Trap) in the previous settings will not be displayed on the screen. The default Trap Community is " " (NULL).
Re-enter Community Name (Trap)*1	Enters the community name used for trap again to confirm it.

Trap Notification 1-4	Trap Address Type	Select the check boxes to notify trap occurrence. In this case, specify the IP address and IP socket in the following format:
	Trap Address Port Number Notify	IPv4 Specify the IP address and IP socket in the nnn.nnn.nnn.nnn:mmmmm format. Each section of "nnn" is a variable value between 0 and 255. Note that values 127 and 224-254 are not valid for the first three-digits only. IP socket mmmm is a variable value between 0 and 65,535. IPv6 Specify the IP address and IP socket in the xxxx:xxxx:xxxx:xxxx:xxxx:xxxx:xxxx:xxxx:mmmm mm format. Each section of "xxxx" is a hexadecimal variable value between 0 and ffff. IP socket mmmm is a variable value between 0 and 65,535.
	Authenticate Error Trap	Select the check box to notify Authenticate Error Trap.

*1 The default value can be changed by using **Dell Printer Configuration Web Tool**.

SNMP v3

Purpose:

To edit the detailed settings of SNMP v3 protocol. To enter this page, click **Edit SNMP v3 Properties** in the **SNMP** page.

Values:

Administrator Account	Account Enabled	Select the check box to enable the administrator account.
	User Name	Enters the user name of the administrator account.
	Authentication Password	Sets the authentication password of the administrator account using 8 to 32 alphanumeric characters.
	Re-enter Authentication Password	Confirms the set password.
	Privacy Password	Sets the privacy password of the administrator account using 8 to 32 alphanumeric characters.
	Re-enter Privacy Password	Confirms the set password.
Print Drivers / Remote Client Account	Account Enabled	Select the check box to enable the print drivers and remote client account.
	Reset to default Password	Click to reset the password for the print drivers and remote client account to default.

LLTD

Purpose:

To specify the maximum number of devices.

Values:

Maximum number of Device	Sets the maximum number of device from 64 to 1,024.
---------------------------------	---

Wireless LAN



NOTE: Wireless LAN feature is available only when the printer is connected using the wireless network.

Purpose:

To configure the detailed setting for the wireless network. To use the wireless adapter, be sure to disconnect the network cable.



NOTE: Once wireless LAN is activated, wired LAN protocol will be disabled.

Values:

Wireless Settings	SSID	Sets the name that identifies the wireless network. Up to 32 alphanumeric characters can be entered.
	Network Type	Sets the network type from either Ad-Hoc or Infrastructure .
	MAC Address	Displays the MAC address of the wireless adapter for the printer.
	Link Channel	Displays the channel number of the wireless connection for the printer.
	Link Quality	Displays the quality of the wireless network connection for the printer.
Security Settings	Encryption	Select the security method from the list.
	No Security	Sets No Security to configure the wireless setting without specifying a security method from WEP, WPA-PSK, and WPA-Enterprise.
	WEP	Sets the WEP to use through the wireless network.
	WPA-PSK(WPA2-PSK)^{*1, 2}	Sets the WPA-PSK to use through the wireless network.

WEP	Encryption	Select the WEP key code from either Hex or Ascii .
	WEP Key 1	Sets the WEP key set used through the wireless network only when WEP 128bit or WEP 64bit is selected for Encryption .
	Re-enter WEP Key 1	Enters the WEP key 1 again to confirm it.
	WEP Key 2	Sets the WEP key set used through the wireless network only when WEP 128bit or WEP 64bit is selected for Encryption .
	Re-enter WEP Key 2	Enters the WEP key 2 again to confirm it.
	WEP Key 3	Sets the WEP key set used through the wireless network only when WEP 128bit or WEP 64bit is selected for Encryption .
	Re-enter WEP Key 3	Enters the WEP key 3 again to confirm it.
	WEP Key 4	Sets the WEP key set used through the wireless network only when WEP 128bit or WEP 64bit is selected for Encryption .
	Re-enter WEP Key 4	Enters the WEP key 4 again to confirm it.
	Transmit Key	Sets the transmit key type from the list.
WPA-PSK	Pass Phrase	Sets the pass phrase.
	Re-enter Pass Phrase	Enters the pass phrase again to confirm it.

*1 For encryption, AES or TKIP method is used.

*2 This item is available only when the Infrastructure mode is selected for Network Type.



NOTE: The optional wireless adapter supports WEP, WPA-PSK-TKIP, WPA-PSK-AES, and WPA-PSK-AES.

Reset Print Server

Purpose:

To initialize NVRAM (non-volatile RAM) for the network feature and reboot the printer. You can also initialize NVRAM of the printer from **Reset Defaults** in the **Printer Settings** menu.

Values:

Initialize NIC NVRAM Memory and restart printer.	Click the Start button to initialize NVRAM, revert network settings to the factory default settings, and reboot the network capability.
Restart Printer	Click the Start button to reboot the printer.

Security

The **Security** tab includes **Set Password, SSL/TLS, IPsec, 802.1x** and **IP Filter (IPv4)**.

Set Password

Purpose:

To set or change the password that is required to access the setup parameters of the printer from the **Dell Printer Configuration Web Tool**.

Set the password of the operator panel from **Panel Lock** in the **Printer Settings**. This page can also be displayed by clicking **Set Password** in the Left Frame.



NOTE: To restore the password to the default (NULL), initialize the non-volatile memory (NVM).

Values:

Administrator Password	Sets the password using up to 10 alphanumeric characters.
Re-enter Administrator Password	Confirms the set password.
Access denial by the authentication failure of the Administrator	Sets the amount of time the administrator should wait for the access to the printer setup from Dell Printer Configuration Web Tool . Sets the time period from 5 up to 255 seconds. The access is denied if the time-out time is exceeded. If you set 0, this mode is disabled.

SSL/TLS

Purpose:

To specify the settings for the SSL encryption communication to the printer.

Values:

SSL/TLS	HTTP-SSL/TLS Communication ^{*1}	Select the check box to enable the HTTP-SSL/TLS Communication.
	HTTP-SSL/TLS Communication Port Number	Sets the port number, which is not identical with that of HTTP for SSL/TLS. This must be 443 or between 8,000 and 9,999.
Machine Digital Certification	Generate Self-Signed Certificate ^{*2}	Click this button to display the Generate Self-Signed Certificate page.
	Certificate Details ^{*3}	Click this button to display the Certificate Details page for the contents of the certificate or to delete the certificate.

^{*1} This item is enabled only when you generate the self-signed certificate on the **Generate Self-Signed Certificate** page.

^{*2} This button is grayed out after you generate the self-signed certificate on the **Generate Self-Signed Certificate** page.

^{*3} This button is available only when **HTTP-SSL/TLS Communication** is set to **Enable**.

SSL/TLS (Generate Self-Signed Certificate)

Purpose:

To generate a self-signed certificate.

Values:

Generate Self-Signed Certificate	Size of Public Key	Sets the size of public key.
	Issuer	Sets the issuer of the self-signed certificate.
Generate Signed Certificate		Click this button to generate the signed certificate.
Back		Click this button to go back to the previous page.

SSL/TLS (Certificate Details)

Purpose:

To refer to the contents of the certificate or delete the certificate.

Values:

Certificate Details	Category	Displays the category of the device to certificate.
	Issued To	Displays the device to certificate.
	Issuer	Displays the issuer of the self-signed certificate.
	Serial Number	Displays the serial number of the device.
	Size of Public Key	Display the size of public key.
	Valid From	Displays the time the certificate is valid.
	Valid Until	Displays the time the certificate is invalid.
	Status	Displays whether the certificate is valid or not.
	Certificate Purpose	Displays the purpose of certificate.
	Certificate Selection Status	Displays the type of device certificate you selected.
Delete		Click this button to delete the self-signed certificate.
Back		Click this button to go back to the previous page.

IPsec

Purpose:

To specify the Security Architecture settings for Internet Protocol (IPsec) for encrypted communication to the printer.

Values:

IPsec Settings	Protocol	Select the check box to enable the protocol.
	IKE	Sets IKE authentication. IKE is fixed to Pre-Shared Key .
	Pre-Shared Key	Sets a shared key. Up to 255 alphanumeric characters, periods, and hyphens can be used.
	Re-enter Pre-Shared Key	Enters the shared key again to confirm it.
	IKE SA Lifetime	Sets the lifetime for IKE SA from 5 to 28,800 minutes.
	IPsec SA Lifetime	Sets the lifetime for IPsec SA from 5 to 2,880 minutes.
	DH Group	Sets the DH group.
	PFS	Select the check box to enable the PFS setting.
	Remote peers IPv4 address	Sets the IP address to connect to.
	Remote peers IPv6 address	Sets the IP address to connect to.
	Non IPsec communication policy	Allows communication with a device which does not support IPsec.

 **NOTE:** If IPsec is enabled with incorrect settings, you must disable it using the **Reset IPsec** menu on the operator panel.

802.1x

Purpose:

To specify the settings for IEEE 802.1x authentication for encrypted communication to the printer.

Values:

Configure 802.1x	Enable IEEE 802.1x	Select the check box to enable IEEE 802.1x authentication.
	Authentication Method	EAP-MD5 EAP-MS-CHAPv2 PEAP/MS-CHAPv2
	Login Name: (Device Name)	Sets the login name (device name) for IEEE 802.1x authentication using up to 128 alphanumeric characters.
	Password	Sets the login password for IEEE 802.1x authentication using up to 128 alphanumeric characters.
	Re-enter Password	Confirms the set login password.

IP Filter (IPv4)

Purpose:

To specify the IP address and subnet mask to be permitted or denied access to the printer.

Values:

Access List	Address	Sets the IP addresses that are permitted or denied access to the printer. Enter a numeric value between 0 and 255 in each field.	
	Address Mask	Sets the subnet mask that are permitted or denied access to the printer. Enter a numeric value between 0 and 255 in each field.	
	Active Mode	Reject	Rejects printing from specified network address.
		Permit	Permits printing from specified network address.
	Disabled	Disables the IP Filter feature for the specified IP address.	

Copy Printer Settings

The **Copy Printer Settings** menu includes the **Copy Printer Settings** and **Copy Printer Settings Report** pages.

Copy Printer Settings

Purpose:

To copy the printer settings to one or more of the same model of the printer.

To copy the settings to another printer, specify the IP address and password of the printer to which the settings are copied in the **IP Address** text box and **Password** text box. Then, click the **Copy the settings to the Host in the above list** button. Copying the settings is complete. The connection time-out period is 60 seconds. After that, you can check whether the settings were copied to this page. And you need to check the **Copy the settings to the Host in the above list and reboot the printer** menu of the **Dell Printer Configuration Web Tool** in the destination printer to verify if the settings were actually copied or not.

If the settings can be copied but the printer configuration is different, the settings of only the same items are copied. Printer settings are simultaneously copied to printers of up to 10 IP addresses.

Copy Printer Settings Report

Purpose:

To verify whether the printer setting is copied to other printers successfully.



NOTE: The history is cleared by turning off the printer.

Print Volume

The **Printer Volume** menu includes the **Print Volume** and **Dell ColorTrack** pages.

Print Volume

Purpose:

To verify the number of printed pages. This page can also be displayed by clicking **Print Volume** in the left frame.

Values:

Printer Page Count	Displays the total number of pages printed since the printer was shipped from the factory.
Paper Used	Displays the number of pages printed for each paper size.

Dell ColorTrack

Purpose:

To specify which users have access to color printing and to limit print volume per user.

Values:

ColorTrack Mode	Sets whether to enable the ColorTrack mode, which specifies who has access to color printing.
No Account User Print	Sets whether to permit the printing of data without authentication information. To permit the printing for non-account user, set to On .
ColorTrack Error Report	Sets whether to automatically print error-related information if printing with ColorTrack results in an error.
User Registration ^{*1}	Click Edit User Registration to edit print user registrations.

^{*1} This item is available only when **ColorTrack Mode** is set to **On**.

Edit Print User Registration - List

Purpose:

To edit the print meter setting for each user.

Values:

User No. List to:	Selecting each button displays a list of print meter settings for the group of user registration numbers indicated on the button.
No.	Displays the user registration number.
User Name	Displays the user name. (Not in Use) is displayed in User Name when there is no registration.

MonoCount (Limit)	Displays the total number of monochrome pages printed to date and the maximum number of monochrome pages the user is permitted to print.
ColorCount (Limit)	Displays the total number of color pages printed to date and the maximum number of color pages the user is permitted to print.
Delete	Deletes the entry for the selected user registration number.
Confirm / Change	Displays a dialog box where you can edit the entry for the selected user registration number.
Create	Displays a dialog box where you can create a new entry under the selected user registration number.

Print User Settings (Confirm/Change, Create)

Purpose:

To view or edit the user entries on the **Edit Print User Registration** page, or create a new entry. The following items are in the dialog box that appears when you click the **Confirm/Change** or **Create** button on the **Edit Print User Registration** page.

Values:

User Registration No.	Displays the selected user registration number.
Delete User^{*1}	Click this button to display the Print User Settings - Delete page to delete the user from registration.
User Name	Allows you to view or edit the name of the user registered under the selected user registration number, or enter a user name for the new entry.
Password	Displays the password associated with the user name in asterisks, or allows you to enter a password for the new entry.
Re-enter Password	Confirms the set password.
Color Mode Limitation	Sets whether to permit only monochrome printing or both color and monochrome printing.
Upper Limit for Color Print	Sets the maximum number of color pages the user is permitted to print.
Cumulative Color Page Count	Displays the total number of color pages printed to date.

Upper Limit for Monochrome Print	Sets the maximum number of monochrome pages the user is permitted to print.
Cumulative Monochrome Page Count	Displays the total number of monochrome pages printed to date.
Apply New Settings	Click this button to apply the new settings.
Restore Settings	Click this button to restore the previous settings.
Back	Click this button to return to the Edit Print User Registration - List page.
* ¹ This item is available only when you click the Confirm / Change button.	

Print User Settings (Delete)

Purpose:

To delete the user entries registered on the **Edit Print User Registration** page. The following items are in the dialog box that appears when you click the **Delete** button on the **Edit Print User Registration** page.

Values:

User Registration No.	Displays the selected user registration number.
User Name	Displays the name of the user registered under the user registration number.
Apply New Settings	Click this button to apply the new settings.
Back	Click this button to return to the Edit Print User Registration page.

Tray Settings

Use the **Tray Settings** menu to set the paper size and type of paper loaded in the standard 250-sheet tray and the optional 250-sheet feeder.

Values:

Tray 1 Paper Size	Sets the size of paper loaded in the standard 250-sheet tray.
--------------------------	---

Tray 1 Paper Type	Sets the type of paper loaded in the standard 250-sheet tray.
Tray 1 Custom Size - Y	Sets the length of custom size paper loaded in the standard 250-sheet tray.
Tray 1 Custom Size - X	Sets the width of custom size paper loaded in the standard 250-sheet tray.
Tray 1 Display Popup	Sets whether to display a popup message that prompts the user to set the paper size and type when the paper is loaded in the standard 250-sheet tray.
Tray 2 Paper Size^{*1}	Sets the size of paper loaded in the optional 250-sheet feeder.
Tray 2 Paper Type^{*1}	Sets the type of paper loaded in the optional 250-sheet feeder.
Tray 2 Display Popup^{*1}	Sets whether to display a popup message that prompts the user to set the paper size and type when the paper is loaded in the optional 250-sheet feeder.
*1 This item is available only when the optional 250-sheet feeder is installed.	

Print Media Guidelines

Print media refers to paper, labels, envelopes, and coated paper among others. Your printer provides high-quality printing on a variety of print media. Selecting the appropriate print media for your printer helps avoid printing troubles. This section describes selecting print media, caring for print media, and loading the print media in the standard 250-sheet tray.

Paper

For the best print quality in color, use 75 g/m² (20 lb) xerographic, grain long paper. For the best print quality in black and white, use 90 g/m² (24 lb) xerographic, grain long paper. It is recommended that you try a sample first before buying large quantities of any print media.

When loading paper, identify the recommended print side on the paper package, and load the paper accordingly. See "Loading Print Media in the Standard 250-Sheet Tray and the Optional 250-Sheet Feeder" and "Loading Print Media in the SSF" for detailed loading instructions.

Paper Characteristics

The following paper characteristics affect print quality and reliability. It is recommended that you follow these guidelines when evaluating new paper stock.

Weight

The tray automatically feeds paper weights from 60 g/m² to 216 g/m² (16 lb to 80 lb bond) grain long. The single sheet feeder automatically feeds paper weights from 60 g/m² to 216 g/m² (16 lb to 80 lb bond) grain long. Paper lighter than 60 g/m² (16 lb) may not feed properly, and could cause paper jams. For best performance, use 75 g/m² (20 lb bond) grain long paper.

Curl

Curl is the tendency of print media to curve at its edges. Excessive curl can cause paper feeding problems. Curl usually occurs after the paper passes through the printer, where it is exposed to high temperatures. Storing paper

unwrapped, even in the paper tray, can contribute to paper curling prior to printing and cause feeding problems regardless of humidity. When printing on curled paper, straighten the paper and then insert it into the single sheet feeder.

Smoothness

The degree of paper smoothness directly affects the print quality. If the paper is too rough, the toner does not fuse on to the paper properly, resulting in poor print quality. If the paper is too smooth, it can cause paper feeding problems. Smoothness between 150 and 250 Sheffield points produces the best print quality.

Moisture Content

The amount of moisture in the paper affects both the print quality and the ability of the printer to feed the paper properly. Leave the paper in its original packaging until you are ready to use it. This limits the exposure of the paper to moisture changes that can degrade its performance.

Grain Direction

Grain refers to the alignment of the paper fibers in a sheet of paper. Grain is either grain long, running the length of the paper, or grain short, running the width of the paper. For 60 g/m² to 135 g/m² (16 lb to 36 lb bond) paper, grain long fibers are recommended. For paper heavier than 135 g/m² (36 lb bond), grain short is preferred.

Fiber Content

Most high-quality xerographic paper is made from 100 % chemically pulped wood. Paper containing fibers such as cotton may lead to degraded paper handling.

Recommended Paper

To ensure the best print quality and feed reliability, use 75 g/m² (20 lb) xerographic paper. Business paper designed for general business use also provides acceptable print quality. Only use paper able to withstand high temperatures without discoloring, bleeding, or releasing hazardous emissions. The laser printing process heats paper to high temperatures. Check with the manufacturer or vendor to determine whether the paper you have chosen is acceptable for laser printers.

It is recommended that you try a sample first before buying large quantities of any print media. When choosing any print media, you should consider the weight, fiber content, and color.

Unacceptable Paper

The following paper types are not recommended for use with the printer:

- Chemically treated paper used to make copies without carbon paper, also known as carbonless paper, carbonless copy paper (CCP), or no carbon required (NCR) paper.
- Preprinted paper with chemicals that may contaminate the printer.
- Preprinted paper that can be affected by the temperature in the fuser.
- Preprinted paper that requires a registration (the precise print location on the page) greater than ± 0.09 inches, such as optical character recognition (OCR) forms.

In some cases, you can adjust registration with your software program to successfully print on these forms.

- Coated paper (erasable bond), synthetic paper, and thermal paper.
- Rough-edged, rough or heavily textured surface paper, or curled paper.
- Recycled paper containing more than 25 % post-consumer waste that does not meet DIN 19 309.
- Multiple-part forms or documents.
- Print quality may deteriorate (blank spaces or blotches may appear in the text) when printing on talc or acid paper.

Selecting Paper

Proper paper selection helps prevent jams and ensures trouble-free printing.

To help avoid jams or poor print quality:

- Always use new, undamaged paper.
- Before loading the paper, identify the recommended print side of the paper. This information is usually indicated on the paper package.
- Do not use paper that you have cut or trimmed.
- Do not mix print media sizes, weights, or types in the same source. This may result in a paper jam.

- Do not remove the tray while printing is in progress.
- Ensure that the paper is properly loaded in the tray.
- Flex the paper back and forth, and then fan them. Straighten the edges of the stack on a level surface.

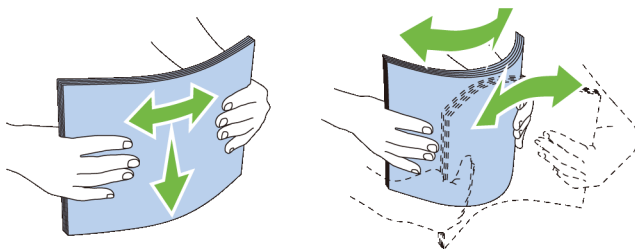

Selecting Pre-Printed Media and Letterheads

When selecting pre-printed and letterhead paper for the printer:

- Use grain long paper for best results.
- Use only forms and letterheads printed using an offset lithographic or engraved printing process.
- Select paper that absorb ink, but does not bleed.
- Avoid paper with rough or heavily textured surfaces.
- Use paper printed with heat-resistant inks designed for use in xerographic copiers. The ink must withstand temperatures of 225 °C (437 °F) without melting or releasing hazardous emissions.
- Use inks that are not affected by the resin in the toner or the silicone in the fuser. Inks that are oxidation-set or oil-based should meet these requirements; latex inks might not. If you are in doubt, contact your paper supplier.

Selecting Pre-Punched Paper

When selecting pre-punched paper for the printer:

- Test paper from several manufacturers before ordering and using large quantities of pre-punched paper.
- Paper should be punched at the paper manufacturer and not drilled into paper already packaged in a ream. Drilled paper can cause jams when multiple sheets feed through the printer. This may result in a paper jam.

- Pre-punched paper can include more paper dust than standard paper. Your printer may require more frequent cleaning and feed reliability may not be as good as standard paper.
- Weight guidelines for pre-punched paper are the same as non-punched paper.

Printing on a Letterhead (Pre-Printed and Pre-Punched Paper)

Check with the manufacturer or vendor to determine whether the pre-printed letterhead that you have selected is acceptable for laser printers.

Page orientation is important when printing on pre-printed paper such as letterhead and pre-punched paper. The following table shows the orientation when loading letterheads in the tray or feeders. For other pre-printed and pre-punched paper, load the paper by reference to the following table.

Print media source	Print side	Page orientation
Standard 250-sheet tray and Optional 250-sheet feeder	Dell 2150cn Color Printer Face up	Letterhead enters the printer last

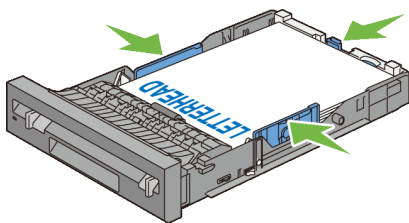

Dell 2150cdn Color Printer Face down	Letterhead enters the printer first
---	-------------------------------------

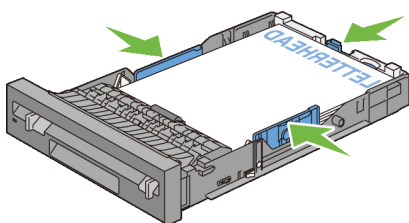

NOTE: Set LetterH Dup Mode (**Letterhead Duplex Mode**) to Enable and Paper Type to Letterhead, Preprinted, or Prepunched from the operator panel or the printer driver even when you print on a single side of letterhead, pre-printed, or pre-punched paper.

Print media source	Print side	Page orientation
Single sheet feeder (SSF)	Face down	Letterhead enters the printer first

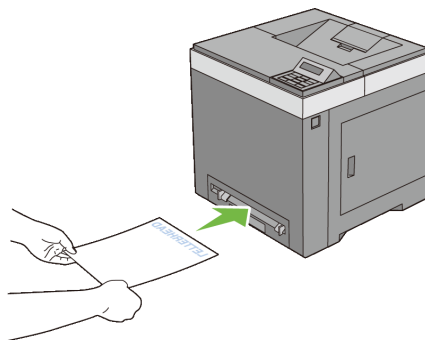

Envelopes

Depending on the envelopes, it is possible to expect variable levels of wrinkling. It is recommended that you try a sample first before buying large quantities of any print media. See "Loading Envelopes in the Standard 250-Sheet Tray and Optional 250-Sheet Feeder" or "Loading an Envelope in the SSF" for instructions on loading an envelope.

When printing on envelopes:

- Use only high-quality envelopes that are designed for use in laser printers.
- Set the print media source to the single sheet feeder or the standard 250-sheet tray. Set the paper type to **Envelope**, and select the correct size of envelope from the printer driver.
- Use envelopes made from 75 g/m² (20 lb bond) paper. You can use up to 105 g/m² (28 lb bond) weight for the envelope feeder as long as the cotton content is 25 % or less. Envelopes with 100 % cotton content must not exceed 90 g/m² (24 lb bond) weight.
- Use only freshly unpackaged, undamaged envelopes.
- Use envelopes that can withstand temperatures of 205 °C (401 °F) without sealing, excessive curling, wrinkling, or releasing hazardous emissions. If you have any doubts about the envelopes you are considering, check with the envelope supplier.

- Adjust the guide to fit the width of the envelopes.
- To load an envelope into the single sheet feeder, insert the envelope with the flaps closed and the short-edge of the envelope facing into the printer. The print side must be facing down.
- See "Loading Envelopes in the Standard 250-Sheet Tray and Optional 250-Sheet Feeder" or "Loading an Envelope in the SSF" for instructions on loading an envelope.
- Use one envelope size during a print job.
- Ensure that the humidity is low because high humidity (more than 60 %) and the high printing temperatures may seal the envelopes.
- For best performance, do not use envelopes that:
 - Have excessive curl or twist
 - Are stuck together or damaged in any way
 - Contain windows, holes, perforations, cutouts, or embossing
 - Use metal clasps, string ties, or metal folding bars
 - Have an interlocking design
 - Have postage stamps attached
 - Have any exposed adhesive when the flap is in the sealed or closed position
 - Have nicked edges or bent corners
 - Have rough, cockle, or laid finishes

Labels

Your printer can print on many labels designed only for use with laser printers.

When selecting labels:

- Label adhesives, face sheet (printable stock), and topcoats must be able to withstand temperatures of 205 °C (401 °F) and pressure of 25 pounds per square inch (psi).
- Use labels that can be without sealing, excessive curling, wrinkling, or releasing hazardous emissions.
- Do not use label sheets with a slick backing material.

 **NOTICE:** Before buying large quantities of any print media, it is recommended that you try a sample first.

When printing on labels:

- Use labels that can withstand temperatures of 205 °C (401 °F) without sealing, excessive curling, wrinkling, or releasing hazardous emissions.
- Set the paper type to **Label** from the printer driver.
- Use "Standard Tray" for label.
- Do not print through "Single Sheet Feeder" for label.
- Do not load labels together with paper in the same tray.
- Do not print within 1 mm (0.04 inches) of the die-cut.
- Do not print within 1 mm (0.04 inches) of the edge of the label, of the perforations, or between die-cuts of the label.
- Do not print a label through the printer more than once.
- Portrait orientation is preferred, especially when printing bar codes.
- Do not use labels that have exposed adhesive.
- Use full label sheets. Partial sheets may cause labels to peel off during printing, resulting in a jam.
- Do not use label sheets that have adhesive to the edge of the sheet. It is recommended that zone coating of the adhesive is done at least 1 mm (0.04 inches) away from edges. Adhesive material contaminates your printer and could void your warranty.

 **CAUTION:** Otherwise the printer occur in a jam and contaminate your printer and your cartridges with adhesive. As a result, could void your printer and cartridge warranties.

Storing Print Media

For proper print media storage, the following guidelines will help to avoid media feeding problems and uneven print quality.

- Store print media in an environment where the temperature is approximately 21 °C (70 °F) and the relative humidity is 40 %.
- Store cartons of print media on a pallet or shelf, rather than directly on the floor.

- If you store individual packages of print media out of the original carton, ensure that they rest on a flat surface so that the edges do not buckle or curl.
- Do not place anything on top of the print media packages.

Identifying Print Media and Specifications

The following tables show print media information.

Supported Paper Sizes

Paper size	Single sheet feeder		Standard 250-sheet tray		Optional 250-sheet feeder		Duplexer
	Side 1	Side 2	Side 1	Side 2	Side 1	Side 2	
A4 (210 x 297 mm)	Y	Y	Y	Y	Y	Y	Y
B5 (182 x 257 mm)	Y	Y	Y	Y	Y	Y	N
A5 (148 x 210 mm)	Y	Y	Y	Y	Y	Y	N
Letter (8.5 x 11 in)	Y	Y	Y	Y	Y	Y	Y
Folio (8.5 x 13 in)	Y	Y	Y	Y	Y	Y	Y
Legal (8.5 x 14 in)	Y	Y	Y	Y	Y	Y	Y
Executive (7.25 x 10.5 in)	Y	Y	Y	Y	Y	Y	N
Envelope #10 (4.125 x 9.5 in)	Y	N	Y	N	N	N	N
Monarch (3.875 x 7.5 in)	Y ^{*2}	N	Y	N	N	N	N
DL (110 x 220mm)	Y ^{*2}	N	Y	N	N	N	N
C5 (162 x 229mm)	Y	N	Y	N	N	N	N
Custom ^{*1}	Y	Y	Y	N	N	N	N

*1: Custom: width: 76.2 mm (3.0 inch) to 215.9 mm (8.5 inch)
length: 127.0 mm (5.0 inch) to 355.6 mm (14.00 inch)

*2: Monarch LEF and DL LEF are not available.

Supported Paper Types

Paper type		Single sheet feeder		Standard 250-sheet tray		Optional 250-sheet feeder		Duplexer	
		Side 1	Side 2	Side 1	Side 2	Side 1	Side 2	Side 1	Side 2
Plain	Light	Y	Y	Y	Y	Y	Y	Y	N
	Normal	Y	Y	Y	Y	Y	Y	Y	N
	Thick	Y	Y	Y	Y	Y	Y	Y	N
Covers	Normal	Y	-	Y	-	N	-	N	-
	Thick	Y	-	Y	-	N	-	N	-
Coated	Normal	Y	-	N	-	N	-	N	-
	Thick	Y	-	N	-	N	-	N	-
Label	Normal	N	-	Y	-	N	-	N	-
	Thick	N	-	Y	-	N	-	N	-
Envelope		Y	-	Y	-	N	-	N	-
Recycled		Y	Y	Y	Y	Y	Y	Y	N
Letterhead		Y	-	Y	-	Y	-	Y	-
Preprinted		Y	-	Y	-	Y	-	Y	-
Prepunched		Y	-	Y	-	Y	-	Y	-
Color		Y	Y	Y	Y	Y	Y	Y	N



NOTE: For Plain and Label paper, you can set the paper density by selecting the Paper Density (Light or Normal) under Printer Maintenance from the operator panel, Tool Box, or Dell Configuration Web Tool. Once you set the Paper Density settings, the printer uses the settings for Plain and Label paper.

Paper Type Specifications

Paper type	Weight (g/m ²)	Remarks
Plain	60–90	-
Plain Thick	80/90–105	-
Recycled	60–105	-

Paper type	Weight (g/m ²)	Remarks
Labels	-	Inkjet printer paper cannot be used.
Covers	106–163	-
Covers Thick	164–216	-
Envelope	-	-
Coated	106–163	Inkjet printer paper cannot be used.
Coated Thick	164–216	Inkjet printer paper cannot be used.
Letterhead	-	-
Preprinted	64	-
Prepunched	64	-
Color	64	-

Loading Print Media

Loading print media properly helps prevent jams and ensures trouble-free printing.

Before loading any print media, identify the recommended print side of the print media. This information is usually indicated on the print media package.

Capacity

The standard 250-sheet tray and optional 250-sheet feeder can hold:

- 250 sheets of the standard paper.

The SSF can hold:

- 1 sheet of the standard paper.

Print Media Dimensions

The maximum dimensions of print media that the standard 250-sheet tray, optional 250-sheet feeder, and SSF can handle are:

- Width — 76.2 mm (3.00 inches) to 215.9 mm (8.5 inches)
- Length — 127 mm (5.00 inches) to 355.6 mm (14.00 inches)

Loading Print Media in the Standard 250-Sheet Tray and the Optional 250-Sheet Feeder



NOTE: To avoid paper jams, do not remove the tray while printing is in progress.



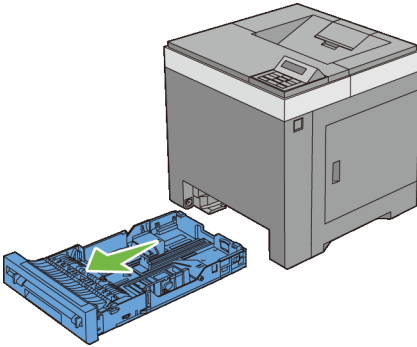

NOTE: Use only laser print media. Do not use ink jet paper in the printer.

- 1 Pull the tray out of the printer about 200 mm. Hold the tray with both hands, and remove it from the printer.

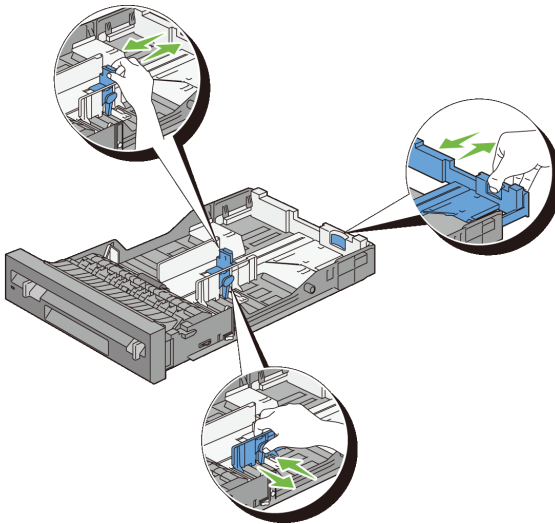

- 2 Adjust the paper guides.



 **NOTE:** Extend the rear side of the tray when you load Legal size paper.

- 3 Before loading the print media, flex the sheets and fan them. Straighten the edges of the stack on a level surface.

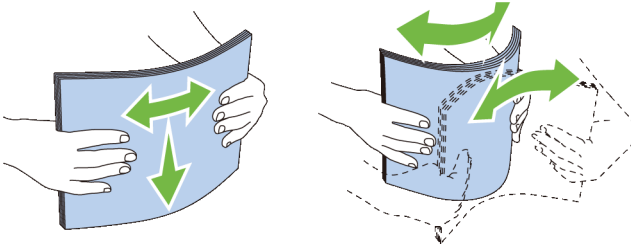

- 4 Load the print media into the tray with the recommended print side facing up.

 **NOTE:** Do not exceed the maximum fill line in the tray. Overfilling the tray may cause paper jams.



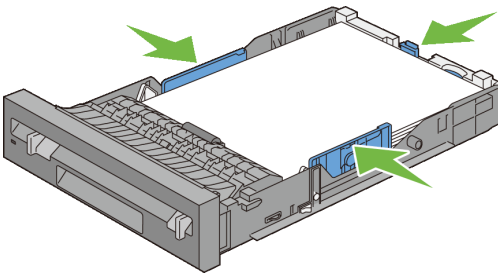



- 5 Align the width guides against the edges of the paper.

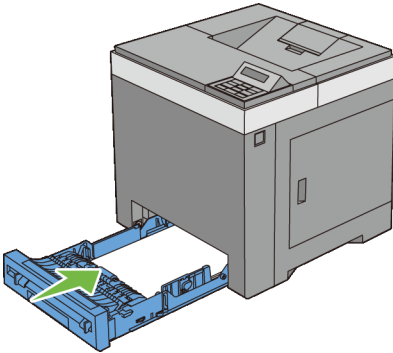

 **NOTE:** When loading user-specified print media, adjust the width guides and slide the extendable part of the tray by pinching the length guide and sliding it until it rests lightly against the edge of the paper.

- 6 After confirming that the guides are securely adjusted, insert the tray into the printer.



- 7 On the operator panel, press  or  button until the desired paper size appears, and then press the  (Set) button.
- 8 Press  or  button until the desired paper type appears, and then press the  (Set) button.

Loading Envelopes in the Standard 250-Sheet Tray and Optional 250-Sheet Feeder

Use the following guidelines when loading envelopes in the standard 250-sheet tray and optional 250-sheet feeder:

-  **NOTE:** If you do not load envelopes in the standard 250-sheet tray and optional 250-sheet feeder right after they have been removed from the packaging, they may bulge. To avoid jams, flatten them as shown below before loading the envelopes in the tray.

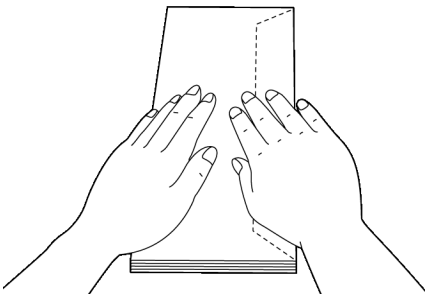

Envelope #10

Load the envelopes short edge feed with the flaps closed and the print side up. Ensure that the flaps come at the right when you face towards the printer.

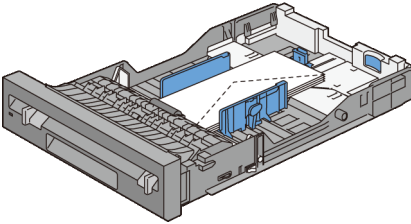

Monarch or DL

The Monarch or DL envelopes can be loaded in one of the following ways:
Load the envelopes short edge feed with the flaps closed and the print side up. Ensure that the flaps come at the right when you face towards the printer.

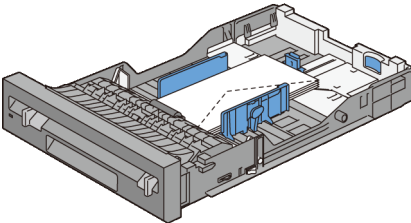

OR

Load the envelopes long edge feed with the flaps open and the print side up. Ensure that the flaps come at the top when you face towards the printer.

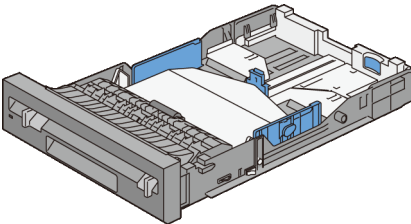

C5

Load the envelopes short edge feed with the flaps closed and the print side up. Ensure that the flaps come at the bottom when you face towards the printer.

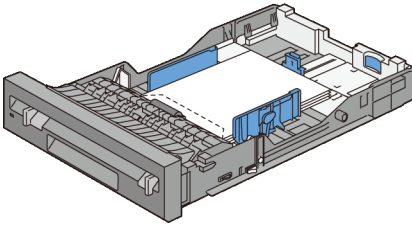

Loading Letterhead (Pre-Printed and Pre-Punched Paper)

When using the standard 250-sheet tray and optional 250-sheet feeder, the pre-printed paper such as letterhead enters the printer with the print side facing up for Dell 2150cn Color Printer. As for Dell 2150cdn Color Printer, the pre-printed paper such as letterhead and pre-punched paper enter the printer with the print side facing down as shown below.



NOTE: For Dell 2150cdn Color Printer, set LetterH Dup Mode (**Letterhead Duplex Mode**) to Enable and Paper Type to Letterhead, Preprinted, or Prepunched from the operator panel or the printer driver even when you print on a single side of letterhead, pre-printed, or pre-punched paper.

When using the single sheet feeder, the pre-printed paper such as letterhead enters the printer first with the print side facing down.

The following table shows the orientation when loading letterheads in the tray or feeders. For other pre-printed and pre-punched paper, load the paper by reference to the following table.

Print media source	Print side	Page orientation
Standard 250-sheet tray and optional 250-sheet feeder	Dell 2150cn Color Printer Face up	Letterhead enters the printer last

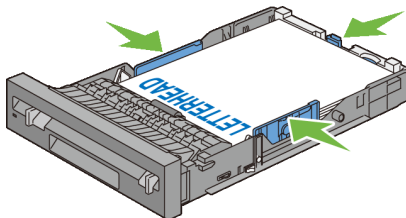

Dell 2150cdn Color Printer Face down	Letterhead enters the printer first
---	-------------------------------------

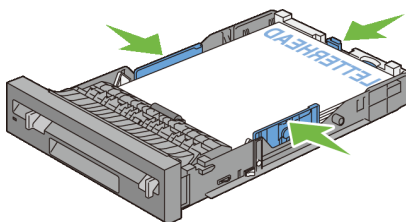

NOTE: Set LetterH Dup Mode (**Letterhead Duplex Mode**) to Enable and Paper Type to Letterhead, Preprinted, or Prepunched from the operator panel or the printer driver even when you print on a single side of letterhead, pre-printed, or pre-punched paper.

Print media source	Print side	Page orientation
Single sheet feeder (SSF)	Face down	Letterhead enters the printer first

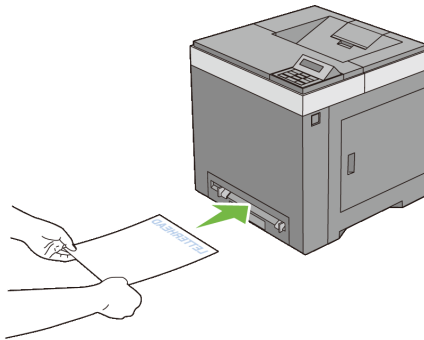

Loading Print Media in the SSF

- 1 Adjust the width guides to the print media's width.

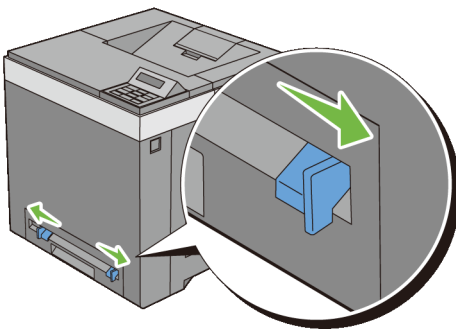

- 2 Hold both sides of the print media facing down close to the single sheet feeder, and push it 8 cm to 9 cm (4 inches) into the printer until it automatically feeds.

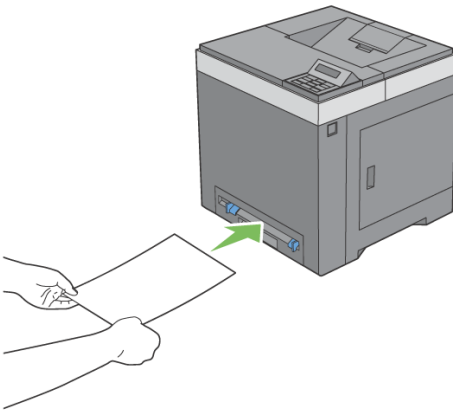

- ✎ NOTE: Do not force the print media into the single sheet feeder.
- ✎ NOTE: Load letterhead face-down, with the top of the sheet entering the printer first.
- ✎ NOTE: If you experience problems with paper feed, turn the paper around.

Loading an Envelope in the SSF

Envelope #10, Monarch, or DL

To load an envelope into the single sheet feeder, insert the envelope short edge feed with the flap closed and the print side down. Ensure that the flap comes at the right when you face towards the printer.

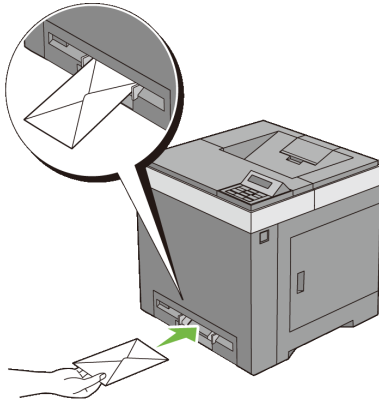

- ➔ **NOTICE:** Never use envelopes with windows, coated linings, or self-stick adhesives. These lead to paper jams and can cause damage to the printer.
- ✍ **NOTE:** Ensure that you load an envelope with the flap completely closed.
- ✍ **NOTE:** Insert an envelope with the flap side face up and with the stamp area on the top right side.

C5

To load an envelope into the single sheet feeder, insert the envelope short edge feed with the flap open and the print side down. Ensure that the flap comes at the bottom when you face towards the printer.

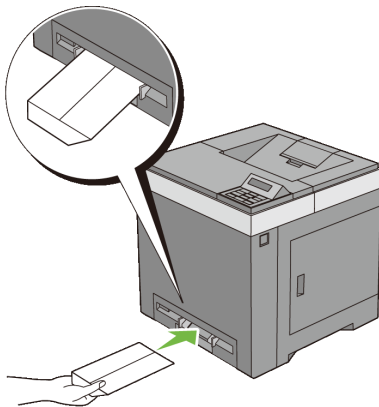

OR

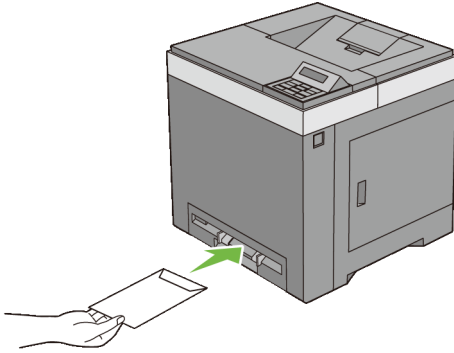

- ➔ **NOTICE:** Never use envelopes with windows, coated linings, or self-stick adhesives. These lead to paper jams and can cause damage to the printer.
- ✍ **NOTE:** Ensure that you load an envelope with the flap completely opened.
- ✍ **NOTE:** Insert an envelope with the flap side face up and with the stamp area on the bottom right side.

Using the SSF

- Load only one size and type of print media during a single print job.
- To achieve the best possible print quality, use only high-quality print media that is designed for use in laser printer. For more guidelines on print media, see "Print Media Guidelines."
- Do not add or remove print media when the printer is printing from the SSF. This may result in a paper jam.
- Print media should be loaded with the recommended print side down and the top of the print media going into the SSF first.
- Do not place objects on the SSF. Also, avoid pressing down or apply excessive force on it.
- The icons on the SSF show how to load the SSF with paper, and how to turn an envelope for printing.

Linking Trays

The printer automatically links the trays when you load the same size and type of print media in them. The first tray will be utilized until the media runs out after which the next tray will be used.

 **NOTE:** The print media should be the same size and type in each tray. The SSF cannot be linked to any of the tray sources.

After loading the selected trays with the same size and type of print media, select the Paper Type setting in the Tray Settings component for each source (tray).

To disable tray linking change the Paper type in one of the sources (trays) to a unique value.

 **NOTE:** If different types of print media of the same size are loaded in each tray, the printer will automatically link them if the paper type is not specified in the printer driver properties/preferences.



Operator Panel



Using the Operator Panel Buttons

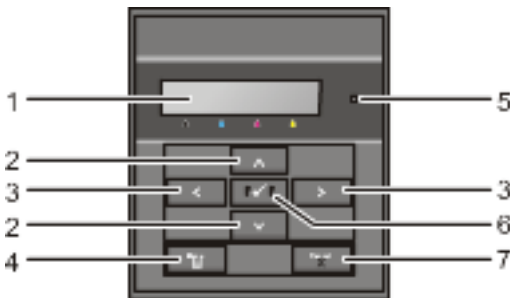

The operator panel has a 2-line by 16-character liquid crystal display (LCD), seven buttons, and two indicators that flash when the printer is ready to print, and when an error occurs.

 **NOTE:** The images used and procedures described in this manual are those of Dell™ 2150cn Color Printer.



- 1 LCD panel
 - Displays various settings, instructions, and error messages.
- 2  button
 - In the Menu mode, scrolls through menus or items. To enter numbers or passwords for secure print jobs, press these buttons.
- 3  button
 - In the Menu mode, selects submenus or setting values.
- 4  (Menu) button
 - In the Print mode, switches to the Menu mode.
 - In the Menu mode, switches to the Print mode.
- 5 Ready / Error LED





- Lights green when the printer is ready or sleeping and blinks when data is being received. (Ready LED)
 - Lights orange when an error occurs and blinks when an unrecoverable print error occurs. (Error LED)
- 6  **(Set)** button
- In the Menu mode, displays the selected menu or item and determines the selected value.
- 7  **(Cancel)** button
- Cancels the current print job.
 - In the top level of the Menu mode, switches to the Print mode.
 - In the submenu of the Menu mode, switches to the previous level.

 **NOTE:** Moving to a different menu or returning to a previous screen cancels the current entry or setting. Make sure to press the  **(Set)** button to save the current entry or setting.

Printing a Panel Settings Page

The panel settings page shows current settings for the operator panel menus.

When Using the Operator Panel

- 1 Press the  **(Menu)** button.
- 2 Ensure that **Report/List** is displayed, and then press the  **(Set)** button.
- 3 Press  button until **Panel Settings** appears, and then press the  **(Set)** button.

The panel settings page is printed.

When Using the Tool Box

 **NOTE:**

- 1 Click **Start**→ **All Programs**→ **Dell Printers**→ **Dell 2150 Color Printer**→ **Tool Box**.

 **NOTE:** The **Select Printer** window appears in this step when multiple printer drivers are installed on your computer. In this case, click the name of this printer listed in **Printer Names**, and then click **Ok**.

The **Tool Box** opens.

- 2 Ensure that the **Printer Settings Reports** tab is open.
- 3 Select **Reports** from the list at the left side of the page.

The **Reports** page appears.

- 4 Click the **Panel Settings** button.

The panel settings page is printed.

Printing

Printing

This chapter covers tips for printing, how to print certain information from your printer, and how to cancel a job.



NOTE: The images used and procedures described in this manual are those of Dell™ 2150cn Color Printer.

Tips for Successful Printing

Tips on Storing Print Media

Store your print media properly. For more information, see "Storing Print Media."

Avoiding Paper Jams



NOTICE: Before buying large quantities of any print media, it is recommended that you try a sample first.

By selecting appropriate print media and loading it properly, you can avoid paper jams. See the following instructions on loading print media:

- "Loading Print Media in the Standard 250-Sheet Tray and the Optional 250-Sheet Feeder"
- "Loading Print Media in the SSF"
- "Avoiding Jams"

If you encounter a paper jam, see "Clearing Jams."

Sending a Job to Print

To support all of the printer features, use the printer driver. When you choose **Print** from a software program, a window representing the printer driver opens. Select the appropriate settings for the specific job that you are sending to print. Print settings selected from the driver override the default menu settings selected from the operator panel or Tool Box.

You may need to click **Preferences** from the initial **Print** box to see all of the available system settings you can change. If you are not familiar with a feature in the printer driver window, open the online Help for more information.

To print a job from a typical Microsoft® Windows® application:

- 1 Open the file you want to print.
- 2 From the **File** menu, select **Print**.
- 3 Verify that the correct printer is selected in the dialog box. Modify the system settings as appropriate (such as the pages you want to print or the number of copies).
- 4 Click **Preferences** to adjust system settings that are not available from the first screen, and then click **OK**.
- 5 Click **OK** or **Print** to send the job to the selected printer.

Canceling a Print Job

There are several methods for canceling a job.

- Canceling a Job From the Operator Panel
- Canceling a Job From a Computer Running Windows

Canceling a Job From the Operator Panel

To cancel a job after it has started printing:

- 1 Press the **X (Cancel)** button.

Printing is canceled only for the current job. All the following jobs will continue to print.

Canceling a Job From a Computer Running Windows

Canceling a Job From the Taskbar

When you send a job to print, a small printer icon appears in the bottom right corner of the taskbar.

- 1 Double-click the printer icon.
A list of print jobs appears in the printer window.
- 2 Select the job you want to cancel.
- 3 Press **Delete** on the keyboard.

Canceling a Job From the Desktop

- 1 Click **Start**→**Printers and Faxes**.
For Windows XP®: Click **start**→ **Printers and Faxes**.
For Windows Vista®: Click **Start**→ **Control Panel**→ **Hardware and Sound**→ **Printers**.
For Windows Server® 2008: Click **Start**→ **Control Panel**→ **Printers**.
For Windows Server 2008 R2/Windows 7: Click **Start**→ **Devices and Printers**.

A list of available printers appears.

- 2 Double-click the printer that you selected when you sent the job for print.
A list of print jobs appears in the printer window.
- 3 Select the job you want to cancel.
- 4 Press **Delete** on the keyboard.

Duplex Printing

Duplex printing (or two-sided printing) allows you to print on both sides of a sheet of paper. For sizes that are acceptable for duplex printing, see "Supported Paper Sizes."

Duplex Printing With Duplexer (Dell 2150cdn Color Printer Only)

- 1 Click **Start**→**Printers and Faxes**.

For Windows XP: Click **start**→ **Printers and Faxes**.

For Windows Vista: Click **Start**→ **Control Panel**→ **Hardware and Sound**→ **Printers**.

For Windows Server 2008: Click **Start**→ **Control Panel**→ **Printers**.

For Windows Server 2008 R2/Windows 7: Click **Start**→ **Devices and Printers**.

- 2 Right-click the printer and select **Printing Preferences**.

The **Paper/Output** tab appears.

- 3 Select **Paper Source from Tray 1, Tray 2, and Auto**.

- 4 From **Duplex**, select **Flip on Long Edge** or **Flip on Short Edge**.

 NOTE: For details on the **Flip on Long Edge** and **Flip on Short Edge** options, see "Flip on Long Edge" and "Flip on Short Edge."

- 5 Click **OK**.

Duplex Printing Without Duplexer (Dell 2150cn Color Printer Only)

Manual duplex printing (or two-sided printing) allows you to manually print on both sides of the paper. For information on the paper sizes that support manual duplex printing, see "Supported Paper Sizes."

 NOTE: You can use the manual duplex feature using PCL 6 printer driver.

 NOTE: To use the manual duplex feature, select **Paper Source** other than **Auto** or **SSF**.

- 1 Click **Start**→**Printers and Faxes**.

For Windows XP: Click **start**→ **Printers and Faxes**.

For Windows Vista: Click **Start**→ **Control Panel**→ **Hardware and Sound**→ **Printers**.

For Windows Server 2008: Click **Start**→ **Control Panel**→ **Printers**.

For Windows Server 2008 R2/Windows 7: Click **Start**→ **Devices and Printers**.

- 2 Right-click the printer and select **Printing Preferences**.

The **Paper/Output** tab appears.

- 3 From **Paper Source**, select **Tray 1** or **Tray 2**.
- 4 From **Duplex**, select **Flip on Long Edge** or **Flip on Short Edge**.

 **NOTE:** For details on the **Flip on Long Edge** and **Flip on Short Edge** options, see "Flip on Long Edge" and "Flip on Short Edge."

- 5 Click **OK**.

A window that shows the instructions for manual duplex printing appears.

The even-numbered pages are printed from the printer.

Clicking the **OK** button on your printer driver will first print the even-numbered pages of your document. If your document consists of six pages, its even-numbered pages are printed in the order of page 6, 4, and then 2. After the even-numbered pages are printed, a message **Insert Output to Tray 1 (Tray 2)(071-920 or 072-920)** appears on the operator panel.

- 6 Remove the stack of output from the output tray. Load the stack back into the tray without turning it over (with the blank side face up).

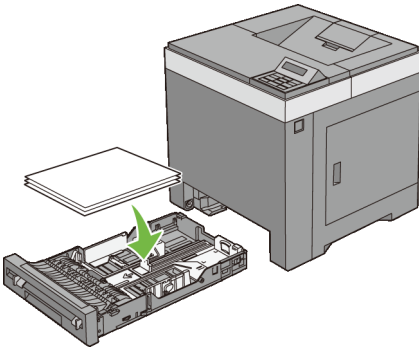

- 7 A message **Press ✓ to continue printing (071-921 or 072-921)** appears on the operator panel. Press the **✓ (Set)** button.

The odd-numbered pages are printed in the order of page 1, 3, and then 5.

 **NOTE:** You cannot duplex print mix-sized documents.

Using Booklet Print (Dell 2150cn and 2150cdn Models)

To use the booklet print feature, select **Booklet Creation** in the **Booklet/Poster/Mixed Document** dialog box displayed by clicking the **Booklet/Poster/Mixed Document** button. **Flip on Long Edge** binding position is selected by default. If you want to change the position, select **Flip on Short Edge** from the **Duplex** menu in the printer properties dialog box.

 NOTE: For Dell 2150cdn Color Printer, select **Paper Source** or **Auto** to use the booklet printing feature. For Dell 2150cn Color Printer, select **Paper Source**. You cannot select **Auto** or **SSF** for booklet printing.

 NOTE: When XPS driver is used, booklet print is not available.

Flip on Long Edge Assumes binding along the long edge of the page (left edge for portrait orientation and top edge for landscape orientation). The following illustration shows long-edge binding for portrait and landscape pages:

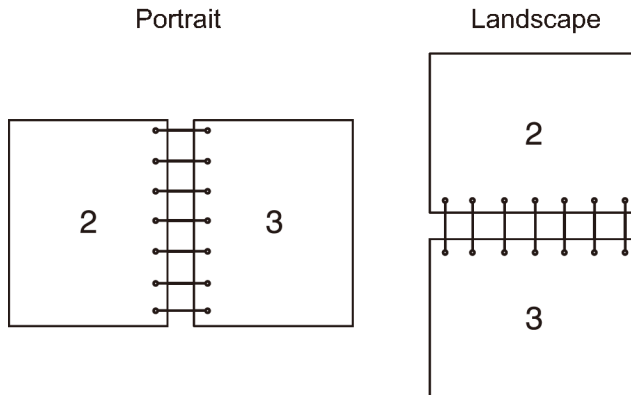

Flip on Short Edge Assumes binding along the short edge of the page (top edge for portrait orientation and left edge for landscape orientation). The following illustration shows short-edge binding for portrait and landscape pages:

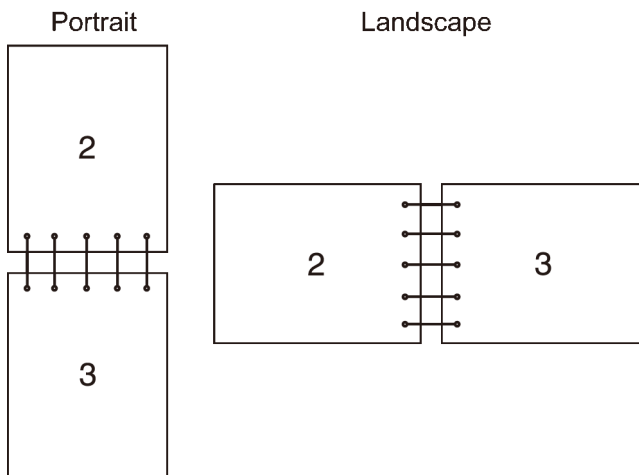

Using the Stored Print Function

When you send a job to the printer, you can specify in the driver that you want the printer to store the job in the memory. When you are ready to print the job, go to the printer and use the operator panel menus to identify which job in the memory you want to print. You can use this function for Secure Print, Private MailBox Print, Public MailBox Print, and Proof Print.



NOTE: Stored Print function is available when:

- The optional memory module is installed.
- The RAM disk is enabled in the operator panel menu.
- **RAM Disk** is set to **Available** in the printer driver.



NOTE: The data in memory is cleared when the printer is turned off.

The stored print function includes the following job types:

- Secure Print
- Private MailBox Print

- Public MailBox Print
- Proof Print

Secure Print

You can store print jobs temporarily in printer memory and print them later from the operator panel. This feature can be used to print confidential documents. A stored print job will be deleted after you print it or at a designated time.



NOTE: Secure Print is available when using the PCL driver.

Private MailBox Print

You can store print jobs temporarily in printer memory and print them at a more convenient time from the operator panel. This feature can be used to print confidential documents. The stored jobs remain in printer memory until you delete them on the operator panel or turn off the printer.



NOTE: Private MailBox Print is available when using the PCL driver.

Public MailBox Print

You can store print jobs temporarily in printer memory and print them at a more convenient time from the operator panel or turn off the printer. A print job is stored until you delete it from printer memory on the printer operator panel. You cannot use the password function with this feature. This function does not require a password to print a stored job.



NOTE: Public MailBox Print is available when using the PCL driver.

Proof Print

When you specify multiple copies for a collated job, this feature allows you to print only the first set for checking, before proceeding to print the remaining copies at the printer.



NOTE: If a print job is too large for the memory available, the printer may display error messages.



NOTE: If a document name is not assigned to your print job in the printer driver, the job's name will be identified using the printer's time and date of submission to distinguish it from other jobs you have stored under your name.



NOTE: Proof Print is available when using the PCL driver.

Storing Print Jobs

When you select a job type other than **Normal Print** in the **Paper/Output** tab of the printer driver, the job will be stored in temporary memory until you request to print it from the operator panel or turn off the printer.







NOTE: Secure Print and Private MailBox Print require specifying a password for confidentiality.

Printing the Stored Jobs

Once jobs are stored, you can use the operator panel to specify printing. Select the job type you are using from Secure Print, Private MailBox Print, Public MailBox Print, and Proof Print. Then, select your user name from a list. Secure Print and Private MailBox Print require the password you specified in the driver when you sent the job.

To print the stored documents, use the procedure below.

- 1 Press the  (**Menu**) button.
- 2 Press  button until `Print` Menu appears, and then press the  (**Set**) button.
- 3 Press  button until the desired job type appears, and then press the  (**Set**) button.

The stored document will be printed.

Specifying Your Password on the Operator Panel (Secure Print/Private MailBox Print)

When you select `Secure Print` or `Private MailBox Print` from the `Print Menu` after selecting your user name, the following prompt appears:

[*****]

Use the buttons on the operator panel to enter the numeric password you specified in the printer driver. The password you entered will be displayed as asterisks (*****) to ensure confidentiality.

If you enter an invalid password, the message Wrong Password appears. Wait three seconds, or press the ✓ (Set) or ✕ (Cancel) button to return to the screen for user selection.

When you enter a valid password, you have access to all print jobs matching the user name and password you entered. The print jobs matching the password you entered appear on the screen. You can then choose to print or delete jobs matching the password you entered. (See "Printing the Stored Jobs" for more information.)

Deleting Stored Jobs

With Secure Print, a job that has been stored will be deleted after printing or deleted at a designated time if entered on the operator panel or at turning off the printer.

For other jobs, these jobs remain stored until you delete them on the operator panel or turn off the printer.

Printing a Report Page

By using the **Reports** menu, you can print a variety of settings for your printer including system settings, panel setting, and font list. The following sections describe two examples of printing from the **Reports** menu.

- Printing Printer Settings Report
- Printing Font Sample List

Printing Printer Settings Report

To verify detailed printer settings, print a printer settings report. A printed printer settings report also allows you to verify whether or not options have been installed properly.

See "Understanding the Printer Menus" to identify the display and operator panel buttons if you need help.

When Using the Operator Panel

- 1 Press the  (Menu) button.
- 2 Ensure that Report/List is displayed, and then press the ✓ (Set) button.

- 3 Ensure that `Printer Settings` is displayed, and then press the ✓ **(Set)** button.

The printer settings report is printed.

When Using the Tool Box



NOTE:

- 1 Click **Start**→ **All Programs**→ **Dell Printers**→ **Dell 2150 Color Printer**→ **Tool Box**.



NOTE: The **Select Printer** dialog box opens in this step when multiple printer drivers are installed on your computer. In this case, click the name of this printer listed in **Printer Names**, and then click **OK**.

The **Tool Box** opens.

- 2 Ensure that the **Printer Settings Report** tab is open.
- 3 Select **Reports** from the list at the left side of the page.

The **Reports** page appears.

- 4 Click the **Printer Settings** button.

The printer settings report is printed



The message `Send Printer Information` . appears while the page prints. The printer returns to the standby mode after printing the printer settings report.

If any other message appears when you print this page, see the online Help for more information.

Printing Font Sample List

To print samples of all the fonts currently available for your printer:

When Using the Operator Panel

- 1 Press the  (**Menu**) button.
- 2 Ensure that `Report/List` is displayed, and then press the ✓ **(Set)** button.
- 3 Press  button until `PCL Fonts List` appears, and then press the ✓ **(Set)** button.

The PCL fonts list is printed.

When Using the Tool Box



NOTE:

- 1 Click **Start**→ **All Programs**→ **Dell Printers**→ **Dell 2150 Color Printer**→ **Tool Box**.



NOTE: The **Select Printer** dialog box opens in this step when multiple printer drivers are installed on your computer. In this case, click the name of this printer listed in **Printer Names**, and then click **OK**.

The **Tool Box** opens.

- 2 Ensure that the **Printer Settings Report** tab is open.
- 3 Select **Reports** from the list at the left side of the page.

The **Reports** page appears.

- 4 Click the **PCL Fonts List** button.

The PCL fonts list is printed.

The message `Send Printer Information.` appears while the page prints. The printer returns to the standby mode after printing the font sample list.

Printer Settings

You can change most of the system settings from your software program. If your printer is attached to the network, you can change settings from the **Dell Printer Configuration Web Tool**. To launch the **Dell Printer Configuration Web Tool**, type the printer's IP address in your web browser. To find your printer's IP address, see "Printing Printer Settings Report."



Settings from the software program update the default system settings for the printer. Settings from the printer driver only apply to the job that you are currently sending to the printer.

If you cannot change a setting from your software program, use the operator panel, Tool Box or the **Dell Printer Configuration Web Tool**. Changing a system setting from the operator panel, Tool Box or from the **Dell Printer Configuration Web Tool** makes that setting the user default.

Printing Printer Settings Report

You can verify the detailed system settings by printing a printer settings report.

When Using the Operator Panel

- 1 Press the  (**Menu**) button.
- 2 Ensure that **Report/List** is displayed, and then press the  (**Set**) button.
- 3 Ensure that **Printer Settings** is displayed, and then press the  (**Set**) button.
The printer settings report is printed.

When Using the Tool Box



NOTE:

- 1 Click **Start**→ **All Programs**→ **Dell Printers**→ **Dell 2150 Color Printer**→ **Tool Box**.



NOTE: The **Select Printer** dialog box opens in this step when multiple printer drivers are installed on your computer. In this case, click the name of this printer listed in **Printer Names**, and then click **OK**.

The **Tool Box** opens.

- 2 Ensure that the **Printer Settings Report** tab is open.
- 3 Select **Reports** from the list at the left side of the page.

The **Reports** page appears.

- 4 Click the **Printer Settings** button.

The printer settings report is printed

Using the Operator Panel to Change the Printer Settings

You can select menu items and corresponding values from the operator panel.

When you first browse through the menus from the operator panel, you see an asterisk (*) next to an item in the menus.

The asterisks indicate the factory default menu settings. These settings are the original printer settings.









NOTE: Factory defaults may vary for different countries.





When you select a new setting from the operator panel, an asterisk appears next to the setting to identify it as the current user default menu setting.

These settings are active until new ones are selected or the factory defaults are restored.

To select a new value as a setting:

- 1 Press the  (**Menu**) button.
- 2 Press  or  button until the desired menu appears, and then press the  (**Set**) button.
- 3 Press  or  button until the desired menu or menu item appears, and then press the  (**Set**) button.
 - If the selection is a menu, the menu is opened and the first system setting in the menu appears.
 - If the selection is a menu item, the default menu setting for the menu item appears. (The current user default menu setting has an asterisk (*) beside it.)

Each menu item has a list of values for the menu item. A value can be:

- A phrase or word to describe a setting
 - A numerical value that can be changed
 - An On or Off setting
- 4 Press  or  button until the desired value appears, and then press the  (**Set**) button.
 - 5 Press the  (**Cancel**) or  button to return to the previous menu.

To continue setting other items, select the desired menu. To quit setting new values, press the  (**Cancel**) button.

Driver settings may override changes previously made and may require you to change the operator panel defaults.

Using the Dell Printer Configuration Web Tool to Change the Printer Settings

If your printer is connected to the network, you can change the printer settings from your web browser. If you are a network administrator, you can clone the system settings of one printer to one or all the printers on the network.



Type the IP address of your printer in your web browser. Choose **Printer Settings** from the topics list, and then select the **System Settings** you want to change.

To change the paper type and size, choose **Tray Settings** from the topics list. To change the Color Track settings, choose **Print Volume** from the topics list, and then select the **Dell Color Track** tab.

To copy your system settings to another printer on the network, choose **Copy Printer Settings** from the topics list, and then type the other printer's IP address.

If you do not know your printer's IP address, see the printer settings report or display the TCP/IP settings.

When Using the Operator Panel

- 1 Press the  (**Menu**) button.
- 2 Ensure that **Report/List** is displayed, and then press the  (**Set**) button.
- 3 Ensure that **Printer Settings** is displayed, and then press the  (**Set**) button.

The printer settings report is printed.

When Using the Tool Box



NOTE:

- 1 Click **Start**→ **All Programs**→ **Dell Printers**→ **Dell 2150 Color Printer**→ **Tool Box**.



NOTE: The **Select Printer** dialog box opens in this step when multiple printer drivers are installed on your computer. In this case, click the name of this printer listed in **Printer Names**, and then click **OK**.

The **Tool Box** opens.







- 2 Ensure that the **Printer Settings Report** tab is open.
- 3 Select **TCP/IP Settings** from the list at the left side of the page.

The **TCP/IP Settings** page appears.

Resetting Defaults



After resetting defaults and rebooting the printer, all the menu parameters, except the parameters for the network, are reset to their default values.

When Using the Operator Panel

- 1 Press the  (**Menu**) button.
- 2 Press  button until **Admin Menu** appears, and then press the  (**Set**) button.
- 3 Press  button until **Maintenance** appears, and then press the  (**Set**) button.
- 4 Press  button until **Reset Defaults** appears, and then press the  (**Set**) button.

The **Are you sure?** message appears on the operator panel.

- 5 Press the  (**Set**) button.

 **NOTE:** To cancel resetting defaults, press the  (**Cancel**) button.

The printer is turned off automatically to apply the settings.

When Using the Tool Box

 **NOTE:**

- 1 Click **Start** → **All Programs** → **Dell Printers** → **Dell 2150 Color Printer** → **Tool Box**.

 **NOTE:** The **Select Printer** dialog box opens in this step when multiple printer drivers are installed on your computer. In this case, click the name of this printer listed in **Printer Names**, and then click **OK**.

The **Tool Box** opens.

- 2 Click the **Printer Maintenance** tab.
- 3 Select **Reset Defaults** from the list at the left side of the page.

The **Reset Defaults** page appears.





- 4 Select the **System Section** button.

The printer is turned off automatically to apply the settings.

Adjusting the Language

To display a different language on the operator panel:

Using the Operator Panel

- 1 Press the  (**Menu**) button.
- 2 Press  button until **Panel Language** appears, and then press the  (**Set**) button.
- 3 Press  button until the desired language appears, and then press the  (**Set**) button.

When Using the Tool Box



NOTE:

- 1 Click **Start**→ **All Programs**→ **Dell Printers**→ **Dell 2150 Color Printer**→ **Tool Box**.



NOTE: The **Select Printer** dialog box opens in this step when multiple printer drivers are installed on your computer. In this case, click the name of this printer listed in **Printer Names**, and then click **OK**.

The **Tool Box** opens.

- 2 Click the **Printer Maintenance** tab.
- 3 Select **System Settings** from the list at the left side of the page.
The **System Settings** page appears.
- 4 Select the desired language from **Panel Language**, and then press the **Apply New Settings** button.

Know Your Printer

Understanding the Tool Box Menus

The Tool Box allows you to view, specify, and diagnose the system settings.

The Tool Box consists of the **Printer Settings Report**, **Printer Maintenance**, and **Diagnosis** tabs.



NOTE: A **Password** dialog box appears the first time you try to change settings on **Tool Box** when **Panel Lock** is set on the printer. In this case, input the password that you have already specified, and click **OK** to apply the settings.



NOTE: The images used and procedures described in this manual are those of Dell™ 2150cn Color Printer.

Printer Settings Report

The **Printer Settings Report** tab includes the **Printer Information**, **Menu Settings**, **Reports**, **TCP/IP Settings**.

Printer Information

Purpose:

To display the system information of the printer.

Values:

Dell Service Tag Number	Displays the service tag number of your printer.
Express Service Code	Displays the express service code number.
Printer Serial Number	Displays the serial number of your printer.
Printer Type	Displays the type of printing for the printer. Color Laser is displayed normally.
Asset Tag Number	Displays the asset tag number of your printer.
Memory Capacity	Displays the memory capacity.
Processor Speed	Displays the processing speed.

Firmware Version	Displays the version of the controller.
Network Firmware Version	Displays the NIC version.
MCU Firmware Version	Displays the version of the Machine Control Unit (MCU) firmware.
Printing Speed (Color)	Displays the speed for color printing.
Printing Speed (Monochrome)	Displays the speed for monochrome printing.

Menu Settings

Purpose:

To display the menu settings of the printer.

Values:

System Settings	Power Saver Timer Sleep	Displays the amount of transition time to the Sleep mode after the printer finishes a job.
	Power Saver Timer Deep Sleep	Displays the amount of transition time between the Sleep mode and the Deep Sleep mode.
	Auto Reset	Displays the amount of time before the printer automatically resets the settings on the operator panel to the defaults when no additional settings are made.
	Control Panel Tone	Displays the volume of the tone that is emitted when the operator panel input is correct. Off indicates that the tone is disabled.
	Invalid Key Tone	Displays the volume of the tone that is emitted when the operator panel input is incorrect. Off indicates that the tone is disabled.
	Machine Ready Tone	Displays the volume of the tone that is emitted when the printer becomes ready. Off indicates that the tone is disabled.

Job Completed Tone	Displays the volume of the tone that is emitted when a job other than copying is complete. Off indicates that the tone is disabled.
Fault Tone	Displays the volume of the tone that is emitted when a job ends abnormally. Off indicates that the tone is disabled.
Alert Tone	Displays the volume of the tone that is emitted when a problem occurs. Off indicates that the tone is disabled.
Out of Paper Alert Tone	Displays the volume of the tone that is emitted when the printer runs out of paper. Off indicates that the tone is disabled.
Low Toner Alert Tone	Displays the volume of the tone that is emitted when the toner is low. Off indicates that the tone is disabled.
Auto Clear Alert Tone	Displays the volume of the tone that is emitted 5 seconds before the printer performs auto clear. Off indicates that the tone is disabled.
Fault Time-out	Displays the amount of time the printer waits before canceling a job that stops abnormally.
Job Time-out	Displays the amount of time the printer waits for data to arrive from the computer.
Panel Language	Displays the language that is used on the operator panel screen.
Auto Log Print	Displays whether to automatically print a job history report after every 20 jobs.
Print ID	Displays where to print a user ID on the output paper.
Print Text	Displays whether the printer outputs PDL (Page Description Language) data (which is not supported by the printer) as text when the printer receives it.

	Banner Sheet Insert Position * ³	Displays where to insert the banner sheet.
	Banner Sheet Specify Tray * ³	Displays the banner sheet tray.
	RAM Disk * ¹	Displays whether to allocate RAM for the disk file system for the Secure Print and Proof Print features.
	Substitute Tray	Displays an indication to use paper of a different size when the paper that is loaded in the specified tray does not match the paper size settings for the current job.
	mm/inch	Displays the measurement unit used on the operator panel.
	Default Print Paper Size	Displays the default print paper size.
	ColorTrack Error Report	Displays whether to print the error report on the ColorTrack
	Letterhead Duplex Mode * ³	Displays whether to print both sides of a sheet of letterhead paper.
	Low Toner Alert Msg	Displays the volume of the tone that is emitted when the toner is low. Off indicates that the tone is disabled.
Date & Time	Date Format	Displays the selected date format.
	Time Format	Displays the selected time format; 24H or 12H .
	Time Zone	Displays the selected time zone.
	Set Date	Displays the date setting.
	Set Time	Displays the time setting.
Paper Density	Plain	Displays the plain paper density settings.
	Label	Displays the label paper density settings.
Auto Registration Adjustment	Auto Registration Adjustment	Displays whether to automatically adjust color registration.

Adjust Altitude	Adjust Altitude	Displays the altitude of the location where the printer is installed.
Non-Dell Toner	Non-Dell Toner	Displays whether to use toner cartridge of another manufacturer.
Tray Settings	Tray 1 Paper Type	Displays the paper type setting of the standard 250-sheet tray.
	Tray 1 Paper Size	Displays the paper size setting of the standard 250-sheet tray.
	Tray 1 Custom Size - Y	Displays the length of custom size paper loaded in the standard 250-sheet tray.
	Tray 1 Custom Size - X	Displays the width of custom size paper loaded in the standard 250-sheet tray.
	Tray 1 Display Popup	Displays a popup menu that prompts to set the paper size and type when paper is loaded in the standard 250-sheet tray.
	Tray 2 Paper Type ^{*2}	Displays the paper type setting of the optional 250-sheet feeder.
	Tray 2 Paper Size ^{*2}	Displays the paper size setting of the optional 250-sheet feeder.
	Tray 2 Display Popup ^{*2}	Displays a popup menu that prompts to set the paper size and type when paper is loaded in the optional 250-sheet feeder.

^{*1} This item is available only when the optional 512 MB memory module is installed.

^{*2} This item is available only when the optional 250-sheet feeder is installed.

^{*3} This item is available only for Dell 2150cdn Color Printer.

Reports

Purpose:

To print the settings and history information of the printer.

The reports are printed in the paper size specified in system settings. The default is A4.

Values:

Printer Settings	Click this button to print a detailed list of the printer settings.
Panel Settings	Click this button to print a detailed list of the panel settings.
PCL Fonts List	Click this button to print a list of the PCL (Hewlett-Packard Printer Control Language) Fonts.
PCL Macro List	Click this button to print a list of the PCL Macro.
Job History	Click this button to print the Completed Jobs history of the printer.
Error History	Click this button to print the error history of the printer.
Print Meter	Click this button to print the report for the total number of pages printed.
Color Test Page	Click this button to print a color test page.
Stored Documents ^{*1}	Click this button to print a list of the Stored Documents.

^{*1} You can print the list only when RAM disk is enabled.

TCP/IP Settings

Purpose:

To display the current settings of TCP/IP (Transmission Control Protocol/Internet Protocol).

Values:

IP Address Mode	Displays the method for acquiring the IP address.
IP Address	Displays the IP address of the printer.
Subnet Mask	Displays the subnet mask.
Gateway Address	Displays the gateway address.

Printer Maintenance

The **Printer Maintenance** tab includes the **System Settings, Date & Time, Paper Density, Color Registration Adjustment, Adjust Altitude, Reset Defaults, Non-Dell Toner, Initialize Print Meter, Tray Settings, TCP/IP Settings, and Network Settings** pages.



NOTE: Values marked by an asterisk (*) are the factory default menu settings.

System Settings

Purpose:

To configure the power management of the printer, auto clear time, alarm tones, time-out time, mm/inch setting, job log auto print, position of the Print ID, setting of the dump print, setting of the additional memory, setting of the substitute sheet, and operator panel language settings.

Values:

Power Saver Timer	Sleep ^{*1}	1–30 minutes	Sets the amount of transition time to the Sleep mode after the printer finishes a job.
		3 minutes *	
	Deep Sleep ^{*1}	5–60 minutes	Sets the amount of transition time between the Sleep mode and the Deep Sleep mode.
		10 minutes *	
Auto Reset		45 seconds *	Sets the amount of time before the printer automatically resets the settings on the operator panel to the defaults when no additional settings are made.
		1 minute	
		2 minutes	
		3 minutes	
		4 minutes	

Audio Tone	Control Panel	Off *	Does not emit a tone when the operator panel input is correct.
		On	Emits a tone at the specified volume when the operator panel input is correct.
	Invalid Key	Off *	Does not emit a tone when the operator panel input is incorrect.
		On	Emits a tone at the specified volume when the operator panel input is incorrect.
	Machine Ready	Off	Does not emit a tone when the printer becomes ready.
		On *	Emits a tone at the specified volume when the printer becomes ready.
	Job Completed	Off	Does not emit a tone when any other job except copying is complete.
		On *	Emits a tone at the specified volume when any other job except copying is complete.
	Fault Tone	Off	Does not emit a tone when a job ends abnormally.
		On *	Emits a tone at the specified volume when a job ends abnormally.
	Alert Tone	Off	Does not emit a tone when a problem occurs.
		On *	Emits a tone at the specified volume when a problem occurs.
	Out of Paper	Off	Does not emit a tone when the printer runs out of paper.
		On *	Emits a tone at the specified volume when the printer runs out of paper.

Low Toner Alert	Off	Does not emit a tone when the toner is low.
	On *	Emits a tone at the specified volume when the toner is low.
Auto Clear Alert	Off *	Does not emit a tone before the printer performs auto clear.
	On	Emits a tone at the specified volume 5 seconds before the printer performs auto clear.
Fault Time-out	0	Sets the amount of time the printer waits before canceling a job when the job stops abnormally.
	3–300 seconds	
	60 seconds *	
Job Time-out	0	Sets the amount of time the printer waits for additional data from the computer before it cancels the job.
	5–300 seconds	
	30 seconds *	
Auto Log Print	Off *	Does not automatically print a job history report after every 20 jobs.
	On	Automatically prints a job history report after every 20 jobs.
Print ID	Off *	Does not print the user ID.
	Top Left	Prints the user ID on the specified location.
	Top Right	
	Bottom Left	
	Bottom Right	
Print Text	Off	Does not print the received PDL data as text data.
	On *	Prints the received PDL data as text data.

Banner Sheet * ³	Insert Position	Off *	Does not insert the banner sheet.
		Front	Sets where to insert the banner sheet.
		Back	
	Front & Back		
	Specify Tray	Tray1 * Tray2 * ²	Sets the tray for the banner sheet.
RAM Disk * ⁴	Disable		Does not allocate RAM for the disk file system. Secure Print and Proof Print jobs will abort and be recorded to the job log.
	50-500MBytes		Allocates RAM for the disk file system automatically.
	300MBytes *		(in 50MBytes increments)
Substitute Tray	Off		No tray size substitute accepted.
	Larger Size		Substitutes paper of next largest size. When there is no larger paper size, the printer substitutes paper of nearest size.
	Nearest Size *		Substitutes paper of nearest size.
mm/inch	Millimeters(mm) *		Selects millimeter or inch as the default measurement unit.
	Inches(")		
Default Print Paper Size	A4 *		Sets the default print paper size.
	Letter		
ColorTrack Error Report	Off *		Does not automatically print error-related information if printing with ColorTrack results in an error.
	On		Automatically prints error-related information if printing with ColorTrack results in an error.
Letterhead Duplex Mode * ³	Disable *		Does not prints on both sides of a sheet of letterhead paper.
	Enable		Prints on both sides of a sheet of letterhead paper.

Low Toner Alert Msg	On [*]	Shows the alert message when the toner is low.
	Off	Does not show the alert message when the toner is low.
Panel Language	English [*]	Sets the language to be used on the operator panel.
	French	
	Italian	
	German	
	Spanish	
	Danish	
	Dutch	
	Norwegian	
Swedish		
Apply New Settings		After you change the settings, click this button to apply the changes.
Restart printer to apply new settings		Click this button to apply the changes.

^{*1} Enter 3 to put the printer in the power saver timer mode 3 minutes after it finishes a job. This uses much less energy, but requires more warm-up time for the printer. Enter 3 if your printer shares an electrical circuit with room lighting and you notice lights flickering. Select a high value if your printer is in constant use. Under most circumstances, this keeps the printer ready to operate with minimum warm-up time. Select a value between 1 and 30 minutes for the power saver timer mode if you want a balance between energy consumption and a shorter warm-up period. The printer automatically returns to the standby mode from the power saver timer mode when it receives data from the computer. You can also return the printer to the standby mode by pressing any button on the operator panel.

^{*2} This item is available only when the optional 250-sheet feeder is installed.

^{*3} This item is available only for Dell 2150cdn Color Printer.

^{*4} This item is available only when the optional 512 MB memory module is installed.

Date & Time

Purpose:

To specify the date and time.

Values:

Date Format	Sets the date format.
Time Format	Sets the time format in 24H or 12H .
Time Zone	Sets the time zone.
Set Date	Sets the date.
Set Time	Sets the time. You can select AM or PM when Time Format is set to 12H .
Apply New Settings	After you change the settings, click this button to apply the changes.
Restart printer to apply new settings	Click this button to restart the printer and apply the changes.

Paper Density

Purpose:

To specify the paper density settings.

Values:

Plain	Light	Sets plain paper density.
	Normal*	
Label	Light	Sets label paper density.
	Normal*	
Apply New Settings	After you change the settings, click this button to apply the changes.	
Restart printer to apply new settings	Click this button to restart the printer and apply the changes.	

Color Registration Adjustment

Purpose:

To set **Color Registration Adjustment** (individual yellow, magenta, cyan correction) settings. When **Auto Registration Adjustment** is set to **On**, the printer prints the color registration chart and adjusts the color registration by using the chart. Color registration adjustments need to be made during the initial setup of the printer or when the printer is moved to a different location.

Values:

Auto Registration Adjustment	Auto Registration Adjustment	Off	Does not perform color registration automatically.	
		On *	Performs color registration automatically.	
Manual Registration Adjustments *1	Auto Correct		Click Start to perform color registration automatically.	
	Print Color Regi Chart		Click Start to print a color registration chart.	
	Registration Adjustments	PY(Process Yellow)	-9 to +9 0*	Sets lateral (perpendicular to paper feed direction) and process (paper feed direction) color adjustment values that are found in the color registration chart individually for Yellow , Magenta , and Cyan .
		PM(Process Magenta)	-9 to +9 0*	
		PC(Process Cyan)	-9 to +9 0*	
		LY(Left Yellow)	-9 to +9 0*	
		LM(Left Magenta)	-9 to +9 0*	
		LC(Left Cyan)	-9 to +9 0*	
		RY(Right Yellow)	-9 to +9 0*	
		RM(Right Magenta)	-9 to +9 0*	
RC(Right Cyan)		-9 to +9 0*		
Apply New Settings			After you complete change the settings, click this button to apply the changes.	

Restart printer to apply new settings

Click this button to restart the printer and apply the changes.

*1 This item is available only when **Auto Registration Adjustment** is set to **Off**.

Adjust Altitude

Purpose:

To specify the altitude of the location where the printer is installed.

The method for charging the photo conductor varies with barometric pressure. Adjustments are performed by specifying the altitude of the location where the printer is being used.

Values:

Adjust Altitude	0 meter*	Sets the altitude of the location where the printer is installed.
	1000 meters	
	2000 meters	
	3000 meters	

Apply New Settings After you change the settings, click this button to apply the changes.

Restart printer to apply new settings Click this button to restart the printer and apply the changes.

Reset Defaults

Purpose:

To initialize wired network data stored in non-volatile memory (NVM). After executing this function and rebooting the printer, all wired network settings are reset to their default values.

Values:

System Section Initializes the system parameters.

Non-Dell Toner



NOTICE: Using a non-Dell toner cartridge may severely damage your printer. The warranty does not cover damages caused by using non-Dell toner cartridges.

Purpose:

To use toner cartridge of another manufacturer.

Values:

Non-Dell Toner	Off*	Disables the use toner cartridge of another manufacturer.
	On	Enables the use toner cartridge of another manufacturer.
Apply New Settings		After you change the settings, click this button to apply the changes.
Restart printer to apply new settings		Click this button to restart the printer and apply the changes.

Initialize Print Meter**Purpose:**

To initialize the Print Meter. When the print meter is initialized, the meter count is reset to 0.

Values:

Initialize Print Meter	Click Start to initialize the Print Meter.
-------------------------------	---

Tray Settings**Purpose:**

To specify the paper types and sizes for the standard 250-sheet tray and the optional 250-sheet feeder respectively.

Values:

Tray 1 Paper Type	Plain*	Sets the type of paper loaded in the standard 250-sheet tray.
	Plain Thick	
	Covers	
	Covers Thick	
	Label	
	Envelope	
	Recycled	
	Letterhead	
	Preprinted	
	Prepunched	
	Color	
	Plain - Side 2	
	Plain Thick - Side 2	
	Recycled Side 2	
Color - Side 2		
Tray 1 Paper Size	A4*	Sets the size of paper loaded in the standard 250-sheet tray.
	A5	
	B5	
	Letter	
	Folio	
	Legal	
	Executive	
	Envelope #10	
	Monarch	
	Monarch Landscape	
	DL	
	DL Landscape	
	C5	
	Custom Size	

Tray 1 Custom Size - Y	127–355 mm (5.0-14.0 inch) 297 mm * (11.7 inch)	Sets the length of custom size paper loaded in the standard 250-sheet tray.
Tray 1 Custom Size - X	77–215 mm (3.0–8.5 inch) 210 mm * (8.3 inch)	Sets the width of custom size paper loaded in the standard 250-sheet tray.
Tray 1 Display Popup	On *	Displays a popup message that prompts the user to set Paper Type and Paper Size when the paper is loaded in the standard 250-sheet tray.
Tray 2 Paper Type ^{*1}	Plain * Plain Thick Recycled Letterhead Preprinted Prepunched Color Plain - Side 2 Plain Thick - Side 2 Recycled - Side 2 Color - Side 2	Sets the type of paper loaded in the optional 250-sheet feeder.
Tray 2 Paper Size ^{*1}	A4 * A5 B5 Letter Folio Legal Executive	Sets the size of paper loaded in the optional 250-sheet feeder.
Tray 2 Display Popup ^{*1}	On *	Displays a popup message that prompts the user to set Paper Type and Paper Size when the paper is loaded in the optional 250-sheet feeder.

Apply New Settings	After you change the settings, click this button to apply the changes.
Restart printer to apply new settings	Click this button to restart the printer and apply the changes.

*1 This item is available only when the optional 250-sheet feeder is installed.

TCP/IP Settings

Purpose:

To configure TCP/IP settings.

Values:

IP Address Mode	AutoIP*	Automatically sets the IP address. A random value in the range of 169.254.1.0 to 169.254.254.255 that is not currently in use on the network is set as the IP address. The subnet mask is set as 255.255.0.0.
	BOOTP	Sets the IP address using BOOTP.
	RARP	Sets the IP address using RARP.
	DHCP	Sets the IP address using DHCP.
	Panel	Manually sets the IP address.
IP Address		Manually sets the IP address allocated to the printer. It is allocated to the printer using the format nnn.nnn.nnn.nnn. Each octet that makes up nnn.nnn.nnn.nnn is a value in the range of 0 to 254. 127 and any value in the range of 224 to 254 cannot be specified for the first octet of a gateway address.
Subnet Mask		Manually sets the subnet mask. It is specified using the format nnn.nnn.nnn.nnn. Each octet that makes up nnn.nnn.nnn.nnn is a value in the range of 0 to 255. 255.255.255.255 cannot be specified as the subnet mask.

Gateway Address	Manually sets the gateway address. It is specified using the format nnn.nnn.nnn.nnn. Each octet that makes up nnn.nnn.nnn.nnn is a value in the range of 0 to 254. 127 and any value in the range of 224 to 254 cannot be specified for the first octet of a gateway address.
Apply New Settings	After you change the settings, click this button to apply the changes.
Restart printer to apply new settings	Click this button to restart the printer and apply the changes.

Network Settings



NOTE: Network Settings is not available when the printer is connected using a USB cable.

Purpose:

To configure the setup of the printer using your web browser.

Values:

Print Server Settings ^{*1}	Display	Click to display the Print Server Setup page on the Dell Printer Configuration Web Tool .
Display of EWS	Off	Does not display the server settings for the Dell Printer Configuration Web Tool .
	On [*]	Displays the server settings for the Dell Printer Configuration Web Tool .
Apply New Settings		After you change the settings, click this button to apply the changes.
Restart printer to apply new settings		Click this button to restart the printer and apply the changes.

^{*1} This item is available only when **Display of EWS** is set to **On**.

Diagnosis

The **Diagnosis** tab includes the **Chart Print**, **Machine Check**, **Paper Wrinkle Check Mode**, **Environment Sensor Info**, **Clean Developer**, and **Refresh Mode** pages.



NOTE: Values marked by an asterisk (*) are the factory default menu settings.

Chart Print

Purpose:

To print various charts that can be used for diagnosis of the printer. The chart is printed to A4 or letter size paper.

Values:

Pitch Configuration Chart	Prints full halftone pages for yellow, magenta, cyan, and black. Also prints pages to check the pitch. A total of five pages are output.
Ghost Configuration Chart	Prints a chart to check for ghost printing. One page is printed.
4 Colors Configuration Chart	Bands of yellow, magenta, cyan, and black are printed with varying density. One page is printed.
MQ Chart	Prints charts to check for the binding in A4 or Letter.
Alignment Chart	Prints a chart to check for proper alignment of the print image on the paper. One page is printed.
Drum Refresh Configuration Chart	Prints a chart to check the light fatigue of the drum cartridge.

Machine Check

Purpose:

To check the operation of the printer components.

Values:

Machine Check	Main Motor Operation Check *	Click Start to operate the main motor inside the printer. Confirm the motor sound.
	Fuser Motor Operation Check	Click Start to operate the fuser motor. Confirm the motor sound.
	Feed Roll Operation Check * ¹	Click Start to operate the feed roll. Confirm the motor sound.
	REGI CLUTCH Operation Check	Click Start to operate the REGI CLUTCH. Confirm that you can hear the clutch clicking.
	Dispense Motor Check (Yellow)	Click Start to operate the dispense motor for each toner cartridge. Confirm the motor sound.
	Dispense Motor Check (Magenta)	
	Dispense Motor Check (Cyan)	
	Dispense Motor Check (Black)	
Play of Sound	Plays back through speakers of your computer a recording of the normal sound for the currently selected Machine Check item.	
Start	Click this button to check the operation of the items selected with Machine Check and output the results to Result .	
Result	Displays the results of the checked items.	
*1 When performing the feed roll operation check, remove the paper tray from the printer.		

Paper Wrinkle Check Mode

Purpose:

To determine whether or not paper is wrinkled in the fuser.

This function stops printing before the paper enters the fuser. After you remove the paper inside the printer, check the following:

- If the paper is wrinkled, the wrinkle occurred in the part other than fuser.
- If the paper is not wrinkled, the wrinkle occurred in the fuser.

Values:

Paper Size	A4*	Sets the size of paper to be used by the Paper Wrinkle Check Mode.
	A5	
	B5	
	Letter	
	Folio	
	Legal	
	Executive	
	Envelope #10	
	Monarch	
	DL	
C5		
Paper Type	Plain*	Sets the type of paper to be used by the Paper Wrinkle Check Mode.
	Plain Thick	
	Covers	
	Covers Thick	
	Label	
	Recycled	
	Envelope	
	Letterhead	
	Preprinted	
	Prepunched	
Color		
Rear side	Off*	Does not use the print side 2 of the paper.
	On	Uses the print side 2 of the paper.
Color Mode	Color*	Prints in color mode.
	Black & White	Prints in monochrome mode.
Start	Click this button to print in the specified paper size, type, and color mode.	

Environment Sensor Info

Purpose:

To print the internal environment sensor information of the printer to **Result**.

Values:

Get Environment Sensor Info	Click this button to confirm the internal environment sensor information of the printer such as temperature and humidity.
------------------------------------	---

Clean Developer

Purpose:

To rotate the developer motor and stir the toner in the toner cartridge.

Values:

Clean Developer	Click Start to stir the toner.
------------------------	---------------------------------------

Refresh Mode

Purpose:

To use up a toner cartridge or PHD unit when you need to replace it before the end of its life, or to stir the toner in a new toner cartridge.



NOTE: Using the Refresh Mode consumes extra toner.

Values:

Toner Refresh Mode	Yellow	Click Yellow to clean the yellow cartridge.
	Magenta	Click Magenta to clean the magenta cartridge.
	Cyan	Click Cyan to clean the cyan cartridge.
	Black	Click Black to clean the black cartridge.
Drum Refresh Mode	Drum	Click Drum to clean the drum.

Resetting Defaults

After executing this function and rebooting the printer, all the menu parameters, except the parameters for the network, are reset to their default values.

When Using the Tool Box



NOTE:

- 1 Click **Start**→ **All Programs**→ **Dell Printers**→ **Dell 2150 Color Printer**→ **Tool Box**.



NOTE: The **Select Printer** window appears in this step when multiple printer drivers are installed on your computer. In this case, click the name of this printer listed in **Printer Names**, and then click **OK**.

The **Tool Box** opens.

- 2 Ensure that the **Printer Maintenance** tab is open.
- 3 Select **Reset Defaults** from the list at the left side of the page.

The **Reset Defaults** page appears.

- 4 Click **System Section** button.

The printer restarts automatically to apply the settings.

Understanding the Printer Menus

When your printer is connected to a network and available to a number of users, the access to the Admin Menu can be limited. This prevents other users from using the operator panel to inadvertently change a user default that has been set by the administrator.

However, you can use your printer driver to override user defaults and select settings for individual print jobs.



NOTE: The images used and procedures described in this manual are those of Dell™ 2150cn Color Printer.

Report / List

Use the Report/List menu to print various types of reports and lists.

Printer Setting

Purpose:

To print a list of the current user default values, the installed options, the amount of installed print memory, and the status of printer supplies.

Panel Settings

Purpose:

To print a detailed list of all the settings on the operator panel menus.

PCL Fonts List

Purpose:

To print a sample of the available PCL fonts.

See also:

"Understanding Fonts", "Printing Font Sample List"

PCL Macro List

Purpose:

To print the information on the downloaded PCL macro.

Job History

Purpose:

To print a detailed list of the print jobs that have been processed. This list contains the last 20 jobs.

Error History

Purpose:

To print a detailed list of paper jams and fatal errors.

Print Meter

Purpose:

To print the reports for the total number of pages printed.

Color Test Page

Purpose:

To print a page for testing colors.

Stored Documents



NOTE: Stored Documents feature is available only when the optional 512 MB memory module is installed on the printer and RAM Disk under System Settings is enabled.

Purpose:

To print a list of all files stored for Secure Print, Private Mail Box Print, Public Mail Box Print, and Proof Print in the RAM disk.

Admin Menu

Use the Admin Menu menu to configure a variety of printer features.

Print Language

Purpose:

To specify the settings for PCL.

PCL

Use the PCL menu to change printer settings that only affect jobs using the PCL emulation printer language.



NOTE: Values marked by an asterisk (*) are the factory default menu settings.

Paper Tray

Purpose:

To specify the default paper tray.

Values:

Auto *
Tray 1
Tray 2 * ¹
SSF

*¹ This item is available only when the optional 250-sheet feeder is installed.

Paper Size

Purpose:

To specify the default paper size.

Values:

mm series

A4 * ¹
A5
B5
Letter
Folio
Legal
Executive

Envelope #10

Monarch

DL

C5

Custom Size

*1 Denotes country-specific factory default value.

inch series

Letter *1

Folio

Legal

A4

A5

B5

Executive

Envelope #10

Monarch

DL

C5

Custom Size

*1 Denotes country-specific factory default value.



NOTE: Selecting a custom size for the paper size prompts you to enter a custom length and width.

Orientation

Purpose:

To specify how text and graphics are oriented on the page.

Values:

Portrait *	Prints text and graphics parallel to the short edge of the paper.
Landscape	Prints text and graphics parallel to the long edge of the paper.

2 Sided



NOTE: 2 Sided print feature is available only for Dell 2150cdn Color Printer.

Purpose:

To specify whether to print on both sides of a sheet of paper.

Values:

2 Sided Print	Off *	Does not print on both sides of a sheet of paper.
	On	Prints on both sides of a sheet of paper.
Binding Edge	Flip Long Edge *	Prints on both sides of a sheet of paper to be bound by long edge.
	Flip Short Edge	Prints on both sides of a sheet of paper to be bound by short edge.

Font

Purpose:

To specify the default font from the fonts registered in the printer.

Values:

CG Times	LetterGothic	CourierPS
CG Times It	LetterGothic It	CourierPS Ob
CG Times Bd	LetterGothic Bd	CourierPS Bd
CG Times BdIt	Albertus Md	CourierPS BdOb
Univers Md	Albertus XBd	SymbolPS
Univers MdIt	Clarendon Cd	Palatino Roman
Univers Bd	Coronet	Palatino It
Univers BdIt	Marigold	Palatino Bd
Univers MdCd	Arial	Palatino BdIt
Univers MdCdIt	Arial It	ITCBookman Lt
Univers BdCd	Arial Bd	ITCBookman LtIt
Univers BdCdIt	Arial BdIt	ITCBookmanDm
AntiqueOlv	Times New	ITCBookmanDm It
AntiqueOlv It	Times New It	HelveticaNr
AntiqueOlv Bd	Times New Bd	HelveticaNr Ob
CG Omega	Times New BdIt	HelveticaNr Bd
CG Omega It	Symbol	HelveticaNrBdOb
CG Omega Bd	Wingdings	N C Schbk Roman
CG Omega BdIt	Line Printer	N C Schbk It
GaramondAntiqua	Times Roman	N C Schbk Bd
Garamond Krsv	Times It	N C Schbk BdIt
Garamond Hlb	Times Bd	ITC A G Go Bk
GaramondKrsvHlb	Times BdIt	ITC A G Go BkOb
Courier*	Helvetica	ITC A G Go Dm
Courier It	Helvetica Ob	ITC A G Go DmOb
Courier Bd	Helvetica Bd	ZapfC MdIt

Courier BdIt	Helvetica BdOb	ZapfDingbats
---------------------	-----------------------	---------------------

Symbol Set

Purpose:

To specify a symbol set for a specified font.

Values:

DESKTOP	ISO L5	PC-8 TK
DNGBTSMS	ISO L6	PI FONT
ISO-11	LEGAL	PS MATH
ISO-15	MATH-8	PS TEXT
ISO-17	MC TEXT	ROMAN-8*
ISO-21	MS PUB	SYMBOL
ISO-4	PC-1004	WIN 3.0
ISO-6	PC-775	WINBALT
ISO-60	PC-8	WINGDINGS
ISO-69	PC-850	WIN L1
ISO L1	PC-852	WIN L2
ISO L2	PC-8 DN	WIN L5

Font Size

Purpose:

To specify the font size for scalable typographic fonts.

Values:

12.00* Sets the values in increments of 0.25.

4.00 – 50.00

Font size refers to the height of the characters in the font. One point equals approximately 1/72 of an inch.



NOTE: The `Font Size` menu is only displayed for typographic fonts.

See also:

"Pitch and Point Size"

Font Pitch

Purpose:

To specify the font pitch for scalable mono spaced fonts.

Values:

10.00* Sets the value in increments of 0.01.

6.00–24.00

Font pitch refers to the number of fixed-space characters in a horizontal inch of type. For nonscalable mono spaced fonts, the pitch is displayed, but cannot be changed.



NOTE: The Font Pitch menu is only displayed for fixed or mono spaced fonts.

See also:

"Pitch and Point Size"

Form Line

Purpose:

To set the number of lines in a page.

Values:

mm series

64*1 Sets the value in increments of 1.

5–128

*1 Denotes country-specific factory default values.

inch series

60*1 Sets the value in increments of 1.

5–128

*1 Denotes country-specific factory default values.

The printer sets the amount of space between each line (vertical line spacing) based on the **Form Line** and **Orientation** menu items. Select the correct **Form Line** and **Orientation** before changing **Form Line**.

See also:

"Orientation"

Quantity

Purpose:

To set the default print quantity. (Set the number of copies required for a specific job from the printer driver. Values selected from the printer driver always override values selected from the operator panel.)

Values:

1*	Sets the value in increments of 1.
-----------	------------------------------------

1–999	
--------------	--

Image Enhance

Purpose:

To specify whether to enable the Image Enhance feature, which makes the boundary line between black and white smoother to decrease jagged edges and enhance the visual appearance.

Values:

Off	Disables the Image Enhance feature.
------------	-------------------------------------

On*	Enables the Image Enhance feature.
------------	------------------------------------

Hex Dump

Purpose:

To help isolate the source of a print job problem. With Hex Dump selected, all data sent to the printer is printed in hexadecimal and character representation. Control codes are not executed.

Values:

Disable*	Disables the Hex Dump feature.
-----------------	--------------------------------

Enable	Enables the Hex Dump feature.
---------------	-------------------------------

Draft Mode

Purpose:

To save toner by printing in the draft mode. The print quality is reduced when printing in the draft mode.

Values:

Disable *	Does not print in the draft mode.
------------------	-----------------------------------

Enable	Prints in the draft mode.
---------------	---------------------------

Line Termination

Purpose:

To add the line termination commands.

Values:

Off *	The line termination command is not added. CR=CR, LF=LF, FF=FF
--------------	---

Add-LF	The LF command is added. CR=CR-LF, LF=LF, FF=FF
---------------	--

Add-CR	The CR command is added. CR=CR, LF=CR-LF, FF=CR-FF
---------------	---

CR-XX	The CR and LF commands are added. CR=CR-LF, LF=CR-LF, FF=CR-FF
--------------	---

Default Color

Purpose:

To specify the color mode to `Color` or `Black`. This setting is used for a print job that does not specify a print mode.

Values:

Black *	Prints in the black and white mode.
----------------	-------------------------------------

Color	Prints in the color mode.
--------------	---------------------------

Network

Use the **Network** menu to change the printer settings affecting jobs sent to the printer through the wired or wireless network.

 **NOTE:** Values marked by an asterisk (*) are the factory default menu settings.

Ethernet

Purpose:

To specify the communication speed and the duplex settings of Ethernet. The change becomes effective after the printer is turned off and then on again.

Values:

Auto *	Detects the Ethernet settings automatically.
10BASE-T Half	Uses 10BASE-T Half-duplex.
10BASE-T Full	Uses 10BASE-T Full-duplex.
100BASE-TX Half	Uses 100BASE-TX Half-duplex.
100BASE-TX Full	Uses 100BASE-TX Full-duplex.
1000BASE-T Full	Uses 1000BASE-T Full-duplex.

Wireless Status

 **NOTE:** Wireless Status feature is available only when the printer is connected using the wireless network.

Purpose:

To confirm the wireless communication status.

Values:

Connection	Good
	Acceptable
	Low
	No Reception

Wireless Setup

 **NOTE:** Wireless Setup is available only when the printer is connected using the wireless network.

Purpose:

To configure the wireless network interface.

Values:

Manual Setup	Enter (SSID)	Specifies a name to identify the wireless network. Up to 32 alphanumeric characters can be entered.
Infra-structure		Select when you configure the wireless setting through the access point such as a wireless router.
	No Security	Specifies No Security to configure the wireless setting without specifying a security method from WEP , WPA-PSK-TKIP , and WPA-PSK-AES .
	WEP(64Bit)	Specifies the WEP 64 bit key to use through the wireless network. Up to 10 hexadecimal characters can be entered.
	Transmit Key	Specifies the transmit key from WEP Key 1 , WEP Key 2 , WEP Key 3 , and WEP Key 4 .
	WEP(128Bit)	Specifies the WEP 128 bit key to use through the wireless network. Up to 26 hexadecimal characters can be entered.
	Transmit Key	Specifies the transmit key from WEP Key 1 , WEP Key 2 , WEP Key 3 , and WEP Key 4 .
	WPA-PSK-TKIP	Select to configure the wireless setting with the security method of WPA-PSK-TKIP.
	PassPhrase Entry	Specifies the passphrase of alphanumeric characters from 8 to 63 only when WPA-PSK-TKIP is selected for Encryption.
	WPA2-PSK-AES	Select to configure the wireless setting with the security method of WPA2-PSK-AES.
	PassPhrase Entry	Specifies the passphrase of alphanumeric characters from 8 to 63 only when WPA-PSK-AES is selected for Encryption.

Ad-hoc	Select to configure the wireless setting without the access point such as a wireless router.		
	No Security	Select to configure the wireless setting without specifying the security method from WEP .	
	WEP(64Bit)	Specifies the WEP 64 bit key to use through the wireless network. Up to 10 hexadecimal characters can be entered.	
		Transmit Key	Specifies the transmit key from WEP Key 1, WEP Key 2, WEP Key 3, and WEP Key 4.
	WEP(128Bit)	Specifies the WEP 128 bit key to use through the wireless network. Up to 26 hexadecimal characters can be entered.	
		Transmit Key	Specifies the transmit key from WEP Key 1, WEP Key 2, WEP Key 3, and WEP Key 4.
WPS	Push Btn. Ctrl	PBC Start	Cancel*
			Disables the security method of WPS-PBC.
			Start
			Configures the wireless setting with the security method of WPS-PBC.
	PIN Code	Start Config.*	Configures the wireless setting using the PIN code assigned automatically by the printer.
		Print PIN Code	Prints the PIN code. Confirm it when entering PIN assigned to the printer into your computer.

Reset Wireless



NOTE: Reset Wireless feature is available only when the printer is connected using the wireless network.

Purpose:

To initialize wireless network settings. After executing this function and rebooting the printer, all wireless network settings are reset to their default values.

Values:

Are You Sure? Press the  **(Set)** button to reset the wireless setting.

TCP/IP

Purpose:

To configure TCP/IP settings.

Values:

IP Mode	Dual Stack *	Uses both IPv4 and IPv6 to set the IP address.
	IPv4 Mode	Uses IPv4 to set the IP address.
	IPv6 Mode	Uses IPv6 to set the IP address.

IPv4	Get IP Address	AutoIP*	Sets the IP address automatically. A random value in the range of 169.254.1.0 to 169.254.254.255 that is not currently in use on the network is set as the IP address. The subnet mask is set as 255.255.0.0.
		BOOTP	Sets the IP address using BOOTP.
		RARP	Sets the IP address using RARP.
		DHCP	Sets the IP address using DHCP.
		Panel	Use this option when you want to set the IP address manually on the operator panel.
	IP Address		When an IP address is being set manually, the IP is allocated to the printer using the format nnn.nnn.nnn.nnn. Each octet that makes up nnn.nnn.nnn.nnn is a value in the range of 0 to 254. 127 and any value in the range of 224 to 254 cannot be specified for the first octet of a gateway address.
	Subnet Mask		When an IP address is being set manually, the subnet mask is specified using the format nnn.nnn.nnn.nnn. Each octet that makes up nnn.nnn.nnn.nnn is a value in the range of 0 to 255. 255.255.255.255 cannot be specified as the subnet mask.
	Gateway Address		When an IP address is being set manually, the gateway address is specified using the format nnn.nnn.nnn.nnn. Each octet that makes up nnn.nnn.nnn.nnn is a value in the range of 0 to 254. 127 and any value in the range of 224 to 254 cannot be specified for the first octet of a gateway address.
IPsec	Disable*		Disables IPsec.

Protocol

Purpose:

To enable or disable each protocol. The change becomes effective after the printer is turned off and then on again.

Values:

LPD	Disable	Disables the LPD port.
	Enable [*]	Enables the Line Printer Daemon (LPD) port.
Port9100	Disable	Disables the Port9100 port.
	Enable [*]	Enables the Port9100 port.
IPP	Disable	Disables IPP port.
	Enable [*]	Enables IPP port.
SMB TCP/IP	Disable	Disables SMB TCP/IP port.
	Enable [*]	Enables SMB TCP/IP port.
SMB NetBEUI	Disable	Disables SMB Net BEUI port.
	Enable [*]	Enables SMB Net BEUI port.
WSD	Disable	Disables WSD port.
	Enable [*]	Enables WSD port.
SNMP UDP	Disable	Disables the SNMP UDP port.
	Enable [*]	Enables the Simple Network Management Protocol (SNMP) UDP port.
E-Mail Alert	Disable	Disables the E-Mail Alert feature.
	Enable [*]	Enables the E-Mail Alert feature.
EWS	Disable	Disables an access to Dell Printer Configuration Web Tool embedded in the printer.
	Enable [*]	Enables an access to Dell Printer Configuration Web Tool embedded in the printer.
Bonjour(mDNS)	Disable	Disables Bonjour (mDNS).
	Enable [*]	Enables Bonjour (mDNS).
Telnet	Disable	Disables Telnet.
	Enable [*]	Enables Telnet.
LLTD	Disable	Disables LLTD.
	Enable [*]	Enables LLTD.
HTTP-SSL/TLS ^{*1}	Disable	Disables HTTP-SSL/TLS.
	Enable [*]	Enables HTTP-SSL/TLS.

^{*1} This item is available only when a certificate is published using **Dell Printer Configuration Web Tool**.

IP Filter

 NOTE: IP Filter feature is available only for LPD or Port9100.

Purpose:

To block data received from certain IP addresses through the wired or wireless network. You can set up to five IP addresses. The change becomes effective after the printer is turned off and then on again.

Values:

No. n / Address (n is 1–5.)	Sets the IP address for Filter <i>n</i> .
No. n / Mask (n is 1–5.)	Sets the address mask for Filter <i>n</i> .
No. n / Mode (n is 1–5.) Off*	Disables the IP Filter feature for Filter <i>n</i> .
Accept	Accepts an access from the specified IP address.
Reject	Rejects an access from the specified IP address.

IEEE 802.1x

 NOTE: IEEE 802.1x feature is available only when the printer is connected using LAN cable and it is available only when the IEEE 802.1 authentication is enabled.

Purpose:

To disable IEEE 802.1x authentication. The change becomes effective after the printer is turned off and then on again.

Values:

Disable	Disables IEEE 802.1x.
----------------	-----------------------

Reset LAN

Purpose:

To initialize wired network data stored in non-volatile memory (NVM). After executing this function and rebooting the printer, all wired network settings are reset to their default values.

Values:

Are You Sure?	Press the  (Set) button to initialize the wired network data stored in NVM.
----------------------	--

USB Settings

Use the **USB Settings** menu to change printer settings affecting a USB port.

USB Port

Purpose:

To specify whether to enable the USB port. The change becomes effective after the printer is turned off and then on again.

Values:

Disable	Disables the USB interface.
Enable*	Enables the USB interface.

System Settings

Use **System Settings** to configure the power saving mode, warning tones, time-out duration, device display language, and job log auto print settings.



NOTE: Values marked by an asterisk (*) are the factory default menu settings.

Power Saver Timer

Purpose:

To specify the time for transition to power saver mode.

Values:

Sleep	3min.* 1–30 min.	Specifies the time taken by the printer to enter Sleep mode after it finishes a job.
Deep Sleep	10min.* 5–60 min.	Specifies the time taken by the printer to enter Deep Sleep mode after it has entered Sleep mode.

Enter 3 to put the printer in power saver mode 3 minutes after it finishes a job. This uses much less energy, but requires more warm-up time for the printer. Enter 3 if your printer shares an electrical circuit with room lighting and you notice lights flickering.

Select a high value if your printer is in constant use. In most circumstances, this keeps the printer ready to operate with minimum warm-up time. Select a value between 1 and 30 minutes for power save mode if you want a balance between energy consumption and a shorter warm-up period.

The printer automatically returns to the standby mode from the power saver mode when it receives data from the computer. You can also change the status of the printer to the standby mode by pressing any button on the operator panel.

Auto Reset

Purpose:

To automatically reset the settings to the default settings and return to the standby mode after you do not specify any settings for the specified time.

Values:

45sec*

1min

2min

3min

4min

Fault Time-out

Purpose:

To specify the amount of time the printer waits before canceling a job that stops abnormally. The print job is cancelled if the time-out time is exceeded.

Values:

Off	Disables the fault time-out.
------------	------------------------------

On*	60sec*	Sets the amount of time the printer waits before canceling a job that stops abnormally.
	3-300 sec.	

Job Time-out

Purpose:

To specify the amount of time the printer waits for data to arrive from the computer. The print job is cancelled if the time-out time is exceeded.

Values:

Off		Disables the job time-out.
On*	30sec* 5–300 sec.	Sets the time the printer waits for data to arrive from the computer.

Date & Time**Purpose:**

To specify the date and time formats.

Values:

Set Date & Time	Time Zone	Sets the time zone.
	Set Date	Sets the date.
	Set Time	Sets the time.
Date Format		Sets the date format.
Time Format	12H	Sets the time in the 12-hour format.
	24H*	Sets the time in the 24-hour format.

Audio Tone**Purpose:**

To configure settings for tones emitted by the printer during operation or when a warning message appears.

Values:

Control Panel	Off*	Does not emit a tone when the operator panel input is correct.
	On	Emits a tone when the operator panel input is correct.
Invalid Key	Off*	Does not emit a tone when the operator panel input is incorrect.
	On	Emits a tone when the operator panel input is incorrect.
Machine Ready	Off	Does not emit a tone when the printer is ready to process a job.
	On*	Emits a tone when the printer is ready to process a job.

Job Completed	Off	Does not emit a tone when a job is complete.
	On *	Emits a tone when a job is complete.
Fault Tone	Off	Does not emit a tone when a job ends abnormally.
	On *	Emits a tone when a job ends abnormally.
Alert Tone	Off	Does not emit a tone when a problem occurs.
	On *	Emits a tone when a problem occurs.
Out of Paper	Off	Does not emit a tone when the printer runs out of paper.
	On *	Emits a tone when the printer runs out of paper.
Low Toner Alert	Off	Does not emit a tone when a toner is low.
	On *	Emits a tone when a toner is low.
AutoClear Alert	Off *	Does not emit a tone 5 seconds before the printer performs auto clear.
	On	Emits a tone 5 seconds before the printer performs auto clear.
All Tones	Off	Disables all the alert tones.
	On *	Sets the volume of all the alert tones at once.

mm / inch

Purpose:

To specify the default measurement unit displayed after the numeric value on the operator panel.

Values:

Millimeters (mm) *	Selects millimeter as the default measurement unit.
Inches (")	Selects inch as the default measurement unit.



NOTE: The default for mm / inch varies depending on other settings, such as Country and Document Size.

Def. Paper Size

Purpose:

To specify the default paper size.

Values:

mm series

A4^{*1}

Letter

^{*1} Denotes country-specific factory default values.

inch series

A4

Letter^{*1}

^{*1} Denotes country-specific factory default values.

Auto Log Print

Purpose:

To automatically print a job history report after every 20 jobs.

Values:

Off^{*} Does not automatically print a job history report.

On Automatically prints a job history report.

Print logs can also be printed using the `Admin Reports` menu.

Print ID

Purpose:

To specify a location where the user ID is printed.

Values:

Off^{*} Does not print the user ID.

Top Left Prints the user ID on the top left of the page.

Top Right Prints the user ID on the top right of the page.

Bottom Left Prints the user ID on the bottom left of the page.

Bottom Right Prints the user ID on the bottom right of the page.



NOTE: When printing on DL size paper, a part of the user ID may not be printed correctly.

Print Text

Purpose:

To specify whether the printer outputs PDL data, which is not supported by the printer, as text when the printer receives it. Text data is printed on A4 or Letter size paper.

Values:

Off	Does not print the received data.
On *	Prints the received data as text data.

Banner Sheet



NOTE: Banner Sheet feature is available only when the optional 250-sheet feeder is installed to Dell 2150cdn Color Printer.

Purpose:

To specify the position of banner sheet, and also specify the tray in which the banner sheet is loaded.

Values:

Insert Position	Off *	Does not print the banner sheet.
	Front	Inserted before the first page of every job.
	Back	Inserted after the last page of every job.
	Front & Back	Inserted before the first page of every job and after the last page of every job.
Specify Tray	Tray 1 *	The banner sheet is loaded in the standard 250-sheet tray.
	Tray 2	The banner sheet is loaded in the optional 250-sheet feeder.

RAM Disk



NOTE: RAM Disk feature is available only when the optional 512 MB memory module is installed on the printer.

Purpose:

To allocate memory to the RAM disk file system for the Secure Print, Mailbox Print, and Proof Print features. The change becomes effective after the printer is turned off and then on again.

Values:

Disable		Does not allocate memory to the RAM disk file system. Secure Print and Proof Print jobs will abort and be recorded to the job log.
Enable*	300MB* 50-500MB	Sets the allocation of memory to the RAM disk file system in increments of 50 MB.



NOTE: Restart your printer when you change the settings for the RAM Disk menu.

Substitute Tray**Purpose:**

Specifies whether to use paper of a different size when the paper that is loaded in the specified tray does not match the paper size settings for the current job.

Values:

Off	No tray size substitute accepted.
Larger Size	Substitutes paper of next largest size. When there is no larger paper size, the printer substitutes paper of nearest size.
Nearest Size*	Substitutes paper of nearest size.

Set Avail. Time**Purpose:**

Sets the available time for the Print service.

Values:

Off*	Does not set the time when printing is available.
-------------	---

On	Sets the time when printing is available.
Start Time	Sets the start time of the available time.
End Time	Sets the end time of the available time.
Recurrence	Sets the day of the week to repeat the setting.

Secure Job Exp.



NOTE: Secure Job Exp. feature is available only when RAM Disk is set to Enable.

Purpose:

To specify the date and time to delete the files stored as Secure Print in the RAM disk.

Values:

Expiration Mode	Off*	Does not set the date and time to delete the files stored as Secure Print in the RAM disk.
	On	Sets the date and time to delete the files stored as Secure Print in the RAM disk.
Expiration Time	Sets the time to delete the files stored as Secure Print in the RAM disk.	
Recurrence	Daily	Sets the recurrence to delete the files stored as Secure Print in the RAM disk daily.
	Weekly*	Sets the recurrence to delete the files stored as Secure Print in the RAM disk weekly.
	Monthly	Sets the recurrence to delete the files stored as Secure Print monthly.
Weekly Setting	Monday	Sets the day of the week to delete the files stored as Secure Print.
	Tuesday	
	Wednesday	
	Thursday	
	Friday	
	Saturday	
	Sunday*	

Monthly Setting	1 Day *	Sets the day of the month to delete the files stored as Secure Print in the RAM disk.
	2-28 Day	

ColorTrack Mode

Purpose:

To specify who has access to color printing.

Values:

Off *	Does not limit access to color printing.
On	Limits access to color printing.

NoAcct User Prt

Purpose:

To specify whether to permit the printing of data without authentication information.

Values:

Off *	Does not permit non-account user to print the data.
On *1	Permits non-account user to print the data.

*1 Set **No Account User Password** using the Dell Printer Configuration Web Tool.

Col. Tra Err Rep

Purpose:

To specify whether to automatically print error-related information if printing with ColorTrack results in an error.

Values:

Off *	Does not print the error report when printing with Color Track results in an error.
On	Prints the error report when printing with Color Track results in an error.

LetterH Dup Mode



NOTE: LetterH Dup Mode feature is available only for Dell 2150cdn Color Printer.

Purpose:

To specify whether to print on both sides when using letterhead.

Values:

Disable*	Does not print on both sides of letterhead.
Enable	Prints on both sides of letterhead.

Low Toner Msg

Purpose:

To specify whether to show the alert message when the toner is low.

Values:

Off	Does not show the alert message when the toner is low.
On*	Shows the alert message when the toner is low.

Maintenance

Use the `Maintenance` menu to initialize the NV (non-volatile) memory, configure the plain paper quality adjustment settings, and configure the security settings.



NOTE: Values marked by an asterisk (*) are the factory default menu settings.

F/W Version

Purpose:

To confirm the current F/W version.

Service Tag

Purpose:

To confirm the service tag.

Express Code

Purpose:

To confirm the express service code.

Paper Density

Purpose:

To specify paper density settings.

Values:

Plain	Light
	Normal*
Label	Light
	Normal*

Adjust BTR



NOTE: The print quality changes depending on the setting values you select for this item.

Purpose:

To specify the transfer roller voltage adjustment for each paper type.

Values:

Plain	0* -6 to +6	Sets the transfer roller voltage in increments of 1. The default settings may not give the best output on all paper types. If you see mottles on the print output, try to increase the voltage. If you see white spots on the print output, try to decrease the voltage.
Plain Thick	0* -6 to +6	
Covers	0* -6 to +6	
Covers Thick	0* -6 to +6	
Label	0* -6 to +6	
Coated	0* -6 to +6	
Coated Thick	0* -6 to +6	
Envelope	0* -6 to +6	
Recycled	0* -6 to +6	

Adjust Fuser



NOTE: The print quality changes depending on the setting values you select for this item.

Purpose:

To adjust the fuser temperature setting for each paper type.

Values:

Plain	0* -6 to +6	Sets the fuser temperature in increments of 1. The default settings may not give the best output on all paper types. When the printed paper has curled, try to lower the temperature. When the toner does not fuse on the paper properly, try to increase the temperature.
Plain Thick	0* -6 to +6	
Covers	0* -6 to +6	
Covers Thick	0* -6 to +6	
Label	0* -6 to +6	
Coated	0* -6 to +6	
Coated Thick	0* -6 to +6	
Envelope	0* -6 to +6	
Recycled	0* -6 to +6	

Auto Reg Adj

Purpose:

To specify whether to automatically perform color registration adjustment.

Values:

Off	Does not automatically perform color registration adjustment.
On*	Automatically performs color registration adjustment.

Color Reg Adj

Purpose:

To manually perform color registration adjustment.

Manual Color Registration Adjustments are required when the printer is initially installed and after the printer is moved.

 **NOTE:** The Color Reg Adjust feature can be configured when Auto Reg Adjust is set to Off.

Values:

Auto Correct	Are You Sure?	Press the ✓ (Set) button to automatically perform color registration correction.
ColorReg Chart	Are You Sure?	Press the ✓ (Set) button to print a color registration chart. The color registration chart prints a lattice pattern of yellow, magenta, and cyan lines. On the chart, find the values on the right side that are next to the line that is perfectly straight for each of the three colors. If the value for the this line is 0, color registration adjustment is not required. If the value for this line is any value other than 0, specify the adjustment values.
Enter Number	Enter (LY, LM, LC) Enter (RY, RM, RC) Enter (PY, PM, PC)	Sets lateral (perpendicular to paper feed direction) and process (paper feed direction) color adjustment values individually for Yellow, Magenta, and Cyan. Enter a number in order of lateral adjustment (left), lateral adjustment (right), and process adjustment. Press the ✓ (Set) button to save all the settings.

 **NOTE:** Ensure that you remove the paper from the single sheet feeder before performing Auto Correct.

Clean Developer

Purpose:

To stir the toner in a new toner cartridge.

Values:

Are You Sure?	Press the ✓ (Set) button to stir the toner in a new toner cartridge.
----------------------	---

Toner Refresh

Purpose:

To clean the toner in each toner cartridge.

Values:

Yellow, Magenta, Cyan, Black	Are You Sure?	Press the ✓ (Set) button to clean the toner in the selected toner cartridge.
-------------------------------------	----------------------	--

Drum Refresh

Purpose:

To clean the surface of the PHD unit.

Values:

Are You Sure?	Press the ✓ (Set) button to clean the surface of the PHD unit.
----------------------	--

Reset Defaults

Purpose:

To initialize the non-volatile (NV) memory. After executing this function and rebooting the printer, all the menu parameters are reset to their default values.

Values:

Are You Sure?	Press the ✓ (Set) button to initialize the system parameters.
----------------------	---

Init PrintMeter

Purpose:

To initialize the print meter of the printer. When the print meter is initialized, the meter count is reset to zero.

Values:

Are You Sure?	Press the ✓ (Set) button to initialize the print meter.
----------------------	---

Clear Storage



NOTE: Clear Storage feature is available only when the optional 512 MB memory module is installed.

Purpose:

To clear all files stored as Secure Print, Mailbox Print, Proof Print, and Stored Print in the RAM disk.

Values:

All Clear	Are You Sure?	Press the ✓ (Set) button to delete all files stored as Secure Print, Mailbox Print, and Proof Print in the RAM disk.
Secure Document	Are You Sure?	Press the ✓ (Set) button to delete all files stored as Secure Print and Mailbox Print in the RAM disk.
Stored Document	Are You Sure?	Press the ✓ (Set) button to delete all files stored as Stored Print in the RAM disk.

Non-DELL Toner

Purpose:

To use toner cartridge of another manufacturer.



NOTICE: Using a non-Dell toner cartridge may severely damage your printer. The warranty does not cover damages caused by using non-Dell toner cartridges.

Values:

Off*	Does not use toner cartridge of another manufacturer.
On	Uses toner cartridge of another manufacturer.

Adjust Altitude

Purpose:

To specify the altitude of the location where the printer is installed.

The discharge phenomenon for charging the photo conductor varies with barometric pressure. Adjustments are performed by specifying the altitude of the location where the printer is being used.



NOTE: An incorrect altitude adjustment setting leads to poor printing quality, incorrect indication of remaining toner, etc.

Values:

0m*	Sets the altitude of the location where the printer is installed.
1000m	
2000m	
3000m	

Secure Settings

Use the **Secure Settings** menu to set a password to limit access to the menus. This prevents items from being changed accidentally.



NOTE: Values marked by an asterisk (*) are the factory default menu settings.

See also:

"Panel Lock"

Panel Lock

Purpose:

To set the limited access to **Admin Menu** with a password, and to set or change the password.

Values:

Panel Lock Set	Disable*	Disables password protection for Admin Menu .
	Enable	Enables password protection for Admin Menu .
Change Password*¹	0000-9999	Sets or changes the password required to access Admin Menu .

^{*1} This item is available only when **Panel Lock Set** is set to **Enable**.

Login Error



NOTE: Login Error feature is available only when **Panel Lock Set** is set to **Enable**.

Purpose:

To specify the number of error entry attempts allowed when you log in as an administrator in the **Admin Menu** and **Report/List** menu.

Values:

Off *	Does not allow an administrator to log in after one error entry attempt.
On 5	Sets the number of error entry attempts allowed when an administrator logs in.
1-10	

Tray Settings

Use the `Tray Settings` menu to define the print media loaded in the standard 250-sheet tray and the optional 250-sheet feeder.



NOTE: Values marked by an asterisk (*) are the factory default menu settings.

Tray 1

Purpose:

To specify the paper loaded in the standard 250-sheet tray.

Values:

Paper Size	A4^{*1}
mm series	A5
	B5
	Letter
	Folio
	Legal
	Executive
	Envelope #10
	Monarch
	Monarch LEF
	DL
	DL LEF
	C5
	Custom Size
inch series	Letter^{*1}
	Folio
	Legal
	A4
	A5
	B5
	Executive
	Envelope #10
	Monarch
	Monarch LEF
	DL
	DL LEF
	C5
	Custom Size

Paper Type	Plain [*]	
	Plain Thick	
	Covers	
	Covers Thick	
	Label	
	Envelope	
	Recycled	
	Letterhead	
	Preprinted	
	Prepunched	
	Color	
	Plain S2	
	Plain Thick S2	
	Recycled S2	
	Color S2	
Display Popup	Off	Does not display a popup message that prompts to set Paper Type and Paper Size when paper is loaded in the standard 250-sheet tray.
	On [*]	Displays a popup message that prompts to set Paper Type and Paper Size when paper is loaded in the standard 250-sheet tray.

^{*}1 Denotes country-specific factory default value.



NOTE: For more information on supported paper sizes, see "Supported Paper Sizes."

Tray 2



NOTE: Tray 2 feature is available only when the optional 250-sheet feeder is installed.

Purpose:

To specify the paper loaded in the optional 250-sheet feeder.

Values:

Paper Size	A4^{*1}
mm series	A5
	B5
	Letter
	Folio
	Legal
	Executive
inch series	Letter^{*1}
	Folio
	Legal
	A4
	A5
	B5
	Executive
Paper Type	Plain[*]
	Plain Thick
	Recycled
	Letterhead
	Preprinted
	Prepunched
	Color
	Plain S2
	Plain Thick S2
	Recycled S2
	Color S2

Display Popup	Off	Does not display a popup message that prompts to set <code>Paper Type</code> and <code>Paper Size</code> when paper is loaded in the standard 250-sheet feeder.
	On [*]	Displays a popup message that prompts to set <code>Paper Type</code> and <code>Paper Size</code> when paper is loaded in the standard 250-sheet feeder.

^{*1} Denotes country-specific factory default value.

Panel Language

Purpose:

To determine the language of the text on the operator panel screen.

Values:

English^{*}

Français

Italiano

Deutsch

Español

Dansk

Nederlands

Norsk

Svenska

Print Menu

Use the Print Menu to print a job using the Secure Print, Private Mail Box, Public Mail Box, and Proof Print features.



NOTE: Values marked by an asterisk (*) are the factory default menu settings.

Secure Print



NOTE: Secure Print feature is available only when `RAM disk` is set to `Enable`.

Purpose:

To print confidential jobs. The printer can hold the job in memory until you arrive at the printer and type the password on the operator panel.

Values:

Select User ID	Enter the password you specified on the printer driver.	
All Documents ^{*1}	Print and Del	Deletes all documents from print memory after printing them.
	Delete	Deletes all documents from print memory.
document n ^{*2}	Print and Del	Deletes the specified document from print memory after printing it.
	Delete	Deletes the specified document from print memory.

*1 This item is available only when the multiple print jobs are stored.

*2 The document name is displayed. The save date and time are displayed if the document name is not specified.

Private Mail Box



NOTE: Private Mail Box feature is available only when RAM disk is set to Enable.

Purpose:

To specify whether and how to print the job stored in the Private Mail Box.

Values:

Select User ID	Enter the password you specified on the printer driver.	
All Documents ^{*1}	Print and Del	Deletes all documents from print memory after printing them.
	Print	Prints all documents and saves them in memory.
	Delete	Deletes all documents from print memory.
document n ^{*2}	Print and Del	Deletes the specified document from print memory after printing it.
	Print	Prints the specified document and saves it in memory.
	Delete	Deletes the specified document from print memory.

*¹ This item is available only when the multiple print jobs are stored.

*² The document name is displayed. The save date and time are displayed if the document name is not specified.

Public Mail Box



NOTE: Public Mail Box feature is available only when RAM disk is set to Enable.

Purpose:

To specify whether and how to print the job stored in the Public Mail Box.

Values:

Select User ID	All Documents ^{*1}	Print and Del	Deletes all documents from print memory after printing them.
		Print	Prints all documents and saves them in memory.
		Delete	Deletes all documents from print memory.
	document n ^{*2}	Print and Del	Deletes the specified document from print memory after printing it.
		Print	Prints the specified document and saves it in memory.
		Delete	Deletes the specified document from print memory.

*1 This item is available only when the multiple print jobs are stored.

*2 The document name is displayed. The save date and time are displayed if the document name is not specified.

Proof Print



NOTE: Proof Print feature is available only when RAM disk is set to Enable.

Purpose:

To print only one copy and check the print result before printing all of the copies. This prevents a large number of misprinted copies from being printed at one time.

Values:

Select User ID	All Documents *1	Print and Del	Deletes all documents from print memory after printing them.
		Print	Prints all documents and save them in memory.
		Delete	Deletes all documents from print memory.
	document n *2	Print and Del	Deletes the specified document from print memory after printing it.
		Print	Prints the specified document and save it in memory.
		Delete	Deletes the specified document from print memory.

*1 This item is available only when the multiple print jobs are stored.

*2 The document name is displayed. The save date and time are displayed if the document name is not specified.







Panel Lock





This feature prevents unauthorized personnel from changing the settings made by the administrator. For regular printing, items can be selected from the menu and printer settings remain unchanged. For regular printing, items can be configured using the printer driver.





NOTE: Disabling the operator panel menus does not prevent access to the Stored Print and Tray Settings menus.



Enabling the Panel Lock

- 1 Press the  (**Menu**) button.
- 2 Press  button until **Admin Menu** appears, and then press the  (**Set**) button.
- 3 Press  button until **Secure Settings** appears, and then press the  (**Set**) button.
- 4 Ensure that **Panel Lock** is displayed, and then press the  (**Set**) button.
- 5 Ensure that **Panel Lock Set** is displayed, and then press the  (**Set**) button.









- 6 Press  button until `Enable` appears, and then press the  **(Set)** button.
- 7 Enter the new password, and then press the  **(Set)** button.
- 8 Re-enter the password to confirm the password that you entered, and then press the  **(Set)** button.

The password has been changed.

 **NOTE:** If you forget your password, turn off the printer. Then, while holding the  **(Menu)** button, turn on the printer. Perform steps 7 to 8 to reset the password.

 **NOTE:** If you change the password while `Panel Lock` is `Enable`, follow the following steps. Perform steps 1 to 4 above. Press  button until `Change Password` appears, and then press the  **(Set)** button. Perform steps 7 and 8 above to change the password. This will change the password.

Disabling the Panel Lock



- 1 Press the  **(Menu)** button.
- 2 Press  button until `Admin Menu` appears, and then press the  **(Set)** button.
- 3 Press  button until `Secure Settings` appears, and then press the  **(Set)** button.
- 4 Ensure that `Panel Lock` is displayed, and then press the  **(Set)** button.
- 5 Ensure that `Panel Lock Set` is displayed, and then press the  **(Set)** button.
- 6 Ensure that `Disable` is displayed, and then press the  **(Set)** button.
- 7 Enter the current password, and then press the  **(Set)** button.





The setting has been changed.

Resetting Defaults

After executing this function and rebooting the printer, all the menu parameters, except the parameters for the network, are reset to their default values.

When Using the Operator Panel

- 1 Press the  **(Menu)** button.
- 2 Press  button until `Admin Menu` appears, and then press the  **(Set)** button.

- 3 Press  button until Maintenance appears, and then press the  **(Set)** button.
- 4 Press  button until Reset Defaults appears, and then press the  **(Set)** button.
- 5 Ensure that Are You Sure? is displayed, and then press the  **(Set)** button.

The printer is restarted automatically.

Understanding Your Printer Software

Use the *Drivers and Utilities* CD that shipped with your printer to install a combination of software programs, depending on your operating system.

Printer Status Window

The **Printer Status** window alerts you when there is a warning or when an error occurs, for example, when a paper jam occurs or toner is running low.

By default, the **Printer Status** window launches only when an error occurs. When an error occurs, the error message appears on the **Printer Status** window. You can set the **Printer Status** window to always launch when printing in **Printing Status Window Properties**.

You can also check toner level, quantity of paper remaining or the configuration of options for the local printer.

Status Monitor Console

Use the **Status Monitor Console** to manage multiple instances of the **Status Window** for a particular printer.

Select a printer from the list view (or **Printer Selection**) by clicking its name to open a **Status Window** for a particular printer.

Dell Supplies Management System

You can launch the **Dell Supplies Management System** dialog box from the **All Programs** menu or the desktop icon.

You can order consumables by phone or from the web.

- 1 Click **Start**→ **All Programs**→ **Dell Printers**→ **Additional Color Laser Software**→ **Dell Supplies Management System**.

The **Dell Supplies Management System** window appears.

- 2 Select your printer from the **Select Printer Model** list.
- 3 If you are ordering from the web:

- a When you cannot get information from the printer automatically by two-way communication, a window prompting you to type the Service Tag appears. Type the Service Tag of your Dell printer in the field provided.
Your Service Tag is located inside the toner access cover of your printer.
 - b Select a URL from the **Select Reorder URL** list.
 - c Click **Visit Dell printer supplies ordering web site**.
- 4 If you order by phone, call the number that appears in the **Order by Phone** section.

User Setup Disk Creating Tool

The **User Setup Disk Creating Tool** program located in the **MakeDisk** folder of the **Utilities** folder on the *Drivers and Utilities* CD and the printer drivers located on the *Drivers and Utilities* CD are used to create driver installation packages that contain custom driver settings. A driver installation package can contain a group of saved printer driver settings and other data for things such as:

- Print orientation and Multiple Up (document settings)
- Watermarks
- Font references

If you want to install the printer driver with the same settings on multiple computers running the same operating system, create a setup disk in a floppy disk or in a server on the network. Using the setup disk that you have created will reduce the amount of work required when installing the printer driver.

- Install the Dell™ 2150cn Color Printer driver in the computer on which the setup disk is to be created.
- The setup disk can only be used on the operating system on which the disk was created or computers running the same operating system. Create a separate setup disk for each of the operating systems.

Software Update

The firmware and/or driver updates can be downloaded from the Dell Support web site located at **support.dell.com**.

Printer Settings Utility

You can open the **Status Window**, **Tool Box**, **Updater**, and **Troubleshooting** using the **Quick Launch Utility** window.

 **NOTE:** **Quick Launch Utility** is only supported on Windows.

To use the **Quick Launch Utility**, select to install the **Quick Launch Utility** when you install the Dell software.

For information about installing the software, see "Setting Up for Shared Printing."

To open the **Quick Launch Utility** window:

- 1 Click **Start**→ **All Programs**→ **Dell Printers**→ **Additional Color Laser Software**→ **Quick Launch Utility**.

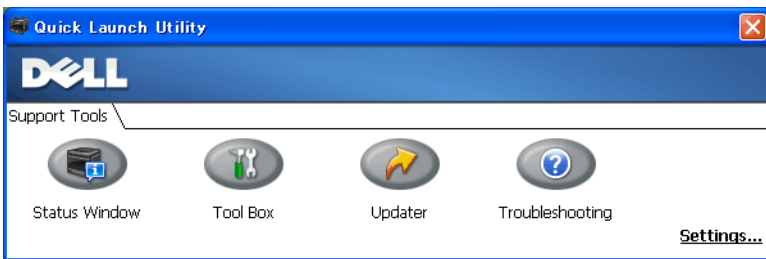

The **Quick Launch Utility** window provides four buttons: **Status Window**, **Tool Box**, **Updater**, and **Troubleshooting**.

To exit the **Quick Launch Utility** window:

- 1 Click the X button at the top-right of the window.
For details, click the **Help** button of each application.

Status Window

The **Status Window** button opens the **Printer Status** window. For more information about using Status Window, refer to "Printer Status Window."

Tool Box

The **Tool Box** button opens the Tool Box. For more information about using Tool Box, refer to "Understanding the Tool Box Menus."

Updater

The **Updater** button updates the Dell software and printer firmware.

Troubleshooting

The **Troubleshooting** button opens the Troubleshooting Guide, which allows you to solve problems by yourself.

Status Monitor Widget for Macintosh

Status Monitor Widget is a printer utility that promotes efficient use of the printer through the exchange of information between the Macintosh and the printer.

Status Monitor Widget Feature

- **Monitoring Dell Printers**
Allows you to check the status of Dell printers currently connected to your Macintosh
- **Receiving Alerts**
Alerts you to problems, such as paper jams or low toner
- **Ordering Supplies**
Allows you to access the web site to order supplies

Before Installing the Status Monitor Widget

Operating systems

- Mac OS X 10.4.11
- Mac OS X 10.5
- Mac OS X 10.6

Network protocols and interfaces

- LPR
- Socket 9100
- Bonjour

- USB 2.0 and 1.1 (When connecting with multiple printers of the same model via USB cables, only the printer recognized first can be monitored in the **Status Monitor Widget**.)

Installing the Status Monitor Widget

- 1 Double-click the **Status Monitor Installer** icon in the **Finder** window.
- 2 Follow the on-screen instructions.

When the **Install Succeeded** screen appears, the installation is complete.

 **NOTE:** Entering the administrative login name and password are required during the installation process.

Opening and Closing the Status Monitor Widget

Opening the Status Monitor Widget

- 1 Click the Dashboard icon in the Dock to launch Dashboard.



- 2 Click the Plus (+) sign to display the Widget Bar.

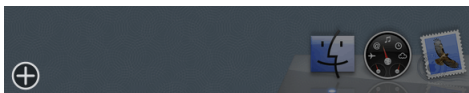

- 3 Click the icon of **Status Monitor** in the Widget Bar. The **Printer Status** window appears.

 **NOTE:** If the message **Select a printer** is displayed, select your printer in **Preferences**. (For more information on Preferences, see "Preferences.")

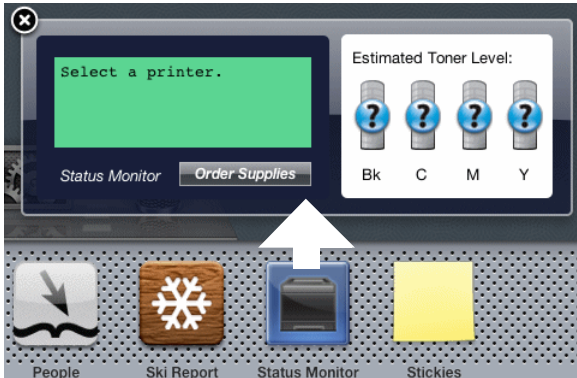

Closing the Status Monitor Widget

- 1 Click the Close (x) button in the upper-left corner of the **Printer Status** window.

Printer Status Window

When the **Status Monitor Widget** is activated, the **Printer Status** window appears on Dashboard.

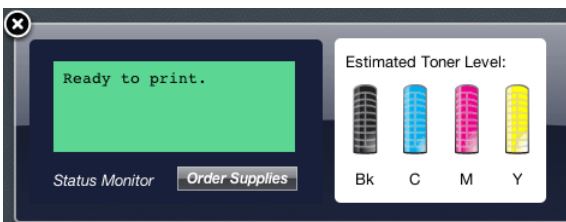

Printer Status Message Area

Displays a message of the current printer status.

 **NOTE:** The **Status Monitor Widget** automatically obtains the printer information at the updated interval that can be specified in **Preferences**. Also, the printer status is refreshed when Dashboard is launched or **Preferences** is closed.

 **NOTE:** If the **Status Monitor Widget** receives no response from the printer, the message **Cannot get printer information** is displayed.

 **NOTE:** When the printer is connected via USB cable, you cannot check the status of the printer during a print job.

Printer Status Image Area

Displays the image of printer condition.

- Estimated Toner Level image

Displays the estimated toner level of each color if the printer is functioning properly.



 **NOTE:** If the utility does not receive a response from the printer, the **Unknown** toner image is displayed.

- Printer error image

Displays an indication image when an error occurs.



An error has occurred and the printer requires your attention to correct a problem.



An error has occurred and the printer cannot be used.



An unknown error has occurred and the printer cannot be used.

Order Supplies button

Click this button to display the **Order** window.

To hide the **Order** window, click **Order Supplies** again.

Info (i) button

Click this button to open **Preferences**.

 **NOTE:** The **info (i)** button appears on the lower-right corner of the window when the cursor is over the **Printer Status** window. The **info (i)** button is a standard used across all widgets.

Order Window

This window provides you with the information for ordering printer supplies by telephone or from the web site.

To open the **Order** window:

- 1 Click the **Order Supplies** in the **Printer Status** window.

The **Order** window appears.

 **NOTE:** The **Order** window appears when low toner is detected.

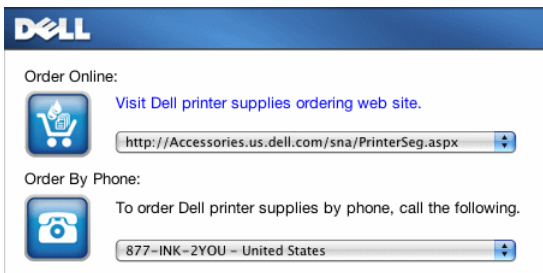

Order Online

- **Visit Dell printer supplies ordering web site** hyperlink

Click the **Visit Dell printer supplies ordering web site** hyperlink to access the web site for ordering Dell printer supplies.

- URL list

Displays a list of available URLs where you can order Dell printer supplies.

Select a URL address to use when the **Visit Dell printer supplies ordering web site** hyperlink is clicked.

Order By Phone

- Phone number list

Displays a list of available phone numbers that you can call to order Dell printer supplies.

Preferences

To open **Preferences**:

- 1 Click the **info (i)** button in the **Printer Status** window.

Preferences appears.

 **NOTE:** The **info (i)** button appears on the lower-right corner of the window when the cursor is over the **Printer Status** window. The **info (i)** button is a standard used across all widgets.

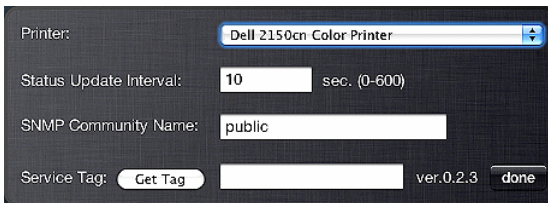

Printer

Displays a list of available printer names in the pull down menu. The first printer displayed in this list is set as default.

Status Update Interval

You can specify the update interval of the printer status. By default, it is set to obtain the printer information every 10 seconds. It can be set from 0 second to 600 seconds.

SNMP Community Name

You can change the SNMP (Simple Network Management Protocol) community name if using default community name (public). Up to 31 characters can be entered.

Service Tag button

Click this button to obtain the service tag.



NOTE: You cannot retrieve the service tag when the printer is connected via USB cable.

done button

Click this button to return to the **Printer Status** window.

Status Monitor Console for Linux

Status Monitor Console is a printer utility that promotes efficient use of the printer through the exchange of information between the Linux and the printer.

Status Monitor Console Feature

- **Monitoring Dell Printers**
Allows you to check the status of Dell printers currently connected to your Linux.
- **Receiving Alerts**
Alerts you to problems, such as paper jams or low toner.
- **Ordering Supplies**
Allows you to access the web site to order supplies.

Before Installing the Status Monitor Console



NOTE: The Status Monitor Console requires the following modules installed.

- Python, PyGTK, Net-SNMP, cups-libs, and xog-open

Please confirm that these modules are installed before you install the Status Monitor Console.



NOTE: The Status Monitor Console is available when the printer is connected to a network (LPR or Socket 9100). USB connection is not supported.

Distributions

- Red Hat[®] Enterprise Linux[®] WS 4
- Red Hat Enterprise Linux 5 Desktop

- SUSE® Linux Enterprise Desktop 10
- SUSE Linux Enterprise Desktop 11

Printing system

- CUPS (Common Unix Printing System)

Installing the Status Monitor Console

- 1 Activate the terminal, and log in as a super user.
- 2 Type the following rpm command in the terminal window.

```
# rpm -ivh (Type the package file name)
```

Starting the Status Monitor Console

- 1 Click **Dell Printers**→ **Status Monitor Console**

The **Printer Selection** window appears.

For more information on Printer Selection window, see "Printer Selection Window."

- 2 Select your printer.

The **Printer Status** window appears.

For more information on Printer Status window, see "Printer Status Window."

- You can order supplies from the **Dell Supplies Management System** window. See "Dell Supplies Management System Window."

Printer Selection Window

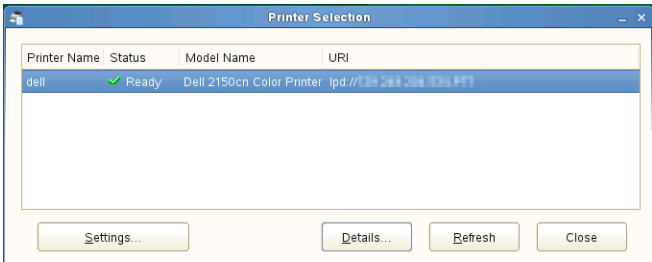

Printers list

All the printers registered in the CUPS (Common UNIX Printing System) are displayed in a list.

- Status icons:
 - ✓ Ready
 - ⚠ Unknown/Offline/Toner Low/Paper Low
 - ✖ Door Open/Paper Jam/No Toner/Out Of Paper

Settings button

Click this button to open the **Settings** window.

Details button

Click this button to open the **Printer Status** window. If a non-supported printer is selected, it opens the **Dell Printer Configuration Web Tool**. For details on the Dell Printer Configuration Web Tool, see "Dell Printer Configuration Web Tool."

Refresh button

Click this button to update the information of printers.

Close button

Click this button to close the **Printer Selection** window.

Printer Status Window

When the printer is specified in the **Printer Selection** window, the **Printer Status** window appears.

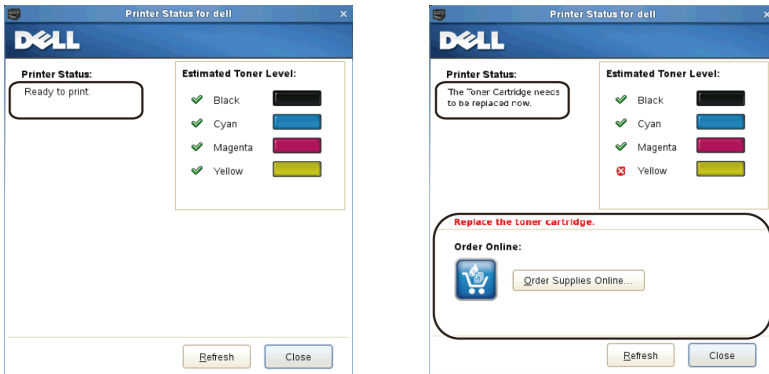

Printer Status Message Area

Displays a message of the current printer status.







NOTE: The **Status Monitor Console** automatically obtains the printer information at the updated interval that can be specified in the **Settings** window. Also, the printer status is refreshed when the **Refresh** is clicked.



NOTE: If the **Status Monitor Console** receives no response from the printer, the message **Cannot get printer information** is displayed.

Printer Status Image Area

- Current Toner Status icons
 - Displays icons of the current status of each toner.
 -  The toner level is more than 30%.
 -  The toner level is less than 29%.
 -  The toner level is less than 9%.
 -  The toner level is unknown.
- Estimated Toner Level images
 - Keeps you informed about the amount of toner that remains for each color.

Toner Alert

Displays an alert message when any remaining toner is low, empty, or unknown.

Order Online

- **Order Supplies Online** button

Click this button to access the web site for ordering Dell printer supplies.

This button appears when the amount of toners becomes less than 30%.

Refresh button

Click this button to update the status of the printer.

Close button

Click this button to close the **Printer Status** window.

Dell Supplies Management System Window

This window provides you with the information for ordering printer supplies by telephone or from the web site.

To open the **Dell Supplies Management System** window:

- 1 Click **Order Supplies Online** button in the **Printer Status** window.

OR

Click **Dell Printers**→ **Dell Supplies Management System**.



Select Printer Model

Select your printer model name.

Order Online

- **Order Supplies Online** button
 - When the Regular URL is selected in the **Select Reorder URL**:
Click this button to open the **Service Tag** window.
 - When the Premier URL is selected in the **Select Reorder URL**:
Click this button to open the procurement and support web site.

- **Select Reorder URL**

Displays a list of available URLs where you can order Dell printer supplies. Select a URL address to use when the **Order Supplies Online** button is clicked.

- Regular URL: <http://Accessories.us.dell.com/sna/PrinterSeg.aspx>
- Premier URL: <http://premier.dell.com>

Order by Phone

- **To order Dell printer supplies by phone, call the following**

Select your country with phone number from the list, and call the displayed telephone number to order supplies.

Close button

Click this button to close the **Dell Supplies Management System** window.

Service Tag Window



- 1 Enter the Dell printer service tag.



NOTE: For information on the service tag, see "Express Service Code and Service Tag."

Settings Window

To open the **Settings** window:

- 1 Click the **Settings** button in the **Printer Selection** window.

The **Settings** window appears.

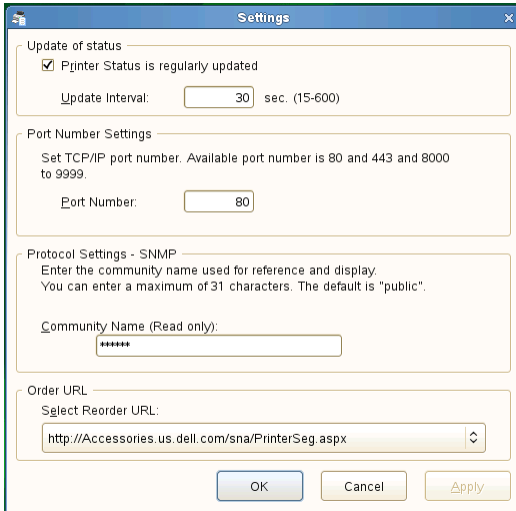

Update of status

- **Printer Status is regularly updated** check box

Select the check box to enable/disable the Printer Status to be updated by the specified interval.

- **Update interval** text box

Specify the update interval of the printer status.

Port Number Settings

- **Port Number**

Specify the port number in the **Port Number** text box to open the setting page of your printer in a web browser.

Protocol Settings - SNMP

- **Community Name**

Enter the Community name of SNMP in the **Community Name** text box.

Order URL

- **Select Reorder URL**

The selected URL address is set as default web site for the **Select Reorder URL** in the **Dell Supplies Management System** window.

Understanding Fonts

Typefaces and Fonts

A font is a set of characters and symbols created with a distinct design. The distinct design is called a *typeface*. The typefaces you select add personality to a document. Well-chosen typefaces make a document easier to read.

The printer has numerous resident fonts in PCL 5/PCL 6. See "Resident Fonts" for a listing of all resident fonts.

Weight and Style

Typefaces are often available in different weights and styles. These variations modify the original typeface so you can, for example, emphasize important words in text or highlight book titles. The different weights and styles are designed to complement the original typeface.

Weight refers to the thickness of the lines that form the characters. Thicker lines result in darker characters. Some words commonly used to describe the weight of a typeface are bold, medium, light, black, and heavy.

Style refers to other typeface modifications, such as tilt or character width. Italic and oblique are styles where the characters are tilted. Narrow, condensed, and extended are three common styles that modify the character widths.

Some fonts combine several weight and style modifications; for example, Helvetica BdoB. A group of several weight and style variations of a single typeface is called a *typeface family*. Most typeface families have four variations: regular, italic (oblique), bold, and bold italic (bold oblique). Some families have more variations, as the following illustration for the Helvetica typeface family shows:

Helvetica	ABCDEFGHIJKLMNOPQRSTUVWXYZabcdefghijklmnopqrstuvwxyz1234567890
<i>Helvetica Oblique</i>	<i>ABCDEFGHIJKLMNOPQRSTUVWXYZabcdefghijklmnopqrstuvwxyz1234567890</i>
Helvetica Bold	ABCDEFGHIJKLMNOPQRSTUVWXYZabcdefghijklmnopqrstuvwxyz1234567890
<i>Helvetica Bold Oblique</i>	<i>ABCDEFGHIJKLMNOPQRSTUVWXYZabcdefghijklmnopqrstuvwxyz1234567890</i>
Helvetica Narrow	ABCDEFGHIJKLMNOPQRSTUVWXYZabcdefghijklmnopqrstuvwxyz1234567890
<i>Helvetica Narrow Oblique</i>	<i>ABCDEFGHIJKLMNOPQRSTUVWXYZabcdefghijklmnopqrstuvwxyz1234567890</i>
Helvetica Narrow Bold	ABCDEFGHIJKLMNOPQRSTUVWXYZabcdefghijklmnopqrstuvwxyz1234567890
<i>Helvetica Narrow Bold Oblique</i>	<i>ABCDEFGHIJKLMNOPQRSTUVWXYZabcdefghijklmnopqrstuvwxyz1234567890</i>

Pitch and Point Size

The size of a font is specified as either a pitch or point size, depending on whether the font is fixed space or proportional.

In *fixed space* fonts, each character has the same width. *Pitch* is used to specify the size of fixed space fonts. It is a measure of the number of characters that will print in one horizontal inch of type. For example, all 10-pitch fonts print 10 characters per inch (cpi) and all 12-pitch fonts print 12 cpi:

Courier	10 Pitch	1234567890
Courier-Bold	10 Pitch	1234567890
Courier	12 Pitch	123456789012
Courier-Bold	12 Pitch	123456789012



In *proportional* (or *typographic*) fonts, every character can have a different width. Since proportional fonts have characters with different widths, the font size is specified in point size, not pitch. *Point size* refers to the height of the characters in the font. A *point* is defined as 1/72 inch. The characters in a font printed at 24 point will be twice as large as the characters in the same font printed at 12 point.

The following illustration shows samples of a font printed in different point sizes:

48 point 36 point

24 point 18 point 12 point 10 point

The point size of a font is defined as the distance from the top of the tallest character in the font to the bottom of the lowest character in the font. Due to the definition of point size, different fonts printed at the same point size may appear quite different in size. This is because there are other font parameters that affect how the font looks. However, the point size of a font is an excellent specification of the relative size of a font. The following examples illustrate two very different proportional fonts at 14 point:

ITC Avant Garde
abcdefghijklmnopABCDEF GH
ITC Zapf Chancery
abcdefghijklmnopABCDEF GH

Bitmapped and Scalable Fonts

The printer uses both bitmapped and scalable fonts.

Bitmapped fonts are stored in print memory as predefined patterns of bits that represent a typeface at a specific size, style, and resolution. The following illustration shows an example of a character from a bitmapped font.

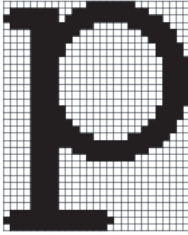

Bitmapped fonts are available in different type styles and point sizes as downloadable fonts.

Scalable fonts (also called *outline* fonts) are stored as computer programs that define the outlines of the characters in the font. Each time you print characters from a scalable font, the printer creates a bitmap of the characters at the point size you choose and saves it temporarily in print memory.



These temporary bitmapped fonts are deleted when you turn off or reset the printer. Scalable fonts provide the flexibility of printing in many different point sizes.

Your printer uses different scalable font formats for downloading fonts to the printer. PCL 5/PCL 6 uses Intellifont and TrueType scalable fonts. There are thousands of different scalable fonts available in these different font formats from numerous font suppliers.

If you plan to use many downloadable bitmapped or scalable fonts or if you plan to use many different sizes of scalable fonts, you may need to purchase additional memory for your printer.

Resident Fonts

Your printer is equipped with resident fonts stored permanently in print memory. Different fonts are available in PCL 5/PCL 6. Some of the most popular typefaces, like Courier and TimesNew, are available for all printer languages.

The following table lists all the fonts resident in your printer. See "Printing Font Sample List" for instructions on how to print samples of the fonts. You can select the resident fonts from your software program or from the operator panel.

Resident bitmapped and scalable fonts		
PCL 5/PCL 6		
CG Times	CG Omega BdlT	Coronet
CG Times It		
CG Times Bd	Garamond Antiqua	Marigold
CG Times BdlT	Garamond Krsv	
	Garamond Hlb	Arial
Univers Md	Garamond KrsvHlb	Arial It
Univers MdlT		Arial Bd
Univers Bd	Courier	Arial BdlT
Univers BdlT	Courier It	
Univers MdCd	Courier Bd	TimesNew
Univers MdCdIt	Courier BdlT	TimesNew It
Univers BdCd		TimesNew Bd
Univers BdCdIt	LetterGothic	TimesNew BdlT
	LetterGothic It	
AntiqueOlv	LetterGothic Bd	Symbol
AntiqueOlv It		
AntiqueOlv Bd	Albertus Md	Wingdings
	Albertus XBd	
CG Omega		
CG Omega It	Clarendon Cd	
CG Omega Bd		

Resident bitmapped and scalable fonts		
PCL 5/PCL 6		
Times Roman	Palatino Roman	N C Schbk Roman
Times It	Palatino It	N C Schbk It
Times Bd	Palatino Bd	N C Schbk Bd
Times BdIt	Palatino BdIt	N C Schbk BdIt
Helvetica	ITCBookman Lt	ITC A G Go Bk
Helvetica Ob	ITCBookman LtIt	ITC A G Go BkOb
Helvetica Bd	ITCBookmanDm	ITC A G Go Dm
Helvetica BdOb	ITCBookmanDm It	ITC A G Go DmOb
CourierPS	HelveticaNr	ZapfC MdIt
CourierPS Ob	HelveticaNr Ob	
CourierPS Bd	HelveticaNr Bd	ZapfDingbats
CourierPS BdOb	HelveticaNr BdOb	
SymbolPS		

Symbol Sets

A symbol set is the collection of alphabetic and numeric characters, punctuation, and special characters available in the font you select. Symbol sets support the requirements for different languages or specific applications, such as math symbols used for scientific text.

In PCL 5/PCL 6, a symbol set also defines which character will print for each key on the keyboard (or more specifically, for each *code point*). Some applications require different characters at some code points. To support multiple applications and languages, your printer has 36 symbol sets for the resident PCL 5/PCL 6 fonts.

Symbol Sets for PCL 5/PCL 6

Not all font names support all of the symbol sets listed.

Roman 8 (Default)	ISO 8859-1 Latin 1	ISO 8859-2 Latin 2
ISO 8859-9 Latin 5	ISO 8859-10 Latin 6	PC-8
PC-8 DN	PC-775 Baltic	PC-850 Multilingual
PC-852 Latin 2	PC-1004 OS/2	PC Turkish
Windows 3.1 Latin 1	Windows 3.1 Latin 2	Windows 3.1 Latin 5
DeskTop	PS Text	MC Text
Microsoft Publishing	Math 8	PS Math
Pi Font	Legal	ISO 4 United Kingdom
ISO 6 ASCII	ISO 11 Swedish:names	ISO 15 Italian
ISO 17 Spanish	ISO 21 German	ISO 60 Norwegian v1
ISO 69 French	Windows 3.0 Latin 1	Windows Baltic
Symbol	Wingdings	ITC ZapfDingbats MS

Understanding Printer Messages





The printer operator panel displays error messages describing the current state of the printer and indicates possible printer problems you must resolve. This chapter provides a list of error codes and tells you how to clear error messages.

 **NOTICE:** When an error message appears, the print data remaining on the printer and the information accumulated in the memory of the printer are not secure.

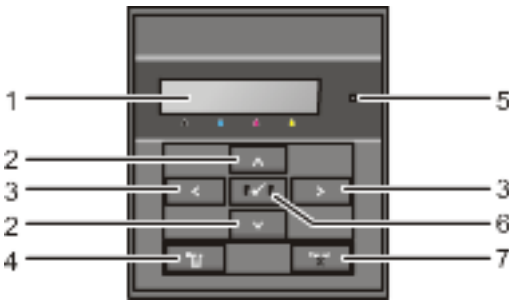
 **NOTE:** An error code is listed in an error message.

 **NOTE:** For error messages that are not listed in this chapter, refer to instructions in each error message.



1	LCD panel* ¹	2	 button
3	 button	4	 (Menu) button
5	Ready / Error LED* ²	6	 (Set) button
7	 (Cancel) button		

*¹ Displays an error message when an error occurs.

*² Lights green when the printer is ready or sleeping and blinks when data is being received. Lights orange when an error occurs and blinks when an unrecoverable print error occurs.

Error-Code What you can do

004-310	Turn off the printer. Confirm that the optional 250-sheet feeder is correctly installed, and turn on the printer. Contact customer support if this failure is repeated.
004-311	Turn off the printer. Confirm that the duplexer is correctly installed, and turn on the printer. Contact customer support if this failure is repeated.
004-312	Turn off the printer, and turn it on again. Contact customer support if this failure is repeated.
009-360	Turn off the printer. Confirm the yellow cartridge is correctly installed, and turn on the printer. Contact customer support if this failure is repeated.
009-361	Turn off the printer. Confirm the magenta cartridge is correctly installed, and turn on the printer. Contact customer support if this failure is repeated.
009-362	Turn off the printer. Confirm the cyan cartridge is correctly installed, and turn on the printer. Contact customer support if this failure is repeated.
009-363	Turn off the printer. Confirm the black cartridge is correctly installed, and turn on the printer. Contact customer support if this failure is repeated.
010-317	Turn off the printer and wait for 30 minutes. Open the front cover and make sure that the fuser is fully installed.
010-377	Turn off the printer. Confirm that the fuser is correctly installed, and turn on the printer. Contact customer support if this failure is repeated.
016-316	Turn off the printer. Remove the optional 512 MB memory module from the slot, and then reattach it firmly. Turn on the printer. Contact customer support if this failure is repeated.
016-317	Turn off the printer, and turn it on again. Contact customer support if this failure is repeated.
016-318	Remove the unsupported additional memory module. Contact customer support if this failure is repeated.
016-386	Turn off the printer, and turn it on again. Contact customer support if this failure is repeated.
016-387	
016-388	
016-391	Turn off the printer, and turn it on again. Contact customer support if this failure is repeated.
016-392	
016-393	
016-394	

016-404	Contact your system administrator.
016-405	
016-520	
016-521	
016-522	
016-523	
016-524	
016-527	
016-531	The account is not registered. Contact your system administrator.
016-532	
016-533	
016-545	
016-535	
016-536	
016-541	Contact your system administrator.
016-542	
016-543	
016-750	Press the ✓ (Set) button, or wait for 30 seconds for the printer to recover.
016-753	
016-755	
016-756	Contact your system administrator.
016-757	The account is not registered. Contact your system administrator.
016-758	The function cannot be used. Contact your system administrator.
016-759	Printable page limit is exceeded. Contact your system administrator.
016-786	Press the ✓ (Set) button, or wait for 30 seconds for the printer to recover. Check if the network cable is connected properly. If there is no problem with the network cable, contact server administrator.
016-790	
016-791	Press the ✓ (Set) button, or wait for 30 seconds for the printer to recover.
016-799	Press the ✓ (Set) button to clear the message and cancel the current print job. Confirm the configuration of the printer on the printer driver.

016-920	Press the ✓ (Set) button and try again.
016-921	
016-922	
016-930	The device is not supported. Remove it from the front USB port.
016-931	The USB hub is not supported. Remove it from the front USB port.
024-910	Reload the specified paper on the standard 250-sheet tray.
024-911	Reload the specified paper on the optional 250-sheet feeder.
024-914	Reload the specified paper on the SSF.
024-946	Insert the standard 250-sheet tray.
024-947	Insert the optional 250-sheet feeder.
027-452	Change IP address to avoid duplication. Turn off the printer, and turn it on again.
027-446	
042-700	Wait for a while until the printer cools down.
071-100	Remove the standard 250-sheet tray and jammed paper. Open and close the front cover.
071-920	Set side 2 of the sheet to the standard 250-sheet tray.
071-921	Press the ✓ (Set) button.
072-100	Remove the optional 250-sheet feeder and jammed paper. Open and close the front cover.
072-921	Press the ✓ (Set) button.
072-920	Set side 2 of the sheet to the optional 250-sheet feeder.
072-101	Remove the standard 250-sheet tray or the optional 250-sheet feeder, and remove the jammed paper. Open and close the front cover.
072-908	Remove the standard 250-sheet tray or the optional 250-sheet feeder, and remove the jammed paper. Open and close the front cover.
075-101	Open the front cover and remove the jammed paper, and then open and close the front cover.
075-102	Pull the jammed paper out of the SSF. Open and close the front cover.
072-921	Press the ✓ (Set) button.
075-922	Remove the paper from the SSF.
075-923	Pull the paper out of the SSF. Reload the paper in the SSF.
077-300	Close the front cover.

077-301	Close the toner access cover.
091-912	Remove the ribbon from the PHD unit. Contact customer support if this failure is repeated.
091-972	Open the front cover, and make sure that the PHD unit is fully installed.
092-310	Clean the CTD sensor.
092-910	
093-919	Remove and shake the yellow cartridge. Contact customer support if this failure is repeated.
093-920	Remove and shake the magenta cartridge. Contact customer support if this failure is repeated.
093-921	Remove and shake the cyan cartridge. Contact customer support if this failure is repeated.
093-922	Remove and shake the black cartridge. Contact customer support if this failure is repeated.
093-930	Open the toner access cover. Remove the used yellow cartridge, and install a new cartridge.
093-931	Open the toner access cover. Remove the used magenta cartridge, and install a new cartridge.
093-932	Open the toner access cover. Remove the used cyan cartridge, and install a new cartridge.
093-933	Open the toner access cover. Remove the used black cartridge, and install a new cartridge.
093-934	Open the toner access cover. Remove the used yellow cartridge, and install a new cartridge.
093-935	Open the toner access cover. Remove the used magenta cartridge, and install a new cartridge.
093-936	Open the toner access cover. Remove the used cyan cartridge, and install a new cartridge.
093-937	Open the toner access cover. Remove the used black cartridge, and install a new cartridge.
093-960	Open the toner access cover. Remove the unsupported yellow cartridge, and install a supported cartridge.
093-961	Open the toner access cover. Remove the unsupported magenta cartridge, and install a supported cartridge.

093-962	Open the toner access cover. Remove the unsupported cyan cartridge, and install a supported cartridge.
093-963	Open the toner access cover. Remove the unsupported black cartridge, and install a supported cartridge.
093-965	Open the front cover. Remove the unsupported PHD unit, and install a supported unit.
093-970	Open the toner access cover, and make sure that the yellow cartridge is fully installed.
093-971	Open the toner access cover, and make sure that the magenta cartridge is fully installed.
093-972	Open the toner access cover, and make sure that the cyan cartridge is fully installed.
093-973	Open the toner access cover, and make sure that the black cartridge is fully installed.
116-752	Press the  (Set) button, or wait for 30 seconds for the printer to recover.

Printing With Web Services on Devices (WSD)

This section provides information for network printing with WSD, the new Microsoft® protocol for Microsoft Windows® Vista®, Windows Server® 2008, Windows Server 2008 R2, and Windows 7.

Adding Roles of Printer Services

When you use Windows Server 2008 or Windows Server 2008 R2, you need to add the roles of print services to the Windows Server 2008 or Windows Server 2008 R2 client.

For Windows Server 2008:

- 1 Click **Start**→ **Administrative Tools**→ **Server Manager**.
- 2 Select **Add Roles** from the Action menu.
- 3 Check the Print Services check box on the **Server Roles** window in the **Add Roles Wizard**, and then click **Next**.
- 4 Check the **Print Server** check box, and then click **Next**.
- 5 Click **Install**.

For Windows Server 2008 R2:

- 1 Click **Start**→ **Administrative Tools**→ **Server Manager**.
- 2 Select **Add Roles** from the **Action** menu.
- 3 Check the **Print and Document Services** check box on the **Server Roles** window in the **Add Roles Wizard**, and then click **Next**.
- 4 Click **Next**.
- 5 Check the **Print Server** check box, and then click **Next**.
- 6 Click **Install**.

Printer Setup

You can install your new printer on the network using the *Drivers and Utilities* CD that shipped with your printer, or using Microsoft Windows' **Add Printer** wizard.

Installing a Printer Driver Using the Add Printer Wizard

- 1 Click **Start**→ **Control Panel**→ **Hardware and Sound**→ **Printers (Start**→ **Devices and Printers** for Windows Server 2008 R2 and Windows 7).
- 2 Click **Add a printer** to launch the **Add Printer** wizard.
- 3 Select **Add a network, wireless or Bluetooth printer**.
- 4 In the list of available printers, select the one you want to use, and then click **Next**.



NOTE: In the list of available printers, the WSD printer is displayed in the form of **http://IP address/ws/**.



NOTE: If no WSD printer is displayed in the list, enter the printer's IP address manually to create a WSD printer. To enter the printer's IP address manually, follow the instructions below.

For Windows Server 2008 R2, to create a WSD printer, you must be a member of Administrators group.

1. Click **The printer that I want isn't listed**.
2. Select **Add a printer using a TCP/IP address or hostname** and click **Next**.
3. Select **Web Services Device** from **Device type**.
4. Enter the printer's IP address in the **Hostname or IP address** text box and click **Next**.



NOTE: Before installing the driver using the Add Printer wizard on Windows Server 2008 R2 or Windows 7, perform one of the following:

- Establish the Internet connection so that Windows Update can scan your computer.
 - Add the printer driver to your computer.
- 5 If prompted, install the printer driver on your computer. If you are prompted for an administrator password or confirmation, type the password or provide confirmation.
 - 6 Complete the additional steps in the wizard, and then click **Finish**.
 - 7 Print a test page to verify print installation.

- a Click **Start**→ **Control Panel**→ **Hardware and Sound**→ **Printers** (**Start**→ **Devices and Printers** for Windows Server 2008 R2 and Windows 7).
- b Right-click the printer you just created, and then click **Properties** (**Printer properties** for Windows Server 2008 R2 and Windows 7).
For PCL driver:
On the **Options** tab, set each setting item, and then click **Apply**.
For PS driver:
On the **Device Settings** tab, set each setting item, and then click **Apply**.
- c On the **General** tab, click **Print Test Page**. When a test page prints successfully, installation is complete.

Specifications

Operating System Compatibility

Your Dell™ 2150cn/2150cdn Color Printer is compatible with Microsoft® Windows® XP, Windows XP 64-bit Edition, Windows Server® 2003, Windows Server 2003 x64 Edition, Windows Server 2008, Windows Server 2008 64-bit Edition, Windows Server 2008 R2 64-bit Edition, Windows Vista®, Windows Vista 64-bit Edition, Windows 7, Windows 7 64-bit Edition, Mac OS X 10.3.9, 10.4.11, 10.5, 10.6, Red Hat® Enterprise Linux® 4 WS/5 Client (x86), and SUSE® Linux Enterprise Desktop 10/11 (x86).

Power Supply

Rated Voltage	220 VAC - 240 VAC	110 VAC - 127 VAC
Frequency	50/60 Hz	50/60 Hz
Current	5 A or less	9 A or less

Dimensions

Height: 413 mm (16.26 inches) Width: 400 mm (15.75 inches) Depth: 406 mm (15.98 inches)

Weight (not including cartridge and PHD unit): 15.0 kg (32.47 lb)

Memory

Base memory	256 MB
Maximum memory	768 MB (256 MB + 512 MB)
Connector	144 pin EP2-2100 DDR2 SDRAM 32b-SO-DIMM
DIMM Size	512 MB
Speed	EP2-2100

Page Description Language (PDL)/Emulation, Operating System, and Interface

PDL/Emulations	PCL 6, PCL5e, HBPL, XPS (Host Based)	
Operating Systems	Microsoft Windows XP/XP x64/Server 2003/Server 2003 x64/Server 2008/Server 2008 x64/Server 2008 R2 x64/Vista/Vista x64/7/7 XPS, Mac OS X (10.3.9/10.4.11/10.5/10.6), Red Hat Enterprise Linux 4 WS/5 Client (x86), and SUSE Linux Enterprise Desktop 10/11 (x86)	
Interfaces	Standard local:	USB 2.0
	Standard network:	10Base-T/100Base-TX/ 1000Base-T Ethernet
	Optional network:	IEEE 802.11b/802.11g/802.11n (Wireless)

MIB Compatibility

Management Information Base (MIB) is a database containing information about network devices (such as adapters, bridges, routers, or computers). This information helps network administrators manage the network (analyze performance, traffic, errors, and so on). Dell 2150cn/2150cdn Color Printer complies with standard industry MIB specifications, allowing the printer to be recognized and managed by various printer and network management software systems.

Environment

Operation

Temperature	10 °C - 32 °C
Relative humidity	10 % - 85 % RH (no condensation)

Print Quality Guarantee

Temperature	15 °C - 28 °C
Relative humidity	20 % - 70 % RH (no condensation)

Storage



Temperature range	-20 °C to 40 °C (0 °F to 104 °F)
Storage humidity range	5 % - 85 % RH (no condensation)

Altitude

Operating	Up to 3,100 m (10,000 feet)
Storage	70.9275 Kpa

Cables

Your interconnection cable must meet the following requirements:

	Connection type	Connection specifications and symbols
1	USB	USB 2.0 
2	Ethernet	10Base-T/100Base-TX/ 1000Base-T 
3	Wireless adapter socket	IEEE 802.11b/802.11g/802.11n 

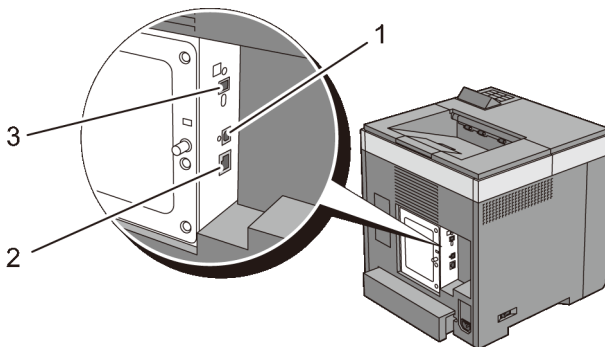

Maintaining Your Printer

Maintaining Your Printer

You need to complete certain tasks to maintain optimum print quality.



NOTE: The images used and procedures described in this manual are those of Dell™ 2150cn Color Printer.

Determining the Status of Supplies

If your printer is connected to the network, the **Dell Printer Configuration Web Tool** can provide instant feedback on remaining toner levels. Type the printer's IP address in your web browser to view this information. To use the **E-Mail Alert Setup** feature that notifies you when the printer requires new supplies, type the desired e-mail address in the e-mail list box.

On the operator panel, you can also confirm the following:

- Any supply or maintenance items that require attention replacing (However, the printer can only display information about one item at a time).
- Amount of toner remaining in each toner cartridge.

Conserving Supplies

You can change several settings in your printer driver to conserve toner cartridge and paper.

Supply	Setting	Function
Toner cartridge	Toner Saving Mode in the Advanced tab	This check box allows the users to select a print mode that uses less toner. The image quality will be lower when this feature is used.

Supply	Setting	Function
Print media	Multiple Up in the Layout tab	The printer prints two or more pages on one side of a sheet. Values for Multiple Up are 2 Up, 4 Up, 8 Up, 16 Up, or 32 Up. Combined with the duplex setting, Multiple Up allows you to print up to 64 pages on one sheet of paper. (32 images on the front and 32 on the back)

Ordering Supplies

You can order consumables from Dell on the Internet when using a networked printer. Type the IP address of your printer in your web browser, launch the **Dell Printer Configuration Web Tool**, and click the **Order Supplies at:** to order toner for your printer.

You can also order toner cartridges by the following method.

- 1 Click **Start**→ **All Programs**→ **Dell Printers**→ **Additional Color Laser Software**→ **Dell Supplies Management System**.

The **Dell Supplies Management System** window appears.

- 2 Select your printer from the **Select Printer Model** list.
- 3 If ordering from the web:
 - a When you cannot get information from the printer automatically by two-way communication, a window that prompts you to type the Service Tag appears. Type your Dell printer Service Tag in the field provided.
Your Service Tag number is located inside the toner access cover of your printer.
 - b Select a URL from the **Select Reorder URL** list.
 - c Click **Visit Dell printer supplies ordering web site**.
- 4 If ordering by phone, call the number that appears under the **Order by Phone** heading.

Storing Print Media

To avoid potential paper feeding problems and uneven print quality, there are several things you can do.

- To achieve the best possible print quality, store print media in an environment where the temperature is approximately 21 °C (70 °F) and the relative humidity is 40 %.
- Store cartons of print media on a pallet or shelf, rather than directly on the floor.
- If you store individual packages of print media out of the original carton, ensure that they rest on a flat surface so the edges do not buckle or curl.
- Do not place anything on top of the print media packages.

Storing Consumables

Store consumables in their original packaging until you need to use them. Do not store consumables in:

- Temperatures greater than 40 °C (104 °F).
- An environment with extreme changes in humidity or temperature.
- Direct sunlight.
- Dusty places.
- A car for a long period of time.
- An environment where corrosive gases are present.
- A humid environment.

Replacing the Toner Cartridges

 **CAUTION:** Before performing any of the following procedures, read and follow the safety instructions in your *Product Information Guide*.

Dell toner cartridges are available only through Dell. You can order cartridges online at <http://www.dell.com/supplies> or by phone. To order by phone, see "Contacting Dell."

It is recommended to use Dell toner cartridges for your printer. Dell does not provide warranty coverage for problems caused by using accessories, parts, or components not supplied by Dell.

 **CAUTION:** Never throw used toner cartridges into fire. The residual toner could explode resulting in burns and injuries.

 **CAUTION:** Do not shake the used toner cartridge. This may cause toner spills.

Removing the Toner Cartridge

- 1 Open the toner access cover.

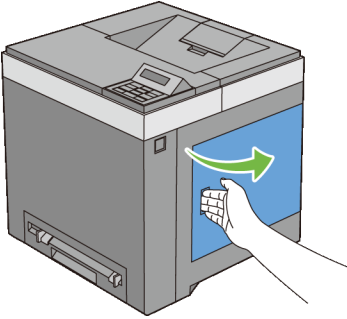

- 2 Push the latch(es) backwards to pop open the toner cartridge(s) that you want to replace.

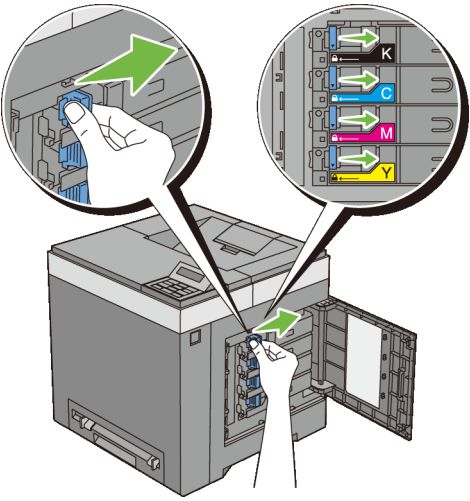

- 3 Pull the cartridge holder until it clicks, and then pull out the toner cartridge.

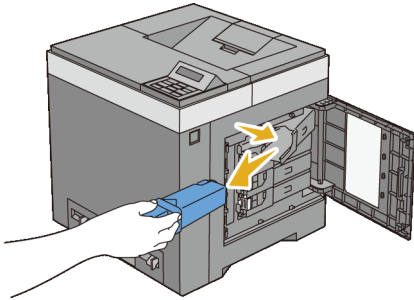

! CAUTION: Do not shake the toner cartridge as it may cause toner spills.

Installing a Toner Cartridge

- 1 Ensure that the color of the new toner cartridge matches that on the handle before replacing it. Shake the new toner cartridge five or six times to distribute the toner evenly.

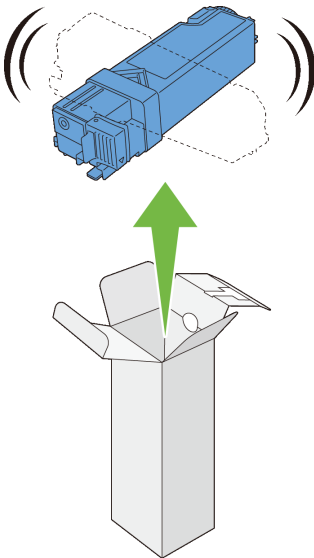

- 2 Insert the toner cartridge into the associated cartridge holder, and then slide the latch of the toner cartridge.

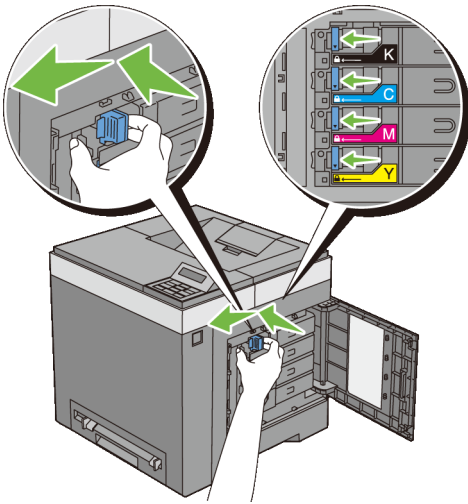
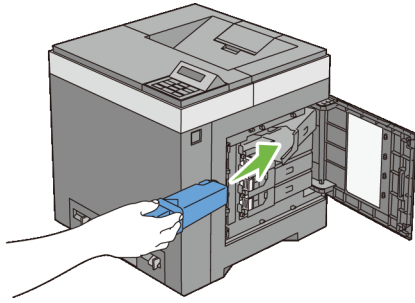

3 Close the toner access cover.

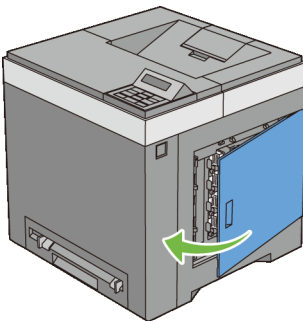

Replacing the Print Head Device (PHD) Unit

- ⚠ **CAUTION:** Before performing any of the following procedures, read and follow the safety instructions in your *Product Information Guide*.
- ➡ **NOTICE:** Protect the drums of the Print Head Device (PHD) against bright light. If the front cover remains open for more than three minutes, print quality may deteriorate.
- ➡ **NOTICE:** Ensure nothing touches or scratches the surface (black-colored film) of the belt unit. Scratches, dirt, or oil from your hands on the film of the belt unit may reduce print quality.

Removing the PHD Unit

- 1 Ensure that the printer is turned off.
- 2 Pull the standard 250-sheet tray out of the printer about 200 mm. Hold the standard 250-sheet tray with both hands, and remove it from the printer.

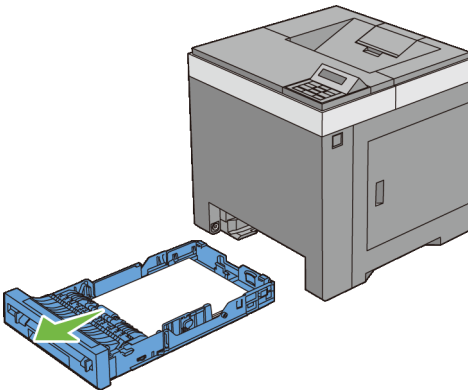

- 3 Push the side button to open the front cover.

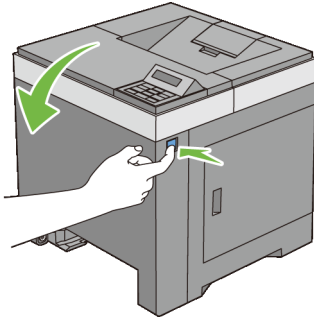

4 Open the belt unit.

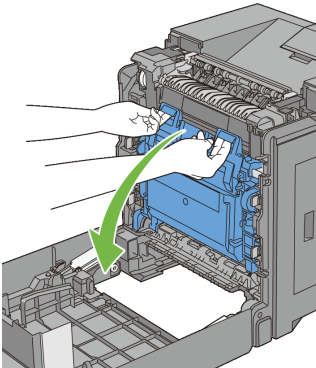

5 Turn the four PHD lock levers 90-degrees counterclockwise.

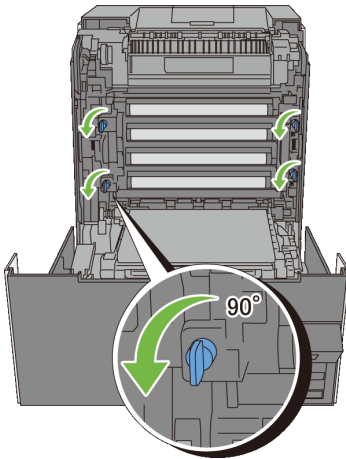

- 6 Hold the gray tabs, and then pull the PHD unit out of the printer.

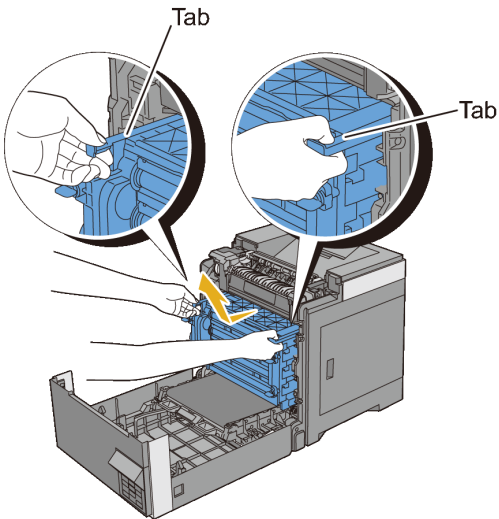

Installing a PHD Unit

- 1 Open the PHD packaging.



2 Take out the PHD unit from the packaging.

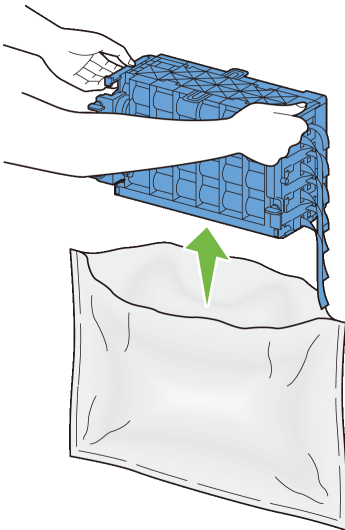

3 Completely pull out the eight yellow ribbons from the PHD unit.

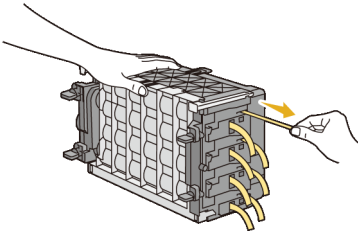

- 4 Remove the rear protective cover from the PHD unit.



NOTE: Do not remove the front protective cover at this moment.

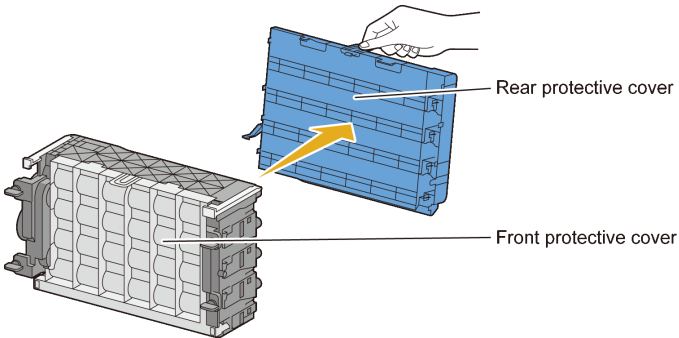

- 5 Insert the PHD unit until the line on the handle aligns with the white line on the printer.

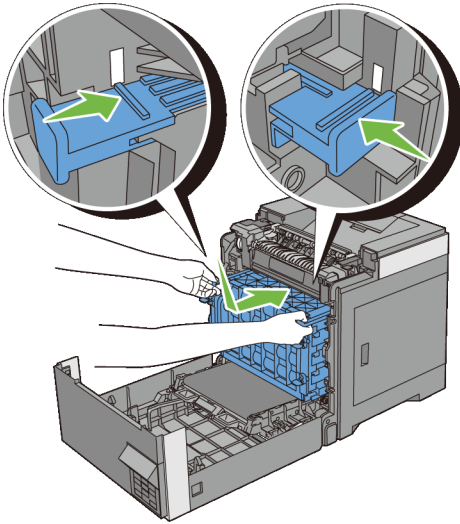

- 6 Turn the four PHD lock levers 90-degrees clockwise to lock the PHD unit.

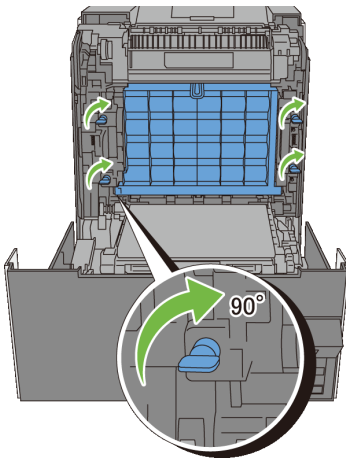

- 7 Remove the front protective cover from the PHD unit.

➔ NOTICE: Ensure that you do not hit the belt unit when removing the front protective cover.

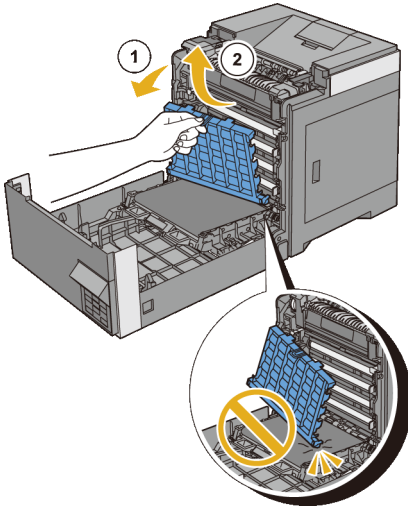

8 Close the belt unit, and push at the top of the unit until it clicks.

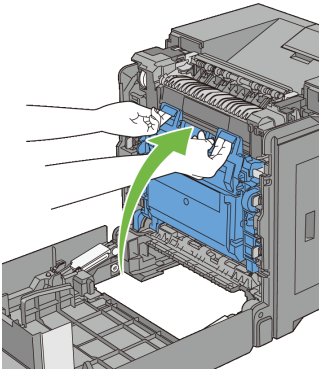

9 Close the front cover.

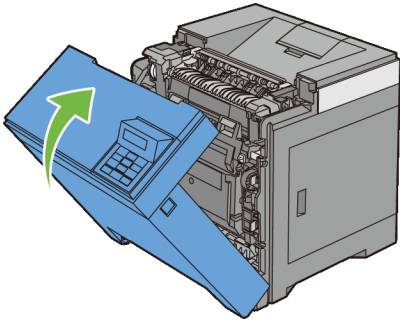

10 Insert the standard 250-sheet tray into the printer, and push until it stops.

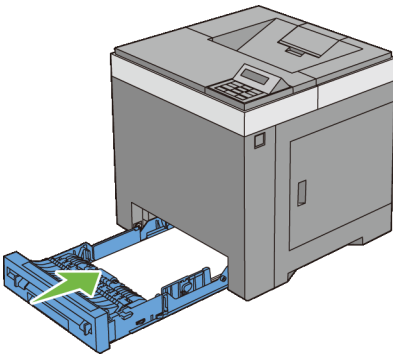

Replacing the Retard Roller

Keeping the retard roller in the paper tray clean helps ensure the best possible printing. It is recommended to clean the retard roller at regular intervals.

! CAUTION: To prevent electric shock, always turn off the printer and disconnect the power cable from the grounded outlet before performing maintenance.

! CAUTION: Before performing any of the following procedures, read and follow the safety instructions in your *Product Information Guide*.

Dell retard rollers are available only through Dell. To order by phone, see "Contacting Dell."

It is recommended to use Dell retard rollers for your printer. Dell does not provide warranty coverage for problems caused by using accessories, parts, or components not supplied by Dell.

Removing the Retard Roller in the Standard 250-Sheet Tray

- 1 Pull the standard 250-sheet tray out of the printer about 200 mm. Hold the standard 250-sheet tray with both hands, and remove it from the printer.

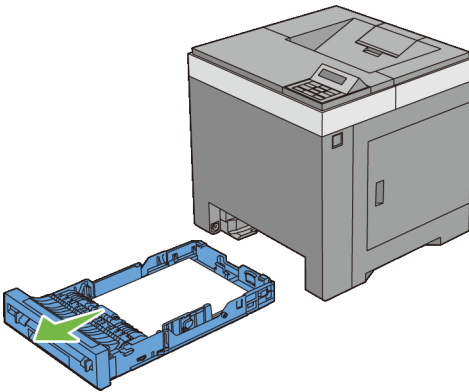

 **NOTE:** Ensure that you remove all the paper from the standard 250-sheet tray before removing the retard roller.

- 2 Holding the retard roller tabs with your fingers, pull the retard roller out of the groove in the axle.

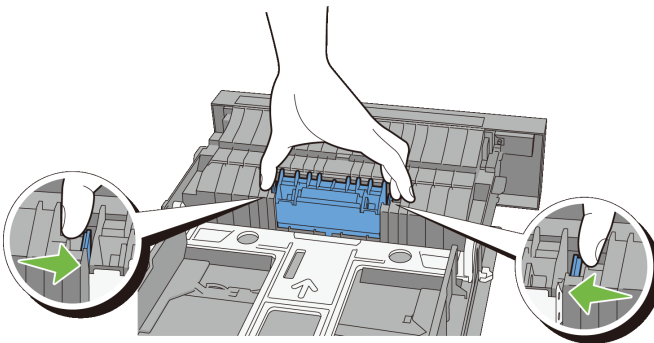

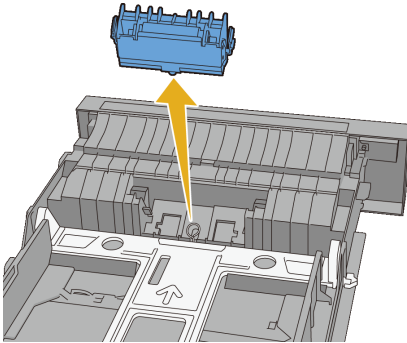

Installing a Retard Roller in the Standard 250-Sheet Tray

- 1 Align the new retard roller with the groove on the axle.

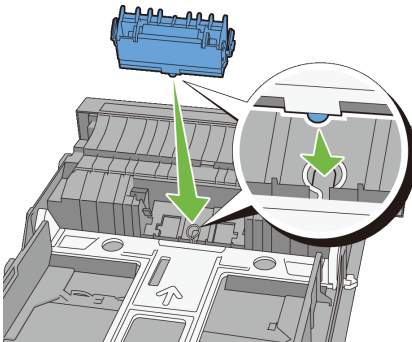

- 2 Insert the retard roller into the axle until it snaps. The protrusions fit completely into the slots and the roller hook reseats into the groove on the axle.

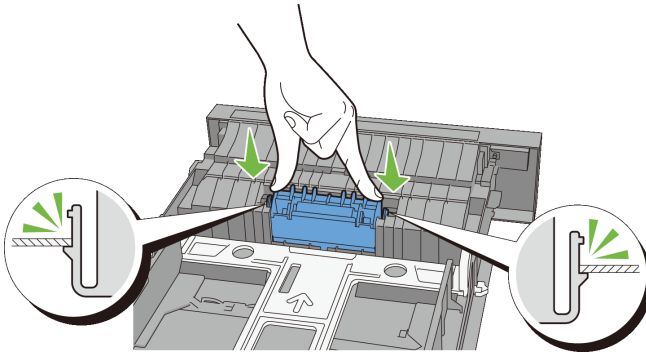

- 3 Load paper in the standard 250-sheet tray, and then insert the tray into the printer and push until it stops.

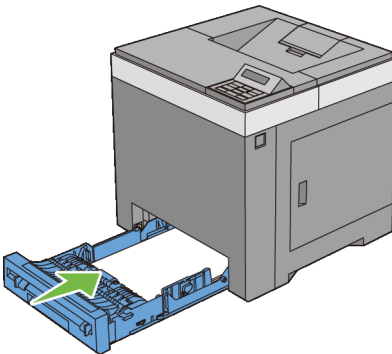

Cleaning Inside the Printer

Cleaning the Feed Roller

Clean the feed roller inside the printer if print media does not feed correctly.

- 1 Ensure that the printer is turned off.
- 2 Pull the standard 250-sheet tray out of the printer about 200 mm. Hold the standard 250-sheet tray with both hands, and remove it from the printer.

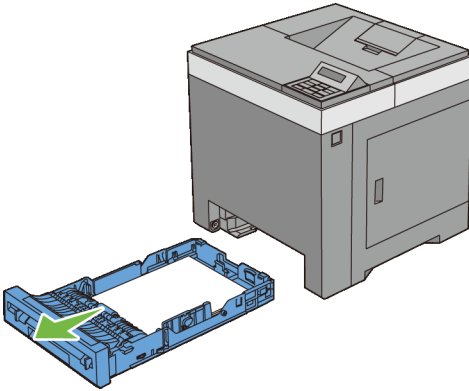

3 Push the side button to open the front cover.

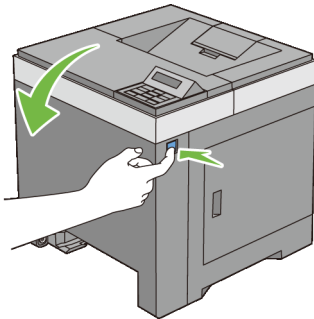

4 Open the belt unit.

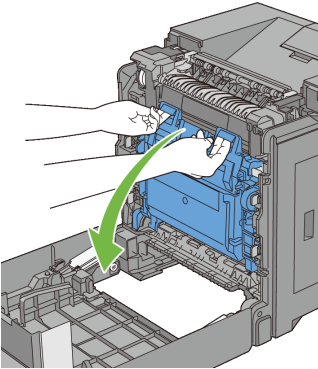

5 Turn the four PHD lock levers 90-degrees counterclockwise.

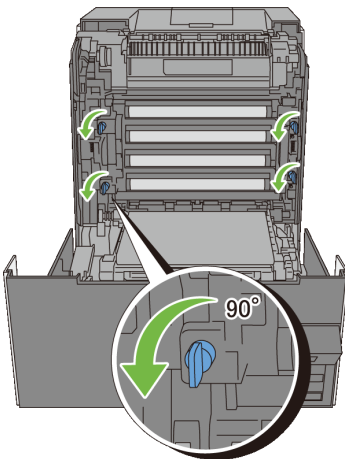

6 Hold the gray tabs, and then pull out the PHD unit.

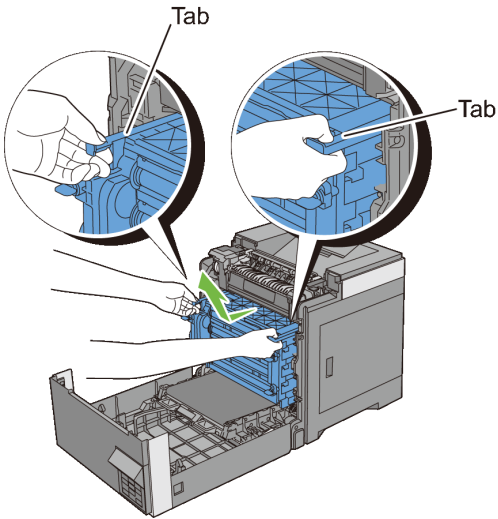

 **NOTE:** Keep the PHD unit in a dark place. If the front cover remains open for more than three minutes, print quality may deteriorate.

- 7 Clean the feed roller inside the printer with a dry cloth.

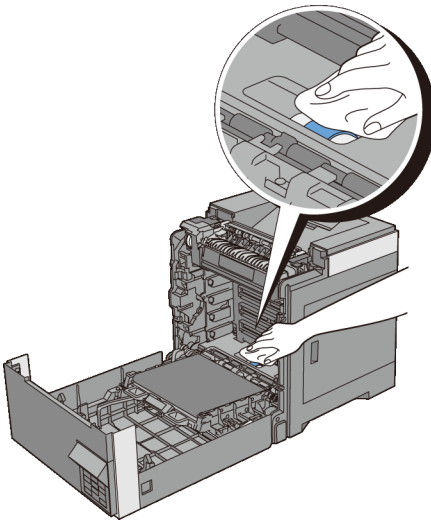

- 8 Insert the PHD unit until it stops, and then turn the four PHD lock levers 90-degrees clockwise to lock the PHD unit.

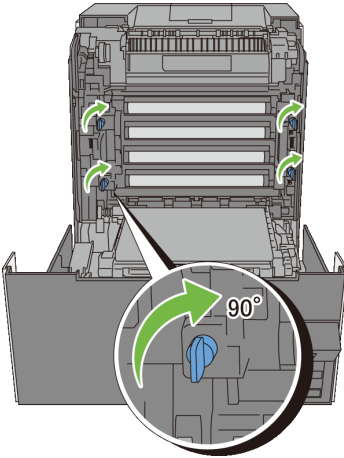

- 9 Close the belt unit, and push at the top of the unit until it clicks.

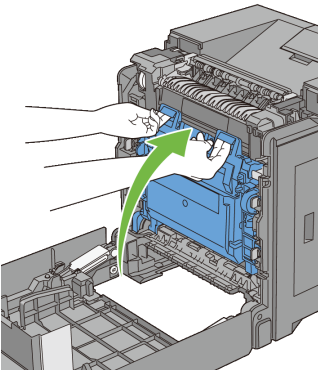

- 10 Close the front cover.

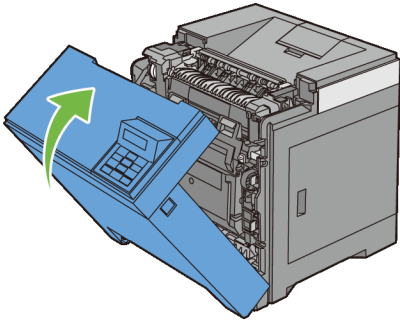

- 11 Insert the standard 250-sheet tray into the printer, and push until it stops.

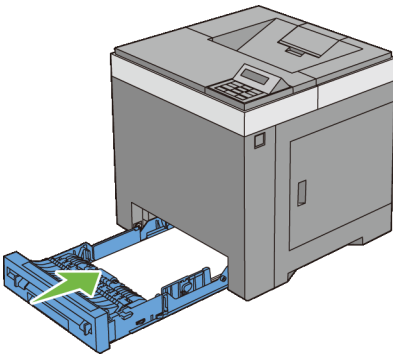

Cleaning the CTD Sensor

Clean the Color Toner Density (CTD) sensor only when an alert for the CTD sensor is shown on the Status Monitor or operator panel.

- 1 Ensure that the printer is turned off.
- 2 Pull the standard 250-sheet tray out of the printer about 200 mm. Hold the standard 250-sheet tray with both hands, and remove it from the printer.

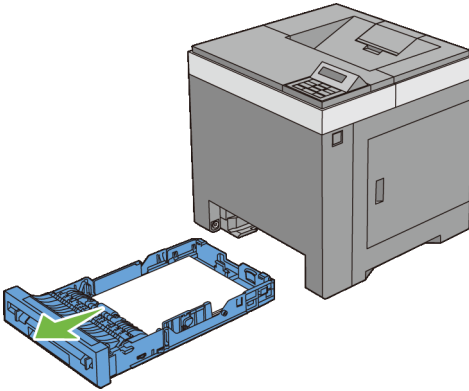

3 Push the side button to open the front cover.

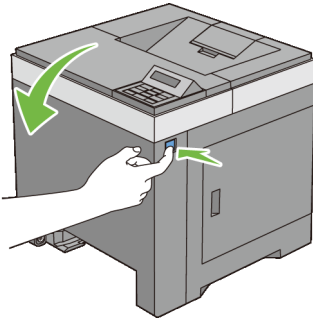

4 Open the belt unit.

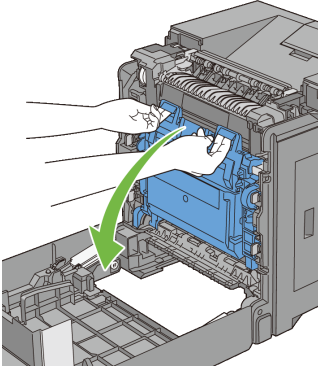

- 5 Clean the CTD sensor inside the printer with a clean dry cotton swab.

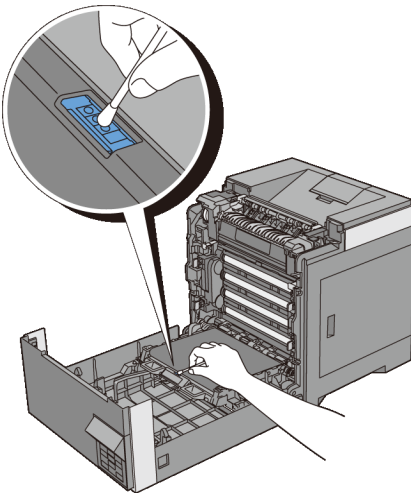

- 6 Close the belt unit, and push at the top of the unit until it clicks.

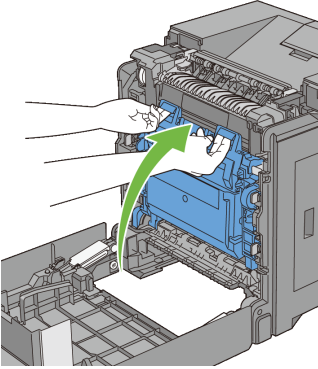

7 Close the front cover.

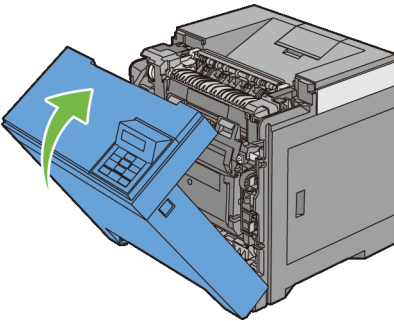

8 Insert the standard 250-sheet tray into the printer, and push until it stops.

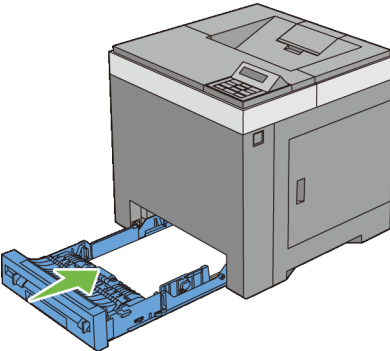









Adjusting Color Registration

To adjust the color registration when you first install the printer or after moving it to a new location, follow the procedure below.

- Printing the Color Registration Chart
- Determining Values
- Entering Values



Printing the Color Registration Chart

When Using the Operator Panel

- 1 Press the  (**Menu**) button.
- 2 Press  button until `Admin Menu` appears, and then press the  (**Set**) button.
- 3 Press  button until `Maintenance` appears, and then press the  (**Set**) button.
- 4 Press  button until `Color Reg Adj` appears, and then press the  (**Set**) button.
- 5 Press  button until `ColorReg Chart` appears, and then press the  (**Set**) button.

The `Are you sure?` message appears on the operator panel.

- 6 Press the  (**Set**) button.

 **NOTE:** To cancel printing the color registration chart, press the  (**Cancel**) button.

The color registration chart is printed.

When Using the Tool Box

 **NOTE:**

- 1 Click **Start**→ **All Programs**→ **Dell Printers**→ **Dell 2150 Color Printer**→ **Tool Box**.

 **NOTE:** The **Select Printer** dialog box opens in this step when multiple printer drivers are installed on your computer. In this case, click the name of this printer listed in **Printer Names**, and then click **OK**.

The **Tool Box** opens.

- 2 Click the **Printer Maintenance** tab.
- 3 Select **Color Registration Adjustment** from the list at the left side of the page.

The **Color Registration Adjustment** page is displayed.

- 4 Click the **Start** button next to **Print Color Regi Chart**.

The color registration chart is printed.

Determining Values

On the color registration chart, there are two types of charts: Chart 1 (fast scan) and Chart 2 (slow scan).

The Chart 1 is used to adjust the color registration for the fast scan direction, which is vertical to paper feed direction. The Chart 2 is used to adjust the color registration for the slow scan direction, which is horizontal to paper feed direction.

The following sections explain how to determine the adjustment values for the fast scan and the slow scan using Chart 1 and Chart 2.

Fast Scan

On the Chart 1 of the color registration chart, find the straightest lines where the two black lines and the colored line are most closely aligned for each color (**Y**, **M**, and **C**). If you find the straightest line, make a note of the value (-9 to +9) indicated by the straightest line for each color.

When the value is **0** for each color, you do not need to adjust the color registration for the fast scan.

When the value is not **0**, enter the value using the procedure in "Entering Values."

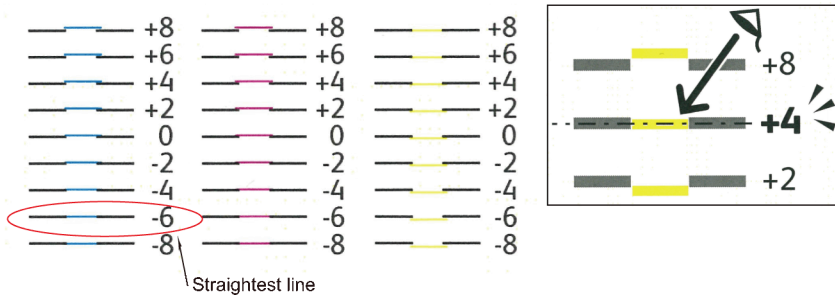

Slow Scan

On the Chart 2 of the color registration chart, find the medium line within the range of white area for each color pattern (Y, M, and C). If you find the medium line, make a note of the value (-9 – +9) indicated by the medium line for each color.

When the value is 0 for each color, you do not need to adjust the color registration for the slow scan.



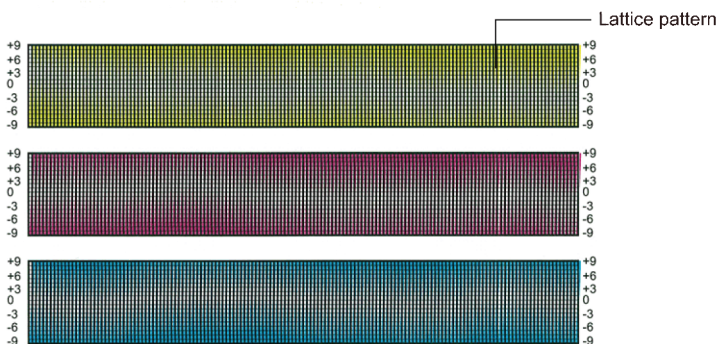
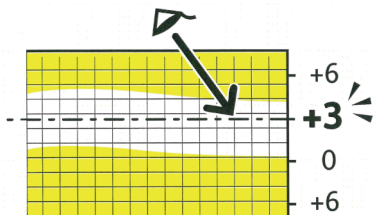







When the value is not 0, enter the value using the procedure in "Entering Values."



Entering Values

When Using the Operator Panel

Using the operator panel, enter the values found in the color registration chart to make adjustments.

- 1 Press the  (**Menu**) button.
- 2 Press  button until **Admin Menu** appears, and then press the  (**Set**) button.
- 3 Press  button until **Maintenance** appears, and then press the  (**Set**) button.
- 4 Press  button until **Color Reg Adj** appears, and then press the  (**Set**) button.
- 5 Press  button until **Enter Number** appears, and then press the  (**Set**) button.
- 6 Ensure that the cursor is displayed at the value under **LY** and press  or  button to specify the values.

7 Press  button to move the cursor to the next value.

8 Press the  (**Set**) button.

The cursor is displayed at the value under RY.



9 Repeat steps 6 to 8 to enter the desired values, and then press the  (**Set**) button.

 **NOTE:** You can specify each value for process, left, and right colors (LY, LM, LC, RY, RM, RC, PY, PM, and PC) by repeating the steps 6 to 8.

10 Press  and  until **ColorReg Chart** appears, and then press the  (**Set**) button.

The **Are you sure?** message appears on the operator panel.

11 Press the  (**Set**) button.

 **NOTE:** To cancel printing the color registration chart, press the  (**Cancel**) button.

The color registration chart with the new values is printed.

If the straightest line is not at the value of 0, adjust the values again. Checking the charts before and after the adjustments will help you to determine the values to enter.

When Using the Tool Box

 **NOTE:**

Using the Tool Box, enter the values that you found in the color registration chart to make adjustments.

1 Click **Start**→ **All Programs**→ **Dell Printers**→ **Dell 2150 Color Printer**→ **Tool Box**.

 **NOTE:** The **Select Printer** dialog box opens in this step when multiple printer drivers are installed on your computer. In this case, click the name of this printer listed in **Printer Names**, and then click **OK**.

The **Tool Box** opens.

2 Click the **Printer Maintenance** tab.

3 Select **Color Registration Adjustment** from the list at the left side of the page.

The **Color Registration Adjustment** page is displayed.

- 4 Select the value with the straight line, and then click the **Apply New Settings** button.
- 5 Click the **Start** button next to **Print Color Regi Chart**.
The color registration chart is printed with the new values.
- 6 Adjust till all straight lines are at the value of 0. Show image of before and after adjustment will help.

After printing the color registration chart, do not turn off the printer until the printer motor has stopped running.



NOTE: If 0 is not next to the straightest lines, determine the values and adjust the printer again.

Removing Options

If the printer location needs to change or the printer and print media handling options need to be shipped to a new location, all print media handling options must be removed from the printer. For shipping, pack the printer and print media handling options securely to avoid damage.

Removing the Optional Memory Module

⚠ CAUTION: When you remove the optional memory module, be sure to turn off the printer, unplug the power cable, and disconnect all cables from the back of the printer before starting these tasks.

- 1 Ensure that the printer is turned off and unplug all the cables including the power cable from the back of the printer.
- 2 Turn the screw on the control board cover counterclockwise.

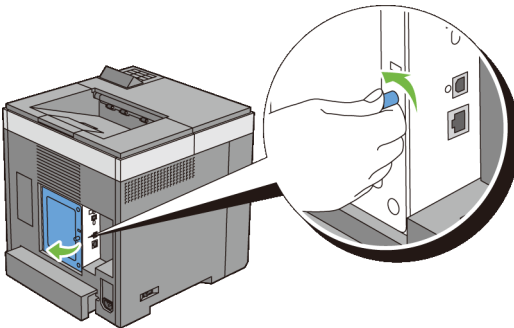

- 3 Open the control board cover.



NOTE: Remove the control board cover by pulling it upward until the lower hinge is out of the slit, and then pull the cover towards you and remove it.

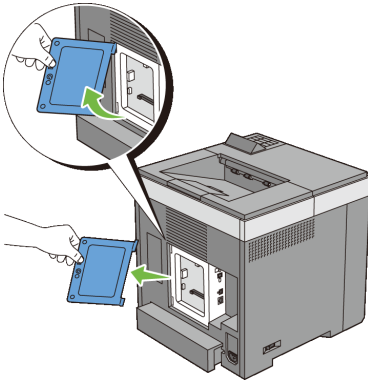

- 4 Push the clips on both sides of the slot outward to raise the memory module up.

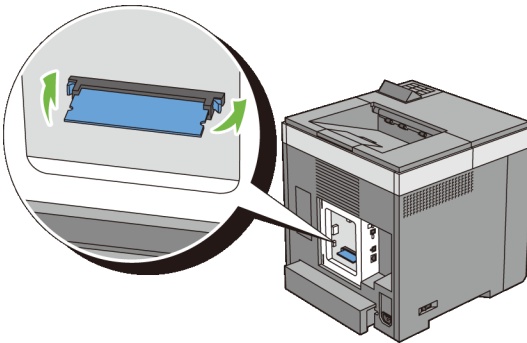

- 5 Hold the memory module and pull it straight out.

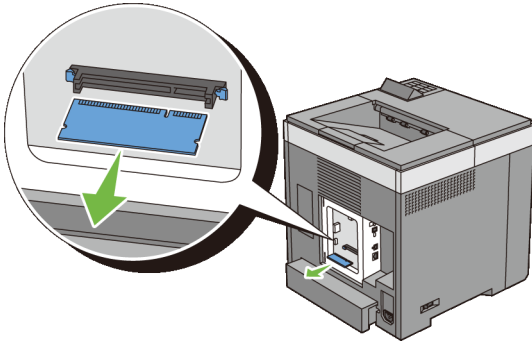

6 Install the control board cover.



NOTE: Insert the upper hinge of the control board cover into the upper slit on the printer. Next, insert the lower hinge of the control board cover into the lower slit of the printer.

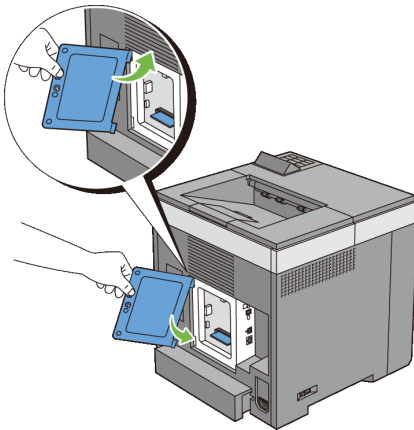

7 Close the control board cover and turn the screw clockwise.

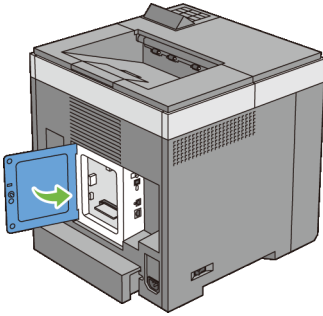

- 8 Turn on the printer.

Removing the Optional 250-Sheet Feeder

⚠ CAUTION: When you remove the optional 250-sheet feeder, be sure to turn off the printer, unplug the power cable, and disconnect all cables from the back of the printer before starting these tasks.

- 1 Turn off the printer and unplug the power cable. Then, disconnect all cables from the back of the printer.
- 2 Pull the standard 250-sheet tray out of the printer about 200 mm. Hold the tray with both hands, and remove it from the printer.

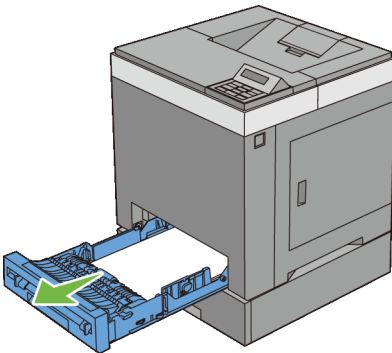

- 3 Remove the two screws joining the printer and the optional 250-sheet feeder by unscrewing them with a coin or similar object.

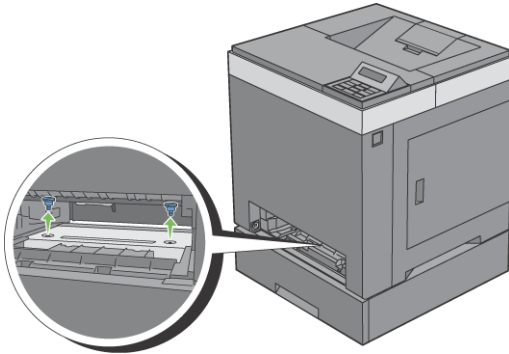

 **NOTE:** The screw hole is located in 216 mm recess from the front of the printer.

4 Gently lift the printer off the tray module, and place it on a level surface.

 **CAUTION:** Two people are required to lift the printer. The printer should be lifted holding the front and back. Never lift the printer from its sides.

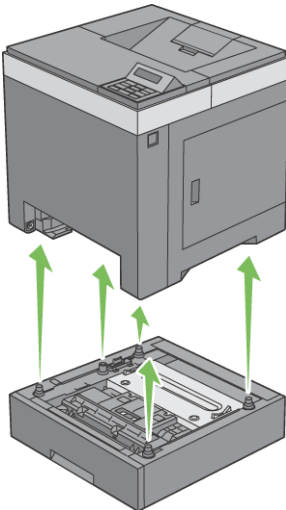

5 Insert the standard 250-sheet tray into the printer, and push until it stops.

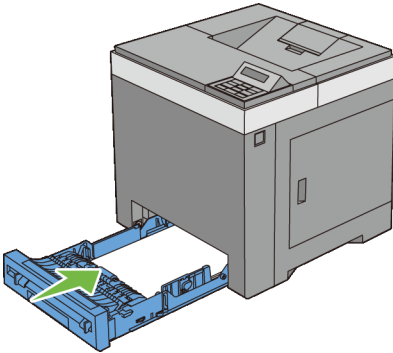

- ➔ **NOTICE:** Do not use excessive force on the tray. Doing so could damage the tray or the inside of the printer.
- 6 Reconnect all cables including the power cable into the back of the printer and turn on the printer.

Removing the Optional Wireless Adapter

! **CAUTION:** When you remove the optional wireless adapter, be sure to turn off the printer, unplug the power cable, and disconnect all cables from the back of the printer before starting these tasks.

- 1 Ensure that the printer is turned off.
- 2 Turn the screw on the control board cover counterclockwise and open the cover.

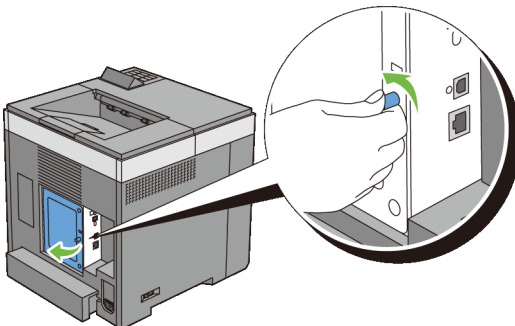

- 3 Remove the control board cover.

-  **NOTE:** Remove the control board cover by pulling it upward until the lower hinge is out of the slit, and then pull the cover towards you and remove it.

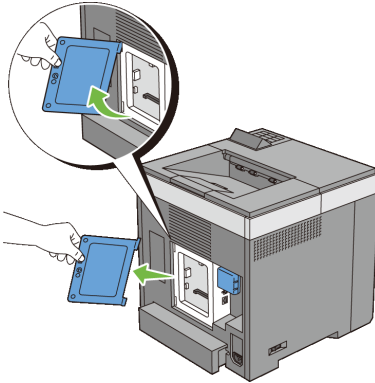

- 4 Remove the wireless adapter from the printer by releasing the adapter's hook while pushing the wireless adapter towards the front of the printer.

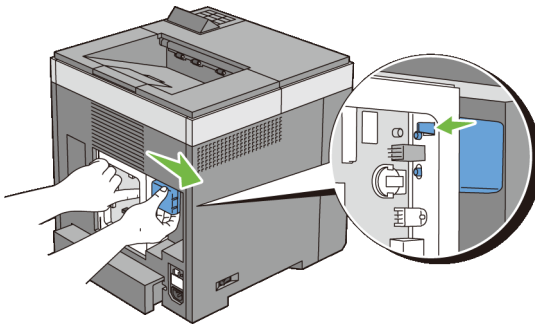

- 5 Install the control board cover.

-  **NOTE:** Insert the upper hinge of the control board cover into the upper slit on the printer. Next, insert the lower hinge of the control board cover into the lower slit of the printer.

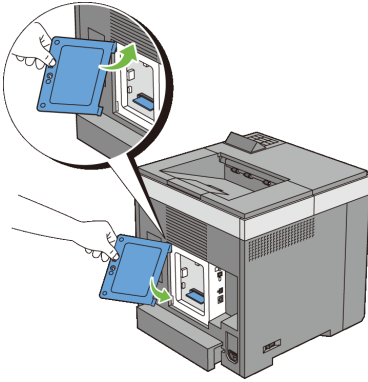

6 Close the control board cover and turn the screw clockwise.

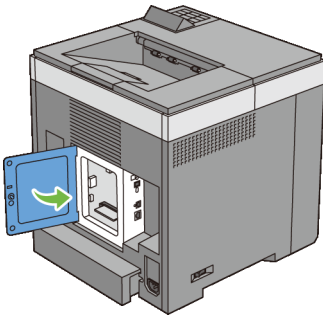

7 Turn on the printer.

Clearing Jams

Careful selection of appropriate print media and proper loading allow you to avoid paper jams. See "Print Media Guidelines" for more information.



NOTE: Before buying large quantities of any print media, it is recommended to try a sample first.

Avoiding Jams

- Use only recommended print media. See "Print Media Guidelines" for more information.
- See "Loading Print Media in the Standard 250-Sheet Tray and the Optional 250-Sheet Feeder" and "Loading Print Media in the SSF" to load print media properly.
- Do not overload the print media sources. Ensure that the print media stack height does not exceed the maximum height indicated by the load-line labels in the tray.
- Do not load wrinkled, creased, damp, or curled print media.
- Flex, fan, and straighten print media before you load it. If a jam occurs with print media, try feeding one sheet at a time through the single sheet feeder.
- Do not use print media that you have cut or trimmed yourself.
- Do not mix print media sizes, weights, or types in the same print media source.
- Ensure that the recommended print side is face up when you insert the print media when using the standard 250-sheet tray and the optional 250-sheet feeder. Also, the recommended print side should be face down when using the single sheet feeder.
- Keep print media stored in an acceptable environment. For more information, see "Storing Print Media."
- Do not remove the feeding tray during a print job.
- Push the tray in firmly after loading.
- Ensure that all cables that connect to the printer are correctly attached.

- Overtightening the guides may cause jams.
- Wipe the retard rollers in the tray or single sheet feeder with a cloth that is slightly dampened with water if jams caused by misfeeding paper occur frequently.

Identifying the Location of Paper Jams

⚠ CAUTION: Do not attempt to clear any jams using tools or instruments. This may permanently damage the printer.

The following illustration shows where paper jams may occur along the print media path.

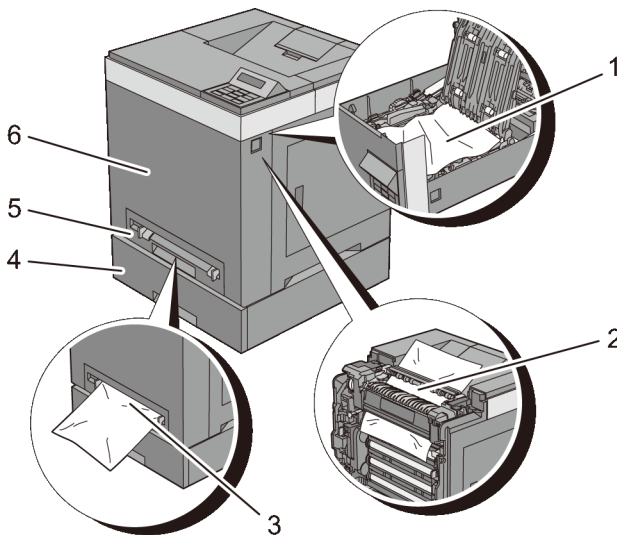

1	Duplexer (2150cdn only)
2	Fuser
3	Single Sheet Feeder (SSF)
4	Optional 250-Sheet Feeder
5	Standard 250-Sheet Tray
6	Front Cover

Clearing Paper Jams From the SSF

➡ **NOTICE:** Protect the drums of the Print Head Device (PHD) against bright light. If the front cover remains open for more than three minutes, print quality may deteriorate.

✍ **NOTE:** To resolve the error displayed on the operator panel, you must clear all print media from the print media path.

- 1 Pull the jammed paper out of the single sheet feeder. If no jammed paper can be found or you are unable to remove the paper, go to the next step to remove the jammed paper from the inside of the printer.

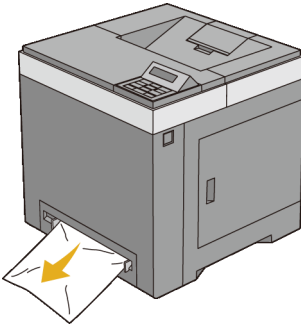

- 2 Remove the standard 250-sheet tray from the printer, and then pull out the jammed paper remaining inside the printer. If no jammed paper can be found or you are unable to remove the paper, go to the next step to remove the jammed paper from the inside of the printer.

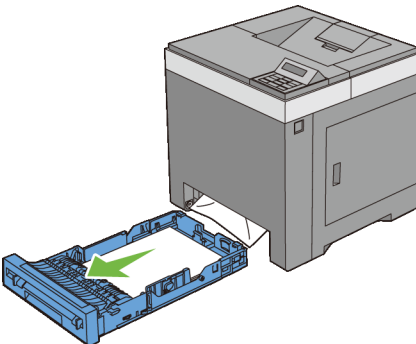

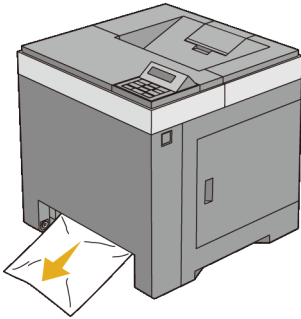

- 3 Push the side button to open the front cover.

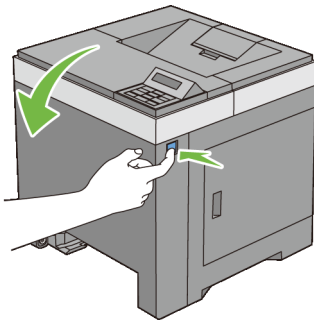

- 4 Open the belt unit until it stops and remove the jammed paper. Confirm that there are no scraps of paper remaining inside the printer.

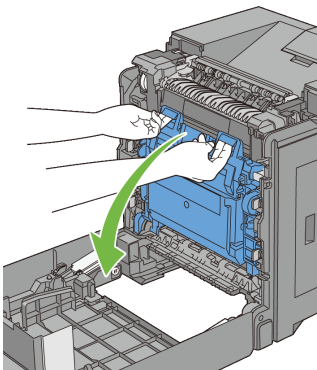

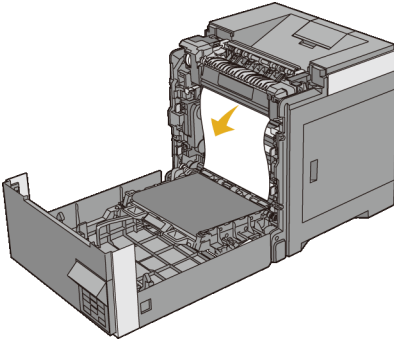

5 Close the belt unit, and push at the top of the unit until it clicks.

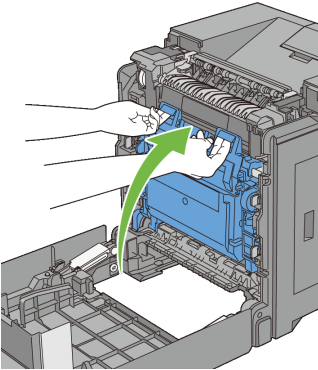

6 Close the front cover.

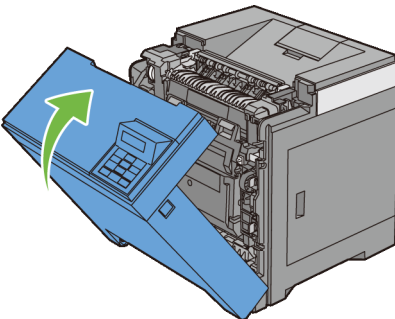

7 Insert the standard 250-sheet tray into the printer, and push until it stops.

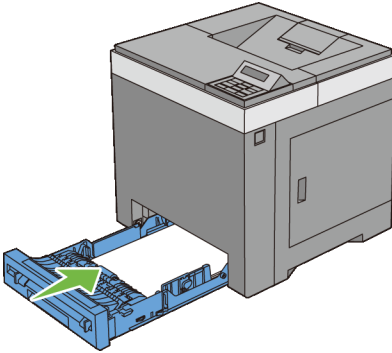

- ➔ **NOTICE:** Do not use excessive force on the tray. Doing so could damage the tray or the inside of the printer.

Clearing Paper Jams From the Standard 250-Sheet Tray

- ➔ **NOTICE:** Protect the drums of the Print Head Device (PHD) against bright light. If the front cover remains open for more than three minutes, print quality may deteriorate.

- ✎ **NOTE:** To resolve the error displayed on the operator panel, you must clear all print media from the print media path.

- 1 Pull the standard 250-sheet tray out of the printer carefully. Hold the tray with both hands, lift the front slightly, and remove it from the printer.

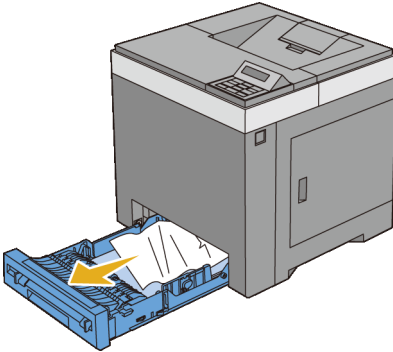

- 2 Remove all the jammed and/or creased paper from the tray.

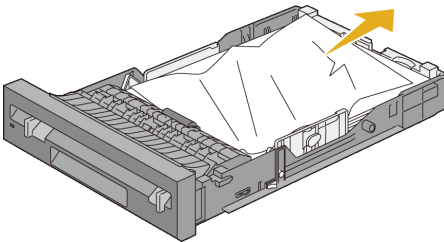

- 3 Pull the jammed paper out carefully to avoid tearing it. If you are still unable to remove the paper, go to the next step to remove the jammed paper from the inside of the printer.

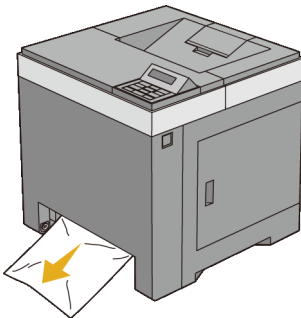

- 4 Push the side button to open the front cover.

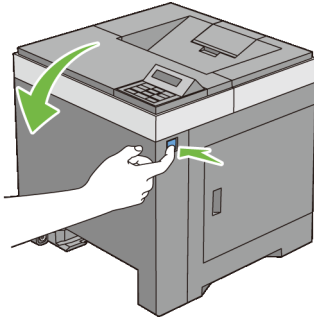

- 5 Open the belt unit until it stops and remove the jammed paper. Confirm that there are no scraps of paper remaining inside the printer.

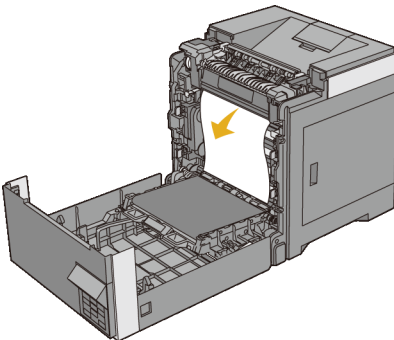
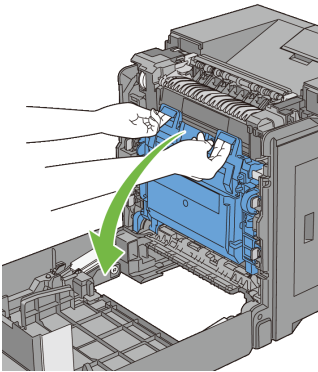

- 6 Close the belt unit, and push at the top of the unit until it clicks.

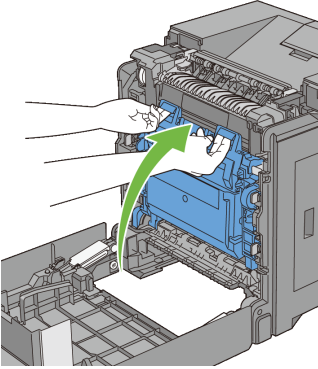

7 Close the front cover.

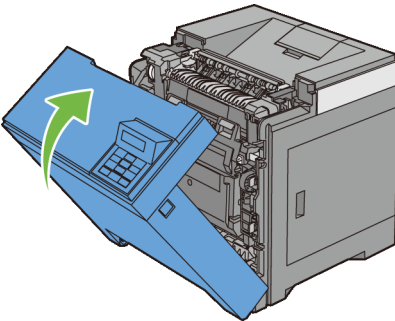

8 Insert the standard 250-sheet tray into the printer, and push until it stops.

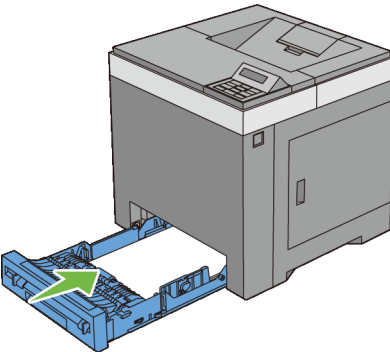

- ➔ **NOTICE:** Do not use excessive force on the tray. Doing so could damage the tray or the inside of the printer.

Clearing Paper Jams From the Fuser

- ➔ **NOTICE:** Ensure nothing touches or scratches the surface (black-colored film) of the belt unit. Scratches, dirt, or oil from your hands on the film of the belt unit may reduce print quality.
- ➔ **NOTICE:** Protect the drums of the Print Head Device (PHD) against bright light. If the front cover remains open for more than three minutes, print quality may deteriorate.
- 🔧 **NOTE:** To resolve the error displayed on the operator panel, you must clear all print media from the print media path.
 - 1 Turn off the printer and wait for 30 minutes.
 - 2 Push the side button to open the front cover.

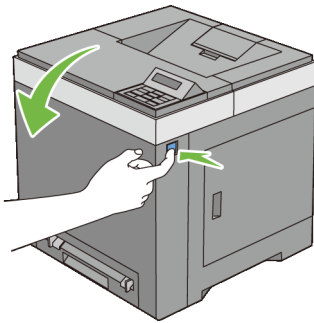

- 3 Open the belt unit.

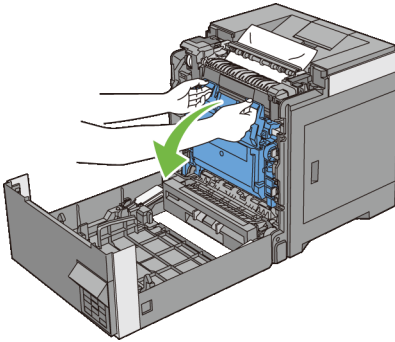

- 4 Lift the levers at both ends of the fuser, and remove the jammed paper. If you are still unable to remove the paper, go to the next step.

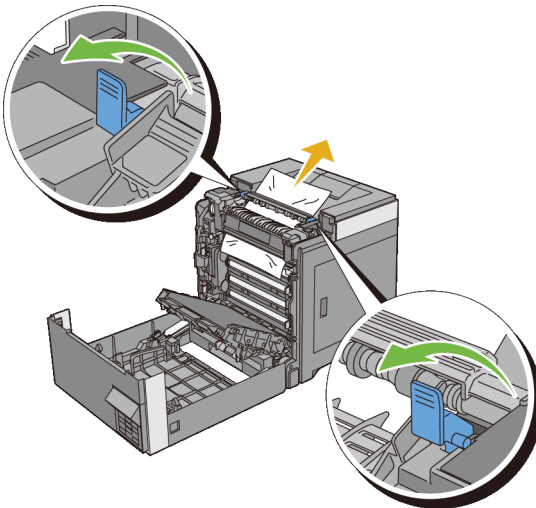

CAUTION: The fuser is hot. Do not touch it, doing so may cause burns.

- 5 Open the cover of the fuser and remove the jammed paper.

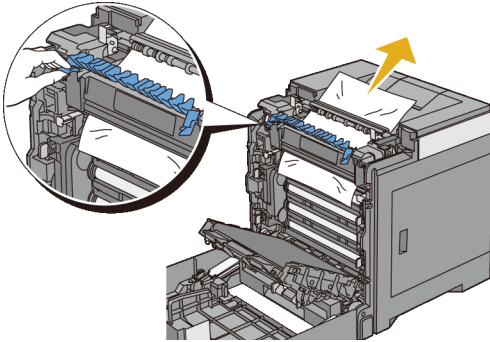

- 6 Close the cover of the fuser and press down the levers at both ends of the fuser.

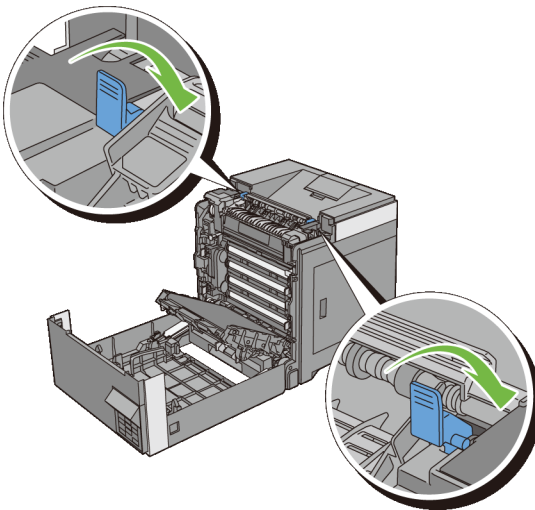

- 7 Confirm that there are no scraps of paper remaining inside the printer, and then close the belt unit.

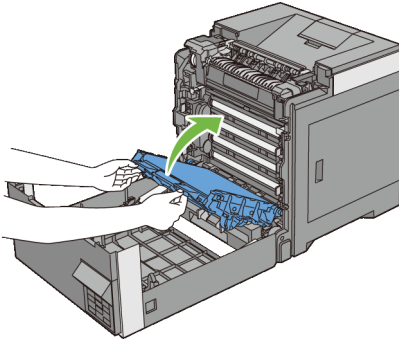

8 Close the front cover.

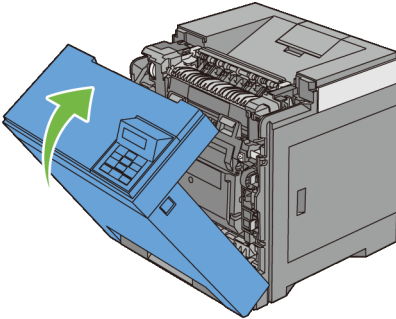

Clearing Paper Jams From the Duplexer

 **NOTE:** To resolve the error displayed on the operator panel, you must clear all print media from the print media path.

1 Push the side button to open the front cover.

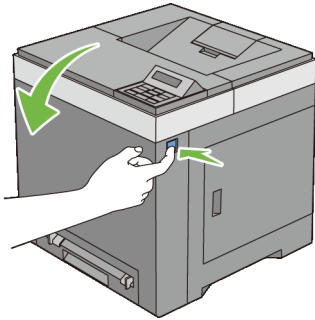

- 2 Open the cover of the duplexer.
- 3 Remove the jammed paper from the duplexer.

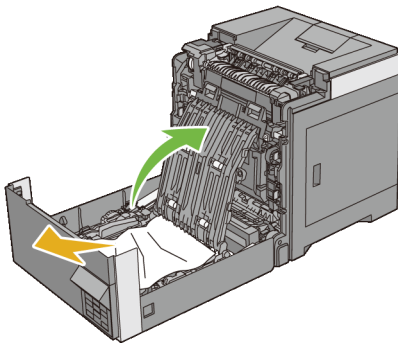

- 4 Close the cover of the duplexer.
- 5 Close the front cover.

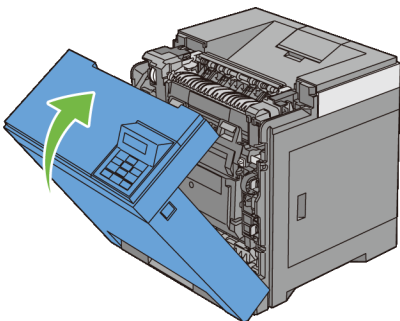

Clearing Paper Jams From the Optional 250-Sheet Feeder

 **NOTE:** To resolve the error displayed on the operator panel, you must clear all print media from the print media path.

- 1 Pull the optional 250-sheet feeder out of the printer carefully. Hold the feeder with both hands, and remove it from the printer.

 **NOTE:** Paper in the optional 250-sheet feeder feeds to the printer from the front of the standard 250-sheet tray, therefore paper jammed in the standard 250-sheet tray can block the optional 250-sheet feeder in the printer, preventing you from opening it. Look for the jammed paper sequentially, starting with the optional 250-sheet feeder.

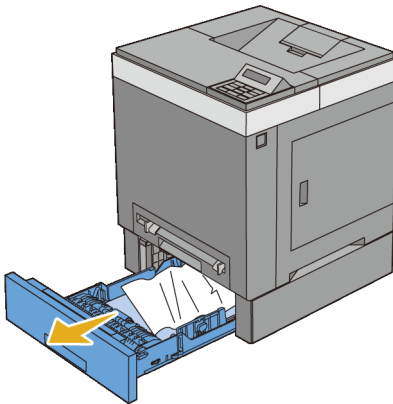

- 2 Remove all jammed and/or creased paper from the feeder.

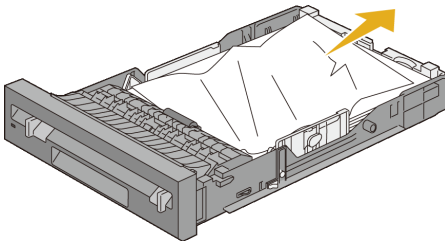

- 3 Pull the jammed paper out carefully to avoid tearing it. If you are still unable to remove the paper, go to the next step to remove the jammed paper from the inside of the printer.

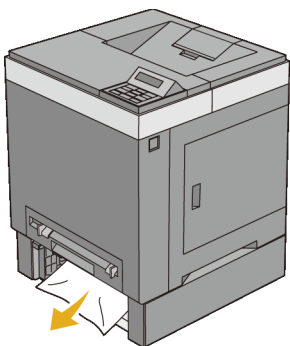

- 4 Push the side button to open the front cover.

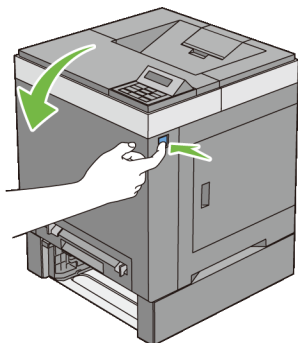

- 5 Open the belt unit until it stops and remove the jammed paper. Confirm that there are no scraps of paper remaining inside the printer.

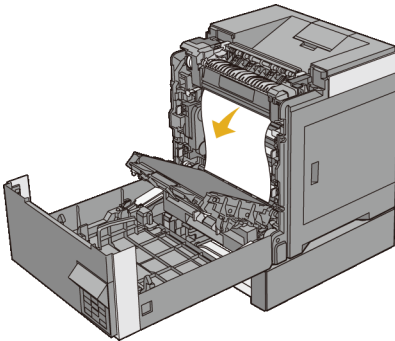
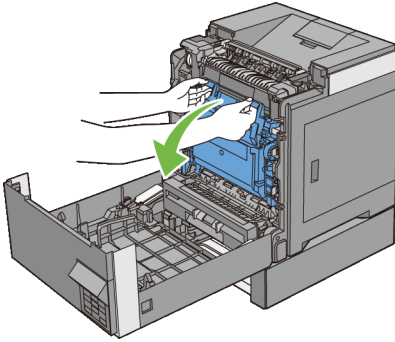

6 Close the belt unit, and push at the top of the unit until it clicks.

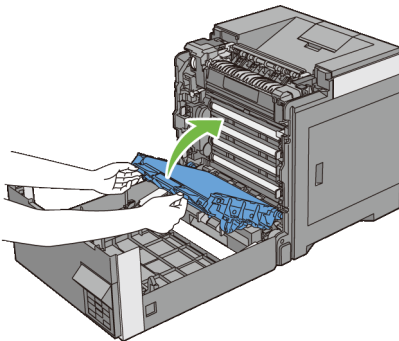

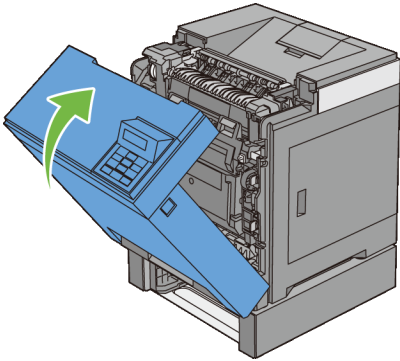

7 Close the front cover.

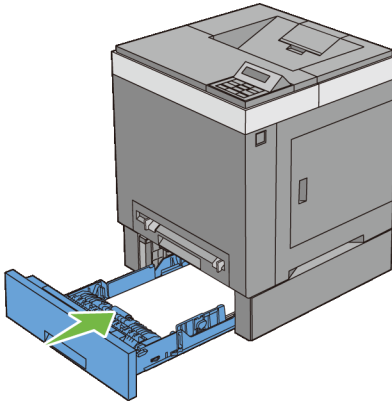

 **NOTE:** If the paper jam message is not cleared after closing the front cover, pull out the standard 250-sheet tray and check if there is a jammed paper in the opening of the tray.

- 8 Insert the optional 250-sheet feeder into the printer, and push until it stops.



 **NOTICE:** Do not use excessive force on the tray. Doing so could damage the tray or the inside of the printer.

Troubleshooting

Troubleshooting Guide

Basic Printer Problems

Some printer problems can be easily resolved. If a problem occurs with your printer, check each of the following:

The power cable is plugged into the printer and a properly grounded electrical outlet.



- The printer is turned on.
- The electrical outlet is not turned off at any switch or breaker.
- Other electrical equipment plugged into the outlet are working.
- Optional memory is properly installed.

If you have checked all of the above and still have a problem, turn off the printer, wait for 10 seconds, and then turn on the printer. This often fixes the problem.

Display Problems

Problem	Action
After the printer is turned on, the display on the operator panel is blank, keeps showing Please wait... , or the back light is not lit.	<ul style="list-style-type: none"> • Turn off the printer, wait for 10 seconds, and turn on the printer. • Self Test Message appears on the operator panel. When the test is completed, <code>Ready to Print</code> is displayed.
Menu settings changed from the operator panel have no effect.	Settings in the software program, the printer driver, or the printer utilities are overriding the settings made on the operator panel.

Printing Problems

Problem	Action
Job did not print or incorrect characters printed.	Ensure that the top menu appears on the operator panel before you send a job to print. Press the  (Menu) button to return to the top menu.
	Ensure that the print media is loaded in the printer. Press the  (Menu) button to return to the top menu.
	Verify that the printer is using the correct page description language (PDL).
	Verify that you are using the correct printer driver.
	Ensure that the correct USB or Ethernet cable is securely connected to the printer.
	Verify that the correct print media size is selected.
	If you are using a print spooler, verify that the spooler has not stalled.
	Check the printer's interface from the Admin Menu.
	Determine the host interface you are using. Print a panel settings page to verify that the current interface settings are correct.

Problem	Action
Print media misfeeds or multiple feeds occur in the standard 250-sheet tray or single sheet feeder.	Ensure that the print media you are using meets the specifications for your printer. See "Supported Paper Types" for more information.
	Fan the print media before loading it in the standard 250-sheet tray.
	Ensure that the print media is loaded correctly.
	Ensure that the width and length guides of the print media sources are adjusted correctly.
	Ensure that the standard 250-sheet tray is securely inserted.
	Do not overload the tray.
	Do not force print media into the single sheet feeder when you load it; otherwise, it may skew or buckle.
	Ensure that the print media is not curled.
	Face the recommended print side up or down appropriately for the type of print media you are using. See "Loading Print Media in the Standard 250-Sheet Tray and the Optional 250-Sheet Feeder" for more information.
	Turn the print media over or around and try printing again to see if feeding improves.
	Do not mix print media types.
	Do not mix reams of print media.
	Remove the top and bottom curled sheets of a ream before loading the print media.
	Load print media only when the tray is empty.
Wipe the retard rollers in the standard 250-sheet tray or single sheet feeder with a cloth moistened with water.	
The envelope is creased after printed.	Make sure that the envelope is loaded in the standard 250-sheet tray or single sheet feeder as instructed in "Loading Envelopes in the Standard 250-Sheet Tray and Optional 250-Sheet Feeder" or "Loading an Envelope in the SSF."

Problem	Action
Page breaks in unexpected places.	Increase the value for Time-Out on the operator panel, the Tool Box, or Dell Printer Configuration Web Tool.
Print media does not stack neatly in the output bin.	Turn the print media stack over in the tray.
Cannot perform manual duplex printing.	Select Flip on Short Edge or Flip on Long Edge from the Duplex menu on the Paper/Output tab in the printer driver.
Cannot print from the standard 250-sheet tray because the print media in the tray is curled.	Load the print media into the single sheet feeder.

Print Quality Problems



NOTE: Some of the following procedures that use the Tool Box can also be performed using the operator panel or Dell Printer Configuration Web Tool. For information on how to use the operator panel and Dell Configuration Web Tool, see "Understanding the Tool Box Menus" and "Dell Printer Configuration Web Tool."

- The output is too light
- Toner smears or print comes off
- Random spots/Blurred images
- The entire output is blank
- Streaks appear on the output
- Part or the entire output is black
- Pitched color dots
- Vertical blanks
- Ghosting
- Light-induced fatigue
- Fog
- Bead-Carry-Out (BCO)
- Jagged characters
- Banding

- Auger mark
- Wrinkled/Stained paper
- Damage on the leading edge of paper

The output is too light

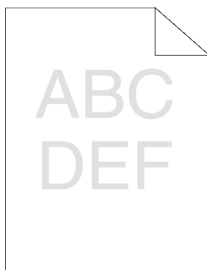

Action	Yes	No
<p>1 The toner cartridges may be low or need to be replaced. Confirm the amount of toner left in each toner cartridge.</p> <p style="padding-left: 20px;">a Check the toner level in the Status tab in the Status Monitor.</p> <p style="padding-left: 20px;">b Replace the toner cartridges as necessary.</p> <p>Does this solve your problem?</p>	The task is complete.	Go to action 2.
<p>2 If you are using non-Dell brand toner cartridges, disable the Non-Dell Toner option.</p> <p style="padding-left: 20px;">a Launch the Tool Box, and click Non-Dell Toner on the Printer Maintenance tab.</p> <p style="padding-left: 20px;">b Ensure that the On check box is not selected.</p> <p>Does this solve your problem?</p>	The task is complete.	Go to action 3.
<p>3 Disable the Toner Saving Mode in the printer driver.</p> <p style="padding-left: 20px;">a On the Advanced tab, ensure that the Toner Saving Mode check box is not selected.</p> <p>Does this solve your problem?</p>	The task is complete.	Go to action 4.

Action	Yes	No
<p>4 The print media surface may be uneven. Try changing the Paper Type setting in the printer driver. For example, change the plain paper to thick.</p> <p>a On the Paper/Output tab, change the Paper Type setting.</p> <p>Does this solve your problem?</p>	The task is complete.	Go to action 5.
<p>5 Verify that the correct print media is being used. See "Supported Paper Types." If not, use the print media recommended for the printer.</p> <p>Does this solve your problem?</p>	The task is complete.	Go to action 6.
<p>6 Ensure that the eight yellow ribbons are correctly removed from the Print Head Device (PHD) unit. See "Removing the Print Head Device (PHD) Ribbons" and "Installing a PHD Unit." If not, remove the ribbons.</p> <p>Does this solve your problem?</p>	The task is complete.	Go to action 7.
<p>7 Ensure that the developer motor functions properly.</p> <p>a Launch the Tool Box, and click Machine Check on the Diagnosis tab.</p> <p>b Select Main Motor Operation Check from the drop-down list box and click the Start button.</p> <p>c Click the Play of Sound button to check the motor sound.</p> <p>Does the motor function properly?</p>	Go to action 8.	Contact Dell.

Action	Yes	No
<p>8 Ensure that the dispense motor for each toner cartridge functions properly.</p> <ul style="list-style-type: none"> a Launch the Tool Box, and click Machine Check on the Diagnosis tab. b Select Dispense Motor Check (Yellow), Dispense Motor Check (Magenta), Dispense Motor Check (Cyan), or Dispense Motor Check (Black) from the drop-down list box, and click the Start button. c Click the Play of Sound button to check the motor sound. d Repeat steps b and c to perform Dispense Motor Check for the rest of the toner cartridges. <p> NOTE: You can perform Dispense Motor Check for CMYK in any order you desire.</p>	Go to action 9.	Contact Dell.

Does the dispense motor function properly?

<p>9 If printing many low density images, execute the Toner Refresh Mode.</p> <ul style="list-style-type: none"> a Launch the Tool Box, and click Refresh Mode on the Diagnosis tab. b Click the Yellow button under Toner Refresh Mode. c Repeat step b for Magenta, Cyan, and Black buttons. <p> CAUTION: Using the Refresh Mode consumes extra toner.</p> <ul style="list-style-type: none"> d After you complete the Toner Refresh Mode, select Chart Print from the list on the Diagnosis tab. e Click the 4 Colors Configuration Chart button. <p>The 4 Colors Configuration Chart is printed.</p>	The task is complete.	Go to action 10.
--	-----------------------	------------------

Does this solve your problem?

Action	Yes	No
<p>10 Replace the PHD unit if you have a spare unit.</p> <p>a Replace the PHD unit. See "Replacing the Print Head Device (PHD) Unit" and "Installing a PHD Unit."</p> <p>b After you replace the PHD unit, click Chart Print on the Diagnosis tab.</p> <p>c Click the 4 Colors Configuration Chart button.</p> <p>The 4 Colors Configuration Chart is printed.</p> <p>Does this solve your problem?</p>	The task is complete.	Contact Dell.

Toner smears or print comes off

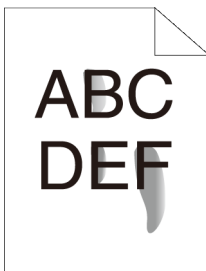

Action	Yes	No
<p>1 The print media surface may be uneven. Try changing the Paper Type setting in the printer driver. For example, change the plain paper to thick.</p> <p>a On the Paper/Output tab, change the Paper Type setting.</p> <p>Does this solve your problem?</p>	The task is complete.	Go to action 2.
<p>2 Verify that the correct print media is being used. See "Supported Paper Types." If not, use the print media recommended for the printer.</p> <p>Does this solve your problem?</p>	The task is complete.	Go to action 3.

Action	Yes	No
3 Replace the PHD unit if you have a spare unit. a Replace the PHD unit. See "Replacing the Print Head Device (PHD) Unit" and "Installing a PHD Unit." b After you replace the PHD unit, test print your document again. Does this solve your problem?	The task is complete.	Contact Dell.

Random spots/Blurred images

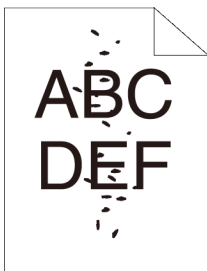

Action	Yes	No
1 Ensure that the toner cartridges are installed correctly. See "Installing a Toner Cartridge." Does this solve your problem?	The task is complete.	Go to action 2.
2 Ensure that the PHD unit is installed correctly. See "Replacing the Print Head Device (PHD) Unit" and "Installing a PHD Unit." Does this solve your problem?	The task is complete.	Go to action 3.

Action	Yes	No
<p>3 Replace the PHD unit if you have a spare unit.</p> <p>a Replace the PHD unit. See "Replacing the Print Head Device (PHD) Unit" and "Installing a PHD Unit."</p> <p>b After you replace the PHD unit, click Chart Print on the Diagnosis tab.</p> <p>c Click the Pitch Configuration Chart button.</p> <p>The Pitch Configuration Chart is printed.</p> <p>Does this solve your problem?</p>	The task is complete.	Contact Dell.

The entire output is blank

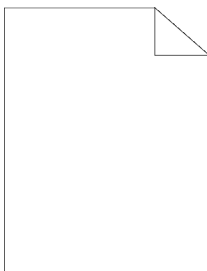

Action	Yes	No
<p>1 The toner cartridges may be low or need to be replaced. Confirm the amount of toner left in each toner cartridge.</p> <p>a Check the toner level in the Status tab in the Status Monitor.</p> <p>b Replace the toner cartridges as necessary.</p> <p>Does this solve your problem?</p>	The task is complete.	Go to action 2.
<p>2 If you are using non-Dell brand toner cartridges, disable the Non-Dell Toner option.</p> <p>a Launch the Tool Box, and click Non-Dell Toner on the Printer Maintenance tab.</p> <p>b Ensure that the On check box is not selected.</p> <p>Does this solve your problem?</p>	The task is complete.	Go to action 3.

Action	Yes	No
<p>3 Disable the Toner Saving Mode in the printer driver.</p> <p>a On the Advanced tab, ensure that the Toner Saving Mode check box is not selected.</p> <p>Does this solve your problem?</p>	The task is complete.	Go to action 4.
<p>4 The print media surface may be uneven. Try changing the Paper Type setting in the printer driver. For example, change the plain paper to thick.</p> <p>a On the Paper/Output tab, change the Paper Type setting.</p> <p>Does this solve your problem?</p>	The task is complete.	Go to action 5.
<p>5 Verify that the correct print media is being used. See "Supported Paper Types." If not, use the print media recommended for the printer.</p> <p>Does this solve your problem?</p>	The task is complete.	Go to action 6.
<p>6 Ensure that eight yellow ribbons are correctly removed from the PHD unit. See "Replacing the Print Head Device (PHD) Unit" and "Installing a PHD Unit." If not, remove the ribbons.</p> <p>Does this solve your problem?</p>	The task is complete.	Go to action 7.
<p>7 Ensure that the developer motor functions properly.</p> <p>a Launch the Tool Box, and click Machine Check on the Diagnosis tab.</p> <p>b Select Main Motor Operation Check from the drop-down list box and click the Start button.</p> <p>c Click the Play of Sound button to check the motor sound.</p> <p>Does the motor function properly?</p>	Go to action 8.	Contact Dell.

Action	Yes	No
<p>8 Ensure that the dispense motor for each toner cartridge functions properly.</p> <ul style="list-style-type: none"> a Launch the Tool Box, and click Machine Check on the Diagnosis tab. b Select Dispense Motor Check (Yellow), Dispense Motor Check (Magenta), Dispense Motor Check (Cyan), or Dispense Motor Check (Black) from the drop-down list box, and click the Start button. c Click the Play of Sound button to check the motor sound. d Repeat steps b and c to perform Dispense Motor Check for the rest of the toner cartridges. 	Go to action 9.	Contact Dell.
<p> NOTE: You can perform Dispense Motor Check for CMYK in any order you desire.</p>		
<p>Does the dispense motor function properly?</p>		
<p>9 Replace the PHD unit if you have a spare unit.</p> <ul style="list-style-type: none"> a Replace the PHD unit. See "Replacing the Print Head Device (PHD) Unit" and "Installing a PHD Unit." b After you replace the PHD unit, click Chart Print on the Diagnosis tab. c Click the 4 Colors Configuration Chart button. <p>The 4 Colors Configuration Chart is printed.</p>	The task is complete.	Contact Dell.
<p>Does this solve your problem?</p>		

Streaks appear on the output

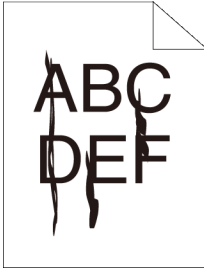

Action	Yes	No
<p>1 The toner cartridges may be low or need to be replaced. Confirm the amount of toner left in each toner cartridge.</p> <ul style="list-style-type: none"> a Check the toner level in the Status tab in the Status Monitor. b Replace the toner cartridges as necessary. <p>Does this solve your problem?</p>	The task is complete.	Go to action 2.
<p>2 If you are using non-Dell brand toner cartridges, disable the Non-Dell Toner option.</p> <ul style="list-style-type: none"> a Launch the Tool Box, and click Non-Dell Toner on the Printer Maintenance tab. b Ensure that the On check box is not selected. <p>Does this solve your problem?</p>	The task is complete.	Go to action 3.
<p>3 Replace the PHD unit if you have a spare unit.</p> <ul style="list-style-type: none"> a Replace the PHD unit. See "Replacing the Print Head Device (PHD) Unit" and "Installing a PHD Unit." b After you replace the PHD unit, click Chart Print on the Diagnosis tab. c Click the 4 Colors Configuration Chart button. <p>The 4 Colors Configuration Chart is printed.</p> <p>Does this solve your problem?</p>	The task is complete.	Contact Dell.

Part or the entire output is black

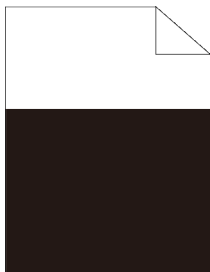

Action	Yes	No
1 Ensure Output Color is set to Color (Auto) in the printer driver. a On the Graphics tab, ensure that the Output Color is set to Color (Auto) .	The task is complete.	Go to action 2.
Does this solve your problem?		
2 Replace the PHD unit if you have a spare unit. a Replace the PHD unit. See "Replacing the Print Head Device (PHD) Unit" and "Installing a PHD Unit." b After you replace the PHD unit, click Chart Print on the Diagnosis tab. c Click the 4 Colors Configuration Chart button. The 4 Colors Configuration Chart is printed.	The task is complete.	Contact Dell.
Does this solve your problem?		

Pitched color dots

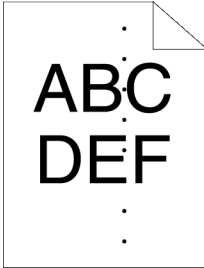

Action	Yes	No
<p>1 Locate the cause of the problem using the Pitch Configuration Chart.</p> <p>a Launch the Tool Box, and click Chart Print on the Diagnosis tab.</p> <p>b Click the Pitch Configuration Chart button.</p> <p>The Pitch Configuration Chart is printed.</p> <p>c Compare the pitch of the color spots on your output with that on the Pitch Configuration Chart, and locate the cause of the problem.</p> <p>Is the cause of the problem located?</p>	<p>Proceed to the action corresponding to the location of the problem:</p> <ul style="list-style-type: none"> • PHD unit - 2 • Fuser - Contact Dell and replace the fuser. • Main unit of the printer - Contact Dell. 	<p>Contact Dell.</p>
<p>2 Replace the PHD unit if you have a spare unit.</p> <p>a Replace the PHD unit. See "Replacing the Print Head Device (PHD) Unit" and "Installing a PHD Unit."</p> <p>b After you replace the PHD unit, click Chart Print on the Diagnosis tab.</p> <p>c Click the Pitch Configuration Chart button.</p> <p>The Pitch Configuration Chart is printed.</p> <p>Does this solve your problem?</p>	<p>The task is complete.</p>	<p>Contact Dell.</p>

Vertical blanks

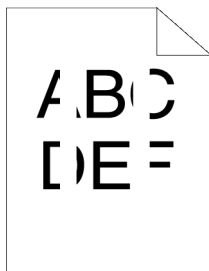

Action	Yes	No
<p>1 Ensure the light path is not covered.</p> <p>a Remove the PHD unit, and keep it in the dark place. See "Replacing the Print Head Device (PHD) Unit."</p> <p>b Check the light path, and then remove the shielding.</p> <p>c Re-install the PHD unit. See "Installing a PHD Unit."</p> <p>d Launch the Tool Box, and click Chart Print on the Diagnosis tab.</p> <p>e Click the Pitch Configuration Chart button.</p> <p>The Pitch Configuration Chart is printed.</p> <p>Does this solve your problem?</p>	The task is complete.	Go to action 2.
<p>2 Replace the PHD unit if you have a spare unit.</p> <p>a Replace the PHD unit. See "Replacing the Print Head Device (PHD) Unit" and "Installing a PHD Unit."</p> <p>b After you replace the PHD unit, click Chart Print on the Diagnosis tab.</p> <p>c Click the Pitch Configuration Chart button.</p> <p>The Pitch Configuration Chart is printed.</p> <p>Does this solve your problem?</p>	The task is complete.	Contact Dell.

Ghosting

Action	Yes	No
<p>1 Locate the cause of the problem using the Ghost Configuration Chart.</p> <p>a Launch the Tool Box, and click Chart Print on the Diagnosis tab.</p> <p>b Click the Ghost Configuration Chart button.</p> <p>The Ghost Configuration Chart is printed.</p> <p>Is the type of the problem identified?</p>	<p>Proceed to the action corresponding to the type of ghosting.</p> <p>Positive ghost - 2a</p> <p>Negative ghost - 2b</p>	<p>Contact Dell.</p>
<p>2a Replace the PHD unit if you have a spare unit.</p> <p>a Replace the PHD unit. See "Replacing the Print Head Device (PHD) Unit" and "Installing a PHD Unit."</p> <p>b After you replace the PHD unit, click Chart Print on the Diagnosis tab.</p> <p>c Click the Ghost Configuration Chart button.</p> <p>The Ghost Configuration Chart is printed.</p> <p>Does this solve your problem?</p>	<p>The task is complete.</p>	<p>Contact Dell.</p>
<p>2b If you are using non-recommended print media, use the print media recommended for the printer.</p> <p>Does this solve your problem?</p>	<p>Go to action 3.</p>	<p>Go to action 2a.</p>
<p>3 Adjust the transfer bias.</p> <p>a On the operator panel, press the  (Menu) button and select Admin Menu→ Maintenance→ Adjust BTR.</p> <p>b Adjust the setting for the type of print media being used.</p> <p>c Launch the Tool Box, and click Chart Print on the Diagnosis tab.</p> <p>d Click the Ghost Configuration Chart button.</p> <p>The Ghost Configuration Chart is printed.</p> <p>Does this solve your problem?</p>	<p>The task is complete.</p>	<p>Contact Dell.</p>

Light-induced fatigue

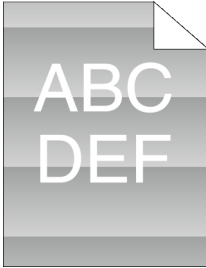

Action	Yes	No
<p>1 Check the light fatigue pattern using the Pitch Configuration Chart.</p> <p>a Launch the Tool Box, and click Chart Print on the Diagnosis tab.</p> <p>b Click the Pitch Configuration Chart button.</p> <p>The Pitch Configuration Chart is printed.</p> <p>Does the pattern on the output match with that on the Pitch Configuration Chart?</p>	Go to action 2.	Contact Dell.
<p>2 Execute the PHD Refresh Mode.</p> <p>a Launch the Tool Box, and click Refresh Mode on the Diagnosis tab.</p> <p>b After you start the Drum Refresh Mode, click Chart Print on the Diagnosis tab.</p> <p>c Click the 4 Colors Configuration Chart button.</p> <p>The 4 Colors Configuration Chart is printed.</p> <p>Does this solve your problem?</p>	The task is complete.	Go to action 3.
<p>3 Replace the PHD unit if you have a spare unit. See "Replacing the Print Head Device (PHD) Unit" and "Installing a PHD Unit."</p> <p>Does this solve your problem?</p>	The task is complete.	Contact Dell.

Fog



Action	Yes	No
<p>1 Execute the PHD Refresh Mode.</p> <ul style="list-style-type: none">a Launch the Tool Box, and click Refresh Mode on the Diagnosis tab.b After you start the Drum Refresh Mode, click Chart Print on the Diagnosis tab.c Click the 4 Colors Configuration Chart button. <p>The 4 Colors Configuration Chart is printed.</p> <p>Does this solve your problem?</p>	<p>The task is complete.</p>	<p>Go to action 2.</p>
<p>2 Replace the PHD unit if you have a spare unit.</p> <ul style="list-style-type: none">a Replace the PHD unit. See "Replacing the Print Head Device (PHD) Unit" and "Installing a PHD Unit."b After you replace the PHD unit, click Chart Print on the Diagnosis tab.c Click the 4 Colors Configuration Chart button. <p>The 4 Colors Configuration Chart is printed.</p> <p>Does this solve your problem?</p>	<p>The task is complete.</p>	<p>Contact Dell.</p>

Bead-Carry-Out (BCO)

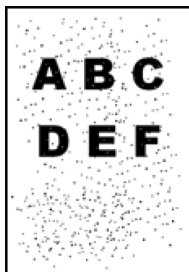

Action	Yes	No
1 If the printer is installed in a high altitude location, set the altitude of the location. <ul style="list-style-type: none"> a Launch the Tool Box, and click Adjust Altitude on the Printer Maintenance tab. b Select the value close to the altitude of the location where the printer is installed. Does this solve your problem?	The task is complete.	Go to action 2.
2 Replace the PHD unit if you have a spare unit. See "Replacing the Print Head Device (PHD) Unit" and "Installing a PHD Unit." <p>Does this solve your problem?</p>	The task is complete.	Contact Dell.

Jagged characters

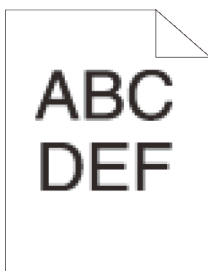

Action	Yes	No
1 Set Screen to Fineness in the printer driver. a On the Advanced tab, set Screen under Items: to Fineness . Does this solve your problem?	The task is complete.	Go to action 2.
2 Set Print Mode to High Quality in the printer driver. a On the Graphics tab, select High Quality from Print Mode . Does this solve your problem?	The task is complete.	Go to action 3.
3 Enable Bitmap Smoothing in the printer driver. a On the Advanced tab, set Bitmap Smoothing under Items: to On . Does this solve your problem?	The task is complete.	Go to action 4.
4 Enable Bitmap Text Smoothing in the printer driver. a On the Advanced tab, set Bitmap Text Smoothing under Items: to On . Does this solve your problem?	The task is complete.	Go to action 5.
5 If using a downloaded font, ensure that the font is recommended for the printer, operating system, and the application being used. Does this solve your problem?	The task is complete.	Contact Dell.

Banding

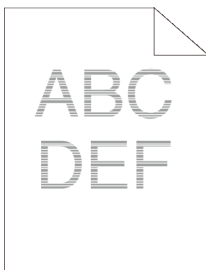

Action	Yes	No
<p>1 Locate the cause of the problem using the Pitch Configuration Chart.</p> <p>a Launch the Tool Box, and click Chart Print on the Diagnosis tab.</p> <p>b Click the Pitch Configuration Chart button.</p> <p>The Pitch Configuration Chart is printed.</p> <p>Is the cause of the problem located?</p>	<p>Proceed to the action corresponding to the location of the problem:</p> <ul style="list-style-type: none"> • PHD unit - 2 • Fuser - Contact Dell and replace the fuser. • Main unit of the printer - Contact Dell 	<p>Contact Dell.</p>
<p>2 Replace the PHD unit if you have a spare unit.</p> <p>a Replace the PHD unit. See "Replacing the Print Head Device (PHD) Unit" and "Installing a PHD Unit."</p> <p>b After you replace the PHD unit, click Chart Print on the Diagnosis tab.</p> <p>c Click the Pitch Configuration Chart button.</p> <p>The Pitch Configuration Chart is printed.</p> <p>Does this solve your problem?</p>	<p>The task is complete.</p>	<p>Contact Dell.</p>

Auger mark



Action	Yes	No
<p>1 Locate the cause of the problem using the Pitch Configuration Chart.</p> <p>a Launch the Tool Box, and click Chart Print on the Diagnosis tab.</p> <p>b Click the Pitch Configuration Chart button.</p> <p>The Pitch Configuration Chart is printed.</p> <p>Does the output match with the pattern for auger mark?</p>	Go to action 2.	Contact Dell.
<p>2 Execute the Clean Developer.</p> <p>a Launch the Tool Box, and click Clean Developer on the Diagnosis tab.</p> <p>b Click the Start button.</p> <p>c After you execute the Clean Developer, click Chart Print on the Diagnosis tab.</p> <p>d Click the Pitch Configuration Chart button.</p> <p>The Pitch Configuration Chart is printed.</p> <p>Does this solve your problem?</p>	The task is complete.	Go to action 3.
<p>3 Replace the PHD unit if you have a spare unit. See "Replacing the Print Head Device (PHD Unit)" and "Installing a PHD Unit."</p> <p>Does this solve your problem?</p>	The task is complete.	Contact Dell.

Wrinkled/Stained paper

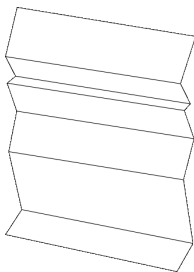

Action	Yes	No
1 Verify that the correct print media is being used. See "Supported Paper Types." If not, use the print media recommended for the printer. Does this solve your problem?	The task is complete.	If printing on an envelope, go to action 2a. If printing on print media other than envelopes, go to action 2b.
2a Check the wrinkle. Is the wrinkle within 30 mm of the four edges of the envelope?	This type of wrinkle is considered normal. Your printer is not at fault.	If the envelope is 220 mm or longer (C5 or Envelope #10), go to action 3a. If the envelope is shorter than 220 mm (Monarch or DL), go to action 3a or 3b.
2b Execute the Paper Wrinkle Check Mode . a Launch the Tool Box, and click Paper Wrinkle Check Mode on the Diagnosis tab. b Click the Start button. Is the paper wrinkled?	Contact Dell.	Contact Dell to replace fuser.
3a Load the envelopes in the standard 250-sheet tray in the short edge feed orientation with the flap closed and print side up. For details, see "Loading Envelopes in the Standard 250-Sheet Tray and Optional 250-Sheet Feeder." Does this solve your problem?	The task is complete.	Contact Dell.
3b Load the envelopes in the standard 250-sheet tray in the long edge feed orientation with the flap open and print side up. For details, see "Monarch or DL." Does this solve your problem?	The task is complete.	Contact Dell.

Damage on the leading edge of paper

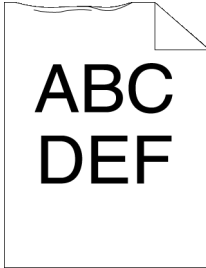

Action	Yes	No
1 When you use the SSF, reverse the paper and then try again. When you use any of the trays, change the paper and then try again. Does this solve your problem?	The task is complete.	(SSF) Go to action 2. (trays) Contact Dell.
2 Change the paper with another one and then try again. Does this solve your problem?	The task is complete.	Go to action 3.
3 Use any of other tray in place of the SSF. Does this solve your problem?	The task is complete.	Contact Dell.

Jam/Alignment Problems



NOTE: Some of the following procedures that use the Tool Box can also be performed using the operator panel or Dell Printer Configuration Web Tool. For information on how to use the operator panel and Dell Configuration Web Tool, see "Understanding the Tool Box Menus" and "Dell Printer Configuration Web Tool."

- The top and side margins are incorrect
- Color registration is out of alignment
- Images are skewed
- Standard 250-Sheet Tray Misfeed Jam
- SSF Misfeed Jam
- Optional 250-Sheet Feeder Misfeed Jam

- Regi Jam (Exit Sensor On JAM)
- Exit Jam (Exit Sensor Off JAM)
- Standard 250-Sheet Tray/Optional 250-Sheet Feeder Multi-feed Jam
- SSF Multi-feed Jam

The top and side margins are incorrect

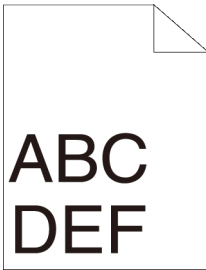

Action	Yes	No
1 Ensure that the margins are set correctly on the application being used. Does this solve your problem?	The task is complete.	Contact Dell.

Color registration is out of alignment



Action	Yes	No
<p>1 Execute auto color registration adjustment.</p> <p>a On the operator panel, press the  (Menu) button and select Admin Menu→ Maintenance→ Color Reg Adjustment→ Auto Correct.</p> <p>OR</p> <p>a Launch the Tool Box, and click Color Registration Adjustment on the Printer Maintenance tab.</p> <p>b Click the Start button under Auto Correct.</p> <p>Does this solve your problem?</p>	The task is complete.	Go to action 2.
<p>2 Do you have a spare PHD unit?</p>	Go to action 3a.	Go to action 3b.
<p>3a Replace the PHD unit if you have a spare unit.</p> <p>a Replace the PHD unit. See "Replacing the Print Head Device (PHD) Unit" and "Installing a PHD Unit."</p> <p>b Launch the Tool Box, and click Color Registration Adjustment on the Printer Maintenance tab.</p> <p>c Click the Start button under Print Color Regi Chart.</p> <p>The Color Regi Configuration Chart is printed.</p> <p>Does this solve your problem?</p>	The task is complete.	Contact Dell.

Action	Yes	No
<p>3b Print the Color Regi Configuration Chart and manually correct the color registration.</p> <p>a Launch the Tool Box, and click Color Registration Adjustment on the Printer Maintenance tab.</p> <p>b Click the Start button under Print Color Regi Chart.</p> <p>The Color Regi Configuration Chart is printed.</p> <p>c Identify the offset values from the chart and enter them in Color Registration Adjustment (Process) and Color Registration Adjustment (Left). See "Adjusting Color Registration" for details.</p> <p>d Click the Apply New Settings button.</p> <p>e Click the Start button under Print Color Regi Chart to print the Color Regi Configuration Chart again.</p>	The task is complete.	Contact Dell.

Does this solve your problem?

Images are skewed

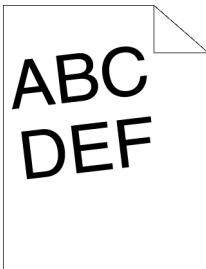

Action	Yes	No
<p>1 Adjust the paper guides properly.</p> <p>Does this solve your problem?</p>	The task is complete.	Contact Dell.

Standard 250-Sheet Tray Misfeed Jam

Action	Yes	No
<p>1 Ensure that the standard 250-sheet tray is properly inserted.</p> <p>Does this solve your problem?</p>	<p>The task is complete.</p>	<p>Proceed to the action corresponding to the type of the print media being used:</p> <ul style="list-style-type: none"> • Thick - 2a • Thin - 2b • Coated - 2c • Envelope - 2d <p>If performing manual duplex printing, go to action 2e.</p> <p>If using paper other than the above or if not performing manual duplex printing, go to action 2f.</p>
<p>2a Use thick paper that is 216 g/m² or less.</p> <p>Does this solve your problem?</p>	<p>The task is complete.</p>	<p>Go to action 3a.</p>
<p>2b Use thin paper that is 60 g/m² or more.</p> <p>Does this solve your problem?</p>	<p>The task is complete.</p>	<p>Go to action 3a.</p>
<p>2c Load coated paper one sheet at a time.</p> <p>Does this solve your problem?</p>	<p>The task is complete.</p>	<p>Go to action 3b.</p>
<p>2d Ensure that the envelope is properly loaded in the Standard 250-sheet tray as instructed in "Loading Envelopes in the Standard 250-Sheet Tray and Optional 250-Sheet Feeder."</p> <p>Does this solve your problem?</p>	<p>The task is complete.</p>	<p>Go to action 3c.</p>

Action	Yes	No
2e Ensure that the print media is not curled. Does this solve your problem?	The task is complete.	Go to action 3a.
2f Is the print media damp?	Go to action 3d.	Go to action 3a.
3a Fan the print media. Does this solve your problem?	The task is complete.	Go to action 3b.
3b Wipe the retard roller in the standard 250-sheet tray with a cloth moistened with water. Does this solve your problem?	The task is complete.	Go to action 4b.
3c If the envelope is deformed, correct it or use another envelope. Does this solve your problem?	The task is complete.	Go to action 3a.
3d Turn over the print media. Does this solve your problem?	The task is complete.	Go to action 4a.
4a Use print media that is not damp. Does this solve your problem?	The task is complete.	Go to action 3a.
4b Replace the PHD unit if you have a spare unit. Does this solve your problem?	The task is complete.	Contact Dell.

SSF Misfeed Jam

Action	Yes	No
1 Ensure that the SSF is properly inserted. Does this solve your problem?	The task is complete.	Proceed to the action corresponding to the type of the print media being used: <ul style="list-style-type: none"> • Thick - 2a • Thin - 2b • Coated - 2c • Envelope - 2d <p>If performing manual duplex printing, go to action 2e.</p> <p>If using paper other than the above or if not performing manual duplex printing, go to action 2f.</p>
2a Use thick paper that is 216 g/m ² or less. Does this solve your problem?	The task is complete.	Go to action 3a.
2b Use thin paper that is 60 g/m ² or more. Does this solve your problem?	The task is complete.	Go to action 3a.
2c Load coated paper one sheet at a time. Does this solve your problem?	The task is complete.	Go to action 3b.
2d Ensure that the envelope is properly loaded in the SSF as instructed in "Loading an Envelope in the SSF." Does this solve your problem?	The task is complete.	Go to action 3c.
2e Ensure that the print media is not curled. Does this solve your problem?	The task is complete.	Go to action 3a.

Action	Yes	No
2f Is the print media damp?	Go to action 3d.	Go to action 3a.
3a Fan the print media. Does this solve your problem?	The task is complete.	Go to action 3b.
3b Wipe the retard roller in the SSF tray with a cloth moistened with water. Does this solve your problem?	The task is complete.	Go to action 4b.
3c If the envelope is deformed, correct it or use another envelope. Does this solve your problem?	The task is complete.	Go to action 3a.
3d Turn over the print media. Does this solve your problem?	The task is complete.	Go to action 4a.
4a Use print media that is not damp. Does this solve your problem?	The task is complete.	Go to action 3a.
4b Replace the PHD unit if you have a spare unit. Does this solve your problem?	The task is complete.	Contact Dell.

Optional 250-Sheet Feeder Misfeed Jam

Action	Yes	No
1 Ensure that the optional 250-sheet feeder is properly inserted. Does this solve your problem?	The task is complete.	Go to action 2.
2 Ensure the right hand cover is closed. Does this solve your problem?	The task is complete.	Proceed to the action corresponding to the type of the print media being used: Thick - 3a Thin - 3b Manual Dup - 3c Others - 3d

Action	Yes	No
3a Use thick paper that is 105 g/m ² or less. Does this solve your problem?	The task is complete.	Go to action 4a.
3b Use thin paper that is 60 g/m ² or more. Does this solve your problem?	The task is complete.	Go to action 4a.
3c Ensure that the print media is not curled. Does this solve your problem?	The task is complete.	Go to action 4a.
3d Is the print media damp?	Go to action 4c.	Go to action 5.
4a Fan the print media. Does this solve your problem?	The task is complete.	Go to action 4b.
4b Wipe the retard roller in the optional 250-sheet feeder with a cloth moistened with water. Does this solve your problem?	The task is complete.	Contact Dell.
4c Turn over the print media. Does this solve your problem?	The task is complete.	Go to action 4a.
5 Use print media that is not damp. Does this solve your problem?	The task is complete.	Go to action 4a.

Regi Jam (Exit Sensor On JAM)

Action	Yes	No
1 Ensure that the PHD unit is installed correctly. Does this solve your problem?	The task is complete.	Go to action 2.
2 Replace the PHD unit if you have a spare unit. See "Replacing the Print Head Device (PHD) Unit." Does this solve your problem?	The task is complete.	Contact Dell.

Exit Jam (Exit Sensor Off JAM)

Action	Yes	No
1 Ensure the fuser is installed correctly. Does this solve your problem?	The task is complete.	Contact Dell.

Standard 250-Sheet Tray/Optional 250-Sheet Feeder Multi-feed Jam

Action	Yes	No
1 Ensure that the tray is properly inserted. Does this solve your problem?	The task is complete.	If using coated paper, go to action 2. If using other type of print media, go to action 3.
2 Load coated paper one sheet at a time. Does this solve your problem?	The task is complete.	Go to action 4.
3 Use print media that is not damp. Does this solve your problem?	The task is complete.	Go to action 4.
4 Fan the print media. Does this solve your problem?	The task is complete.	Go to action 5.
5 Wipe the retard roller in the tray where the multi-feed occurred with a cloth moistened with water. Does this solve your problem?	The task is complete.	Contact Dell.

SSF Multi-feed Jam

1 Ensure the media type you are using. If using coated paper, go to action 2. If using other type of print media, go to action 3.	-	-
2 Load coated paper one sheet at a time. Does this solve your problem?	The task is complete.	Go to action 4.
3 Use print media that is not damp. Does this solve your problem?	The task is complete.	Go to action 4.
4 Fan the print media. Does this solve your problem?	The task is complete.	Go to action 5.
5 Wipe the retard roller in the tray where the multi-feed occurred with a cloth moistened with water. Does this solve your problem?	The task is complete.	Contact Dell.

Noise

Action	Yes	No
1 To specify the cause of the noise, perform the Auto Registration Adjustment. Does this solve your problem?	Go to action 2.	Go to action 3.
2 Replace the PHD unit if you have a spare unit. Does this solve your problem?	The task is complete.	Contact Dell.
3 Replace the toner cartridge (K). See "Replacing the Toner Cartridges."	The task is complete. (The toner cartridge (K) you are using has been damaged. Replace it with a new one.)	Go to action 4.
4 Replace the toner cartridge (Y). See "Replacing the Toner Cartridges."	The task is complete. (The toner cartridge (Y) you are using has been damaged. Replace it with a new one.)	Go to action 5.
5 Replace the toner cartridge (M). See "Replacing the Toner Cartridges."	The task is complete. (The toner cartridge (M) you are using has been damaged. Replace it with a new one.)	Go to action 6.

6	Replace the toner cartridge (C). See "Replacing the Toner Cartridges."	The task is complete. (The toner cartridge (C) you are using has been damaged. Replace it with a new one.)	Contact Dell.
---	--	--	---------------

Problems With Installed Optional Accessories

If an option does not operate correctly following installation or stops working:

- Turn off the printer, wait for 10 seconds, and then turn on the printer. If this does not fix the problem, unplug the printer, and check the connection between the option and the printer.
- Print the printer settings report to see if the option is listed in the Installed Options list. If the option is not listed, re-install it. See "Printing Printer Settings Report."
- Ensure the option is selected in the printer driver you are using.

The following table lists printer's option and corrective action for related problem. If the suggested corrective action does not correct the problem, call customer service.

Problem	Action
250-sheet feeder	<ul style="list-style-type: none">• Ensure the 250-sheet feeder is correctly installed on the printer. Re-install the feeder. See "Removing the Optional 250-Sheet Feeder" and "Installing the Optional 250-Sheet Feeder."• Ensure the print media is loaded correctly. See "Loading Print Media in the Standard 250-Sheet Tray and the Optional 250-Sheet Feeder" for more information.
Memory module	<ul style="list-style-type: none">• Ensure the memory module is securely connected to the memory connector.
Wireless printer adapter	<ul style="list-style-type: none">• Ensure the wireless printer adapter is securely inserted to the correct slot.

Other Problems

Problem	Action
Condensation has occurred inside the printer.	This usually occurs within several hours after you heat the room in winter. This also occurs when the printer is operating in a location where relative humidity reaches 85% or more. Adjust the humidity or relocate the printer to an appropriate environment.

Problem	Action
"CTD Sensor Error Error 009-340 Code:xx Restart Printer", "Check CTD Unit 092-910 Clean CTD Sensor", or "Check CTD Unit 092-310" is displayed.	Clean the CTD sensor. See "Cleaning the CTD Sensor."
"Authentication error has occurred. The account is not registered. Please contact the system administrator. 016-757" is displayed on the Status Monitor.	Contact your system administrator.
"Function unavailable. It is a function that cannot be used. Please contact the system administrator. 016-758" is displayed on the Status Monitor.	Contact your system administrator.
"Printable page limit reached. Printable page limit reached, cannot print. Please contact the system administrator. 016-759" is displayed on the Status Monitor.	Contact your system administrator.

Problem	Action
"Multifunction printer error. Check the PHD unit and the Toner Cartridge. Contact customer support if this failure is repeated. 093-919" is displayed on the Status Monitor.	<p>Replace the toner cartridge of the color displayed on the operator panel.</p> <hr/> <p>Replace the PHD unit.</p> <hr/> <p>Contact Customer Support.</p>
"Multifunction printer error. Check the PHD unit and the Toner Cartridge. Contact customer support if this failure is repeated. 093-920" is displayed on the Status Monitor.	<p>Replace the toner cartridge of the color displayed on the operator panel.</p> <hr/> <p>Replace the PHD unit.</p> <hr/> <p>Contact Customer Support.</p>
"Multifunction printer error. Check the PHD unit and the Toner Cartridge. Contact customer support if this failure is repeated. 093-921" is displayed on the Status Monitor.	<p>Replace the toner cartridge of the color displayed on the operator panel.</p> <hr/> <p>Replace the PHD unit.</p> <hr/> <p>Contact Customer Support.</p>
"Multifunction printer error. Check the PHD unit and the Toner Cartridge. Contact customer support if this failure is repeated. 093-922" is displayed on the Status Monitor.	<p>Replace the toner cartridge of the color displayed on the operator panel.</p> <hr/> <p>Replace the PHD unit.</p> <hr/> <p>Contact Customer Support.</p>

Problem	Action
"An internal temperature of the printer became a high temperature. 042-700" is displayed on the Status Monitor.	Please wait for a while until falling in temperature.

Contacting Service

When you call for printer service, be prepared to describe the problem you are experiencing or the error message that appears.

You need to know the model type and service tag of your printer. See the label located inside the side door of your printer.

Appendix

Appendix

Dell™ Technical Support Policy

Technician-assisted technical support requires the cooperation and participation of the customer in the troubleshooting process and provides for restoration of the operating system, software program and hardware drivers to the original default configuration as shipped from Dell, as well as the verification of appropriate functionality of the printer and all Dell-installed hardware. In addition to this technician assisted technical support, online technical support is available at Dell Support. Additional technical support options may be available for purchase.

Dell provides limited technical support for the printer and any Dell-installed software and peripherals. Support for third-party software and peripherals is provided by the original manufacturer, including those purchased and/or installed through Software & Peripherals (DellWare), ReadyWare, and Custom Factory Integration (CFI/DellPlus).

Online Services

You can learn about Dell products and services on the following websites:

www.dell.com

www.dell.com/ap (Asian/Pacific countries only)

www.dell.com/jp (Japan only)

www.euro.dell.com (Europe only)

www.dell.com/la (Latin American and Caribbean countries)

www.dell.ca (Canada only)

You can access Dell Support through the following websites and e-mail addresses:

- Dell Support websites

support.dell.com

support.jp.dell.com (Japan only)

support.euro.dell.com (Europe only)

- Dell Support e-mail addresses
mobile_support@us.dell.com
support@us.dell.com
la-techsupport@dell.com (Latin America and Caribbean countries only)
apsupport@dell.com (Asian/Pacific countries only)
- Dell Marketing and Sales e-mail addresses
apmarketing@dell.com (Asian/Pacific countries only)
sales_canada@dell.com (Canada only)
- Anonymous file transfer protocol (FTP)
ftp.dell.com

Log in as user: `anonymous`, and use your e-mail address as your password.

Warranty and Return Policy

Dell Computer Corporation ("Dell") manufactures its hardware products from parts and components that are new or equivalent to new in accordance with industry-standard practices. For information about the Dell warranty for your printer, see **support.dell.com**.

Recycling Information

It is recommended that customers dispose of their used computer hardware, monitors, printers, and other peripherals in an environmentally sound manner. Potential methods include reuse of parts or whole products and recycling of products, components, and/or materials.

For specific information on Dell's worldwide recycling programs, see **www.dell.com/recyclingworldwide**.

Contacting Dell

You can access Dell Support at **support.dell.com**. Select your region on the WELCOME TO DELL SUPPORT page, and fill in the requested details to access help tools and information.

You can contact Dell electronically using the following addresses:

- World Wide Web
www.dell.com
www.dell.com/ap (Asian/Pacific countries only)
www.dell.com/jp (Japan only)
www.euro.dell.com (Europe only)
www.dell.com/la (Latin American and Caribbean countries)
www.dell.ca (Canada only)
- Anonymous file transfer protocol (FTP)
ftp.dell.com
 Log in as user: anonymous, and use your email address as your password.
- Electronic Support Service
 mobile_support@us.dell.com
 support@us.dell.com
 la-techsupport@dell.com (Latin America and Caribbean countries only)
 apsupport@dell.com (Asian/Pacific countries only)
 support.jp.dell.com (Japan only)
 support.euro.dell.com (Europe only)
- Electronic Quote Service
 apmarketing@dell.com (Asian/Pacific countries only)
 sales_canada@dell.com (Canada only)

Index

Symbols

(Cancel) button, 234

(Set) button, 234

Numerics

1000BASE-T Full-Duplex, 184

100BASE-TX Full-Duplex, 184

100BASE-TX Half-Duplex, 184

10BASE-T Full-Duplex, 184

10BASE-T Half-Duplex, 184

4 Colors Configuration
Chart, 278

802.1x, 202

A

A4, 218

A5, 218

About printer, 29

Ad-Hoc, 197

Adjust Altitude, 163, 174, 263,
272

Adjust BTR, 162, 171, 311

Adjust Fuser, 163, 171, 312

Adjusting color registration, 396

Adjusting the Language, 255

Admin Menu, 284

Administrator Account, 196

Alert Tone, 159, 166, 261, 266,
304

Alignment Chart, 278

All Tones, 159, 166, 304

Altitude, 367

Appendix, 477

Apply New Settings, 152

Asset Tag Number, 142, 156

Assigning IP address, 83

Audio Tone, 266

Authenticate Error Trap, 195

Auto Clear Alert, 267

Auto Clear Alert Tone, 159, 166,
261

Auto Correct, 172, 314

Auto Log Print, 159, 167, 261,
267, 305

Auto Reg Adjust, 313

Auto Registration
Adjustment, 163, 172, 262,
271

Auto Reset, 158, 166, 260, 265

AutoClear Alert, 304

AutoIP, 298

Avoiding jam, 239, 411

B

B5, 218

Banner Sheet, 268

Banner Sheet Insert
Position, 159, 167, 262

Banner Sheet Specify Tray, 160,
167, 262

Base memory, 365

Basic Information, 183

Basic printer problem, 431

Belt unit, 30

Bitmapped font, 349

Bonjour (mDNS), 184, 299

BOOTP, 298

C

C5, 218

Cable, 367

Canceling a print job, 240

Canceling print job
From your computer, 241

Carbonless copy paper, 211

CCP, 211

Change printer settings, 252

Changing the settings of menu
item, 152

Clean Developer, 173, 281

Clearing jam, 411
From duplexer, 423
From fuser, 420
From optional 250-sheet
feeder, 425
From SSF, 413
From standard 250-sheet tray, 416

Clock Settings, 163

Coated, 162-163, 171-172, 312-
313

Coated Thick, 162-163, 171-172,
312-313

Color Mode, 280

Color Mode Limitation, 206

Color Reg Adjust, 313

Color Regi Chart, 173

Color Registration
Adjustments, 172-173

Color registration chart, 396

Color Test Page, 165, 264, 284

ColorReg Chart, 314

ColorTrack Error Report, 262,
268

Community Name, 193-194

Completed Jobs, 143, 157

Confidential jobs, 323

configuring wireless adapter, 56

- Connecting local printer, 80
 - Connecting printer, 79
 - Connecting to the Network, 81
 - Connection specification, 79, 367
 - Connection type, 79, 367
 - Conserving supplies, 371
 - Contact Dell Support at, 145, 151
 - Contact Person, 149
 - Contacting service, 470
 - Control board, 30
 - Control board cover, 30
 - Control Panel, 266, 303
 - Control Panel Tone, 158, 166, 260
 - Copy Printer Settings, 144, 150, 204
 - Copy Printer Settings Report, 204
 - Cover, 155
 - Covers, 162-163, 171-172, 312-313
 - Covers Thick, 162-163, 171-172, 312-313
 - Cumulative Color Page Count, 206
 - Cumulative Monochrome Page Count, 207
 - Custom Size - X, 161, 168
 - Custom Size - Y, 161, 168
- D**
- Date & Time, 262, 269
 - Date Format, 163, 262, 270
 - Deep Sleep, 265
 - Default Color, 161, 168, 292
 - Default Paper Size, 159, 167
 - Default Print Paper Size, 262, 268
 - Dell ColorTrack, 164, 205
 - Dell Printer Configuration Web Tool, 250
 - Page display format, 148
 - Dell Service Tag Number, 156
 - Dell Supplies Management System, 329
 - Dell support website, 25
 - Dell technical support policy, 477
 - Details, 156
 - Determining Values, 397
 - DHCP, 298
 - Dimensions, 365
 - DIMM Size, 365
 - Direct connection setup, 95
 - Disabling Panel Lock, 327
 - Dispense Motor Check (Black), 279

- Dispense Motor Check (Cyan), 279
- Dispense Motor Check (Magenta), 279
- Dispense Motor Check (Yellow), 279
- Display of EWS, 277
- Display problem, 431
- DL, 218
- DNS, 178, 186
- Draft Mode, 161, 168, 292
- Driver, 23
- Drivers and utilities CD, 23
- Drum Refresh, 173
- Drum Refresh Configuration Chart, 278
- Drum Refresh Mode, 281
- Duplexer, 29, 412

E

- Edit Print User Registration, 205
- E-Mail Alert, 144, 151, 184, 190, 299
- E-Mail Alert Settings, 182, 192
- E-Mail Alert Setup, 141
- E-mail Alert Setup Page, 181
- E-Mail Server Settings, 182, 191
- Emulations, 366

- Encryption, 197-198
- End Time, 161
- Enter Number, 314
- Entering Values, 399
- Envelope, 162-163, 171-172, 215, 312
- Envelope #10, 218
- Environment, 366
- environment settings of your web browser, 145
- Error History, 165, 264, 284
- error messages, 355
- Error-Code, 355
- Ethernet, 174, 176, 184, 367
- Ethernet port, 30, 79, 82
- Event Panel, 149
- EWS, 299
- EWS Settings, 183
- Executive, 218
- Express Service Service Code, 156

F

- fast scan, 397
- Fault Time-Out, 158, 166, 261, 267
- Fault Tone, 159, 166, 261, 266, 304

Feed Roll Operation Check, 279
Finding Information, 23
Firmware Version, 156
Flip on Long Edge, 244
Flip on Short Edge, 245
Folio, 218
Font, 161, 168, 347
 PCL 5/PCL 6, 351
 Pitch, 348
 Point size, 348
 Style, 347
 Typefaces and fonts, 347
 Weight, 347
Font Pitch, 161, 168, 290
Font Size, 161, 168, 289
Form Line, 161, 168, 290
Front cover, 30
Fuser, 412
Fuser Motor Operation
 Check, 279

G

Gateway Address, 186, 264, 277,
 298
Get Environment Sensor
 Info, 281
Ghost Configuration Chart, 278

H

Hex Dump, 161, 168, 291
Host I/F, 157
Host Name, 157, 192
How to install option, 41
How to remove option, 403
How to replace retard roller, 384
How to set up, 25
How to use printer, 24
HTTP, 179, 188
HTTP-SSL/TLS, 299
HTTP-SSL/TLS
 Communication, 200

I

ID, 157
Identifying print media, 218
Identifying print paper, 218
Image Enhancement, 161, 168
Impression Number, 157
Infrastructure, 197
Init Print Meter, 315
Initialize NIC NVM and restart
 printer, 199
Initialize Print Meter, 273
Installing optional 250-sheet
 feeder, 46

Installing retard roller in tray, 386
Installing the optional accessories, 41
Installing toner cartridge, 38
Installing wireless printer adapter, 51
Interfaces, 366
Invalid Key, 266, 303
Invalid Key Tone, 158, 166, 260
IP Address, 83, 142-143, 149, 177, 186, 195, 202-203, 264, 276, 298
IP Address Mode, 264, 276
IP Filter, 181, 203
IP filter setup, 188
IPP, 184, 299
IPsec, 201, 298
IPv4, 195, 202, 298
IPv6, 178, 186, 195, 202

J

Job Completed, 266, 304
Job Completed Tone, 159, 166, 261
Job History, 165, 264, 284
Job List, 143, 157
Job Name, 157
Job Status, 157

Job Submitted Time, 157
Job Time-Out, 158, 166, 261, 267

L

Label, 162-163, 171-172, 216, 262, 270, 312-313
Landscape, 287
LCD panel, 233
Left frame, 150
Legal, 218
Letter, 218
Letterhead Duplex Mode, 160, 167, 262, 268
Line Termination, 161, 168, 292
Link Channel, 197
Link Quality, 197
LLTD, 184, 299
Loading an envelope in the SSF, 229
Loading letterhead, 226
Loading paper, 89
Loading print media, 221
SSF, 228
standard 250-sheet tray and optional 250-sheet feeder, 221
Location, 149, 156
Login Error, 169

Login Error -Attempts, 161
Low Toner Alert, 267, 304
Low Toner Alert Msg, 160, 167,
262, 269
Low Toner Alert Tone, 159, 166,
261
LPD, 178, 184, 187, 299

M

MAC Address, 197
Machine Check, 279
Machine Ready, 266, 303
Machine Ready Tone, 159, 166,
260
Main Motor Operation
Check, 279
Maintenance, 371
Manual Registration
Adjustments, 271
Maximum memory, 365
Memory, 365
Memory Capacity, 156
Memory connector, 365
Memory module, 403
Memory slot, 30
Memory speed, 365
Menu item, 152
Menu Settings, 158

MIB compatibility, 366
mm/inch, 159, 167, 262, 268
Monarch, 218
MQ Chart, 278
Multiple Up, 372

N

NCR, 211
Network, 81
Network connection setup, 98
Network Firmware Version, 156
Network Type, 197
No carbon required, 211
No. of Sheets, 157
Non-Dell Toner, 163, 263, 273,
316

O

OCR, 211
Online Help, 145, 151
Operation, 366
Operator panel, 29, 233
Operator Panel Buttons, 233
Optical character
recognition, 211
Optional 250-sheet feeder, 29,
412

- Order Supplies at, 145, 151
- Ordering supplies, 32, 372
- Orientation, 161, 168, 286
- OS, 366
- OS compatibility, 365
- Other problems, 467
- Out of Paper, 266, 304
- Out of Paper Alert Tone, 261
- Out of Paper Tone, 159, 166
- Output Result, 157
- Output Tray, 155
- Owner, 157

P

- Page display format, 148
- Page orientation, 214, 227
- Panel, 298
- Panel Language, 160, 167, 261, 269, 322
- Panel Lock Set, 161, 317
- Panel Settings, 165, 264, 283
- Panel settings page, 165, 234
- Paper, 209
 - Characteristics, 209
 - Curl, 209
 - Fiber content, 210
 - Grain direction, 210
 - Moisture content, 210
 - Smoothness, 210

- Weight, 209
- Paper Density, 162, 170, 262, 311
- Paper jam location, 412
- Paper Size, 161, 168, 280, 285
- Paper Tray, 161, 168, 285
- Paper Type, 219, 280
- Paper Used, 205
- Parts name, 29
- Password, 188, 196, 199, 203
- PCL, 285
 - Font, 288
- PCL 5/PCL 6, 351
- PCL Fonts List, 165, 264, 283
- PCL Macro List, 165, 264, 283
- PCL printer driver, 95, 98
- PCL Settings, 161, 167
- PDL, 366
- Peer-to-Peer, 115
- Pitch Configuration Chart, 278
- Plain, 162-163, 171, 262, 270, 312-313
- Plain Thick, 162-163, 171, 312-313
- Play of Sound, 279
- Point and Print, 113
- Port Settings, 183
- Port Status, 184
- Port9100, 178, 184, 187, 299

Portrait, 287
 Power connector, 30
 Power Saver Time, 301
 Power Saver Time - Deep Sleep, 158
 Power Saver Time - Sleep, 158
 Power Saver Timer, 265
 Power Saver Timer Deep Sleep, 260
 Power Saver Timer Sleep, 260
 Power supply, 365
 Power switch, 30
 Premier, 164
 Print cartridge level, 155
 Print Drivers / Remote Client Account, 196
 Print ID, 159, 167, 261, 267, 305
 Print media, 209, 372
 Source, 214, 227
 Print Meter, 165, 264
 Print quality guarantee, 366
 Print Server Reports, 175
 Print Server Settings, 144, 150, 175, 183, 277
 Print Server Setup Page, 176
 Print side, 214, 227
 Print Text, 159, 167, 261, 267, 306
 Print User Settings, 206
 Print Volume, 144, 150, 204
 Printer Bitmap, 149
 Printer Driver, 127, 129
 Printer Events, 156
 Printer Information, 144, 150, 156
 Printer Jobs, 143, 150, 156
 Printer Maintenance, 170
 Printer Page Count, 205
 Printer paper, 209
 Printer Revision Levels, 156
 Printer Serial Number, 156
 Printer Settings, 143, 150, 158, 165, 264
 Printer Settings Report, 158
 Printer settings report, 44, 48, 54
 Printer settings utility, 331
 Printer software, 329
 Printer specification, 365
 Printer Status, 143, 150, 154-155
 Printer Status Window, 329
 Printer Type, 155
 Printing, 239
 Printing on letterhead, 213
 Printing problem, 432
 Printing Speed, 156
 Problems with Optional Accessories, 467

Processor Speed, 156
Product Information Guide, 24
Proof Print, 325

Q

Quantity, 161, 168, 291
Quick Launch Utility, 331
Quick Reference Guide, 24

R

RAM Disk, 160, 167, 262, 268, 306
RARP, 298
Ready / Error LED, 233
Rear side, 280
Recommended paper, 210
Recurrence, 161
Recycled, 163, 172, 312
Red Hat, 127
Red Hat Enterprise Linux, 127, 365
Refresh, 152
REGI CLUTCH Operation
 Check, 279
Regular, 164
Relative humidity, 366
Removing an optional memory
 module, 403

Removing optional 250-sheet
 feeder, 406

Removing options, 403

Removing paper jam, 411

 From duplexer, 423

 From fuser, 420

 From optional 250-sheet
 feeder, 425

 From single sheet feeder, 413

 From tray, 416

Removing retard roller in
 tray, 385

Removing toner cartridge, 374

Removing wireless adapter, 408

Replacing the retard roller, 384

Reports, 165

Reset Print Server, 198

Resetting Defaults, 254

Resident font, 351

Resident scalable fonts, 351

Restore Settings, 152

Return policy, 478

Right frame, 151

RSA BSAFE, 20

S

Safety information, 24

Scalable font, 349

Secure Job Expiration, 170

Secure Print, 322
 Secure Settings, 161, 168
 Security, 199
 Security Settings, 197
 Select Reorder URL, 164
 Selecting letterhead, 212
 Selecting paper, 211
 Selecting preprinted form, 212
 Selecting pre-punched paper, 212
 Sending print job, 240
 Service code, 25
 Service tag, 25
 Set Available Time, 161, 169
 Set Date, 163, 262, 270
 Set Password, 144, 151, 199
 Set Time, 163, 262, 270
 Setting, 371
 Shared printing, 111
 Side button, 29
 Single Sheet Feeder (SSF), 29, 412
 Sleep, 265
 slow scan, 397-398
 SMB, 184
 SMB NetBEUI, 299
 SMB TCP/IP, 299
 SNMP, 180, 184
 SNMP UDP, 299
 Software update, 330
 SSID, 197
 SSL/TLS, 200
 Standard 250-sheet tray, 29, 412
 Start Time, 161
 Status Monitor Console, 329
 Status Monitor Console for Linux, 338
 Status Monitor Widget for Macintosh, 332
 Status of printer supplies, 371
 Status Window, 331
 Storage, 367
 Storage humidity range, 367
 Stored Documents, 165, 264, 284
 Storing consumables, 373
 Storing print media, 217, 239, 372
 Straightest lines, 397
 Subnet Mask, 264, 276, 298
 Substitute Tray, 160, 167, 262, 268, 307
 Supported print paper, 218
 SUSE, 365
 SUSE Linux Enterprise Desktop 10, 130

SUSE Linux Enterprise Desktop
11, 134
Symbol Set, 161, 168, 289, 352
For PCL 5/PCL 6, 352
System Setting, 260
System Settings, 158, 165, 183

T

TCP/IP, 185
TCP/IP Settings, 177, 185
Telnet, 184, 299
Temperature, 366
Time Format, 163, 262, 270
Time Zone, 163, 262, 270
Time-Out, 187-188, 302
Toner access cover, 29
Toner cartridge, 38
Toner Refresh, 173
Toner Refresh Mode, 281
Tool Box, 331
Top frame, 148
Trap Notification, 195
Tray 1 Custom Size - X, 164, 263,
275
Tray 1 Custom Size - Y, 164, 263,
275
Tray 1 Display Popup, 164, 263,
275

Tray 1 Paper Size, 164, 263, 274
Tray 1 Paper Type, 164, 263, 274
Tray 2 Display Popup, 164, 263,
275
Tray 2 Paper Size, 164, 263, 275
Tray 2 Paper Type, 164, 263, 275
Tray rear cover, 30
Tray Settings, 144, 150, 164, 207,
263, 318
Troubleshooting, 332, 431
Typeface, 347

U

Unacceptable paper, 211
UNITED STATES
GOVERNMENT
RESTRICTED RIGHTS, 20
Update, 332
Upper Limit for Color Print, 206
Upper Limit for Monochrome
Print, 207
USB, 367
USB port, 30, 79, 81
USB printing, 95
USB Settings, 160
User setup disk creating
tool, 330
Using Dell Printer Configuration
Web Tool, 143

V

Verifying IP settings, 86

W

Warranty, 478

Warranty information, 24

Web Link Customization, 164,
175

Web Services on Devices, 361

WEP, 197-198

Width guide, 90, 223

WINS, 178, 187

Wired Network

 Ethernet, 293

 IP Filter, 300

 Protocol, 298

 Reset LAN, 300

 TCP/IP, 297

Wireless Adapter, 51

Wireless adapter socket, 30

Wireless Settings, 176, 197

WPA-PSK, 198

WSD, 184, 299, 361

X

XPS printer driver, 95, 99

Free Manuals Download Website

<http://myh66.com>

<http://usermanuals.us>

<http://www.somanuals.com>

<http://www.4manuals.cc>

<http://www.manual-lib.com>

<http://www.404manual.com>

<http://www.luxmanual.com>

<http://aubethermostatmanual.com>

Golf course search by state

<http://golfingnear.com>

Email search by domain

<http://emailbydomain.com>

Auto manuals search

<http://auto.somanuals.com>

TV manuals search

<http://tv.somanuals.com>