

# DVP-01HC

## High-speed Counter Module Instruction Sheet

### 1 WARNING

- Please carefully read this instruction thoroughly prior to use the DVP-01HC.
- Make sure that power is OFF before wiring.
- This is an OPEN TYPE PLC. The PLC should be kept in an enclosure away from airborne dust, humidity, electric shock risk and vibration. Also, it is equipped with protective methods such as some special tools or keys to open the enclosure, in order to prevent hazard to users or damage the PLC.
- Do NOT connect the AC main circuit power supply to any of the input/output terminals, or it may damage the PLC. Check all the wiring prior to power up.

### 2 INTRODUCTION

#### 2.1 Model Name Explanation and Peripherals

- Thank you for choosing DELTA's PLC DVP series. DVP-01HC high-speed counter input module could accept 200KHz pulse from external counter. It uses instruction FROM/TO to read/write the data in module via EH MPU. There are 33 Controlled Registers (CR, each register is 16-bit) in each module. 32 bits data consists of two continuous CRs and allow executing itself after setting CR.
- The different counter modes, such as single-phase mode, two phases mode, 16-bit mode or 32-bit mode, can be designated by CR. The controlled registers are written by instruction TO via MPU. When wiring, connect 24V, A24+, B24+, P24+, D24+, A12+, B12+, A5+, B5+, P5+ and D5+ to positive potential. In the same way, 0V, A24-, B24-, P24-, D24-, A12-, B12-, A5-, B5-, P5- and D5- should be connected to negative potential.
- Input signal source could be 1-phase or 2-phase encoder and voltage level could be 5V, 12V and 24V. Besides, it also provides two terminals, PRESET and DISABLE. When terminal "PRE" is on, the data in CR#10 and CR#11 will be sent to CR#20 and CR#21. That also means current value of counter will be changed to be factory setting. When terminal "DIS" is on, "count" operation is disabled.
- There are two outputs, YH0 and YH1, in hardware input module of DVP-01HC. When counter value is equal to the setting, the corresponding output point will activate. The transistors of output points are independent and isolated.

#### Nameplate Explanation

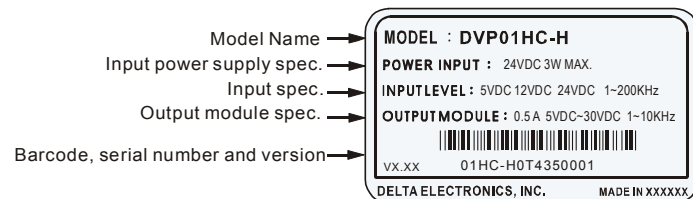

#### Model and Serial Number Explanation

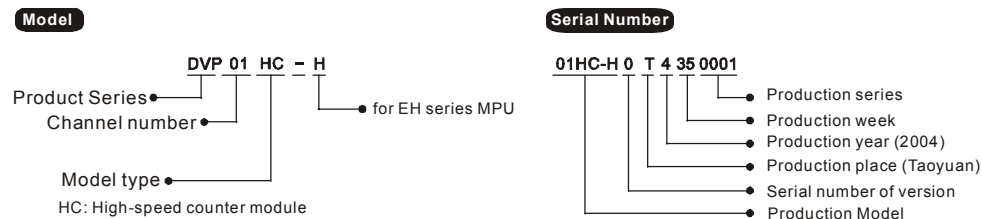

### 2.2 Product Profile and Outline

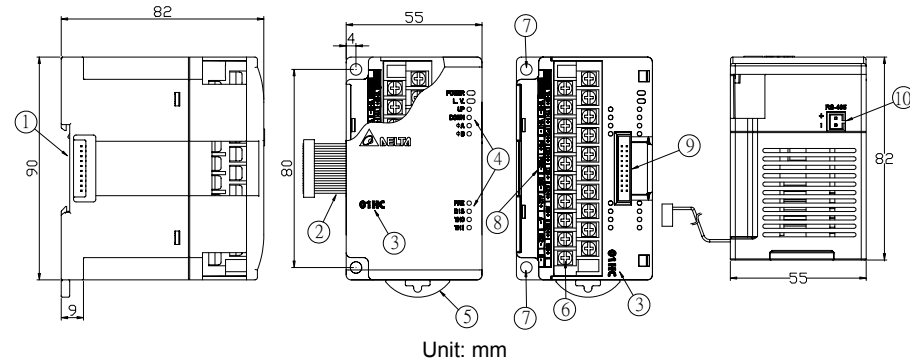

- DIN rail track (35mm)
- Mounting wire to connect extension module/extension unit
- Model name
- Status Indicator (Power, Run and ERROR)
- DIN rail clip
- Terminal
- Mounting hole
- Terminal layout
- Extension port to connect extension module/unit
- RS-485 communication port

#### LED Display

- Power** : Power LED. When external +24V power is applied, it will be ON.
- L.V.** : Low voltage LED. When external power supply is lower than 19V, it will be ON.
- UP** : Count up LED
- DOWN** : Count down LED
- ψ A** : When input point A is ON, it will light.
- ψ B** : When input point B is ON, it will light.
- PRE** : PRESET LED. When external terminal PRE is ON, it will light.
- DIS** : DISABLE LED. When external terminal DIS is ON, it will light.
- YH0, YH1** : When output points YH0 and YH1 are ON, it will light.

### 2.3 Wiring

- Please use O-type or Y-type terminals for I/O wiring terminals. The specification for the terminals is as shown on the left. Tighten PLC terminal screws to a torque of 5 to 8 kg-cm (4.3~6.9 in-lbs).
- I/O signal wires or power supply should not run through the same multi-wire cable or conduit.
- Use copper conductor only, 60°C.

#### External Wiring

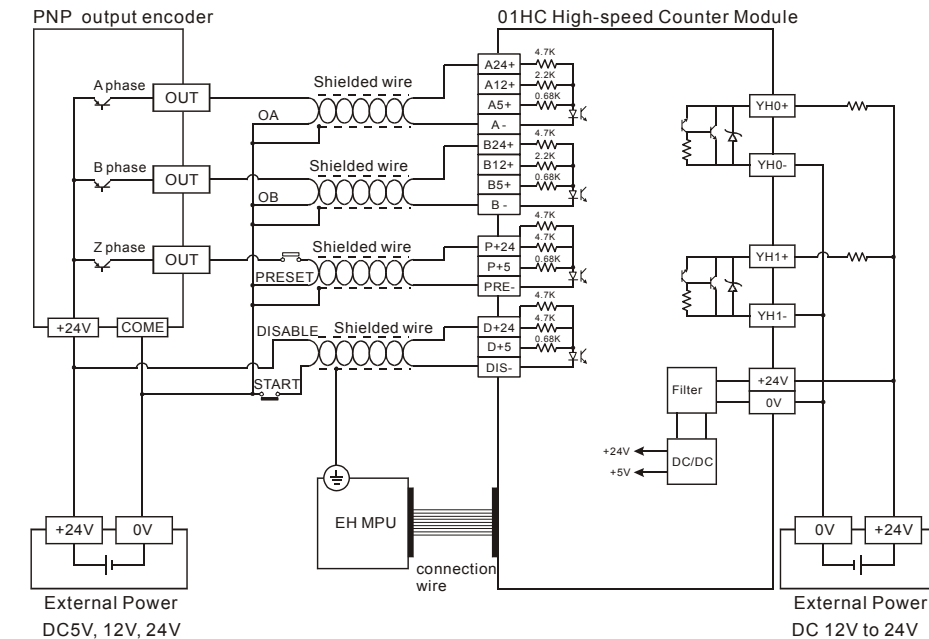

Make sure the positive/negative pole of 01HC input terminal wiring is correct when using NPN encoder.

Start-up current for 01HC is  $I_{PEAK}=0.8A$  and general working current is  $I_{MAX}=0.2A$ (input voltage is +24V).

### 3 FUNCTION SPECIFICATION

#### 3.1 Function Specification

Item	1-phase Input		2-phase (A, B) Input		
	1 Input	2 Inputs	Normal Frequency	Double Frequency	Four Times Frequency
Power Supply	DC24V(-15% ~ +20%), Current consumption 140±30mA Power is supplied from PLC or external power supply.				
Max. Number of Connecting Units	8 units; (All I/O points are not occupied. There can be 8 special extension units at most connected to EH series.)				
Input Signal	Voltage Level	Terminals [A24+], [B24+]: DC24V ±10 % Terminals P24+, [D24+]: DC12V ~24V ±10 % Terminals [A12+], [B12+]: DC12V ±10 % Terminals [A5+], [B5+], [P5+], [D5+]: DC5V ±10 % Choose only one suitable voltage level for positive pole of each signal.			A: A Phase B: B Phase P: Preset D: Disable
	Max. Count Frequency	200KHz	200KHz	200KHz	100KHz
Waveform			t1: rise/fall time ≤ 0.8us t2: On/Off pulse width ≥ 2.5us t3: phase difference between A phase and B phase ≥ 1us PRESET input: input pulse width ≥ 50us DISABLE input: input pulse width ≥ 50us		
	Count Mode	There is three count modes: count up/down ((2-phase input for AB phase), 1-phase 2 inputs and 1-phase 1 input.)			
Count Specification	Range	32-bit mode: -2,147,483,648~+2,147,483,647 16-bit mode: 0~65,536 (upper limit can be set by CR#2,3)			
	Comparison Method	Two comparison values are available and correspond to two outputs, YH0 and YH1, respectively. When count value is equal to settings, the output will be ON. It adopts hardware circuit comparison and output settings with real-time handle.			
Output Signal	Output Form	YH0+: output point YH0, transistor: Collector YH0-: output point YH0, transistor: Emitter YH1+: output point YH1, transistor: Collector YH1-: output point YH1, transistor: Emitter			
	Output	5V TO 30VDC, 0.5A			
Connect to DVP-PLC MPU in Series	The module number it connects to MPU from closest to the farthest is from 0 to 7. 8 modules is the max and it won't occupy any digital I/O.				

#### 3.2 Other Specification

Environmental specifications	
Operation/Storage	1. Operation: 0°C~55°C (Temperature), 50~95% (Humidity), pollution degree 2 2. Storage: -25°C~70°C (Temperature), 5~95% (Humidity)
Vibration/Shock immunity	Standard: IEC1131-2, IEC 68-2-6 (TEST Fc) / IEC1131-2 & IEC 68-2-27 (TEST Ea)
Antistatic spec.	All places between terminals and ground comply with the spec.

### 4 CONTROLLED REGISTER (CR)

DVP-01HC High-speed Counter Module						
HW	LW	CR No.			Content	Setting Range
		Communication Address	Latched	Attribute		
#0	H415E	✓	R	Model type	System used, read only, DVP-01HC model code=H'0120	
#1	H 415F	✗	R/W	Count up/down mode setting	Setting range: 0-1, factory setting K0 1-phase 1 input(Software): count up/down mode setting, count up: K0, count down:K1	
#3	#2	H 4160	✗	R/W	Ring length	16-bit: factory setting is K65,536.

#### Example:

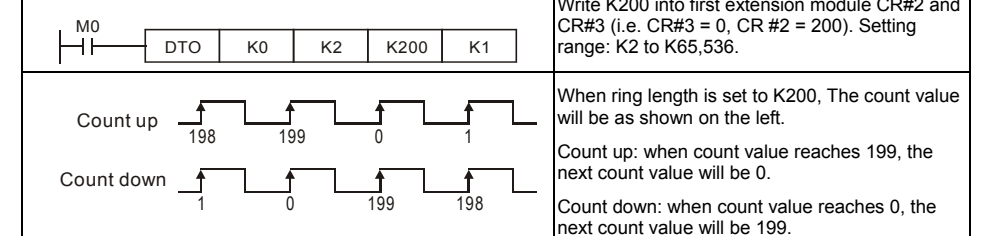

#### Setting notices:

- It must write with 32-bit.
- It only can be write-in when writing value is greater or equal to current count value.
- It only can be set when counter stops counting and count mode is 16-bit.

#4	H4162	X	R/W	Instruction	Instruction, factory setting: K0
CR#4	'0'(Off)	'1'(On)			
b0	Count is disabled	Count is enabled			
b1	YH0 output is disabled	YH0 output is enabled			
b2	YH1 output is disabled	YH1 output is enabled			
b3	YH0 and YH1 activate independently	YH0 and YH1 affect each other (they cannot be ON/OFF simultaneously)			
b4	Preset disabled	Preset is enabled			
b5~b7	Reserved				
b8	Not used	Clear error flag			
b9	Not used	Clear YH0 output			
b10	Not used	Clear YH1 output			
b11	Not used	YH0 output setting			
b12	Not used	YH1 output setting			
b13~b15	Reserved				

- When b0 is set to 1 and terminal "DIS" is off, count is enabled.
- When b1 is set to 1, YH0 (hardware comparison output) output is enabled.
- When b2 is set to 1, YH1 (hardware comparison output) output is enabled.
- When b3 is set to 1, YH0 and YH1 affect each other (they cannot be ON/OFF simultaneously). In other words, when YH0=ON, YH1 must be OFF and when YH0=OFF, YH1 must be ON. When b3=0, YH0 and YH1 activate independently.
- When b4=0, terminal "PRE" is disabled.
- When b8=1, all error flags (CR#29) will be cleared.
- When b9=1, YH0 output will be cleared to be OFF.
- When b10=1, YH1 output will be cleared to be OFF.
- When b11=1, YH0 output will be ON.
- When b12=1, YH1 output will be ON.

Setting notes:

- After setting CR#4, b8~b12 will be cleared to 0.
- It needs to set to disable count(b0=0) before setting count mode (CR#5).

#5	H4163	X	R/W	Count mode setting	Count mode K0~K11, factory setting is K0
Count mode		CR#5 settings			
		32 bits	16 bits		
2-phase 2 inputs	Normal frequency	K0	K1		
	Double frequency	K2	K3		
		K4	K5		
1-phase 2 inputs		K6	K7		

Count mode		CR#5 settings			
		32 bits	16 bits		
1-phase 1 input	Count Up/Down is controlled by Hardware (Note 1)	K8	K9		
	Count Up/Down is controlled by software (Note 2)	K10	K11		

Note1: count up/down control is controlled by external input control.  
Note2: count up/down control is controlled by internal control register(CR#1).

**16-bit mode**

When it is 16-bit mode, the count values are all positive value and its range is 0~65,536. When overflow event is occurred, count value will be changed from upper limit to 0 or from 0 to upper limit. The upper limit is set by CR#3 and CR #2.

**32-bit mode**

When it is 32-bit mode, the count range is -2,147,483,648 - 2,147,483,647. When overflow event is occurred, count value will be changed from upper limit to lower limit or from lower limit to upper limit. And upper limit is +2,147,483,647 and lower limit is -2,147,483,648.

Setting notes:

- It only can be written when count is disabled (bit 0 of CR#4 is 0).
- After writing, it will initial controlled registers as follows: CR#1: 0. CR#2, 3: 65,536. CR#10: 0. CR#12, 13: 32,767. CR#14, 15: 32,767. CR#20, 21: 0. CR#22, 23: 0. CR#24, 25: 0.

<b>1-phase 1 input (K8~K11)</b>		<b>1-phase 2 inputs (K6~K7)</b>	
External input count up/down control (K8~K9)	Internal controlled register count up/down control	1-phase 2 inputs counter (K6, K7)	
A input:	CR#1:	A input:	
B input: Off (count up) / On (count down)	A input:	B input:	
count up / count down	count value	count value	
<b>2-phase 2 inputs (K0~K5)</b>			
Normal frequency (K0, K1)	Double frequency (K2, K3)	Four times frequency (K4, K5)	
A input:	A input:	A input:	
B input:	B input:	B input:	
count value 0 1 2 2 1 0	count value 0 1 2 3 4 3 2 1 0	count value 0 1 2 3 4 5 6 7 8 7 6 5 4 3 2 1 0	

#6 ~ #9	Reserved					
#11	#10	H4168	X	R/W	Factory setting	Factory setting for counter (#10: Lower word / #11: Upper word), factory setting: K0 Setting notes: in 16-bit mode, CR#11 will be cleared to 0 when writing factory setting.
#13	#12	H416A	X	R/W	YH0 comparison value	YH0 output comparison value (#12: Lower word / #13: Upper word), factory setting: K32,767. Setting notes: in 16-bit mode, CR#13 will be cleared to 0 when writing YH0 comparison value.
#15	#14	H416C	X	R/W	YH1 comparison value	YH1 output comparison value (#14: Lower word / #15: Upper word), (factory setting: K32,767). Setting notes: in 16-bit mode, CR#15 will be cleared to 0 when writing YH1 comparison value.

When current value of counter = comparison value, output YH0/YH1 will be ON and hold. User can clear output point by using b9 and b10 of CR#4.

If count value = comparison value by using PRESET or instruction TO, corresponding output YH0 or YH1 will be OFF. In other case that count value = comparison value does not use PRESET or instruction TO, corresponding output YH0 or YH1 will be ON.

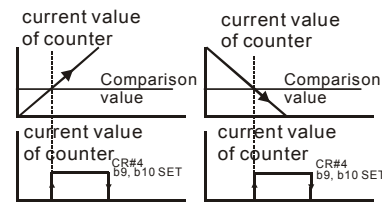

#16~ #19	Reserved					
#21	#20	H4172	X	R/W	Current value of counter	Current value of counter (#20: Lower word / #21: Upper word), factory setting is K0. Setting notes: it must write with 32-bit. In 16-bit mode, value that is written must be less than ring length (CR#2). In 16-bit mode, CR#21 will be cleared to 0 when writing into current value of counter.
#23	#22	H4174	X	R/W	Max. count value	Max. count value (#22: Lower word / #23: Upper word), factory setting is K0.
#25	#24	H4176	X	R/W	Min. count value	Min. count value (#24: Lower word / #25: Upper word), factory setting is K0.
#26	H4178	X	R		Comparison result	Comparison result

CR#26	'0'(Off)	'1'(On)	CR#26	'0'(Off)	'1'(On)
YH0	b2	Setting value ≤ current value	YH1	b6	Setting value ≤ current value
	b1	Setting value ≠ current value		b5	Setting value ≠ current value
	b0	Setting value ≥ current value		b4	Setting value ≥ current value
		Setting value > current value			Setting value > current value
		Setting value = current value			Setting value = current value
		Setting value < current value			Setting value < current value

#27	H4179	O	R	Action status	The indication of count up/down and terminal status
-----	-------	---	---	---------------	---

CR#27	'0'(Off)	'1'(On)	CR#27	'0'(Off)	'1'(On)
b0	-	Count up	b4	PRE input is Off	PRE input is On
b1	-	Count down	b5	DIS input is Off	DIS input is On
b2	A input is off	A input is on	b6	YH0 output is Off	YH0 output is On
b3	B input is off	B input is on	b7	YH1 output is Off	YH1 output is On

#29	H417B	X	R/W	Error status	Data register that is used to save all error status. Refer to table below.
-----	-------	---	-----	--------------	--

CR#29		Error Status			
b0~ b3		Reserved			
b4		CR number that is designated by instruction FROM/TO exceeds the usage range			
b5		Overflow indication, When count-up value exceeds upper limit(upper limit is CR#2 and #3 in 16-bit mode and it is K2,147,483,647 in 32-bit mode)			
b6		Overflow indication, When count-down value is less than lower limit(lower limit is 0 in 16-bit mode and it is K-2,147,483,648 in 32-bit mode)			
b7~ b15		Reserved			

#30	H417C	O	R	System version	Hexadecimal, display current software version, such as version 1.0A will be displayed as H'010A.
#31	H417D	O	R/W	Communication address	RS-485 communication address, range set: 01~255, factory default value: K1
#32	H417E	O	R/W	Baud Rate Setting	Baud rate setting: 4800,9600,19200bps,38400 bps,57600 bps, 115200 bps. ASCII mode data format is always 7Bit, even bit, and 1 stop bit (7 E 1). RTU mode data format is always 8Bit, even bit , and 1 stop bit ( 8 E 1) b0: 4800 bps(bit/sec.), b1: 9600 bps(bit/sec.) (default value) b2: 19200 bps(bit/sec.), b3: 38400 bps(bit/sec.) b4: 57600 bps(bit/sec.), b5: 115200 bps(bit/sec.) b6~b14: reserved, b15: ASCII / RTU mode switch

- CR#0~CR#34: The corresponding addresses are H 415E-H 4180 for user to read/write by using RS-485.
- Baud rate could be 4800, 9600, 19200, 38400 and 57600bps.
  - Communication protocol can be Modbus ASCII mode and RTU mode. For ASCII mode, data format is 7Bits, even, 1 stop bit (7 E 1). For RTU mode, data format is 8Bits, even, 1 stop bit (8 E 1).
  - Function code: 03H: read register data. 06H: write one WORD data into register. 10H: write multiple WORDs into register.

### 5 TRIAL RUN & TROUBLESHOOTING

- MPU connects to HC extension module
- Make sure that the power of MPU and extension unit is OFF before wiring.
  - Open extension port of EH MPU and connect to HC extension unit with cable. There is no connection order for EH MPU to connect extension unit, mix connection is allowed.
  - The power supply of HC extension unit must be external +24VDC power supply.
  - Before power up, check if the load circuit of output points YH0 and YH1 is correct, especially the circuit between YH0+, YH0- and YH1+, YH1-. There is a Zener Diode that is connected between YH0+, YH0- and YH1+, YH1- in HC. If the positive/negative pole is wrong, it may cause unexpected result.

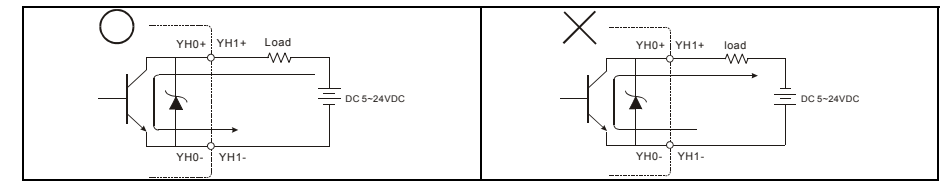

- Before power up, check if A phase or B phase connects to correct voltage level. (there are three voltage level: +24, +12V and +5V) If +24V signal connects to +5V input terminal, it may damage internal circuit.
- After power up MPU, it will start to detect extension module. If no external +24VDC power is applied to HC at this time or power is applied after EH MPU completing detecting extension module, the connection will fail. Therefore, power wiring and power supply timing should be as following.

**Power wiring**

**Power supply timing**

**Timing analysis**

- When power supply for HC is +24V\_INT:  $t5 > t3$ , power is ON and the connection of HC extension unit is normal.
- When power supply for HC is +24V\_EXT: Because start time (t2) of external power supply for HC extension module is unknown, user must make sure that  $t2+t4 < t1+t5$ , otherwise HC extension module cannot be detected by MPU.

- The maximum special extension modules number for EH MPU connects is 8 special extension modules. After power is ON, EH will save module codes of connected special modules in D1320~D1327 in order. The module code of 01HC is H'0120. It indicates communication is OK when H'0120 is displayed in the corresponding special D register by using HPP02 or other monitor software.

### 6 Troubleshooting

Judge the errors by the indicators on the front panel. When errors occurred on DVP PLC, please check:

#### POWER LED

The "POWER" LED at the front of HC extension module will be lit (in green) if the power is on. If the indicator is not on when power up, please remove the wiring on terminals +24V. Once the indicator lights after this, it means that the 24V DC power supply of the PLC is overloaded. Please do not use the DC power supply from the +24V terminals, but use a DC24V power supply instead.

#### L.V. LED

The "L.V." LED at the front of HC extension module will be lit if input voltage is not enough. The extension module won't active at this time.

### 6 RELATIVE INSTRUCTIONS

API	D	FROM	P	(m1) (m2) (D) (n)	Read Special Module CR Data
-----	---	------	---	-------------------	-----------------------------

Instruction Explanation: (m1): number of special module (m1=0~7). (m2): CR number of special module that will be read. (D): address for saving reading data. (n): data number for reading once.

Program Example: Writing special module #0 of CR#24 into D0 and special module #0 of CR#25 into D1. only write two data once (n=2).

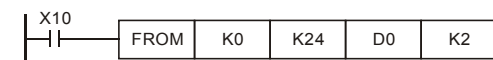

API	D	TO	P	(m1) (m2) (S) (n)	Special Module CR Data Write In
-----	---	----	---	-------------------	---------------------------------

Instruction Explanation: (m1): number of special module (m1=0~7). (m2): CR number of special module that will be wrote in. (S): data to write in CR. (n): data number to write in once.

Program Example: Using 32-bit instruction DTO to write D11 and D10 into special module#0 of CR#3 and CR#2. only write a data once (n=1).

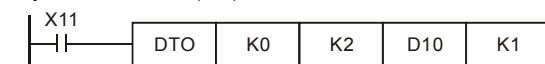

## Free Manuals Download Website

<http://myh66.com>

<http://usermanuals.us>

<http://www.somanuals.com>

<http://www.4manuals.cc>

<http://www.manual-lib.com>

<http://www.404manual.com>

<http://www.luxmanual.com>

<http://aubethermostatmanual.com>

Golf course search by state

<http://golfingnear.com>

Email search by domain

<http://emailbydomain.com>

Auto manuals search

<http://auto.somanuals.com>

TV manuals search

<http://tv.somanuals.com>