

Instruction Sheet

Thank you very much for purchasing DELTA CTA series. Please read this instruction sheet before using your CTA series to ensure proper operation and please keep this instruction sheet handy for quick reference.



- > **DANGER! Caution! Electric Shock!**
- > When the power is on, DO NOT touch the AC terminals in case an electric shock may occur.
- > Make sure the power is disconnected when you check the unit inside.



- > CTA series is an OPEN-TYPE device. They are intended for installation completely within an overall panel and are for use in counting or timing application. If it will cause serious injury to workers or damage on other equipments when used in a dangerous environment, please make sure it is installed in an automatic safety protection device.

1. Precaution

- Always use recommended solder-less terminals: Fork terminal with isolation (M3 screw, width 7.0mm), hole (diameter 3.2mm). Screw size: M3x6.5 (with 6.8x6.8 square washer). Recommended tightening torque: 0.4 N.m (4kgf.cm). Applicable wire: solid/twisted wire of 2mm², 12AWG to 24AWG. Please be sure to tighten them properly.
- Prevent dust or metallic debris from falling into the device and cause malfunctions.
- DO NOT modify or uninstall the device.
- DO NOT use empty terminals.
- Make sure the wires are correctly connected to proper terminals.
- Keep away from high-voltage and high-frequency environment during installation in case of interference.
- Prevent using the device in premises which contain:
 - Dust or corrosive gas
 - High humidity
 - High radiation
 - Vibration and shock
- CTA series is an open-type device. Make sure to install it in an enclosure to prevent dust, humidity in case of an electric shock.
- Please make sure the power cables and signal device are installed correctly before switching on the power; otherwise serious damage may occur.
- DO NOT touch the terminals or repair the device when the power is on; otherwise an electric shock may occur.
- Please wait for one minute after the power is switched off to allow the capacitor to discharge and DO NOT touch the internal wiring within this period.
- Use dry cloth to clean the device. DO NOT use acid or alkaline liquid to clean the device.

2. Display, Indicators and Keys

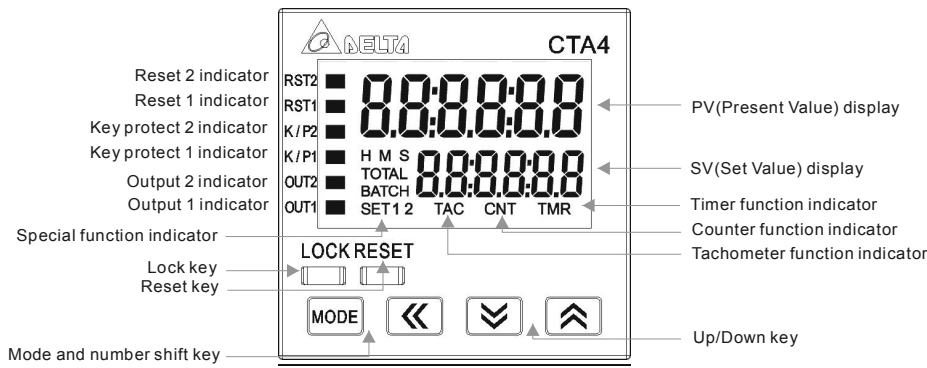

❖ LCD Display and indicators

RST 1/2	Light on when reset signal is detected	BATCH	"Batch Counting Mode" in Counter and Tachometer function
K/P 1/2	Light on when key-protected mode is enabled	SET 1 2	SV1, SV2 display
OUT 1/2	Light on when output is executing	TAC	Light on when Tachometer function is executing
H M S	Hour, minute, second, unit of timer, displayed in Timer function	CNT	Light on when Counter function is executing
TOTAL	"Total Counting Mode" in Counter and Tachometer function	TMR	Light on when Timer function is executing

❖ Key Operation

- ▲/▼** Increase and decrease SV or change parameter settings.
- ←** Left move 1 digit of the selected digit. The indicator of the selected digit will flash.
- ↵** Save the set parameters or switch among functions.
- LOCK** Prevent settings from being changed. Key-protected mode still works after the power is switched off. Press **LOCK** to enter key-protected mode. In non-key-protected status, press **LOCK** to enter Lock 1. In Lock 1, press **LOCK** again to enter Lock 2. Press **MODE** and **←** at the same time to disable key-protected mode. **LOCK** (Lock 1) disables the functions of all keys. **LOCK** (Lock 2) allows users to change SV and functions of **RESET** remain. **LOCK** only functions in non-key-protected status.
- RESET** Clear and reset PV.

❖ Modes: Operation Mode and Configuration Mode

- Operation** When the power is on, the timer/counter/tachometer is in the operation mode. Press **▲/▼** to change SV, or **←** to make change on a desired digit. The indicator of the selected digit will flash. After the change is made, press **↵** to save the setting. If SV or parameters are not changed, press **MODE** once to switch between SET1 and SET2.
- Configuration** Press **MODE** in operation mode for more than 3 seconds to enter configuration mode. Press **MODE** once to switch among parameters. To return to operation mode, press **MODE** for more than 3 seconds.

3. Ordering Information



Product name	CTA: Delta Counter/Timer/Tachometer A series	Preset stage	0: 2 preset stage
Panel size	4: 48mm x 48mm 1/16DIN	Communication	0: none
Output 2	0: NPN; 1: Relay	Power supply	A: AC 100~240V

4. Specification

Power input	AC 100~240V, 50/60Hz
Input voltage range	85% to 110%, rated voltage
Power consumption	Less than 10VA
External power supply	12Vdc ±10%, 100mA
Display	Double-line, 6-digit negative transmissive LCD display
Input signal	Non-voltage input (NPN): ON impedance 1K ohm max. ON residual voltage: 2V max. Voltage input (PNP): High level: 4.5 to 30Vdc, Low level: 0 to 2Vdc
Output 1	Relay: SPST max.250Vac, 5A (resistance load) Transistor: NPN open collector. When 100mA /30Vdc, residual voltage=1.5Vdc max.
Output 2	Relay: SPDT max.250Vac, 5A (resistance load) Transistor: NPN open collector. When 100mA /30Vdc, residual voltage=1.5Vdc max.
Dielectric strength	2000Vac 50/60 Hz for 1 minute
Vibration resistance	Without damage: 10~55Hz, amplitude=0.75mm, 3 axes for 2 hours
Shock resistance	Without damage: drop 4 times, 300m/s ² , 3 edges, 6 surfaces and 1 corner
Ambient temperature	0 °C to +50 °C
Storage temperature	-20 °C to +65 °C
Altitude	2000m or less
Ambient humidity	35% to 85% RH (non-condensing)
Pollution degree	Degree 2

5. Parameters in Configuration Mode

❖ Timer

FUNCT	↑/↓	←/→	↵	MODE	MODE	MODE	MODE	MODE	MODE	MODE	MODE
Select a function	Setup Timer function, (counting up or down)	Select output mode of Timer	Setup the displayed unit of timer	Setup the pulse width of output 1	Reset min. pulse width	Select input type (PNP or NPN)	Back to "select a function"				

❖ Counter

FUNCT	↑/↓	←/→	↵	MODE	MODE	MODE	MODE	MODE	MODE	MODE	MODE
Select a function	Select counting modes	Setup input mode of Counter	Setup output mode of Counter (not dual output)	Setup dual output counting mode (dual output)	Setup counting speed	Setup the pulse width of output 1	Back to "select a function"				

❖ Tachometer

FUNCT	↑/↓	←/→	↵	MODE	MODE	MODE	MODE	MODE	MODE	MODE	MODE
Select a function	Setup output mode of Tachometer	Setup counting speed	Setup the decimal point	Setup pre-scale value	Reset min. pulse width	Setup the average of input data	Setup the delay time while switching on power	Back to "select a function"			

❖ Timer + Counter Mixed

FUNCT	↑/↓	←/→	↵	MODE	MODE	MODE	MODE	MODE	MODE	MODE	MODE
Select a function	Setup Timer function, (counting up or down)	Setup output mode of timer	Setup the displayed unit of timer	Setup input mode of Counter	Setup output mode of Counter (not dual output)	Setup counting speed	Setup the pulse width of output 1	Back to "select a function"			

6. Timer Function

There are counting up/down modes, several counting units and output modes to choose from in timer function.

↑/↓	Select counting up UP or counting down DOWN
←/→	Setup the output time of timer, from 0 to 99.99 secs. 0= Hold output
↵	Setup output modes

MODE Setup the counting unit of the timer.

5 00 : sec	0.01~9999.99	A unit = 10ms.	Max. counting = 9999.99 secs.
5 0 : sec	0.1~99999.9	A unit = 0.1sec.	Max. counting = 99999.9 secs.
5 : sec	1~999999	A unit = 1 sec.	Max. counting = 999999 secs.
5 0 : min,sec	0.01~9959.99	A unit = 0.01 sec.	Max. counting = 5999.99 secs.
5 0 : min,sec	0.1~99959.9	A unit = 0.1 sec.	Max. counting = 59999.9 secs.
5 : min	0.1~99999.9	A unit = 0.1 min.	Max. counting = 99999.9 mins.
5 : min	1~999999	A unit = 1 min.	Max. counting = 999999 mins.
5 : hr,min,sec	1~995959	A unit = 1 sec.	Max. counting = 359999 secs (100hr)
5 : hr,min	1~999959	A unit = 1 min.	Max. counting = 35999999 secs (10000hr)
5 : hr	1~999999	A unit = 1 hr.	Max. counting = 999999 hrs

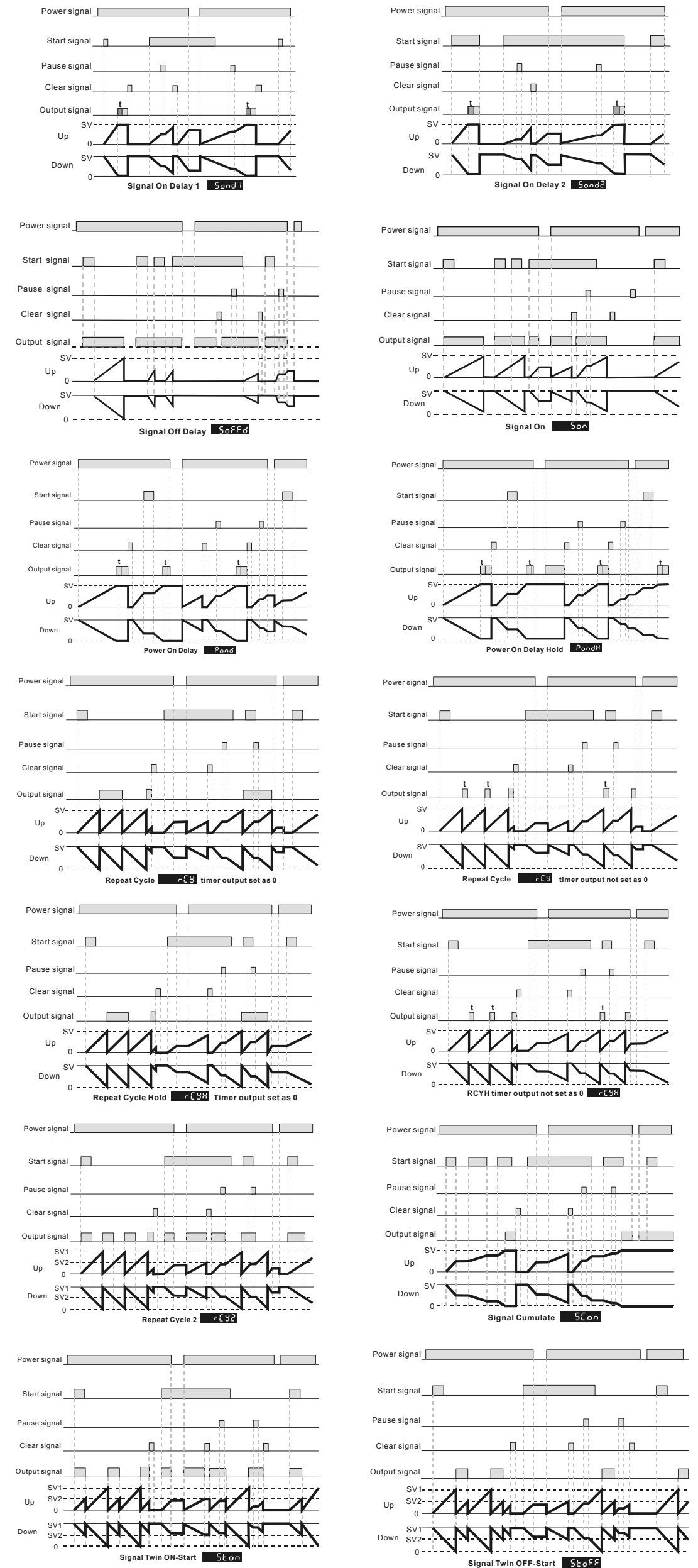

7. Counter Function

Counter functions include 1-stage counting, 2-stage counting, batch counting, total counting and dual counting.

5E R5 E 1	1-stage	Only 1 SV is allowed. See "output modes of counter".
5E R5 E 2	2-stage	2 SVs, 2 PVs are allowed. See "output modes of counter".
b R E C H	Batch	Apart from the counting of PV and SV, when PV=SV, the batch counting adds 1 and clear PV as 0 for recounting till the batch counting equals batch SV.
t o t a l	Total	Total counting adds up all the counting values till they reach SV for output.
d u a l	Dual	CP1 and CP2 can be independent counters, but the counting speed can only reach 5kHz. CP1 and CP2 can execute addition Rdd or subtraction SuB .

Input modes of counter C u n P t			
U P	Counting up	U d b	Individual
d o w n	Counting down	U d c	Quadrature
U d R	Command		

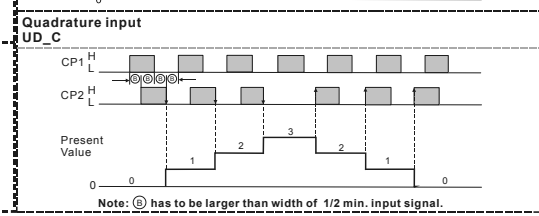
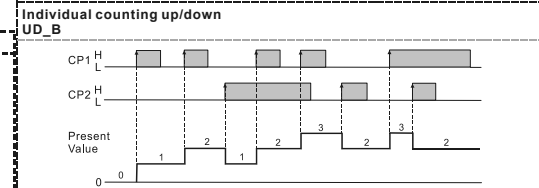
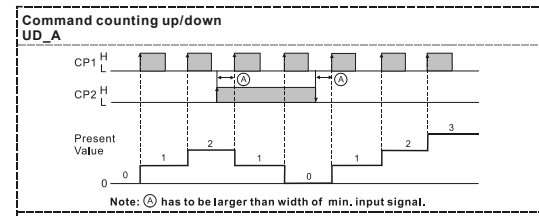

Counting up

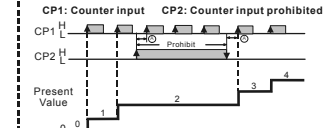

Counting down

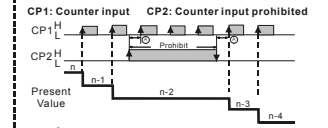

Output modes of counter **C o u t**

The output of SV can be 1-stage or 2-stage. When the output is set as 1-stage, Output 2 will be the same as the Output 1. The output modes include: F, N, C, R, K, P, Q, A, S, T, D

F	F	When PV reaches SV, output is enabled but counting continues. Recounting starts after reset signal is over. Output 2 remains.
n	N	When PV reaches SV, output is enabled but counting stops. Recounting starts after reset signal is over. Output 2 remains.
c	C	When PV reaches SV, recounting executes automatically. Output 2 is pulse output. Output 1 remains till Output 2 is over.
r	R	When PV reaches SV, counting stops till Output 2 (pulse) is over for recounting. Output 1 remains till Output 2 is over.
k	K	When PV reaches SV, output is enabled but counting continues. Recounting starts after reset signal is over.
p	P	When PV reaches SV, output is enabled and recounting is automatically executed. But display of counting remains till Output 2 (pulse) is over.
q	Q	When PV reaches SV, output is enabled but the counting continues. Recounting starts after Output 2 (pulse) is over.
A	A	When PV reaches SV, output is enabled but the counting stops. Recounting starts and Output 2 (pulse) executes after reset signal is over.
S	S	When PV ≥ SV1, Output 1 is enabled. When PV ≥ SV2, Output 2 is enabled
T	T	When PV ≤ SV1, Output 1 is enabled. When PV ≥ SV2, Output 2 is enabled.
D	D	When SV=PV, output is enabled but counting continues. Addition and subtraction modes are valid.

The time of Output 1 and Output 2 (pulse) can be setup separately, ranging from 0.01 to 99.99 secs. Recounting refers to counting up or addition/subtraction counting starting from 0 and counting down starting from SV. The counting range: -99999~99999. The counting will restart from 0 if the counting exceeds the range.

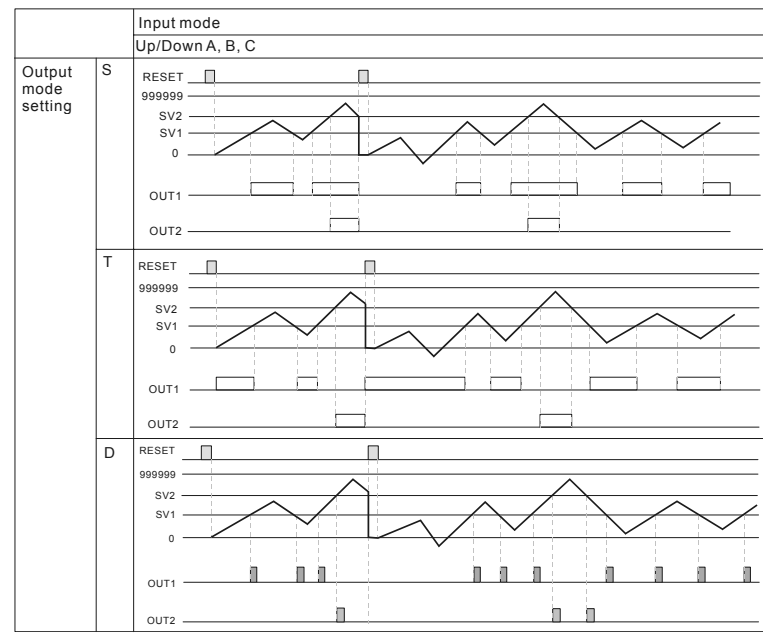
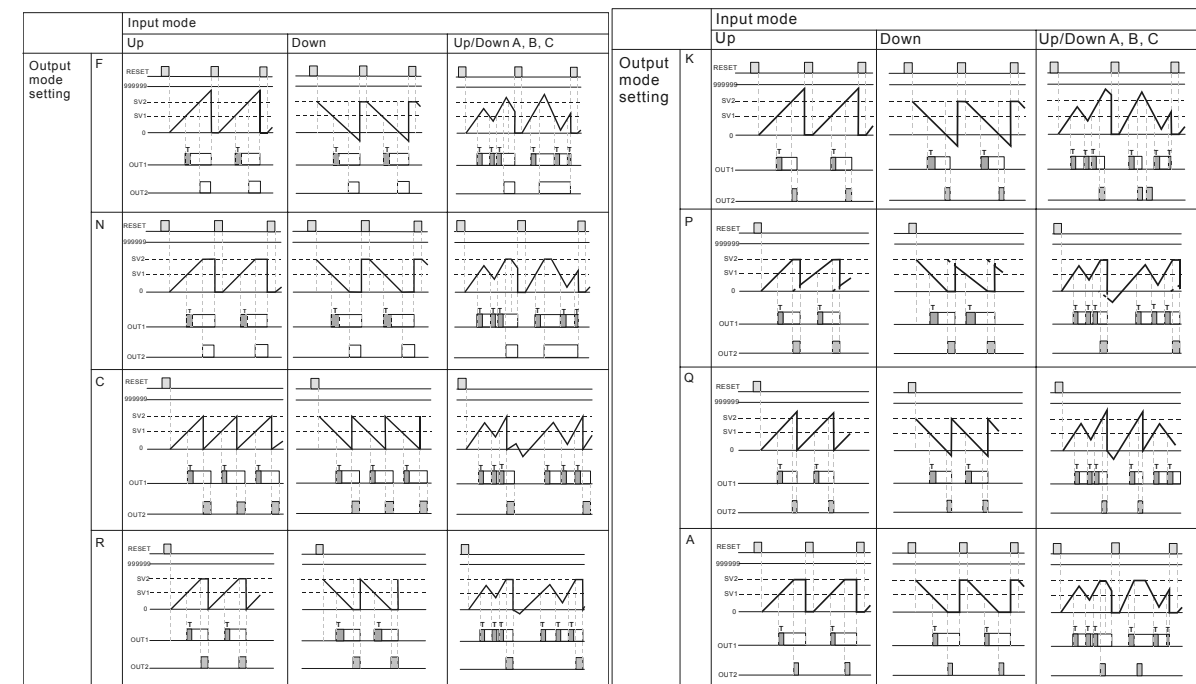

Save the data before power off **P o w e r S**. When **S R o S** is set, the current PV will be saved. When **C L E A R** is displayed, the PV will be cleared.

Pre-scale function **P r e S c a l e**: When conducting unit conversion, PV = PV x PreScale value, ranging from 0.001 to 99.999.

8. Tachometer Function

Measuring Rotation speed: Measuring pulse width and determining current frequency

Output methods: Lo-Lo, Lo-Hi, Hi-Lo, Hi-Hi

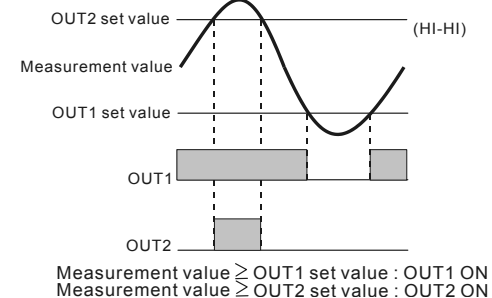
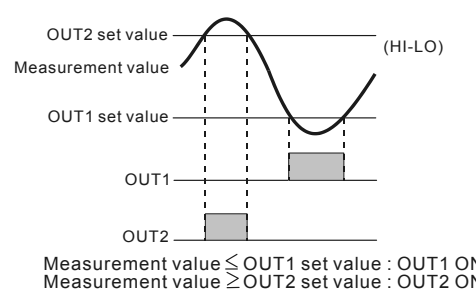
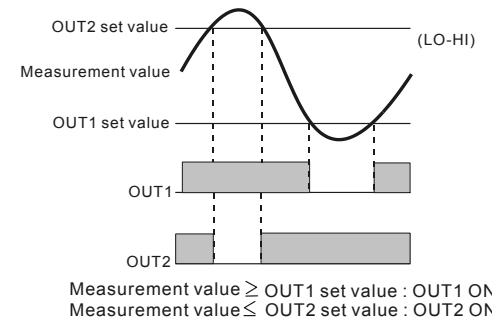
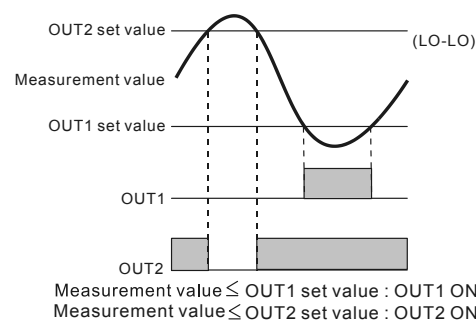

Delay time after switching on the power **S e t D e l**: The tachometer will start to run when the set delay time is due after the power is switched on. (Range of delay time: 0.1~99.9 secs.)

Setup average value of input filter **S e t R a v**: Range for obtaining average (n = 0 ~ 3). This parameter obtains the average of 2ⁿ input data for more stable output value.

9. Timer + Counter Mixed Function

In Timer + Counter function, SV1, PV1 and Output 1 are for Timer; SV2, PV2 and Output2 are for Counter. DIP switch is disabled. All timer and counter functions remain except

- RCY2, SCON, STON, STOFF in output mode of Timer function
- Command up/down, Individual up/down, quadrature counting in input mode, S, T, D in output mode of Counter function

Only 1-stage counting in Counter function is available.

10. Easy DIP Switch Setup

Users can use DIP switch to setup parameters. When DIP is switched to ON, the corresponding parameters can only be read, not changed.

SW	Counter	Timer	Tachometer
8	Reset pulse width ON: 1ms, OFF: 20ms	Reset pulse width ON: 1ms, OFF: 20ms	Reset pulse width ON: 1ms, OFF: 20ms
7	Input type ON: PNP OFF: NPN	Unit of Timer See Table 1	Input type ON: PNP OFF: NPN
6	N/A	Unit of Timer See Table 1	N/A
5	Counting speed ON: 10K CPS OFF: 30 CPS	Unit of Timer See Table 1	Counting speed ON: 10KHz OFF: 30Hz
4	Output mode of counter See Table 2	Output mode of Timer See Table 2	Output mode of Tachometer See Table 2
3	Output mode of counter See Table 2	Output mode of Timer See Table 2	Output mode of Tachometer See Table 2
2	Input mode of counter ON: counting down OFF: counting up	Time counting up/down ON: down OFF: up	N/A
1	ON: Enable DIP OFF: Disable DIP	ON: Enable DIP OFF: Disable DIP	ON: Enable DIP OFF: Disable DIP

SW5	SW6	SW7	Displayed unit
OFF	OFF	OFF	0.01 sec
ON	OFF	OFF	0.1 sec
OFF	ON	OFF	1 sec
ON	ON	OFF	min, 0.01 sec
OFF	OFF	ON	min, 0.1 sec
ON	OFF	ON	0.1 min
OFF	ON	ON	Min
ON	ON	ON	hr, min, sec

		Table 2 Output Mode Configuration		
SW3	SW4	Counter	Timer	Tachometer
OFF	OFF	F	Signal ON Delay 1	Lo-Lo
ON	OFF	N	Signal ON Delay 2	Lo-Hi
OFF	ON	C	Signal OFF Delay	Hi-Lo
ON	ON	R	Signal ON	Hi-Hi

Table 1

11. Terminal Definition

CTA4 series

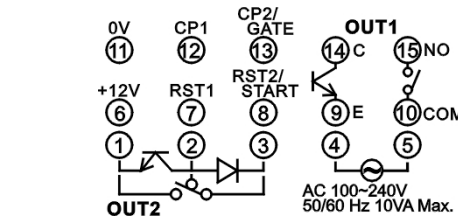

Input connections

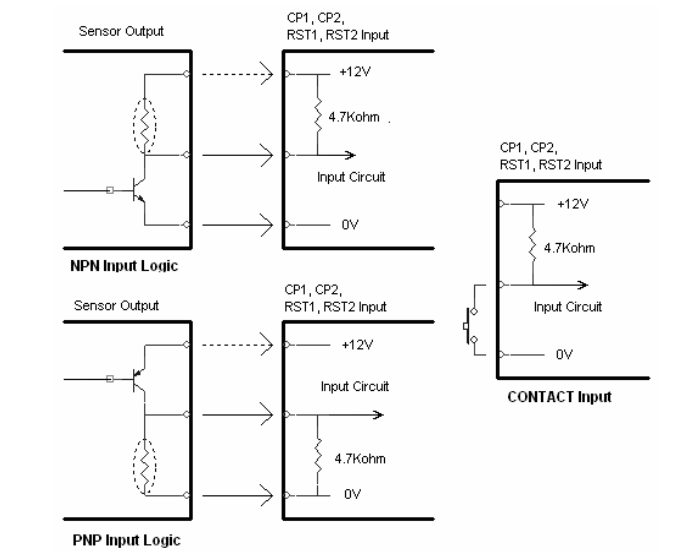

Multi-function input pin

Counter	Timer	Tachometer	Timer + Counter
CP1		CP1	CP1
CP2	Gate		Gate
Reset1	Reset1	Reset1	Reset1
Reset2	Start		Start

12. Dimension & Panel Cutout

CTA4 series

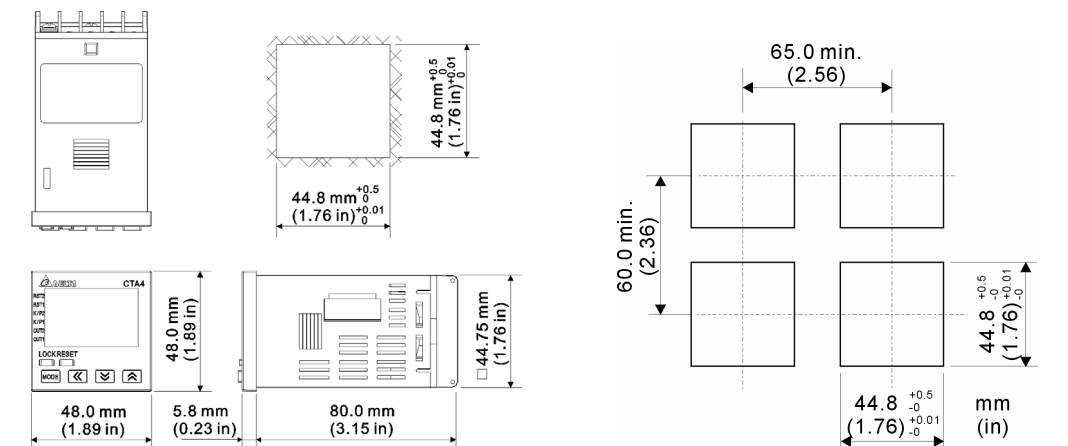

13. How to Mount

- Step-1.** Insert the controller through the panel cutout.
- Step-2.** Insert the mounting bracket into the mounting groove at the top and bottom of the controller and push the mounting bracket forward until the bracket stops at panel wall.
- Step-3.** Insert and tighten screws on bracket to secure the controller in place.

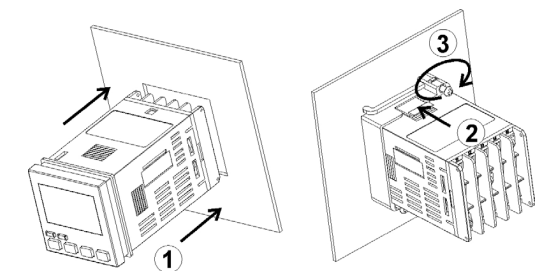

Delta Electronics, Inc. 31-1 Shien Pan Road, Kuei Shan Industrial Park, Taoyuan Shien 33341, Taiwan, R.O.C.
TEL: +886-3-362-6301
FAX: +886-3-362-7267

The content of this instruction sheet may be revised without prior notice. Please consult our distributors or download the most updated version at <http://www.delta.com.tw/industry/automation>

Free Manuals Download Website

<http://myh66.com>

<http://usermanuals.us>

<http://www.somanuals.com>

<http://www.4manuals.cc>

<http://www.manual-lib.com>

<http://www.404manual.com>

<http://www.luxmanual.com>

<http://aubethermostatmanual.com>

Golf course search by state

<http://golfingnear.com>

Email search by domain

<http://emailbydomain.com>

Auto manuals search

<http://auto.somanuals.com>

TV manuals search

<http://tv.somanuals.com>