



DVPEN01-SL

Ethernet Communication Module

Operation Manual



<http://www.delta.com.tw/industrialautomation>

DVP-0204320-02



Warning

- ✓ Please read this instruction carefully before use and follow this instruction to operate the device in order to prevent damages on the device or injuries to staff.
- ✓ Switch off the power before wiring.
- ✓ RTU-DNET is an OPEN TYPE device and therefore should be installed in an enclosure free of airborne dust, humidity, electric shock and vibration. The enclosure should prevent non-maintenance staff from operating the device (e.g. key or specific tools are required for operating the enclosure) in case danger and damage on the device may occur.
- ✓ RTU-DNET is to be used for controlling the operating machine and equipment. In order not to damage it, only qualified professional staff familiar with the structure and operation of RTU-DNET can install, operate, wire and maintain it.
- ✓ DO NOT connect input AC power supply to any of the I/O terminals; otherwise serious damage may occur. Check all the wirings again before switching on the power and DO NOT touch any terminal when the power is switched on. Make sure the ground terminal Ⓢ is correctly grounded in order to prevent electromagnetic interference.



Table of Contents

1	INTRODUCTION.....	3
1.1	Functions.....	3
1.2	Specifications	3
2	PRODUCT PROFILE & OUTLINE	4
2.1	Dimension	4
2.2	Product Profiles	4
2.3	LED Indicators.....	5
2.4	RJ-45 PIN Definition.....	5
3	INSTALLATION & WIRING	5
3.1	Installation	5
4	CONTROL REGISTER (CR)	6
4.1	Control Registers in DVPEN01-SL.....	6
4.2	Explanations on CR	8
4.3	Numbering of Left-Side Modules.....	13
5	SETTING UP SOFTWARE	14
5.1	Setting up Communication & Searching for Modules.....	14
5.2	Basic Settings	20
5.3	Network Settings	21
5.4	Setting up E-Mails	24
5.5	Data Exchange.....	25
5.6	RTU	26
5.7	IP Filter.....	27
5.8	Static ARP Table.....	27
5.9	Setting up Password	28

5.10	Returning to Default Setting	29
6	APPLICATION EXAMPLES.....	30
6.1	Setting up IP and Communicating through WPLSoft.....	30
6.2	Connecting the PC with DVPEN01-SL through LAN	33
6.3	Setting up Password and Clearing Password	37
6.4	When the Password is Lost (Returning to Default Setting by RS-232).....	39
6.5	IP Filter Protection	40
6.6	Setting up Static ARP Table	42
6.7	Application of E-Mail	44
6.8	Application of Data Exchange (1)	45
6.9	Application of Data Exchange (2)	48
6.10	Application of Data Exchange (3)	49
6.11	Application of Data Exchange (4)	50
6.12	Application of Data Exchange (5)	52
6.13	Application of Modbus TCP Master	53
6.14	RTU Mapping.....	54

1 Introduction

Thank you for choosing DVPEN01-SL module. To correctly install and operate DVPEN01-SL, please read the manual carefully before using the module.

DVPEN01-SL is an Ethernet communication module for remote setting and communication through WPLSoft. DVPEN01-SL is able to send E-mails, automatically correct the RTC in DVP28SV11R/T and exchange data. It supports Modbus TCP communication protocol and can conduct remote monitoring by using SCADA (Supervisor Control and Data Acquisition) software or HMI (Human Machine Interfaces). DVPEN01-SL can be the master of Modbus TCP, sending out Modbus TCP instructions and controlling the peripheral equipment. In addition, under MDI/MDI-X auto-detection, it does not need to use a crossing cable. See the contents below for more detailed instructions on DVPEN01-SL module.

1.1 Functions

- Auto-detects 10/100Mbps transmission speed
- MDI/MDI-X auto-detection
- Supports Modbus TCP protocol (at the same time supports Master and Slave mode)
- Able to send out E-mails
- Auto-corrects the RTC in PLC through the Internet time correction function
- Supports point-to-point data exchange (Max. data exchange length: 200 bytes)

1.2 Specifications

■ Internet interface

Item	Specification
Interface	RJ-45 with Auto MDI/MDIX
Number of ports	1 Port
Transmission method	IEEE802.3, IEEE802.3u
Transmission cable	Category 5e
Transmission speed	10/100 Mbps Auto-Detect
Network protocol	ICMP, IP, TCP, UDP, DHCP, SMTP, NTP, Modbus TCP

■ Serial communication interface

Item	Specification
Interface	RS-232
Number of ports	1 Port
Transmission cable	DVPACAB230, DVPACAB215, DVPACAB2A30, DVPACAB2B10

■ Environment

Item	Specification
Noise immunity	ESD (IEC 61131-2, IEC 61000-4-2): 8KV Air Discharge EFT (IEC 61131-2, IEC 61000-4-4): Power Line: 2KV Analog & Communication I/O: 1KV Damped-Oscillatory Wave: Power Line: 1KV RS (IEC 61131-2, IEC 61000-4-3): 26MHz ~ 1GHz, 10V/m
Environment	Operation: 0°C ~ 55°C (temperature), 50 ~ 95% (humidity), Pollution degree 2;

Item	Specification
	Storage: -25°C ~ 70°C (temperature), 5 ~ 95% (humidity)
Vibration/ Shock Resistance	Standard: IEC61131-2, IEC 68-2-6 (TEST Fc)/IEC61131-2 & IEC 68-2-27 (TEST Ea)

■ Electrical specifications

Item	Specification
Power supply voltage	24VDC (-15% ~ 20%) (Power is supplied by the internal bus of MPU.)
Power consumption	1.5W
Insulation voltage	500V
Weight (g)	92 (g)

2 Product Profile & Outline

2.1 Dimension

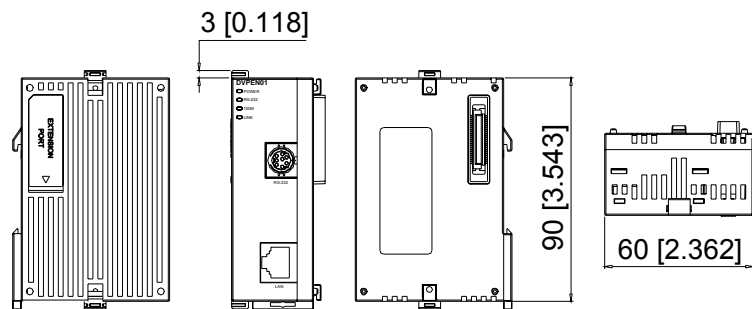

Unit: mm [inches]

2.2 Product Profiles

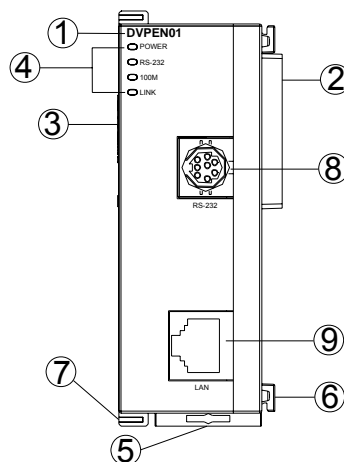

1. Model name	6. Fixing tenon for I/O module
2. Extension port to connect device	7. Fixing clip for I/O module
3. Extension port to connect I/O module	8. RS-232 connection port
4. POWER, LINK, RS-232, 100M indicators	9. Ethernet RJ-485 connection port
5. DIN rail clip	

2.3 LED Indicators

Indicator	Color	Indication
POWER	Green	Power indication
RS-232	Red	Communication status of the series port
100M	Orange	Network connection status
LINK	Green	Network communication speed

2.4 RJ-45 PIN Definition

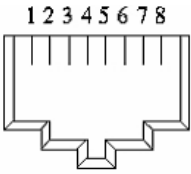
RJ-45 sketch	Terminal No.	Definition	Explanation
	1	Tx+	Positive pole for data transmission
	2	Tx-	Negative pole for data transmission
	3	Rx+	Positive pole for data receiving
	6	Rx-	Negative pole for data receiving
	4, 5, 7, 8	-	N/C

3 Installation & Wiring

This section gives instructions on how to connect DVPEN01-SL with PLC MPU and how to connect DVPEN01-SL to the network.

3.1 Installation

Connect PLC MPU to DVPEN01-SL

- Adjust the I/O module clip on the left side of the MPU.
- Meet the I/O module port of the MPU with DVPEN01-SL as shown in the figure below.
- Fasten the I/O module clip on the left side of the MPU.

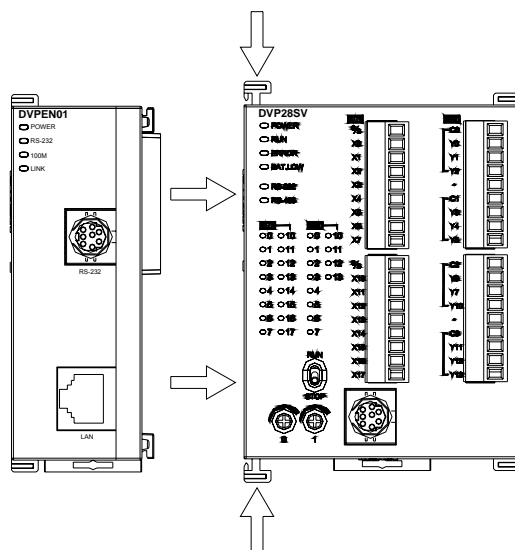

Connect DVPEN01-SL to other I/O modules

- To connect DVPEN01-SL with the other I/O module, lift the extension clip of the I/O module by a screwdriver and open the side cover.

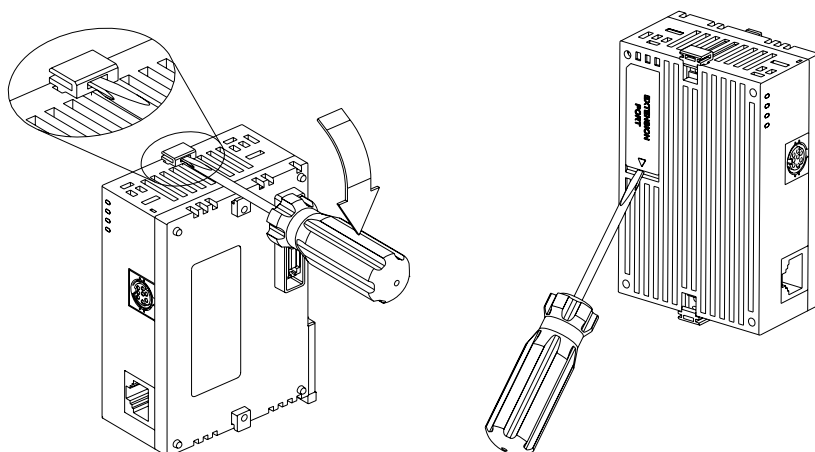

Connect DVPEN01-SL to the Network:

Connect DVPEN01-SL to the Ethernet Hub by twisted pair cable CAT-5e. DVPEN01-SL has Auto MDI/MDIX function; therefore, DVPEN01-SL does not need to use a crossing cable between the PC and DVPEN01-SL.

Network connections between the PC and DVPEN01-SL:

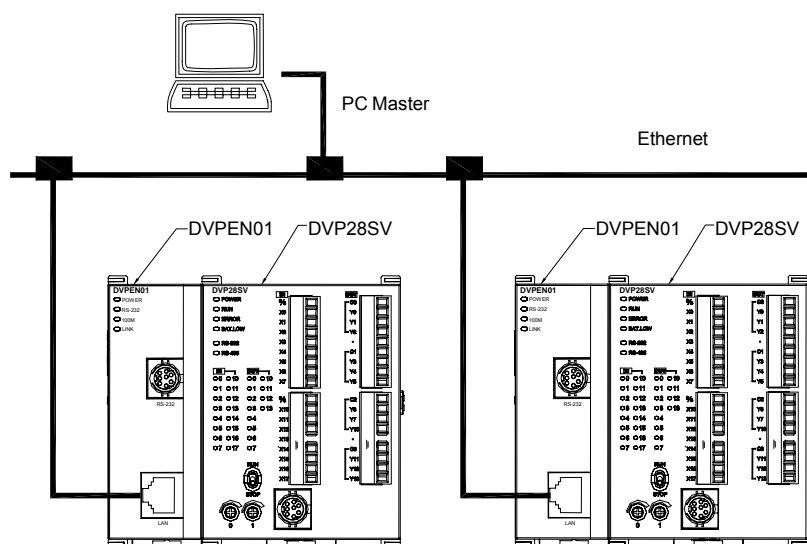

4 Control Register (CR)

4.1 Control Registers in DVPEN01-SL

CR#		Attribute	Content	Explanation
HW	LW			
	#0	R	Model name	Set up by the system; read only. Model code of DVPEN01-SL = H'4050
	#1	R	Firmware version	Displaying the current firmware version in hex.
	#2	R	Communication mode	b0: Modbus TCP mode; b1: data exchange mode
	#3	W	E-Mail Event 1 trigger	Set up whether to send E-Mail 1
	#4	W	E-Mail Event 2 trigger	Set up whether to send E-Mail 2
	#5	W	E-Mail Event 3 trigger	Set up whether to send E-Mail 3
	#6	W	E-Mail Event 4 trigger	Set up whether to send E-Mail 4

CR#		Attribute	Content	Explanation
HW	LW			
	#7	R	Status of E-Mail 1, 2	b0 ~ b7: Current status of E-Mail 2 b8 ~ b15: Current status of E-Mail 1
	#8	R	Status of E-Mail 3, 4	b0 ~ b7: Current status of E-Mail 4 b8 ~ b15: Current status of E-Mail 3
	#9	R/W	E-Mail 1 additional message	Filled in by the user, and it will be send by E-mail.
	#10	R/W	E-Mail 2 additional message	Filled in by the user, and it will be send by E-mail.
	#11	R/W	E-Mail 3 additional message	Filled in by the user, and it will be send by E-mail.
	#12	R/W	E-Mail 4 additional message	Filled in by the user, and it will be send by E-mail.
	#13	R/W	Data exchange trigger	Set up whether to send out data in data exchange mode
	#14	R	Status of data exchange	Displaying current status of data exchange.
	#15	RW	Enabling flag for RTU mapping	1: Enable; 0: Disable. Default = 0
	#16	RW	Connection status of RTU mapping slave	b0: Status of RTU slave 1 b1: Status of RTU slave 2 b2: Status of RTU slave 3 b3: Status of RTU slave 4
#24 ~ #17		-	Reserved	
#26	#25	R/W	Destination IP	Destination IP address for data exchange
	#27	-	Reserved	
	#28	R/W	Destination Slave ID	Destination Slave ID for data exchange
#48 ~ #29		R/W	Data transmission buffer	Buffer for transmitted data in data exchange
#68 ~ #49		R	Data receiving buffer	Buffer for received data in data exchange
#80 ~ #69		-	Reserved	
	#81	R/W	Read address for data exchange	Slave transmission buffer address for data exchange
	#82	R/W	Read length for data exchange	Number of registers for read data
	#83	R/W	Received address for data exchange	Buffer address for the receiving Master in data exchange
	#84	R/W	Written-in address for data exchange	Buffer address for the receiving Slave in data exchange
	#85	R/W	Written-in length for data exchange	Number of registers for data transmission
	#86	R/W	Transmission address for data exchange	Master transmission buffer address for data exchange
#110 ~ #87		-	Reserved	
	#111	R/W	8-bit processing mode	Setting up Modbus TCP Master control as 8-bit mode
	#112	R/W	Modbus TCP Keep-Alive Time-out	Modbus TCP Keep-Alive Time-out (s)
	#113	-	Reserved	
	#114	R/W	Modbus TCP time-out	Setting up Modbus TCP time-out (in ms)

CR#		Attribute	Content	Explanation
HW	LW			
	#115	R/W	Modbus TCP trigger	Setting up whether to send out data in Modbus TCP mode
	#116	R/W	Modbus TCP status	Displaying current status of Modbus TCP mode
#118	#117	R/W	Modbus TCP destination IP	Setting up destination IP address for Modbus TCP transaction
	#119	R/W	Modbus TCP data length	Setting up the data length for Modbus TCP transaction
#219 ~ #120		R/W	Modbus TCP data buffer	Data buffer of Modbus TCP for storing sending/receiving data
#248 ~ #220		-	Reserved	
	#251	R	Error code	Displaying the errors. See table of error codes in the following section for more information.
#255 ~ #252		-	Reserved	

Symbols "R" refers to "able to read data by FROM instruction"; "W" refers to "able to write data by TO instruction".

4.2 Explanations on CR

CR#0: Model Name

Explanations:

1. Model code of DVPEN01-SL = H'4050.
2. You can read the model code in the program to see if the I/O module exists.

CR#1: Firmware Version

Explanations:

The firmware version of DVPEN01-SL is displayed in hex, e.g. H'0100 indicates version V1.00.

CR#2: Communication Mode

Explanations:

Bit No.	Mode	"0"	"1"
b0	Modbus TCP	Disable	Enable
b1	Data exchange	Disable	Enable

■ E-mail Functions

CR#3 ~ 6: E-Mail Event 1 ~ 4 Trigger

Explanations:

When the CR is set as "1", E-mail sending will be enabled. After the sending is completed, the CR will automatically be reset as "0". Note: Please trigger by differential instructions.

CR#7 ~ 8: Status of E-Mail 1 ~ 4

Explanations:

1. CR#7_b0 ~ b7: current status of E-Mail 2; CR#7_b8 ~ b15: current status of E-Mail 1.
2. CR#8_b0 ~ b7: current status of E-Mail 4; CR#8_b8 ~ b15: current status of E-Mail 3.
3. Table of E-Mail status

CR value	E-Mail status
0	Not been sent
1	Being processed
2	E-Mail sending is successful
10	Fail to connect to SMTP-Server
11	Incorrect recipient E-Mail address
12	SMTP-Server communication error
13	Exceeding the max. number of TCP connection
3 ~ 9, 14 ~ 255	Reserved

CR#9 ~ 12: E-Mail 1 ~ 4 Additional Message

Explanations:

The user fills in the code, and the code will be stored in the title of the E-Mail and sent out with the E-Mail.

■ **Data Exchange**

CR#13: Data Exchange Trigger

Explanations:

When the CR is set as “0”, the data in data exchange area will not be transmitted. When the CR is set as “1”, the data in data exchange area will be transmitted.

- ▶ When the Execute Mode in the software is set to “Program Control” (See 5.5), set CR#13 to 2, and the data exchange will continue to execute. Set CR#13 to 0 to stop the data exchange.
- ▶ When the Execute Mode in the software is set to “Always Enable”, the data exchange will continue to execute whatever the setting in CR#13 is.

(Firmware V2.0 and later versions support continuous execution of data exchange.)

CR#14: Data Exchange Status

Explanations:

When the CR is set as “0”, the data have not yet been received. When the CR is set as “1”, the data exchange is in progress. When the CR is set as “2”, the data exchange is successful. When the CR is set as “3”, the data exchange fails.

CR value	Status
0	Data have not yet been received.
1	Data exchange is in progress.
2	Data exchange is successful.
3	Data exchange fails.

CR#25, 26: Destination IP

Explanations:

To set up the Slave IP address for data exchange manually, write "0" into CR#28 first before setting up the destination IP. For example, if the user wants to set the destination IP address to 192.168.0.2, write H'0002 to CR#25 and H'C0A8 to CR#26. (K192 = H'C0, K168 = H'A8, K0 = H'00, K2 = H'02).

CR#28: Destination Slave ID

Explanations:

When you set up the Slave ID (i.e. K1 ~ K255) for data exchange, DVPEN01-SL will automatically search for the corresponding IP address from the Slave IP list. For example, if the ID is set as "0", the value in CR#25 and #26 will be regarded as the destination IP.

CR#29 ~ 48: Data Transmission Buffer

Explanations:

Storing the data to be transmitted to the remote MPU.

CR#49 ~ 68: Data Receiving Buffer

Explanations:

Storing the data received from the remote MPU.

CR#81: Read Address for Data Exchange

Explanations:

Setting up manually the Modbus address of the register for Slave data exchange. Only register address is allowed (e.g. D0 = H'1000).

CR#82: Read Length for Data Exchange

Explanations:

The number of receiving registers (K1 ~ K100) in data exchange.

CR#83: Read Length for Data Exchange

Explanations:

Setting up the Modbus address of the register for Master data exchange.

CR#84: Written-in Address for Data Exchange

Explanations:

Setting up manually the Modbus address of the register for Slave data exchange.

CR#85: Written-in Address for Data Exchange

Explanations:

The number of transmission registers (K1 ~ K100) in data exchange.

CR#86: Transmission Address for Data Exchange

Explanations:

1. Setting up the Modbus address of the register for Master data exchange.
2. Example: Write H'1000 (D0) into CR#81, K1 into CR#82, and H'1064 (D100) into CR#83. If the data exchange is successful, the value in D0 of the Slave will be written into D100 of the MPU. Or write H'1002 (D2) into CR#84, K4 into CR#85, and H'1008 (D8) into CR#86. If the data exchange is successful, the value in D8 ~ D11 of the Master will be written into D2 ~ D5 of the Slave. Both sending and receiving can be executed at the same time. When the values in CR#82 and #85 are both "0", DVPEN01-SL will use the default registers (CR#29 ~ CR#68) and number of registers (K20).

■ Sending Modbus TCP Instruction

CR#111: 8-bit Processing Mode

Explanations:

Setting up the Modbus TCP transmission mode. When the CR value is set as "0" → 16-bit mode; when the CR value is set as "1" → 8-bit mode.

CR#112: Modbus Client Keep-Alive Time-out

Explanations:

CR#112 is the TCP Keep-Alive time-out for Modbus TCP connection (s). Default: 30s. If the connection idle time becomes longer than the keep-alive time-out, DVPEN01-SL will cut off the idle connection.

CR#114: Modbus TCP Time-Out

Explanations:

Setting up the communication time-out (in ms) for Modbus TCP mode.

CR#115: Modbus TCP Trigger

Explanations:

When the CR value is set as "1", Modbus TCP will be triggered. After the data transmission is completed in Modbus TCP mode, the CR value will automatically be reset to "0". Please trigger by differential instructions.

CR#116: Modbus TCP Status

Explanations:

Displaying the current communication status of Modbus TCP mode. When the CR value is set as "0" → the data have not yet been received; when the CR value is set as "1" → the data exchange is in progress; when the CR value is set as "2" → the data exchange is successful; when the CR value is set as "3" → the data exchange fails.

CR value	Data exchange status
0	The data have not been received.
1	The data exchange is in progress.
2	The data exchange is successful.
3	The data exchange fails.

CR#117, 118: Modbus TCP Destination IP

Explanations:

Setting up the destination IP address in Modbus TCP mode. See explanations on CR#70 and #71 for how to set.

CR#119: Modbus TCP Data Length

Explanations:

Setting up the length of communication data in Modbus TCP mode. Length for 8-bit mode: K1 ~K100; length for 16-bit mode: K1 ~ K200.

CR#120 ~ 219: Modbus TCP Data Buffer

Explanations:

Buffer for transmitted/received data in Modbus TCP mode.

CR#251: Error Code

Explanations:

Table of error code:

Bit No.	Error
b0	The network is not yet connected.
b1	Incorrect IP setting
b2	CR#13 is set as "transmitting data", but the data exchange is forbidden.
b3	CR#13 is set as "transmitting data", but the data exchange mode has not yet been enabled.
b4	NTP-Server connection fails.
b7	SMTP-Server connection fails.
b8	DHCP has not obtained the correct network parameter.

■ **RTU Mapping**

CR#15: Enabling Flag for RTU Mapping

Explanations:

1: Enable; 0: Disable. Default = 0

Firmware V2.0 and later versions support RTU mapping.

CR#16: Connection Status of RTU Mapping Slave

Explanations:

b3 ~ b0 display the connection status of RTU slave. The connection may encounter some problems when any of the bits becomes 0. Firmware V2.0 and later versions support RTU mapping.

- b0: Status of RTU slave 1
- b1: Status of RTU slave 2
- b2: Status of RTU slave 3
- b3: Status of RTU slave 4

4.3 Numbering of Left-Side Modules

After DVPEN01-SL is installed properly, you need to compile the PLC program to control the special I/O module. PLC offers FROM instruction (for reading) and TO instruction (for writing) to control the control registers (CR) in the special I/O module.

Numbering of the modules: Every special I/O module connected to PLC MPU has a No. to allow you to know which module is which when compiling the PLC program. The first special I/O module attached at the left hand side of the PLC MPU is numbered as K100, the second as K101, the third K102, and so on.

5 Setting up Software

This section gives instructions on how to set up DVPEN01-SL by DCISoft and explanations on each setup page. Before you start a setup page, you have to select “Ethernet” in the communication setting. Next, you can search by IP address or use Auto-Search. You also can open the setup page for DVPEN01-SL by RS-232. DVPEN01-SL is set up by UDP port 20006; therefore, you have to be aware of the relevant settings of the firewall.

5.1 Setting up Communication & Searching for Modules

■ Communication settings

1. Open DCISoft in your PC and click on “Communication Setting”.

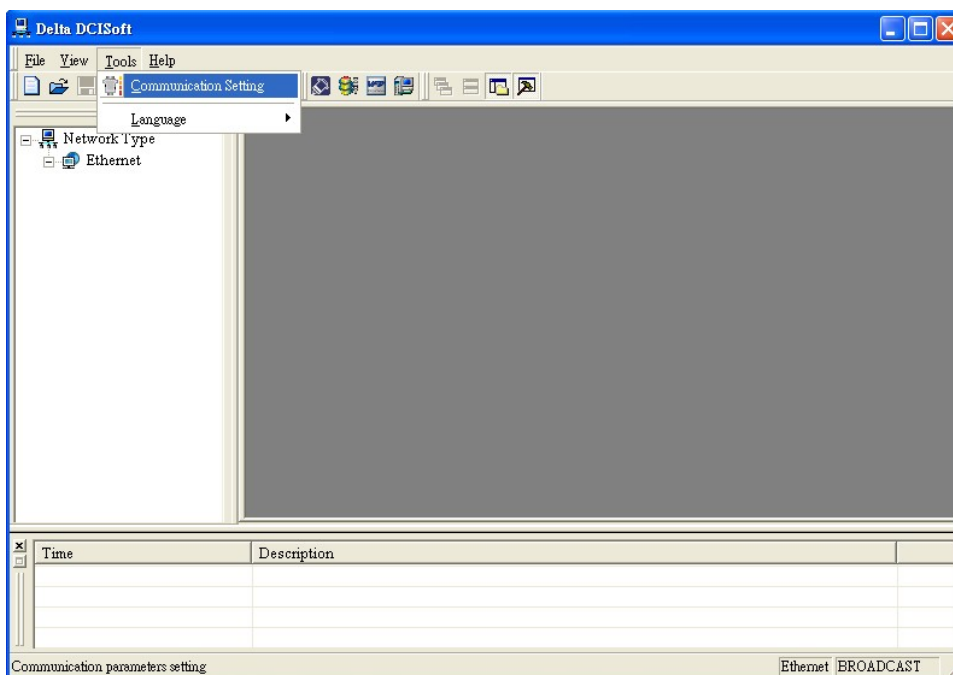

2. Select “Ethernet” as the transmission type.

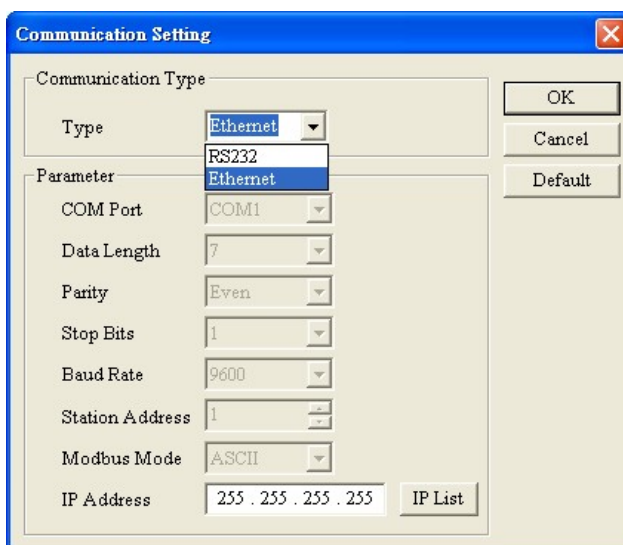

■ Broadcast search

1. Click broadcast icon in DCISoft to search for all Delta Ethernet products on the network. The window on the left hand side shows the models found, and the window on the right hand side displays the device list of all models.

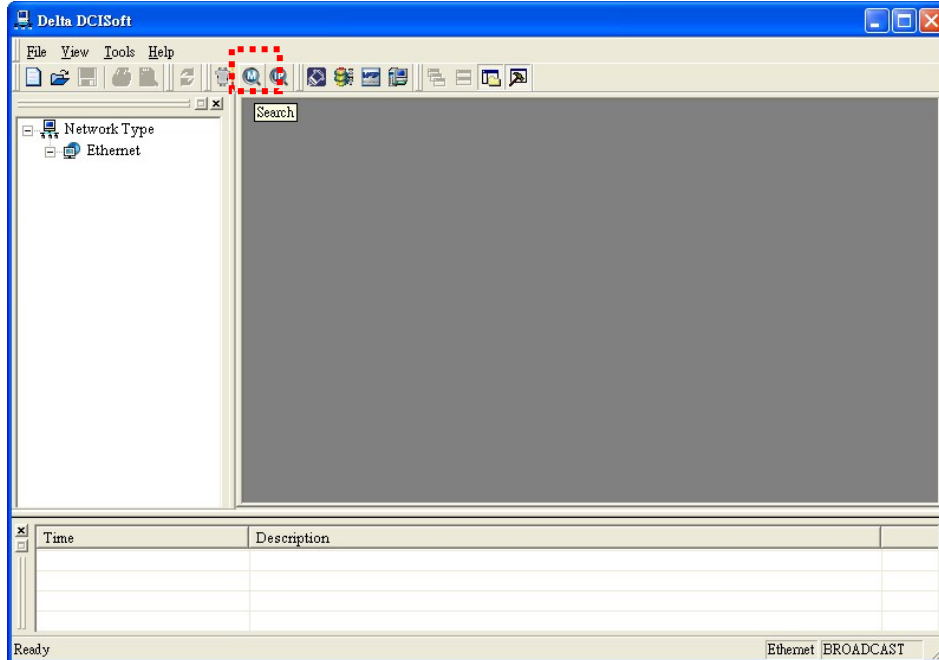

2. Click a model on the left hand side, and you will see the device list of the model selected on the right hand side. Click the device to be set up to enter the setup page.

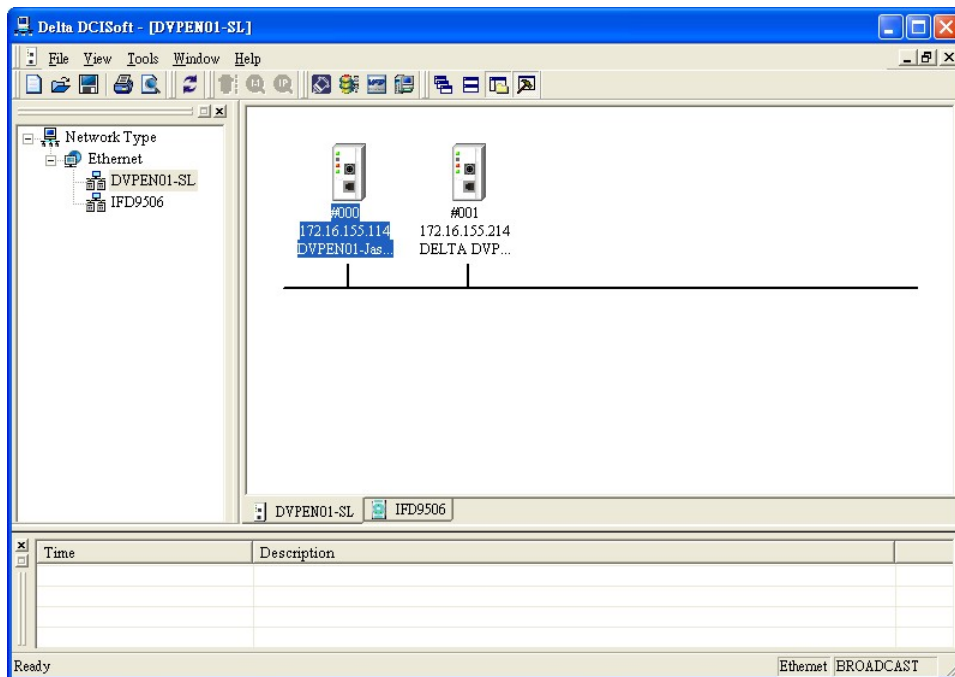

3. You will see the basic setup page as follow.

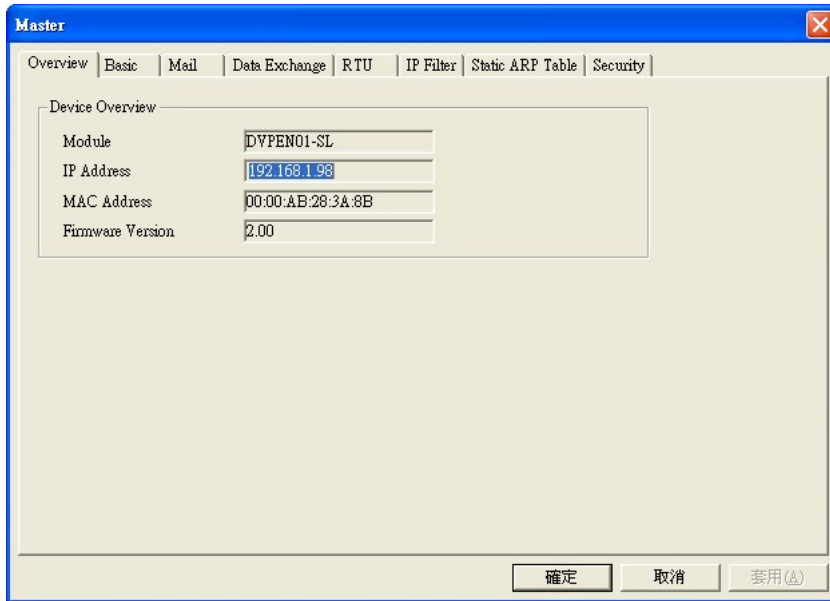

■ Designating model to search

1. Right click "Ethernet" on the left hand side window and select "Configure" to designate a model to search for.

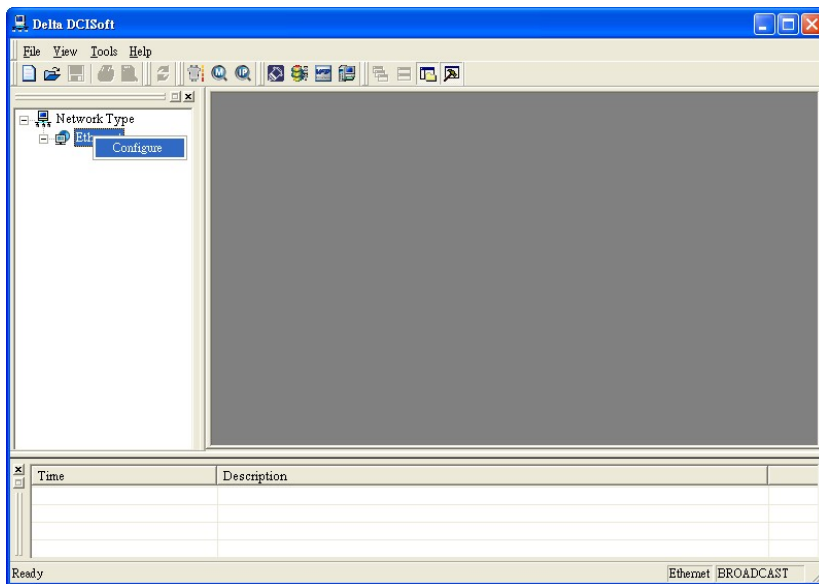

2. After configure a model, select "DVPEN01-SL" and click "OK" to auto-search for DVPEN01-SL modules on the network.

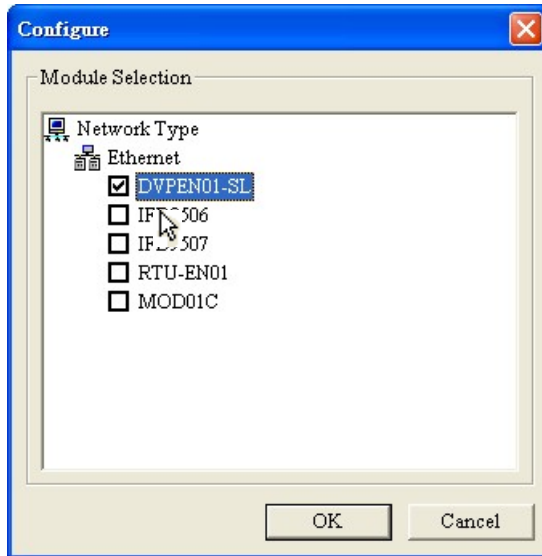

3. List of the current DVPEN01-SL modules

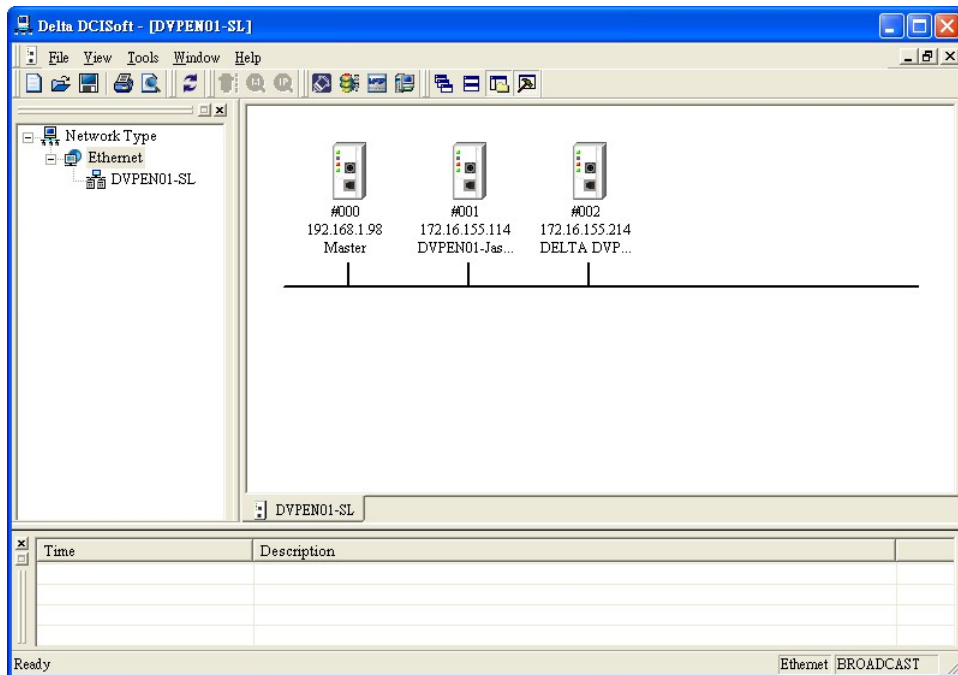

■ Searching by IP address

1. Set the communication type to "Ethernet" and enter the IP address. Click "OK".

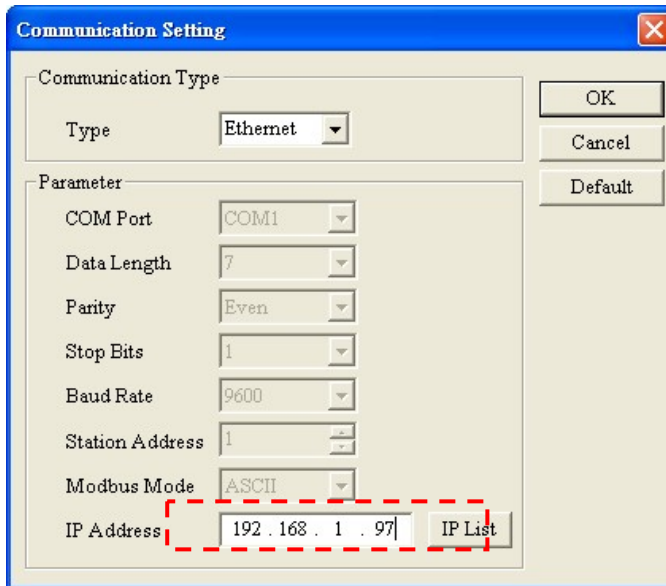

2. Click "IP Search" icon to start searching for the designated IP.

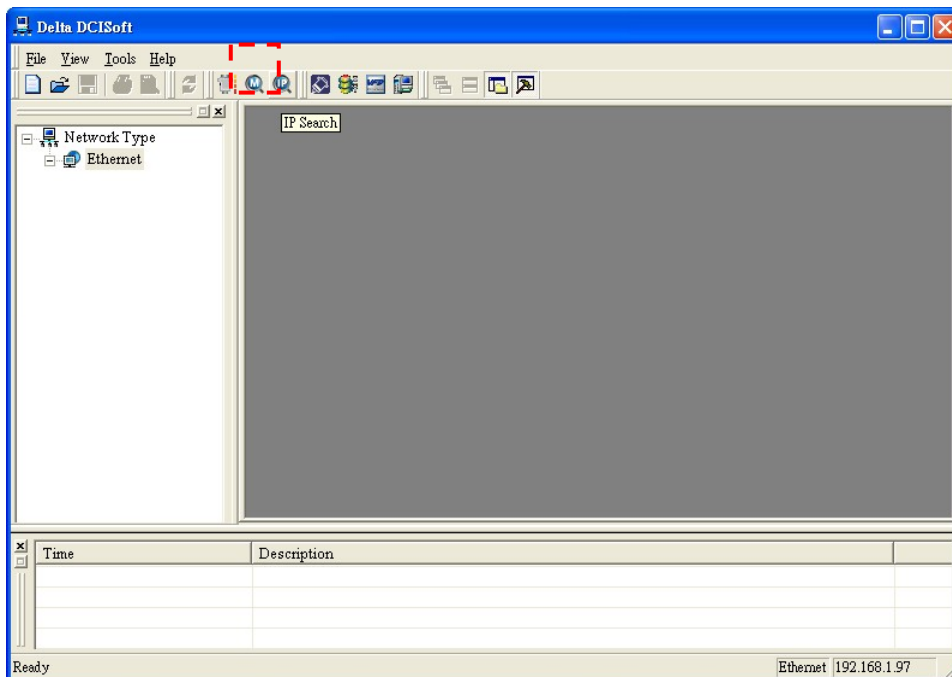

3. The DVPEN01-SL module found will be displayed in the right hand side window. Double click it to enter the setup page.

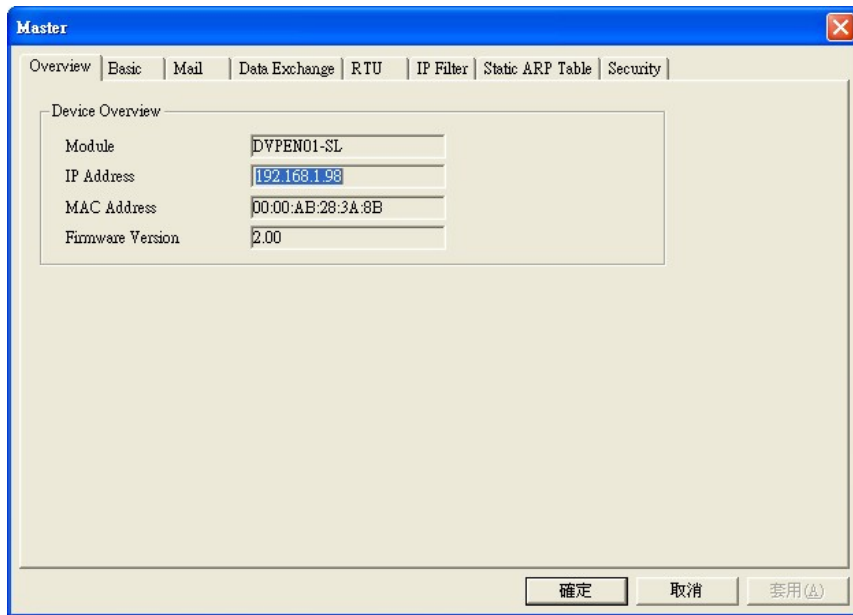

■ **Opening DVPEN01-SL setup page by RS-232**

1. Select "RS232" as the transmission type in communication setting. You will have to designate a communication port. When DVPEN01-SL is searched by RS-232, you do not need to set up the parameters (i.e. data length, parity, stop bits and baud rate).

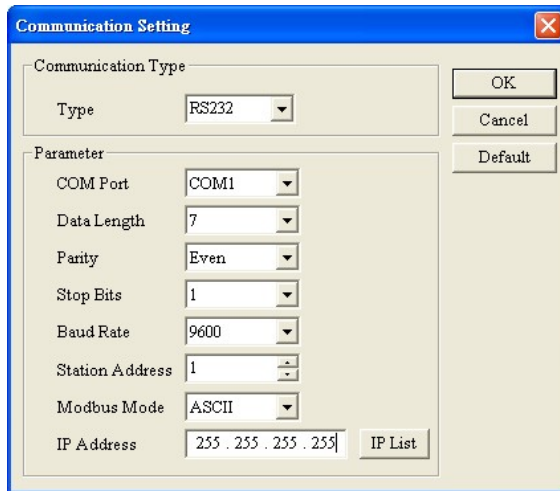

2. After setting up the communication port, press "broadcast search" icon. If the searching is successful, the setup page for DVPEN01-SL will open automatically.

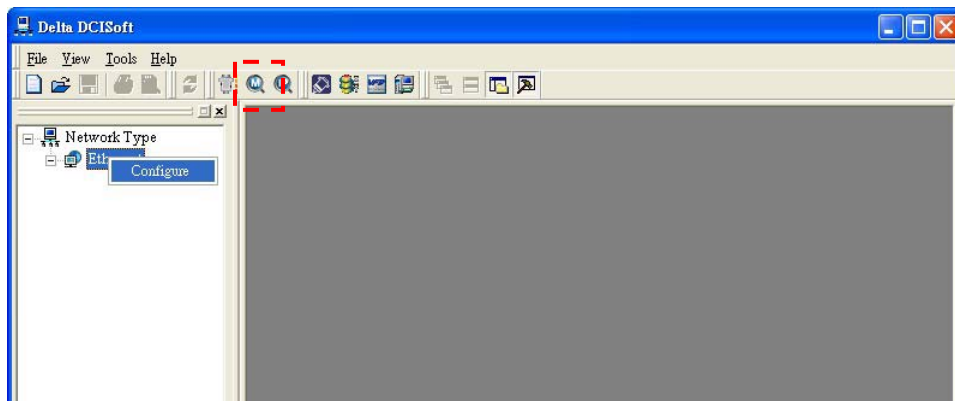

5.2 Basic Settings

The basic settings include parameters as module name, language, enabling Modbus TCP and time correction.

■ Setting up DVPEN01-SL basics

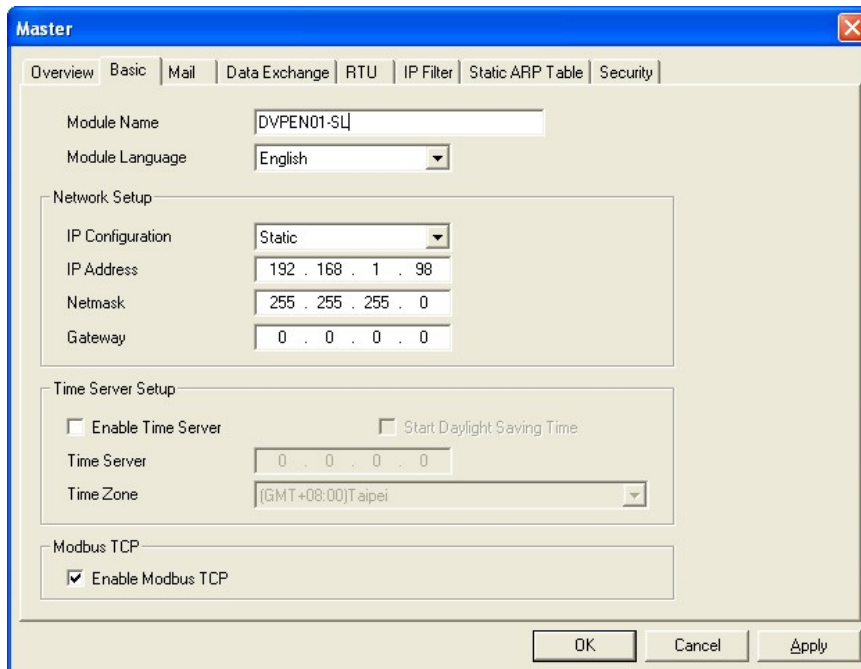

1. Module Name:

There can be many DVPEN01-SL modules in the network. Thus, you can set up a module name for each module to identify the module when you need to use them.

2. Module Language:

You can select a language for each module name, and the windows will be displayed in the selected language.

3. Enable Modbus TCP:

To enable or disable Modbus TCP. When Modbus TCP is disabled, WPLSoft will not be able to upload or download.

4. Enable time correction:

DVPEN01-SL adopts NTP (Network Time protocol), which means it can acquire correct time automatically from the time server in the network and correct the RTC in the MPU every fixed period of time to ensure correct time in the MPU. The default setting of this function is “disable”.

5. Start Daylight Saving Time:

Daylight Saving Time; also known as summer time is a conventional local time adopted by many countries in the world on a seasonal basis. Most commonly DST is obtained by adjusting the official local time forward, by one hour, for the spring, summer, and early autumn periods.

Daylight Saving Time is not implemented in Taiwan; therefore, you do not need to check this item.

6. Time Server:

IP address of the time server. You can acquire correct time from the time server to correct the time in the MPU.

7. Time Zone:

A time zone is a region of the Earth that has adopted the same standard time, usually referred to as the local time. Most adjacent time zones are exactly one hour apart, and by convention compute their local time as an offset from Greenwich Mean Time (see also UTC). Standard time zones can be defined by geometrically subdividing the Earth's spheroid into 24 lunes (wedge-shaped sections), bordered by meridians each 15° of longitude apart. The local time in neighboring zones is then exactly one hour different. However, political and geographical practicalities can result in irregularly shaped zones that follow political boundaries or that change their time seasonally (as with daylight saving time), as well as being subject to occasional redefinition as political conditions change. You should choose the Time zone that you are.

5.3 Network Settings

The first step for all the network equipment to connect to the network is to have its own IP address (Internet Protocol). The IP address is like a number for every network equipment to be identified in the network.

■ Setting up static IP of the PC

1. Enter Control Panel → Network Connection → click on “Local Area Connection”

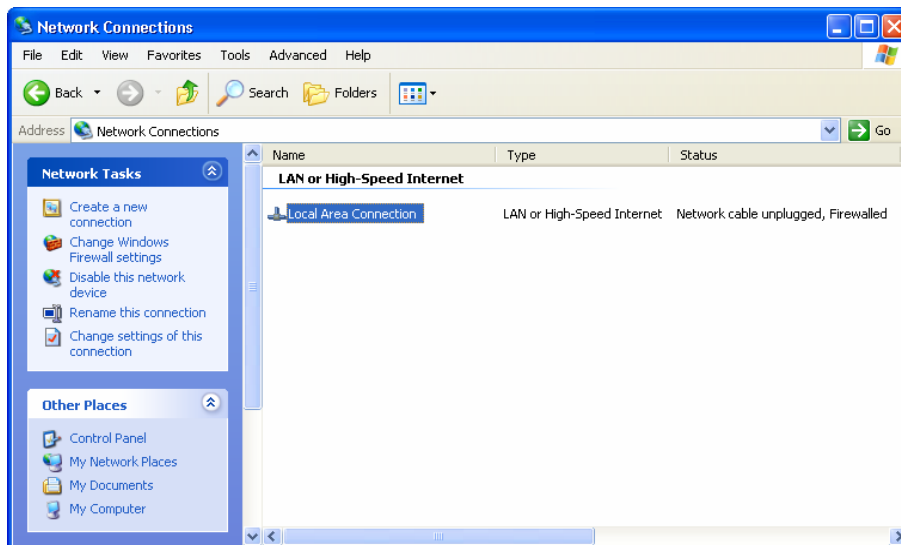

2. You will see the “Local Area Connection Status” window. Click on “Properties”.

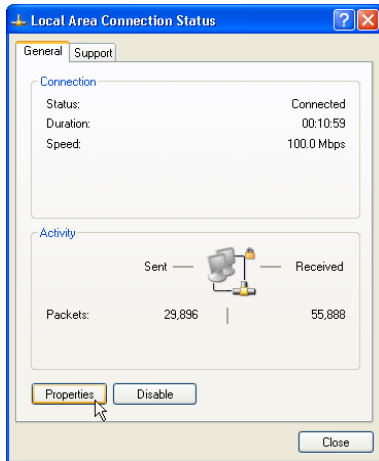

3. Click on "Internet Protocol (TCP/IP)".

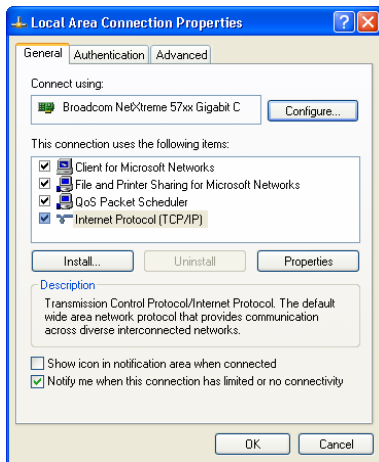

4. Enter 192.168.0.1 into IP address. Click on "OK" to complete the IP address setting of the PC.

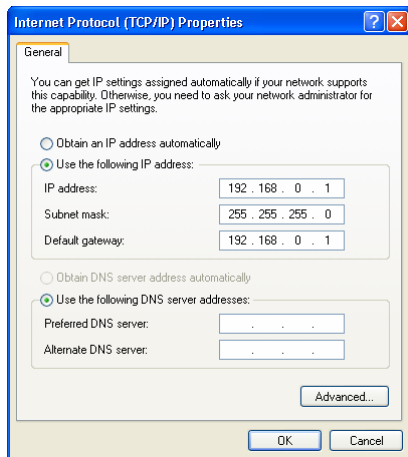

■ Setting up DVPEN01-SL Network

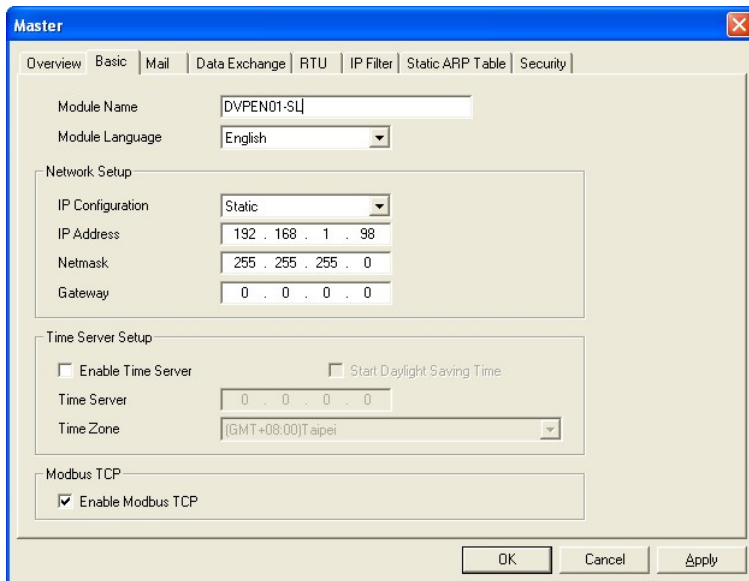

1. IP configuration:

There are two types of IP, static IP and DHCP.

Static IP: Preset or manually modified by the user.

DHCP: Automatically updated by the server. There has to be a server in the LAN.

IP	Explanation
Static	The user enters the IP address, subnet mask and gateway.
DHCP	DHCP server offers the IP address, subnet mask and gateway.

2. IP address:

IP address is the location of the equipment in the network. Every equipment connected to the network has to have an IP address. Incorrect IP address will result in connection failure on the equipment or even other equipment. Ask your ISP for questions about IP address setup. The default IP for DVPEN01-SL is 192.168.1.5.

3. Subnet mask:

Subnet mask is an important parameter for setting up the subnet, used for seeing if the destination IP and the local equipment are in the same subnet. If not, the equipment will send the packet to the gateway, and the gateway will send the packet to another subnet. Incorrect setting may cause the destination equipment unable to communicate with DVPEN01-SL. To see if your setting is correct, conduct bitwise AND operations between your IP and subnet mask and destination IP and subnet mask. If the two values obtained are the same, the two IPs are in the same subnet. The default subnet mask of DVPEN01-SL is 255.255.255.0.

4. Gateway:

Gateway is the gate for two different subnets, allowing the two ends in different subnets to communicate. For example, if the LAN has to be connected to WAN, it will need a gateway to bridge the communication. The IP of the gateway has to be in the same subnet as DVPEN01-SL. The default gateway IP address of DVPEN01-SL is 192.168.1.1.

5.4 Setting up E-Mails

E-mail is the abbreviation of electronic mail, which transmits mails through the network. DVPEN01-SL has E-Mail functions for the user to pre-save a segment of text messages, which can be a descriptive message or error message, into the subject of the E-Mail. When the E-Mail is triggered, DVPEN01-SL will send the messages to the user by E-Mail.

DVPEN01-SL offers 4 sets of E-Mail information, and you can self-define the register or bit information to be read. When the trigger occurs, DVPEN01-SL will add the set register or bit present value read to the E-Mail. Every set of E-Mail information is able to contain maximum 100 continuous register data.

■ Setting up DVPEN01-SL mail

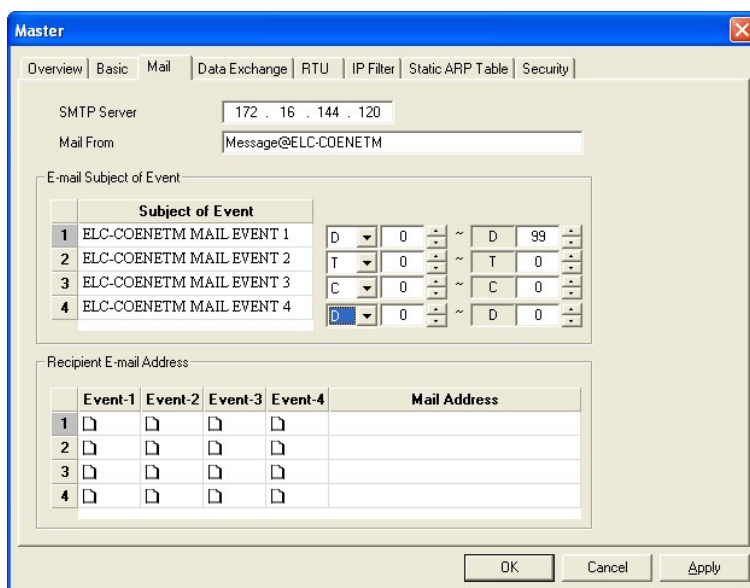

1. SMTP Server:

The E-Mail will first be sent to SMTP server, and SMTP server will send it to the designated address. For example, assume there is an E-Mail to be sent to test@delta.com.tw, and the SMTP server is 172.16.144.121. The E-Mail will be sent to SMTP server first, and the server will further send it to the recipient test@delta.com.tw.

2. Subject of E-Mail:

You can enter text message in the column, and the message will be placed in the subject of the E-Mail and sent to the recipient. DVPEN01-SL is able to contain 1 ~ 4 E-Mail subjects (max. 63 English characters are allowed).

You can select additional information for the E-Mail. Every set of E-Mail is able to contain 100 continuous addresses of registers.

3. E-Mail of Sender:

Maximum 63 English characters are allowed.

4. E-mail of Recipient:

You can enter 4 E-Mail addresses. One mail can be sent to 4 addresses (max. 63 English characters are allowed).

5. Select recipients:

After you have set up all the parameters for the E-Mail, you will need to select recipients. The

E-Mail will be sent to the designated recipients when the E-Mail is triggered. To trigger E-Mail, set the value is CR#3 ~ CR#6 as "1".

6. See "Application Examples Section 6.8" for more details.

Notes:

To correctly send out E-Mails, there has to be a SMTP server in the network. When we send out an E-Mail, the mail will be sent to SMTP server first, and the server will further send the mail to the designated address.

5.5 Data Exchange

DVPEN01-SL is able to designate a data exchange area for PLC MPUs to exchange and synchronize their data.

■ Setting up DVPEN01-SL data exchange

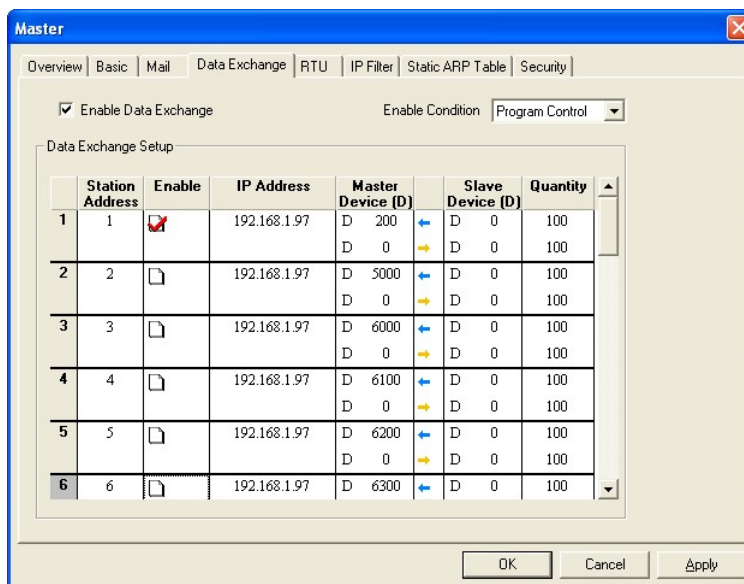

1. Enable Data Exchange:

Check the box to enable or disable data exchange. Start data exchange after enable it.

2. Execute Mode:

You can set it to "Always Enable" or "Program Control". When set to "Always Enable", DVPEN01-SL will execute data exchange continuously until the setting in DCISoft is changed. When set to "Program Control", DVPEN01-SL will execute data exchange according to the program setting (CR#13 = 2: Execute; CR#13 = 0: Stop).

3. Communication Address & Data exchange host IP:

You have to enter the IP address of DVPEN01-SL at the other end. For example, if you would like DVPEN01-SL to exchange data with 192.168.0.1, set No. 1 as 192.168.0.1. When the data are being exchanged, if the value in CR#28 is H'0001, the data will be exchanged with 192.168.0.1.

4. Master Address & Slave address & Quantity.

Read (←): Start address of the master's receiving register ← Start address of the slave's sending register

Write (→): Start address of the master's sending register → Start address of the slave's

receiving register

In data exchange, DVPEN01-SL will execute Write (→) first before Read (←).

Quantity: A slave is able to send and receive at the same time maximum 100 consecutive data.

- ▶ For data exchange, D register is parted into 2 sections, D0000 ~ D4095 and D4096 ~ D9999.

Please DO NOT use different sections for the consecutive sent and received data (start address + number of data).

5. See “Application Examples Section 6.11” for more details.

5.6 RTU

Use the “RTU” function to conduct mapping between Delta’s network modules DVPEN01-SL and RTU-EN01. Set up the mapping information first, and you will be able to use WPLSoft in DVPEN01-SL to save and retrieve the mapped bit (M) and register (D) in order to operate the remote RTU-EN01.

■ The settings

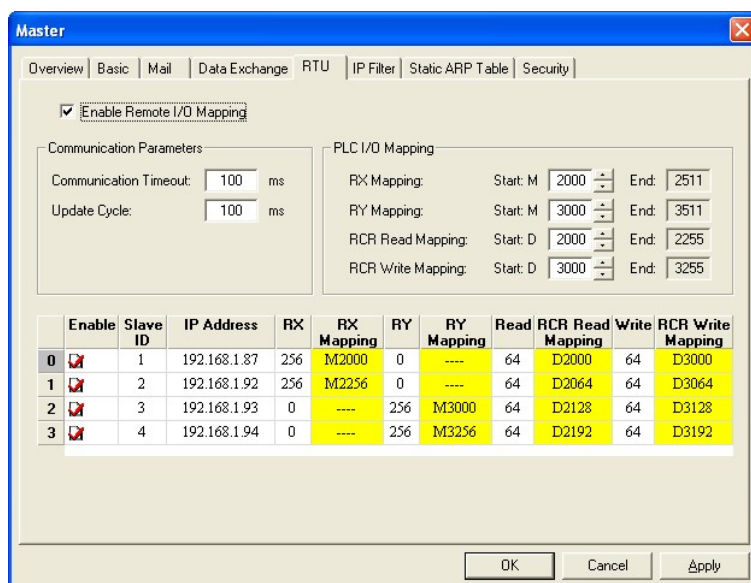

1. Enable Remote I/O Mapping:

Check the box to enable the remote I/O mapping. The mapping with remote RTU-EN01 will be enabled according to the settings.

2. Communication Parameters:

Set up “Communication Timeout” (ms) and “Update Cycle” (ms) here.

3. PLC I/O Mapping:

Set up the start address of the mapped bit and analog register (RCR) of digital input (X) and digital output (Y) on remoter RTU-EN01. The bit starts from M2000, and read/write register starts from D2000/D3000. The software will automatically calculate the end address according to the settings below.

4. Remote Device Mapping:

Check “Enable” and enter the remote RTU-EN01 ID (Slave ID), IP Address, number of digital input points (RX), number of digital output points (RY), number of mapped read registers (Read) and write register (Write).

DVPEN01-SL offers 4 slaves for mapping. Max. number of digital and analog points for mapping

of every slave:

Digital I/O points (RX+RY): 256

Analog (Read) register: 64

Analog (Write) register: 64

5.7 IP Filter

IP filter is used for restricting the connection of the network in case some uncertain IP will cause errors. Only the IP set within a certain range can establish a connection. Other IPs will be rejected.

■ Setting up IP filter

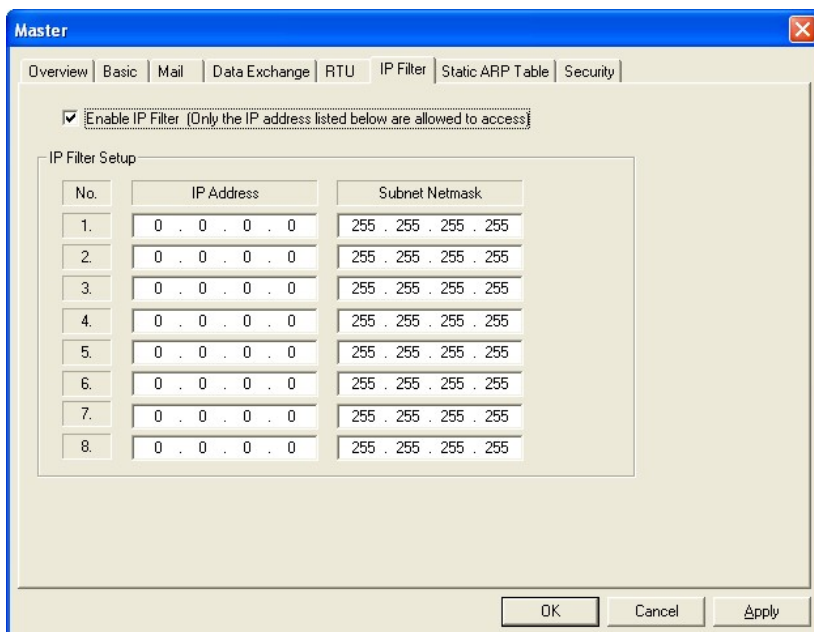

1. Enable IP Filter Function:

Check the box to enable IP filter.

2. IP:

IP addresses that are allowed to establish connections. Maximum 8 IPs are allowed.

3. Netmask:

The subnet of the IP is allowed to establish a connection. To see whether the destination IP is allowed, conduct bitwise AND operations between the allowed IP and subnet mask and destination IP and subnet mask. If the two values obtained are the same, the destination IP is allowed by the IP filter. For example, assume the IP is 192.168.0.1 and subnet mask 255.255.255.255, the only one IP allowed to establish a connection is 192.168.0.1. If the subnet mask is 255.255.255.0, the IPs allowed to establish connections will become 192.168.0.0 ~ 192.168.0.255.

5.8 Static ARP Table

ARP (Address Resolution Protocol) is used for obtaining the MAC address corresponding to the IP address in data transmission. For example, there is a datum to be sent to 172.16.155.250, but you do not know the corresponding MAC address. You can use ARP to look up the MAC address by IP address, and the corresponding MAC address will be saved, so you do not need to look it up again when sending the next datum.

Therefore, if you do not know the MAC address, you will have to spend some time looking up the MAC address. If you want to enhance the transmission efficiency, use static ARP table to save time. For example, assume IP: 192.168.0.1 and MAC: 00:14:22:56:0F:7F. As long as there are data sent to 192.168.0.1, you will get the MAC address from the table.

■ Setting up static ARP table

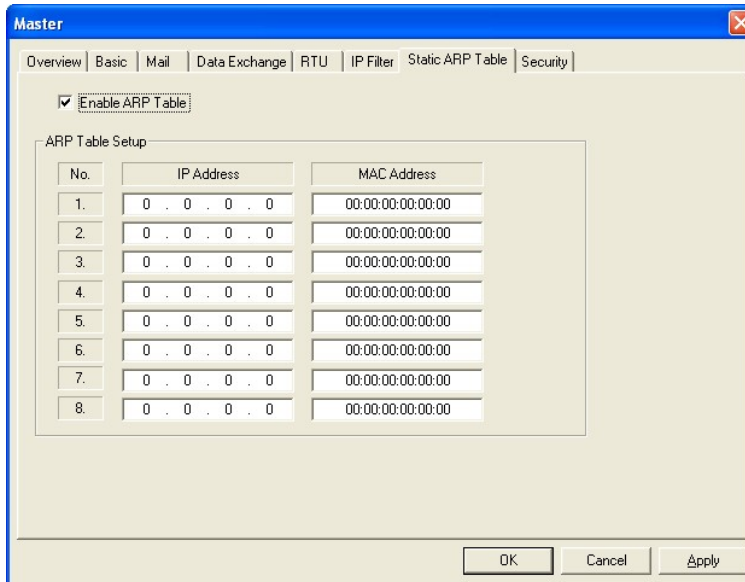

1. IP:

Destination IP address in data transmission.

2. MAC:

The MAC addresses corresponding to the IP address.

Note:

Incorrect settings may result in connection failure. Therefore, DO NOT set the MAC address of the equipment without the network into the table.

5.9 Setting up Password

To prevent the set values in DVPEN01-SL from being modified, you can set up password to lock the settings in DVPEN01-SL.

■ Setting up DVPEN01-SL password

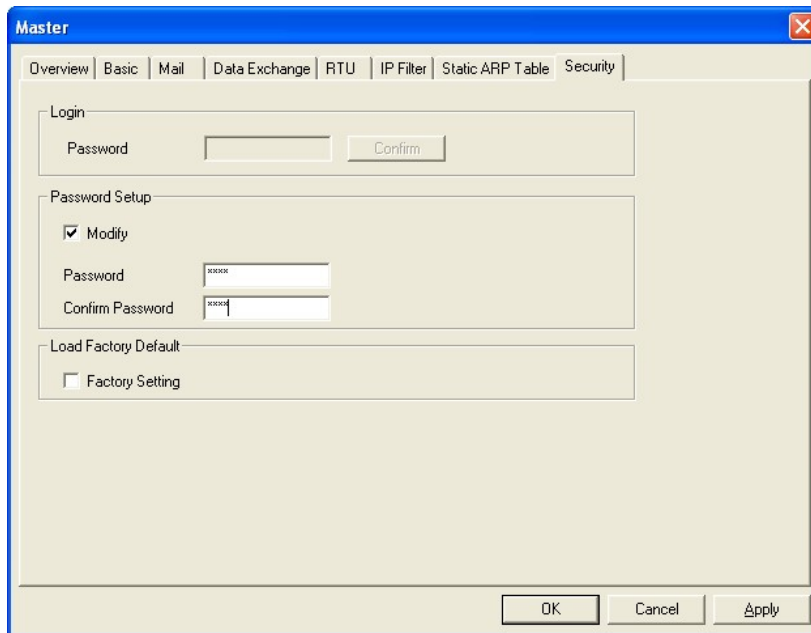

1. Modify:
Check the box to modify the password.
2. New Password:
Maximum 4 characters are allowed. Leave the column “blank” to disable the password protection function.
3. Confirm Password:
Enter the new password again.
4. See “Application Examples Section 6.4” for more details.

Note:

After the password is locked, all the pages cannot be set up unless you unlock the password. However, if you set up DVPEN01-SL by RS-232, you can return the setting to default setting whether the password is locked or not. For example, if you have locked DVPEN01-SL but forget the password, you have to return DVPEN01-SL to factory default setting by RS-232, and all the settings will return to default ones.

5.10 Returning to Default Setting

If you need to clear all the settings after many modifications on the settings and return the settings to default ones, check the “default setting” box.

- **DVPEN01-SL returning to default setting**

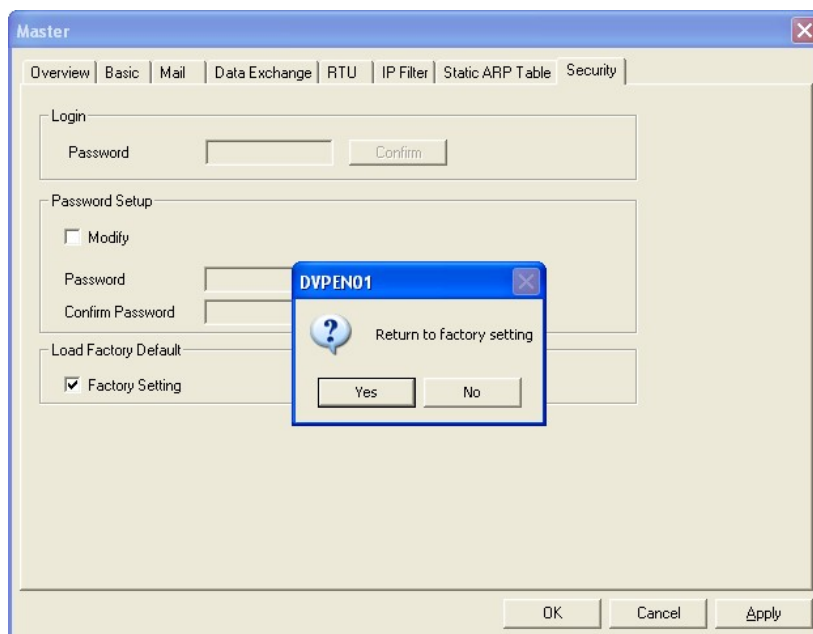

Check “Default Setting” box and click on “Yes”.

Note:

If you set up DVPEN01-SL by RS-232, you can return the setting to default setting whether the password is locked or not. It takes approximately 10 seconds to return to default setting, so DO NOT switch off the power within the 10 seconds.

6 Application Examples

6.1 Setting up IP and Communicating through WPLSoft

Application	Setting up network parameters of DVPEN01-SL directly on the PC.
Network requirement	(1) IP of PC executing WPLSoft: 192.168.0.3 (2) Subnet mask: 255.255.255.0; Gateway: 192.168.0.1 (3) IP of DVPEN01-SL: 192.168.0.4 (4) Connect the PC and DVPEN01-SL by RJ-45 cable. Note: Both PC and DVPEN01-SL have to adopt static IP.

1. The connection

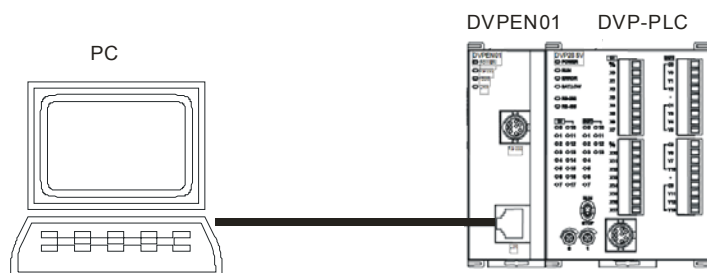

2. Open "Communication Setting" in WPLSoft.

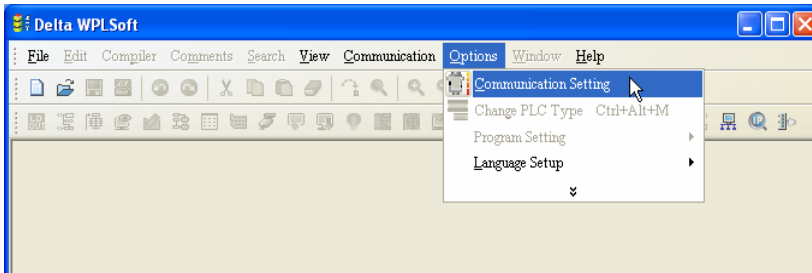

3. Select "Ethernet" and press "OK".

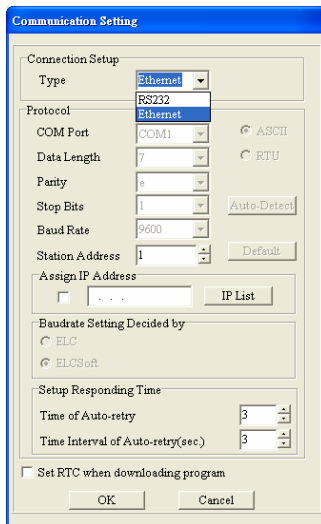

4. Click on "Auto-Search" icon to search for all DVPEN01-SL modules in the network.

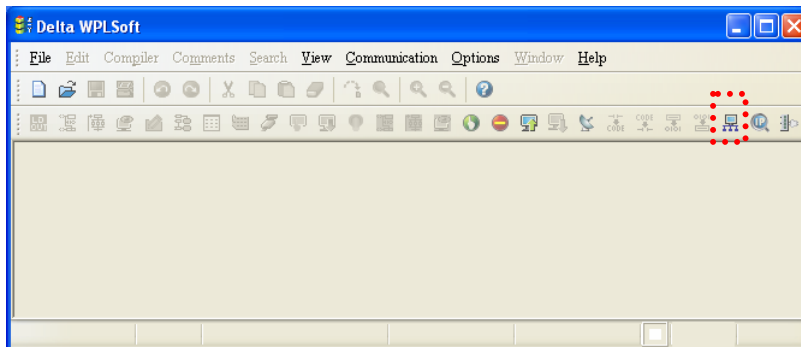

5. Designate a DVPEN01-SL and double click it to open the setup page.

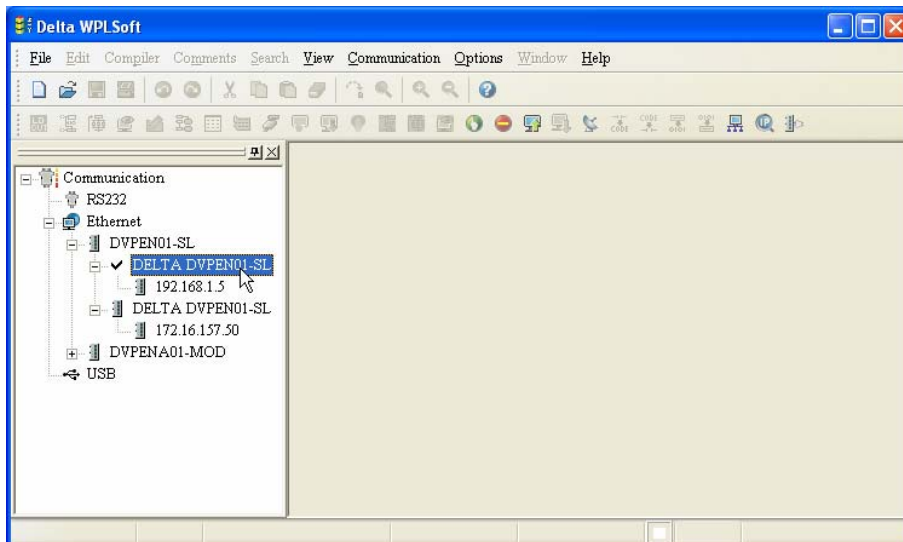

6. Open “Basic” setup page.

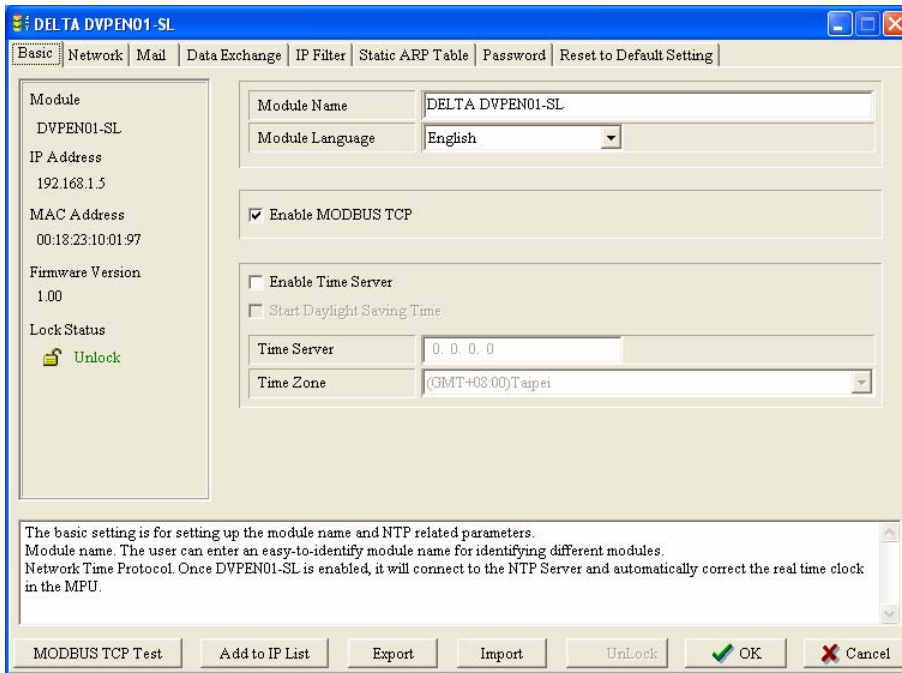

7. Switch to “Network” setup page

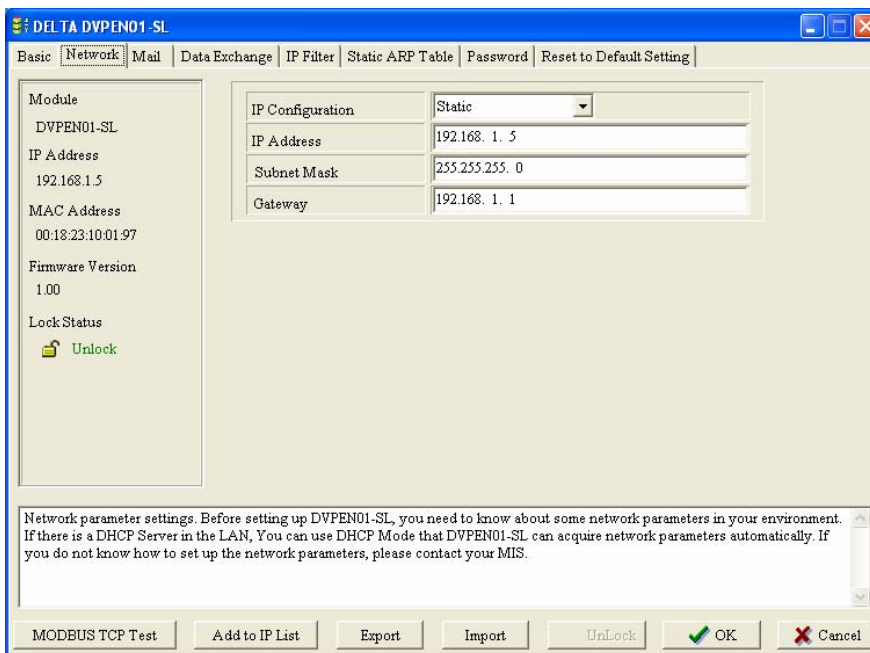

8. Enter IP address: 192.168.0.4; Netmask: 255.255.255.0; Gateway: 192.168.0.1. Press "OK" to complete the setup, and WPLSoft will automatically search for DVPEN01-SL.

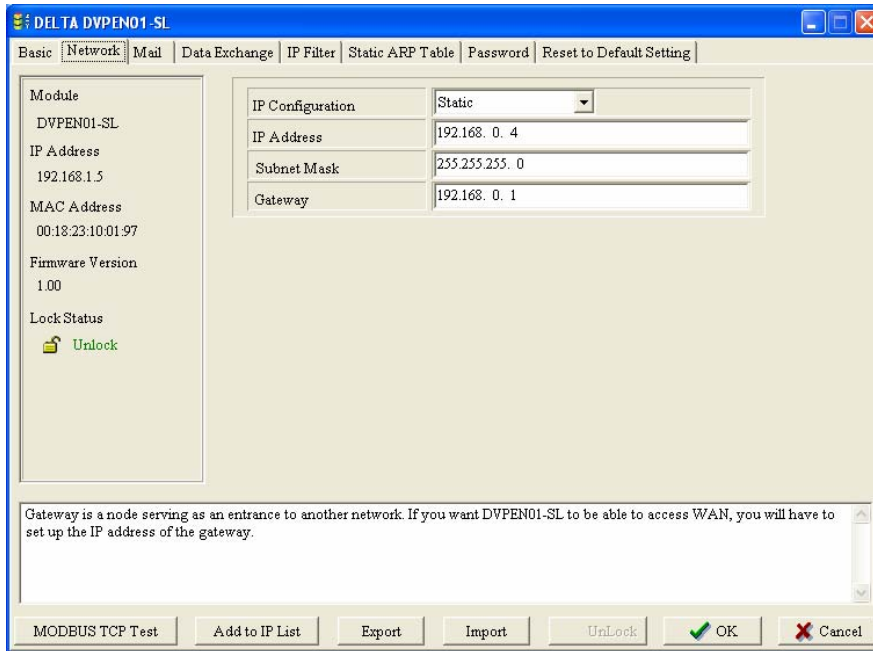

9. The IP of DVPEN01-SL has been modified into the new setting (DELTA DVPEN01-SL: 192.168.0.4).

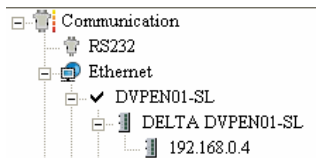

10. Click on DELTA DVPEN01-SL, and WPLSoft will be able to communicate with the MPU.

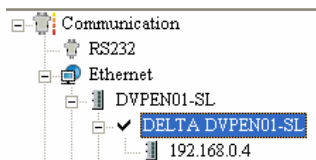

6.2 Connecting the PC with DVPEN01-SL through LAN

Application	Setting up network parameters of DVPEN01-SL by WPLSoft through LAN.
Network requirement	(1) Connect the PC and DVPEN01-SL by using DHCP server through LAN. (2) IP of DVPEN01-SL: 172.16.157.148 Note: DVPEN01-SL can use RJ-45 cable with/without jump wire.

1. The connection

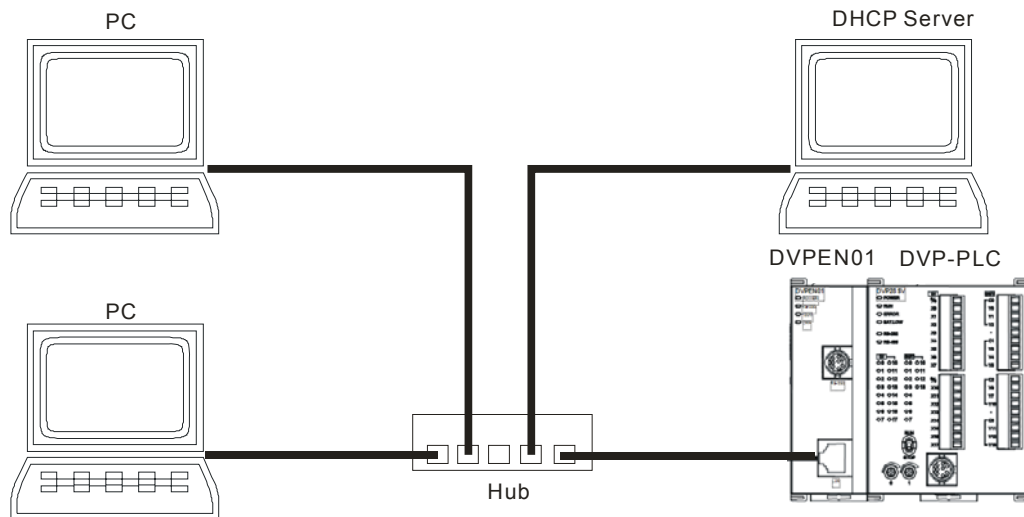

2. Open "Communication Setting" in WPLSoft.

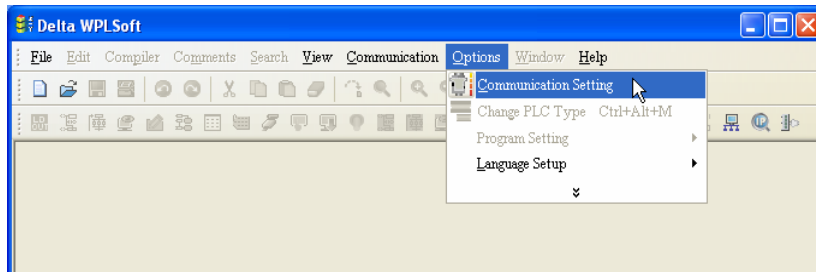

3. Select "Ethernet" and press "OK".

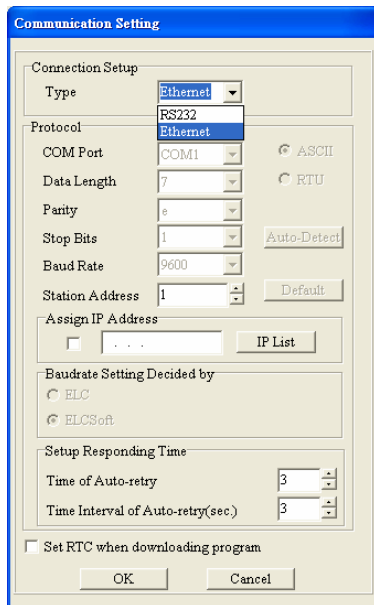

4. Click on “Auto-Search” icon to search for all DVPEN01-SL modules in the network. Follow “View → Workspace → Communication” or “View → Workspace → Project” to find the detected DVPEN01-SL module (default module name: DELTA DVPEN01-SL, IP: 192.168.1.5) in the window.

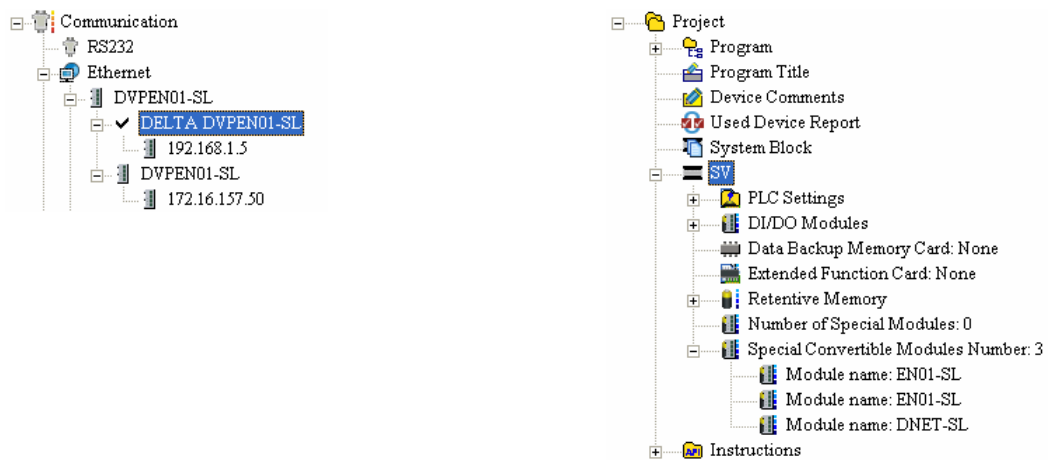
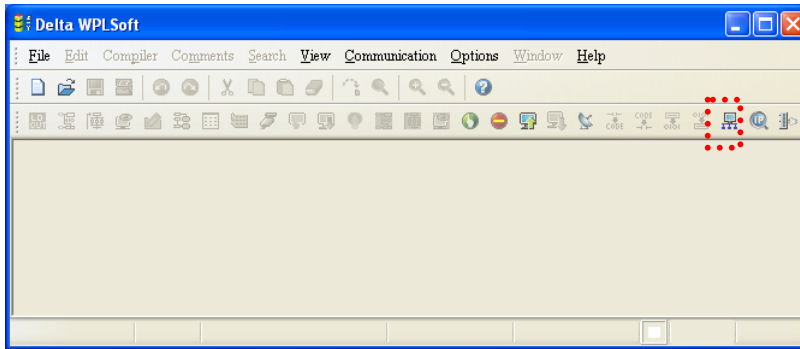

5. Designate a DVPEN01-SL and double click it to open the setup page.

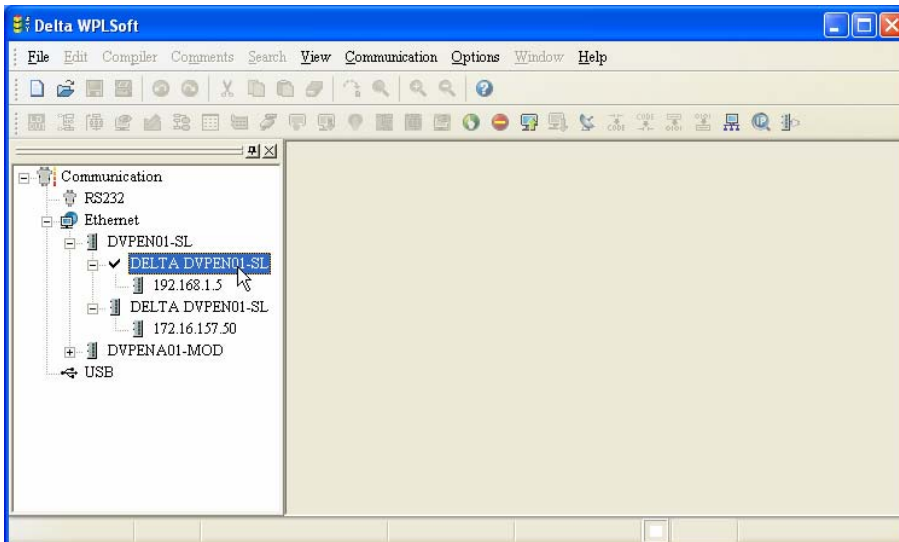

- Open the setup page. You can modify the module name for easier identification.

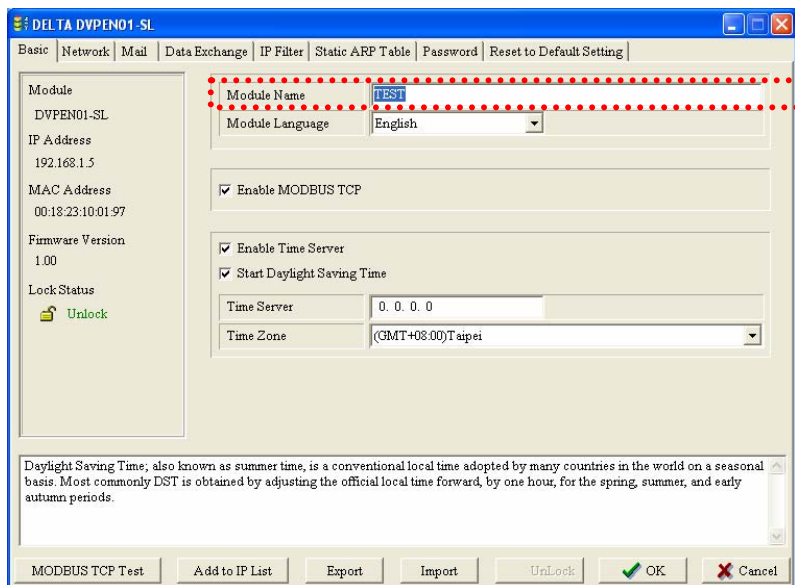

- Next, set up the new IP of DVPEN01-SL. First switch to "Network" setup page. If there is a DHCP server in the LAN, select DHCP in "IP Configuration". If there is no DHCP server in the LAN, you can set a static IP. Please be noted that the settings of subnet mask and gateway have to be the same as the settings in the same LAN. Press "OK" to complete the setting, and WPLSoft will automatically search for DVPEN01-SL.

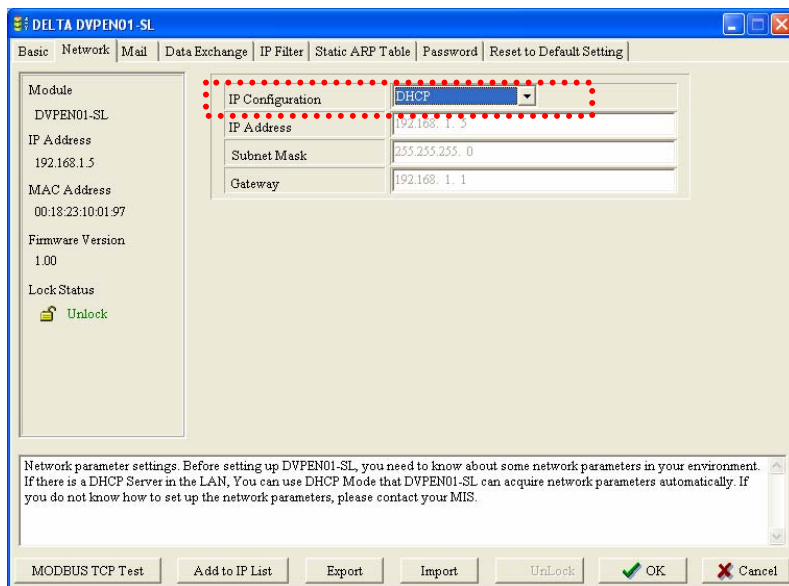

- The module name and IP of DVPEN01-SL have been modified into new settings (TEST: 172.16.157.148).

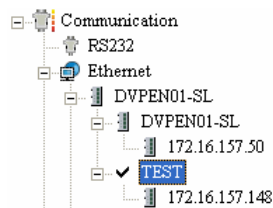

- Click on DVPEN01-SL, and WPLSoft will be able to communicate with the MPU (e.g. uploading/downloading program or monitoring devices).

6.3 Setting up Password and Clearing Password

Application	Setting up and clearing password by WPLSoft
Network requirement	(1) Set password in DVPEN01-SL (2) Unlock DVPEN01-SL (3) Clear the password in DVPEN01-SL

1. See 6.1 for the connection and how to set up the communication.
2. Open the setup page and switch to “Password” page.

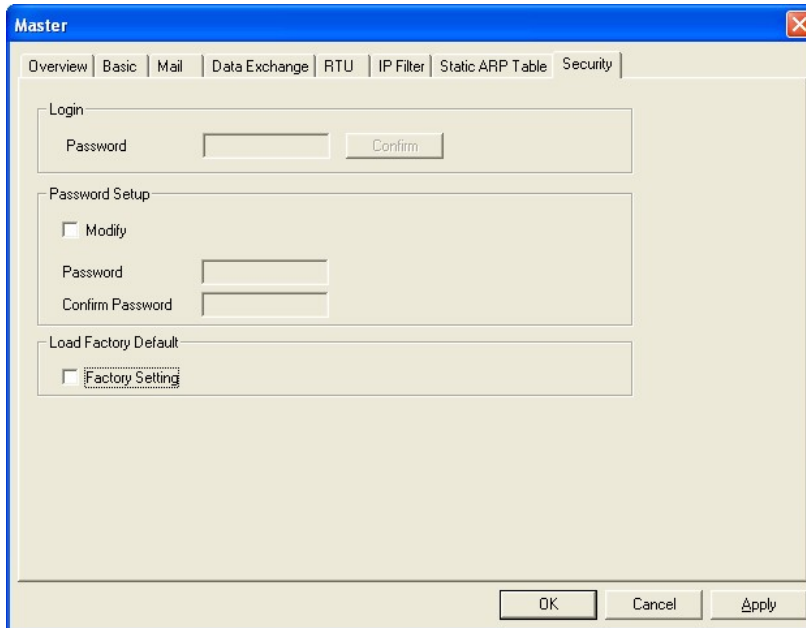

3. Check “Modify” box and enter “aabb” in “New Password” and “Confirm Password” columns. Click on “OK” to save the password.

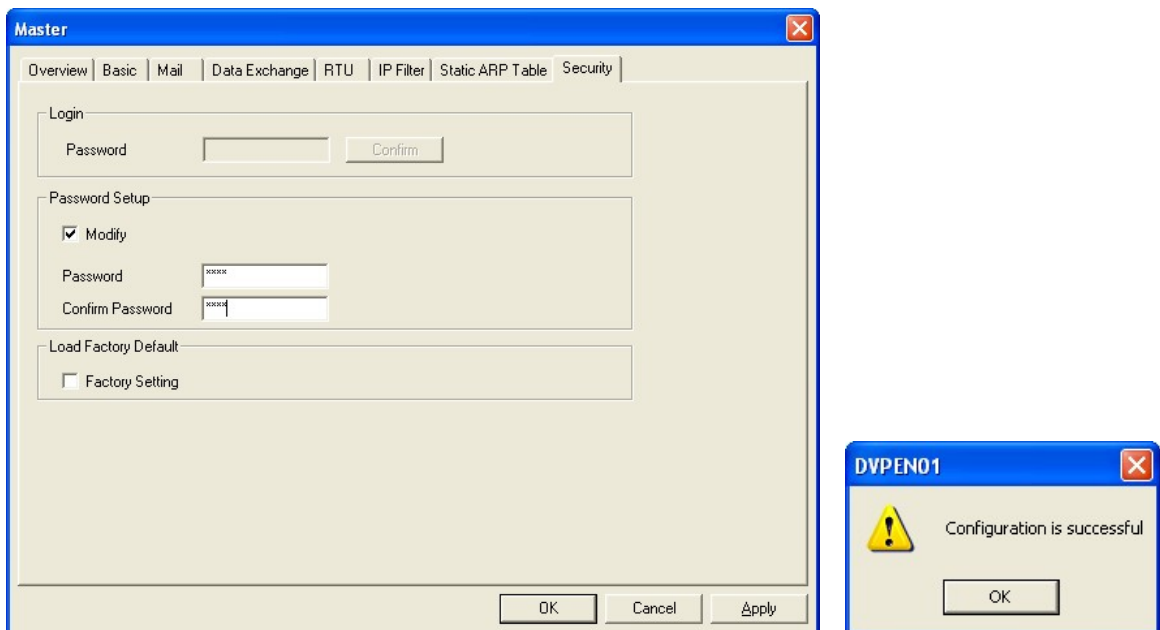

4. Open the setup page again, and DVPEN01-SL is now locked by the password. You cannot open any of the settings now. Click on “Unlock” to leave the entering password window.

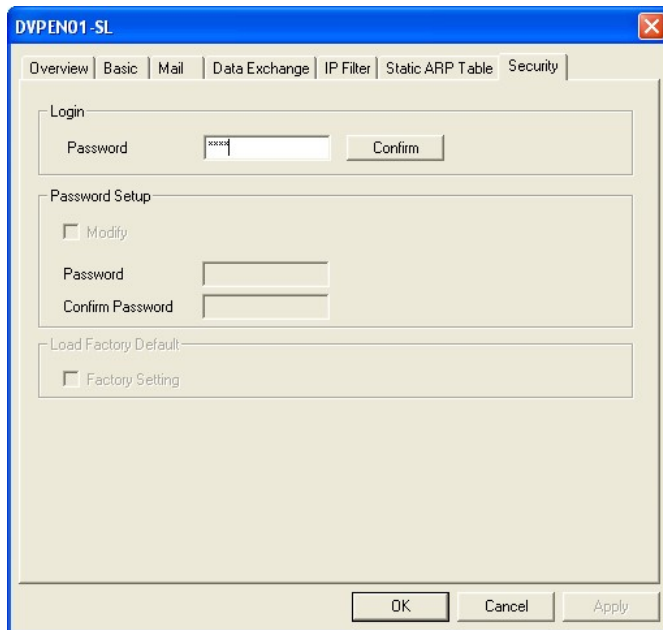

5. Enter the password to temporarily unlock the protection and modify the parameters. If you close the setup page, the locking will automatically be recovered.

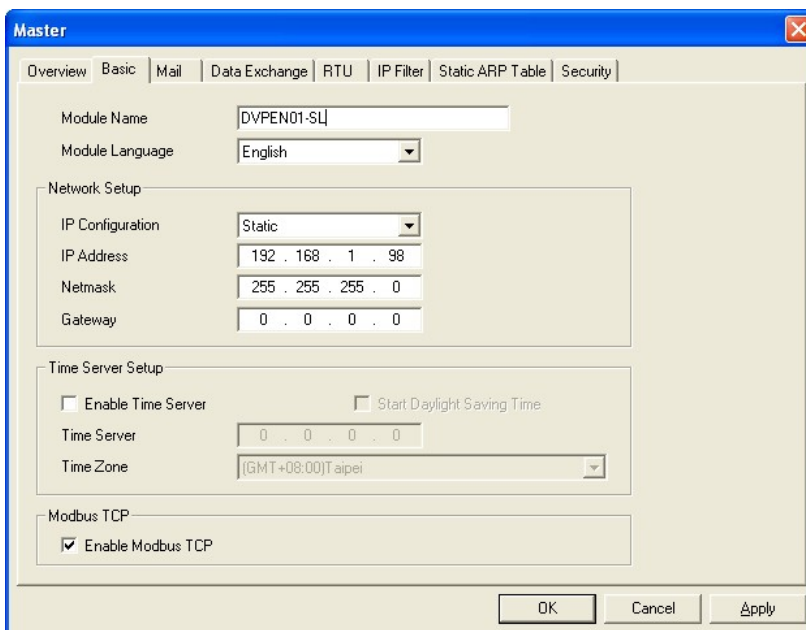

6. To clear the password, simply leave the password columns blank. Click on "OK" to clear the password.

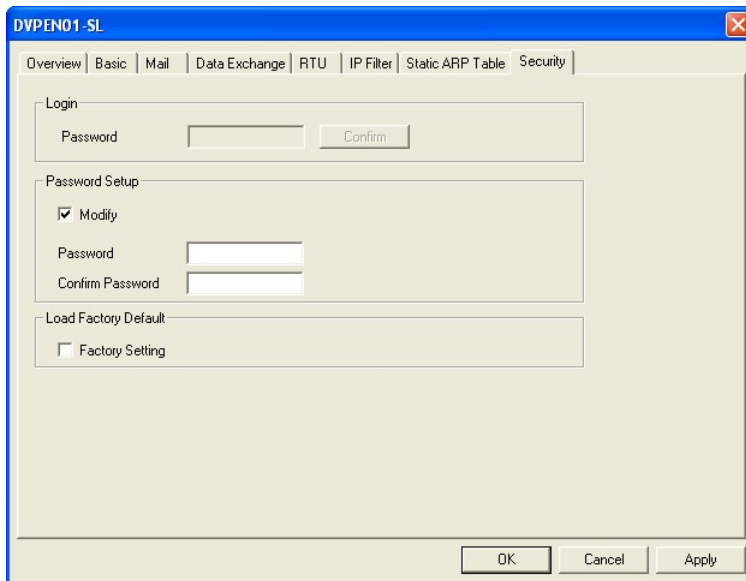

7. After the password is cleared, you can modify the parameters.

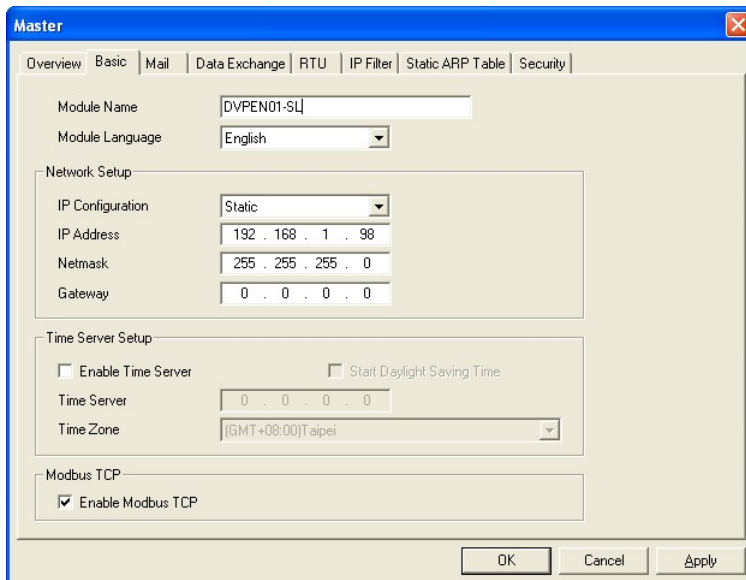

6.4 When the Password is Lost (Returning to Default Setting by RS-232)

Application	Returning to default setting by RS-232
Network requirement	(1) DVPEN01-SL is set with a password. (2) The password is forgotten.

1. Use DVPACAB2A30 cable to connect the PC and DVPEN01-SL and open the setup page. Open the “reset to default setting” pages. Click on “Unlock”.

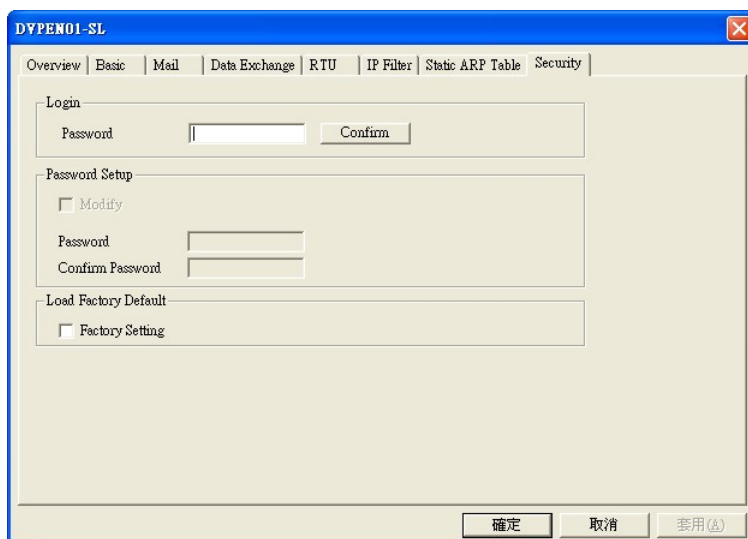

2. Check the “Default Setting” box and the “Warning” dialog box will appear. Click on “Yes” to return to default setting (in approx. 5 ~ 10 seconds), and the password will be cleared as well.

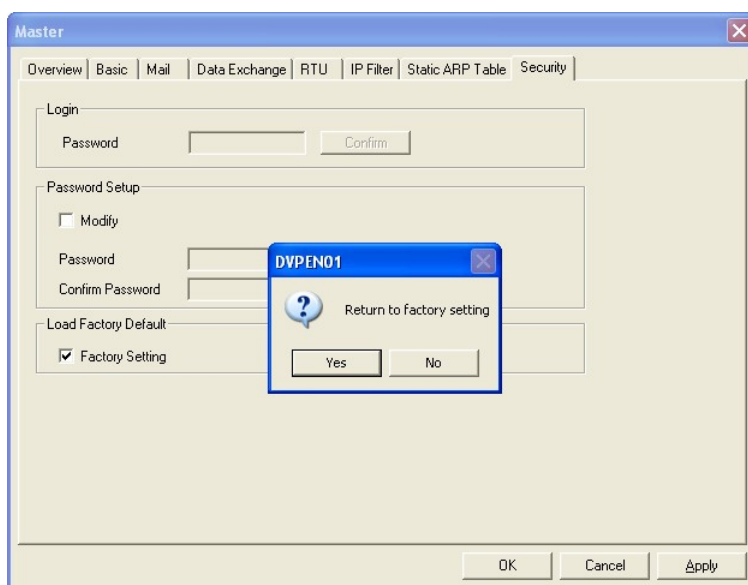

3. After the searching, all the parameters have already returned to their default settings.

6.5 IP Filter Protection

Application	Setting up IP filter protection
Network requirement	(1) IP of DVPEN01-SL: 192.168.0.4 (2) Only connections to 192.168.0.7 and 172.16.0.1~172.16.0.255 are allowed.

1. See 6.1 for the connection and how to set up the communication.
2. Open the setup page and switch to “IP Filter” page.

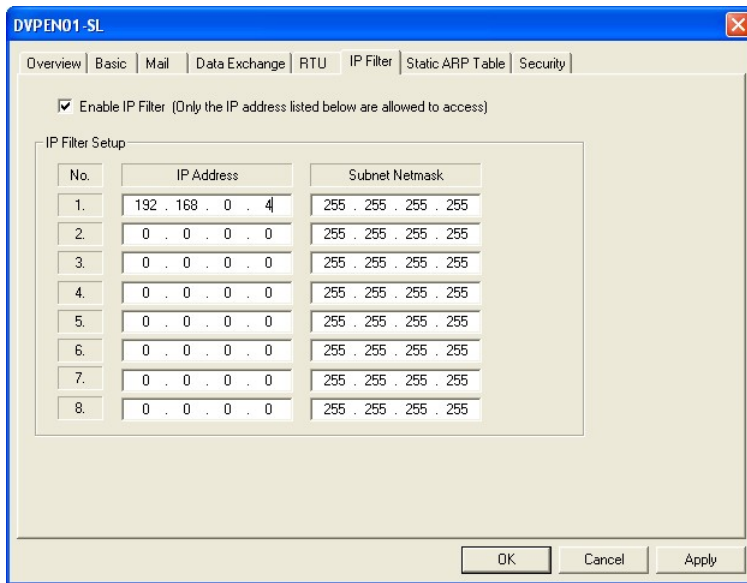

3. Check "Enable IP Filter Function" box. Enter "192.168.0.4" in No. 1 IP and "255.255.255.255" in all "Netmask" columns.

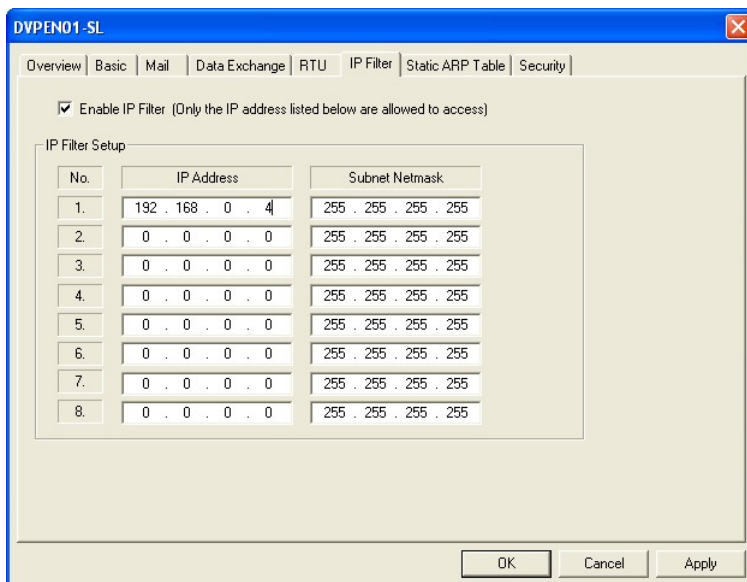

4. Enter "192.168.0.1" in No. 2 IP and "255.255.255.0" in No.2 "Netmask" column. Click on "OK" to complete the setting. Only the equipment within the IP range can be connected.

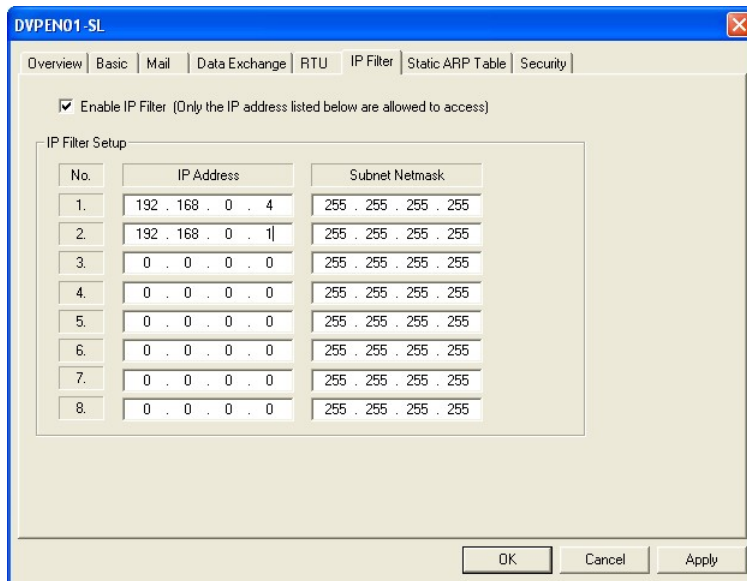

6.6 Setting up Static ARP Table

Application	Setting up static ARP table
Network requirement	(1) MAC address of equipment 192.168.1.6 is 00:18:23:10:00:35 (2) MAC address of equipment 192.168.1.1 is 00:18:23:10:00:04

1. See 6.1 for the connection and how to set up the communication.
2. Open the setup page and switch to “Static ARP Table” page.

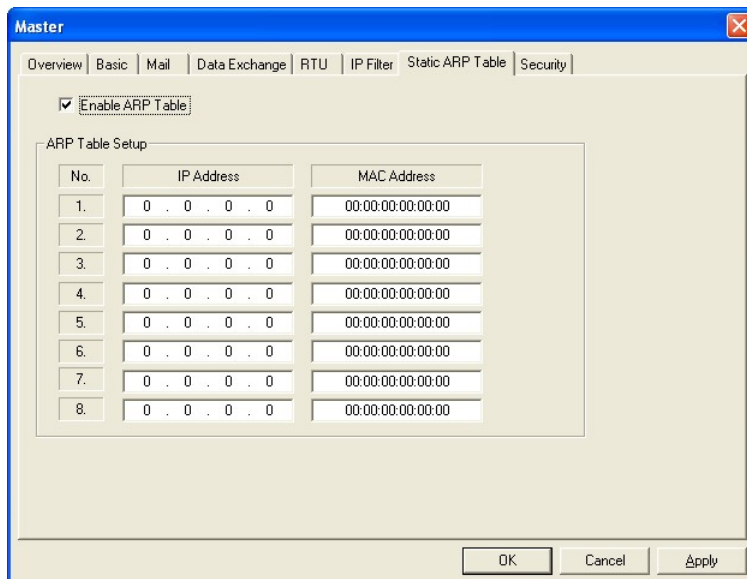

3. Check “Enable ARP Table” box. Enter “192.168.1.6” in No. 1 IP, and its corresponding MAC address is “00:18:23:10:00:35”.

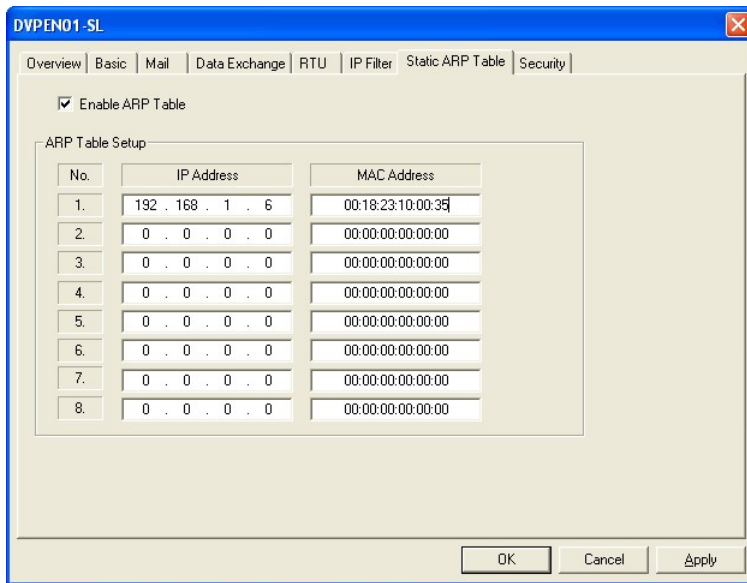

4. Enter “192.168.1.1” in No.2 IP, and its MAC address is “00:18:23:10:00:04”. Click on “OK” to complete the setting. Only the equipment within the IP range can be connected.

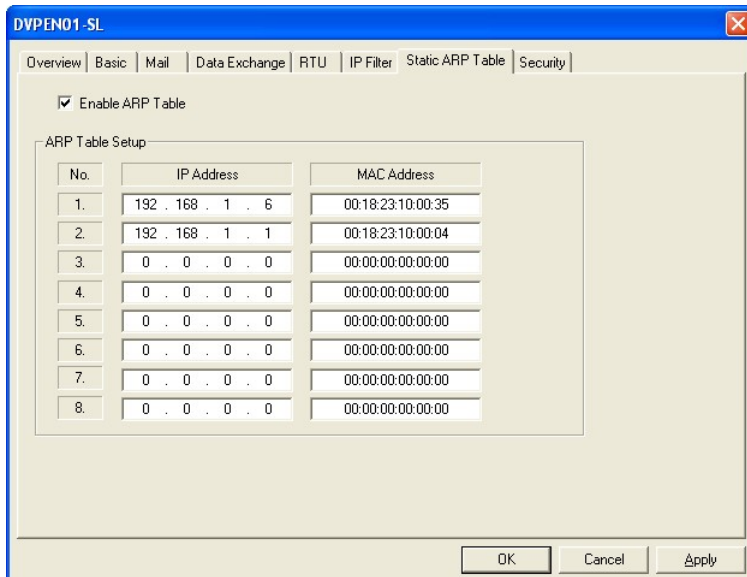

Note:

The MAC address of DVPEN01-SL can be obtained from WPLSoft or the MAC address sticker on the equipment. The MAC address of PC can be found in the “Network Connection Details” (see below).

MAC address



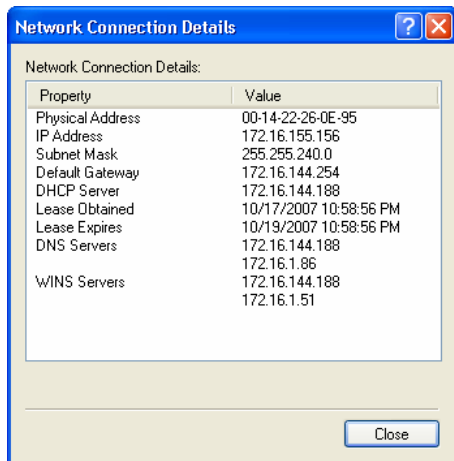

6.7 Application of E-Mail

Application	Sending an E-Mail to notify the administrator when the current status of X0 and Y0 is changed.
Network application	(1) SMTP Server IP: 172.16.144.121 ◦ (2) E-mail address of administrator: test@sample.com (3) An E-mail message will be generated when the status of X0 and Y0 is changed.

1. See 6.1 for the connection and how to set up the communication.
2. Open the setup page and switch to "Mail" page.

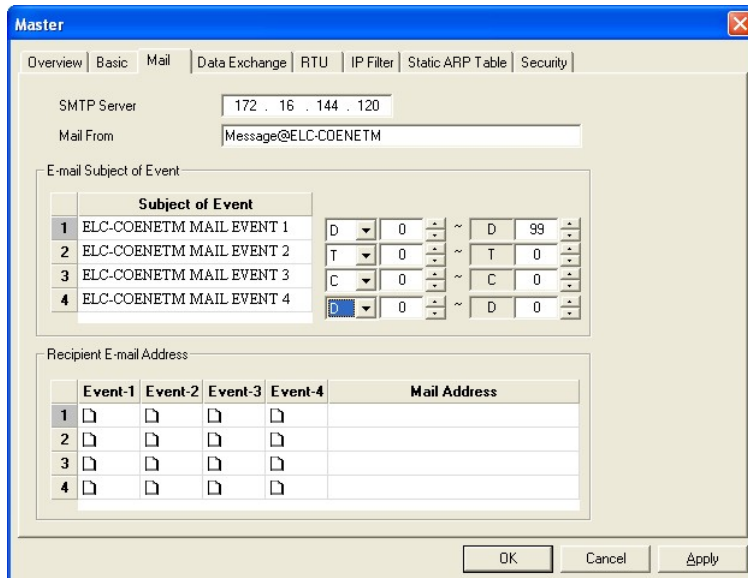

3. In "Subject and Mail" page, enter the address of SMTP server, subject of E-Mail, and E-mail address of the recipient. E-mail address of the recipient, and the present value and the number of data for D, T, C registers.

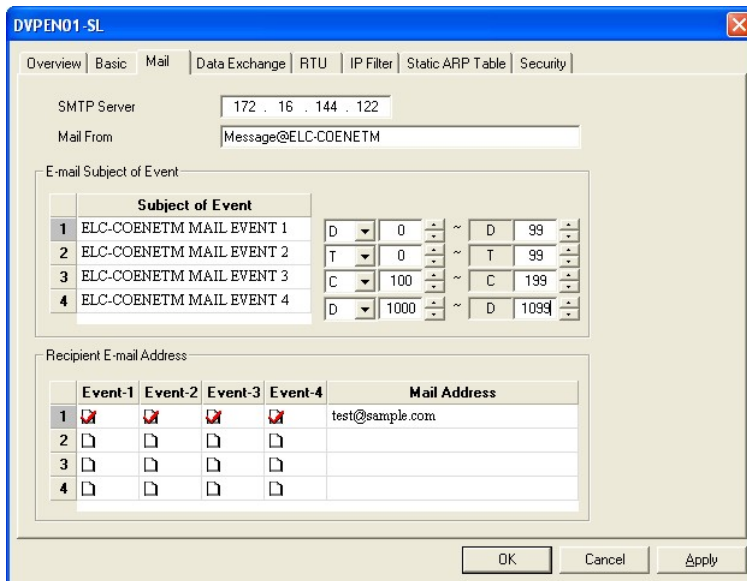

4. Switch to “Select Recipients” page. Check all the boxes of “Recipient 1”. Click on “OK” to complete the setting.
5. After all the settings in DVPEN01-SL are completed, compile the ladder diagram in the MPU and download it to the MPU. See below for the program design:

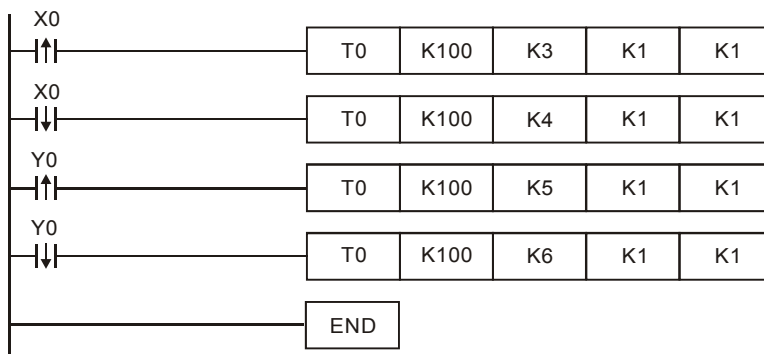

Explanations:

- If the rising-edge of X0 is triggered, X0 will go from Off to On. Write “1” into CR#3 of DVPEN01-SL, and the first E-Mail will be sent out.
- If the falling-edge of X0 is triggered, X0 will go from On to Off. Write “1” into CR#4 of DVPEN01-SL, and the second E-Mail will be sent out.
- If the rising-edge of Y0 is triggered, Y0 will go from Off to On. Write “1” into CR#5 of DVPEN01-SL, and the third E-Mail will be sent out.
- If the falling-edge of Y0 is triggered, Y0 will go from On to Off. Write “1” into CR#6 of DVPEN01-SL, and the fourth E-Mail will be sent out.

6.8 Application of Data Exchange (1)

Application	Writing the time in RTC in PLC_B into D0 ~ D6 of PLC_A
Network requirement	(1) Adopting static IP. (2) IP of PLC_A: 192.168.0.4 (3) IP of PLC_B: 192.168.0.5” (4) Update from PLC_B to PLC_A

1. See 6.1 for how to set up the communication.
2. Open the setup page of PLC_B and switch to “Data Exchange” page.

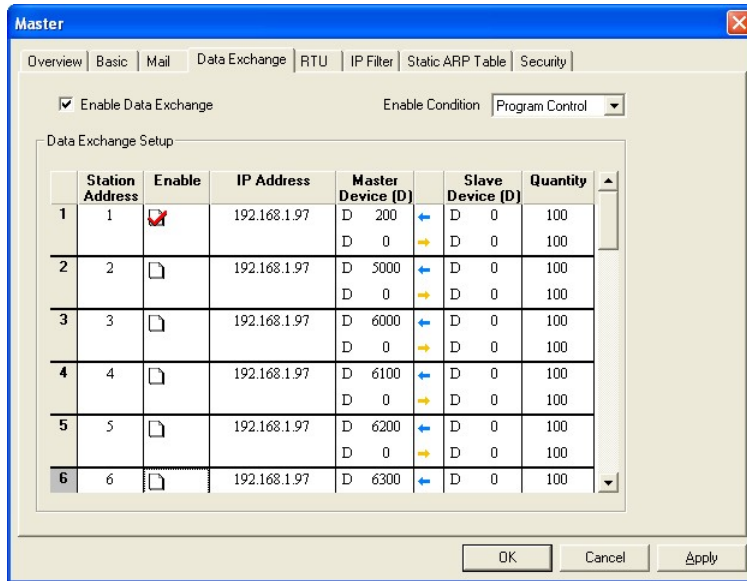

3. Check “Enable Data Exchange” box. Select “Program Control” for Execute Mode. Enter IP address of PLC_A “192.168.0.4” in No. 1 Data Exchange Host IP column. Click on “OK” to complete the setting.

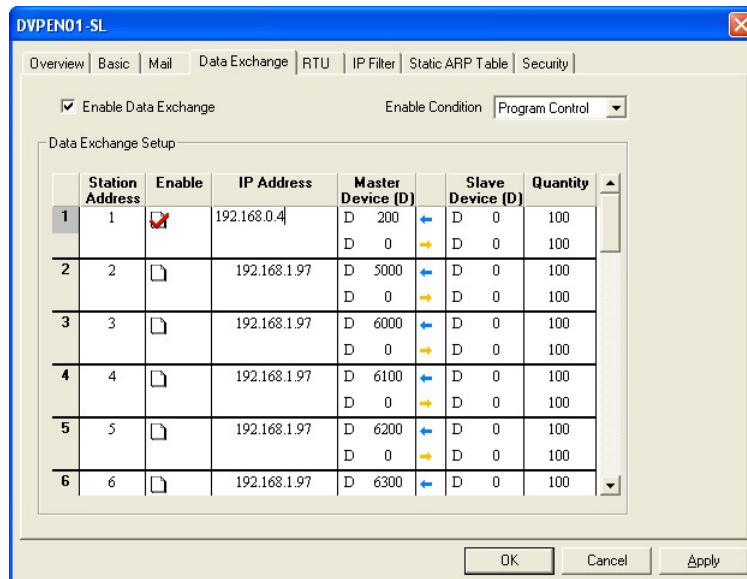

4. After all the settings in PLC_B are completed, compile the ladder diagram in the MPU and download it to PLC_B. See below for the program design:

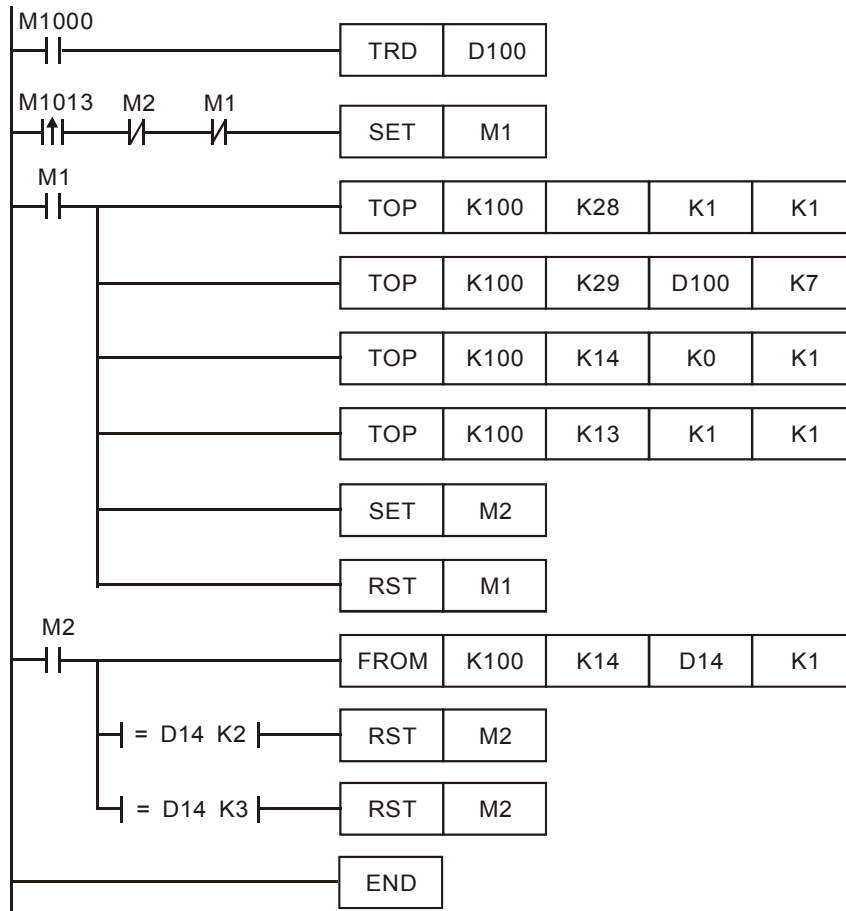

Explanations:

- The data exchange will be executed every one second.
- Write the communication address of the destination PLC in CR#28, and DVPEN01-SL will automatically detect by the previous setting that No. 1 IP is "192.168.0.4".
- Write the data in RTC into CR#29 ~ CR#35.
- Write "1" into CR#13 to start the data exchange.
- CR#14 = 2 refers to successful exchange. CR#14 = 3 refers to failed exchange.

5. Compile the ladder diagram for PLC_A and download it to PLC_A.

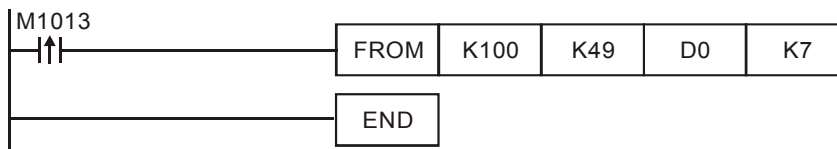

Explanations:

- The received data are stored in CR#49 ~ CR#55.
- The data received every one second are written into D0 ~ D6.

6.9 Application of Data Exchange (2)

Available in firmware V2.0 and later versions

Application	“Always Enable” Data Exchange. Enable a timer and write the timer values into D0 ~ D99. Continue to write the present values in D0 ~ D99 of PLC_A into D0 ~ D99 of PLC_B, and write the values in D0 ~ D99 of PLC-B into D200 ~ D299 of PLC_A.
Network requirement	(1) Adopting static IP. (2) IP of PLC_A: 192.168.1.99 (3) IP of PLC_B: 192.168.1.97 (4) Update from PLC_A to PLC_B and PLC_B to PLC_A.

1. See 6.1 for how to set up the communication.
2. Open the setup page of PLC_A and switch to “Data Exchange” page.

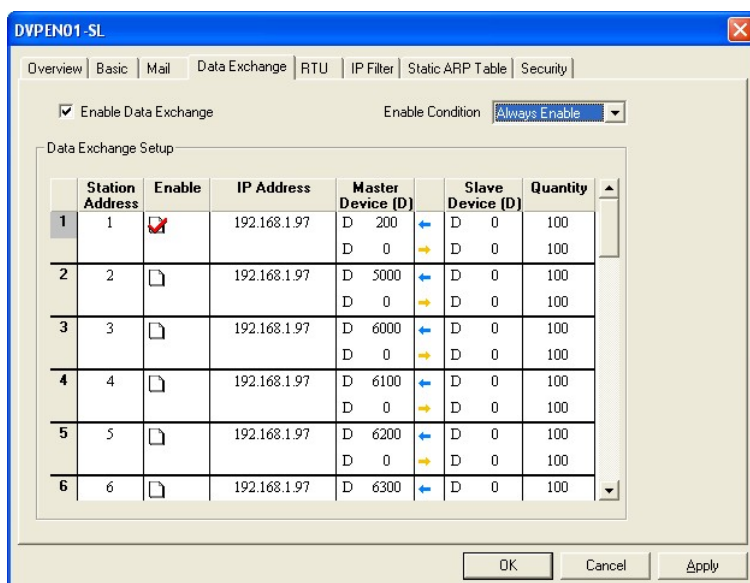

4. Check “Enable Data Exchange” box. Select “Always Enable” for Execute Mode. Enter IP address of PLC_B “192.168.1.97”, D200←D0 Quantity: 100 and D0→D0 Quantity: 100 in No. 1 Data Exchange Host IP column. Click “OK” to complete the setting.

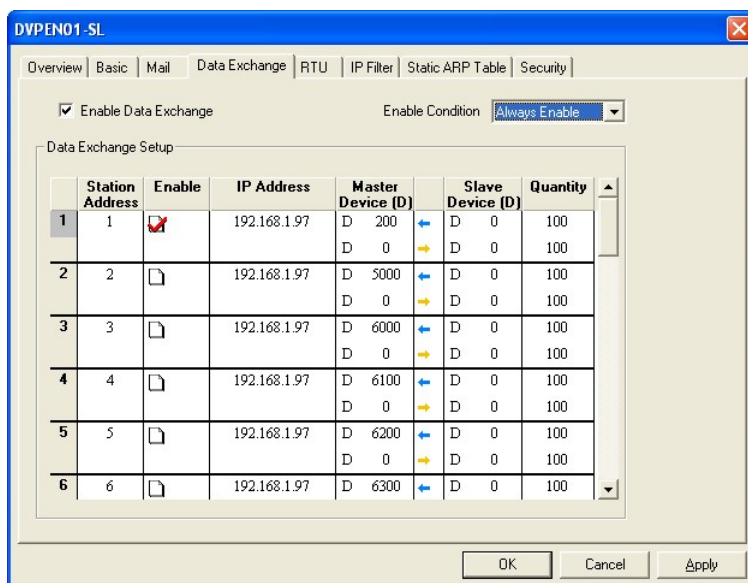

5. After all the settings in PLC_A are completed, compile the ladder diagram in the MPU and download it to PLC_A. See below for the program design:

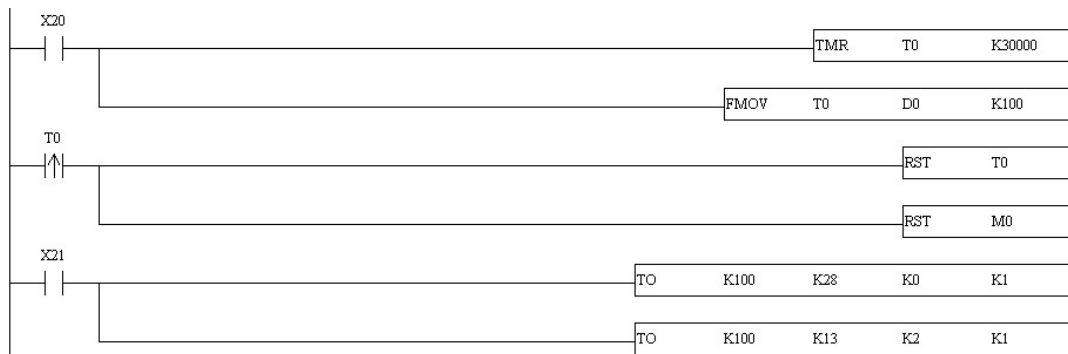

6.10 Application of Data Exchange (3)

Available in firmware V2.0 and later versions

Application	Enable a timer (X20) and write the timer values into D0 ~ D99. Control the program (X21) and write the present values in D0 ~ D99 of PLC_A into D0 ~ D99 of PLC_B, and write the values in D0 ~ D99 of PLC-B into D200 ~ D299 of PLC_A. Control the program (X21) to stop the execution.
Network requirement	(1) Adopting static IP. (2) IP of PLC_A: 192.168.1.99 (3) IP of PLC_B: 192.168.1.97 (4) Update from PLC_A to PLC_B and PLC_B to PLC_A.

1. See 6.1 for how to set up the communication.
2. Open the setup page of PLC_A and switch to “Data Exchange” page.

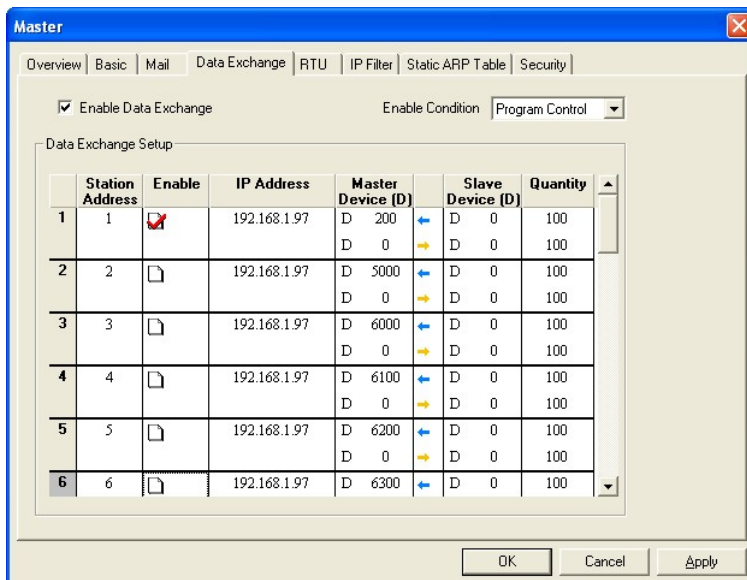

3. Check “Enable Data Exchange” box. Select “Program Control” for Execute Mode. Enter IP address of PLC_B “192.168.1.97”, D200←D0 Quantity: 100 and D0→D0 Quantity: 100 in No. 1 Data Exchange Host IP column. Click “OK” to complete the setting.

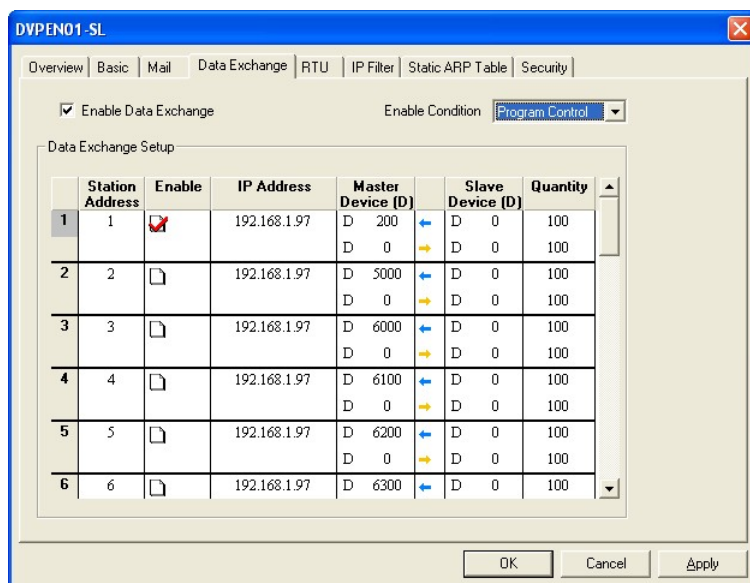

After all the settings in PLC_A are completed, compile the ladder diagram in the MPU and download it to PLC_A. See below for the program design:



6.11 Application of Data Exchange (4)

Application	Writing the time in RTC in PLC_B into D0 ~ D6 of PLC_A by designating IP by ladder diagram.
Network requirement	(1) Adopting static IP. (2) IP of PLC_A: 192.168.0.4 (3) IP of PLC_B: 192.168.0.5 (4) Update from PLC_B to PLC_A

1. See 6.1 for how to set up the communication. Compile the ladder diagram in the MPU and download it to PLC_B. See below for the program design:

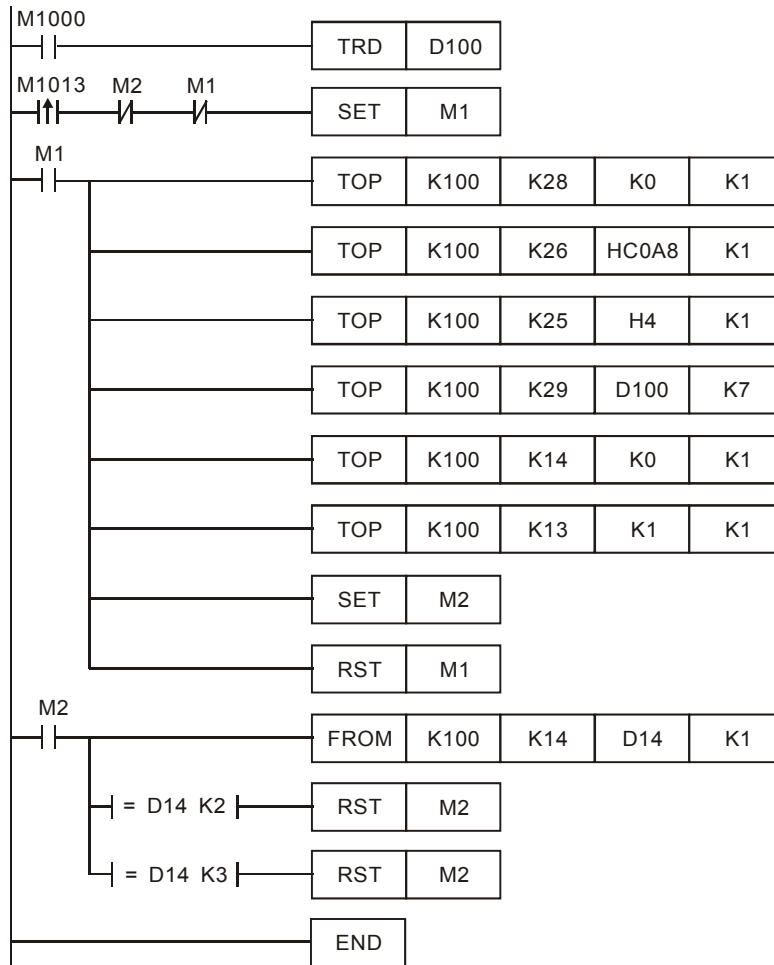

Explanations:

- The data exchange will be executed every one second.
- Write “0” into CR#28, and PLC_B will use CR#25 ~ CR#26 as the IP address of the destination PLC.
- Write the IP address of PLC_A into CR#25 and CR#26. The first two IP codes (192.168 = H’C0A8) should be written into CR#26, and the last two IP codes (0.4 = H’0004) into CR#25.
- Write the data in RTC into CR#29 ~ CR#35.
- Write “1” into CR#13 to start the data exchange.
- CR#14 = 2 refers to successful execution. CR#14 = 3 refers to failed execution.

2. Compile the ladder diagram for PLC_A and download it to PLC_A.

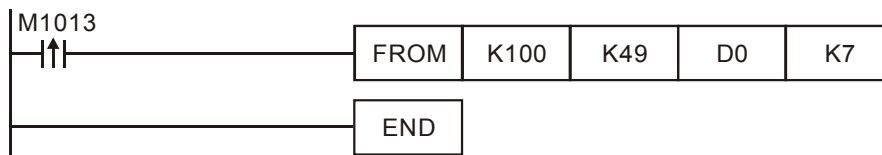

Explanations:

- The received data are stored in CR#49 ~ CR#55.
- The data received every one second are written into D0 ~ D6.

6.12 Application of Data Exchange (5)

Application	Writing the time in RTC in PLC_B directly into D0 ~ D6 of PLC_A without writing in ladder diagram into PLC_A.
Network requirement	(1) Adopting static IP. (2) IP of PLC_A: 192.168.0.4 (3) IP of PLC_B: 192.168.0.5 (4) Update from PLC_B to PLC_A.

1. See 6.1 for how to set up communication.
2. Compile the ladder diagram in the MPU and download it to PLC_B. We do not need to write any corresponding ladder diagram into PLC_A.

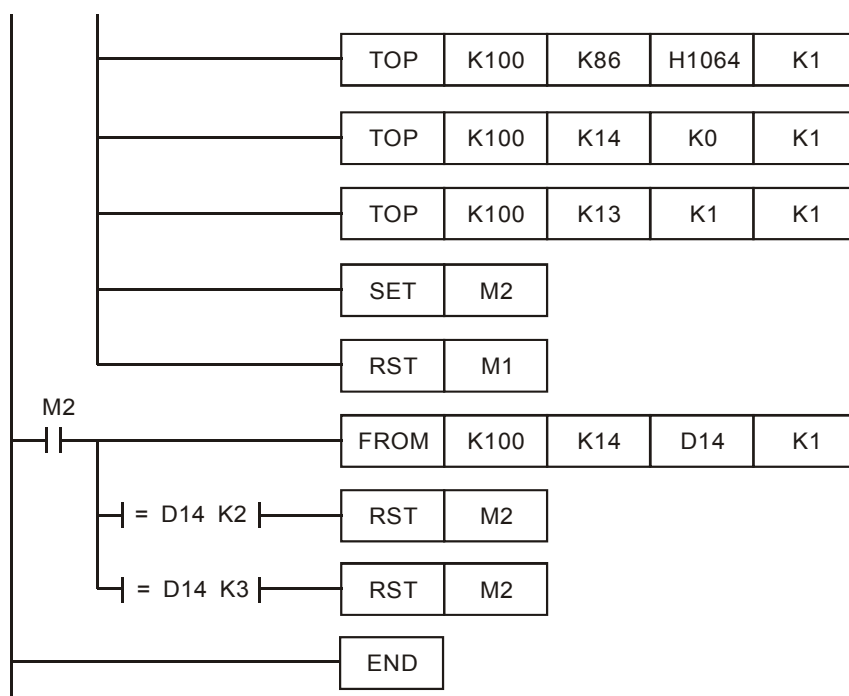
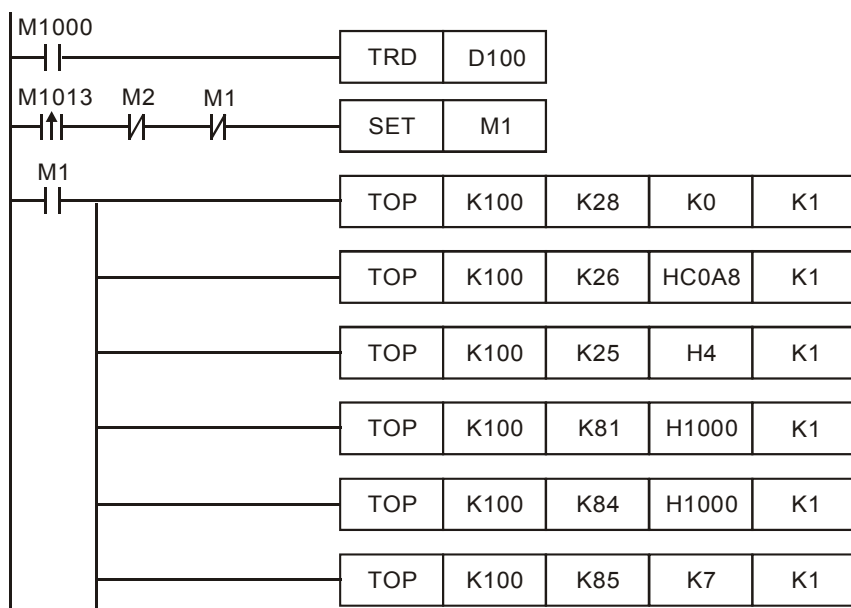

Explanations:

- The data exchange will be executed every one second.

- Write “0” into CR#28, and PLC_B will use CR#25 ~ CR#26 as the IP address of the destination PLC.
- Write the IP address of PLC_A into CR#25 and CR#26. The first two IP codes (192.168 = H’C0A8) should be written into CR#26, and the last two IP codes (0.4 = H’0004) into CR#25.
- Write the Modbus address of D0 (H’1000) in PLC_A into CR#81 and CR#84.
- Write the Modbus address of D100 (register of RTC) (H’1064) into CR#86.
- Write the number of registers K7 into CR#85.
- Write “1” into CR#13 to start the data exchange.
- CR#14 = 2 refers to successful execution. CR#14 = 3 refers to failed execution.
- Once the data exchange is successful, the values in D1313 ~ D1318 in PLC_B will be written into D0 ~ D6 of PLC_A.

6.13 Application of Modbus TCP Master

Application	Compiling Modbus instruction by PLC_B, making Y0 of PLC_A flashing
Network requirement	(1) Adopt static IP. (2) IP of PLC_A: 192.168.0.4 (3) IP of PLC_B: 192.168.0.5 (4) Update from PLC_B to PLC_A (5) Use Modbus instruction 050500FF00 to set “On” Y0. (6) Use Modbus instruction 0505000000 to set “Off” Y0. (7) Y0 goes between On/Off once every one second.

1. See 6.1 for how to set up the communication.
2. Compile the ladder diagram in the MPU and download it to PLC_B. See below for the program design.
We do not need to write any corresponding ladder diagram into PLC_A.

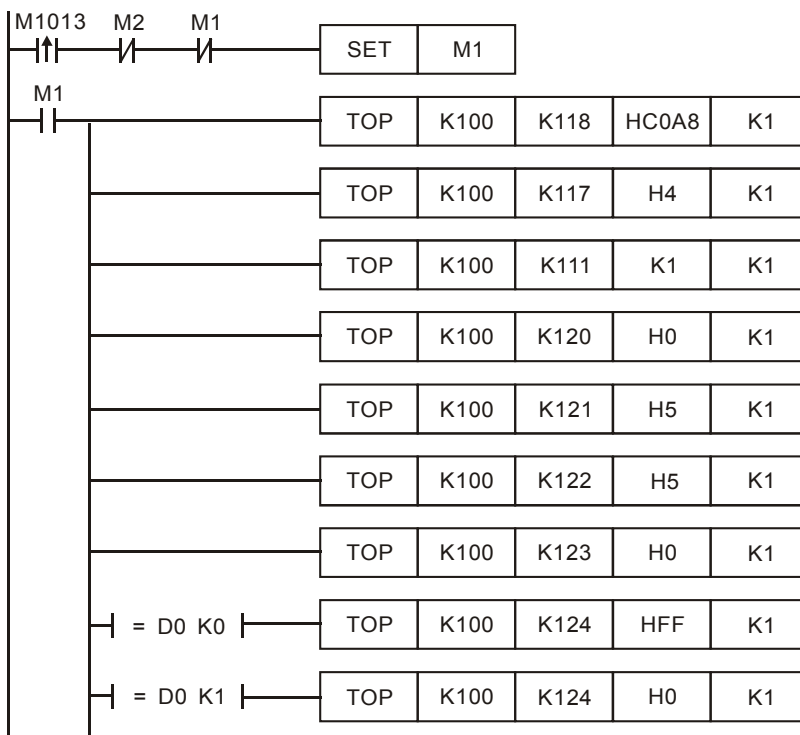

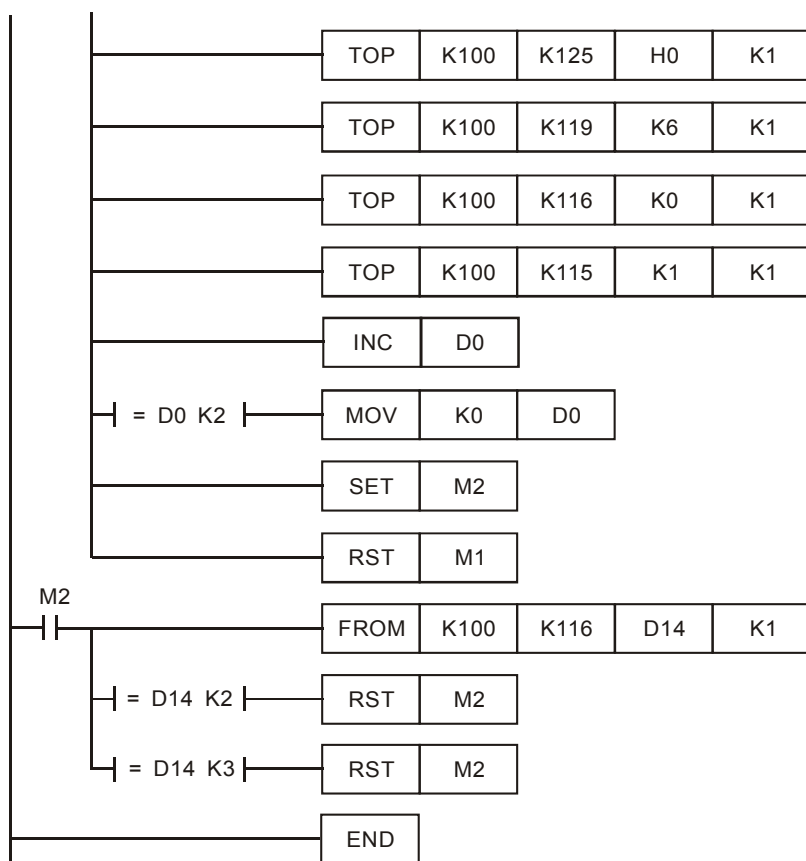

Explanations:

- The data exchange will be executed every one second.
- Write the IP address of PLC_A into CR#117 and CR#118. The first two IP codes (192.168 = H'C0A8) should be written into CR#118, and the last two IP codes (0.4 = H'0004) into CR#117.
- Set CR#111 as "1" to enable the 8-bit mode. The Modbus instruction is stored in the low byte of CR#120 ~ CR#247.
- Write Modbus instruction into CR#120 ~ CR#125. CR#120 is the Modbus address.
- Write the length of the instruction into CR#119.
- Write "1" into CR#115 to start the execution of Modbus TCP instruction.
- CR#116 = 2 refers to successful execution. CR#116 = 3 refers to failed execution.
- If the execution is successful, Y0 on PLC_A will go between On and Off every one second.

6.14 RTU Mapping

Application	Using RTU mapping to read/write the remote digital I/O and analog I/O registers. DVP28SV+DVPEN01-SL → RTU-EN01+DVP06XA+DVP16SP
Network requirement	<ol style="list-style-type: none"> (1) Adopt static IP. (2) IP of DVPEN01-SL: 192.168.1.90 (3) IP of RTU-EN01: 92.168.1.91 (4) Use DCISoft for RTU-EN01 and check 10 mapping data for read and 10 mapping data for write. (5) Set up the mapping start address and number of data for RX, RY, RCR (read) and RCR (write) at DVPEN01-SL. (6) Enable the mapping function in DVP-SV PLC at DVPEN01-SL. Use M2000 and D2000 in DVP-SV to read and M3000 and D3000 to write the value in the remote RTU-EN01.

1. See 6.1 for how to set up the communication.
2. Use DCISoft for RTU-EN01 to set up the mapping CR for read/write.

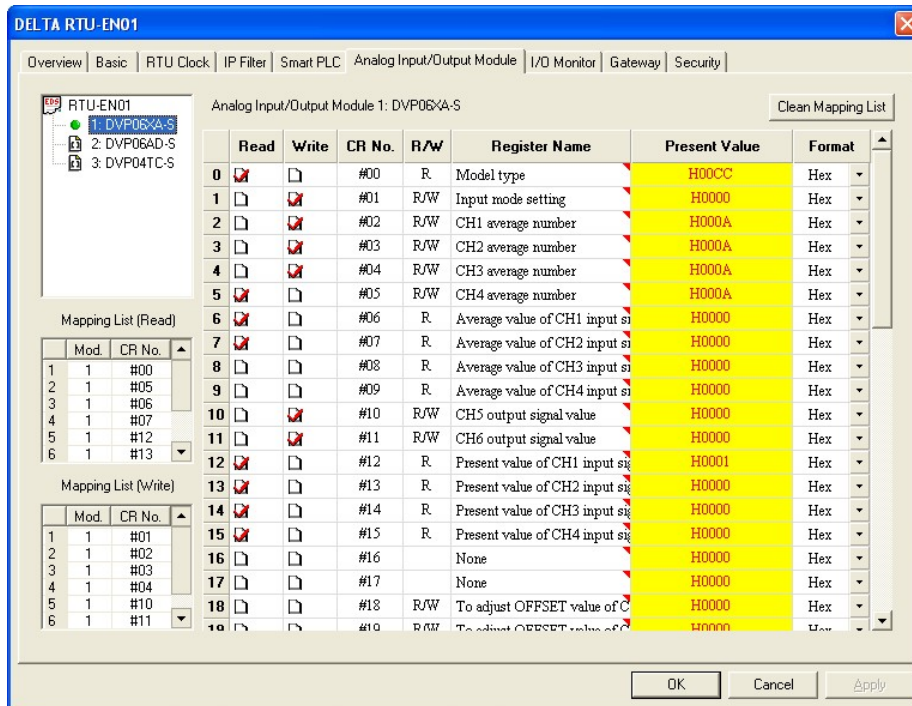

3. Use DCISoft for DVPEN01-SL to set up the mapping start address and number of data. RX: M2000 ~ M2009, RY: M3000 ~ M3009, RCR Read: D2000 ~ D20009, RCR Write: D3000 ~ D3009

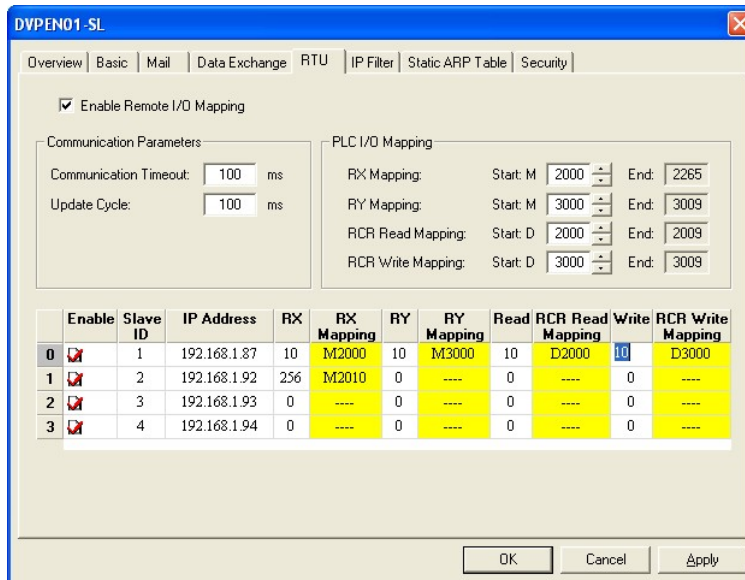

4. Edit the ladder diagram in the MPU and download it to DVPEN01-SL. See the program design as shown below:

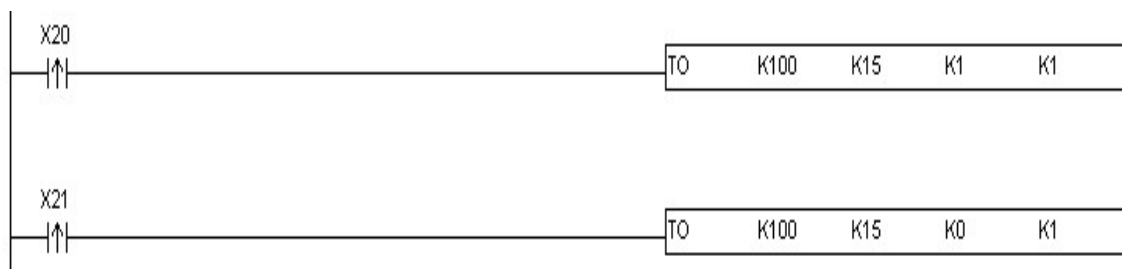

Explanations:

1. Enable mapping: CR15 = 1
2. Disable mapping: CR15 = 0
3. Once CR#15 is enabled, M2000 ~ M2009 and D2000 ~ D2009 will read the data, and M3000 ~ M3009 and D3000 ~ D3009 will read the present value before starting to write.
4. During the execution of mapping, other devices are not allowed to modify the value in the mapped register.

Free Manuals Download Website

<http://myh66.com>

<http://usermanuals.us>

<http://www.somanuals.com>

<http://www.4manuals.cc>

<http://www.manual-lib.com>

<http://www.404manual.com>

<http://www.luxmanual.com>

<http://aubethermostatmanual.com>

Golf course search by state

<http://golfingnear.com>

Email search by domain

<http://emailbydomain.com>

Auto manuals search

<http://auto.somanuals.com>

TV manuals search

<http://tv.somanuals.com>