

# DENON

## AV SURROUND RECEIVER

# AVR-5700

## OPERATING INSTRUCTIONS

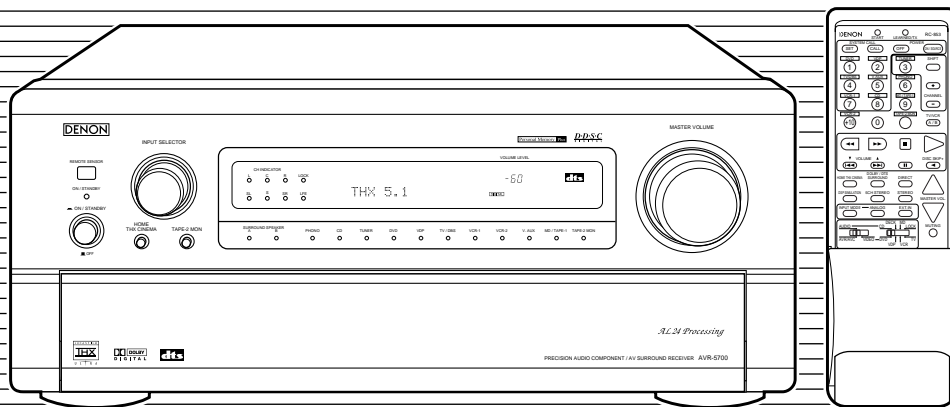

- We greatly appreciate your purchase of the AVR-5700.
- To be sure you take maximum advantage of all the features the AVR-5700 has to offer, read these instructions carefully and use the set properly. Be sure to keep this manual for future reference should any questions or problems arise.

“SERIAL NO. \_\_\_\_\_

PLEASE RECORD UNIT SERIAL NUMBER ATTACHED TO THE REAR OF THE  
CABINET FOR FUTURE REFERENCE”

## SAFETY PRECAUTIONS



**CAUTION**

**RISK OF ELECTRIC SHOCK**

**DO NOT OPEN**



**CAUTION: TO REDUCE THE RISK OF ELECTRIC SHOCK, DO NOT REMOVE COVER (OR BACK). NO USER-SERVICEABLE PARTS INSIDE. REFER SERVICING TO QUALIFIED SERVICE PERSONNEL.**

The lightning flash with arrowhead symbol, within an equilateral triangle, is intended to alert the user to the presence of uninsulated "dangerous voltage" within the product's enclosure that may be of sufficient magnitude to constitute a risk of electric shock to persons.

The exclamation point within an equilateral triangle is intended to alert the user to the presence of important operating and maintenance (servicing) instructions in the literature accompanying the appliance.

**WARNING: TO REDUCE THE RISK OF FIRE OR ELECTRIC SHOCK, DO NOT EXPOSE THIS APPLIANCE TO RAIN OR MOISTURE.**

**CAUTION**

TO PREVENT ELECTRIC SHOCK DO NOT USE THIS (POLARIZED) PLUG WITH AN EXTENSION CORD, RECEPTACLE OR OTHER OUTLET UNLESS THE BLADES CAN BE FULLY INSERTED TO PREVENT BLADE EXPOSURE.

**ATTENTION**





POUR PREVENIR LES CHOCS ELECTRIQUES NE PAS UTILISER CETTE FICHE POLARISEE AVEC UN PROLONGATEUR UNE PRISE DE COURANT OU UNE AUTRE SORTIE DE COURANT, SAUF SI LES LAMES PEUVENT ETRE INSEREES A FOND SANS EN LAISSER AUCUNE PARTIE A DECOUVERT.

This device complies with Part 15 of the FCC Rules. Operation is subject to the following two conditions: (1) This device may not cause harmful interference, and (2) this device must accept any interference received, including interference that may cause undesired operation.

This Class B digital apparatus meets all requirements of the Canadian Interference-Causing Equipment Regulations.

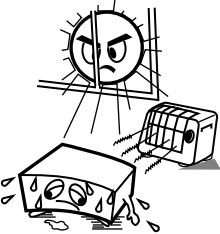
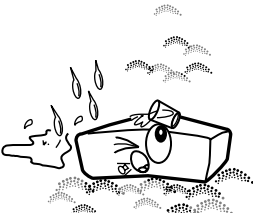
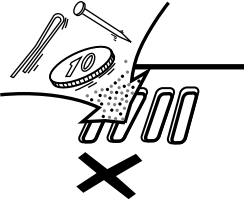
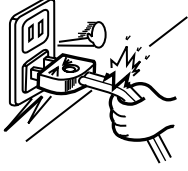
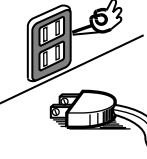
Cet appareil numérique de la classe B respecte toutes les exigences du Règlement sur le matériel brouilleur du Canada.

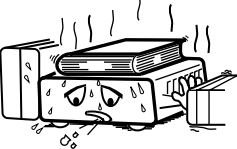
## NOTE ON USE / OBSERVATIONS RELATIVES A L'UTILISATION

 <ul style="list-style-type: none"> <li>Avoid high temperatures. Allow for sufficient heat dispersion when installed on a rack.</li> <li>Eviter des températures élevées. Tenir compte d'une dispersion de chaleur suffisante lors de l'installation sur une étagère.</li> </ul>	 <ul style="list-style-type: none"> <li>Keep the set free from moisture, water, and dust.</li> <li>Protéger l'appareil contre l'humidité, l'eau et la poussière.</li> </ul>	 <ul style="list-style-type: none"> <li>Do not let foreign objects in the set.</li> <li>Ne pas laisser des objets étrangers dans l'appareil.</li> </ul>
 <ul style="list-style-type: none"> <li>Handle the power cord carefully. Hold the plug when unplugging the cord.</li> <li>Manipuler le cordon d'alimentation avec précaution. Tenir la prise lors du débranchement du cordon.</li> </ul>	 <ul style="list-style-type: none"> <li>Unplug the power cord when not using the set for long periods of time.</li> <li>Débrancher le cordon d'alimentation lorsque l'appareil n'est pas utilisé pendant de longues périodes.</li> </ul>	 <ul style="list-style-type: none"> <li>Do not let insecticides, benzene, and thinner come in contact with the set.</li> <li>Ne pas mettre en contact des insecticides, du benzène et un diluant avec l'appareil.</li> </ul>
	 <p style="text-align: center;">* (For sets with ventilation holes)</p> <ul style="list-style-type: none"> <li>Do not obstruct the ventilation holes.</li> <li>Ne pas obstruer les trous d'aération.</li> </ul>	 <ul style="list-style-type: none"> <li>Never disassemble or modify the set in any way.</li> <li>Ne jamais démonter ou modifier l'appareil d'une manière ou d'une autre.</li> </ul>

# SAFETY INSTRUCTIONS

1. Read Instructions – All the safety and operating instructions should be read before the appliance is operated.
2. Retain Instructions – The safety and operating instructions should be retained for future reference.
3. Heed Warnings – All warnings on the appliance and in the operating instructions should be adhered to.
4. Follow Instructions – All operating and use instructions should be followed.
5. Water and Moisture – The appliance should not be used near water – for example, near a bathtub, washbowl, kitchen sink, laundry tub, in a wet basement, or near a swimming pool, and the like.
6. Carts and Stands – The appliance should be used only with a cart or stand that is recommended by the manufacturer.
- 6A. An appliance and cart combination should be moved with care. Quick stops, excessive force, and uneven surfaces may cause the appliance and cart combination to overturn.
7. Wall or Ceiling Mounting – The appliance should be mounted to a wall or ceiling only as recommended by the manufacturer.
8. Ventilation – The appliance should be situated so that its location or position does not interfere with its proper ventilation. For example, the appliance should not be situated on a bed, sofa, rug, or similar surface that may block the ventilation openings; or, placed in a built-in installation, such as a bookcase or cabinet that may impede the flow of air through the ventilation openings.
9. Heat – The appliance should be situated away from heat sources such as radiators, heat registers, stoves, or other appliances (including amplifiers) that produce heat.
10. Power Sources – The appliance should be connected to a power supply only of the type described in the operating instructions or as marked on the appliance.
11. Grounding or Polarization – Precautions should be taken so that the grounding or polarization means of an appliance is not defeated.
12. Power-Cord Protection – Power-supply cords should be routed so that they are not likely to be walked on or pinched by items placed upon or against them, paying particular attention to cords at plugs, convenience receptacles, and the point where they exit from the appliance.
14. Cleaning – The appliance should be cleaned only as recommended by the manufacturer.
15. Power Lines – An outdoor antenna should be located away from power lines.
16. Outdoor Antenna Grounding – If an outside antenna is connected to the receiver, be sure the antenna system is grounded so as to provide some protection against voltage surges and built-up static charges. Article 810 of the National Electrical Code, ANSI/NFPA 70, provides information with regard to proper grounding of the mast and supporting structure, grounding of the lead-in wire to an antenna-discharge unit, size of grounding conductors, location of antenna-discharge unit, connection to grounding electrodes, and requirements for the grounding electrode. See Figure A.
17. Nonuse Periods – The power cord of the appliance should be unplugged from the outlet when left unused for a long period of time.
18. Object and Liquid Entry – Care should be taken so that objects do not fall and liquids are not spilled into the enclosure through openings.
19. Damage Requiring Service – The appliance should be serviced by qualified service personnel when:
  - A. The power-supply cord or the plug has been damaged; or
  - B. Objects have fallen, or liquid has been spilled into the appliance; or
  - C. The appliance has been exposed to rain; or
  - D. The appliance does not appear to operate normally or exhibits a marked change in performance; or
  - E. The appliance has been dropped, or the enclosure damaged.
20. Servicing – The user should not attempt to service the appliance beyond that described in the operating instructions. All other servicing should be referred to qualified service personnel.

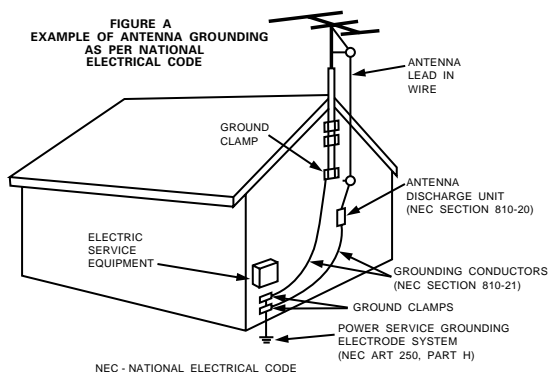

## ■ INTRODUCTION

Thank you for choosing the DENON AVR-5700 Digital Surround A / V receiver. This remarkable component has been engineered to provide superb surround sound listening with home theater sources such as DVD, as well as providing outstanding high fidelity reproduction of your favorite music sources. As this product is provided with an immense array of features, we recommend that before you begin hookup and operation that you review the contents of this manual before proceeding.

## TABLE OF CONTENTS

<b>1</b> Before Using .....4	<b>10</b> Surround .....43~47
<b>2</b> Cautions on Installation .....4	<b>11</b> DSP Surround Simulation .....48~51
<b>3</b> Cautions on Handling .....5	<b>12</b> Listening to the Radio .....52~54
<b>4</b> Features .....5	<b>13</b> Last Function Memory .....54
<b>5</b> Connections .....6~13	<b>14</b> Initialization of the Microprocessor .....54
<b>6</b> Part Names and Functions .....14, 15	<b>15</b> Troubleshooting .....55
<b>7</b> Setting up the system .....16~27	<b>16</b> Additional Information .....56~61
<b>8</b> Remote Control Unit .....28~36	<b>17</b> Specifications .....62
<b>9</b> Operation .....36~42	

## ■ ACCESSORIES

Check that the following parts are included in addition to the main unit:

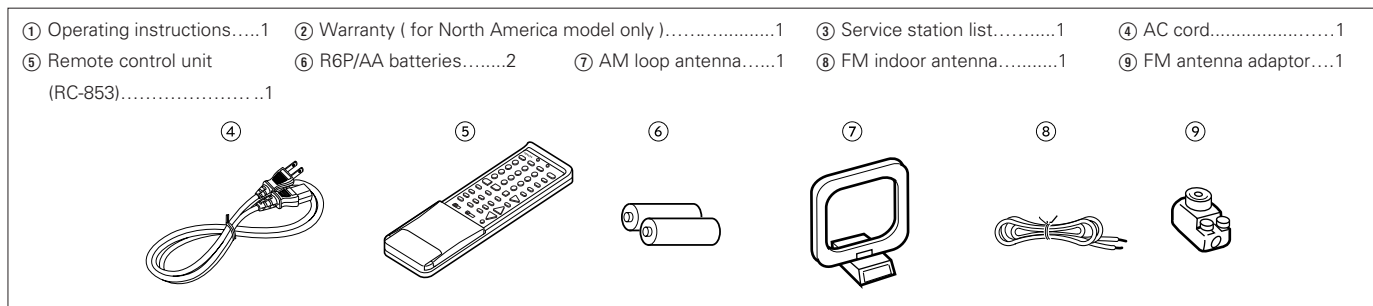

## 1 BEFORE USING

Pay attention to the following before using this unit:

- **Moving the set**  
To prevent short circuits or damaged wires in the connection cords, always unplug the power cord and disconnect the connection cords between all other audio components when moving the set.
- **Before turning the power switch on**  
Check once again that all connections are proper and that there are not problems with the connection cords. Always set the power switch to the standby position before connecting and disconnecting connection cords.

- **Store this instructions in a safe place.**  
After reading, store this instructions along with the warranty in a safe place.
- **Note that the illustrations in this instructions may differ from the actual set for explanation purposes.**

## 2 CAUTIONS ON INSTALLATION

Noise or disturbance of the picture may be generated if this unit or any other electronic equipment using microprocessors is used near a tuner or TV.

If this happens, take the following steps:

- Install this unit as far as possible from the tuner or TV.
- Set the antenna wires from the tuner or TV away from this unit's power cord and input/output connection cords.
- Noise or disturbance tends to occur particularly when using indoor antennas or 300 Ω/ohms feeder wires. **We recommend using outdoor antennas and 75 Ω/ohms coaxial cables.**

**For heat dispersal, leave at least 10 cm of space between the top, back and sides of this unit and the wall or other components.**

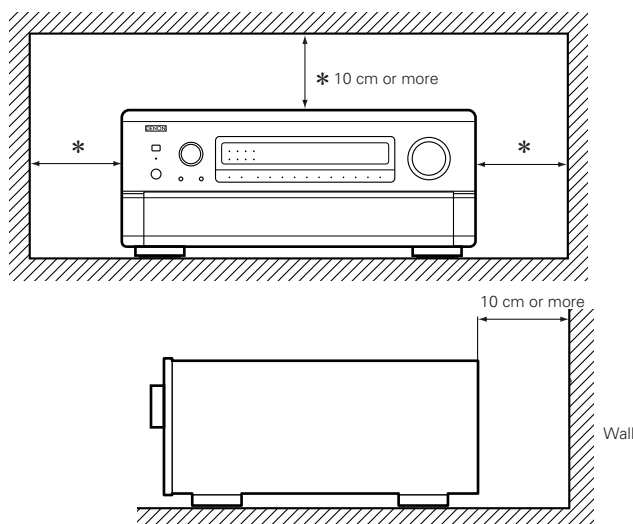

### 3 CAUTIONS ON HANDLING

- **Switching the input function when input jacks are not connected**

A clicking noise may be produced if the input function is switched when nothing is connected to the input jacks. If this happens, either turn down the MASTER VOLUME control or connect components to the input jacks.

- **Muting of PRE OUT jacks and SPEAKER terminals**

The PRE OUT jacks and SPEAKER terminals include a muting circuit. Because of this, the output signals are greatly reduced for several seconds after the power switch is turned on or input function, surround mode or any other-set-up is changed. If the volume is turned up during this time, the output will be very high after the muting circuit stops functioning. Always wait until the muting circuit turns off before adjusting the volume.

- **Whenever the power switch is in the OFF state, the apparatus is still connected on AC line voltage. Please be sure to unplug the cord when you leave home for, say, a vacation.**

- **Opening and closing the door**

**This unit has a door on the front panel.**

**Lightly press on the bottom of the door to open it.**

### 4 FEATURES

1. **Digital Surround Sound Decoding**

Featuring dual 32 bit high speed DSP processors, operating entirely in digital domain, surround sound from digital sources such as DVD, LD, DTV and satellite are faithfully re-created.

2. **Dolby Digital**

Using advanced digital processing algorithms, Dolby Digital provides up to 5.1 channels of wide-range, high fidelity surround sound. Dolby Digital is the default digital audio delivery system for North American DVD and DTV, and is available on laser discs as well as some digital satellite direct-to-home services.

3. **DTS (Digital Theater Systems)**

DTS provides up to 5.1 channels of wide-range, high fidelity surround sound, from sources such as laser disc, DVD and specially-encoded music discs.

4. **Lucasfilm Home THX Ultra Certified**

Home THX is the unique collaboration between Lucasfilm Ltd. and audio equipment manufacturers. THX Ultra certification is the highest performance level, and provides a rigorous set of performance standards, along with proprietary surround sound post-processing technologies, designed to enhance the surround soundtrack playback experience in the home theater.

5. **24 bit D/A Conversion**

All six channels, including the five main channels and the low frequency effects (LFE) channel benefit from reference Burr-Brown DACs, for optimum high fidelity reproduction of music and movie soundtracks.

6. **24 Bit AL Processing**

A feature of DENON's premium CD players, Alpha processing is a proprietary DSP function that provides increased definition of detail. The latest 24 bit Alpha processing technology is applied to the two main front channels (left and right) for superb reproduction of high fidelity music sources.

7. **Dual Surround Speaker Mode**

Provides for the first time the ability to optimize surround sound reproduction using two different types of surround sound speakers as well as two different surround speaker positions:

- (1) **Movie Surround**

Motion picture soundtracks use the surround channel(s) to provide the ambient elements of the acoustic environment they want the audience to realize. This is best accomplished by the use of specially-designed surround speakers that offer a wide diffusion pattern (bipolar dispersion) or by using surround speakers that provide broad dispersion with a minimum of on-axis localization (dipolar dispersion). Side wall mounting (closer to the ceiling) of the surround speakers provides the greatest envelopment, minimizing localization of direct sound from the speakers.

- (2) **Music Surround**

With full range discrete surround channels, as well as three discrete full range front channels, digital formats such as Dolby and DTS offer thrilling surround sound music listening. Producers of multi-channel discrete digital music recordings almost always favor the use of direct radiating (monopolar) surround speakers, placed in the rear corners of the room, since that is how they configure their studios during the mixing/creation process.

The DENON AVR-5700 provides the ability to connect two different sets of surround speakers, and place them in the appropriate locations in your home theater room, so that you can enjoy both movie soundtracks and music listening, with optimum results and no compromise.

8. **Component Video Switching**

In addition to composite video and "S" video switching, the AVR-5700 provides 2 sets of component video (Y, R-Y, B-Y) inputs for the DVD and TV/DBS inputs, and one set of component video outputs to the television, for superior picture quality.

9. **Video Select Function**

Allow you to watch one source (visual) while listening to another source (audio).

- **Five Identical Power Amplifiers**

Featuring discrete high current power transistors, the power amp section is THX Ultra certified for top performance with the widest range of speaker systems. Rated at 140 watts into 8  $\Omega$ /ohms, the amp channels feature additional low impedance drive capability.

10. **Future Sound Format Upgrade Capability via Eight Channel Inputs & Outputs**

For future multi-channel audio format(s), the AVR-5700 is provided with 7.1 channel (seven main channels, plus one low frequency effects channel) inputs, along with a full set of 7.1 channel pre-amp outputs, controlled by the 8 channel master volume control. This assures future upgrade possibilities for any future multi-channel sound format.

## 5 CONNECTIONS

- Do not plug in the AC cord until all connections have been completed.
- Be sure to connect the left and right channels properly (left with left, right with right).
- Insert the plugs securely. Incomplete connections will result in the generation of noise.
- Use the AC OUTLETS for audio equipment only. Do not use them for hair driers, etc.
- Note that binding pin plug cords together with AC cords or placing them near a power transformer will result in generating hum or other noise.
- Noise or humming may be generated if a connected audio equipment is used independently without turning the power of this unit on. If this happens, turn on the power of this unit.

### Connecting the audio components

- When making connections, also refer to the operating instructions of the other components.

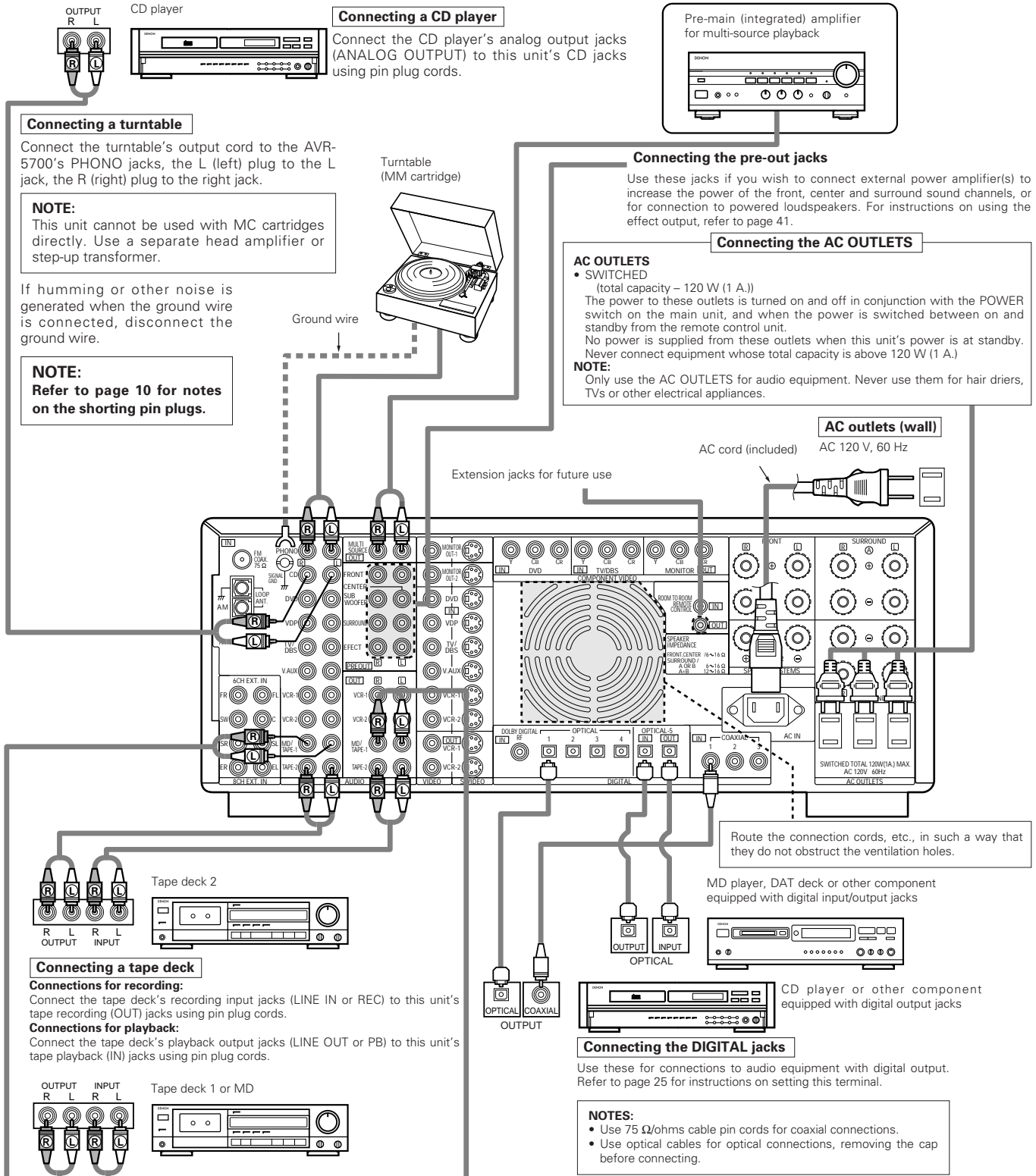

## Connecting video components

- To connect the video signal, connect using a 75 Ω/ohms video signal cable cord. Using an improper cable can result in a drop in sound quality.
- When making connections, also refer to the operating instructions of the other components.

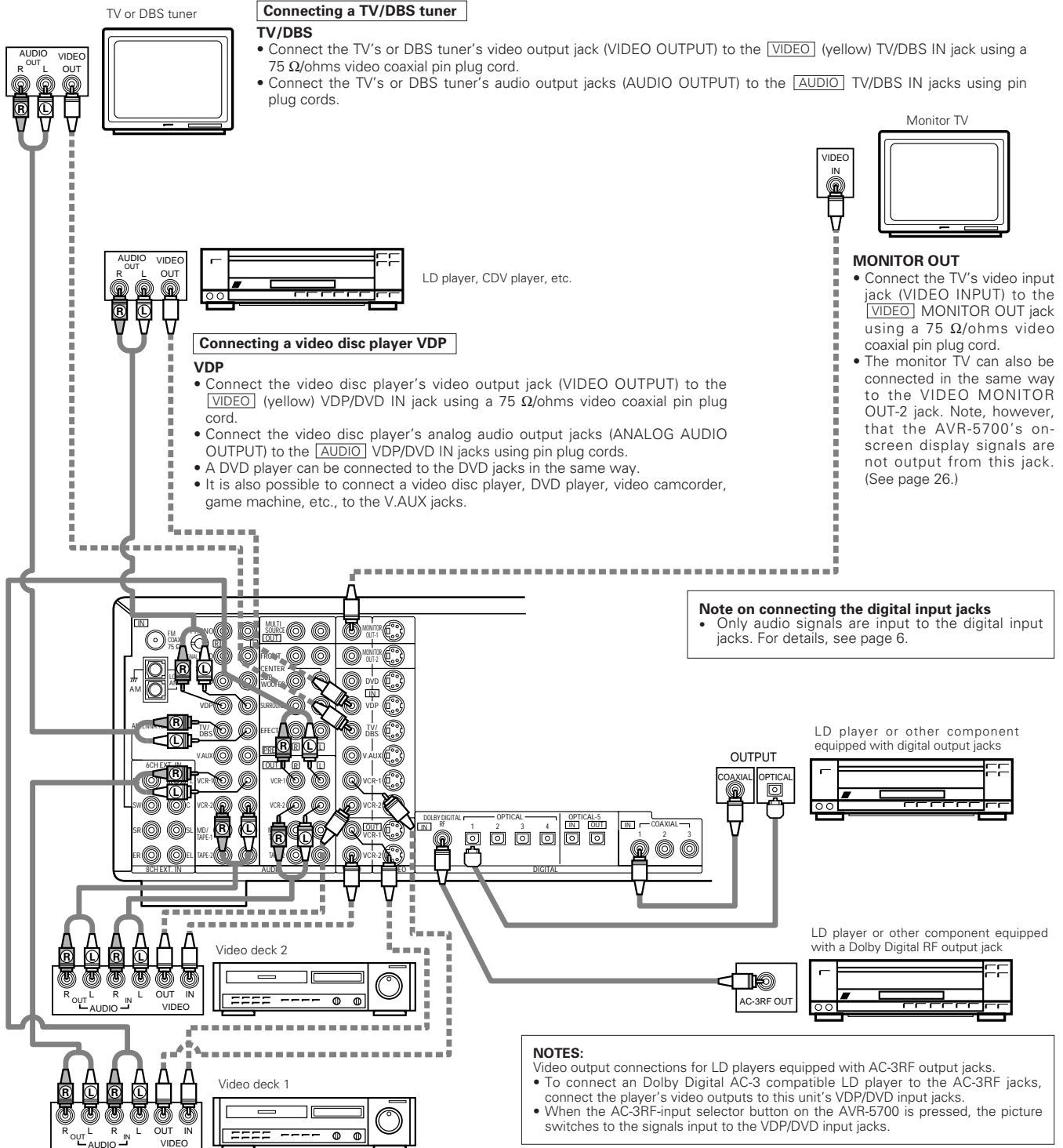

### Connecting a video decks

- There are two sets of video deck (VCR) jacks, so two video decks can be connected for simultaneous recording or video copying.

#### Video input/output connections:

- Connect the video deck's video output jack (VIDEO OUT) to the **VIDEO** (yellow) VCR-1 IN jack, and the video deck's video input jack (VIDEO IN) to the **VIDEO** (yellow) VCR-1 OUT jack using 75 Ω/ohms video coaxial pin plug cords.

#### Connecting the audio output jacks

- Connect the video deck's audio output jacks (AUDIO OUT) to the **AUDIO** VCR-1 IN jacks, and the video deck's audio input jacks (AUDIO IN) to the **AUDIO** VCR-1 OUT jacks using pin plug cords.

\* Connect the second video deck to the VCR-2 jacks in the same way.

## Connecting a video component equipped with S-Video jacks

- When making connections, also refer to the operating instructions of the other components.

- **A note on the S input jacks**

The input selectors for the S inputs and pin jack inputs work in conjunction with each other.

- **Precaution when using S-jacks**

This unit's S-jacks (input and output) and video pin jacks (input and output) have independent circuit structures, so that video signals input from the S-jacks are only output from the S-jack outputs and video signals input from the pin jacks are only output from the pin jack outputs.

When connecting this unit with equipment that is equipped with S-jacks, keep the above point in mind and make connections according to the equipment's instruction manuals.

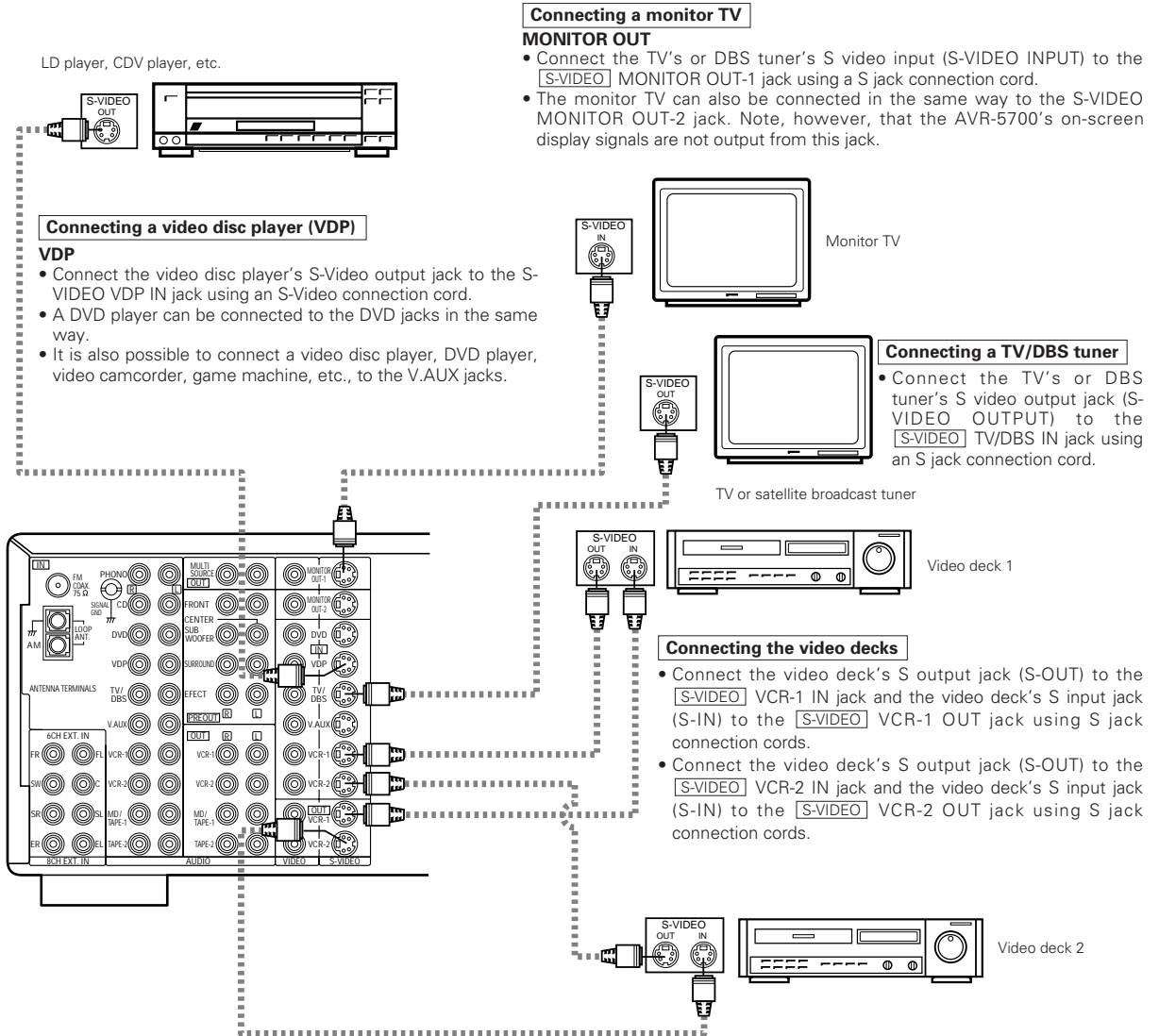

Connect the components' audio inputs and outputs as described on page 6.

### NOTES:

- The on-screen display signals are not output from the video signal MONITOR OUT-2 (yellow) or S-Video signal MONITOR OUT-2 jack.
- The on-screen display signals are not output from the color difference (component) video signal MONITOR OUT jacks.





## Connecting a Video Component Equipped with Color Difference (Component - Y, R-Y, B-Y) Video Jacks (DVD Player)

- When making connections, also refer to the operating instructions of the other components.
- The signals input to the color difference (component) video jacks are not output from the VIDEO output jack (yellow) or the S-Video output jack. In addition, the video signals input to the VIDEO input (yellow) and S-Video input jacks are not output to the color difference (component) video jacks.
- The AVR-5700's on-screen display signals are not output from the color difference (component) video output jacks (MONITOR OUT).
- Some video sources with component video outputs are labeled Y, Pb, Pr, or Y, Cb, Cr, or Y, R-Y, B-Y. These terms all refer to component video color difference output.

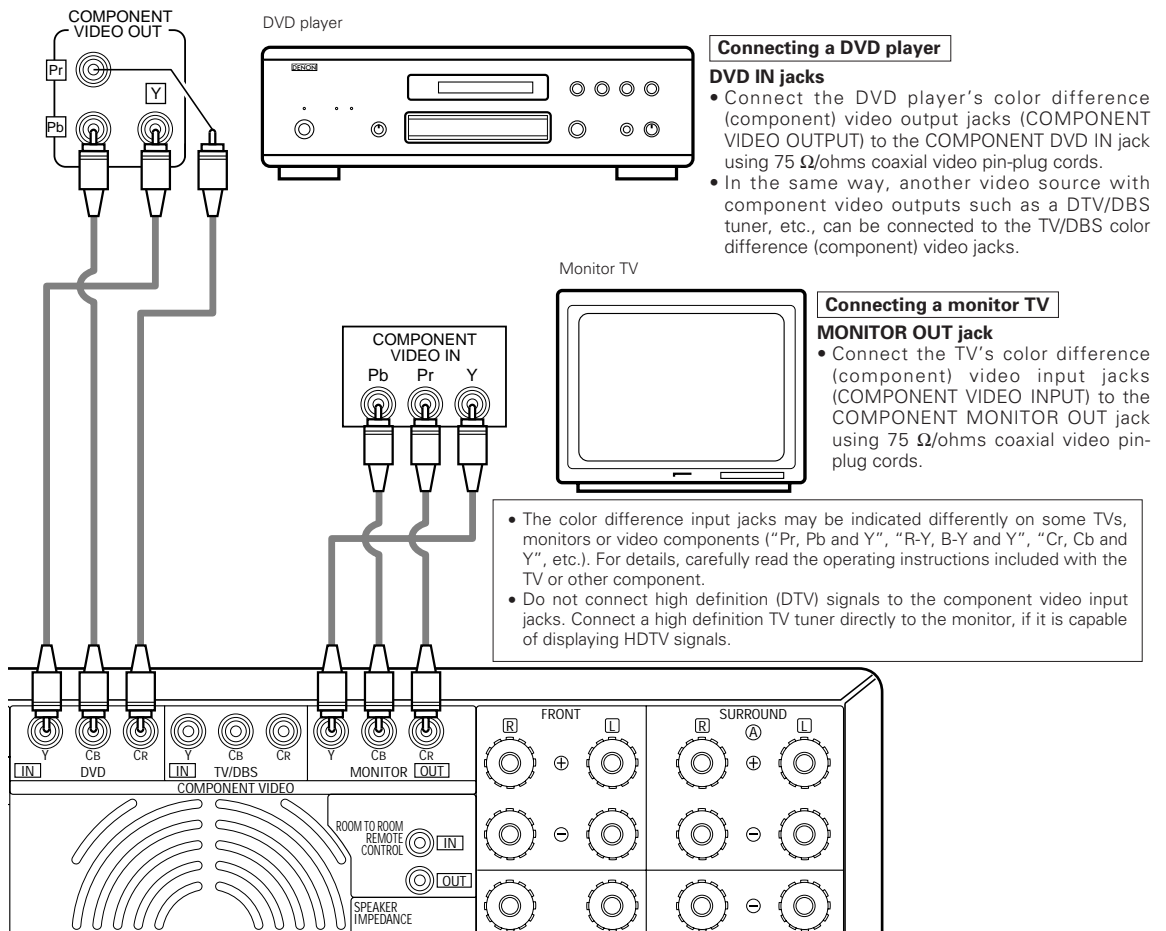

### NOTES (refer to page 6)

- Shorting pin plugs are inserted into the PHONO input jacks to prevent noise if the PHONO input is selected and there is no turntable connected. Remove these pin plugs when connecting a turntable.
- DO NOT insert the shorting pin plugs into the REC (recording output) or pre-out jacks. Doing so may cut off the sound and may damage the AVR-5700 and connected components.

## Connecting the external input (EXT. IN) jacks

- These input jacks are for inputting multi-channel audio signals in high definition MUSE 3-1 format, multi-channel audio signals from an MPEG multi-channel decoder, or future multi-channel sound format, etc.
- When making connections, also refer to the operating instructions of the other components.

When connecting a high definition (MUSE 3-1 format) component, use a separately sold mono/stereo cable if the surround channel output is monaural.

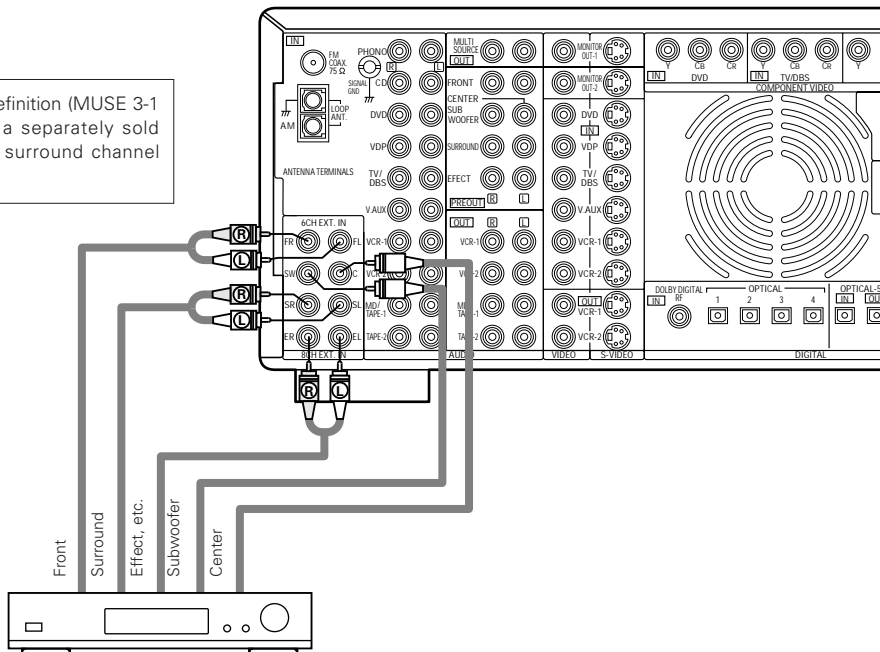

Decoder with 8- or 6-channel analog output

\* For instructions on playback using the external input (EXT. IN) jacks, see page 41.

## Connecting the MULTI SOURCE jacks

- If another pre-main (integrated) amplifier is connected, the multi-source jacks can be used to play a different program source in another room at the same time. (See page 40.)

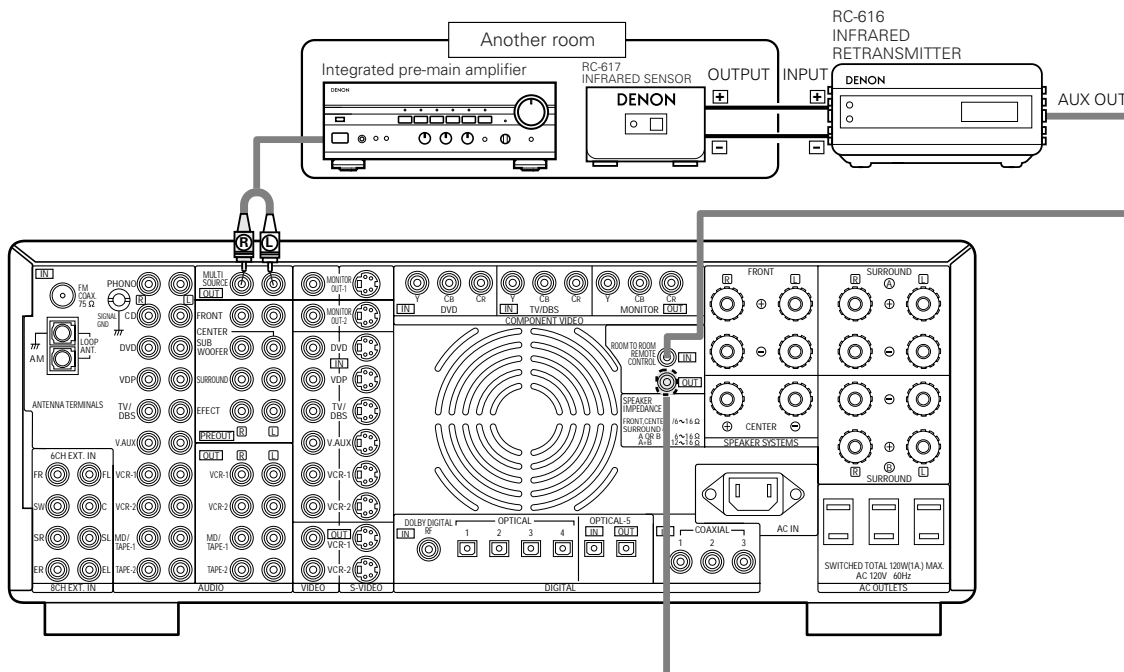

Extension jacks for future use.

\* For instructions on operations using the MULTI SOURCE jacks, see page 42 or page 40.

## Speaker system connections

- Connect the speaker terminals with the speakers making sure that like polarities are matched (⊕ with ⊕, ⊖ with ⊖). Mismatching of polarities will result in weak central sound, unclear orientation of the various instruments, and the sense of direction of the stereo being impaired.
- When making connections, take care that none of the individual conductors of the speaker cord come in contact with adjacent terminals, with other speaker cord conductors, or with the rear panel.

### NOTE:

**NEVER touch the speaker terminals when the power is on. Doing so could result in electric shocks.**

### Speaker Impedance

- Speakers with an impedance of from 6 to 16 Ω/ohms can be connected for use as front and center speakers.
- Be careful when using two pairs of surround speakers (A + B) at the same time, since use of speakers with an impedance of 12 to 16 Ω/ohms will lead to damage.
- Speakers with an impedance of 6 to 16 Ω/ohms can be connected for use as surround speakers.
- The protector circuit may be activated if the set is played for long periods of time at high volumes when speakers with an impedance lower than the specified impedance are connected.

### Connecting the speaker cords

1. Loosen by turning counterclockwise.

2. Insert the cord.

3. Tighten by turning clockwise.

Either tightly twist or terminate the core wires.

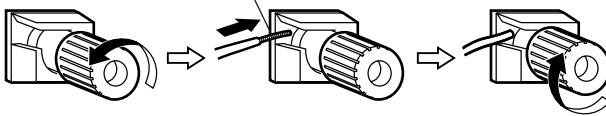

### Connecting banana plugs

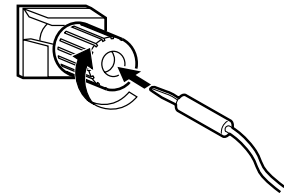

Turn clockwise to tighten, then insert the banana plug.

### Connections

- When making connections, also refer to the operating instructions of the other components.

Connection jack for subwoofer with built-in amplifier (super woofer), etc.

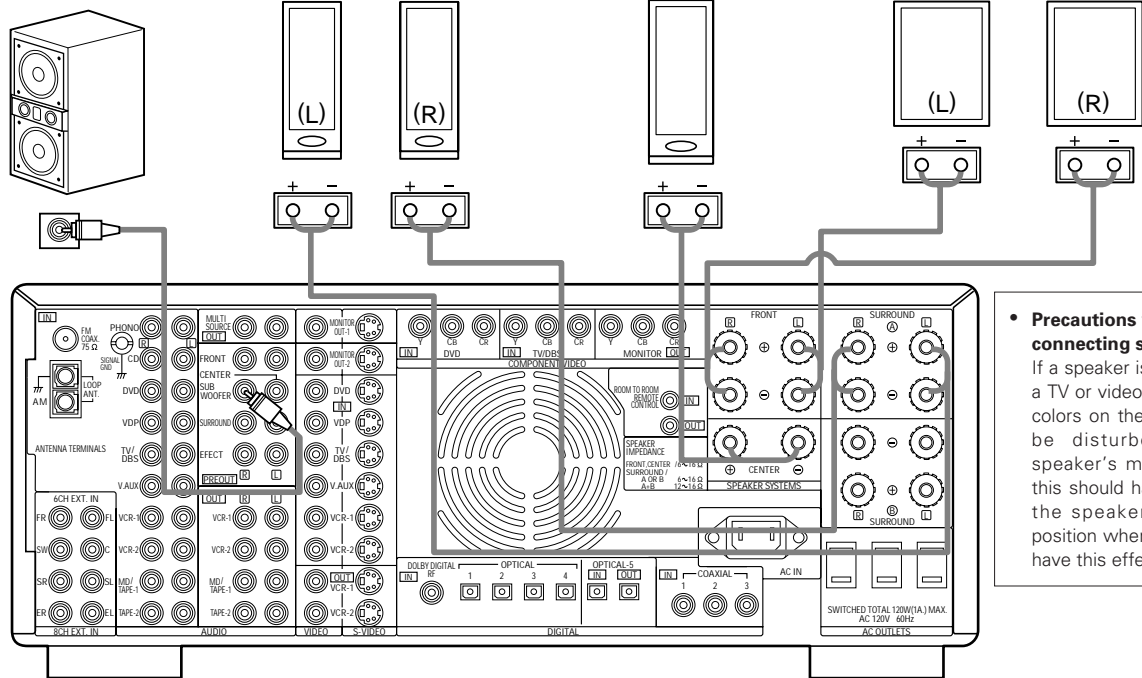

**• Precautions when connecting speakers**  
If a speaker is placed near a TV or video monitor, the colors on the screen may be disturbed by the speaker's magnetism. If this should happen, move the speaker away to a position where it does not have this effect.

### **Protector circuit**

- This unit is equipped with a high-speed protection circuit. The purpose of this circuit is to protect the speakers under circumstances such as when the output of the power amplifier is inadvertently short-circuited and a large current flows, when the temperature surrounding the unit becomes unusually high, or when the unit is used at high output over a long period which results in an extreme temperature rise.

When the protection circuit is activated, the speaker output is cut off and the power supply indicator LED flashes. Should this occur, please follow these steps: be sure to switch off the power of this unit, check whether there are any faults with the wiring of the speaker cables or input cables, and wait for the unit to cool down if it is very hot. Improve the ventilation condition around the unit and switch the power back on.

If the protection circuit is activated again even though there are no problems with the wiring or the ventilation around the unit, switch off the power and contact a DENON service center.

### **Note on speaker impedance**

- The protector circuit may be activated if the set is played for long periods of time at high volumes when speakers with an impedance lower than the specified impedance (for example speakers with an impedance of lower than 4  $\Omega$ /ohms) are connected. If the protector circuit is activated, the speaker output is cut off. Turn off the set's power, wait for the set to cool down, improve the ventilation around the set, then turn the power back on.

## 6 PART NAMES AND FUNCTIONS

### Front Panel

- For details on the functions of these parts, refer to the pages given in parentheses ( ).

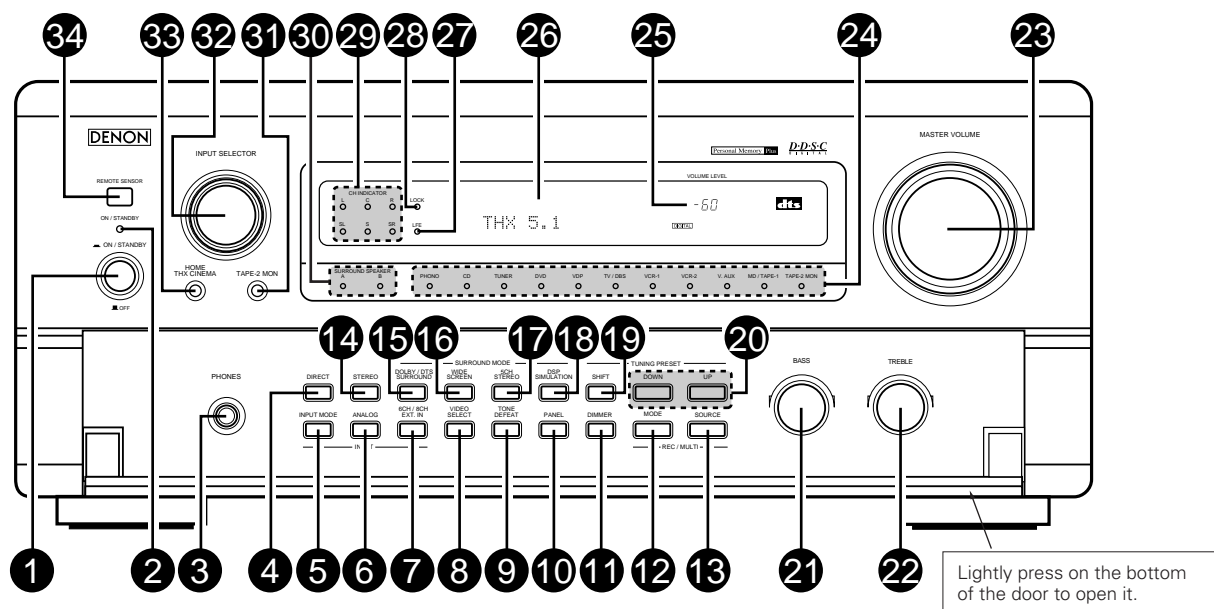

<b>1</b> Power switch .....(36)	<b>19</b> SHIFT button .....(53, 54)
<b>2</b> Power indicator .....(36)	<b>20</b> PRESET UP/DOWN button .....(53, 54)
<b>3</b> Headphones jack (PHONES) .....(39)	<b>21</b> BASS adjustment control .....(39)
<b>4</b> DIRECT button .....(49)	<b>22</b> TREBLE adjustment control .....(39)
<b>5</b> INPUT MODE selector button .....(37)	<b>23</b> MASTER VOLUME control .....(38)
<b>6</b> ANALOG button .....(37)	<b>24</b> Input source indicators
<b>7</b> 6CH/8CH external input button (6CH/8CH EXT. IN) .....(41)	<b>25</b> Master volume indicator (VOLUME LEVEL) .....(38)
<b>8</b> VIDEO SELECT button .....(39)	<b>26</b> Display
<b>9</b> TONE DEFEAT button .....(39)	<b>27</b> Low frequency effect indicator (LFE) .....(46)
<b>10</b> PANEL button .....(39)	<b>28</b> Digital lock indicator (LOCK) .....(38)
<b>11</b> DIMMER button .....(39)	<b>29</b> Dolby digital/DTS surround input channel indicators [CH INDICATOR] .....(45)
<b>12</b> REC/MULTI MODE selector button .....(40)	<b>30</b> Surround speaker system indicators (SURROUND SPEAKER A/B)
<b>13</b> REC/MULTI SOURCE selector button .....(40)	<b>31</b> Tape 2 monitor button (TAPE-2 MON) .....(37)
<b>14</b> STEREO button .....(38)	<b>32</b> Input source selector dial (INPUT SELECT) .....(37)
<b>15</b> DOLBY/DTS SURROUND button .....(44, 45)	<b>33</b> HOME THX CINEMA button .....(47)
<b>16</b> WIDE SCREEN button .....(49)	<b>34</b> Remote control sensor (REMOTE SENSOR) .....(28)
<b>17</b> 5CH STEREO button .....(49)	
<b>18</b> DSP SIMULATION button .....(49)	

## Remote control unit

- For details on the functions of these parts, refer to the pages given in parentheses ( ).

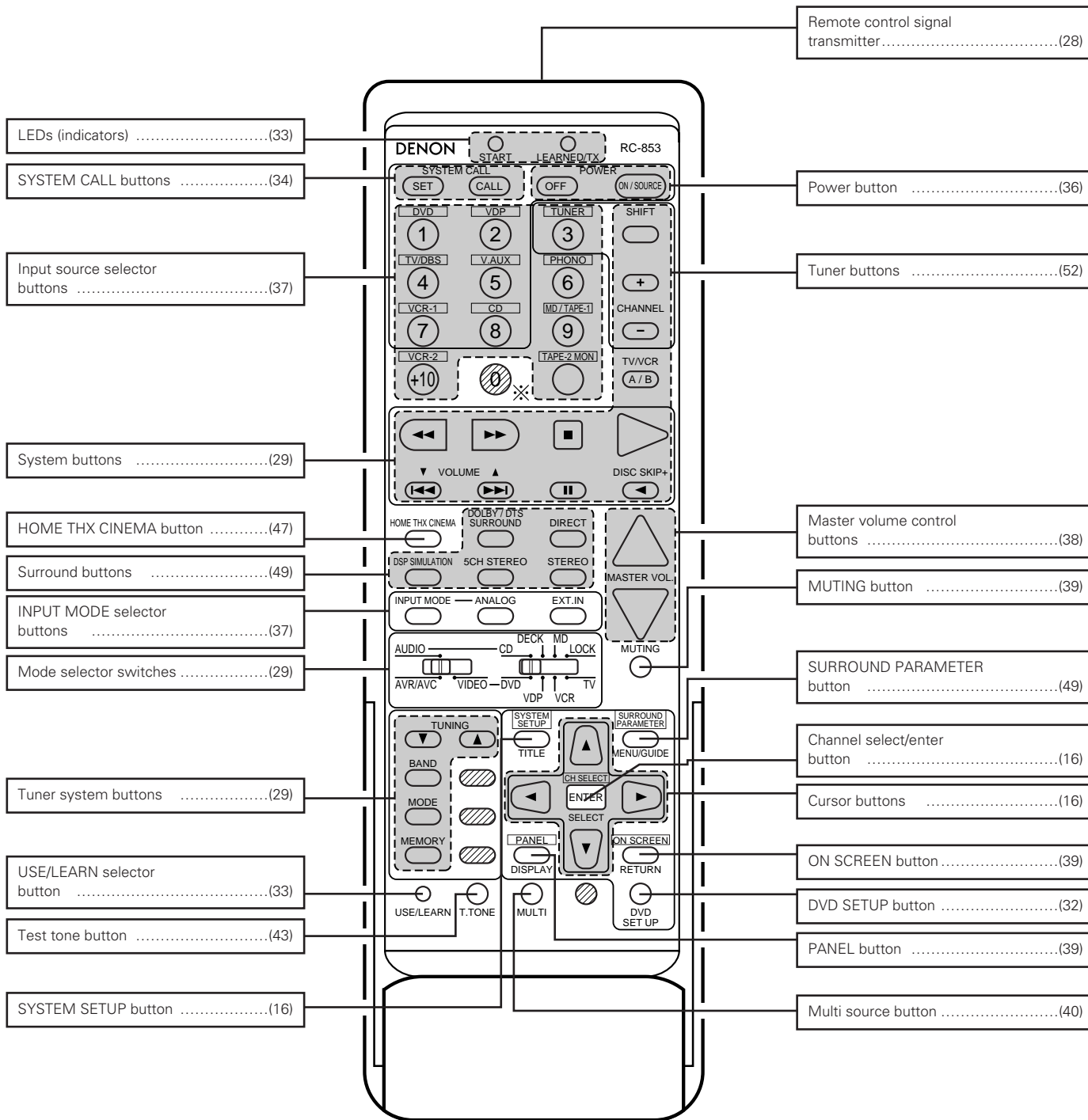

### NOTE

- The shaded buttons  do not function with the AVR-5700. (Nothing happens when they are pressed.)  
The button indicated \*, however, can be used with the learning function.

## 7 SETTING UP THE SYSTEM

- Once all connections with other AV components have been completed as described in "CONNECTIONS" (see pages 6 to 13), make the various settings described below on the monitor screen using the AVR-5700's on-screen display function. These settings are required to set up the listening room's AV system centered around the AVR-5700.
- Use the following buttons to set up the system:

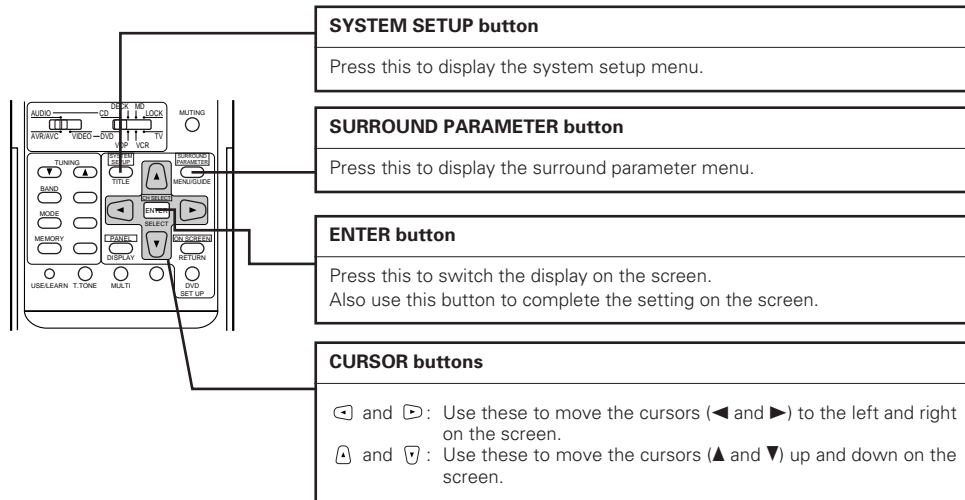

- System setup items and default values (set upon shipment from the factory)

System setup				Default settings							
①	Speaker Configuration	Input the combination of speakers in your system and their corresponding sizes (SMALL for regular speakers, LARGE for full-size, full-range) to automatically set the composition of the signals output from the speakers and the frequency response.		Front Sp.		Center Sp.		Surround Sp.		Sub Woofer	
	(Surround Speaker Setting)	Use this function when using multiple surround speaker combinations for more ideal surround sound. Once the combinations of surround speakers to be used for the different surround modes are preset, the surround speakers are selected automatically according to the surround mode.	Surround mode	DOLBY/DTS SURROUND	THX SURROUND	WIDE SCREEN	5CH STEREO	DSP SIMULATION	EXT. IN	—	—
			Surround speaker	A	A	A	A	A	A	—	—
②	Bass Output	This selects the subwoofer speaker for playing deep bass signals.		Bass Out = Subwoofer Only THX							
③	Delay Time	This parameter is for optimizing the timing with which the audio signals are produced from the speakers and subwoofer according to the listening position.		Front L & R		Center		Surround L & R		Sub Woofer	
				3.6 m (12 ft)		3.6 m (12 ft)		3.0 m (10 ft)		3.6 m (12 ft)	
④	Channel Level	This adjusts the volume of the signals output from the speakers and subwoofer for the different channels in order to obtain optimum effects.		Front L	Front R	Center		Surround L	Surround R	Subwoofer	
				0 dB	0 dB	0 dB		0 dB	0 dB	0 dB	
⑤	Subwoofer Peak Limit Lev	This parameter is for detecting the maximum level of the low bass signals output from the subwoofer channel in order to protect the subwoofer from damage and prevent unpleasant distorted sounds from being produced.		Peak Limiter = OFF							
⑥	Digital Inputs	This assigns the digital input jacks for the different input sources.	Input source	CD	DVD	VDP	TV/DBS	VCR-1	VCR-2	V. AUX	TAPE-1
			Digital Inputs	COAXIAL 1	COAXIAL 2	COAXIAL 3	OPTICAL 1	OPTICAL 2	OPTICAL 3	OPTICAL 4	OPTICAL 5
⑦	On Screen Display	This sets whether or not to display the on-screen display that appears on the monitor screen when the controls on the remote control unit or main unit are operated (from MONITOR 1 outputs only).		On Screen Display = ON							
⑧	Auto Tuner Presets	FM stations are received automatically and stored in the memory.		A1 ~ A8	87.5/89.1/98.1/107.9/90.1/90.1/90.1/90.1 MHz						
				B1 ~ B8	520/600/1000/1400/1500/1710 kHz/90.1/90.1 MHz						
				C1 ~ C8	90.1 MHz						
				D1 ~ D8	90.1 MHz						
				E1 ~ E8	90.1 MHz						

### NOTES:

- The on-screen display signals are not output from the MONITOR OUT-2 output jack or the color difference (component) video signal (MONITOR OUT) jacks.
- The on-screen display signals are output with priority to the S-VIDEO MONITOR OUT jack during playback of a video component. For example, if the TV monitor is connected to both the AVR-5700's S-Video and video monitor output jacks and signals are input to the AVR-5700 from a video source (VDP, etc.) connected to both the S-Video and video input jacks, the on-screen display signals are output with priority to the S-Video monitor output. If you wish to output the signals to the video monitor output jack, do not connect a cord to the S-VIDEO MONITOR OUT jack. (For details, see page 27.)
- The AVR-5700's on-screen display function is designed for use with high resolution monitor TVs, so it may be difficult to read small characters on TVs with small screens or low resolutions.
- The setup menu is not displayed when headphones are being used.



• **Speaker system layout**

Basic system layout

- The following is an example of the basic layout for a system consisting of six speaker systems and a television monitor:

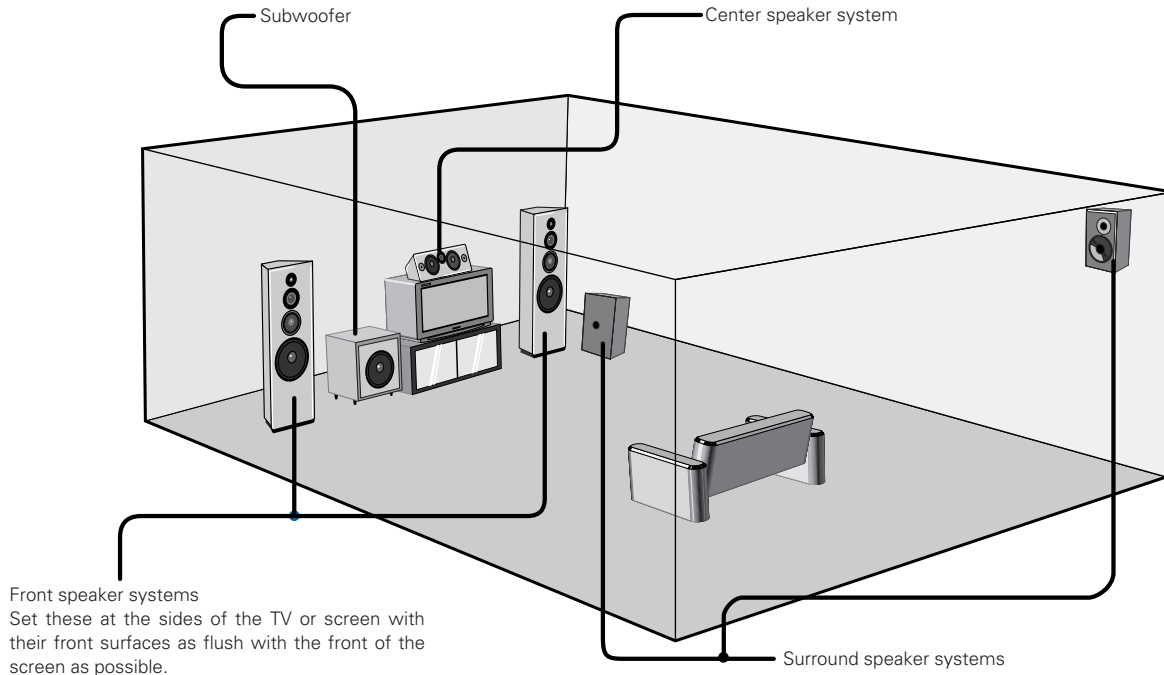

With the AVR-5700 it is also possible to use the surround speaker selector function to choose the best layout for a variety of sources and surround modes.

• **Surround speaker selector function**

This function uses either or both of two systems of surround speakers (A and B) to achieve the optimum sound field for different sources. The speaker settings (on or off for A only, B only or A+B) are stored in the memory for the different surround modes and are recalled automatically when that surround mode is set.

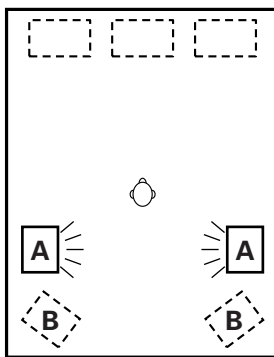

Using A only

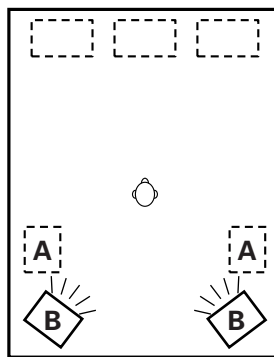

Using B only

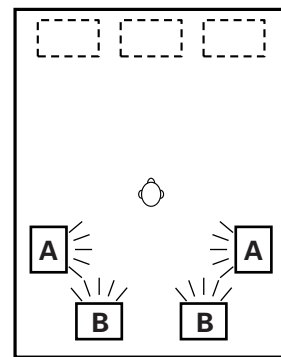

Using both A and B (A+B)  
Multi surround speaker mode

## Before setting up the system

**1** Check that all the connections are correct, then turn on the main unit's power.

**2** Display the System Setup Menu.

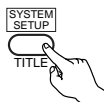

```

System Setup Menu
Speaker Configuration
▼ Bass Output
Delay Time
Channel Level
Subwoofer Peak Limit Lev.
Digital Inputs
On Screen Display
Auto Tuner Presets
    
```

## Setting the type of speakers

• The composition of the signals output from the different channels and the frequency response are adjusted automatically according to the combination of speakers actually being used.

**1** At the System Setup Menu select "Speaker Configuration".

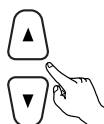

**2** Switch to the speaker configuration screen.



**3** Set whether or not speakers are connected and, if so, their size parameters.

- To select the speaker

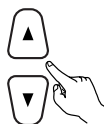

```

Speaker Config. Front Sp.
Large Small
Center Sp.
Small None
Surround Sp. A
Small None
Surround Sp. B
Small None
Subwoofer
Yes No
    
```

- To select the parameter

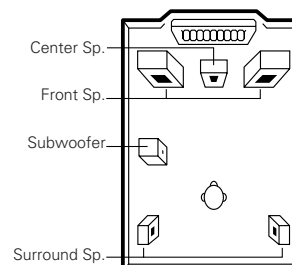
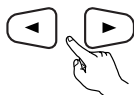

4



Enter the setting.

- a) If no surround speakers are used (if "None" is set for both A and B):  
The System Setup Menu reappears.
- b) If both surround speakers A and B are used (if either "Large" or "Small" is set for both A and B):  
The surround speaker setting screen appears.
- c) If "None" is set for surround speakers A:  
"None" is automatically set for surround speakers B.

**NOTE:**

- Select "Large" or "Small" not according to the actual size of the speaker but according to the speaker's capacity for playing low frequency (approximately 80 Hz and below) signals. If you do not know, try comparing the sound at both settings (setting the volume to a level low enough so as not to damage the speakers) to determine the proper setting.

**Parameters**

- Large..... Select this when using speakers that can fully reproduce low sounds of below 80 Hz.
- Small..... Select this when using speakers that cannot reproduce low sounds of below 80 Hz with sufficient volume.  
When this setting is selected, low frequencies of below 80 Hz are assigned to the subwoofer.
- None..... Select this when no speakers are installed.
- Yes/No... Select "Yes" when a subwoofer is installed, "No" when a subwoofer is not installed.
- \* If the subwoofer has sufficient low frequency playback capacity, good sound can be achieved even when "Small" is set for the front, center and surround speakers.
- \* To take full advantage of the performance of the Home THX certified speaker systems, set the front, center and surround speaker size parameters to "Small" and the subwoofer to "Yes".
- \* For the majority of speaker system configurations, using the SMALL setting for all five main speakers and Subwoofer On with a connected subwoofer will yield the best results.

**Selecting the surround speakers for the different surround modes**

- At this screen preset the surround speakers to be used in the different surround modes.

1

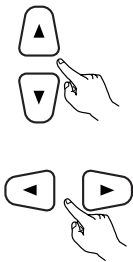

When either "Large" or "Small" has been set for both speakers A and B on the System Setup Menu (when using both A and B surround speakers), the surround speaker setting screen appears.

Select the surround speakers to be used in the different surround modes.

- To select the surround mode
- To select the surround speaker
- A: When using surround speakers A
- B: When using surround speakers B
- A+B: When using both surround speakers A and B

Surround	Sp	Setting
<input checked="" type="checkbox"/> DOLBY/DTS	<input checked="" type="checkbox"/> A	<input checked="" type="checkbox"/> B A+B
<input checked="" type="checkbox"/> SURROUND	<input checked="" type="checkbox"/> A	<input checked="" type="checkbox"/> B A+B
THX/THX5.1	<input checked="" type="checkbox"/> A	<input checked="" type="checkbox"/> B A+B
WIDE SCREEN	<input checked="" type="checkbox"/> A	<input checked="" type="checkbox"/> B A+B
5CH STEREO	<input checked="" type="checkbox"/> A	<input checked="" type="checkbox"/> B A+B
DSP	<input checked="" type="checkbox"/> A	<input checked="" type="checkbox"/> B A+B
SIMULATION	<input checked="" type="checkbox"/> A	<input checked="" type="checkbox"/> B A+B
EXT. IN	<input checked="" type="checkbox"/> A	<input checked="" type="checkbox"/> B A+B

2



Enter the setting.

The System Setup Menu reappears.

- \* Speaker type setting when using both surround speakers A and B  
If "Small" is set for either surround speakers A or B, the output is the same as when "Small" is set for both A and B.

**Setting the bass output**

1

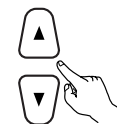

At the System Setup Menu select "Bass Output".

System Setup Menu	
▲	Speaker Configuration
<input checked="" type="checkbox"/>	Bass Output
▼	Delay Time
	Channel Level
	Subwoofer Peak Limit Lev.
	Digital Inputs
	On Screen Display
	Auto Tuner Presets

2



Switch to the Bass Output screen.

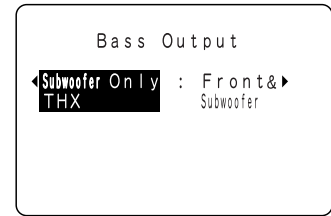

3

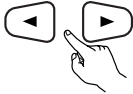

Select the bass signal playback mode.

4



Enter the setting.  
The System Setup Menu reappears.

**Playback modes**

**Subwoofer Only THX (recommended THX mode)**

The LFE and the low frequencies (80 Hz or lower) of the channels set to "Small" at the Speaker Configuration screen are output from the subwoofer.

When a channel is set to "Large", the low frequencies are output from that channel and not from the subwoofer.

**Front & Subwoofer:**

Even if "Large" is set for the front speakers at the Speaker Configuration screen, the LFE and the low frequencies of the front channels as well as the low frequencies of the other channels are output from the subwoofer. The front speakers (left and right, but not the center) also output deep bass. This mode is provided for those with large, floor-standing tower speakers that have full range (20 Hz and up) response, and are using a subwoofer in the system as well.

**NOTE:**

- To play in the Front & Subwoofer mode, set the front speakers to "Large" and the subwoofer to "Yes" at the Speaker Configuration screen.

**Setting the delay time**

- Input the distance between the listening position and the different speakers to set the delay time for the surround mode.
- The delay time can be set separately for surround speakers A and B.

**Preparations:**

Measure the distances between the listening position and the speakers (L1 to L4 on the diagram at the right).

- L1: Distance between center speaker and listening position
- L2: Distance between front speakers and listening position
- L3: Distance between surround speakers and listening position
- L4: Distance between subwoofer and listening position

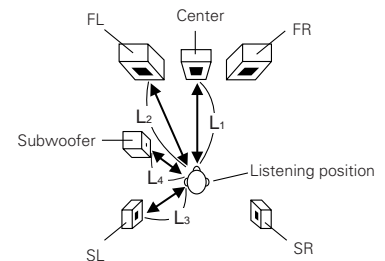

1

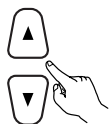

At the System Setup Menu select "Delay Time".

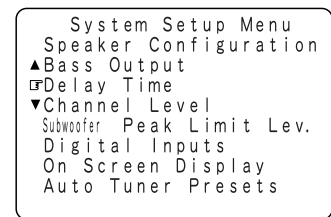

2



Switch to the Delay Time screen.

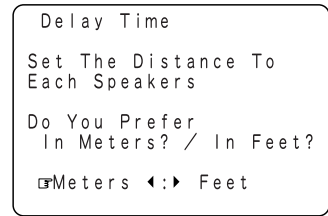

3

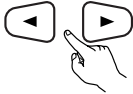

Select the desired unit, meters or feet. Select (darken) the desired units, "Meters" or "Feet".

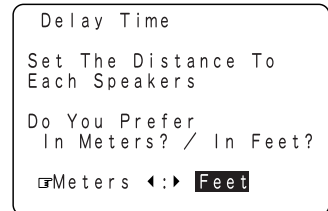

Example: When "Feet" is selected

4

Once "Meters" or "Feet" is selected in step 3, the Delay Time screen appears automatically.

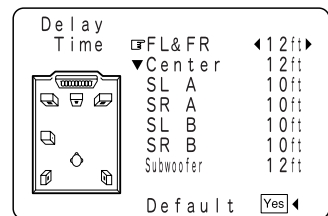

5

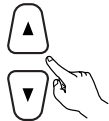

Select the speaker to be set.

6

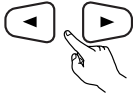

Set the distance between the center speaker and listening position. The distance changes in units of 0.1 meters (1 foot) each time the button is pressed. Select the value closest to the measured distance.

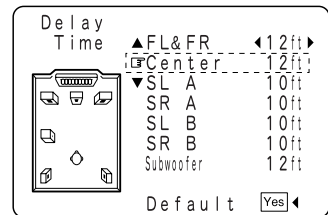

Example: When the distance is set to 12 feet for the center speaker (L1)

\* If "Yes" is selected for "Default", the settings are automatically reset to the default values.

Please note that the difference of distance for every speaker should be 15 ft (4.5 m) or less. If you set an invalid distance, a CAUTION notice, such as screen right will appear. In this case, please relocate the blinking speaker(s) so that its distance is no larger than the value shown in highlighted line.

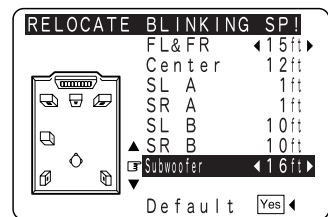

7



Enter the setting.  
The System Setup Menu reappears.  
The AVR-5700 automatically sets the optimum surround delay time for the listening room.

**NOTE:**

- If the distance unit is changed after the delay time is set, the settings are reset to the factory default values (see page 16).

## Setting the channel level

- Use this setting to adjust so that the playback level between the different channels is equal.
- From the listening position, listen to the test tones produced from the speakers to adjust the level.
- The level can also be adjusted directly from the remote control unit. (For details, see page 43.)
- When using both surround speakers A and B, their playback levels can be adjusted separately.

1

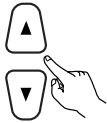

At the System Setup Menu select "Channel Level".

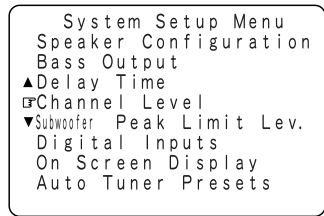

2



Switch to the Channel Level screen.

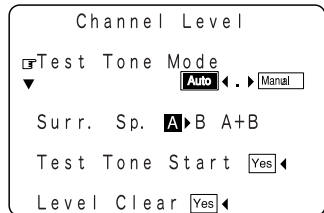

3



Select "Test Tone Mode".

4

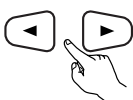

Select the mode.  
Select "Auto" or "Manual".

- Auto:  
Adjust the level while listening to the test tones produced automatically from the different speakers.
- Manual:  
Select the speaker from which you want to produce the test tone to adjust the level.

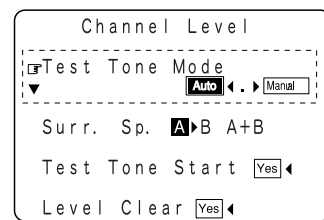

Example: When the "Auto" mode is selected

5

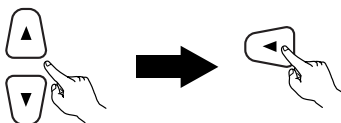

Select "Surr. Sp.", then select the surround speaker(s) from which you want to produce the test tone (A, B or A+B).

- Surr. Sp.: A  
Adjusts the balance of the playback level between the channels when using surround speaker A.
  - Surr. Sp.: B  
Adjusts the balance of the playback level between the channels when using surround speaker B.
  - Surr. Sp.: A+B  
Adjusts the balance of the playback level between the channels when using surround speakers A and B at the same time.
- \* The "Surr. Sp." can only be selected when both surround speakers A and B have been selected at the System Setup Menu (when both A and B have been set to "Large" or

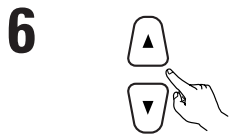

Select "Test Tone Start".

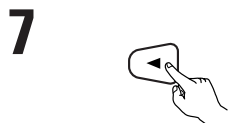

Select "Yes".

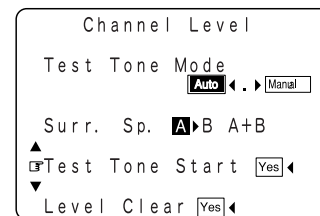

a. If the "Auto" mode is selected:  
 Test tones are automatically emitted from the different speakers. The test tones are emitted from the different speakers in the following order, at 4-second intervals the first time and second time around, 2-second intervals the third time around and on:

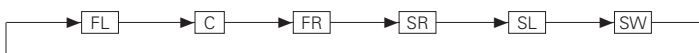

Use the CURSOR buttons to adjust all the speakers to the same volume. The volume can be adjusted between -12 dB and +12 dB in units of 1 dB.

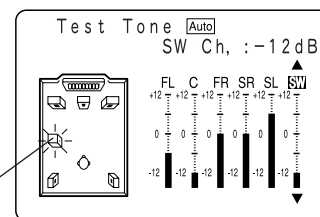

Example: When the volume is set to -12 dB while the test tone is being produced from the subwoofer

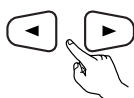

b. When the "Manual" mode is selected  
 Use the ◀ and ▶ cursor buttons to select the speaker from which you want to produce the test tone, then use the ▲ and ▼ cursor buttons to adjust so that the volume from the different speakers sounds the same.

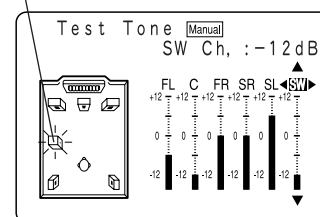
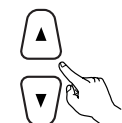

Example: When the volume is set to -12 dB while the subwoofer is selected

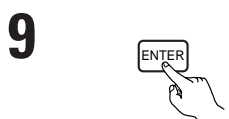

After the above settings are completed, press the ENTER button again. The "Channel Level" screen reappears.

\* To cancel the settings, select "Level Clear" and "Yes" on the "Channel Level" screen, then make the settings again.

The level of each channel should be adjusted to 75 dB (C-weighted, slow meter mode) on a sound level meter at the listening position. If a sound level meter is not available adjust the channels by ear so the sound levels are the same. Because adjusting the subwoofer level test tone by ear is difficult, use a well known music selection and adjust for natural balance.

**NOTE:** When adjusting the level of an active subwoofer system, you may also need to adjust the subwoofer's own volume control.

- \* When you adjust the channel levels while in the SYSTEM SETUP CHANNEL LEVEL mode, the channel level adjustments made will affect ALL surround modes. Consider this mode a Master Channel Level adjustment mode.
- \* After you have completed the SYSTEM SETUP CHANNEL LEVEL adjustments, you can then activate the individual surround modes and adjust channel levels that will be remembered for each of those modes. Then, whenever you activate a particular surround sound mode, your preferred channel level adjustments for just that mode will be recalled. Check the instructions for adjusting channel levels within each surround mode on Page 43.
- \* You can adjust the channel levels for each of the following surround modes: DIRECT, STEREO, 5 CH STEREO, DOLBY/DTS SURROUND, HOME THX CINEMA, WIDE SCREEN, SUPER STADIUM, ROCK ARENA, JAZZ CLUB, CLASSIC CONCERT, MONO MOVIE, and MATRIX.
- \* When using either surround speakers A or B, or when using surround speakers A and B at the same time, be sure to adjust the balance of playback levels between each channel for the various selections of "A or B" and "A and B".

## Subwoofer peak limit level setting

- This unit features a subwoofer peak limit control which prevents distortion and damage in the loudspeaker system by controlling the maximum bass volume level. With this feature you may set the maximum bass level for the system.
- This feature operates with or without a subwoofer in the system.

- 

Use the CURSOR buttons to specify "Subwoofer Peak Limit Lev." from the "System Setup Menu" screen.

System Setup Menu  
 Speaker Configuration  
 Bass Output  
 Delay Time  
 ▲Channel Level  
 ▣Subwoofer Peak Limit Lev.  
 ▼Digital Inputs  
 On Screen Display  
 Auto Tuner Presets
- 

Switch to the Subwoofer Peak Limit Level Setting screen.

Subwoofer Peak  
 Limit Level Setting

Find The Level When  
 Distortion Begins.

▣Peak Limiter  ON ◀▶  OFF
- 

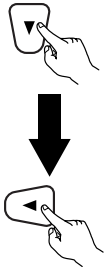
Select "ON" for Peak Limiter.
- 

The screen switches. Select "Setting Start", then select "Yes".  
 The screen switches and a test noise is produced from the speaker system.

Subwoofer Peak  
 Limit Level Setting

Find The Level When  
 Distortion Begins.

▣Peak Limiter  ON ◀▶  OFF  
 ▼Setting start  Yes ◀
- 

Increase the master volume level until the test noise is distorted.  
 The test noise (bass sound) is distorted when it sounds as if the input is excessively high (when the sound crackles).

Subwoofer Peak  
 Limit Level Setting

Turn Up The Volume  
 With  
 Master Vol.  Button.

When Distortion Begins  
 Push Enter Button
- 

Press the ENTER button at the point where the test noise starts sounding distorted.  
 The AVR-5700 automatically sets the subwoofer peak limit level.  
 This prevents future inadvertent subwoofer overload due to excessively strong bass content when the master volume control is at a high level.

\* Clear the subwoofer's peak limit level setting by specifying "Peak Limiter" and "OFF".



### CAUTION!

- The master volume is set to “-30 dB” when test tones are output.
- The test tones are for confirming the low frequency playback limits and are played at an extremely high level. When using a low output subwoofer, be very careful about irregular operations exceeding clipping by for example turning down the subwoofer’s attenuator before starting then slowly turning the attenuator up to the listening level.
- Also, when the subwoofer is set to “NO” in the speaker configuration, the test tones are output from the front speakers. When using front speakers with low input resistance, check that the sound is not clipped at sections where the signal is strong on the CD music source before starting the peak limit setting. The peak limit setting should not be performed if the music source cannot be played with the master volume set at “-15”. Set the front speakers to “small” and the subwoofer to “YES” in the speaker configuration. When this is done, the low frequencies are cut, so the effect is insufficient. We strongly recommend adding a subwoofer.
- If the test tone is clipped when it is set to “-18 dB”, set the peak limit to “-18 dB”. In this case, the input resistance of the subwoofer or front speakers is insufficient so clipping may occur when playing music. We recommend switching to a subwoofer with a higher input resistance.

## Setting the digital inputs

- This setting assigns the digital input jacks of the AVR-5700 for the different input sources.

1

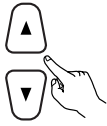

At the System Setup Menu select “Digital Inputs”.

```
System Setup Menu
Speaker Configuration
Bass Output
Delay Time
Channel Level
▲Subwoofer Peak Limit Lev.
▣Digital Inputs
▼On Screen Display
Auto Tuner Presets
```

2



Switch to the Digital Inputs screen.

```
Digital Inputs
▣CD : ◀COAXIAL1▶
▼DVD : COAXIAL2
VDP : COAXIAL3
TV/DBS : OPTICAL1
VCR-1 : OPTICAL2
VCR-2 : OPTICAL3
V.AUX : OPTICAL4
TAPE-1 : OPTICAL5
Default [Yes]◀
```

3

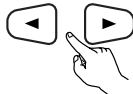

Select the digital input jack to be assigned to the input source.

- To select the input source
- To select the digital input jack

Select “OFF” for input sources for which no digital input jacks are used.

\* If “Yes” is selected for “Default”, the settings are automatically reset to the default values.

4



Enter the setting.  
The System Setup Menu reappears.

### NOTES:

- The OPTICAL 5 jacks on the AVR-5700’s rear panel are equipped with an optical digital output jack for recording digital signals on a DAT deck, MD player or other digital recorder. Use this for digital recording between a digital audio source (stereo - 2 channel) and a digital audio recorder.
- Do not connect the output of the component connected to the OPTICAL 5 OUT jack on the AVR-5700’s rear panel to any jack other than the OPTICAL 5 IN jack.
- “PHONO”, “TAPE-2” and “TUNER” cannot be selected on the Digital Inputs screen.

## Setting the on-screen display (OSD)

- Use this to turn the on-screen display (messages other than the menu screens) on or off.

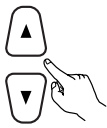
**1**  At the System Setup Menu select "On Screen Display".

```
System Setup Menu
Speaker Configuration
Bass Output
Delay Time
Channel Level
Subwoofer Peak Limit Lev.
▲Digital Inputs
▣On Screen Display
▼Auto Tuner Presets
```

**2**  Switch to the On Screen Display screen.

```
On Screen Display
ON ◀ : ▶ OFF
```

**3**  Select "ON" or "OFF".

**4**  Enter the setting.  
The System Setup Menu reappears.

## Auto tuner presets

Use this to automatically search for FM broadcasts and store up to 40 stations at preset channels A1 to 8, B1 to 8, C1 to 8, D1 to 8 and E1 to 8.

### NOTES:

- If an FM station cannot be preset automatically due to poor reception, use the "Manual tuning" operation to tune in the station, then preset it using the manual "Preset memory" operation.

**1**  Use the CURSOR buttons to specify "Auto Tuner Presets" from the "System Setup Menu" screen.

```
System Setup Menu
Speaker Configuration
Bass Output
Delay Time
Channel Level
Subwoofer Peak Limit Lev.
Digital Inputs
▲On Screen Display
▣Auto Tuner Presets
```

2



Press the ENTER button.  
The "Auto Preset Memory" screen appears.

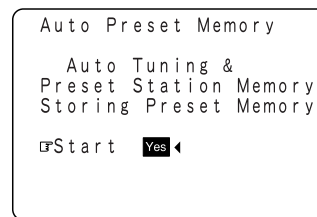

3

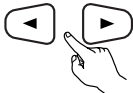

Use the CURSOR button to select "Yes".  
"Search" flashes on the screen and searching begins.  
"Completed" appears once searching is completed.  
The display automatically switches to screen.

\* This completes system setup. Once these settings are made, there is no need to change them unless different AV components are connected or the speakers are repositioned.

### After completing system setup

This button can be pressed at any time during the system setup process to complete the process.

1

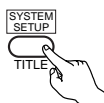

At the System Setup Menu, press the SYSTEM SETUP button.  
\* The changed settings are entered and the on-screen display turns off.

#### • On-screen display signals

	Signals input to the AVR-5700		On-screen display signal output	
	VIDEO signal input jack (yellow)	S-video signal input jack	VIDEO MONITOR OUT-1 video signal output jack (yellow)	S-video MONITOR OUT-1 video signal output jack
1	•	•	○	○
2	○	•	○	•
3	•	○	•	○
4	○	○	•	○

(○): Signal •: No signal)  
(○): On-screen signals output •: On-screen signals not output)

#### NOTES:

- The on-screen display signals are not output from the video signal MONITOR OUT-2 (yellow) or S-Video signal MONITOR OUT-2 jacks.
- The on-screen display signals are not output from the color difference (component) video signal MONITOR OUT jacks.
- For 4 above, the on-screen display signals are output to the VIDEO MONITOR OUT-1 video signal output jack (yellow) if the monitor TV is not connected to the S-video MONITOR OUT-1 video signal output jack.

## 8 REMOTE CONTROL UNIT

- The included remote control unit (RC-853) can be used to operate not only the AVR-5700 but other remote control compatible DENON components as well. Furthermore, it is equipped with a function for learning the control signals of remote control units of other manufacturers, so it can also be used to operate non-DENON remote control compatible video components.

### Inserting the batteries

- ① Remove the remote control unit's rear cover.

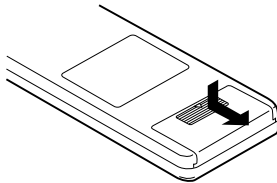

- ② Set two SUM3 (AA size) batteries in the battery compartment in the indicated direction.

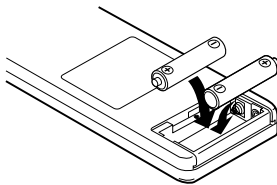

- ③ Put the rear cover back on.

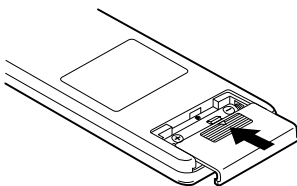

#### Notes on Batteries

- Use SUM3 (AA size) batteries in the remote control unit.
- The batteries should be replaced with new ones approximately once a year, though this depends on the frequency of usage.
- Even if less than a year has passed, replace the batteries with new ones if the set does not operate even when the remote control unit is operated nearby the set.
- When inserting the batteries, be sure to do so in the proper direction, following the “+” and “-” marks in the battery compartment.
- To prevent damage or leakage of battery fluid:
  - Do not use a new battery together with an old one.
  - Do not use two different types of batteries.
  - Do not short-circuit, disassemble, heat or dispose of batteries in flames.
- Remove the batteries from the remote control unit when you do not plan to use it for an extended period of time.
- If the battery fluid should leak, carefully wipe the fluid off the inside of the battery compartment and insert new batteries.
- When replacing the batteries, have the new batteries ready and insert them as quickly as possible.
- The learned remote control signals may be cleared if no batteries are in the remote control unit for about 5 seconds. The factory-installed codes are in permanent memory, however.

### Using the remote control unit

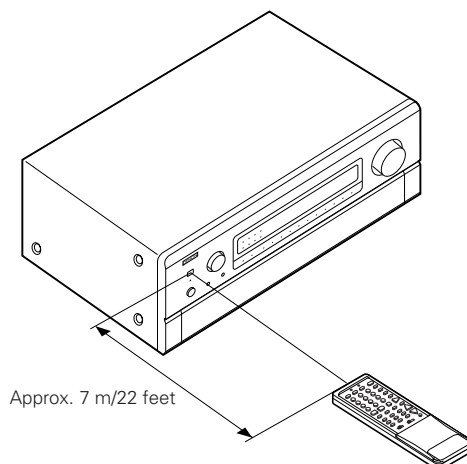

- Point the remote control unit at the remote sensor on the main unit as shown on the diagram.
- The remote control unit can be used from a straight distance of approximately 7 meters/22 feet from the main unit, but this distance will be shorter if there are obstacles in the way or if the remote control unit is not pointed directly at the remote sensor.
- The remote control unit can be operated at a horizontal angle of up to 30 degrees with respect to the remote sensor.

#### NOTES:

- It may be difficult to operate the remote control unit if the remote sensor is exposed to direct sunlight or strong artificial light.
- Do not press buttons on the main unit and remote control unit simultaneously. Doing so may result in malfunction.
- Neon signs or other devices emitting pulse-type noise nearby may result in malfunction, so keep the set as far away from such devices as possible.

# Operating DENON audio components

- Turn on the power of the different components before operating them.

**1** Set mode switch 1 to "AUDIO (AVR/AVC)".

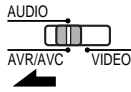

**2** Set mode switch 2 to the position for the component to be operated. (The tuner can be operated when the switch is at any position but "LOCK".)

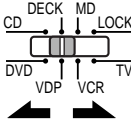

\* When set to LOCK, only the buttons for the basic functions of the AVR-5700 (sections A and B) will function. Use this position for example to prevent children from accidentally operating the system.

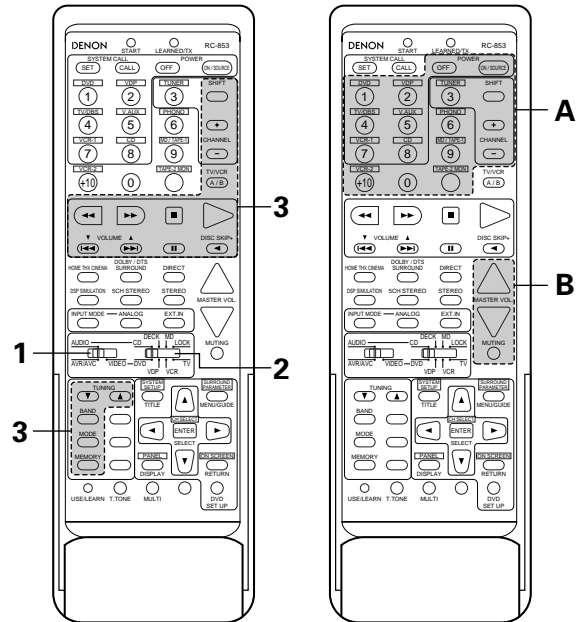

**3** Operate the audio component.

- For details, refer to the component's operating instructions.
- \* While this remote control is compatible with a wide range of infrared controlled components, some models of components may not be operated with this remote control.

### 1. CD player (CD) and MD recorder (MD) system buttons

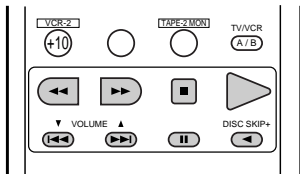

- ◀▶▶▶ : Manual search (forward and reverse)
- : Stop
- ▶ : Play
- ◀◀◀▶▶▶ : Auto search (cue)
- || : Pause
- DISC : Switch discs
- SKIP+ : (for CD changers only)

### 2. Tape deck (DECK) system buttons

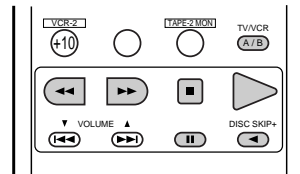

- ◀◀ : Rewind
- ▶▶ : Fast-forward
- : Stop
- ▶ : Forward play
- || : Pause
- ◀ : Reverse play
- A/B : Switch between decks A and B

### 3. Tuner system buttons

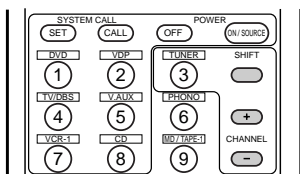

- SHIFT : Switch preset channel range
- CHANNEL : Preset channel
- +, - : up/down

\* For the tuner only, the following buttons can also be operated:

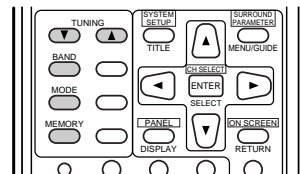

- TUNING : Frequency
- ▲, ▼ : up/down
- BAND : Switch between the AM and FM bands
- MODE : Switch between auto and mono
- MEMORY : Preset memory

## Preset memory

- DENON and other makes of components can be operated by setting the preset memory for your make of video component. **Operation is not possible for some models, however. In this case use the learning function (see page 33) to store the remote control signals.**
- For instructions on clearing the presettings stored in the preset memory, see page 36.

- 1** Set the slide switch to "VIDEO".

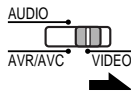

- 2** Set the slide switch to the component to be registered (VDP, VCR or TV).

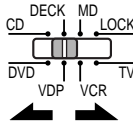

(Keep the POWER button pressed in when performing steps 3 and 4)

- 3** Holding in the POWER button, press the button for the corresponding manufacturer in block A. (Refer to Table 1.)

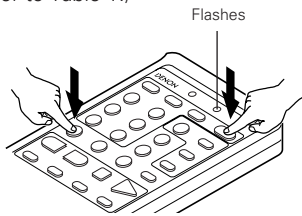

The LEARNED/TX LED flashes.

- 4** Next, while holding the POWER button, press the button for the code in block B. (Refer to Table 1.) The operation is completed when the button is released and the LEARNED/TX LED lights.

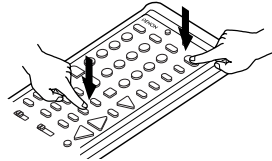

- 5** To continue registering other components, repeat steps 2 to 4.

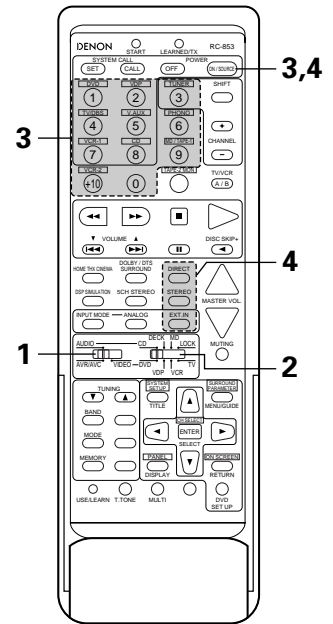

- This remote control unit can be used to operate components of other manufacturers without using the learning function by registering the manufacturer of the component as shown on Table 1.

**Table 1: Combinations of Personal System Codes for Different Manufacturers**

### "DVD"

A \ B	DIRECT (DIRECT)	STEREO (STEREO)	EXT.IN (EXT. IN)
① (DVD)	DENON A	DENON B	—
② (VDP)	—	—	—
③ (TUNER)	—	—	—
④ (TV/DBS)	PANASONIC	—	—
⑤ (V. AUX)	—	—	—
⑥ (PHONO)	SONY	—	—
⑦ (VCR-1)	PIONEER	—	—
⑧ (CD)	TOSHIBA	—	—
⑨ (MD/TAPE-1)	—	—	—
⑩ (VCR-2)	—	—	—
⑪	—	—	—

### "VDP"

A \ B	DIRECT (DIRECT)	STEREO (STEREO)	EXT.IN (EXT. IN)
① (DVD)	DENON A	DENON B	DENON C
② (VDP)	—	—	—
③ (TUNER)	MITSUBISHI	—	—
④ (TV/DBS)	PANASONIC	—	—
⑤ (V. AUX)	—	—	—
⑥ (PHONO)	SONY A	SONY B	SONY C
⑦ (VCR-1)	PIONEER	—	—
⑧ (CD)	—	—	—
⑨ (MD/TAPE-1)	—	—	—
⑩ (VCR-2)	—	—	—
⑪	—	—	—

\*  Preset codes set upon shipment from the factory and when reset

**"VCR"**

A \ B	DIRECT (DIRECT)	STEREO (STEREO)	EXT.IN (EXT. IN)
① (DVD)	—	—	—
② (VDP)	HITACHI A	HITACHI B	—
③ (TUNER)	MITSUBISHI A	MITSUBISHI B	MITSUBISHI C
④ (TV/DBS)	PANASONIC A	PANASONIC B	PANASONIC C
⑤ (V. AUX)	JVC (VICTOR) A	JVC (VICTOR) B	JVC (VICTOR) C
⑥ (PHONO)	SONY A	SONY B	SONY C
⑦ (VCR-1)	PIONEER	—	—
⑧ (CD)	TOSHIBA A	TOSHIBA B	—
⑨ (MD/TAPE-1)	SANYO A	SANYO B	—
⑩ (VCR-2)	SHARP A	SHARP B	—
⑪	NEC A	NEC B	NEC C

**"TV"**

A \ B	DIRECT (DIRECT)	STEREO (STEREO)	EXT.IN (EXT. IN)
① (DVD)	—	—	—
② (VDP)	DENON/HITACHI	—	—
③ (TUNER)	MITSUBISHI A	MITSUBISHI B	—
④ (TV/DBS)	PANASONIC A	PANASONIC B	—
⑤ (V. AUX)	JVC (VICTOR)	—	—
⑥ (PHONO)	SONY	—	—
⑦ (VCR-1)	PIONEER	—	—
⑧ (CD)	TOSHIBA	—	—
⑨ (MD/TAPE-1)	SANYO	—	—
⑩ (VCR-2)	SHARP	—	—
⑪	NEC	—	—

\*  Preset codes set upon shipment from the factory and when reset

**NOTES:**

- The signals for the pressed buttons are emitted while setting the preset memory. To avoid accidental operation, cover the remote control unit's transmitting window while setting the preset memory.
- Some models and years of manufacture of components of the manufacturers listed on Table 1 cannot be used.
- The signals stored at "learned" buttons have priority over the preset codes. If you wish to clear the "learned" signals, do so as described on page 36.
- Some manufacturers use different types of remote control codes for their products. If the component does not operate when set to remote codeset A, try setting to the B or C codesets.

# Operating a video component stored in the preset memory

- 1** Set the slide switch to "VIDEO".

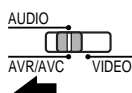

- 2** Set the slide switch to the component to be registered (VDP, VCR or TV).

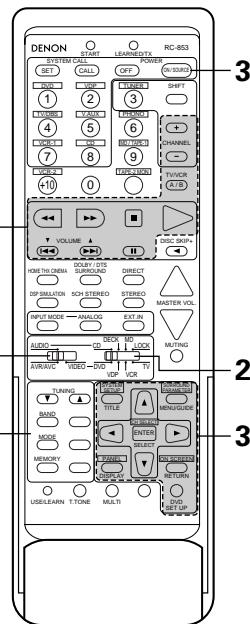
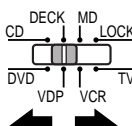

- 3** Operate the video component.  
 • For details, refer to the component's operating instructions.  
 \* Some models cannot be operated with this remote control unit.

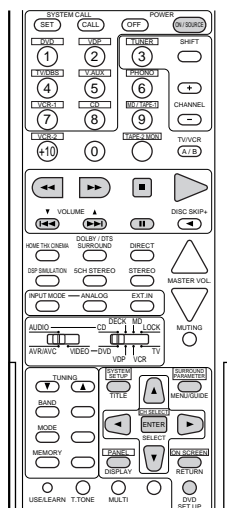

### 1. Digital video disc player (DVD) system buttons

- |       |                                       |            |                     |
|-------|---------------------------------------|------------|---------------------|
| POWER | : Turns power on and off              | MENU       | : Call out menu     |
| ◀▶▶▶  | : Manual search (forward and reverse) | DISPLAY    | : Switch display    |
| ■     | : Stop                                | DVD SET UP | : DVD setup         |
| ▶     | : Play                                | RETURN     | : Menu return       |
| ◀▶▶▶  | : Auto search (cue)                   | ▲▼         | : Cursor up/down    |
| ⏸     | : Pause                               | ◀▶         | : Cursor left/right |
| TITLE | : Call out title                      | SELECT     | : Enter setting     |

**NOTE:**  
 Some manufacturers use different names for the DVD remote control buttons, so also refer to the instructions on remote control for that component.

### 2. Video disc player (VDP) system buttons

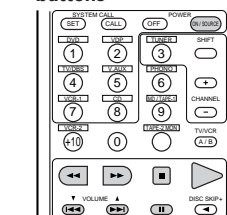

- POWER : Power on/off  
 ◀▶▶▶ : Manual search (forward and reverse)  
 ■ : Stop  
 ▶ : Play  
 ◀▶▶▶ : Auto search (cue)  
 ⏸ : Pause

### 3. Video deck (VCR) system buttons

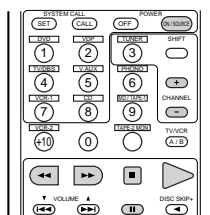

- POWER : Power on/off  
 ◀▶▶▶ : Manual search (forward and reverse)  
 ■ : Stop  
 ▶ : Play  
 ⏸ : Pause  
 CHANNEL : Switch channel  
 +, -

### 4. Monitor TV system buttons

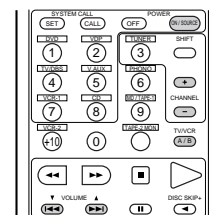

- POWER : Power on/off  
 VOLUME : Volume  
 ▲▼ : up/down  
 TV/VCR : Switch between TV and VCR  
 CHANNEL : Switch channel  
 +, -



## Learning function

- If your AV component is not a DENON product or it cannot be operated with the preset memory codesets, you can "teach" the AVR-5700's remote control to "learn" the codes from the component's original remote control.
- The buttons that can be "learned" are the CD, DECK and MD system buttons (see page 29) and the DVD, VDP, VCR and TV system buttons (see page 32). (For the CD, MD, DVD, VDP and TV, the A block buttons can also be "learned", and for the DVD and TV, the B block buttons can also be "learned".)

- 1** Press the USE/LEARN selector button with the tip of a pen etc., to set the learn mode. Both the START and LEARNED/TX indicators flash.

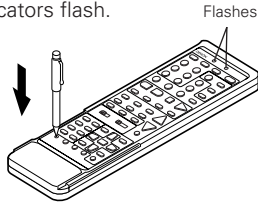

This unit's remote control unit

- 2** Set the program switch to the side to be "learned". Set to the AUDIO side for the CD, tape deck or DAT position, to the VIDEO side for the VDP, VCR or TV position.

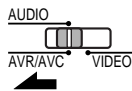

- 3** Set the program switch to the position to be "learned".

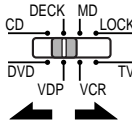

- 4** Set the remote control units so they are facing each other, then press the button to be "learned" on this unit's remote control unit.

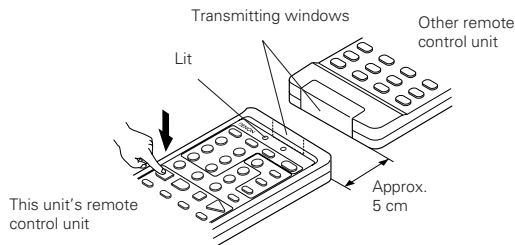

The indicator stops flashing and the START LED lights. The learnable buttons are the buttons which can be operated with the DENON system codes for the CD player, DAT and tape deck, the buttons which can be operated with the preset memory for the VCR, VDP and TV. For the TV only, however, the buttons in the section indicated "A" on the diagram above can also be "learned". Use these to "learn" TV channels.

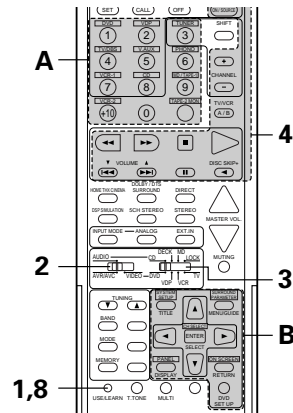

- 5** Check that the START LED is lit, then press the button to be "learned" on the other remote control unit.

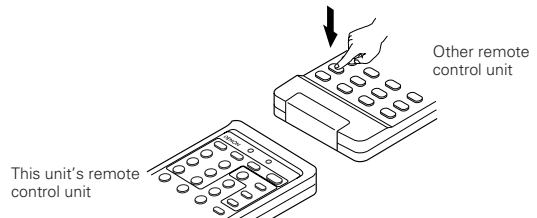

- 6** Once the START LED turns off and the LEARNED/TX LED lights, release the button on the other remote control unit.

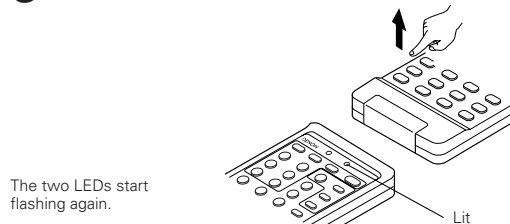

- 7** To "learn" other buttons, repeat steps 2 to 6.

- 8** Once the learning operation is completed, press the USE/LEARN selector button again. The two LEDs stop flashing and the learning mode is cancelled.

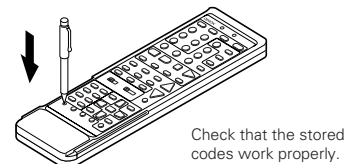

### NOTES:

- Up to 26 codes can be "learned", but this number may be lower if the codes are long.
- If a non-learnable button is pressed or two or more buttons are pressed at once, the two LEDs will once again light when the button(s) is released.
- If the codes could not be stored, the LEARNED/TX LED does not light after the START LED turns off. For limited number of models, codes cannot be stored in RC-853.
- If the two LEDs start flashing rapidly after the START LED lights, this means that the memory is already full, and the code you have just attempted to store was not stored. To "learn" that code, first perform the resetting operation. (See page 36.)

## System call function

- The included remote control unit is equipped with a system call function for transmitting multiple remote control signals when a single button is pressed (this is often referred to as a "macro" function). This function can be used to turn on the amplifier's power, select the input source, turn on the monitor TV's power, turn on a source component's power and start playback, etc., all at the touch of a button.

### (1) System call buttons

The buttons that can be used for the system call function are shown on the table below.

A series of up to 10 operations can be performed with the POWER ON and OFF buttons, and a series of up to 5 operations can be performed with other buttons.

System call signals are already preset at the buttons indicated in the shaded section. System call signals can also be stored at any button on the remote control unit, including the buttons in this section. (See page 35.)

Button	No. transmissions	Stored operation 1	Stored operation 2	Stored operation 3	Stored operation 4	Stored operation 5	Stored operation 6	Stored operation 7	Stored operation 8	Stored operation 9	Stored operation 10
POWER OFF (key 3)	10										
POWER OFF (key 4)	10										
DVD (key 5)	5	Receiver power on	DVD player (DVD) power on	Receiver input source switched to DVD	TV power on	DVD player (DVD) playback					
VDP (key 6)	5	Receiver power on	LD player (VDP) power on	Receiver input source switched to VDP	TV power on	LD player (VDP) playback					
TV/DBS (key 9)	5	Receiver power on	TV power on	Receiver input source switched to TV/DBS							
V.AUX (key 10)	5	Receiver power on	TV power on	Receiver input source switched to V.AUX							
VCR-1 (key 13)	5	Receiver power on	Video (VCR) power on	Receiver input source switched to VCR-1	TV power on	Video (VCR) playback					
CD (key 14)	5	Receiver power on	Receiver input source switched to CD								

The system call signals for the POWER OFF and POWER ON buttons are transmitted from the remote control unit approximately once every second. The signals for the other buttons (DVD, VDP, TV/DBS, V.AUX, VCR-1 and CD) are transmitted approximately once every 1.5 seconds.

### (2) Using the system call function

- Press the system call button.
  - The LEARNED/TX LED flashes for 5 seconds.



- Press the button at which the desired system call signals are stored while the LEARNED/TX LED is flashing.
  - The preset signals or the signals you have stored at that button are transmitted in succession.

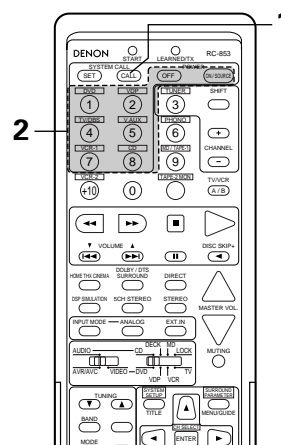

### (3) Storing signals

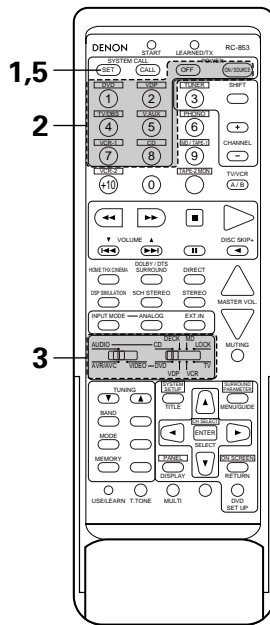

- 1 Press the SET button.
  - The START LED and LEARNED/TX LED both flash.



- 2 Press the button at which you want to store the system call signals.
  - The START LED flashes.

- 3 Set the mode switch to the position for the component whose remote control signals you want to store.

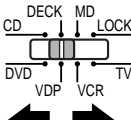
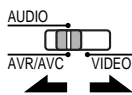

- 4 Press the buttons whose remote control signals you want to store one by one.

- 5 Press the SET button.



#### NOTES:

- The remote control signals for the buttons pressed while storing the system call signals are transmitted when the buttons are pressed, so cover the remote sensor or take other measures so that the components do not operate while the signals are being stored.
- The LEARNED/TX LED does not light if system call signals cannot be stored at the button that you have pressed or if you have already stored the maximum number of signals.

### (4) Clearing system call settings

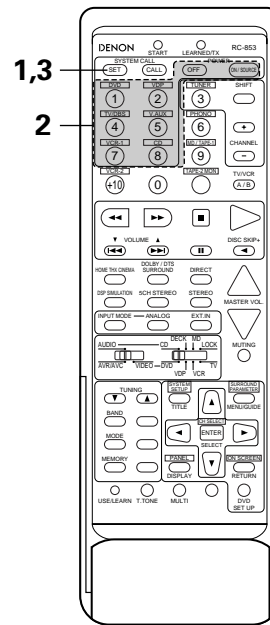

- 1 Press the SET button.



- 2 Press the button whose settings you want to clear.

- 3 Press the SET button.
  - The button is reset to the settings shown on the table on page 34.



## Clearing "learned" remote control signals and resetting the preset memory

- 1 Press the USE/LEARN selector button with the tip of a pen, etc., to set the learn mode.

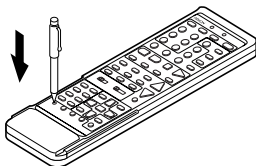

- 2 To clear "learned" remote control signals, set the slide switch to the position at which the signals were "learned". To clear the preset memory settings, set the slide switch to "VIDEO".

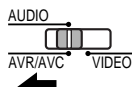

- 3 Set the slide switch to the position at which the signals were "learned" or at which the preset memory settings were set.

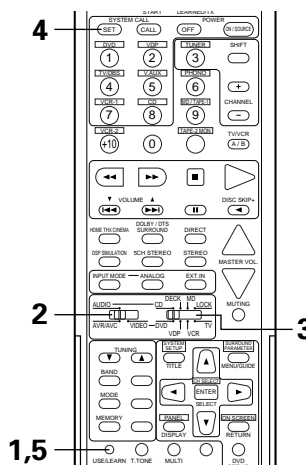
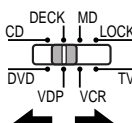

- 4 Press the SYSTEM CALL SET button, and hold it in for at least four seconds.
  - When both the START and LEARNED/TX LEDs light simultaneously, all the stored codes are cleared.

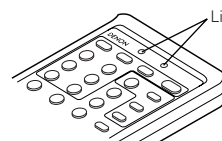

- 5 Press the USE/LEARN selector button.

## 9 OPERATION

### Before operating

- 1 Refer to "CONNECTIONS" (pages 6 to 13) and check that all connections are correct.

- 2 Set the remote control unit's slide switch to the AUDIO position. (only when operating with the remote control unit)

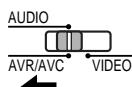

- 3 Turn on the power. Press the POWER switch (button).

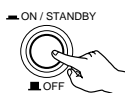

(Main unit)



(Remote control unit)

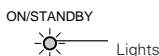

Lights

#### ON/STANDBY

The power turns on and "ON/STANDBY" indicator is lit.

Several seconds are required from the time the power switch is set to the "ON" position until sound is output. This is due to the built-in muting circuit that prevents noise when the power switch is turned on and off.

Set the POWER switch to this position to turn the power on and off from the included remote control unit (RC-853).

#### OFF

The power turns off and "ON/STANDBY" indicator is off.

In this position, the power cannot be turned on and off from the remote control unit.

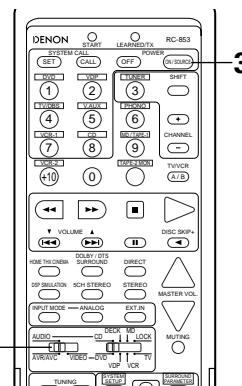
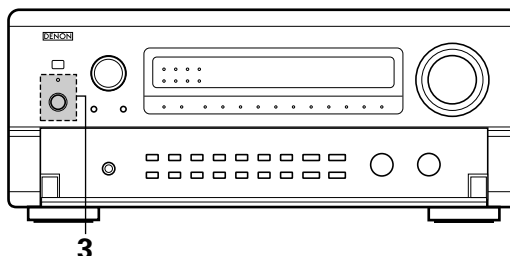

## Playing the input source

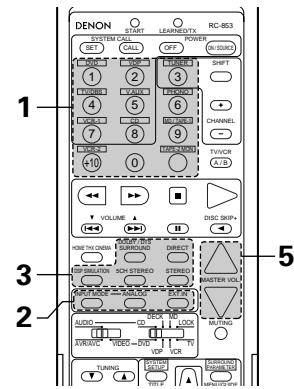
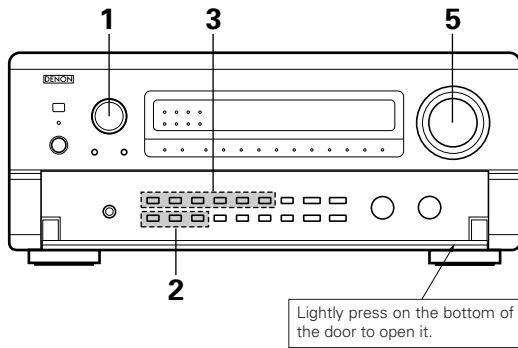

### 1 Select the input source to be played.

**Example: CD**

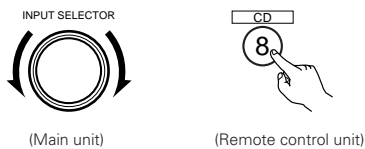

\* When the tape 2 input (TAPE-2 MON) is selected, the input indicator lights.

Lit

### 2 Select the input mode.

- Selecting the analog mode  
Press the ANALOG button to switch to the analog input.

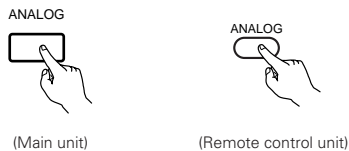

- Selecting the external input (6CH/8CH EXT. IN) mode  
Press the 6CH/8CH EXT. IN (on the EXT. IN button on the remote control unit) to switch the external input.

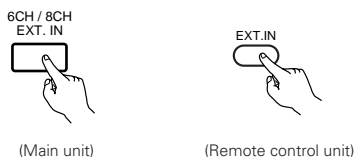

- Selecting the AUTO, DIGITAL, PCM and RF modes  
The mode switches as shown below each time the INPUT MODE button is pressed.

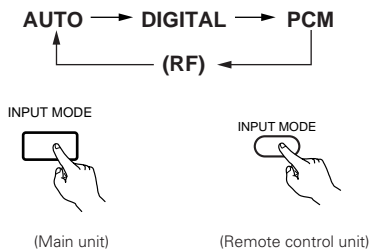

\* The RF mode can only be selected when the program source is set to VDP.

### Input mode selection function

Different input modes can be selected for the different input sources. The selected input modes for the separate input sources are stored in the memory.

#### ① AUTO (All auto mode)

In this mode, the types of signals being input to the digital and analog input jacks for the selected input source are detected and the program in the AVR-5700's surround decoder is selected automatically upon playback. This mode can be selected for all input sources other than PHONO, TAPE-2 and TUNER.

The presence or absence of digital signals is detected, the signals input to the digital input jacks are identified and decoding and playback are performed automatically in DTS, Dolby Digital or PCM (2 channel stereo) format. If no digital signal is being input, the analog input jacks are selected.

With a VDP input (used most often for Laser Disc), the presence or absence of a Dolby Digital AC-3 RF signal is also detected. If an AC-3 RF signal is detected at the Dolby Digital AC-3 RF jack, the RF signals are decoded and played with priority.

#### ② DIGITAL (Digital auto mode)

The signals being input to the digital input jacks are identified and decoding and playback are performed automatically in DTS, Dolby Digital or PCM format.

#### ③ PCM (exclusive PCM signal playback mode)

Decoding and playback are only performed when PCM signals are being input.

#### ④ RF (exclusive RF signal playback mode)

This can only be selected when the program source is set to VDP. Decoding and playback are only performed when RF signals are being input. This is used when the LD player has an AC-3 RF output jack, but does not have a PCM digital output jack.

#### ⑤ ANALOG (exclusive analog audio signal playback mode)

The signals input to the analog input jacks are decoded and played.

#### ⑥ 6CH/8CH EXT. IN (external decoder input jack selection mode)

The signals being input to the external decoder input jacks are played without passing through the surround circuitry.

### NOTES:

- When the AUTO (all auto) mode is selected for the VDP program source and the mode is switched from pause or chapter skip, etc., to playback while playing the Dolby Digital sound of an LD, the PCM/analog sound may be output momentarily before the sound switches to Dolby Digital. If this happens, switch to the "RF" (fixed RF input) mode and the sound will not be interrupted. That is due to the fact that when paused or during chapter skip, the AC-3 RF signal is interrupted.
- When playing PCM signals in the DIGITAL (digital auto) mode, the sound may be briefly interrupted when playback starts after searching on CDs or LDs, depending on how the signals are recorded on the disc. If this happens, switch to the "PCM" (exclusive PCM signal playback) mode to prevent the sound from being interrupted.
- Note that noise will be output when CDs or LDs recorded in DTS format are played in the "PCM" (exclusive PCM signal playback) or "ANALOG" (exclusive PCM signal playback) mode. Select the AUTO (all auto) or DIGITAL (digital auto) mode when playing signals recorded in DTS from a laser disc player.

### 3 Select the play mode.

**Example: Stereo**



### 4 Start playback on the selected component.

- For operating instructions, refer to the component's manual.

### 5 Adjust the volume.

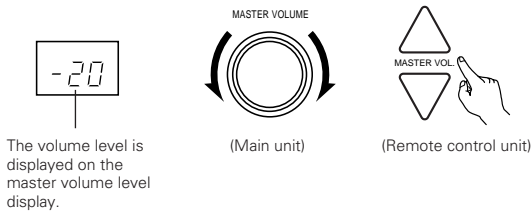

\* The volume can be adjusted within the range of -60 to 0 to 18 dB, in steps of 1 dB. However, when the channel level is set as described on page 22 or pages 43 and 44, if the volume for any channel is set at +1 dB or greater, the volume cannot be adjusted up to 18 dB. (In this case the maximum volume adjustment range is "18 dB — (Maximum value of channel level)".)

#### Input mode when playing DTS sources

- Noise will be output if DTS-compatible CDs or LDs are played in the "ANALOG" or "PCM" mode. When playing DTS-compatible sources, be sure to connect the source component to the digital input jacks (OPTICAL/COAXIAL) and set the input mode to "AUTO" or "DIGITAL".

#### Input mode display

- In the AUTO mode
 





One of these lights, depending on the input signal.  
 ANALOG    DIGITAL
- In the DIGITAL AUTO mode
- In the DIGITAL PCM mode
- When switched to RF in the VDP RF or AUTO mode
- In the ANALOG mode

#### Input signal display

- DOLBY DIGITAL
 

L	C	R	LOCK
SL	S	SR	LFE

One of these lights, depending on the input signal.  
 DIGITAL    PRO LOGIC    LOCK
- DTS
 

L	C	R	LOCK
SL	S	SR	LFE

Lit  
 dts    LOCK
- PCM
 

L	C	R	LOCK
SL	S	SR	LFE

LOCK

\* The LOCK LED lights when digital signals are being input properly. If the LED does not light, check whether the digital input component setup (page 25) and connections are correct and whether the component's power is turned on.

#### NOTE:

- The digital input indicator will light (green) when playing CD-ROMs containing data other than audio signals, but no sound will be heard.

## After starting playback

### [1] Adjusting the sound quality (tone)

The tone control function will not work in the direct or Home THX Cinema mode.

- Adjust the bass sound to the desired level using the BASS adjustment control, the treble sound using the TREBLE adjustment control.

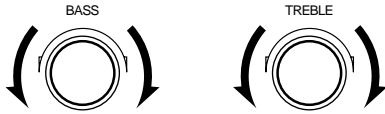

- To increase the bass or treble: Turn the control clockwise. (The bass or treble sound can be increased to up to +12 dB in steps of 2 dB.)
- To decrease the bass or treble: Turn the control counter-clockwise. (The bass or treble sound can be decreased to up to -12 dB in steps of 2 dB.)

- If you do not want the bass and treble to be adjusted, turn on the tone defeat mode.

- The signals do not pass through the bass and treble adjustment circuits, providing higher quality sound.



### [3] Turning the sound off temporarily (muting)

- Use this to turn off the audio output temporarily. Press the MUTING button.

- Press the MUTING button again to cancel MUTE mode.



### [4] Combining the currently playing sound with the desired image

- Simulcast playback  
Use this switch to monitor a video source other than the audio source. Press the VIDEO SELECT button repeatedly until the desired source appears on the display.

- Press the VIDEO SELECT button repeatedly until the desired source appears on the display.
- Select "SOURCE" using the video select button.
- Switch the program source to the component connected to the video input.



### [5] Checking the currently playing program source, etc.

- On screen display
  - Each time an operation is performed, a description of that operation appears on the display connected to the unit's VIDEO MONITOR OUT jack. Also, the unit's operating status can be checked during playback by pressing the remote control unit's ON SCREEN button.

Such information as the position of the input selector and the surround parameter settings is output in sequence.

Front panel display

- Descriptions of the unit's operations are also displayed on the front panel display. In addition, the display can be switched to check the unit's operating status while playing a source by pressing the PANEL button.

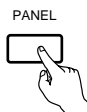
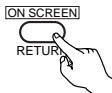

(Main unit)

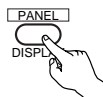

(Remote control unit)

### [2] Listening over headphones

Plug the headphones' plug into the jack.

- Connect the headphones to the PHONES jack.

The pre-out output (including the speaker output) is automatically turned off when headphones are connected.

#### NOTE:

To prevent hearing loss, do not raise the volume level excessively when using headphones.

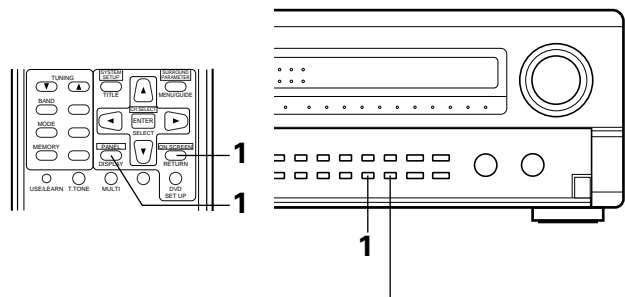
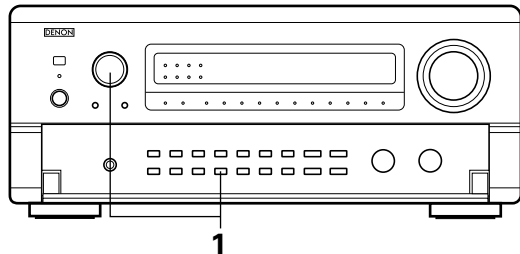
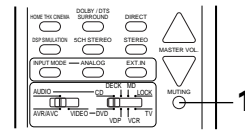
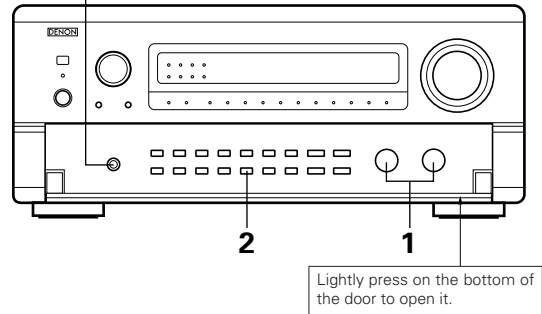

Using the dimmer function

- Use this to change the brightness of the display. The display brightness changes in four steps (bright, medium, dim and off) by pressing the remote control unit's DIMMER button repeatedly.
- The brightness changes in 3 steps each time the button is pressed, and finally the display turns off.

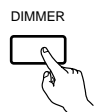

## Multi-source recording/playback

### [1] Playing one source while recording another (REC OUT mode)

**1** Press the REC/MULTI MODE button until "REC OUT SOURCE" appears on the set's display.

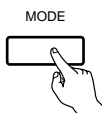

**2** Press the REC/MULTI SOURCE button until the source you want to record appears on the set's display.

- The indicator for the selected program source lights.

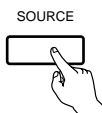

**3** Set the recording mode.

- For operating instructions, refer to the manual of the component on which you want to record.

**4** To cancel, press the REC/MULTI MODE button or press the REC/MULTI SOURCE button until "SOURCE" appears on the display.

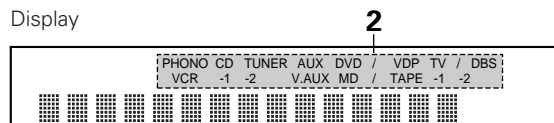
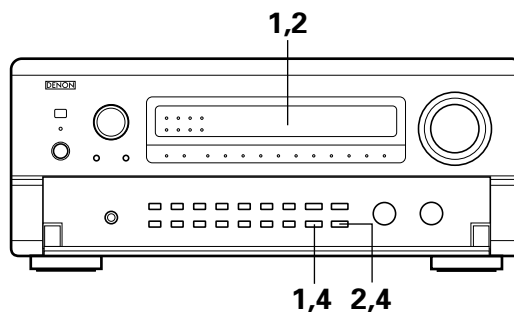
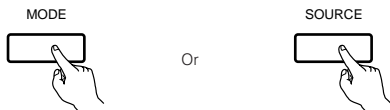

#### NOTES:

- Recording sources other than digital inputs selected in the REC OUT mode are also output to the multi source audio/video output jacks.
- Digital signals are not output from the REC SOURCE or audio/video output jacks.

### [2] Outputting a program source to an amplifier, etc., in a different room (MULTI mode)

**1** Press the REC/MULTI MODE button until "M-SOURCE SOURCE" appears on the set's display.

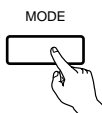

**2** Press the REC/MULTI SOURCE button until the source you want to output appears on the set's display.

- The "MULTI" indicator lights.
- The indicator for the selected program source lights.
- When the AVR-5700 is in the REC OUT mode, the source cannot be output using the MULTI button on the remote control unit.

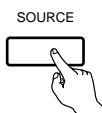

(Main unit)



(Remote control unit)

**3** Start playing the source to be output.

- For operating instructions, refer to the manuals of the respective components.

**4** To cancel, either press the REC/MULTI MODE button or press the REC/MULTI SOURCE button until "SOURCE" appears on the display.

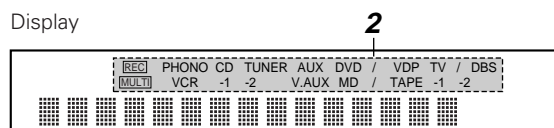
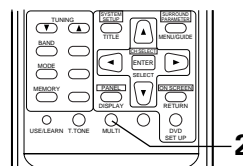
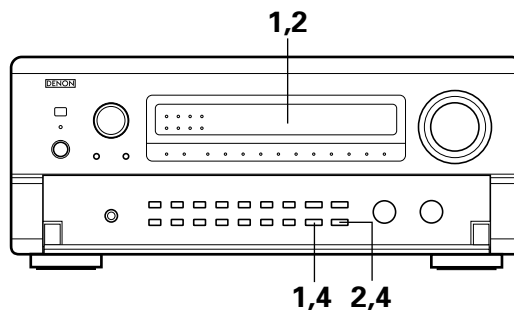
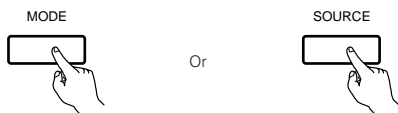

#### NOTES:

- The signals of the source selected in the MULTI mode are also output from the DAT/TAPE-1 and VCR recording output terminals.
- Digital signals are not output from the multi source audio output jacks.



## Playback using the external input (EXT. IN) jacks

- 1** Set the external input (6CH/8CH EXT. IN) mode. Press the 6CH/8CH EXT. IN (on the EXT. IN button on the remote control unit) to switch the external input.

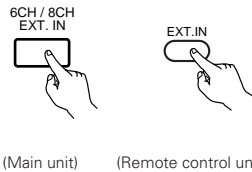

Once this is selected, the input signals connected to the FL (front left), FR (front right), C (center), SL (surround left) and SR (surround right) channels of the EXT. IN jacks are output directly to the front (left and right), center and surround (left and right) speaker systems as well as the pre-out jacks without passing through the surround circuitry.

In addition, the signal input to the SW (subwoofer) jack is output to the PRE OUT SUBWOOFER jack.

**When 6CH/8CH EXT. IN is selected, the input signals connected to the EL (effect left) and ER (effect right) jacks are output to the PRE OUT effect (left and right) jacks.**

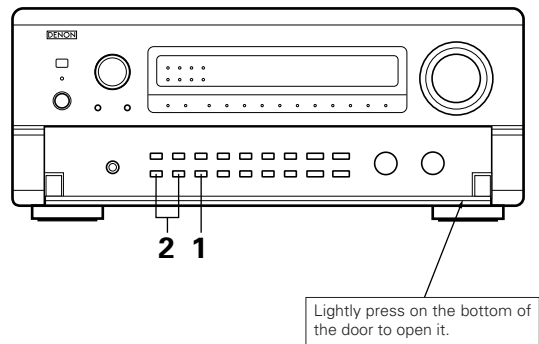

- 2** Canceling the external input mode  
To cancel the external input (6CH/8CH EXT. IN) setting, press the INPUT MODE or ANALOG button to switch to the desired input mode. (See page 37.)

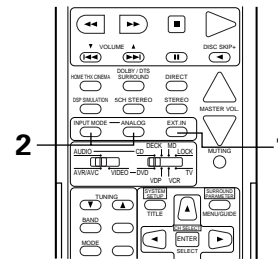
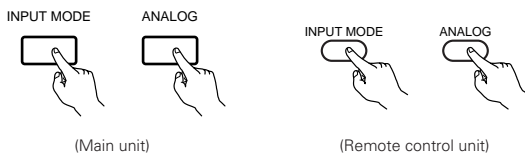

- When the input mode is set to the external input (6CH/8CH EXT. IN), the play mode (DIRECT, STEREO, DOLBY/DTS SURROUND, WIDE SCREEN, 5CH STEREO or DSP SIMULATION) cannot be set.

### NOTES:

- In play modes other than the external input mode, the signals connected to these jacks cannot be played. In addition, signals cannot be output from channels not connected to the input jacks.
- The external input mode can be set for any input source. To watch video while listening to sound, select the input source to which the video signal is connected, then set this mode.

## Multi-source and multi-zone playback

### MULTI ROOM MUSIC ENTERTAINMENT SYSTEM

- When the outputs of the MULTI SOURCE AUDIO OUT terminals are wired and connected to integrated amplifiers installed in other rooms, different sources can be played in rooms other than the main room in which this unit and the playback devices are installed. (Refer to ANOTHER ROOM on the diagram below.)
- When a sold separately room-to-room remote control unit (DENON RC-616, 617 or 618) is wired and connected between the main room and another room, the remote-controllable devices in the main room can be controlled from another room using the remote control unit.
- \* To control playback devices other than the ones above, either use that device's remote control unit or preset a separately sold programmable remote control unit.

#### NOTES:

- For the AUDIO output, use high quality pin-plug cords and wire in such a way that there is no humming or noise.
- For instructions on installation and operation of separately sold devices, refer to the devices' operating instructions.

### MULTI ROOM MUSIC ENTERTAINMENT SYSTEM

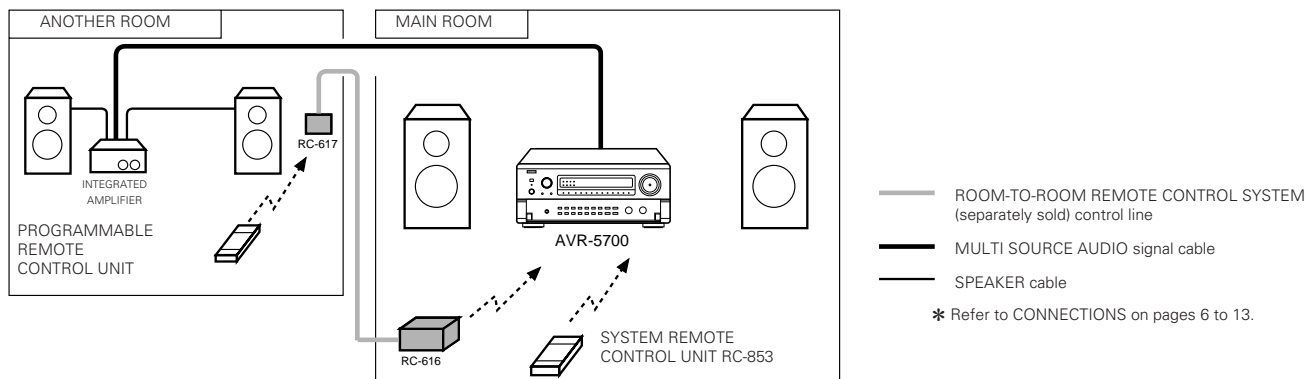

#### Room to Room Remote Control jacks

- The OUT jack is an extension jack for future use.
- When the OUT jack is connected, the signals input to the IN jack are output from the OUT jack directly. (Example: RC616 signals are output.)
- Do not connect only the OUT jack.  
(The signals from the AVR-5700's remote sensor are not output to this jack.)

## 10 SURROUND

### Before playing with the surround function

- Before playing with the surround function, be sure to use the test tones to adjust the playback level from the different speakers. This adjustment can be performed with the system setup (see page 22) or from the remote control unit, as described below.
- Adjusting with the remote control unit using the test tones is only possible in the "Auto" mode and only effective in the DOLBY SURROUND and HOME THX CINEMA modes. The adjusted levels for the different modes are automatically stored in the memory.

**1** Press the T. TONE button.



**2** Test tones are output from the different speakers. Use the channel volume adjust buttons to adjust so that the volume of the test tones is the same for all the speakers.



**3** After completing the adjustment, press the T. TONE button again.



\* Test tone signals are not output to the EL and ER channels.

- After adjusting using the test tones, adjust the channel levels either according to the playback sources or to suit your tastes, as described below.

**1** Select the speaker whose level you want to adjust.



The channel switches as shown below each time the button is pressed.

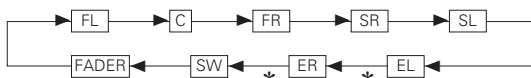

**2** Adjust the level of the selected speaker.



\* The EL and ER channels can only be adjusted when "6CH/8CH EXTERNAL INPUT" is selected.

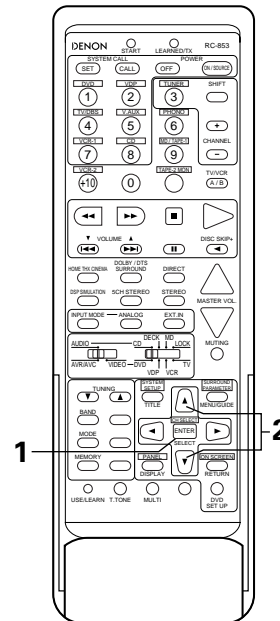
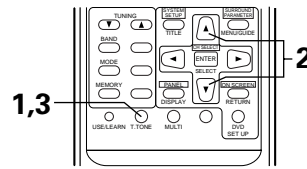

## Fader function

- This function makes it possible to lower the volume of the front channels (FL, C and FR) or the rear channels (SL and SR) together. Use it for example to adjust the balance of the sound from the different positions when playing multi-channel music sources.

- Select "FADER".



The channel switches in the order shown below each time this button is pressed.

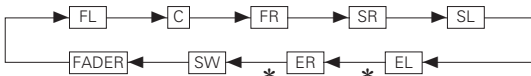

- \* The EL and ER channels can only be adjusted when "6CH/8CH EXTERNAL INPUT" is selected.

- Press the button to reduce the volume of the front channels, the button to reduce the volume of the rear channels.

- \* The fader function does not affect the SW, EL and ER channels.

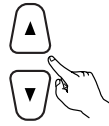

- \* The channel whose channel level is adjusted lowest can be faded to -12 dB using the fader function.
- \* If the channel levels are adjusted separately after adjusting the fader, the fader adjustment values are cleared, so adjust the fader again.

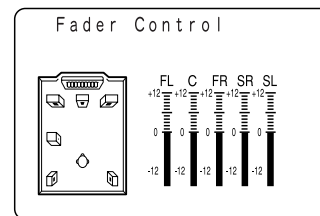
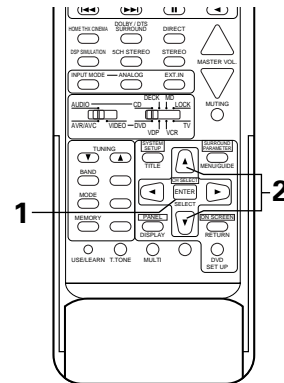

This is only displayed when setting the fader control.

## Dolby Surround Pro Logic mode

- Select the Dolby Surround Pro Logic mode.
  - The Dolby Pro Logic indicator lights.



(Main unit)



(Remote control unit)

Lit

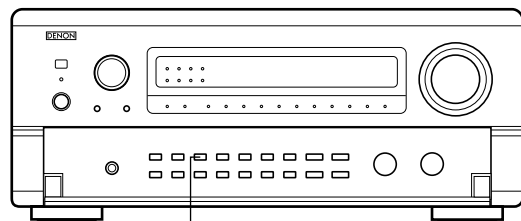

1

- Play a program source with the mark.
  - For operating instructions, refer to the manuals of the respective components.

### NOTE:

- There are four Dolby Surround Pro Logic modes (NORMAL, PHANTOM, WIDE and 3CH. LOGIC). The AVR-5700 sets the mode automatically according to the types of speakers set during the system setup process (page 18).

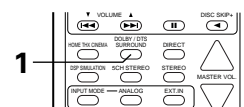

1

# Dolby Digital mode (only with Dolby Digital RF or digital input) and DTS Surround (only with digital input)

**1** Select the input source.

Playback with a Dolby Digital RF input

① Select VDP for the input.

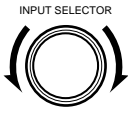

(Main unit)



(Remote control unit)

② Set the input mode to "AUTO" or "RF".

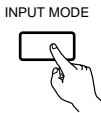

(Main unit)

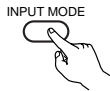

(Remote control unit)

Playback with a digital input

① Select an input source set to digital (COAXIAL/OPTICAL) (see page 25).

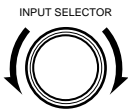

(Main unit)



(Remote control unit)

② Set the input mode to "AUTO" or "DIGITAL".

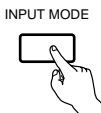

(Main unit)

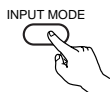

(Remote control unit)

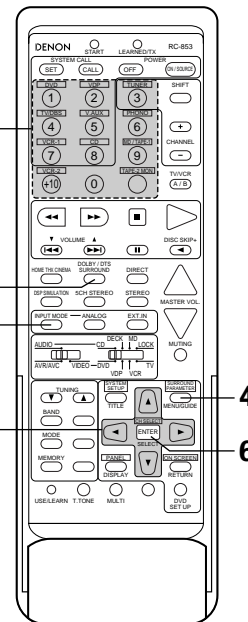
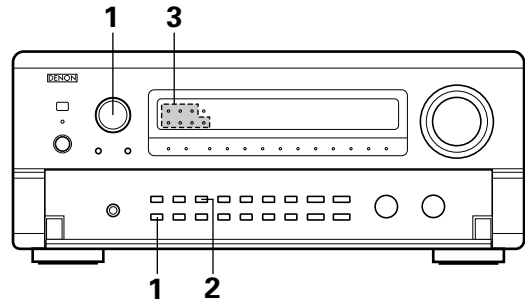

**2** Select the Dolby Surround mode.



(Main unit)



(Remote control unit)

**3** Play a program source with the , mark.

• The Dolby Digital indicator lights when playing Dolby Digital sources. Lit

For operating instructions, refer to the manuals of the respective components.

When the source is played, the input channel indicators indicating the signals included in the source light as shown on the diagram below. (The number of channels that lights depends on the input source.)

CH INDICATOR

L	C	R
O	O	O
SL	S	SR
O	O	O

L: Front left channel

C: Center channel

R: Front right channel

SL: Surround left channel

S: Mono surround channel

SR: Surround right channel

• Also, the following indicator lights if the software contains Low Frequency Effect sounds:

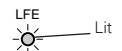

Lit



The DTS indicator lights when playing DTS sources.

4

Display the surround parameter menu.

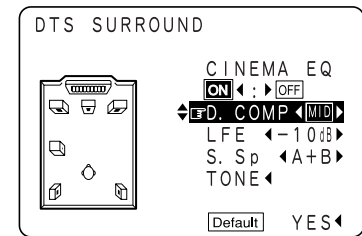
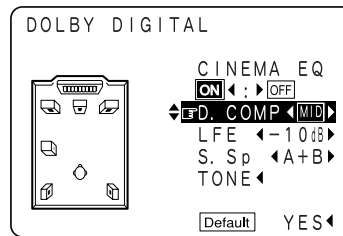
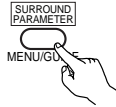

5

Select the various parameters.



6

Enter the setting.



#### NOTE:

- When "Default" is selected and the cursor button is pressed, "CINEMA EQ." and "D.COMP." are automatically turned off, "LFE" is reset, "S.Sp" is set to "A" and the tone is set to the default value.

#### Surround parameters ①

##### CINEMA EQ. (Cinema Equalizer):

The Cinema EQ function gently decreases the level of the extreme high frequencies, compensating for overly-bright sounding motion picture soundtracks. Select this function if the sound from the front speakers is too bright.

This function only works in the Dolby Pro Logic, Dolby Digital and DTS Surround modes.

##### D.COMP. (Dynamic Range Compression):

Motion picture soundtracks have tremendous dynamic range (the contrast between very soft and very loud sounds). For listening late at night, or whenever the maximum sound level is lower than usual, the Dynamic Range Compression allows you to hear all of the sounds in the soundtrack (but with reduced dynamic range). (This only works when playing program sources recorded in Dolby Digital or DTS.) Select one of the four parameters ("OFF", "LOW", "MID" (middle) or "HI" (high)). Set to OFF for normal listening.

##### LFE (Low Frequency Effect):

This sets the level of the LFE (Low Frequency Effect) sounds included in the source when playing program sources recorded in Dolby Digital or DTS.

If the sound produced from the subwoofer sounds distorted due to the LFE signals when playing Dolby Digital or DTS sources when the peak limiter is turned off with the subwoofer peak limit level setting (system setup menu), adjust the level as necessary.

Program source and adjustment range

- Dolby Digital: -10 dB to 0 dB
- DTS Surround (-10 dB to 0 dB)  
(-10 dB to 0 dB for the DTS Surround Home THX Cinema mode)

\* When watching a DTS-encoded Movie program, we recommend that you set the LFE level at 0 dB. When THX is activated with a DTS-encoded movie, the LFE level is automatically set to 0 dB. However, you can adjust it if you wish.

\* When listening to a DTS-encoded Music program, we recommend that you set the LFE level to -10 dB.

##### S.Sp (Surround Speaker):

Select the surround speaker to be used. This is not displayed if the surround speaker setting has been set to "None" in the system setup. It is also not displayed in the direct or stereo modes.

##### TONE:

This adjusts the tone control. (See "Surround parameters ②" on page 51.)

#### ■ Dialogue Normalization

The dialogue normalization function is activated automatically when playing Dolby Digital program sources.

Dialogue normalization is a basic function of Dolby Digital which automatically normalizes the dialog level (standard level) of the signals which are recorded at different levels for different program sources, such as DVD, DTV and other future formats that will use Dolby Digital.

When this function is activated, the following message appears on the main unit's display:

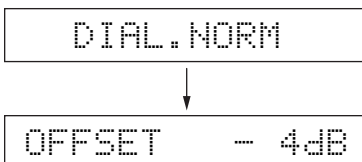

The number indicates the normalization level when the currently playing program is normalized to the standard level.

# Home THX Cinema mode

## [1] Playing sources recorded in Dolby Pro Logic in the Home THX Cinema surround mode

**1** Select the Home THX Cinema mode.



(Main unit)



(Remote control unit)

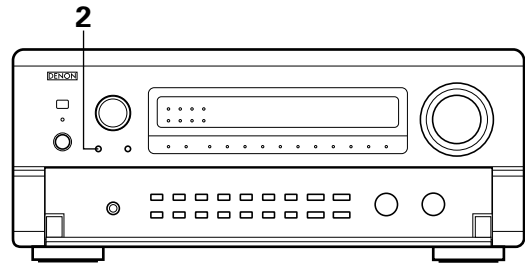

**2** Play a program source with the **DOLBY SURROUND** mark.  
 • For operating instructions, refer to the manuals of the respective components.

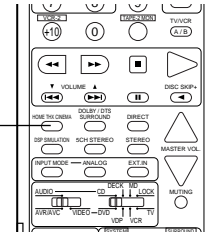

## [2] Playing sources recorded in Dolby Digital or DTS in the Home THX Cinema surround mode

**1** Select the program source  
 Selecting the Dolby Digital input

Perform step 1 under "Dolby Digital mode and DTS Surround" (page 45).

Selecting a digital input source

Perform step 1 under "Dolby Digital mode and DTS Surround" (page 45).

**2** Select the Home THX Cinema mode.



(Main unit)



(Remote control unit)

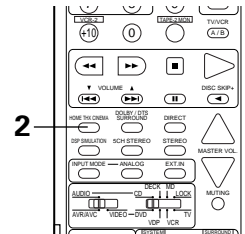
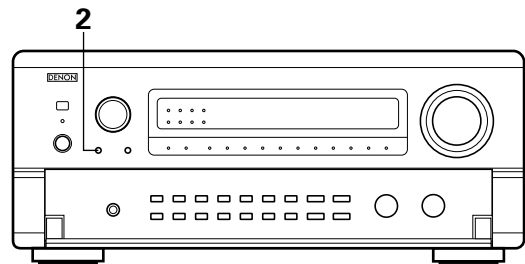

**3** Play a program source with the **DOLBY DIGITAL** or **dts** mark.

For operating instructions, refer to the manuals of the respective components.

When the source is played, the input channel indicators indicating the signals included in the source light as shown on the diagram below. (The number of channels that lights depends on the input source.)

CH INDICATOR			
L	C	R	L: Front left channel
O	O	O	C: Center channel
			R: Front right channel
SL	S	SR	SL: Surround left channel
O	O	O	S: Mono surround channel
			SR: Surround right channel

• Also, the following indicator lights if the software contains Low Frequency Effect sounds:

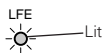

The DTS indicator lights when playing DTS sources.

## 11 DSP SURROUND SIMULATION

- The AVR-5700 is equipped with a high performance DSP (Digital Signal Processor) which uses digital signal processing to synthetically recreate the sound field. One of eight preset surround modes can be selected according to the program source and the parameters can be adjusted according to the conditions in the listening room to achieve a more realistic, powerful sound. These surround modes can also be used for program sources not recorded in Dolby Surround Pro Logic or Dolby Digital AC-3.

### Surround modes and their features

1	SUPER STADIUM	Select this when watching baseball or soccer programs to achieve a sound as if you were actually at the stadium. This mode provides the longest reverberation signals.
2	ROCK ARENA	Use this mode to achieve the feeling of a live concert in an arena with reflected sounds coming from all directions.
3	JAZZ CLUB	This mode creates the sound field of a live house with a low ceiling and hard walls. This mode gives jazz a very vivid realism.
4	CLASSIC CONCERT	Select this for the sound of a concert hall rich in reverberations.
5	MONO MOVIE (NOTE 1)	Select this when watching monaural movies for a greater sense of expansion.
6	MATRIX	Select this to emphasize the sense of expansion for music sources recorded in stereo. Signals consisting of the difference component of the input signals (the component that provides the sense of expansion) processed for delay are output from the surround channel.
7	WIDE SCREEN	Select this to create the sense that you are watching the program source on a larger screen and in a place with more reflected sound. This mode provides stronger reverberations for Dolby Digital and Dolby Pro Logic, and for DTS.
8	5CH STEREO	In this mode, the signals of the front left channel are output from the left surround channel, the signals of the front right channel are output from the right surround channel, and the same (in-phase) component of the left and right channels is output from the center channel. This mode provides all speaker surround sound, but without directional steering effects, and works with any stereo program source

- \* Depending on the program source being played, the effect may not be very noticeable. In this case, try other surround modes, without worrying about their names, to create a sound field suited to your tastes.

NOTE 1: When playing sources recorded in monaural, the sound will be one-sided if signals are only input to one channel (left or right), so input signals to both channels. If you have a source component with only one audio output (monophonic camcorder, etc.) obtain a "Y" adaptor cable to split the mono output to two outputs, and connect to the L and R inputs.

#### NOTE:

Only the DIRECT and 5CH STEREO modes can be used when playing PCM signals with a sampling frequency of 96 kHz (such as from DVD-Video discs that contain 24 bit, 96 kHz audio). If such signals are input during playback in one of the other surround modes, the mode automatically switches to DIRECT.

#### Personal Memory Plus

The AVR-5700 is equipped with a function called Personal Memory Plus which automatically stores the surround mode and level settings selected for the different input programs in the memory. The mode stored in the memory the last time the input program source was used is called out automatically when that program source is selected.

- \* Items automatically stored for the different input program sources with the Personal Memory Plus function

- ① Surround mode
- ② Surround parameter
- ③ Playback level balance for the different output channels
- ④ Type and settings of surround channel speakers
- ⑤ Tone control
- ⑥ Input mode selection function



# DSP surround simulation

**1** Select the surround mode for the input channel.

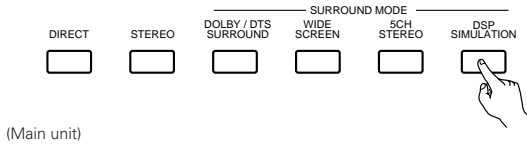

(Main unit)

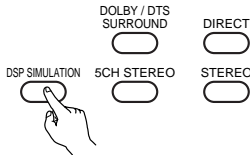

(Remote control unit)

The surround mode switches in the following order each time the DSP SIMULATION button is pressed:

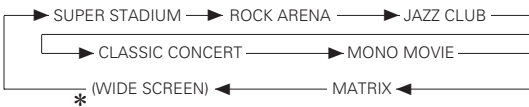

\* "WIDE SCREEN" can only be selected from the main unit.

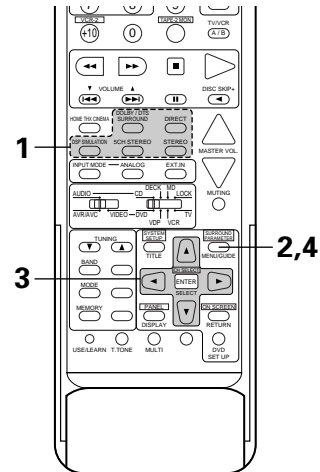
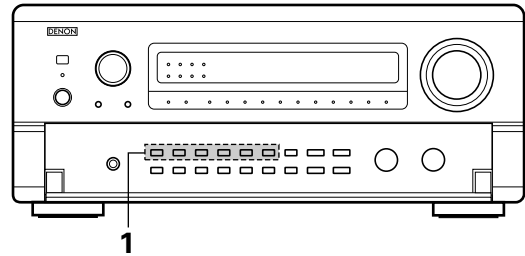

**2** Display the surround parameter screen on the monitor.  
\* The screen for the selected surround mode appears.

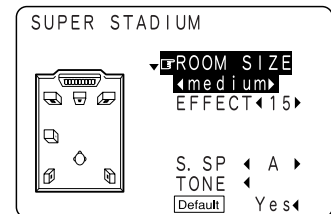
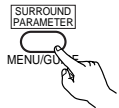

**3** Set the parameters.

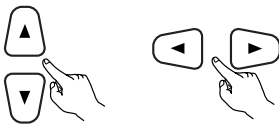

**4** To end the setting mode, press the surround parameter button again.



## NOTES:

- When "Default" is selected and the cursor button is pressed, "CINEMA EQ." and "D.COMP." are automatically turned off, "ROOM SIZE" is set to "medium", "EFFECT LEVEL" to "10" and "DELAY TIME" to "30ms".
- The "ROOM SIZE" expresses the expansion effect for the different surround modes in terms of the size of the sound field, not the actual size of the listening room.

## Tone control setting

- Use the tone control setting to adjust the bass and treble as desired.

- 1** Display the surround parameter screen on the monitor.  
 \* The screen for the selected surround mode appears. "TONE" cannot be selected in the Direct or Home THX Cinema mode.

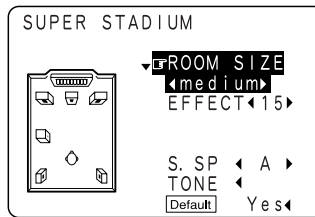
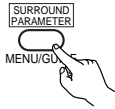

- 2** Select "TONE".

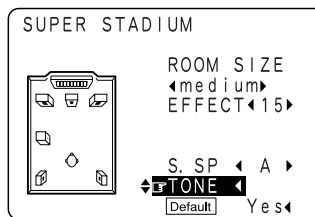
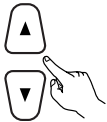

- 3** Switch to the Tone Control screen.

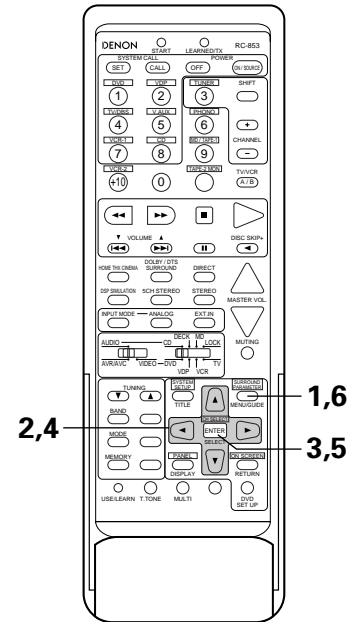

- 4** © To select Bass or Treble. © To set the level. \* If you do not want the tone to be adjusted, set "Tone Defeat" to "ON". (See page 39.)

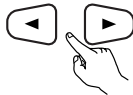
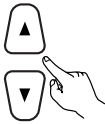

- 5** Enter the setting. The surround menu screen re-appears.



- 6** To end the setting mode, press the surround parameter button again.

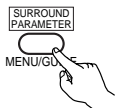

## Surround parameters ②

### ROOM SIZE:

This sets the size of the sound field.

There are five settings: "small", "med.s" (medium-small), "medium", "med.l" (medium-large) and "large". "small" recreates a small sound field, "large" a large sound field.

### EFFECT LEVEL:

This sets the strength of the surround effect.

The level can be set in 15 steps from 1 to 15. Lower the level if the sound seems distorted.

### DELAY TIME:

In the matrix mode only, the delay time can be set within the range of 0 to 300 ms.

### STONE CONTROL:

This can be set individually for the separate surround modes other than Direct and Home THX Cinema.

## ■ Surround modes and parameters

Mode	Signals and adjustability in the different modes												
	Channel output					Parameter (default values are shown in parentheses)						When playing Dolby Digital and DTS signals	
	FRONT L/R	CENTER	SURROUND L/R	SUB-WOOFER	EFFECT L/R	STONE CONTROL	CINEMA EQ.	ROOM SIZE	EFFECT LEVEL	DELAY TIME	D.COMP.	LFE	
DIRECT	○	●	●	⊙	●	●	●	●	●	●	○ (OFF)	○ (0dB)	
STEREO	○	●	●	⊙	●	○ (0dB)	●	●	●	●	○ (OFF)	○ (0dB)	
6CH/8CH EXTERNAL INPUT	○	⊙	⊙	⊙	○	○ (0dB)	●	●	●	●	●	●	
WIDE SCREEN	○	⊙	⊙	⊙	●	○ (0dB)	○ (OFF)	○ (Medium)	○ (10)	●	○ (OFF)	○ (0dB)	
DOLBY PRO LOGIC	○	●	●	⊙	●	●	●	●	●	●	○ (OFF)	○ (0dB)	
(THX CINEMA ON)	○	⊙	⊙	⊙	●	●	●	●	●	●	○ (OFF)	○ (0dB)	
(THX CINEMA OFF)	○	⊙	⊙	⊙	●	○ (0dB)	○ (OFF)	●	●	●	○ (OFF)	○ (0dB)	
DOLBY DIGITAL AC-3	○	●	●	⊙	●	●	●	●	●	●	○ (OFF)	○ (0dB)	
(THX CINEMA ON)	○	⊙	⊙	⊙	●	●	●	●	●	●	○ (OFF)	○ (0dB)	
(THX CINEMA OFF)	○	⊙	⊙	⊙	●	○ (0dB)	○ (OFF)	●	●	●	○ (OFF)	○ (0dB)	
DTS SURROUND	○	●	●	⊙	●	●	●	●	●	●	○ (OFF)	○ (0dB)	
(THX CINEMA ON)	○	⊙	⊙	⊙	●	●	●	●	●	●	○ (OFF)	○ (0dB)	
(THX CINEMA OFF)	○	⊙	⊙	⊙	●	○ (0dB)	○ (OFF)	●	●	●	○ (OFF)	○ (0dB)	
5CH STEREO	○	⊙	⊙	⊙	●	○ (0dB)	●	●	●	●	○ (OFF)	○ (0dB)	
SUPER STADIUM	○	⊙	⊙	⊙	●	○ (note 1)	●	○ (Medium)	○ (10)	●	○ (OFF)	○ (0dB)	
ROCK ARENA	○	⊙	⊙	⊙	●	○ (note 2)	●	○ (Medium)	○ (10)	●	○ (OFF)	○ (0dB)	
JAZZ CLUB	○	⊙	⊙	⊙	●	○ (0dB)	●	○ (Medium)	○ (10)	●	○ (OFF)	○ (0dB)	
CLASSIC CONCERT	○	⊙	⊙	⊙	●	○ (0dB)	●	○ (Medium)	○ (10)	●	○ (OFF)	○ (0dB)	
MONO MOVIE	○	⊙	⊙	⊙	●	○ (0dB)	●	○ (Medium)	○ (10)	●	○ (OFF)	○ (0dB)	
MATRIX	○	⊙	⊙	⊙	●	○ (0dB)	●	●	●	○ (30msec)	○ (OFF)	○ (0dB)	

○ : Signal/adjustable

⊙ : Turned on or off by speaker configuration setting

△ : Selected by speaker configuration setting

● : No signal/not adjustable

(Note 1) BASS: +6dB, TREBLE: 0dB

(Note 2) BASS: +8dB, TREBLE: +4dB

## 12 LISTENING TO THE RADIO

### Auto tuning

- 1** Set the input function to "TUNER".

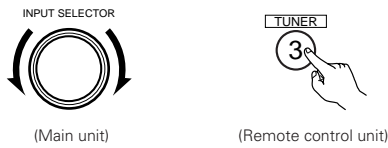

- 2** Watching the display, press the BAND button to select the desired band (AM or FM).



- 3** Press the MODE button to set the auto tuning mode.



"Auto" appears on the display.

- 4** Press the TUNING UP or DOWN button.

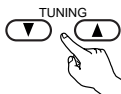

Automatic searching begins, then stops when a station is tuned in.

If tuning does not stop at the desired station, use the "Manual tuning" operation.

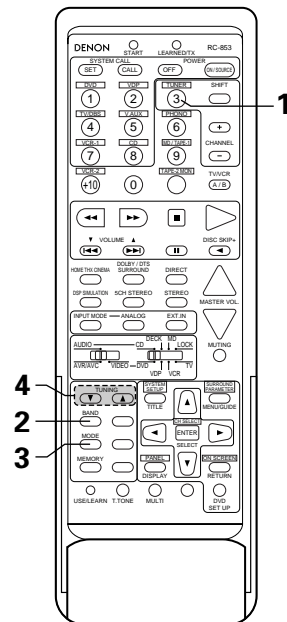
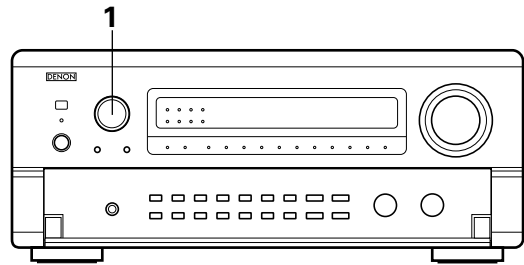

### Manual tuning

- 1** Set the input function to "TUNER".

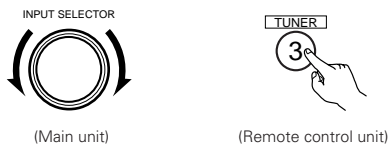

- 2** Watching the display, press the BAND button to select the desired band (AM or FM).



- 3** Press the MODE button to set the manual tuning mode. Check that the display's "AUTO" indicator turns.



- 4** Press the TUNING UP or DOWN button to tune in the desired station. The frequency changes continuously when the button is held in.

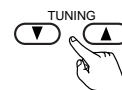

#### NOTES:

- When in the auto tuning mode on the FM band, the "STEREO" indicator lights on the display when a stereo broadcast is tuned in. At open frequencies, the noise is muted and the "TUNED" and "STEREO" indicators turn off.
- When the manual tuning mode is set, FM stereo broadcasts are received in monaural and the "STEREO" indicator turns off.

## Preset memory

**1** Use the "Auto tuning" or "Manual tuning" operation to tune in the station to be preset in the memory.

**2** Press the MEMORY button.



**3** Press the SHIFT button and select the desired memory block (A to D).

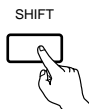

(Main unit)



(Remote control unit)

**4** Press the PRESET UP or DOWN button to select the desired preset channel (1 to 8).

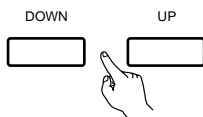

(Main unit)

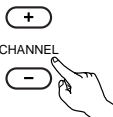

(Remote control unit)

**5** Press the MEMORY button again to store the station in the preset memory.



To preset other channels, repeat steps 2 to 5.  
A total of 40 broadcast stations can be preset — 8 stations (channels 1 to 8) in each of blocks A to E.

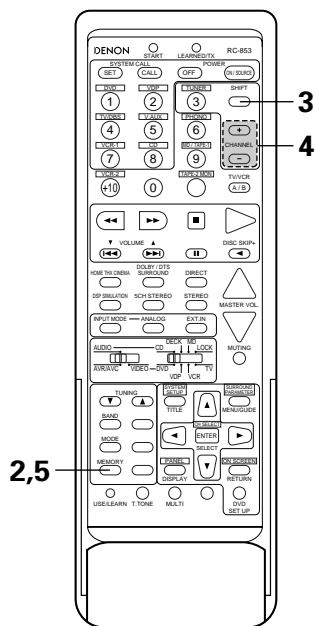
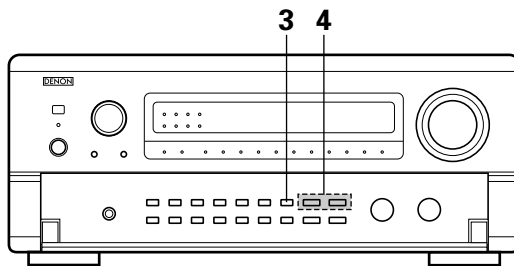

## Checking the preset stations

The preset broadcast stations can be checked on the on screen display.

**1** Press the ON SCREEN button repeatedly until the "Tuner Preset Stations" screen appears on the on screen display.

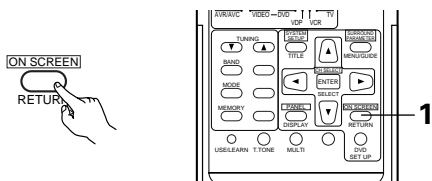

Tuner Preset Stations		
A 1 FM	87.5	0MHz
A 2 FM	89.1	0MHz
A 3 FM	98.1	0MHz
A 4 FM	107.9	0MHz
A 5 FM	90.1	0MHz
A 6 FM	90.1	0MHz
A 7 FM	90.1	0MHz
A 8 FM	90.1	0MHz

## Recalling preset stations

- 1** Watching the display, press the SHIFT button to select the preset memory block.



- 2** Watching the display, press the PRESET UP or DOWN button to select the desired preset channel.

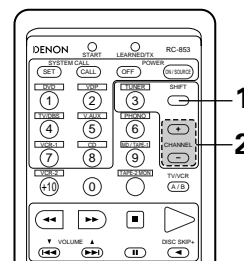
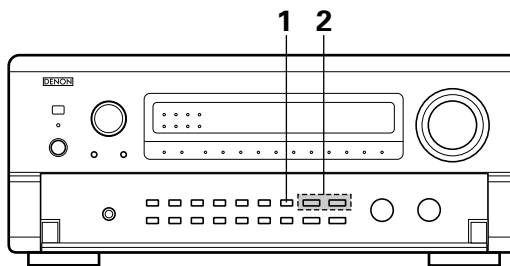
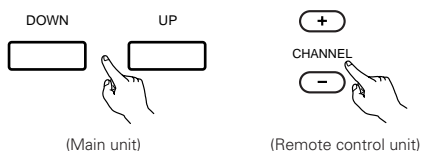

## 13 LAST FUNCTION MEMORY

- This unit is equipped with a last function memory which stores the input and output setting conditions as they were immediately before the power is switched off. This function eliminates the need to perform complicated resettings when the power is switched on.
- The unit is also equipped with a back-up memory. This function provides approximately one week of memory storage when the main unit's power switch is off and with the power cord disconnected.

## 14 INITIALIZATION OF THE MICROPROCESSOR

When the indication of the display is not normal or when the operation of the unit does not shows the reasonable result, the initialization of the microprocessor is required by the following procedure.

- 1** Switch off the unit using the main unit's power switch.
- 2** Hold the following DIRECT button and STEREO button, and turn the main unit's power switch on.
- 3** Check that the entire display is flashing with an interval of about 1 second, and release your fingers from the 2 buttons and the microprocessor will be initialized.

### NOTES:

- If step 3 does not work, start over from step 1.
- If the microprocessor has been reset, all the button settings are reset to the default values (the values set upon shipment from the factory).

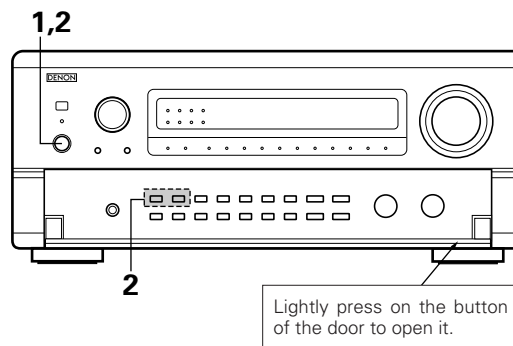

# 15 TROUBLESHOOTING

If a problem should arise, first check the following.

1. Are the connections correct ?
2. Have you operated the receiver according to the Operating Instructions ?
3. Are the speakers, turntable and other components operating properly ?

If this unit is not operating properly, check the items listed in the table below. Should the problem persist, there may be a malfunction. Disconnect the power immediately and contact your store of purchase.

	Symptom	Cause	Measures	Page
Common problems arising when listening to the CD, records, tapes, and FM broadcasts, etc.	DISPLAY not lit and sound not produced when power switch set to on.	<ul style="list-style-type: none"> <li>Power cord not plugged in securely.</li> </ul>	<ul style="list-style-type: none"> <li>Check the insertion of the power cord plug.</li> <li>Turn the power on with the remote control unit after turning the POWER switch on.</li> </ul>	6 36
	DISPLAY lit but sound not produced.	<ul style="list-style-type: none"> <li>Speaker cords not securely connected.</li> <li>Improper position of the audio function button.</li> <li>Volume control set to minimum.</li> <li>MUTING is on.</li> <li>Digital signals not input Digital input selected.</li> </ul>	<ul style="list-style-type: none"> <li>Connect securely.</li> <li>Set to a suitable position.</li> <li>Turn volume up to suitable level.</li> <li>Switch off MUTING.</li> <li>Input digital signals or select input jacks to which digital signals are being input.</li> </ul>	12 37 38 39 37
	DISPLAY not lit and power indicator is flashing rapidly.	<ul style="list-style-type: none"> <li>Speaker terminals are short-circuited.</li> <li>Block the ventilation holes of the set.</li> <li>The unit is operating at continuous high power conditions and/or inadequate ventilation.</li> </ul>	<ul style="list-style-type: none"> <li>Switch power off, connect speakers properly, then switch power back on.</li> <li>Turn off the set's power, then ventilate it well to cool it down. Once the set is cooled down, turn the power back on.</li> <li>Turn off the set's power, then ventilate it well to cool it down. Once the set is cooled down, turn the power back on.</li> </ul>	12 4, 5 4, 5
	Sound produced only from one channel.	<ul style="list-style-type: none"> <li>Incomplete connection of speaker cords.</li> <li>Incomplete connection of input/output cords.</li> </ul>	<ul style="list-style-type: none"> <li>Connect securely.</li> <li>Connect securely.</li> </ul>	12 6 ~ 13
	Positions of instruments reversed during stereo playback.	<ul style="list-style-type: none"> <li>Reverse connections of left and right speakers or left and right input/output cords.</li> </ul>	<ul style="list-style-type: none"> <li>Check left and right connections.</li> </ul>	12
	The on screen display is not displayed.	<ul style="list-style-type: none"> <li>"On screen display" is set to off on the system setup menu screen.</li> </ul>	<ul style="list-style-type: none"> <li>Set "on screen display" on the system setup menu screen to on.</li> </ul>	26, 27
When playing records	Humming noise produced when record is playing.	<ul style="list-style-type: none"> <li>Ground wire of turntable not connected properly.</li> <li>Incomplete PHONO jack connection.</li> <li>TV or radio transmission antenna nearby.</li> </ul>	<ul style="list-style-type: none"> <li>Connect securely.</li> <li>Connect securely.</li> <li>Contact your store of purchase.</li> </ul>	6 6 —
	Howling noise produced when volume is high.	<ul style="list-style-type: none"> <li>Turntable and speaker systems too close together.</li> <li>Floor is unstable and vibrates easily.</li> </ul>	<ul style="list-style-type: none"> <li>Separate as much as possible.</li> <li>Use cushions to absorb speaker vibrations transmitted by floor. If turntable is not equipped with insulators, use audio insulators (commonly available).</li> </ul>	— —
	Sound is distorted.	<ul style="list-style-type: none"> <li>Stylus pressure too weak.</li> <li>Dust or dirt on stylus.</li> <li>Cartridge defective.</li> </ul>	<ul style="list-style-type: none"> <li>Apply proper stylus pressure.</li> <li>Check stylus.</li> <li>Replace cartridge.</li> </ul>	— — —
	Volume is weak.	<ul style="list-style-type: none"> <li>MC cartridge being used.</li> </ul>	<ul style="list-style-type: none"> <li>Replace with MM cartridge or use a head amplifier or step-up transformer.</li> </ul>	6
Remote control unit.	This unit does not operate properly when remote control unit is used.	<ul style="list-style-type: none"> <li>Batteries dead.</li> <li>Remote control unit too far from this unit.</li> <li>Obstacle between this unit and remote control unit.</li> <li>Different button is being pressed.</li> <li>⊕ and ⊖ ends of battery inserted in reverse.</li> </ul>	<ul style="list-style-type: none"> <li>Replace with new batteries.</li> <li>Move closer.</li> <li>Remove obstacle.</li> <li>Press the proper button.</li> <li>Insert batteries properly.</li> </ul>	28 28 28 — 28

## 16 ADDITIONAL INFORMATION

### Optimum surround sound for different sources

There are currently various types of multi-channel signals (signals or formats with more than two channels).

#### ■ Types of multi-channel signals

Dolby Digital, Dolby Pro Logic, DTS, high definition 3-1 signals (Japan MUSE Hi-Vision audio), DVD-Audio, SACD (Super Audio CD), MPEG multi-channel audio, etc.

“Source” here does not refer to the type of signal (format) but the recorded content. Sources can be divided into two major categories.

#### ■ Types of sources

##### • Movie audio

Signals created to be played in movie theaters. In general sound is recorded to be played in movie theaters equipped with multiple surround speakers, regardless of the format (Dolby Digital, DTS, etc.).

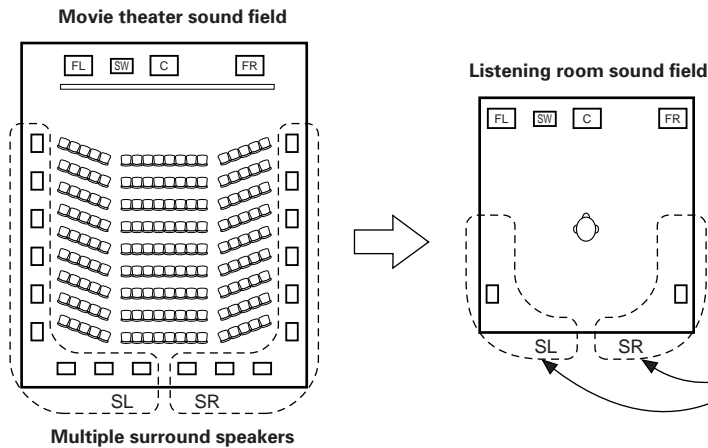

In this case it is important to achieve the same sense of expansion as in a movie theater with the surround channels. To do so, in some cases the number of surround speakers is increased (to four or eight) or speakers with bipolar or dipolar properties are used.

- **Other types of audio** These signals are designed to recreate a 360° sound field using three to five speakers.

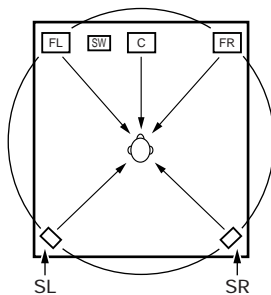

In this case the speakers should surround the listener from all sides to create a uniform sound field from 360°. Ideally the surround speakers should function as “point” sound sources in the same way as the front speakers.

These two types of sources thus have different properties, and different speaker settings, particularly for the surround speakers, are required in order to achieve the ideal sound.

The AVR-5700's surround speaker selection function makes it possible to change the settings according to the combination of surround speakers being used and the surrounding environment in order to achieve the ideal surround sound for all sources. This means that you can connect a pair of bipolar or dipolar surround speakers (mounted on either side of the prime listening position), as well as a separate pair of direct radiating (monopolar) speakers placed at the rear corners of the listening room.



## Speaker setting examples

Here we describe a number of speaker settings for different purposes. Use these examples as guides to set up your system according to the type of speakers used and the main usage purpose.

### (1) Basic setting for primarily watching movies

Use this setting if your main purpose is to listen to movie music and when using one set (two speakers) of regular single-way or two-way speakers as the surround speakers.

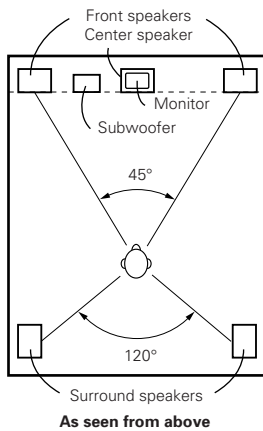

- Set the front speakers with their front surfaces as flush with the TV or monitor screen as possible. Set the center speaker between the front left and right speakers and no further from the listening position than the front speakers.
- Consult the owner's manual for your subwoofer for advice on placing the subwoofer within the listening room.
- If the surround speakers are direct-radiating (monopolar) then place them slightly behind and at an angle to the listening position and parallel to the walls at a position 60 to 90 centimeters (2 to 3 feet) above ear level at the prime listening position.
- Connect the surround speakers to the surround speaker A jacks on the AVR-5700 and set all settings on the setup menu to "A". (This is the factory default setting. For details, see page 16.)

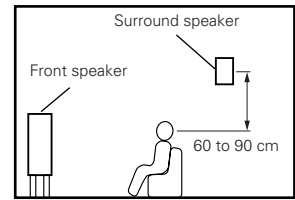

As seen from the side

### (2) Setting for primarily watching movies using diffusion type speakers for the surround speakers

For the greatest sense of surround sound envelopment, diffuse radiation speakers such as bipolar types, or dipolar (THX) types, provide a wider dispersion than is possible to obtain from a direct radiating speaker (monopolar). Place these speakers at either side of the prime listening position, mounted above ear level.

Path of the surround sound from the speakers to the listening position

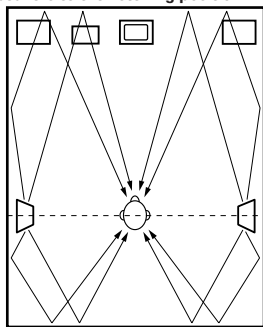

- Set the front speakers, center speaker and subwoofer in the same positions as in example (1).
- Set the surround speakers directly at the sides of the listening position and 60 to 90 centimeters (2 to 3 feet) above ear level.
- Connect the surround speakers to the surround speaker A jacks on the AVR-5700 and set all settings on the setup menu to "A". (This is the factory default setting. For details, see page 16.)
- The signals from the surround channels reflect off the walls as shown on the diagram at the left, creating an enveloping and realistic surround sound presentation.

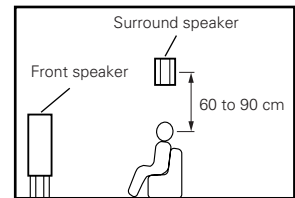

As seen from the side

For multi-channel music sources however, the use of bipolar or dipolar speakers mounted at the sides of the listening position may not be satisfactory in order to create a coherent 360 degree surround sound field. Connect another pair of direct radiating speakers as described in example (3) and place them at the rear corners of the room facing towards the prime listening position.

### (3) When using different surround speakers for movies and music

To achieve more effective surround sound for both movies and music, use different sets of surround speakers and different surround modes for the two types of sources.

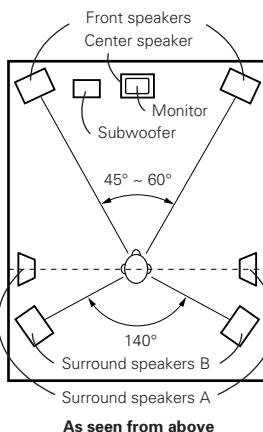

- Set the front speakers slightly wider apart than the setup for watching movies only and point them toward the listening position in order assure clear positioning of the sound.
- Set the center speaker in the same positions as in example (1).
- Set surround speakers A for watching movies in the positions described in example (1) or (2), depending on the types of speakers used.
- Set surround speakers B for playing multi-channel music at the same height as the front speakers and slightly at an angle to the rear of the listening position, and point them toward the listening position.
- Connect the surround speakers for watching movies to the surround speaker A jacks on the AVR-5700, the surround speakers for playing multi-channel music to the surround speaker B jacks. Set the surround speaker selection on the setup menu. (For instructions, see page 18.)
- To activate the appropriate speakers for movies and music, we suggest that during setup, choose Dolby Digital/DTS with THX and Surround Speakers A (the bipolar or dipolar speakers mounted at the sides of the listening position). Choose Dolby Digital/DTS without THX and Surround Speakers B (the direct radiating speakers mounted at the rear corners of the listening room). Then, by simply activating the THX function (used during movie playback, the Surround A speakers are automatically activated. For multi-channel music listening (Dolby Digital or DTS music programs), turn off the THX enhancements by touching the THX button on the remote control, and the Surround B speakers will be automatically activated.

Example: Movie sources (Dolby, DTS surround, etc.)

"THX" or "THX 5.1" mode: Speakers A

Music sources (DVD video, DTS CD, etc.)

"Dolby/DTS surround": Speakers B

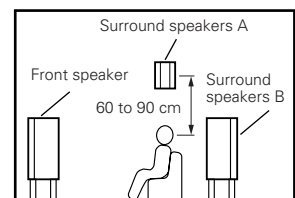

As seen from the side

\* The speakers can be switched at the touch of a button by turning HOME THX CINEMA on when playing movies and off when playing multi-channel music.

The surround speakers can be switched freely during playback with the surround parameter adjustment. (For instructions, see page 46.)

## Surround

The AVR-5700 is equipped with a digital signal processing circuit that lets you play program sources in the surround mode to achieve the same sense of presence as in a movie theater.

### Dolby Surround

#### (1) Dolby Digital (Dolby Surround AC-3)

Dolby Digital is the multi-channel digital signal format developed by Dolby Laboratories.

Dolby Digital consists of up to "5.1" channels - front left, front right, center, surround left, surround right, and an additional channel exclusively reserved for additional deep bass sound effects (the Low Frequency Effects – LFE – channel, also called the ".1" channel, containing bass frequencies of up to 120 Hz).

Unlike the analog Dolby Pro Logic format, Dolby Digital's main channels can all contain full range sound information, from the lowest bass, up to the highest frequencies – 22 kHz. The signals within each channel are distinct from the others, allowing pinpoint sound imaging, and Dolby Digital offers tremendous dynamic range from the most powerful sound effects to the quietest, softest sounds, free from noise and distortion.

#### ■ Dolby Digital and Dolby Pro Logic

Comparison of home surround systems	Dolby Digital	Dolby Pro Logic
No. recorded channels (elements)	5.1 ch	2 ch
No. playback channels	5.1 ch	4 ch
Playback channels (max.)	L, R, C, SL, SR, SW	L, R, C, S (SW - recommended)
Audio processing	Digital discrete processing Dolby Digital (AC-3) encoding/decoding	Analog matrix processing Dolby Surround
High frequency playback limit of surround channel	20 kHz	7 kHz

#### ■ Dolby Digital compatible media and playback methods

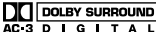
Marks indicating Dolby Digital compatibility:  and .

The following are general examples. Also refer to the player's operating instructions.

Media	Dolby Digital output jacks	Playback method (reference page)
LD (VDP) * 1 * 2 * 3	Coaxial Dolby Digital RF output jack * 1 * 2 * 3	Set the input mode to "AUTO" or "RF". (Page 37)
DVD * 2	Optical or coaxial digital output (same as for PCM) * 4	Set the input mode to "AUTO" or "DIGITAL". (Page 37)
Others (satellite broadcasts, CATV, etc.)	Optical or coaxial digital output (same as for PCM)	Set the input mode to "AUTO" or "DIGITAL". (Page 37)

\* 1 When playing in Dolby Digital with a Dolby Digital compatible LD player, connect the LD (VDP) player to the VDP function. (See page 25.)

\* 2 When the LD/DVD compatible player is equipped with Dolby Digital RF outputs, the LD's Dolby Digital output is output from the RF jacks and the DVD's Dolby Digital output is output from the optical or coaxial digital jacks. Select the input mode according to the type of media being played (LD or DVD). Also, if both the RF and Digital outputs are connected to the AVR-5700's VDP function, the input mode can be selected automatically by setting the "AUTO" mode (see page 45).

\* 3 If the player is switched from the pause or search mode to the play mode when playing an LD in the "AUTO" mode (see page 37), analog sound may be output momentarily before the sound switches to Dolby Digital. This is because the Dolby Digital RF signals output from the LD are not output during the pause and search modes, so during this type the input mode is switched according to the "AUTO" mode's signal priority order (see page 37). If this happens, switch to the "RF" (fixed RF input) mode. No analog sound will be output.

\* 4 Some DVD digital outputs have the function of switching the Dolby Digital signal output method between "bit stream" and "(convert to PCM)". When playing in Dolby Digital surround on the AVR-5700, switch the DVD player's output mode to "bit stream". In some cases players are equipped with both "bit stream + PCM" and "PCM only" digital outputs. In this case connect the "bit stream + PCM" jacks to the AVR-5700.

## (2) Dolby Pro Logic

Dolby Pro Logic is a multi-channel signal playback system developed by Dolby Laboratories which decodes sources recorded in Dolby Surround into four channels: front left, center, front right and surround (the surround channel is monaural, but is played through two surround speakers). Here, "sources recorded in Dolby Surround" are sources on which surround signals (three channels or more) are recorded onto two channels using Dolby Surround encoding technology. Dolby Surround recording is possible for all two-channel signal sources, including soundtracks on DVDs (\*), LDs or hi-fi VCRs (for which stereo signal recording is possible), stereo FM, TV and satellite broadcasts, stereo CD, MD and analog cassette tape recordings. Sources recorded in Dolby Surround are compatible with stereo playback, so they can be played in stereo on regular stereo equipment and in surround with Dolby Pro Logic processing. (DTS and Dolby Digital require special decoders to be played.)

With Dolby Pro Logic, the signal levels of the different channels of the source recorded in Dolby Surround are monitored, channels with higher signal levels are emphasized and the level of the other channels is decreased in order to reinforce the directivity and achieve an effective surround sound.

\* DVDs recorded in Dolby Surround include sources recorded in PCM and sources recorded in 2-channel Dolby Digital. For 2-channel Dolby Digital DVD sources, the DVD player's audio mode is 2-channel Dolby Digital, and the AVR-5700's surround mode is Dolby Pro Logic. Use the display pattern of the channel indicators (see page 45) to check whether the Dolby Digital signals are recorded in 2-channel stereo or Dolby Surround.

### ■ Dolby Pro Logic compatible media and playback methods

Mark indicating Dolby Pro Logic compatibility: 

When playing in Dolby Pro Logic, select the input signal according to how the player is connected to the AVR-5700, in the same way as selecting the stereo signal (see page 25). Set the surround mode to "DOLBY SURROUND" (see page 44) to play in Dolby Pro Logic.

Manufactured on license of the Dolby Laboratories Licensing Corporation.

"Dolby", "Pro Logic" and the double D mark are registered trademarks of the Dolby Laboratories Licensing Corporation.

Confidential and secret copyrighted material. Copyright 1992-1997, Dolby Laboratories Incorporated. Copying prohibited.

## DTS Digital Surround

Digital Theater Surround (also called simply DTS) is a multi-channel digital signal format developed by Digital Theater Systems.



DTS offers the same "5.1" playback channels as Dolby Digital (front left, front right and center, surround left and surround right) as well as the stereo 2-channel mode. The signals for the different channels are fully independent, eliminating the risk of deterioration of sound quality due to interference between signals, crosstalk, etc.

DTS features a relatively higher bit rate as compared to Dolby Digital (1234 kbps for CDs and LDs, 1536 kbps for DVDs) so it operates with a relatively low compression rate. Because of this the amount of data is great, and when DTS playback is used in movie theaters, a separate CD-ROM synchronized with the film is played.

With LDs and DVDs, there is of course no need for an extra disc; the pictures and sound can be recorded simultaneously on the same disc, so the discs can be handled in the same way as discs with other formats.

There are also music CDs recorded in DTS. These CDs include 5.1-channel surround signals (compared to two channels on current CDs). They do not include picture data, but they offer surround playback on CD players that are equipped with digital outputs (PCM type digital output required). DTS surround track playback offers the same intricate, grand sound as in a movie theater, right in your own listening room.

### ■ DTS compatible media and playback methods

Marks indicating DTS compatibility:  and .

The following are general examples. Also refer to the player's operating instructions.

Media	Dolby Digital output jacks	Playback method (reference page)
CD	Optical or coaxial digital output (same as for PCM) * 2	Set the input mode to "AUTO" or "DIGITAL" (page 37). Never set the mode to "ANALOG" or "PCM". * 1
LD (VDP)	Optical or coaxial digital output (same as for PCM) * 2	Set the input mode to "AUTO" or "DIGITAL" (page 37). Never set the mode to "ANALOG" or "PCM". * 1
DVD	Optical or coaxial digital output (same as for PCM) * 3	Set the input mode to "AUTO" or "DIGITAL" (page 37).

\* 1 DTS signals are recorded in the same way on CDs and LDs as PCM signals. Because of this, the un-decoded DTS signals are output as random "hissy" noise from the CD or LD player's analog outputs. If this noise is played with the amplifier set at a very high volume, it may possibly cause damage to the speakers. To avoid this, be sure to switch the input mode to "AUTO" or "DIGITAL" before playing CDs or LDs recorded in DTS. Also, never switch the input mode to "ANALOG" or "PCM" during playback. The same holds true when playing CDs or LDs on a DVD player or LD/DVD compatible player. For DVDs, the DTS signals are recorded in a special way so this problem does not occur.

\* 2 The signals provided at the digital outputs of a CD or LD player may undergo some sort of internal signal processing (output level adjustment, sampling frequency conversion, etc.). In this case the DTS-encoded signals may be processed erroneously, in which case they cannot be decoded by the AVR-5700, or may only produce noise. Before playing DTS signals for the first time, turn down the master volume to a low level, start playing the DTS disc, then check whether the DTS indicator on the AVR-5700 (see page 45) lights before turning up the master volume.

\* 3 A DVD player with DTS-compatible digital output is required to play DTS DVDs. A DTS Digital Output logo is featured on the front panel of compatible DVD players. Recent DENON DVD player models feature DTS-compatible digital output – consult the player's owner's manual for information on configuring the digital output for DTS playback of DTS-encoded DVDs.

Manufactured under license of Digital Theater Systems.

"DTS" and "DTS Digital Surround" are trademarks of Digital Theater Systems.

## Home THX Cinema surround mode

Home THX Cinema is a surround playback technology advocated by Lucasfilm of the United States, a company famous for the sound effects of such movies as Star Wars and Indiana Jones. This technology was born from the desire of movie director George Lucas to create the ultimate theater experience. THX Cinema technology includes both a design and performance certification program for movie theaters and a separate design and certification program for home theater equipment.

The THX Cinema program for theaters is used in over 3000 movie theaters throughout the world and is highly reputed for both its sound and picture quality.

The Home THX program includes proprietary Lucasfilm technology, coupled with an extensive certification process, which provides the listener with the most realistic reproduction in the home of motion picture soundtracks. Differences between the dubbing stage (sound mixing environment) and the motion picture theater are compensated for in home playback environments by the unique THX post-processing functions. THX is not a multi-channel encoding/decoding system (like Dolby Digital or DTS), but is a set of functions that enhance and improve upon the multi-channel decoded audio program material. So, for the best motion picture surround sound reproduction, choose THX with Dolby Digital, Dolby Surround Pro Logic or DTS. The THX processing can be de-activated at the touch of a button when listening to non-movie surround sound programs, such as music concerts, etc.

"THX 5.1" indicates the combination of a digital discrete multi-channel motion picture soundtrack as well as the specific THX multi-channel audio post-processing.

DENON was the first company in the world to offer THX 5.1 processing in a home theater component. The AVR-5700 is the world's first A/V receiver that incorporates the ability to have THX 5.1 surround sound with either Dolby Digital or DTS encoded programs.

The THX processor achieves clear dialogue, more effective sound positioning and directivity and a wide dynamic range. On the AVR-5700, when the Home THX Cinema mode is turned on, THX processing is automatically added after signal processing by the Dolby Digital, DTS, or Dolby Pro Logic decoder. The THX processing consists of the main components described below.

### (1) Re-equalizer:

In general, sound for movie theaters is recorded under the premise that the front and center channels will be output from behind the screen and that the sound will be played in large spaces that include many objects that absorb sound (movie theater seats, etc.). Because of this, the sound characteristics, particular the high frequency response, differs when the same soundtrack is played in the home (it can sound overly bright and harsh). The re-equalizer is a circuit that provides the compensation necessary to achieve natural high frequency sound in the home that matches that heard in the movie theater.

### (2) Timber matching circuit:

The human ear is directional, so the sound from a speaker set in front of the listener will seem different from the sound from the same speaker set at the listener's side. The timber matching circuit compensates for this, and particularly provides a natural sense of movement when the sound moves from the front to the surround and vice versa.

### (3) Dynamic decorrelation circuit:

In movie theaters, surround signals come from two banks of surround speakers, placed at the sides and at the rear of the theater. By using multiple loudspeakers in each surround bank, the audience hears the intended surround effect regardless of where they sit in the theater. Even with 5.1 soundtracks, surround sound information in the motion picture soundtrack is often monaural (sounds are common to both surround left and surround right channels). In the theater, the use of many surround speakers "spreads" the surround information over a wide area, minimizing the ability to localize the sound from a particular speaker. In the home however, monaural information in the soundtrack often provides an unusual result, with the surround sound strongly localized directly at the listening position, and is not perceived as enveloping, spacious surround sound as heard in the theater. The dynamic decorrelation circuit constantly monitors the content of the surround channels, and when monaural surround information is present, processes the sound to derive different signals that are sent to the left and right surround speakers. This provides rich, spacious and enveloping surround sound. The decorrelation circuit is always activated when listening to Dolby Surround Pro Logic programs, since the Pro Logic surround channel is always monaural.

THX 5.1 standards are extremely strict performance standards for AV amplifiers. Over 300 different performance parameters are checked, covering virtually all aspects of the component's performance, including use and operation, along with critical tests and measurements using specialized test tones along with highly revealing program material. The AVR-5700 is certified compliant with THX-ULTRA, Lucasfilm's strictest standards, a sign of quality assurance indicating that it offers the ultimate home theater performance and sound quality.

"Lucasfilm" and "THX" are registered trademarks of Lucasfilm.  
This set manufactured under license of Lucasfilm.



## 17 SPECIFICATIONS

### ■ Audio section

#### • Power amplifier

##### Rated output:

(All properties shown are only for the power amplifier stage.)

Stereo (2ch driven)

140 W + 140 W (8 Ω/ohms, 20 Hz ~ 20 kHz with 0.05% T.H.D.)

170 W + 170 W (8 Ω/ohms, 1 kHz with 0.7% T.H.D.)

Surround

140 W x 5 ch (8 Ω/ohms, 1 kHz with 0.7% T.H.D.)

##### Dynamic power:

190 W x 2 ch (8 Ω/ohms)

310 W x 2 ch (4 Ω/ohms)

390 W x 2 ch (2 Ω/ohms)

##### Output terminals:

Front/Center: 6 ~ 16 Ω/ohms

Surround: A or B 6 ~ 16 Ω/ohms

A + B 12 ~ 16 Ω/ohms

#### • Analog

##### Input sensitivity / input impedance:

200 mV / 47 kΩ/kohms

##### Frequency response:

10 Hz ~ 100 kHz: +0, -3 dB (DIRECT mode)

##### S/N:

105 dB (DIRECT mode)

##### Distortion:

0.005% (20 Hz ~ 20 kHz) (DIRECT mode)

##### Rated output/maximum output:

1.2 V / 8 V

##### Maximum headphones output:

284 mW (8 Ω/ohms)

#### • Digital

##### D/A output:

Rated output — 2 V (at 0 dB playback)

Total harmonic distortion — 0.005% (1 kHz, at 0 dB)

S/N ratio — 105 dB

Dynamic range — 96 dB

Format — Digital audio interface

##### Digital input:

#### • Phono equalizer (PHONO input — REC OUT)

##### Input sensitivity:

2.5 mV

##### RIAA deviation:

±1 dB (20 Hz to 20 kHz)

##### Signal-to-noise ratio:

74 dB (A weighting, with 5 mV input)

##### Rated output / Maximum output:

150 mV / 8 V

##### Distortion factor:

0.03% (1 kHz, 3 V)

### ■ Video section

#### • Standard video jacks

##### Input / output level and impedance:

1 Vp-p, 75 Ω/ohms

##### Frequency response:

5 Hz ~ 10 MHz — +0, -3 dB

#### • S-video jacks

##### Input / output level and impedance:

Y (brightness) signal — 1 Vp-p, 75 Ω/ohms

C (color) signal — 0.286 Vp-p, 75 Ω/ohms

##### Frequency response:

5 Hz ~ 10 MHz — +0, -3 dB

#### • Color component video terminal

##### Input / output level and impedance:

Y (brightness) signal — 1 Vp-p, 75 Ω/ohms

Cb (blue) signal — 0.7 Vp-p, 75 Ω/ohms

Cr (red) signal — 0.7Vp-p, 75 Ω/ohms

##### Frequency response:

5 Hz ~ 20 MHz — +0, -3 dB

### ■ Tuner section

##### Receiving Range:

[FM] (note: μV at 75 Ω/ohms, 0 dBf =  $1 \times 10^{-15}$  W)

87.5 MHz ~ 107.9 MHz

[AM]

520 kHz ~ 1710 kHz

##### Usable Sensitivity:

1.0 μV (11.2 dBf)

18 μV

##### 50 dB Quieting Sensitivity:

MONO 1.6 μV (15.3 dBf)

STEREO 23 μV (38.5 dBf)

##### Signal to Noise Ratio (IHF-A):

MONO 80 dB

50 dB

STEREO 75 dB

##### Total Harmonic Distortion (at 1 kHz):

MONO 0.15%

STEREO 0.3%

### ■ General

##### Power supply:

AC 120 V, 60 Hz

##### Power consumption:

11 A

##### Maximum external dimensions:

434 (W) x 181 (H) x 494 (D) mm (17-3/32" x 7-1/8" x 19-29/64")

##### Weight:

21.5 kg (47 lbs 6 oz)

### ■ Remote control unit (RC-853)

##### Batteries:

R6P/AA Type (two batteries)

##### External dimensions:

70 (W) x 215 (H) x 24 (D) mm (2-3/4" x 8-15/32" x 15/16")

##### Weight:

200 g (Approx. 7 oz) (including batteries)

\* For purposes of improvement, specifications and design are subject to change without notice.



**NIPPON COLUMBIA CO., LTD.**

14-14, AKASAKA 4-CHOME, MINATO-KU, TOKYO 107-8011, JAPAN

Telephone: (03) 3584-8111

Cable: NIPPON COLUMBIA TOKYO Telex: JAPANOLA J22591

Printed in Japan. 511 3418 005  901



## Free Manuals Download Website

<http://myh66.com>

<http://usermanuals.us>

<http://www.somanuals.com>

<http://www.4manuals.cc>

<http://www.manual-lib.com>

<http://www.404manual.com>

<http://www.luxmanual.com>

<http://aubethermostatmanual.com>

Golf course search by state

<http://golfingnear.com>

Email search by domain

<http://emailbydomain.com>

Auto manuals search

<http://auto.somanuals.com>

TV manuals search

<http://tv.somanuals.com>