



Comfort Glow™

**EF5802R
Freestanding
Electric Fireplace**

Installation Instructions and Homeowner's Manual

WARNING! IF THE INFORMATION IN THIS MANUAL IS NOT FOLLOWED EXACTLY, A FIRE MAY RESULT CAUSING PROPERTY DAMAGE, PERSONAL INJURY OR LOSS OF LIFE.



Comfort Home Products, Inc.
12256 William Penn Hwy, Suite A
Huntingdon, PA 16652
Made in China
Printed in China

FOR YOUR SAFETY

**DO NOT STORE
OR USE GASOLINE OR
OTHER FLAMMABLE VAPORS
OR LIQUIDS
IN THE VICINITY OF THIS OR
ANY OTHER APPLIANCE**

**COMFORT GLOW PHONE NUMBER: (814) 643-1775
<http://www.worldmkting.com>**

ANSI/UL 1278. MOVABLE AND WALL-OR CEILING HUNG ELECTRIC ROOM HEATERS

**INSTALLER: DO NOT DISCARD THIS MANUAL - LEAVE FOR HOME OWNER
CUSTOMER: PLEASE RETAIN THIS MANUAL FOR FUTURE USE**

TABLE OF CONTENTS

**PLEASE READ THE INSTALLATION & OPERATIONS INSTRUCTIONS
BEFORE USING THIS APPLIANCE**

IMPORTANT: Read all instructions and warnings carefully before starting installation. Failure to follow these instructions may result in a possible electric shock, fire hazard and will void the warranty.

INSTALLATION INSTRUCTIONS

GENERAL	3
LOCATING YOUR ELECTRIC FIREPLACE	4
CLEARANCE TO COMBUSTIBLES	4
ELECTRICAL CONNECTIONS	4
ELECTRICAL SPECIFICATIONS	4

OPERATING INSTRUCTIONS

ON/OFF SWITCH	5
HEATER CONTROLS	5
INSTRUCTIONS FOR REMOTE	6
INSTRUCTIONS FOR POWER	6

SERVICE INSTRUCTIONS

REPLACING LIGHT BULBS	7
GLASS INFORMATION	7
MAINTENANCE OF MOTORS	7
CLEANING INSTRUCTIONS	7
SPECIFICATIONS	8

REPLACEMENT PARTS LIST	9
-------------------------------	----------

IMPORTANT SAFETY INSTRUCTIONS

PLEASE RETAIN THIS USER'S GUIDE FOR FUTURE REFERENCE

When using electrical appliances, basic precautions should always be followed to reduce the risk of fire, electric shock, and injury to person, including following:

1. Read all instructions before using this appliance.
2. This fireplace is hot when in use. To avoid burns, do not let bare skin touch hot surfaces. The grill directly in front of the heater outlet becomes hot during heater operation. Keep combustible materials, such as furniture, pillows, bedding, papers, clothes, and curtains at least 3 feet from the front of the unit.
3. **CAUTION: Extreme caution is necessary when any heater is used by or near children or invalids and whenever the heater is left operating and unattended.**
4. **Always unplug heater when not in use.**
5. **Do not operate any fireplaces with a damaged cord or plug or after the heater has malfunctioned, or if the fireplace has been dropped or damaged in any manner. Take the fireplace to a authorized service facility for examination, electrical or mechanical adjustment or repair.**
6. Do not use outdoors.
7. This fireplace is not intended for use in bathrooms, laundry areas or similar indoor locations. Never locate the fireplace where it may fall into a bathtub or other water container.
8. Do not install the fireplace directly on carpet or a similar surface, which may restrict air circulation beneath the unit.
9. Do not run cord under carpeting. Do not cover cord with throw rugs, runners or the like. Arrange cord away from traffic areas and where it will not be tripped over
10. To disconnect fireplace, turn controls to the off position and remove plug from outlet. .
11. Do not insert or allow foreign objects to enter any ventilation or exhaust opening as this may cause electric shock, fire or damage to the appliance.
12. To prevent fire, do not block air intakes or exhaust in any manner. Do not use on soft surfaces, such as a bed, where openings may become blocked.
13. **CAUTION:** This appliance gets hot and it contains internal parts that could arc or spark. Do not use it in areas where gasoline, paint, or flammable liquids are used or stored. This electric fireplace should not be used as a drying rack for clothing. Also, do not have Christmas stockings or decorations hung on or near it.
14. Do not modify this fireplace. Use it only as described in this manual. Any other use not recommended by the manufacturer may cause fire, electric shock or injury to persons.
15. Avoid the use of an extension cord because it may overheat and cause a fire hazard. However if you must use an extension cord, the cord shall be 16 AWG, 1875 Watts.
16. Do not burn wood or other materials in this fireplace.
17. Do not strike fireplace glass.
18. Always use a certified electrician should new circuits or outlets been required.
19. Always use properly grounded, fused, and polarized outlets.
20. Always use ground fault protection where required by electrical code.
21. Always disconnect power before performing any cleaning, maintenance or relocation of the fireplace.
22. When transporting or sorting the fireplace and cord, keep in a dry place, free from excessive vibration and store so as to avoid damage.
23. Do not plug this product into a receptacle controlled by a wall switch or dimmer.
24. Do not exceed recommended bulb wattage. Using a higher wattage bulb could create a fire hazard or cause damage to your electric fireplace.
25. **SAVE THESE INSTRUCTIONS.**



WARNING: Procedures and techniques, which, if not carefully followed, will expose the user to the risk of serious injury, illness or death.



WARNING: Procedures and techniques, which, if not carefully followed, will result in damage to the equipment or personal property or may cause personal injury.

WARNING: This is a 1500 watt heater and parts become hot when in use. Be sure to maintain a personal distance and keep any combustible material at least three (3) feet away from the front of the heater. The area directly behind, around and under the heater must be clear and free of any obstructions.

KEEP CHILDREN AND PETS AWAY FROM HEATER AND CONTROLS

LOCATING YOUR ELECTRIC FIREPLACE

Your new freestanding electric fireplace may be installed virtually anywhere in your home. However, when choosing a location for your new electric fireplace, ensure that the general instructions are followed. For best results, install the electric fireplace out of direct sunlight.

CLEARANCE TO COMBUSTIBLES

Back.....0"/0mm
 Sides.....0"/0mm
 Floor.....0"/0mm
 Top.....24"/610mm
 Front.....36"/915mm

ELECTRICAL SPECIFICATIONS

Voltage.....120 VAC/60Hz
 Total Amps.....11.3 Amps
 Total Watts.....1500 Watts
 Heater Ratings.....1400 Watts (+5%, -10%)

ELECTRICAL CONNECTION

A 15 AMP, 120 Volt, 60Hz circuit with a properly grounded outlet is required. Preferably, the heater will be on a dedicated circuit. Other appliances on the same circuit may cause the circuit breaker to trip or the fuse to blow when the heater is in operation. The unit comes standard with a 6' (1828mm) long three wire cord exiting from the rear of the fireplace. Plan the installation to avoid the use of an extension cord. If an extension cord must be used, it must be a minimum 16 AWG three wire with grounding type plug connector and rated no less than 1900 Watts.



WARNING: Electrical outlet wiring must comply with local building codes and all other applicable regulations to reduce the risk of fire, electrical shock and injury.



WARNING: Do not use this fireplace if any part of it has been under water. Immediately call a qualified service technician to inspect the fireplace and replace any part of the electrical system if necessary.

OPERATING INSTRUCTIONS

Note: Ensure the circuit breakers for the power supply are turned on.

The controls are located behind the grill below front glass and can be accessed by pulling the grill up from the top, forward and down.

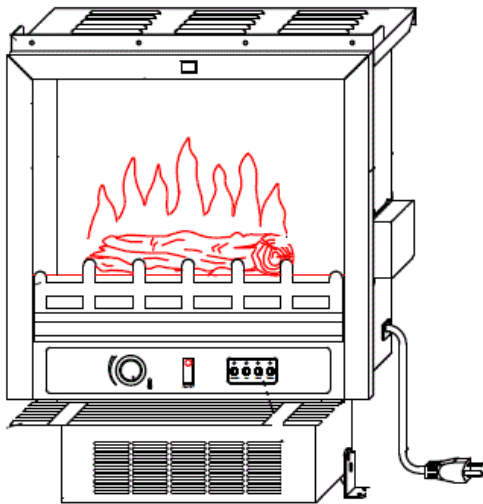

Main Power On/Off



Press this button for main power. The indicator light will turn on.

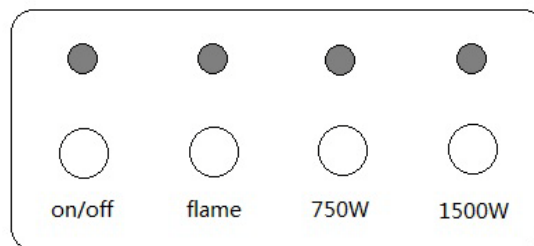

1. **ON/OFF Button:** Main power and flame effect. The red indicator light will turn on when heater is on.
2. **FLAME:** Press this button once for flame effect. The unit will beep and the indicator light will turn on. The bulbs for flame effect & log set will be on. Pressing button again will turn off the light function. Keep pressing down this button, the flame/log light will turn from bright to dim.
3. **750W:** For low heat function - Press this switch while the ON/OFF switch is in the ON position. The indicator light will turn on. Pressing button again will turn off the low heat function.
4. **1500W:** For high heat function - Press this switch while the ON/OFF switch and the 750W switch are in the ON position for high heat. The indicator light will turn on. Pressing button again will turn off the high heat function.
5. **Temperature Control:** To adjust the temperature to your individual requirements, turn the temperature control dial to the right (clockwise) to increase the desired temperature and to the left for lower temperature. This temperature control dial can only be used while the ON/OFF switch and 750W & 1500W switches are in the ON position. When the heater reaches the desired temperature the heater and 750W/1500W indicator light will turn off and the fan will stop working for air flow.

Note: When the ON/OFF switch is turned OFF, all other heater functions will stop even though the other switches may be in the ON position.

INSTRUCTIONS FOR REMOTE OPERATION

Plug in your electric fireplace, and turn on the Main Power On/Off switch on the right side of the front panel. It will beep once. This means you have power and your remote is ready to operate your electric fireplace.

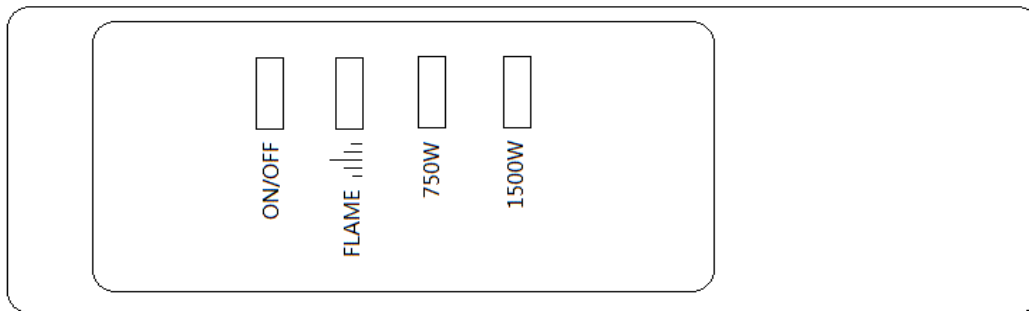

1. **ON/OFF:** Press this button to turn on the power.
2. **FLAME:** Press this button to turn on the flame effect. Keep pressing down this button, the flame/log light will turn from bright to dim. Pressing this button again will turn off the flame.
3. **750W Button:** Press this button and the fireplace will work at 750W. Pressing again will switch it off.
4. **1500W Button:** Press this button and the fireplace will work at 1500W. Pressing again will switch it off.

INSTRUCTIONS FOR POWER

This heater is for use on 120 volts only. The cord has a plug as shown at (A) in the following figure. An adapter as shown at (C) is available for connecting three-blade grounding-type plugs to two-slot receptacles. The green grounding lug extending from the adapter must be connected to a permanent ground such as a properly grounded outlet box. The adapter should not be used if a three-slot grounded receptacle is available.

WARNING: Before servicing this heater be sure to unplug heater from wall outlet. Do not only turn off heater from the main "ON/OFF" switch, be sure to unplug this heater

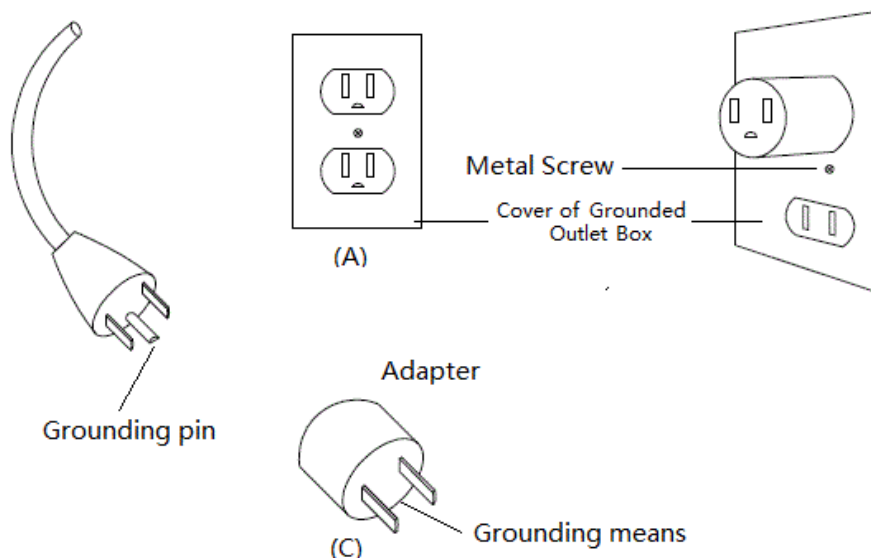

(Adapter NOT permitted in Canada)
Under CZ22.2 No. 0 Standard

SERVICE INSTRUCTIONS



WARNING: Disconnect power before attempting any maintenance or cleaning to reduce the risk of fire, electrical shock or personal injury.



WARNING: Do not exceed 40 Watts per light bulb. Use of a higher rated bulb may result in a fire causing property damage and personal injury.

REPLACING LIGHT BULBS

There is one (1) 40W Type B-10 light bulb located under the logset bed. Remove the four (4) screws on the cover located on the back of the fireplace and then remove the rear cover of the unit.



CAUTION: The bulb in your unit can become extremely hot. Allow at least 15 minutes between turning off the unit and removing the light bulb to

avoid hot bulb coming in contact with the skin.

Loosen and remove burnt out bulb, replace with 40W Type B-10 bulb.

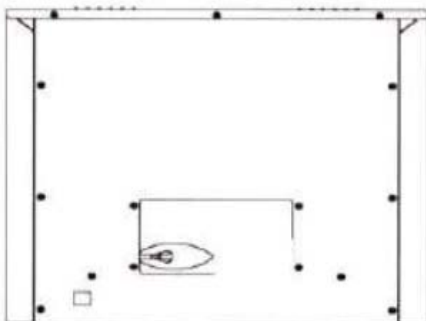
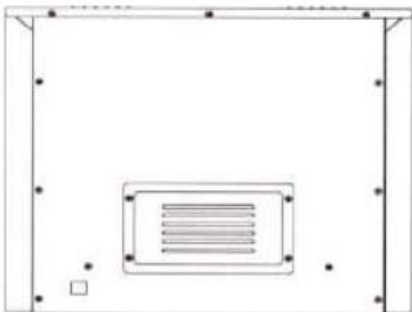

MAINTENANCE OF MOTORS

The motors used on both blower fan and flame simulator assembly are prelubricated for the extended warranty of the motor, no further lubrication is required. However, periodic cleaning/vacuuming of the fan/heater unit is recommended.

CAUTION: Even though the glass is safety glass it may break if bumped, struck or dropped. Care must be taken when handling the glass.

GLASS INFORMATION

1. Under no circumstances should this product be operated with missing or broken glass.
2. Do not strike or slam the glass.
3. Do not use abrasive cleaners to clean the glass.

CAUTION: Wait until the unit has completely cooled before attempting any cleaning.

CLEANING

To clean the unit, first turn off controls on unit and unplug unit from power source.

To clean the glass door: remove dust with clean dry cloth or to remove finger prints and other marks clean glass with clean damp cloth. Do not use abrasive cleaners or spray liquids on glass door surfaces.

Metal and metal painted parts should be cleaned with clean damp cloth only. Do not use abrasive cleaners or spray liquids on this surface

SPECIFICATIONS:

MODEL: EF5802R

VOLTAGE: 120V/60HZ

TOTAL AMPS: 11.3 AMPS

TOTAL WATTS: 1500W

HEATING RATINGS: 1400W (+5%, -10%)

DIMENSIONS, INCHES (H X W X D)

FIREPLACE: 40 X 11.4 X 41.3

CARTON: 44.5 X 42.9 X 15

REPLACEMENT PARTS LIST

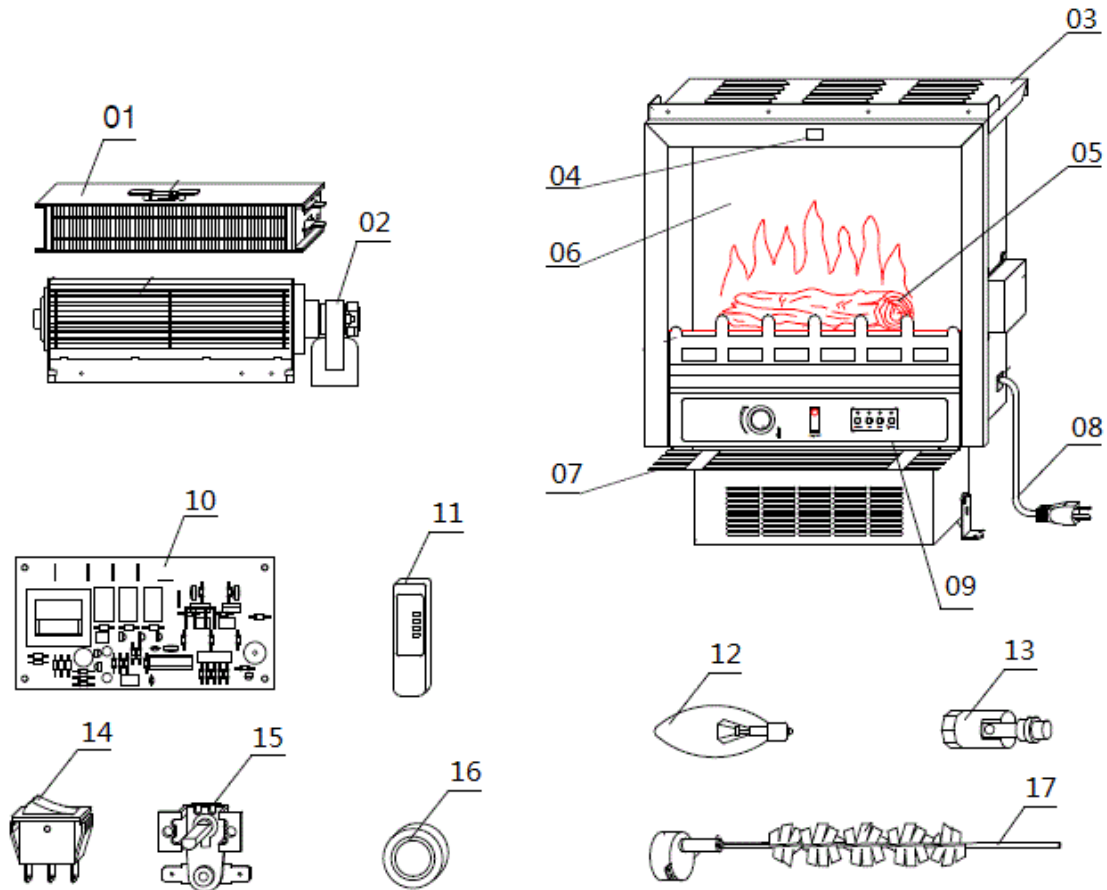

ITEM	DESCRIPTION	OEM
1, 2	Heater/Blower Assembly	NDF-65NBR/60,61,27, 62, 68
3	Heater Cabinet	NDF-65NBR/10, 11
4	Remote Receiver Cover.	NDF-65NBR/09A
5	Log Set	NDF-65NBR/37
6	Flame Screen	NDF-65NBR/14
7	Front Accessing Door	NDF-65NBR/04
8	Power Cord/Plug	NDF-65NBR/23
9	Touch pad	NDF-65NBR/62A
10	PCB Board	NDF-65NBR/43B
11	Remote Handset	NDF-65NBR/78
12	Bulb	NDF-65NBR/52
13	Bulb Socket	NDF-65NBR/51
14	Main Power Switch	NDF-65NBR/28
15	Thermostat Control Device	NDF-65NBR/31
16	Thermostat Knob	NDF-65NBR/32
17	Flame Reflector Assembly	NDF-65NBR/40,41,45,46

Free Manuals Download Website

<http://myh66.com>

<http://usermanuals.us>

<http://www.somanuals.com>

<http://www.4manuals.cc>

<http://www.manual-lib.com>

<http://www.404manual.com>

<http://www.luxmanual.com>

<http://aubethermostatmanual.com>

Golf course search by state

<http://golfingnear.com>

Email search by domain

<http://emailbydomain.com>

Auto manuals search

<http://auto.somanuals.com>

TV manuals search

<http://tv.somanuals.com>