

**1190Sr**

1190Sr

1190Sr

1190Sr

1190Sr

**Diamondback**

f i t n e s s 

**1190 Sr OWNER'S MANUAL**



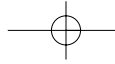

This is a sample Serial Number sticker only. Please check your own equipment where indicated for your serial number



Serial Number

### PURCHASER'S REFERENCE INFORMATION

IT IS IMPERATIVE THAT YOU FILL IN THE FOLLOWING INFORMATION AND REFER TO IT SHOULD THE NEED FOR SERVICE ARISE.

Product Name: Diamondback 1190Sr  
Serial Number: T \_\_\_\_\_

**To Activate Warranty:**

**1. REGISTER YOUR WARRANTY AT**  
**[www.diamondbackfitness.com](http://www.diamondbackfitness.com)**

**OR**

**2. COMPLETELY FILL OUT THE ATTACHED WARRANTY CARD (SEE BACK COVER) AND RETURN TO DIAMONDACK FITNESS WITH IN 15 DAYS OF THE DATE OF PURCHASE. FAILURE TO COMPLY WITH THE WARRANTY ACTIVATION PROCEDURE MAY VOID THE MANUFACTURER'S WARRANTY**

Dealer Name: \_\_\_\_\_

Dealer Address: \_\_\_\_\_

Dealer Telephone Number: (     ) \_\_\_\_\_

Dealer Contact Name: \_\_\_\_\_

Date Purchased: \_\_\_\_\_

**Shipping Materials:**

Diamondback recommends that you retain the original packing materials (box and packing items) for future shipping needs.



## TABLE OF CONTENTS

<b>Purchaser's Reference Information</b>	<b>2</b>
<b>Introduction</b>	<b>4</b>
<b>Safety Instructions and Warnings</b>	<b>5</b>
<b>1190Sr Assembly Drawing</b>	<b>6</b>
<b>1190Sr Assembly Instructions</b>	<b>7</b>
<b>Exercise Guidelines</b>	<b>10</b>
<b>Heart Rate Monitoring Devices</b>	<b>13</b>
<b>Console</b>	<b>15</b>
General Information	
<b>Console Layout &amp; Controls</b>	<b>16</b>
<b>Basic Operation</b>	<b>18</b>
<b>Workout Programs</b>	<b>20</b>
Warm Up	
Cool Down	
Workout Summary	
Quick Start	
Classic Programs	
Manual	
Random	
Interval	
Hill Climb	
Strength	
HR Interactive Programs	
Target HR	
HR Interval	
Fat Burner	
Cardio	
Demo Program	
<b>Maintenance</b>	<b>39</b>
<b>Domestic Warranty Information</b>	<b>40</b>
<b>Warranty Card</b>	<b>43</b>





## INTRODUCTION

### **GOOD HEALTH IS AN EXERCISE IN COMMON SENSE.**

The basics of good health are really common sense. Eat right, drink lots of water, get enough sleep, and exercise at least 3-4 times a week. It may sound simple, but to achieve the look and vitality most health-conscious men and women want, takes more discipline than most people are willing to endure. Having fitness equipment in your home makes it easier to achieve your goals. And having Diamondback equipment gives you even more of an edge. Because when your equipment is comfortable, simple and effective, you exercise more. And that means better results.

### **A WORKOUT THAT WORKS FOR YOU.**

To maintain cardiovascular fitness, the American Heart Association recommends that you exercise 3 to 4 days a week at 60% - 75% of your maximum heart rate. By monitoring your heart rate while you exercise, you can get the most effective workout in the least amount of time. It's the easiest way of determining if you're exercising at a safe and effective level. Of course, if you want to lose weight or reach a higher level of athletic conditioning, working out 5 to 6 times a week will help you achieve that goal faster.

### **GET A SMART START ON EXERCISING.**

1. Always stretch before your workout to loosen muscles, and afterwards to cool down.
2. The first few minutes of your workout should be devoted to warming up muscles before a vigorous workout, and building your heart rate slowly.
3. After your aerobic workout of about 24-32 minutes, spend 10 minutes gradually reducing your heart rate with a lower resistance level.
4. The 1190Sr console contains integrated warm up and cool down programs to safely bring your heart rate up and back down again.

Remember, start slow, with intensity low, until you build endurance and strength. And always consult your physician before beginning any exercise program.

Your feedback and ideas about your experience with Diamondback are very important to us. Write to our product development department at:

*300 Camarillo Ranch Road, Camarillo, CA 93012.*

## SAFETY INSTRUCTIONS AND WARNINGS

This unit is built for optimum safety and is designed to meet or exceed all domestic and international standards. However, certain precautions need to be followed when operating any exercise equipment. **BE SURE TO READ THE ENTIRE OWNER'S MANUAL BEFORE OPERATING THIS PRODUCT.**

### CAUTION – FOR SAFE OPERATION

1. Keep your hands and feet away from all moving parts and pinch points. See figure A for possible pinch points.
2. Before beginning any exercise program, it is important to consult with your physician if you have any of the following:  
History of heart disease, high blood pressure, diabetes, chronic respiratory diseases, elevated cholesterol, or if you smoke cigarettes or experience any other chronic diseases or physical complaints.
3. If over the age of 35 or overweight, consult with your physician before beginning any exercise program.
4. Pregnant women should consult with their physician before beginning an exercise program.
5. If you experience dizziness, nausea, chest pains or other abnormal symptoms during exercise, stop the exercise session immediately. Consult your physician before continue your exercise.
6. Always drink fluids if you exercise for twenty or more minutes.

### WARNING – TO REDUCE RISK OF INJURY TO YOURSELF OR OTHERS

1. To ensure proper functioning of your equipment, do not install attachments or accessories not provided or recommended by Diamondback Fitness.
2. Keep your hands and feet away from all moving parts.
3. Before beginning any exercise program, consult your physician.
4. Always wear proper clothing and shoes when exercising.
5. User weight is not to exceed 325 lbs/148 kilograms on the 1190Sr.
6. Keep children away from equipment. Hands and feet may get caught in the pedals or other moving parts which could result in serious injury. Keep your hands and feet away from all moving parts.
7. Place the unit in an area that will meet minimum clearance requirements:
  - Front, Back & Sides: 4 feet/30cm
8. Keep this equipment away from walls to allow proper ventilation. Air should be able to circulate freely around the units. Keep all air openings free of dirt and dust. Never insert anything into openings.
9. This unit is intended for indoor use in the home environment only. It is not intended for outdoor use.
10. Drink fluids if you exercise for twenty or more minutes.
11. Place the unit on a solid, level surface when in use.
12. Never operate the unit if it is damaged or broken. Contact your local authorized Diamondback Fitness dealer for service.
13. Make sure all components are fastened securely (i.e. seat post, saddle, handlebars, pedals) at all times.

SAVE THESE INSTRUCTIONS FOR YOUR REFERENCE.



**Figure A**



Possible Pinch Points on 1190Sr.

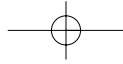

# ASSEMBLY DRAWING

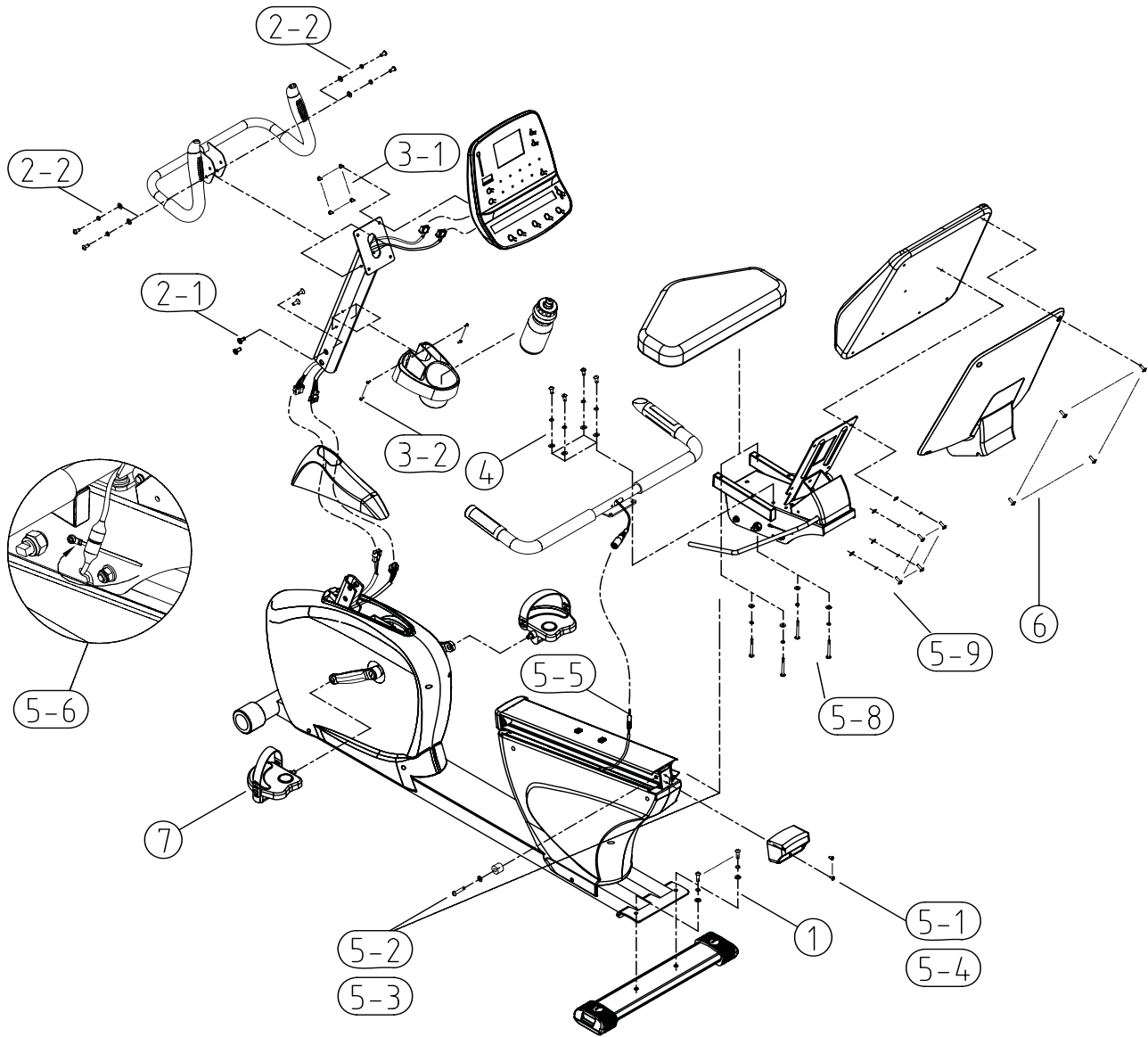

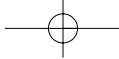

## ASSEMBLY INSTRUCTIONS

### Tools Required:

- 5mm Allen key wrench (included)
- 6mm Allen key wrench (included)
- Phillips head screwdriver
- Two open-ended adjustable wrenches for seat slide adjustment.

The assembly drawing on the preceding page highlights each step for easy identification. Bolts, screws, and washers in the included hardware kit are arranged according to each step below.

### Step 1: Rear Stabilizer Bar

Place rear stabilizer bar onto the rear of the frame as illustrated and align the bolt holes. Insert and tighten the two M8 x 25mm bolts, making sure to include a flat and split lock washer on each bolt.

### Step 2: Console Mast & Handlebar

2-1. Install the console mast:

- 2-1a. Slide console mast cover onto bottom of console mast.
- 2-1b. Connect both the main wire harness and the hand pulse harness in the main frame to the two wire harnesses in the bottom of the console mast. Each plug is keyed to fit in only one direction- do not try to force the plugs into the sockets as this may bend the pins.
- 2-1c. Install the console mast by sliding it over the receptor in the main frame while pulling on the wiring harness. This will keep the slack out of the harness so the wires will not get pinched and damaged. Insert and tighten the four flat head M8 x 16mm bolts (make sure to use the flat head bolts for this step).
- 2-1d. Snap console mast cover into top of sidecase.

2-2. Fasten the handlebar on to the console mast by sliding the bracket in the middle of the handlebar over the bolt holes in the console mast. Be careful not to move the bracket around too much on the mast to avoid scratching the mast. Secure the handlebar to the mast with the four round head M8 x 16mm bolts, making sure to include a flat and split lock washer on each bolt

### Step 3: Console & Bottle Holder

3-1. Connect the plugs from the main wiring harness and hand pulse harness to the sockets on the backside of the console circuit board. Each plug is keyed to fit in only one direction- do not try to force the plug into the socket as this may bend the pins. Then, fasten the console to the console mast with four M5 x 12mm screws.

3-2. Place the bottle holder on the console mast. Insert and tighten four M5 x 12mm screws. Insert the water bottle into the bottle holder. (Note: Some 1190Sr units have a different bottle holder design that requires only two screws).

3-2. Place the bottle holder on the console mast. Insert and tighten two M5x12mm



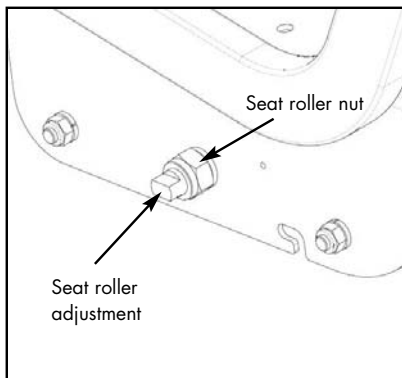

## ASSEMBLY INSTRUCTIONS

screws. Insert the water bottle into the bottle holder.

### Step 4: Rear Handlebar

Install the rear handlebar onto the seat frame. Insert and tighten the four M8x16mm bolts, making sure to include a flat and split lock washer on each bolt.

### Step 5: Seat & Seat Back

- 5-1. Undo the two screws holding the plastic rear endcap to the back of the seat track. Slide the endcap off the seat track.
- 5-2. Undo the bolt holding the seat bumper to the side of the seat track. Remove the seat bumper. Then, slide the entire seat frame into the rear end of the seat track channel while holding the seat frame adjusting handle up, making sure the three rollers on each side of the seat frame are inside the channel. Then, release the adjusting handle to lock the seat frame in position.
- 5-3. Replace the seat bumper and re-tighten the bolt.
- 5-4. Replace the rear endcap and re-tighten the two screws.
- 5-5. Connect the plug from the hand pulse wiring harness on the seat handlebar to the jack on the retracting cable hanging out of the sidecase.
- 5-6. Pull the harness thru the L-shaped slot in the seat frame and secure it onto the side of the seat frame using the included nylon zip tie (see illustration 5-6 in assembly drawing).
- 5-7. Tighten the seat frame on to the seat track so that it does not "wobble" side to side. This can be done by adjusting the middle seat rollers on each side of the seat frame as shown in the picture to the left.
  - 5-7a. Find the middle seat roller adjustment on the right side of the seat frame (under the seat) as shown in the picture.
  - 5-7b. While using an open-end wrench to hold the adjustment knob, loosen the seat roller nut by turning it counter-clockwise with a second open-end wrench.
  - 5-7c. Tighten the seat frame into the seat track by turning the adjustment knob clockwise. Do not overtighten as this may prevent the seat from sliding along the track.
  - 5-7d. Hold the adjustment knob in position with one wrench while you re-tighten the seat roller nut with the second wrench.
  - 5-7e. Repeat steps a-d above with the middle seat roller adjustment on the left side of the seat frame.

The seat should now slide easily along the seat track without "wobbling" side to side.

*Note: The middle seat rollers may need to be readjusted periodically as they wear.*

- 5-8. Install seat pad on the seat frame using the four M6 x 60mm screws, making





## ASSEMBLY INSTRUCTIONS

sure to include a flat and split lock washer on each bolt.

5-9. Install seat back pad on the seat frame using the four M6 x 15mm screws, making sure to include a flat and split lock washer on each bolt.

### **Step 6: Seat Back Cover**

Install the seat back cover over the back of the seat using the four M6 x 15mm screws.

### **Step 7: Pedal Assembly**

Use a 15mm or adjustable open-end wrench to firmly tighten the pedals to the cranks. The left and right pedals are different and are denoted as right or left (R or L) on the top & bottom of each pedal. Note that the left pedal will thread counter-clockwise.

*Note: Pedals should be re-tightened after the first 10 hours of use as they may become loose until they have fully seated to the crank.*



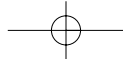

## EXERCISE GUIDELINES



### Good health is an exercise in common sense

The Surgeon General released a new study in 2001, The Surgeon General's Call To Action To Prevent and Decrease Overweight and Obesity. It indicates that 61% of American adults are either overweight or obese. It indicates that 61% of American adults are either overweight or obese. The study concludes that obesity increases the risk of health problems, such as heart disease, certain types of cancer, type 2 diabetes, etc. It further points out that obesity needs to be regarded primarily as a Health rather than as an Appearance issue.

The Surgeon General's Healthy weight advice for consumers is:

1. Aim for a healthy weight: Find your Body Mass Index (BMI) on the chart below.
2. Be active: Keep physically active to balance the calories you consume.
3. Eat well: Select sensible portion sizes.

$$\text{BMI} = (\text{weight (lb)} \div \text{height}^2 \text{ (in)}) \times 703$$

Weight in Pounds

	120	130	140	150	160	170	180	190	200	210	220	230	240	250
<b>4'6</b>	29	31	34	36	39	41	43	46	48	51	53	56	58	60
<b>4'8</b>	27	29	31	34	36	38	40	43	45	47	49	52	54	56
<b>4'10</b>	25	27	29	31	34	36	38	40	42	44	46	48	50	52
<b>5'0</b>	23	25	27	29	31	33	35	37	39	41	43	45	47	49
<b>5'2</b>	22	24	26	27	29	31	33	35	37	38	40	42	44	46
<b>5'4</b>	21	22	24	26	28	29	31	33	34	36	38	40	41	43
<b>5'6</b>	19	21	23	24	26	27	29	31	32	34	36	37	39	40
<b>5'8</b>	18	20	21	23	24	26	27	29	30	32	34	35	37	38
<b>5'10</b>	17	19	20	22	23	24	26	27	29	30	32	33	35	36
<b>6'0</b>	16	18	19	20	22	23	24	26	27	28	30	31	33	34
<b>6'2</b>	15	17	18	19	21	22	23	24	26	27	28	30	31	32
<b>6'4</b>	15	16	17	18	20	21	22	23	24	26	27	28	29	30
<b>6'6</b>	14	15	16	17	19	20	21	22	23	24	25	27	28	29
<b>6'8</b>	13	14	15	17	18	19	20	21	22	23	24	25	26	28

Height in Feet and Inches

Healthy Weight
  Overweight
  Obese

Note: This chart is for adults (aged 20 years and older).

### Heart rate is an important key to your exercise.

The Surgeon General also released a report on physical activity and health. This report definitively stated that exercise and fitness are beneficial for a person's health and redefined that exercise is a key component of disease prevention and healthier living.



## EXERCISE GUIDELINES (CONTINUED)

Medical research has shown us that there is an amount of exercise, which is enough to condition the cardio respiratory system and the muscles of the body. This amount of exercise is between 60% and 85% of your maximum heart rate measured during a training session. This range allows enough exercise to achieve fitness, but not an excessive amount to cause injury. Your heart rate is an excellent indicator of the amount of stress placed on the cardiovascular system. Taking full advantage of this information, the 1190Sr is designed to include heart rate monitoring features.

If exercise intensity is too low or too high, no gains will be made in fitness. If the intensity is too low, the stress levels are ineffective. If the intensity is too high, injury or fatigue may set your exercise program back as you try to recover.

The best way to monitor exercise intensity is to accurately count your pulse during exercise. Your heart rate can easily be determined by counting your pulse at the chest, wrist or at the carotid artery on your neck. It is difficult to count your own pulse during exercise, mainly because you cannot count fast enough to get an accurate number. The 1190Sr is equipped with a wireless telemetry receiving system. What it does is automatically count your heart rate while you are wearing a heart rate chest belt during your exercising period. Heart rate is monitored and electronically displayed as a digital readout. Your target heart rate, the intensity needed to improve cardiovascular fitness, depends primarily on your age and not your state of fitness. It is calculated as a percentage of your maximum heart rate, estimated as 220 minus your age. It is most effective to train at your target heart rate between 60% and 85% of your maximum heart rate.

### Maximum Heart Rate & Training Zone

To calculate your maximum heart rate and find your training zone, use the following formula. An example has been provided below based for a 35-year-old person:

$220 - \text{Age} = \text{Maximum Heart Rate}$	$(220 - 35 = 185)$
60% of Maximum Heart Rate	$(60\% \times 185 = 111\text{bpm})$
85% of Maximum Heart Rate	$(85\% \times 185 = 157\text{bpm})$
Training Zone:	111bpm – 157bpm



### Heart Rate Guidelines 60% - 85% Maximum Target

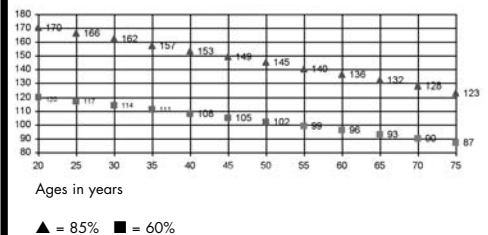



### Typical Target Zone Exercise Patterns for 35 year-old

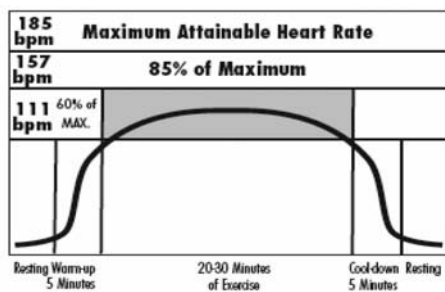

## EXERCISE GUIDELINES (CONTINUED)

### Quantity & Quality

It is recommended that you accumulate at least 30 minutes of physical activity most days of the week. Physical activity should be initiated slowly and the intensity should be increased gradually. You should select activities that you enjoy and can fit into your daily life.

The American College of Sports Medicine makes the following recommendations for the quantity and quality of training for developing and maintaining cardio-respiratory fitness in healthy adults:

- An activity that uses large muscle groups, maintained continuously, and is rhythmical and aerobic in nature.
- Duration: 20 to 60 minutes of continuous aerobic activity, including a warm-up and cool-down period for each exercise session.
- Frequency: 3 to 5 times per week.
- Intensity: 60% to 85% of maximum heart rate.
- In addition to aerobic exercise, it is recommended that you add strength training of moderate intensity twice per week to your program.

### Get a smart start on exercising.

Anyone over the age of 35, as well as younger persons whom are overweight, should check with his/her physician before beginning any type of exercise program. People who have diabetes or high blood pressure, a family history of heart disease, high cholesterol or have lead a sedentary lifestyle should protect themselves with a medical check-up and a stress test, preferably administered during exercise by a healthcare professional.

1. Always stretch before your workout to loosen muscles, and afterwards to cool down.
2. The first few minutes of your workout should be devoted to warming up muscles before a vigorous workout, and building your heart rate slowly.
3. After your aerobic workout of about 24-32 minutes, spend 10 minutes gradually reducing your heart rate with a lower resistance level.

*Remember, to start slow, with intensity low, until you build endurance and strength. And always consult your physician before beginning any exercise program.*



## HEART RATE MONITORING DEVICES

### Pulse Hand Grips (Standard)

The 1190Sr is heart rate controlled and comes standard with stainless steel pulse handgrips. To activate, gently grasp both handgrips to obtain a heart rate reading.

*(Note: It is recommended to wear a chest strap for Heart Rate control programs, as it is more accurate. If you wear a chest strap and use hand grips at the same time for heart rate monitoring purposes, the console will take the measurement from the chest strap.)*

If you are not getting a consistent reading while using the hand pulse option, we recommend the following suggestions:

- Make sure that the palms of the hands are touching the contact area of each hand pulse grip.
- Maintain an even pressure on the grips.
- Do not hold the hand pulse grips too tightly.

### Chest Strap (Standard)

The 1190Sr is equipped with a built-in receiver and a chest strap for your heart rate monitoring. To get an accurate reading using these devices, you will need to be within three feet of the console, and a minimum of four feet from others using a heart rate monitoring device.

*(Note: The transmitter may fluctuate erratically if you are too close to other heart rate monitoring equipment or if there are other electronics near by, such as TV, cell phone, etc...)*

The receiver of the wireless ECG system is built into the console. While using heart rate control programs, the computer monitors the exact measurement of and control over the activity of the heart. Heart rate is displayed while the computer continually compares heart rate to the preprogrammed personal data. The computer adjusts the pedal resistance level to maintain heart rate at the optimum setting.

### How to Wear Your Sensor/ Transmitter

1. Moisten the conductive electrode strips located next to the buckles with water.
2. Buckle one end of the chest strap onto the transmitter.
3. Adjust the band length so that the fit is snug against your skin.



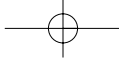

## HEART RATE MONITORING DEVICES



4. Buckle the other end of the chest strap onto the transmitter.
5. Center the transmitter on your chest below the pectoral muscles (breasts).

*(Note: The transmitter is on automatically when being worn. It is off when it is not connected to your body. However, as moisture may activate the transmitter, thoroughly dry the transmitter to prolong battery life.)*



## CONSOLE

### **Glossary of Terms**

- Intensity level = The resistance level provided by the unit. The resistance gradually increases as the level goes up. There are 20 levels of resistance.
- Idle mode = Console is reset and waiting for an entry. The message display window will flash a message of "Select a program".
- LEDs = The lights on the face of the console.
- Watts = The amount of power generated by the 1190 unit's braking system during a workout.
- Work = The amount of energy expended during exercise.

### **Default values**

- Age = 35 years
- Weight = 155 lbs (70kg)
- Time = 30 minutes
- Intensity level: Level 1



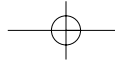

# CONSOLE LAYOUT AND CONTROLS

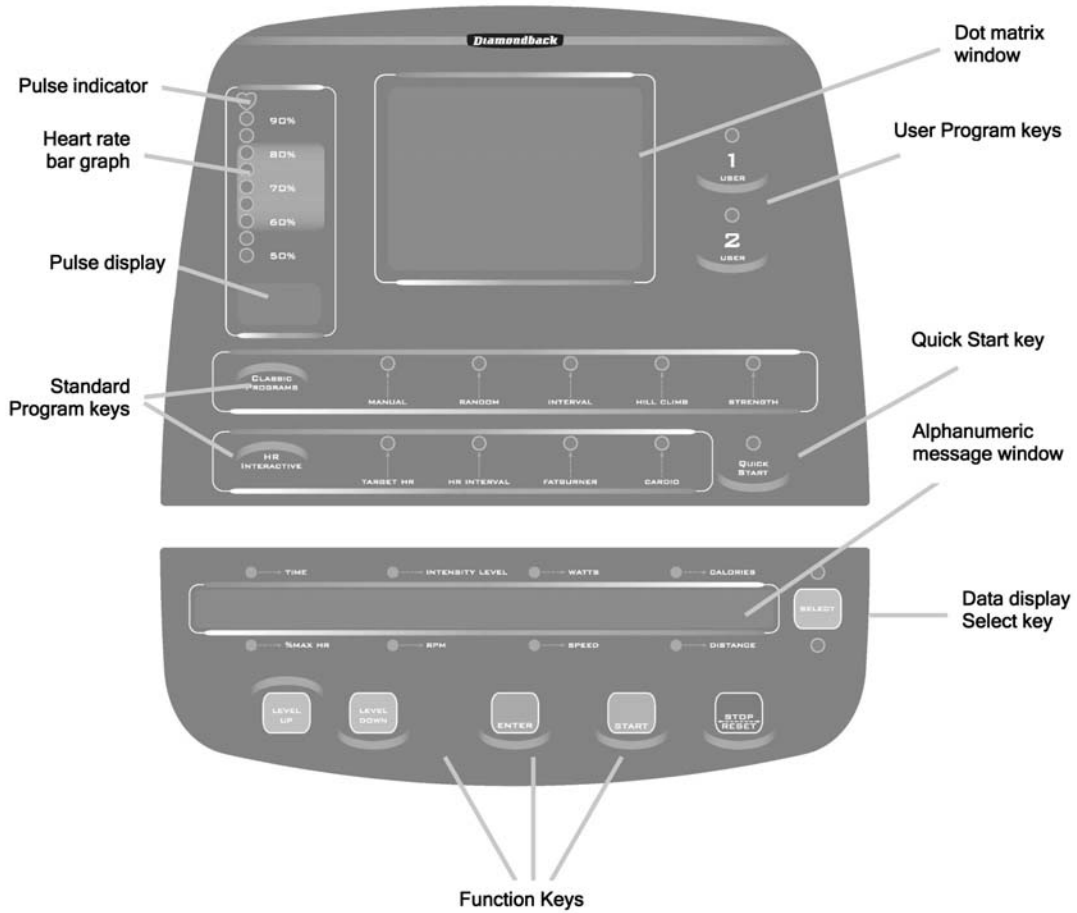

## Handlebar Controls

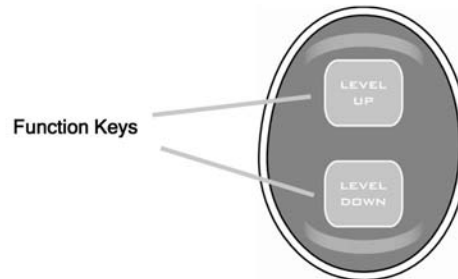



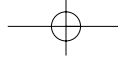

## CONSOLE LAYOUT AND CONTROLS

**Pulse Indicator:** Blinks to indicate that a pulse is currently being detected from the grip sensors or chest strap.

**Heart Rate Bar Graph:** Indicates whether you are currently in the ideal heart rate percentage range. This display will only be active when using the grip sensors or chest strap for heart rate feedback.

**Pulse Display:** Shows current pulse rate in beats per minute (BPM). This display will only be valid when using the grip sensors or chest strap for heart rate feedback. If the pulse display does not receive a heart rate reading, it will display three dashes (- - -).

**Standard Program Keys:** To begin a built-in program, simply press any program key once and an associated LED will light up to indicate this program has been activated. Two types of standard programs are included in the 1190 software: Classic programs allow a traditional, non-heart rate controlled workout. HR Interactive programs attempt to monitor and regulate your heart rate during the workout using the chest strap or grip sensors as feedback.

**User Program Keys:** These keys allow you to save a custom workout routine to electronic memory for recall at any time in the future.

**Quick Start Key:** Pressing this key will activate the Quick Start program. The Quick Start program allows a simple workout with no warm up or cool down period and requires no user data entry.

**Dot Matrix Window:** During a program run, the program profile (resistance or heart rate, depending on the specific program) will be displayed on the dot matrix window. The dots will blink to show your current position in the workout.

**Alphanumeric Message Window:** During a program run, this window will display the current workout data. This window also displays scrolling messages for setup and informational purposes.

### Function Keys:

- Level Up/Level Down keys: Used for data entry during program setup and resistance/HR level adjustment while a program is running.
- Enter key: Used to confirm data entry.
- Start key: Starts the selected program.
- Stop/Reset key: Causes the current program to enter cool-down mode, or workout summary mode if already in cool-down mode. If this key is pressed and held for two seconds, the current program will reset.

**Data Display Select Key:** Press this key to switch the data readouts in the Alphanumeric Message Window between the readings listed above the window and the readings listed under the window.

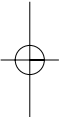



## BASIC OPERATION

- **Power On:** Simply start pedaling to wake up the console and start operation. Before any other keys are pressed, the unit will be in an "idle" mode.
- **Start a Program:** To begin a workout program, press the "Quick Start", "Classic Programs", or "HR Interactive" program key to select a program. Then, follow the instructions on the message display to enter your personal data (Quick Start needs no personal data and will begin immediately). When finished entering data, press the "Start" key to begin the workout program. More details about each program are given in the "Workout Programs" section of this manual.
- **Stop:** To stop a program before it is complete, press the "Stop" key once. The unit will immediately enter "Cool Down" mode. To skip the "Cool Down", press the Stop key again. The unit will enter the Workout Summary mode.
- **Reset:** To reset a program, press and hold the Stop key for two seconds.
- **Pause and Resume:** To pause a program for up to 5 minutes, simply stop pedaling. The display will shut off. To resume the program at the point where you left off, simply start pedaling again within 5 minutes. If the unit is not pedaled within 5 minutes, the unit will automatically reset and the current program will be lost.
- **Save a program:** To save the current program into user memory, press and hold the "User 1" or "User 2" key for two seconds until the data display shows the message "PROGRAM IS SAVED". All the current program settings, including intensity level settings & profiles at various times, will be saved. The entered weight, age, and time will also be saved with the program. **WARNING:** Any program currently saved in that location (User 1 or User 2) will be overwritten by the new program. To select and recall a saved program, press the User 1 or User 2 key once.
- **Switching program:** You may switch from current operating program to another program by pressing a new program key and then ENTER key to accept the new program.
  - If "Classic Program" or "HR Interactive" program key is pressed during a program-executing mode, it will enter program-switching mode:
  - If Enter key is pressed, it will enter this program setup mode. Age and

## BASIC OPERATION

weight default will be the last update and time will be the default program time.

- If Start key is pressed, the new program will begin, but Warm Up mode will be skipped.
  - If 3 seconds passes and no other key is pressed, the program will resume back to previous activities
- **Re-start a program:** You may re-start a program after the current program ends. Simply press the "Start" key during Cool Down or Workout Summary mode. The program will be restarted immediately without a Warm Up mode. The program setup data will remain the same as previous program; the calories and distance will continue accumulating.
  - **% MAX HR:** It is recommended to control your % Max heart rate within 60% — 85% for the most effective workout. It is unsafe and dangerous to exceed 90% and above. The 1190 units are equipped with a safety shut off function in this instance. When the heart rate reaches 90%, the console will beep and flash a warning message. .If the heart rate continues going up and reaches 95% for 8 seconds, the program will automatically reset. **WARNING:** For this safety shutoff function to work, a heart rate acquisition device (chest strap or grip sensors) must be used.
  - **Brake / Resistance Adjustment:** During a program, you may press the LEVEL UP or LEVEL DOWN key to adjust the resistance level. *(Note: brake/resistance adjustments are not allowed in any Heart rate control program).*
  - **English / Metric setting:** The default Units are English system. To enter the system-switching mode, press "START" & "STOP" keys at the same time for 2 seconds during idle mode. The message display will show "SELECT THE UNITS" and "ENGLISH UNITS" or "METRIC UNITS". To change the units, press the level UP or DOWN keys. After the setup is completed, press the "ENTER" key to accept the change and the Console will return to idle mode. At any time you may press the "STOP" and get out of this mode. Doing so will not change the units, it will keep the units the console was set up for prior to entering this mode.





## WORKOUT PROGRAMS

### W A R M U P

#### Getting Started

1190 units automatically initiate a 3-minute Warm Up mode at the beginning of each program. It is designed to prepare your body for an intensive workout and to reduce the possibility of injury.

*Note: Warm Up is skipped for the Quick Start or Manual programs.*

#### Beginning the Program

Warm Up is active as soon as the "Start" key is pressed and a program is started. The message window will flash a message "3:00 WARM UP BEGIN".

#### During the Program

##### Display

- Once the warm up has started, the message window will display the default workout data of "Time, Intensity Level, Watts, and Calories".
- Press the "Select" key to select the desired data displays.

##### Adjusting Intensity Level

- Intensity level = L1. Press "Level Up/Down" key to adjust the intensity level from L1- L5 only.
- The "Start" key can be pressed to skip the warm up and begin the program immediately.

#### Ending the Warm up

- When 3-minute duration is up or Start key is pressed, Warm Up will end and the program will begin.
- The message display will flash a message "PROGRAM BEGIN" and the selected program will be started.
- The calories and distance will be carried over from the warm-up mode..

### C O O L D O W N

#### Getting Started

1190 units are equipped with a 3-minute Cool Down at the end of each program. It appears as soon as a program ends. Cool Down is designed to reduce muscle stiffness and allow your heart rate to recover.

#### Beginning the Program

Cool Down is active as soon as a program ends or the Stop key is pressed during program execution. The message window will flash a message of "THE PROGRAM ENDED" then "3:00 COOL DOWN BEGIN".

#### During the Program

##### Display

- Once the cool down has started, the message window will display the default workout data of "Time, Intensity Level, Watts, and Calories".
- Press the "Select" key to select the desired data displays.

## WORKOUT PROGRAMS

### Adjusting Intensity Level

- Intensity level = L1. Press "Level Up/Down" key to adjust the intensity level from L1- L5 only.
- The "Start" key can be pressed to re-start the program.
- The "Stop" key can be pressed to skip the cool down mode and active the Workout Summary immediately.

### **Ending the Cool Down**

When 3-minute duration is up or the Stop key is pressed, Cool Down will end and enter Workout Summary.

## W O R K O U T S U M M A R Y

### **Getting Started**

For your convenience, the 1190 units incorporate a Workout Summary right after the completion of the Cool Down. It will display the total workout data for your review and repeat it for 3 minutes before the Console resets.

### **Beginning the Program**

Workout Summary appears as soon as the Cool Down mode ends or "Stop" key is pressed during Cool Down mode. The message window will flash a message of "WORKOUT COMPLETED" and "REVIEW YOUR SUMMARY" and the Workout Summary will be displayed

### **During the Program**

#### Display

- Once this summary is started, the message window will display each summary for 3 seconds as following:
  - o TOL TIME: total workout time including Warm Up and Cool Down.
  - o TOL DIS: total distance.
  - o TOL STRIDES: total number of strides
  - o TOL CAL: total calories burned.
  - o AVG HR: average heart rate over the program period.
  - o MIN HR: minimum heart rate during the program.
  - o MAX HR: maximum heart rate during the program.
 (There is no AVG HR, MIN HR or MAX HR displayed if there was no heart rate detected during the program.)
- Press "Level Down" key to jump to the next summary display.
- Press "Level Up" key to jump to the previews summary display.
- Press "Start" key to re-start the program.

### Adjusting Intensity Level

Intensity cannot be adjusted during this time.

### **Ending the Program**

- When 3-minute duration is up or Stop key is pressed, Workout Summary will end and the console will display "PROGRAM COMPLETED" and "CONSOLE WILL RESET"; after these messages the console will reset.





## WORKOUT PROGRAMS, CONTINUED

### Q U I C K S T A R T

#### Getting Started

The Quick Start program allows you to bypass the setup mode and start a workout right away. By picking the Quick Start program, you are accepting the default values for age, weight, time, and intensity level. Be sure to include a warm-up and cool-down period as part of your workout.

#### Beginning the Program

Start pedaling the unit. The message window will flash the message "SELECT A PROGRAM". To begin this program, press "Quick Start" key.

#### Program Default Values

- Time = 30 minutes
- Intensity level = L2

#### During the Program

##### Display

- Once the program is started, the message window will display the workout data of "Time, Intensity Level, Watts and Calories"
- Press the "SELECT" key to select the desired data displays
- If no pulse is detected, the Pulse display will show "--" until there is a pulse, and the HR bar graph will not be illuminated.
- If a pulse is detected, the Pulse display will display the BPM, and the HR bar graph will illuminate to indicate your %Max. HR.

##### Adjusting Intensity Level

- Press the "UP/DOWN" key to adjust the intensity level from L1 to L20 during anytime of the program.
- Each time the "UP/DOWN" key is pressed it will adjust the intensity level of the remaining portion of the program.

*Pause, Reset, Switch, Stop or Save the program*

See Basic Operation section for details.

#### Ending the Program

- When the selected program time is up or the "STOP" key is pressed, there will be a beep to signify the end of the program and Cool Down will become active
- The message window will scroll the messages "THE PROGRAM ENDED" then "3:00 COOL DOWN BEGIN"
- The "Start" key can be pressed to re-start the program.
- The "Stop" key can be pressed to skip the cool down mode and activate the Workout Summary immediately.

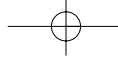

## WORKOUT PROGRAMS, CONTINUED

### C L A S S I C P R O G R A M S

Classic Programs allow a traditional workout without using a heart rate feedback device. Resistance levels are pre-programmed and can be changed manually during the program execution. You can still use a heart rate feedback device (hand grips, chest strap) to monitor your heart rate during the workout.

#### MANUAL PROGRAM

##### **Getting Started**

The manual program allows you to build your own custom profile, a feature that is especially useful if you wish to save a custom workout into the "User 1" or "User 2" program memory. In Manual Program mode, the LED profile displayed on the dot matrix window shows the intensity level for each segment. Be sure to include a warm-up and cool-down period as part of your workout.

##### **Beginning the Program**

Start pedaling the unit. The message window will scroll a message "SELECT A PROGRAM". Press the Classic Programs key until the MANUAL program LED indicator lights up.

##### **Accepting Default values or Entering the program setting mode**

When the message display flashes, "MANUAL", it indicates you are about to select the Manual program. The message display will scroll "PRESS ENTER TO ADJUST OR START TO BEGIN".

- Press "START" key to accept current default values and begin Manual program workout.
  - o Default time = 30 minutes
  - o Default intensity level = L1
- Or press "ENTER" key to enter program-setting mode. The message display will bring you through the program setup step by step as below:

##### Entering Age

1. If ENTER key is pressed, the message window will flash once, "ENTER YOUR AGE", then "AGE = XX" will start blinking.
2. Press "UP/DOWN" key to adjust the age.
3. After age is adjusted, then press "ENTER" key to accept.

##### Entering Weight

1. If ENTER key is pressed, the message window will flash once, "ENTER YOUR WEIGHT", then "WEIGHT = XX" will start blinking.
2. Press "UP/DOWN" key to adjust the weight.
3. After weight is adjusted, then press "ENTER" key to accept.

##### Entering Program Time

1. If ENTER key is pressed, the message window will flash once, "ENTER PROGRAM TIME", then "TIME = 30 MIN" will start blinking.
2. Pressing "UP/DOWN" key to adjust the time. When the time setting reaches 60 minutes, the display will show "TIME = 1HR 00MIN".
3. After time is adjusted, the message window will display "SET UP COMPLETED" "PRESS START TO BEGIN". You may press the "START" key to begin this program.





## WORKOUT PROGRAMS, CONTINUED

*Note: You may press the START key at any time during program setup to skip the adjustment and begin your workout. By doing so, the console will use default value of age and weight for %HR and calories burned calculations.*

### During the Program

#### Display

- Once the program is started, the message window will display the workout data of "Time, Intensity Level, Watts, and Calories".
- Press the "SELECT" key to switch the display to:
  - o For 1190Ub/RB - "%Max HR, RPM, Speed, Distance"
  - o For 1190St - %Max HR, SPM, Floors/min, Floors
- If no pulse is detected, the Pulse display will show "--" until there is a pulse and the HR bar graph will not be illuminated.
- If a pulse is detected, the Pulse display will display the BPM, and the HR bar graph will illuminate to indicate your %Max. HR.

#### Adjusting Intensity Level

- Press the "UP/DOWN" key to adjust the intensity level from L1 to L20 during anytime of the program.
- Each time the "UP/DOWN" key is pressed it will adjust the intensity level of the remaining portion of the program.

*Pause, Reset, Switch, Stop or Save the program*

See Basic Operation section for details.

### Ending the Program

- When the selected program time is up or the "STOP" key is pressed, there will be a beep to signify the end of the program and Cool Down will become active
- The message window will scroll the messages "THE PROGRAM ENDED" then "3:00 COOL DOWN BEGIN"
- The "Start" key can be pressed to re-start the program.
- The "Stop" key can be pressed to skip the cool down mode and activate the Workout Summary immediately.

### RANDOM PROGRAM

#### **Getting Started**

The Random program is designed to allow you to choose a random computer-generated profile for your workout.

#### **Beginning the Program**

Start pedaling the unit. The message window will scroll a message "SELECT A PROGRAM". Press the Classic Programs key until the RANDOM program LED indicator lights up.

#### **Accepting Default values or Entering the program setting mode**

When the message display flashes, "RANDOM", it indicates you are about to select the Random program. The message display will scroll "PRESS ENTER TO ADJUST OR START TO BEGIN".

- Press "START" key to accept current default values and begin the Random program workout.
  - o Default time = 30 minutes



## WORKOUT PROGRAMS, CONTINUED

- Or press "ENTER" key to enter program setup mode. The message display will bring you through the program setup step by step as below:

### Entering Age

1. If ENTER key is pressed, the message window will flash once, "ENTER YOUR AGE", then "AGE = XX" will start blinking.
2. Press "UP/DOWN" key to adjust the age.
3. After age is adjusted, then press "ENTER" key to accept.

### Entering Weight

1. If ENTER key is pressed, the message window will flash once, "ENTER YOUR WEIGHT", then "WEIGHT = XX" will start blinking.
2. Press "UP/DOWN" key to adjust the weight.
3. After weight is adjusted, then press "ENTER" key to accept.

### Entering Program Time

1. If ENTER key is pressed, the message window will flash once, "ENTER PROGRAM TIME", then "TIME = 30 MIN" will start blinking.
2. Pressing "UP/DOWN" key to adjust the time. When the time setting reaches 60 minutes, the display will show "TIME = 1 HR 00MIN".
3. After time is adjusted, the message window will display "SET UP COMPLETED" "PRESS START TO BEGIN". You may press the "START" key to begin this program.

Note: You may press the START key at any time during program setup to skip the adjustment and begin your workout. By doing so, the console will use default value of age and weight for %HR and calories burned calculations.

## During the Program

### Display

- Once the program is started, the message window will display the workout data of "Time, Intensity Level, Watts, and Calories".
- If no pulse is detected, the Pulse display will show "--" until there is a pulse, and the HR bar graph will not be illuminated.
- If a pulse is detected, the Pulse display will display the BPM, and the HR bar graph will illuminate to indicate your %Max. HR.

### Adjusting Intensity Level

- Press the "UP/DOWN" key to adjust the intensity level to L1 and up to L20 during anytime of the program.
- Each time the "UP/DOWN" key is pressed it will adjust the intensity level of the remaining portion of the program.

*Pause, Reset, Switch, Stop or Save the program*

See Basic Operation section for details.

## Ending the Program

- When the selected program time is up or the "STOP" key is pressed, there will be a beep to signify the end of the program and Cool Down will become active
- The message window will scroll the messages "THE PROGRAM ENDED" then "3:00 COOL DOWN BEGIN"
- The "Start" key can be pressed to re-start the program.



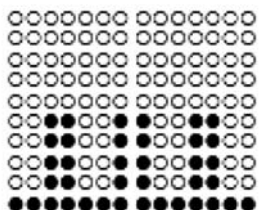

**PROGRAM  
PROFILE**

## WORKOUT PROGRAMS, CONTINUED

- The "Stop" key can be pressed to skip the cool down mode and activate the Workout Summary immediately.

### INTERVAL PROGRAM

The Interval program helps to build the strength of your cardiovascular system by allowing your body to alternate between high-intensity work periods and low-intensity rest periods

#### **Getting Started**

Start pedaling the unit. The message window will scroll a message "SELECT A PROGRAM". Press the Classic Programs key until the Interval program LED indicator lights up.

#### **Accepting Default values or Entering the program setting mode**

When the message display flashes, "INTERVAL", it indicates you are about to select the Interval program. The message display will scroll "PRESS ENTER TO ADJUST OR START TO BEGIN".

- Press "START" key to accept current default values and begin Interval program workout.
  - o Default time = 30 minutes
- Or press "ENTER" key to enter program-setting mode. The message display will bring you through the program setup step by step as below:

#### Entering Age

1. If ENTER key is pressed, the message window will flash once, "ENTER YOUR AGE", then "AGE = XX" will start blinking.
2. Press "UP/DOWN" key to adjust the age.
3. After age is adjusted, then press "ENTER" key to accept.

#### Entering Weight

1. If ENTER key is pressed, the message window will flash once, "ENTER YOUR WEIGHT", then "WEIGHT = XX" will start blinking.
2. Press "UP/DOWN" key to adjust the weight.
3. After weight is adjusted, then press "ENTER" key to accept.

#### Entering Program Time

1. If ENTER key is pressed, the message window will flash once, "ENTER PROGRAM TIME", then "TIME = 30 MIN" will start blinking.
2. Pressing "UP/DOWN" key to adjust the time. When the time setting reaches 60 minutes, the display will show "TIME = 1HR 00MIN".
3. After time is adjusted, the message window will display "SET UP COMPLETED" "PRESS START TO BEGIN". You may press the "START" key to begin this program.

*Note: You may press the START key at any time during program setup to skip the adjustment and begin your workout. By doing so, the console will use default value of age and weight for %HR and calories burned calculations.*

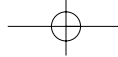

## WORKOUT PROGRAMS, CONTINUED

### During the Program

#### Display

- Once the program is started, the message window will display the workout data of "Time, Intensity Level, Watts, and Calories".
- If no pulse is detected, the Pulse display will show "--" until there is a pulse, and the HR bar graph will not be illuminated.
- If a pulse is detected, the Pulse display will display the BPM, and the HR bar graph will illuminate to indicate your %Max. HR.

#### Adjusting Intensity Level

- During the a Rest segment, press the level "UP" or "DOWN" key to adjust the resistance up to 2 levels below the current Work setting or down to level 1. The remaining Rest segments will be updated to the new setting in the dot matrix profile as well.
- During the Work segment, press the level "UP" or "DOWN" key to adjust the resistance down to 2 levels above the current rest setting and up to Level 20. The remaining Work segments will be updated to the new setting in the dot matrix profile as well.

*Pause, Reset, Switch, Stop or Save the program*  
See Basic Operation section for details.

### Ending the Program

- When the selected program time is up or the "STOP" key is pressed, there will be a beep to signify the end of the program and Cool Down will become active
- The message window will scroll the messages "THE PROGRAM ENDED" then "3:00 COOL DOWN BEGIN"
- The "Start" key can be pressed to re-start the program.
- The "Stop" key can be pressed to skip the cool down mode and activate the Workout Summary immediately.

### HILL CLIMB PROGRAM

#### Getting Started

The Hill Climb program provides a workout that simulates climbing a hill with a constant slope, and then descending the hill.

#### Beginning the Program

Start pedaling the unit. The message window will scroll a message "SELECT A PROGRAM". Press the Classic Programs key until the Hill Climb program LED indicator lights up.

#### Accepting Default values or Entering the program setting mode

When the message display flashes, "HILL CLIMB", it indicates you are about to select the Hill Climb program. The message display will scroll "PRESS ENTER TO ADJUST OR START TO BEGIN".

- Press "START" key to accept current default values and begin Hill Climb program workout.
  - Default time = 30 minutes
- Or press "ENTER" key to enter program-setting mode. The message display will bring you through the program setup step by step as below:

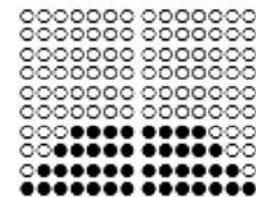

**PROGRAM  
PROFILE**



## WORKOUT PROGRAMS, CONTINUED

### Entering Age

1. If ENTER key is pressed, the message window will flash once, "ENTER YOUR AGE", then "AGE = XX" will start blinking.
2. Press "UP/DOWN" key to adjust the age.
3. After age is adjusted, then press "ENTER" key to accept.

### Entering Weight

1. If ENTER key is pressed, the message window will flash once, "ENTER YOUR WEIGHT", then "WEIGHT = XX" will start blinking.
2. Press "UP/DOWN" key to adjust the weight.
3. After weight is adjusted, then press "ENTER" key to accept.

### Entering Program Time

1. If ENTER key is pressed, the message window will flash once, "ENTER PROGRAM TIME", then "TIME = 30 MIN" will start blinking.
2. Pressing "UP/DOWN" key to adjust the time. When the time setting reaches 60 minutes, the display will show "TIME = 1HR 00MIN".
3. After time is adjusted, the message window will display "SET UP COMPLETED" "PRESS START TO BEGIN". You may press the "START" key to begin this program.

*Note: You may press the START key at any time during program setup to skip the adjustment and begin your workout. By doing so, the console will use default value of age and weight for %HR and calories burned calculations.*

## During the Program

### Display

- Once the program is started, the message window will display the workout data of "Time, Intensity Level, Watts, and Calories".
- If no pulse is detected, the Pulse display will show "--" until there is a pulse, and the HR bar graph will not be illuminated.
- If a pulse is detected, the Pulse display will display the BPM, and the HR bar graph will illuminate to indicate your %Max. HR.

### Adjusting Intensity Level

- Press "UP/DOWN" key to adjust the intensity level to L1 and up to L20 during anytime of the program.
- Each time, the "UP/DOWN" key is pressed; it will adjust the intensity level of the remaining of the program

*Pause, Reset, Switch, Stop or Save the program*  
See Basic Operation section for details.

## Ending the Program

- When the selected program time is up or the "STOP" key is pressed, there will be a beep to signify the end of the program and Cool Down will become active
- The message window will scroll the messages "THE PROGRAM ENDED" then "3:00 COOL DOWN BEGIN"
- The "Start" key can be pressed to re-start the program.
- The "Stop" key can be pressed to skip the cool down mode and activate the Workout Summary immediately.

## WORKOUT PROGRAMS, CONTINUED

### STRENGTH PROGRAM

#### Getting Started

The Strength program gradually increases the workload over time. This will strengthen not only your heart, but also the major muscle groups which are doing the work.

#### Beginning the Program

Start pedaling the unit. The message window will scroll a message "SELECT A PROGRAM".

- Press the Classic Programs key until the Strength program LED indicator lights up.

#### Accepting Default values or Entering the program setting mode

When the message display flashes, "STRENGTH", it indicates you are about to select the Strength program. The message display will scroll "PRESS ENTER TO ADJUST OR START TO BEGIN".

- Press "START" key to accept current default values and begin Strength program workout.
  - o Default time = 30 minutes
- Or press "ENTER" key to enter program setup mode. The message display will bring you through the program setup step by step as below:

#### Entering Age

1. If ENTER key is pressed, the message window will flash once, "ENTER YOUR AGE", then "AGE = XX" will start blinking.
2. Press "UP/DOWN" key to adjust the age.
3. After age is adjusted, then press "ENTER" key to accept.

#### Entering Weight

1. If ENTER key is pressed, the message window will flash once, "ENTER YOUR WEIGHT", then "WEIGHT = XX" will start blinking.
2. Press "UP/DOWN" key to adjust the weight.
3. After weight is adjusted, then press "ENTER" key to accept.

#### Entering Program Time | 190 Series

1. If ENTER key is pressed, the message window will flash once, "ENTER PROGRAM TIME", then "TIME = 30 MIN" will start blinking.
2. Pressing "UP/DOWN" key to adjust the time. When the time setting reaches 60 minutes, the display will show "TIME = 1HR 00MIN".
3. After time is adjusted, the message window will display "SET UP COMPLETED" "PRESS START TO BEGIN". You may press the "START" key to begin this program.

*Note: You may press the START key at any time during program setup to skip the adjustment and begin your workout. By doing so, the console will use default value of age and weight for %HR and calories burned calculations.*

#### During the Program

##### Display

- Once the program is started, the message window will display the workout data of "Time, Intensity Level, Watts, and Calories".

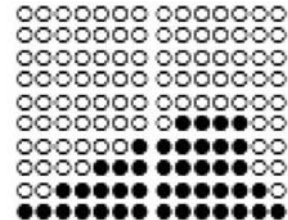

**PROGRAM  
PROFILE**



## WORKOUT PROGRAMS, CONTINUED

- If no pulse is detected, the Pulse display will show “- - -” until there is a pulse, and the HR bar graph will not be illuminated.
- If a pulse is detected, the Pulse display will display the BPM, and the HR bar graph will illuminate to indicate your %Max. HR.

### Adjusting Intensity Level

- Press “UP/DOWN” key to adjust the intensity level to L1 and up to L20 during anytime of the program.
- Each time, the “UP/DOWN” key is pressed; it will adjust the intensity level of the remaining of the program.

### *Pause, Reset, Switch, Stop or Save the program*

See Basic Operation section for details.

### **Ending the Program**

- When the selected program time is up or the “STOP” key is pressed, there will be a beep to signify the end of the program and Cool Down will become active
- The message window will scroll the messages “THE PROGRAM ENDED” then “3:00 COOL DOWN BEGIN”
- The “Start” key can be pressed to re-start the program.
- The “Stop” key can be pressed to skip the cool down mode and activate the Workout Summary immediately.

## **H R I N T E R A C T I V E P R O G R A M S**

All HR Interactive programs use heart rate feedback to control the resistance settings of the unit. In HR Interactive Programs, the resistance level cannot be changed manually, since your heart rate is used to determine the ideal resistance settings during the program execution.

A HEART RATE MONITORING DEVICE (HAND GRIPS, CHEST STRAP) MUST BE USED FOR ALL HR INTERACTIVE PROGRAMS TO FUNCTION PROPERLY. FOR BEST RESULTS, USING A CHEST STRAP IS RECOMMENDED.

IMPORTANT: It is dangerous to exceed 95% of your maximum heart rate while you are exercising. Please consult your physician before performing any Heart Rate based training program.

### TARGET HEART RATE PROGRAM

#### **Getting Started**

The Target Heart Rate program is designed to keep you training at your chosen heart rate level. The 1190 will adjust the intensity level automatically to ensure your target heart rate is achieved and maintained during the entire program. The profile on the Dot Matrix display will show % Max HR for this program rather than intensity level. The profile is replaced with LEDs indicating your actual achieved HR as the program executes. The LEDs will blink to show your current position in the HR profile.

#### **Beginning the Program**

Start pedaling the unit. The message window will scroll a message “SELECT A PROGRAM”.

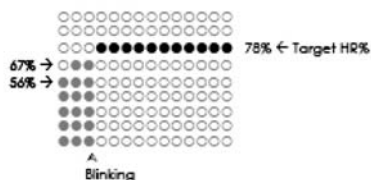

**PROGRAM PROFILE**



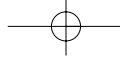

## WORKOUT PROGRAMS, CONTINUED

- Press the HR Interactive Programs key until the Target HR program LED indicator lights up.

### Accepting Default values or Entering the program setting mode

When the message display flashes, "TARGET HR", it indicates you are about to select the Target Heart Rate program. The message display will scroll "PRESS ENTER TO ADJUST OR START TO BEGIN".

- Press "START" key to accept current default values and begin Target HR program workout.
- Or press "ENTER" key to enter program setup mode. The message display will bring you through the program setup step by step as below:

#### Entering Age

1. If ENTER key is pressed, the message window will flash once, "ENTER YOUR AGE", then "AGE = XX" will start blinking.
2. Press "UP/DOWN" key to adjust the age.
3. After age is adjusted, then press "ENTER" key to accept.

#### Entering Weight

1. If ENTER key is pressed, the message window will flash once, "ENTER YOUR WEIGHT", then "WEIGHT = XX" will start blinking.
2. Press "UP/DOWN" key to adjust the weight.
3. After weight is adjusted, then press "ENTER" key to accept.

#### Entering Program Time

1. If ENTER key is pressed, the message window will flash once, "ENTER PROGRAM TIME", then "TIME = 30 MIN" will start blinking.
2. Pressing "UP/DOWN" key to adjust the time. When the time setting reaches 60 minutes, the display will show "TIME = 1HR 00MIN".
3. After weight is adjusted, then press "ENTER" key to accept.

#### Entering Target Heart Rate

1. If ENTER key is pressed, the message window will scroll, "SELECT TARGET HR", then "TARGET HR = XXX" will be blinking.
2. You may adjust the target HR from 60% of maximum HR to 85% of maximum HR by pressing "UP/DOWN" key.
3. After time is adjusted, the message window will display "SET UP COMPLETED" "PRESS START TO BEGIN". You may press the "START" key to begin this program.

*Note: You may press the START key at any time during program setup to skip the adjustment and begin your workout. By doing so, the console will use default value of age and weight for %HR and calories burned calculations, and the default target HR for workout.*

### During the Program

#### Display

- This program cannot be started until a valid pulse is detected for 3 seconds. If no pulse is detected, the message window will flash a message "NO HR DETECTED". Make sure your heart rate device is working properly. If the heart rate signal does not return, the display will continue to flash the "NO HR DETECTED" message and the current resistance level will not change until the





## WORKOUT PROGRAMS, CONTINUED

heart rate signal returns.

- Once the program is started, the message window will display the workout data of "Time, Intensity Level, Watts, and Calories".
- If no pulse is detected, the Pulse display will show "--" until there is a pulse, and the HR bar graph will not be illuminated.
- If a pulse is detected, the Pulse display will display the BPM, and the HR bar graph will illuminate to indicate your %Max. HR.

### Adjusting Target Heart Rate

- Press "UP/DOWN" key to adjust the Target Heart Rate during anytime of the program.
- Each time the "UP/DOWN" key is pressed it will adjust the Target Heart Rate of the remaining portion of the program

*Pause, Reset, Switch, Stop or Save the program*

See Basic Operation section for details.

### **Ending the Program**

- When the selected program time is up or the "STOP" key is pressed, there will be a beep to signify the end of the program and Cool Down will become active
- The message window will scroll the messages "THE PROGRAM ENDED" then "3:00 COOL DOWN BEGIN"
- The "Start" key can be pressed to re-start the program.
- The "Stop" key can be pressed to skip the cool down mode and activate the Workout Summary immediately.

### HEART RATE INTERVAL PROGRAM

#### **Getting Started**

The Heart Rate Interval program is designed to alternate periods of hard work (the stress phase) with periods of light work (the recovery phase). The 1190 will adjust the intensity level up to meet your upper target heart rate and adjust it down to meet your lower target heart rate, continuing to alternate back and forth until the program time is up. The profile on the Dot Matrix display will show % Max HR for this program rather than intensity level. The profile is replaced with LEDs indicating your actual achieved HR as the program executes. The LEDs will blink to show your current position in the HR profile.

#### **Beginning the Program**

Start pedaling the unit. The message window will scroll a message "SELECT A PROGRAM". Press the HR Interval Programs key until the HR Interval program LED indicator lights up.

#### **Accepting Default values or Entering the program setting mode**

When the message display flashes, "HR INTERVAL", it indicates you are about to select the HR Interval program. The message display will scroll "PRESS ENTER TO ADJUST OR START TO BEGIN".

- Press "START" key to accept current default values and begin HR Interval program workout.
- Or press "ENTER" key to enter program setup mode. The message display will bring you through the program setup step by step as below:

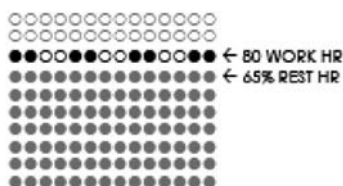

**PROGRAM  
PROFILE**



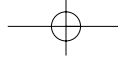

## WORKOUT PROGRAMS, CONTINUED

### Entering Age

1. If ENTER key is pressed, the message window will flash once, "ENTER YOUR AGE", then "AGE = XX" will start blinking.
2. Press "UP/DOWN" key to adjust the age.
3. After age is adjusted, then press "ENTER" key to accept.

### Entering Weight

1. If ENTER key is pressed, the message window will flash once, "ENTER YOUR WEIGHT", then "WEIGHT = XX" will start blinking.
2. Press "UP/DOWN" key to adjust the weight.
3. After weight is adjusted, then press "ENTER" key to accept.

### Entering Program Time

1. If ENTER key is pressed, the message window will flash once, "ENTER PROGRAM TIME", then "TIME = 30 MIN" will start blinking.
2. Pressing "UP/DOWN" key to adjust the time. When the time setting reaches 60 minutes, the display will show "TIME = 1HR 00MIN".
3. After weight is adjusted, then press "ENTER" key to accept.

### Entering Rest (Lower) HR Goal

1. If ENTER key is pressed, the message window will scroll, "SELECT YOUR REST HR". Then the "REST HR = XXXBPM" will be blinking.
2. You can adjust the HR from 60% - 80% max HR by pressing "UP/DOWN" key.
3. After the lower HR adjustment, press "ENTER" key to accept.

### Entering Work (Upper) HR Goal

1. If ENTER key is pressed, the message window will scroll, "SELECT YOUR WORK HR". Then the "WORK HR = XXXBPM" will be blinking.
2. You can adjust the HR from "Rest HR setting" to 85% max HR by pressing "UP/DOWN" key.
3. After upper HR adjustment, the program setting is now completed. Press "START" key to start HR Interval program.

*Note: You may press the START key at any time during program setup to skip the adjustment and begin your workout. By doing so, the console will use default value of age and weight for %HR and calories burned calculations, and the default target HR for workout.*

## During the Program

### Display

- This program cannot be started until a valid pulse is detected for 3 seconds. If no pulse is detected, the message window will flash a message "NO HR DETECTED". Make sure your heart rate device is working properly. If the heart rate signal does not return, the display will continue to flash the "NO HR DETECTED" message and the current resistance level will not change until the heart rate signal returns.
- Once the program is started, the message window will display the workout data of "Time, Intensity Level, Watts, and Calories".
- If no pulse is detected, the Pulse display will show "--" until there is a pulse, and the HR bar graph will not be illuminated.
- If a pulse is detected, the Pulse display will display the BPM, and the HR bar



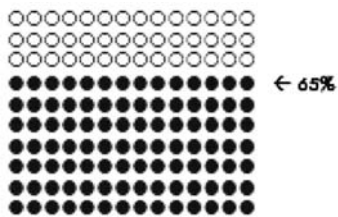

**PROGRAM  
PROFILE**

## WORKOUT PROGRAMS, CONTINUED

graph will illuminate to indicate your %Max. HR.

### Adjusting Work and Rest Heart Rate

- During any Work segment of the program, press "UP/DOWN" key to adjust the Work Heart Rate. Each time the "UP/DOWN" key is pressed it will adjust the Work Heart Rate of the remaining portion of the program.
- During any Rest segment of the program, press "UP/DOWN" key to adjust the Rest Heart Rate. Each time the "UP/DOWN" key is pressed it will adjust the Rest Heart Rate of the remaining portion of the program.

### *Pause, Reset, Switch, Stop or Save the program*

See Basic Operation section for details.

### **Ending the Program**

- When the selected program time is up or the "STOP" key is pressed, there will be a beep to signify the end of the program and Cool Down will become active.
- The message window will scroll the messages "THE PROGRAM ENDED" then "3:00 COOL DOWN BEGIN"
- The "Start" key can be pressed to re-start the program.
- The "Stop" key can be pressed to skip the cool down mode and activate the Workout Summary immediately.

### FATBURNER PROGRAM

#### **Getting Started**

The Fatburner program provides a consistent level of work (65% of Max HR) during your exercise session to maximize the burning of body fat. The 1190 will adjust the intensity level to maintain 65% Max HR during the program. The profile on the Dot Matrix display will show % Max HR for this program rather than intensity level. The profile is replaced with LEDs indicating your actual achieved HR as the program executes. The LEDs will blink to show your current position in the HR profile.

#### **Beginning the Program**

Start pedaling the unit. The message window will scroll a message "SELECT A PROGRAM".

- Press the HR Interactive Programs key until the Fatburner program LED indicator lights up.

#### **Accepting Default values or Entering the program setting mode**

When the message display flashes, "FAT BURNER", it indicates you are about to select the Fatburner program. The message display will scroll "PRESS ENTER TO ADJUST OR START TO BEGIN".

- Press "START" key to accept current default values and begin Fatburner program workout.
- Or press "ENTER" key to enter program setup mode. The message display will bring you through the program setup step by step as below:

#### Entering Age

1. If ENTER key is pressed, the message window will flash once, "ENTER YOUR AGE", then "AGE = XX" will start blinking.
2. Press "UP/DOWN" key to adjust the age.
3. After age is adjusted, then press "ENTER" key to accept.

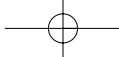

## WORKOUT PROGRAMS, CONTINUED

### Entering Weight

1. If ENTER key is pressed, the message window will flash once, "ENTER YOUR WEIGHT", then "WEIGHT = XX" will start blinking.
2. Press "UP/DOWN" key to adjust the weight.
3. After weight is adjusted, then press "ENTER" key to accept.

### Entering Program Time

1. If ENTER key is pressed, the message window will flash once, "ENTER PROGRAM TIME", then "TIME = 30 MIN" will start blinking.
2. Pressing "UP/DOWN" key to adjust the time. When the time setting reaches 60 minutes, the display will show "TIME = 1HR 00MIN".
3. After time is adjusted, the message window will display "SET UP COMPLETED" "PRESS START TO BEGIN". You may press the "START" key to begin this program.

*Note: You may press the START key at any time during program setup to skip the adjustment and begin your workout. By doing so, the console will use default value of age and weight for %HR and calories burned calculations, and the default target HR for workout.*

### **During the Program**

#### Display

- This program cannot be started until a valid pulse is detected for 3 seconds. If no pulse is detected, the message window will flash a message "NO HR DETECTED". Make sure your heart rate device is working properly. If the heart rate signal does not return, the display will continue to flash the "NO HR DETECTED" message and the current resistance level will not change until the heart rate signal returns.
- Once the program is started, the message window will display the workout data of "Time, Intensity Level, Watts, and Calories".
- If no pulse is detected, the Pulse display will show "--" until there is a pulse, and the HR bar graph will not be illuminated.
- If a pulse is detected, the Pulse display will display the BPM, and the HR bar graph will illuminate to indicate your %Max. HR.

#### Adjusting % Max HR

- Press "UP/DOWN" key to adjust the % Max HR during the program. For the Fatburner program, the % Max HR can only be adjusted between 65% - 70%.

*Pause, Reset, Switch, Stop or Save the program*

See Basic Operation section for details.

### **Ending the Program**

- When the selected program time is up or the "STOP" key is pressed, there will be a beep to signify the end of the program and Cool Down will become active
- The message window will scroll the messages "THE PROGRAM ENDED" then "3:00 COOL DOWN BEGIN"
- The "Start" key can be pressed to re-start the program.
- The "Stop" key can be pressed to skip the cool down mode and activate the Workout Summary immediately.



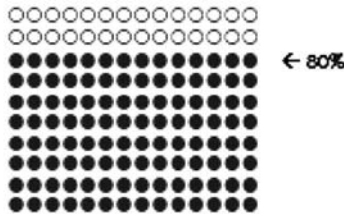

**PROGRAM  
PROFILE**

## WORKOUT PROGRAMS, CONTINUED

### CARDIO PROGRAM

#### **Getting Started**

The Cardio Program provides an intense workout at 80% of your Max HR for high-level cardiovascular conditioning. The 1190 will adjust the intensity level to maintain 80% Max HR during the program. The profile on the Dot Matrix display will show % Max HR for this program rather than intensity level. The profile is replaced with LEDs indicating your actual achieved HR as the program executes. The LEDs will blink to show your current position in the HR profile.

#### **Beginning the Program**

Start pedaling the unit. The message window will scroll a message "SELECT A PROGRAM".

- Press the HR Interactive Programs key until the Cardio program LED indicator lights up.

#### **Accepting Default values or Entering the program setting mode**

When the message display flashes, "CARDIO", it indicates you are about to select the Cardio program. The message display will scroll "PRESS ENTER TO ADJUST OR START TO BEGIN".

- Press "START" key to accept current default values and begin Cardio program workout.
- Or press "ENTER" key to enter program setup mode. The message display will bring you through the program setup step by step as below:

#### Entering Age

1. If ENTER key is pressed, the message window will flash once, "ENTER YOUR AGE", then "AGE = XX" will start blinking.
2. Press "UP/DOWN" key to adjust the age.
3. After age is adjusted, then press "ENTER" key to accept.

#### Entering Weight

1. If ENTER key is pressed, the message window will flash once, "ENTER YOUR WEIGHT", then "WEIGHT = XX" will start blinking.
2. Press "UP/DOWN" key to adjust the weight.
3. After weight is adjusted, then press "ENTER" key to accept.

#### Entering Program Time

1. If ENTER key is pressed, the message window will flash once, "ENTER PROGRAM TIME", then "TIME = 30 MIN" will start blinking.
2. Pressing "UP/DOWN" key to adjust the time. When the time setting reaches 60 minutes, the display will show "TIME = 1HR 00MIN".
3. 2. After time is adjusted, the message window will display "SET UP COMPLETED" "PRESS START TO BEGIN". You may press the "START" key to begin this program.

*Note: You may press the START key at any time during program setup to skip the adjustment and begin your workout. By doing so, the console will use default value of age and weight for %HR and calories burned calculations, and the default target HR for workout.*

## WORKOUT PROGRAMS, CONTINUED

### During the Program

#### Display

- This program cannot be started until a valid pulse is detected for 3 seconds. If no pulse is detected, the message window will flash a message "NO HR DETECTED". Make sure your heart rate device is working properly. If the heart rate signal does not return, the display will continue to flash the "NO HR DETECTED" message and the current resistance level will not change until the heart rate signal returns.
- Once the program is started, the message window will display the workout data of "Time, Intensity Level, Watts, and Calories".
- If no pulse is detected, the Pulse display will show "- -" until there is a pulse, and the HR bar graph will not be illuminated.
- If a pulse is detected, the Pulse display will display the BPM, and the HR bar graph will illuminate to indicate your %Max. HR.

#### Adjusting % Max HR

- Press "UP/DOWN" key to adjust the % Max HR during the program. For the Cardio program, the % Max HR can only be adjusted between 75% - 85%.

*Pause, Reset, Switch, Stop or Save the program*

See Basic Operation section for details.

### Ending the Program

- When the selected program time is up or the "STOP" key is pressed, there will be a beep to signify the end of the program and Cool Down will become active
- The message window will scroll the messages "THE PROGRAM ENDED" then "3:00 COOL DOWN BEGIN"
- The "Start" key can be pressed to re-start the program.
- The "Stop" key can be pressed to skip the cool down mode and activate the Workout Summary immediately.



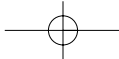

## WORKOUT PROGRAMS, CONTINUED



### Demo Program

The 1190 series units contain a demonstration mode that shows the major features and programs of the unit. To begin this mode, press and hold the "START" key for two seconds when the unit is in idle mode.



## MAINTENANCE

### CAUTION – FOR SAFE OPERATION

Always inspect hardware prior to any exercise session. Look for loose hardware, loose pedals, loose cranks and frayed wires. Repair or replace any damaged or worn parts, tighten all loose hardware.

As part of Diamondback's normal installation and set-up process, all pedal cranks must be tightened after 8 to 10 hours of initial riding to ensure parts are properly seated to axle. This is standard initial "break-in" service, which must be performed after the first 8 to 10 hours of use. Un-tightened pedal cranks may become loose, causing damage, which may void the warranty.

After exercising, always wipe down your unit. Perspiration that continuously settles on frame, pads or casing may eventually cause rust or damage to the unit. Damage resulting from lack of proper maintenance will not be covered under warranty. To clean pads, use a mild soap and warm water. Dry with a clean towel.

If noises develop or malfunctions occur, contact your authorized Diamondback Fitness dealer.





## DOMESTIC WARRANTY INFORMATION

**(Applies to all product sold and placed within the continental US, Alaska, Hawaii, and Puerto Rico only)**

### **Effective: August 2006**

Diamondback warrants this equipment to be free from defects in material and workmanship under normal use in the home. Diamondback's obligation under this Warranty is limited to repair or replacement of any defective part without charge through an authorized service agent to the original purchaser with the following parameters:

### **Who is covered:**

The Warranty is extended to the individual or legal entity whose name appears on the Warranty registration card filed with Diamondback and may not be transferred to any other individual or legal entity

### **To obtain service:**

To obtain service you must contact your authorized Diamondback Fitness dealer. Your dealer is also your authorized service agent. An authorized service agent must diagnose your unit in order to determine Warranty claims/issues.

Sales where the unit is delivered unassembled (in a carton) to the end user (e.g. mail order or Internet sales) without a service contract purchased through the dealer voids the Warranty.

### **Warranty Registration:**

Warranty commitments are valid only with a completed Warranty card that is returned within 15 days from the date of purchase and includes the product serial number. Registration is available at [www.diamondbackfitness.com](http://www.diamondbackfitness.com).

Proof of purchase from Diamondback's authorized dealer will be required if the Warranty card is not registered prior to any consideration of Warranty claim.

## **WHAT IS COVERED**

### HOME

*Maximum Usage: 14 Hours per week*

Frame:	Lifetime limited Warranty. Covers defects in welds, materials and workmanship.
Brake:	Lifetime Limited
Parts & Electronics:	3 years
Normal Wear Items:	90-day limited on foam grips, pedals, and other areas subject to wear
Labor:	1 Year



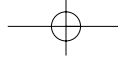

## DOMESTIC WARRANTY INFORMATION

### LIGHT INSTITUTIONAL

*Maximum Usage: 21 Hours per week*

Frame:	Lifetime limited Warranty. Covers defects in welds, materials and workmanship.
Brake:	Lifetime Limited
Parts & Electronics:	2 years
Normal Wear Items:	90-day limited on foam grips, pedals, and other areas subject to wear
Labor:	1 Year



### **Warranty voided if:**

The Warranty does not apply to any failure of the product, or any parts of the product due to: assembly errors, alterations, modifications, misuse, abuse, accident, improper maintenance, or if the serial number on the product has been removed, altered or defaced. Assembly errors include but are not limited to:

Damaged wire harness.  
Stripped crank arms and/or pedals.  
Bolts used in the wrong location.

### **Parts & Service:**

Contact the authorized Diamondback dealer where unit as originally purchased. If you have moved, or that retailer is unavailable, use our dealer locator at [www.diamondbackfitness.com](http://www.diamondbackfitness.com) to help find another authorized dealer.

Diamondback is not responsible for arranging Warranty service and/or honoring extended warranties provided by dealers.

### **Exclusions:**

Warranty is void if the 1190Sr unit is placed in a commercial or major institutional environment such as a health club, school, or correctional facility.

### **Additional Rights:**

This Warranty is expressly in lieu of all other warranties, and any implied warranties of merchantability or fitness for a particular purpose created hereby, are limited to the same duration as the express Warranty herein. Diamondback Fitness, Inc. shall not be liable for any incidental or consequential damages. Some states do not allow the exclusion or limitations of implied warranties, incidental or consequential, so the above limitations and exclusions may not apply to you.





## DOMESTIC WARRANTY INFORMATION (CONTINUED)



Retailers and wholesale outlets for Diamondback Fitness, Inc. products are not authorized to modify this Warranty in any way.

This Warranty gives the original owner specific legal rights. Other additional rights may vary from state to state.

**Diamondback Fitness, Inc.**

300 Camarillo Ranch Road  
Camarillo, CA 93012

Phone no. 800.776.7642



# WARRANTY CARD



**Important! • Important! • Important! • Important! • Important! • Important!**

Warranty card must be completed and returned to Diamondback within **15 days** of purchase. Failure to comply may void manufacturer's Warranty. Or, you may register your product at [www.diamondbackfitness.com](http://www.diamondbackfitness.com).

Your Name: \_\_\_\_\_

Address: \_\_\_\_\_

City: \_\_\_\_\_ State: \_\_\_\_\_ Zip: \_\_\_\_\_

Daytime phone No.: \_\_\_\_\_ Evening phone No.: \_\_\_\_\_

Dealer Store Name: Address: \_\_\_\_\_

City: \_\_\_\_\_ State: \_\_\_\_\_ Zip: \_\_\_\_\_

Model: \_\_\_\_\_ Serial No.: \_\_\_\_\_

Purchase Date: \_\_\_\_\_

Environment Unit Placed:

- Home
- Light Institutional, i.e. Hotel, Business Center...

Mail completed form to:

**Diamondback Fitness - Warranty Card**

300 Camarillo Ranch Road

Camarillo, CA 93012

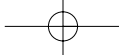

Please refer to [www.diamondbackfitness.com](http://www.diamondbackfitness.com) for instructions in French.  
Svp référez-vous [www.diamondbackfitness.com](http://www.diamondbackfitness.com) pour instructions en français.

[www.diamondbackfitness.com](http://www.diamondbackfitness.com)

**Diamondback Fitness, Inc.**

300 Camarillo Ranch Road  
Camarillo, CA 93012  
T 800-776-7642  
F 805-388-5890

well equipped for success

**Part no. 22-96-125**



## Free Manuals Download Website

<http://myh66.com>

<http://usermanuals.us>

<http://www.somanuals.com>

<http://www.4manuals.cc>

<http://www.manual-lib.com>

<http://www.404manual.com>

<http://www.luxmanual.com>

<http://aubethermostatmanual.com>

Golf course search by state

<http://golfingnear.com>

Email search by domain

<http://emailbydomain.com>

Auto manuals search

<http://auto.somanuals.com>

TV manuals search

<http://tv.somanuals.com>