

D0801.101

G349

D0801.01

D341.FS

D06.13  
quantity 2

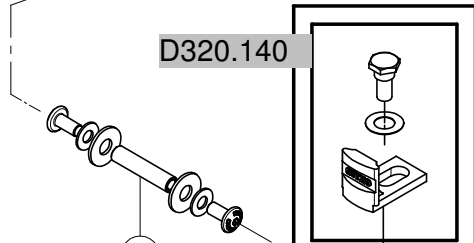
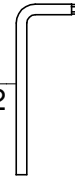

D320.140

A

D09504.32

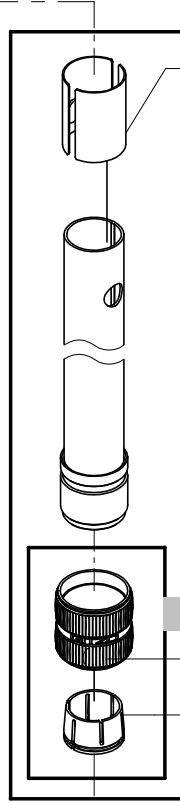

D0201.28  
(2 pcs)

D002.20

D09506.28

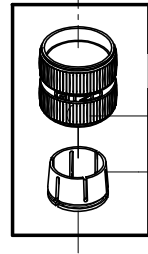

D0401.28

D0402.28

D0301.24

B

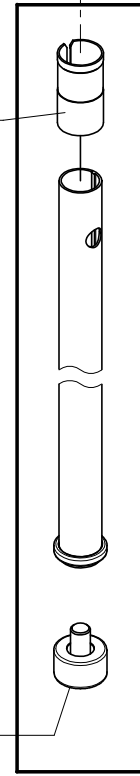

D09507.20

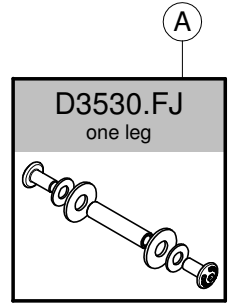

D3530.FJ  
one leg

A

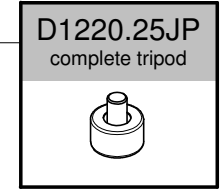

D1220.25JP  
complete tripod

B

D0401.32

D0402.32

D0301.28

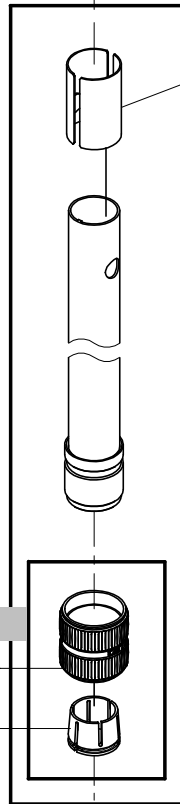
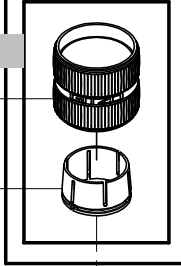

D0201.24  
(2 pcs)

D09506.24

D340.52

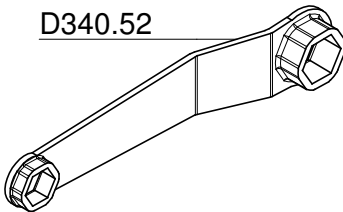

D0401.24

D0402.24

D0301.20

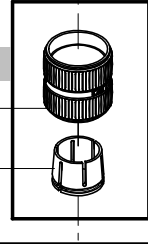

# GT3540LS

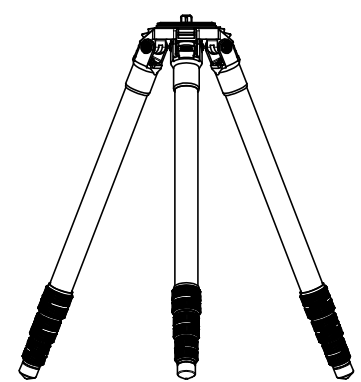

For serial numbers from G0109566

## Free Manuals Download Website

<http://myh66.com>

<http://usermanuals.us>

<http://www.somanuals.com>

<http://www.4manuals.cc>

<http://www.manual-lib.com>

<http://www.404manual.com>

<http://www.luxmanual.com>

<http://aubethermostatmanual.com>

Golf course search by state

<http://golfingnear.com>

Email search by domain

<http://emailbydomain.com>

Auto manuals search

<http://auto.somanuals.com>

TV manuals search

<http://tv.somanuals.com>