

2620A/2625A

Hydra Series II Data Acquisition Unit

Hydra Series II Data Logger

Users Manual

PN 686675

November 1997

© 1997 Fluke Corporation, All rights reserved. Printed in U.S.A.

All product names are trademarks of their respective companies.

LIMITED WARRANTY & LIMITATION OF LIABILITY

Each Fluke product is warranted to be free from defects in material and workmanship under normal use and service. The warranty period is one year and begins on the date of shipment. Parts, product repairs and services are warranted for 90 days. This warranty extends only to the original buyer or end-user customer of a Fluke authorized reseller, and does not apply to fuses, disposable batteries or to any product which, in Fluke's opinion, has been misused, altered, neglected or damaged by accident or abnormal conditions of operation or handling. Fluke warrants that software will operate substantially in accordance with its functional specifications for 90 days and that it has been properly recorded on non-defective media. Fluke does not warrant that software will be error free or operate without interruption.

Fluke authorized resellers shall extend this warranty on new and unused products to end-user customers only but have no authority to extend a greater or different warranty on behalf of Fluke. Warranty support is available if product is purchased through a Fluke authorized sales outlet or Buyer has paid the applicable international price. Fluke reserves the right to invoice Buyer for importation costs of repair/replacement parts when product purchased in one country is submitted for repair in another country.

Fluke's warranty obligation is limited, at Fluke's option, to refund of the purchase price, free of charge repair, or replacement of a defective product which is returned to a Fluke authorized service center within the warranty period.

To obtain warranty service, contact your nearest Fluke authorized service center or send the product, with a description of the difficulty, postage and insurance prepaid (FOB Destination), to the nearest Fluke authorized service center. Fluke assumes no risk for damage in transit. Following warranty repair, the product will be returned to Buyer, transportation prepaid (FOB Destination). If Fluke determines that the failure was caused by misuse, alteration, accident or abnormal condition of operation or handling, Fluke will provide an estimate of repair costs and obtain authorization before commencing the work. Following repair, the product will be returned to the Buyer transportation prepaid and the Buyer will be billed for the repair and return transportation charges (FOB Shipping Point).

THIS WARRANTY IS BUYER'S SOLE AND EXCLUSIVE REMEDY AND IS IN LIEU OF ALL OTHER WARRANTIES, EXPRESS OR IMPLIED, INCLUDING BUT NOT LIMITED TO ANY IMPLIED WARRANTY OF MERCHANTABILITY OR FITNESS FOR A PARTICULAR PURPOSE. FLUKE SHALL NOT BE LIABLE FOR ANY SPECIAL, INDIRECT, INCIDENTAL OR CONSEQUENTIAL DAMAGES OR LOSSES, INCLUDING LOSS OF DATA, WHETHER ARISING FROM BREACH OF WARRANTY OR BASED ON CONTRACT, TORT, RELIANCE OR ANY OTHER THEORY.

Since some countries or states do not allow limitation of the term of an implied warranty, or exclusion or limitation of incidental or consequential damages, the limitations and exclusions of this warranty may not apply to every buyer. If any provision of this Warranty is held invalid or unenforceable by a court of competent jurisdiction, such holding will not affect the validity or enforceability of any other provision.

Fluke Corporation
P.O. Box 9090
Everett, WA 98206-9090
U.S.A.

Fluke Europe B.V.
P.O. Box 1186
5602 BD Eindhoven
The Netherlands

Table of Contents

Chapter	Title	Page
1	Introduction.....	1-1
	The Hydra Series II Data Acquisition Unit	1-3
	The Hydra Series II Data Logger	1-3
	Options and Accessories	1-3
	Applications Software.....	1-3
	IEEE-488 Interface Assembly.....	1-3
	Connector Set (2620A-100)	1-3
	Accessories.....	1-5
	Where to go From Here	1-5
2	Overview.....	2-1
	Introduction	2-3
	Setting Up the Instrument.....	2-3
	Unpacking and Inspecting the Instrument.....	2-3
	Adjusting the Handle	2-3
	Line Power	2-4
	Front/Rear Panel Features.....	2-4
	Input Channels	2-9
	Operating Modes	2-9
	Turning the Instrument On	2-9
	Front Panel Display	2-10
	Reading the Display	2-10
	Left Display.....	2-10
	Right Display	2-10
	Specific Annunciators.....	2-10
	Front Panel Buttons.....	2-11
	Selecting a Channel.....	2-11
	Using the Buttons.....	2-11
	Setting up a Channel.....	2-12
	Setting Alarm Limits and Mx+B Scaling Values.....	2-14
	Alarm Limits	2-14
	Mx+B Scaling	2-15
	Setting the Scan Interval.....	2-15
	Using the Monitor Function	2-16

Using the Scan Function.....	2-16
Reviewing Channel Data.....	2-16
Viewing the Totalizer Count.....	2-17
Using External DC Power.....	2-17
Using the Rack Mount Kit.....	2-18
3 Operating the Instrument from the Front Panel.....	3-1
Introduction.....	3-3
Operating Modes.....	3-3
Other Displayed Data.....	3-4
What is the Present Configuration?.....	3-4
If Power is Interrupted.....	3-4
If the Configuration is Reset.....	3-4
Channel Configuration.....	3-4
Selecting Channel, Function, and Range.....	3-4
Setting Alarms.....	3-9
Alarm Limits.....	3-9
Alarm Indications.....	3-10
Resetting Alarm Conditions.....	3-11
Using the Digital I/O Lines.....	3-11
Mx+B Scaling.....	3-12
Instrument Configuration.....	3-14
Entering and Changing Numeric Values.....	3-14
Selecting Scan Interval.....	3-15
Selecting the Measurement Rate.....	3-15
Triggering.....	3-16
External Triggering.....	3-16
Changing the Temperature Unit.....	3-16
Setting Date and Time of Day.....	3-17
Measurement Connections.....	3-17
DC Volts, AC Volts, Frequency, and Thermocouples.....	3-18
Resistance and RTD.....	3-20
Totalizing.....	3-22
General.....	3-22
Connections.....	3-22
Review Array.....	3-22
List Button Functions.....	3-23
Autoprint.....	3-25
Memory Storage.....	3-25
Front Panel Lock out Conditions.....	3-26
Front Panel Review Only Function.....	3-26
Front Panel Monitor Only Function.....	3-26
Computer Interface-Initiated Lockouts.....	3-27
REM Annunciator.....	3-27
Calibration.....	3-27
4 Using the Computer Interface.....	4-1
Introduction.....	4-3
Front Panel and Computer Interface Operations.....	4-3
Types of Computer Interface.....	4-3
Using the RS-232 Computer Interface.....	4-3
Setting Communication Parameters (RS-232).....	4-4
Autoprint and Memory Storage (RS-232).....	4-5

Autoprint: Computer Interface Control	4-5
Autoprint: Output Format	4-5
Memory Storage: Computer Interface Control	4-6
Memory Retrieval	4-6
Memory Full Operation	4-7
Clearing Memory	4-7
Cabling the Instrument to a Host or Printer (RS-232)	4-7
Installation Test	4-8
RS-232 Information	4-8
Character Echoing	4-8
Character Deletion	4-8
Device Clear Using Ctrl C	4-8
RS-232 Prompts	4-9
Sample Program Using the RS-232 Computer Interface	4-9
Using the IEEE-488 Interface	4-9
IEEE-488 Operating Limitations	4-9
Installing the IEEE-488 Interface	4-9
Enabling the IEEE-488 Interface	4-12
Installation Test	4-13
General Information (RS-232 and IEEE-488)	4-13
How the Instrument Processes Input	4-13
Input Strings	4-14
Input Terminators	4-14
Typical Input Strings	4-14
Sending Numeric Values to the Instrument (RS-232 and IEEE-488)	4-16
Sending Input Strings to the Instrument	4-16
How the Instrument Processes Output	4-16
Service Requests (IEEE-488 only) and Status Registers	4-17
Event Status and Event Status Enable Registers	4-19
Status Byte Register	4-19
Reading the Status Byte Register	4-20
Service Request Enable Register	4-21
Instrument Event Register	4-21
Computer Interface Command Set	4-22

5 Additional Considerations 5-1

Introduction	5-3
Measurement Rate	5-3
Advanced Trigger Mechanisms	5-3
Front Panel Trigger Control	5-3
Computer Interface Trigger Control	5-3
Both External and Monitor Alarms Disabled (Type 0)	5-4
External Trigger Enabled (Type 1)	5-4
Monitor Alarm Enabled (Type 2)	5-6
Thermal Voltages	5-6
When Measuring Resistance or Temperature (RTD)	5-6
True RMS Measurements	5-8
Effects of Internal Noise in AC Measurements	5-8
Waveform Comparison (True RMS vs Average Responding)	5-8
Making Mixed Measurements	5-9
Using Shielded Wiring	5-11
General Rule	5-11
Alternate Suggestions	5-11
Non-Isolated Sensor Configuration	5-11

	Isolated and Shielded Sensor Configuration	5-11
	In More Detail	5-12
6	Maintenance	6-1
	Introduction	6-3
	Cleaning.....	6-3
	Line Fuse	6-3
	Self-Test Diagnostics and Error Codes	6-3
	Performance Tests	6-4
	Accuracy Verification Test.....	6-7
	Channel Integrity Test.....	6-7
	Thermocouple Measurement Range Accuracy Test	6-9
	4-Terminal Resistance Test.....	6-10
	Thermocouple Temperature Accuracy Test.....	6-11
	Open Thermocouple Response Test	6-13
	RTD Temperature Accuracy Test	6-14
	RTD Temperature Accuracy Test (Using Decade Resistance Source)	6-14
	RTD Temperature Accuracy Test (Using DIN/IEC 751)	6-15
	Digital Input/Output Verification Tests.....	6-15
	Digital Output Test	6-16
	Digital Input Test.....	6-16
	Totalizer Test.....	6-17
	Totalizer Sensitivity Test.....	6-18
	Dedicated Alarm Output Test	6-19
	External Trigger Input Test.....	6-21
	Calibration.....	6-21
	Variations in the Display.....	6-22
	Service	6-22
	Appendices	
	A Specifications.....	A-1
	B ASCII & IEEE-488 Bus Codes	B-1
	C IEEE-488.2 Device Documentation Requirements.....	C-1
	D Making Mixed Measurements	D-1
	E Binary Upload of Logged Data (LOG_BIN?) (2625A only).....	E-1
	F RS-232 Cabling.....	F-1

Index

List of Tables

Table	Title	Page
1-1.	Hydra Features	1-4
1-2.	Accessories	1-5
2-1.	Display Annunciators	2-7
2-2.	Front Panel Pushbuttons	2-11
2-3.	Review Array	2-17
3-1.	Configuration Reset Settings	3-5
3-2.	DC Voltage, AC Voltage	3-6
3-3.	Resistance	3-7
3-4.	Frequency.....	3-7
3-5.	Thermocouple Temperature.....	3-8
3-6.	RTD Temperature	3-9
3-7.	Alarm Selection	3-10
3-8.	Initial Alarm Assignments, Digital I/O Lines 4 Through 7.....	3-12
3-9.	Mx+B Selection	3-14
3-10.	Scan Interval	3-15
3-11.	Measurement Rate Selection	3-16
3-12.	Trigger Type Selection	3-16
3-13.	Date/Time Selection	3-17
3-14.	Thermocouple Ranges	3-20
3-15.	Review Array	3-23
3-16.	List Button Operation	3-24
3-17.	Autoprint/Memory Storage Selection.....	3-26
3-18.	Clearing Memory Storage.....	3-26
3-19.	REM Annunciation	3-27
4-1.	RS-232 Setup	4-4
4-2.	IEEE-488.1 Capabilities	4-12
4-3.	IEEE-488 Setup	4-12
4-4.	Status Byte Register.....	4-19
4-5.	Event Status Register	4-20
4-6.	Instrument Event Register (IER)	4-22
4-7.	Command and Query Summary.....	4-23
4-8.	Command and Query Reference.....	4-26
5-1.	Ohms Test Voltage	5-8
6-1.	Power-Up Error Codes.....	6-5
6-2.	Recommended Test Equipment	6-6

6-3.	Performance Tests (Voltage, Resistance, and Frequency)	6-8
6-4.	Performance Tests for Thermocouple Temperature Function (IPTS-68/ITS-90) .	6-13
6-5.	Performance Tests for RTD Temperature Function (Resistance) (DIN/IEC 751 Amendment 1) (IPTS-68)	6-14
6-6.	Performance Tests for RTD Temperature Function (DIN/IEC 751 Amendment 1) (IPTS-68)	6-15
6-7.	Digital Input Values.....	6-17
E-1.	Floating Point Format	E-4

List of Figures

Figure	Title	Page
2-1.	Adjusting Handle	2-3
2-2.	Front Panel.....	2-5
2-3.	Left Display	2-6
2-4.	Right Display	2-6
2-5.	Annunciators.....	2-6
2-6.	Rear View	2-8
3-1.	Configuration Mode.....	3-3
3-2.	Input Module Connections	3-19
3-3.	2-Terminal and 4-Terminal Connections.....	3-21
3-4.	Totalizing Connection	3-22
4-1.	Data/Stop Bits.....	4-4
4-2.	Sample Program.....	4-10
4-3.	Typical Input Strings	4-15
4-4.	Overview of Status Data Registers	4-18
5-1.	External Trigger Timing	5-5
5-2.	2T and 4T-Connections	5-7
5-3.	Comparison of Common Waveforms	5-10
6-1.	Replacing the Line Fuse	6-4
6-2.	4-Terminal Connections to 5700A	6-12
6-3.	4-Terminal Connections to Decade Resistance Box	6-13
6-4.	Dedicated Alarms Output Test	6-20
6-5.	External Trigger Test.....	6-21
E-1.	ASCII String Decoding.....	E-2
E-2.	Floating Point Conversion	E-5
E-3.	Example	E-6
F-1.	Summary of RS-232 Connections	F-3
F-2.	Hydra (DB-9) to PC (DB-9) RS-232 Connection (Generic)	F-4
F-3.	Hydra (DB-9) to PC (DB-25) RS-232 Connection.....	F-5
F-4.	Hydra (DB-9) to Modem (DB-25) RS-232 Connection	F-6
F-5.	Hydra (DB-9) to Printer (DB-25) RS-232 Connection.....	F-7
F-6.	RS-232 DB9 and DB-25 Connectors.....	F-8

Caution

THIS IS AN IEC SAFETY CLASS 1 PRODUCT. BEFORE USING, THE GROUND WIRE IN THE LINE CORD OR THE REAR PANEL BINDING POST MUST BE CONNECTED FOR SAFETY.

Interference Information

This equipment generates and uses radio frequency energy and if not installed and used in strict accordance with the manufacturer's instructions, may cause interference to radio and television reception. It has been type tested and found to comply with the limits for a Class B computing device in accordance with the specifications of Part 15 of FCC Rules, which are designed to provide reasonable protection against such interference in a residential installation.

Operation is subject to the following two conditions:

- This device may not cause harmful interference.
- This device must accept any interference received, including interference that may cause undesired operation.

There is no guarantee that interference will not occur in a particular installation. If this equipment does cause interference to radio or television reception, which can be determined by turning the equipment off and on, the user is encouraged to try to correct the interference by one of more of the following measures:

- Reorient the receiving antenna
- Relocate the equipment with respect to the receiver
- Move the equipment away from the receiver
- Plug the equipment into a different outlet so that the computer and receiver are on different branch circuits

If necessary, the user should consult the dealer or an experienced radio/television technician for additional suggestions. The user may find the following booklet prepared by the Federal Communications Commission helpful: How to Identify and Resolve Radio-TV Interference Problems. This booklet is available from the U.S. Government Printing Office, Washington, D.C. 20402. Stock No. 004-000-00345-4.

Declaration of the Manufacturer or Importer

We hereby certify that the Fluke Model 2620A Data Acquisition Unit and 2625A Data Logger are in compliance with BMPT Vfg 243/1991 and is RFI suppressed. The normal operation of some equipment (e.g. signal generators) may be subject to specific restrictions. Please observe the notices in the users manual. The marketing and sales of the equipment was reported to the Central Office for Telecommunication Permits (BZT). The right to retest this equipment to verify compliance with the regulation was given to the BZT.

Bescheinigung des Herstellers/Importeurs

Hiermit wird bescheinigt, daß Fluke Model 2620A Data Acquisition Unit and 2625A Data Logger in Übereinstimmung mit den Bestimmungen der BMPT-AmtsblVfg 243/1991 funk-entstört ist. Der vorschriftsmäßige Betrieb mancher Geräte (z.B. Meßsender) kann allerdings gewissen Einschränkungen unterliegen. Beachten Sie deshalb die Hinweise in der Bedienungsanleitung. Dem Bundesamt für Zulassungen in der Telekommunikation wurde das Inverkehrbringen dieses Gerätes angezeigt und die Berechtigung zur Überprüfung der Seire auf Einhaltung der Bestimmungen eingeräumt.

Fluke Corporation

Safety Terms in this Manual

This instrument has been designed and tested in accordance with IEC publication 1010, Safety Requirements for Electrical Measuring, control and Laboratory Equipment. This Users Manual contains information, warnings, and cautions that must be followed to ensure safe operation and to maintain the instrument in a safe condition. Use of this equipment in a manner not specified herein may impair the protection provided by the equipment.

The meter is designed for IEC 664, Installation Category II use. It is not designed for use in circuits rated over 4800VA.

Warning statements identify conditions or practices that could result in personal injury or loss of life.

Caution statements identify conditions or practices that could result in damage to equipment.

Symbols Marked on Equipment



Danger - High voltage.



Ground (earth) terminal.



Protective ground (earth) terminal. Must be connected to safety earth ground when the power cord is not used. See Chapter 2.



Attention - refer to the manual. This symbol indicates that information about usage of a feature is contained in the manual. This symbol appears in the following two places on the instrument rear panel:

1. Ground Binding Post (left of line power connector). Refer to "Using External DC Power" in Chapter 2.
2. Alarm Outputs/Digital I/O Connectors. Refer to Appendix A, Specifications.

Warning

To avoid electric shock:

- **When the input module is installed, consider all channels with connections as accessible terminals that may be hazardous live.**
- **Disconnect the input module before touching or changing external wiring.**
- **Remove inputs from live voltages before opening the input module.**

AC Power Source

The instrument is intended to operate from an ac power source that will not apply more than 264V ac rms between the supply conductors or between either supply conductor and ground. A protective ground connection by way of the grounding conductor in the power cord is required for safe operation.

DC Power Source

The instrument may also be operated from a 9 to 16V dc power source when either the rear panel ground binding post or the power cord grounding conductor is properly connected.

Use the Proper Fuse

To avoid fire hazard, use only a fuse identical in type, voltage rating, and current rating as specified on the rear panel fuse rating label.

Grounding the Instrument

The instrument utilizes controlled overvoltage techniques that require the instrument to be grounded whenever normal mode or common mode ac voltages or transient voltages may occur. The enclosure must be grounded through the grounding conductor of the power cord, or if operated on battery with the power cord unplugged, through the rear panel ground binding post.

Use the Proper Power Cord

Use only the power cord and connector appropriate for the voltage and plug configuration in your country.

Use only a power cord that is in good condition.

Refer cord and connector changes to qualified service personnel.

Do Not Operate in Explosive Atmospheres

To avoid explosion, do not operate the instrument in an atmosphere of explosive gas.

Do Not Remove Cover

To avoid personal injury or death, do not remove the instrument cover. Do not operate the instrument without the cover properly installed. Normal calibration is accomplished with the cover closed, and there are no user-serviceable parts inside the instrument, so there is no need for the operator to ever remove the cover. Access procedures and the warnings for such procedures are contained in the Service Manual. Service procedures are for qualified service personnel only.

Do Not Attempt to Operate if Protection may be Impaired

If the instrument appears damaged or operates abnormally, protection may be impaired. Do not attempt to operate it. When in doubt, have the instrument serviced.

Getting Started

Introduction

This section will have you operating Hydra in a matter of minutes. All basic operating information is covered in this short Getting Started guide. Subsequent chapters of the manual cover the instrument in more detail.

Note

This manual contains information and warnings that must be followed to ensure safe operation and retain the instrument in safe condition.

The Basics

Hydra has 21 input channels: channel 0 is on the front panel, and channels 1 through 20 are on the rear input module.

There are two ways Hydra takes measurements (these can be used separately or together):

- A Scan function, which measures all channels at a specified scan interval.
- A Monitor function, which repeatedly measures any one channel.

The instrument has three different modes of operation:

- Active Mode - when the Scan and/or Monitor functions are on.
- Configuration Mode - when any of the setup parameters are being changed.
- Inactive mode - when the instrument is powered up, and sitting idle (i.e., not in Active Mode or Configuration Mode).

Turning On the Instrument

Press **POWER** ON. The entire display lights up as the instrument steps through a series of self tests. (Refer to Chapter 6 if any error messages are displayed during this self-test sequence.) When the self-tests are finished, the instrument resumes whatever mode it was in the last time power went off.

Normally it will go to Inactive Mode, and sit idle with a channel number on the right-hand display. You can change the displayed channel with **▲** and **▼**. Other annunciators are lit dimly to provide a summary description of the selected channel's setup.

The initial setup for all channels should be "off": as you scroll through the channels with **▲** or **▼**, the "OFF" annunciator should be on dimly. If any of the channels are set up otherwise, or if the instrument immediately starts taking measurements after the self-test sequence, then it still contains the previous user's setup. You can quickly get the instrument back to the initial setup by performing a "Configuration Reset".

To perform a Configuration Reset, press **POWER** OFF. Then hold **CANCEL** in, while pressing **POWER** ON; keep **CANCEL** pressed until the self-test sequence is finished and the instrument beeps one time.

Setting Up a Channel

1. Press **▲**, **▼** to select a channel to modify. For this example, start with channel 0.
2. Press **FUNC** to access the function setup menu.

The "SET" and "FUNC" annunciators come on, and the instrument goes into Configuration Mode. The present function for this channel is also highlighted (for

this example, "OFF" is lit if you're working with channel 0, and have already performed the Configuration Reset).

3. Press **▲**, **▼** to cycle through the choices for measurement function. For now, select "V AC", to set up the channel for AC voltage measurements.
4. Press **ENTER** to confirm your choice. The instrument then offers a choice of measurement ranges for this function, starting with "Auto" for autoranging.
5. Press **▲**, **▼** to cycle through the choices for range. Select the 300v range. (300v is available only on channels 0, 1 and 11.)
6. Press **ENTER** to confirm your choice.

This completes setting up channel 0 to measure AC voltage. The instrument returns to Inactive Mode, and the new setup for channel 0 is shown dimly on the display.

The sequence for setting up a channel to measure DC Voltage, Frequency or Resistance is very similar:

1. Press **▲**, **▼** to select a channel to set up.
2. Press **FUNC** to access the function setup menu.
3. Press **▲**, **▼** to cycle through the choices for measurement function, then press **ENTER**.
4. Press **▲**, **▼** to cycle through the choices for range, then press **ENTER**. This completes the setup for the channel and the instrument returns to Inactive Mode.

When you set up a channel to measure resistance, the instrument also lets you choose 2-Terminal or 4-Terminal measurements ("2T" or "4T") before returning to Inactive Mode. Note that 4-Terminal measurements are supported only on channels 1 - 10.

The sequence for setting up a channel to measure temperature is similar:

1. Press **▲**, **▼** to select a channel to set up.
2. Press **FUNC** to access the function setup menu.
3. Press **▲**, **▼** to select "°C" from the list of measurement functions, then press **ENTER**. (Chapter 3 of the manual explains how to change temperature measurement units.)
4. The instrument then offers a choice of 9 different thermocouple types, as well as "Pt" for platinum RTD's.

Press **▲**, **▼** to select a thermocouple type, then press **ENTER**. This completes the setup for the channel and the instrument returns to Inactive Mode.

When setting up a channel to measure RTD's, the instrument also prompts for 2-Terminal vs 4-Terminal measurements, and then allows you to specify a value for R0. (Note that Channel 0 cannot be set up to measure thermocouples or 4-Terminal RTD's.)

Subsequent sections of the manual explain how to set up alarm values and Mx+B linear scaling for each channel.

Selecting the Scan Data Destination

The 2620A will always send the scan data to the RS-232 printer port, following each scan. The 2625A can be configured to send the scan data to the RS-232 printer port, or to the internal Memory Storage, or to both simultaneously. Begin this procedure by selecting MODE (shift print). Select the scan data destination ("dESt" in the right display) as "Print" (left display) to send the data to the RS-232 port, as "StoreE" to send the data to Memory Storage, or as "both" for simultaneous storage and printing. Then

select the mode ("Mode" in right display) from "All" to output all scan data, "ALAr" to output only alarm data, or "trAnS" to output data scanned only when the Hydra goes into or out of alarm.



Once the destination and mode have been set, enable Memory Storage by pressing: print. The "PRN" annunciator lights to indicate that Memory Storage is enabled.

Warning

No data will be saved unless the "PRN" annunciator is lit on the on the Hydra from panel florescent display.

Memory contents can be sent to the RS-232 port for listing directly to a printer (refer to Table 3-16 in Chapter 3) or through the computer interface.

Taking Measurements

Before taking any measurements, you might want to set up a few more channels... set up three additional channels, as described below. (Remember, use  or  when in inactive Mode to select a channel, and then press .)

Channel	Function
0	V AC, 300V range
1	V DC, 30V range
2	(leave set up as "OFF")
3	Resistance, 3 mΩ range
4	Thermocouple Temperature ("°C" or "°F")
5 .. 20	(leave set up as "OFF")



Warning

Inputs may be connected to live voltages. To avoid electric shock remove inputs from live voltages before opening this module.

You need to connect wires to these channels before taking measurements. Insert a pair of test leads into the jacks on the front panel for channel 0. For channels on the rear Input Module, proceed as follows:

1. Remove the input module from the rear panel.
2. Loosen the two large screws on top and open the module.
3. Connect wires to the pairs of terminals for channels 1 and 3. We've enclosed some thermocouple wire for you to connect to channel 4; the thermocouple's red lead must be connected to the "low" input terminal, labeled "L". (Note that the enclosed thermocouple is for demonstration purposes only. Measurements taken with it may be off by 1 - 2 degrees.) Refer to Table 3-14 in Chapter 3 to identify the type of thermocouple by positive lead color. This table also shows the appropriate usable temperature range.
4. Thread the wires through the strain-relief pins and out the back of the module.
5. Close the cover, secure the screws, and insert the module back in the instrument.

The instrument is now ready to take measurements. Start with the Monitor function, which takes repeated measurements on a channel.



Press ,  to select a channel to Monitor.



Press  to activate the monitor function.

Note

You cannot activate the Monitor function if the selected channel is set up as OFF; the instrument gives a long beep and ignores your request.

The "MON" annunciator comes on, and the instrument starts taking measurements on the selected channel. If you haven't connected the input leads to a signal, the instrument simply displays a nominal noise reading; on channels set up to measure resistance, "OL" is displayed for overload. (The instrument also displays "OL", or "otc" for open thermocouple, when attempting to measure temperatures on channels to which no sensor has been connected.)

Press ,  to scroll through other channels and take additional measurements. Note that the instrument automatically skips over channels that are not set up (i.e., those channels still set to "OFF").



Press  to deactivate the Monitor function when you're through. ( toggles the Monitor function on and off.)

Next, press  to activate the Scan function. The "Scan" annunciator comes on, and the instrument begins taking measurements on all the channels you've set up.

When the scan completes, the instrument normally then counts down the time interval remaining until the next scan is due. (the countdown appears on the right display.) However, if you performed a Configuration Reset, then the scan interval has been set back to 0:00:00. Under this condition, the instrument performs continuous scanning. Subsequent sections of the manual explain how to change the scan interval.

Even with the scan function on, you can still use the Monitor function to watch a channel:

Press  to activate the Monitor function.

Press ,  to change the monitor channel, as desired. (The instrument continues to take scan measurements in the background.)

Press  to deactivate the Monitor function when you are through.

Similarly, press  to deactivate the Scan function when you are through.

Viewing Minimum, Maximum, and Last Data Values

While taking scan measurements, the instrument also collects Minimum, Maximum and Last values for each channel. These values are stored in the "Review Array." You can examine the data in the Review array when the instrument is in Active Mode or Inactive Mode. If you are in Active Mode, (i.e. the Scan and/or Monitor functions are on), the instrument will continue to take measurements in the background while you examine the Review data.

Press  to call up the Review array onto the display.

Use the four arrow buttons to examine different entries in the Review array. The arrow buttons move around in the Review array, as illustrated below.

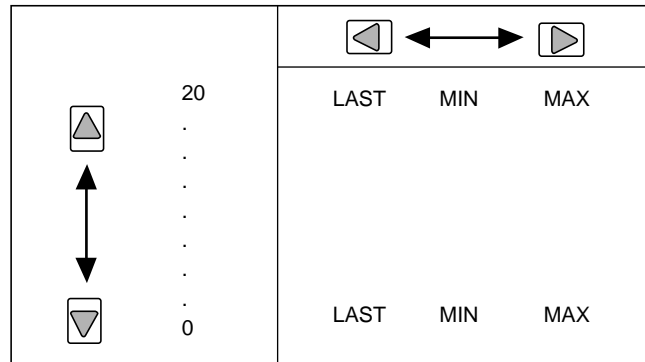

oo24f.eps

Press **REVIEW** or **CANCL** to remove the Review data from the display when you're through.

The remainder of this manual covers all aspects of using Hydra. Glance over the Table of Contents; you'll find that each section presents an additional layer of information. You can use as little as (or as much as) you need for your Hydra application.

Chapter 1

Introduction

Title	Page
The Hydra Series II Data Acquisition Unit	1-3
The Hydra Series II Data Logger	1-3
Options and Accessories	1-3
Applications Software	1-3
IEEE-488 Interface Assembly	1-3
Connector Set (2620A-100)	1-3
Accessories	1-5
Where to go From Here	1-5

Note

This manual contains information and warnings that must be followed to ensure safe operation and retain the instrument in safe condition.

The Hydra Series II Data Acquisition Unit

The Hydra Series II Data Acquisition Unit (Model 2620A) is a multi-channel data acquisition unit able to measure ac and dc voltages, temperature via thermocouples and RTDs, resistance, and frequency. It features 21 measurement channels, 8 digital input/output lines, a Totalizer input, and 4 alarm output lines. The Data Acquisition Unit is easily carried by hand and can be ac or dc powered. The user can choose communications with a host computer over an RS-232 (standard) or IEEE-488 (2620A/05) computer interface. Refer to Table 1-1 for a list of operating features.

The Hydra Series II Data Logger

The Hydra Series II Data Logger (Model 2625A) combines data logging memory with the features of the Data Acquisition Unit. The RS-232 computer interface is standard (IEEE-488 capability is not available.)

Options and Accessories

Applications Software

The following software packages are available for the instrument:

- Hydra Starter (included with instrument)
Allows for communication from an IBM-compatible personal computer through the RS-232 interface, emphasizing transfer of measurement and configuration settings to and from the instrument.
- Hydra Logger Package (order separately)
Hydra Logger (model 2635A-901) is a Windows-based package that allows complete set up and data collection and data conversion from up to 2 Hydra units. Logger communicates over the RS-232 port on a personal computer and may be used with telephone modems. Hydra Logger with Trending (model 2635A-902) includes a comprehensive trending package that simulates a chart recorder. A brochure with complete details is available.

IEEE-488 Interface Assembly

Model 2620A/05 includes an IEEE-488 Interface. Commands for the IEEE-488 interface are virtually identical to those used with the RS-232 Interface

If your Hydra Series II Data Acquisition Unit does not have an IEEE-488 Interface, a field-installable kit (2620A-05K) is available. The Hydra Series II Data Logger cannot be equipped with an IEEE-488 Interface.

Connector Set (2620A-100)

The 2620A-100 is a complete set of input connectors (one Input Module and two Digital I/O Connectors). These connectors allow for additional wiring setups so that a single Hydra Series II Data Acquisition Unit or Data Logger can then be moved among multiple installations.

Table 1-1. Hydra Features

<ul style="list-style-type: none">• Channel Scanning Can be continuous scanning, scanning at an interval time, single scans, or triggered (internal or external) scans.• Channel Monitoring Make measurements on a single channel and view these measurements on the display.• Channel Scanning and Monitoring View measurements made for the monitor channel while scanning of all active channels continues.• Multi-Function Display Left (numeric) display shows measurement readings; also used when setting numeric parameters. Right (alphanumeric) display used for numeric entries, channel number selection and display, status information, and operator prompts.• Front-Panel Operation Almost all operations can be readily controlled with the buttons on the front panel.• Measurement Input Function and Range Volts dc (VDC), volts ac (VAC), frequency (Hz), and resistance (Ω) inputs can be specified in a fixed measurement range. Autoranging, which allows the instrument to use the measurement range providing the optimum resolution, can also be selected.• Temperature Measurement Thermocouple types J, K, E, T, N, R, S, and B, and Hoskins Engineering Co. type C are supported. Also, DIN/IEC 751 Platinum RTDs are supported.• Totalize Events on the Totalizing Input• Alarm Limits and Digital Output Alarm Indication• 4-Terminal Resistance Measurements (Channels 1 through 10 only)• RS-232 Computer Interface Operation• Measurement Rate Selection• Nonvolatile Memory Storage of minimum, maximum, and most recent measurements for all scanned channels. Storage of Computer Interface setup, channel configurations, and calibration values. Storage of measurement data: storage for 2047 scans of up to 21 channels, representing up to 42,987 readings (Hydra Data Logger only).

Accessories

Accessories available for the instrument are described in Table 1-2.

Table 1-2. Accessories

Model	Description
80I-410	
80i-1010	Clamp-On DC/AC Current Probes.
80J-10	Current Shunt.
2620A-05K	Field-installable IEEE-488 Option kit (Hydra Data Acquisition Unit only).
2620A-901	Hydra Data Logger Applications Package.
C40	Soft carrying case. Provides padded protection for the instrument. Includes a pocket for the manual and pouch for the line cord.
M00-200-634	Rackmount Kit. Provides standard 19-inch rack mounting for one instrument (right or left side).
PM 8922	Switchable x1, x10 passive probe.
RS40	Shielded RS-232 terminal interface cable. Connects the instrument to any terminal or printer with properly configured DTE connector (DB-25 socket), including an IBM PC(\R), IBM PC/XT(\R) or IBM PS/2 (models 25, 30, 50, P60, 70, and 80).
RS41	Shielded RS-232 modem cable. Connects the instrument to a modem with properly configured DB-25 male pin connector. Use an RS40 and an RS41 cable in series to connect with an IBM PC/AT(\R).
RS42	Serial printer cable. Contact Fluke for list of compatible printers.
TL20	Industrial test lead set.
TL70	Test lead set.
Y8021	Shielded IEEE-488 one-meter cable, with plug and jack at each end.
Y8022	Shielded IEEE-488 two-meter cable, with plug and jack at each end.
Y8023	Shielded IEEE-488 four-meter cable, with plug and jack at each end.
Y9109	Binding post to BNC plug.
Fluke PN 268789	10Ω Precision Resistor, metal film, +/- 1%, 1/8 watt, 100 ppm. For use with 4 - 20 mA signals.

Where to go From Here

You might want take a minute to familiarize yourself with this manual. Glance through the table of contents at the front to see the overall layout of the manual and the major parts of the instrument. If you have questions about specific topics, the Index at the end of the manual will be useful. Or, just fan through the headers at the top of each page; each header reveals the chapter number and the chief subject for that page.

The chapters are summarized in the following paragraphs:

Getting Started

Provides a quick introduction to instrument setup and operation.

Chapter 1 Introduction

Describes standard features, options, and accessories for the Fluke Hydra Series II Data Acquisition Unit and Hydra Series II Data Logger. Also, this chapter discusses the organization and intended uses of this manual.

Chapter 2 Overview

Brings the instrument from its shipping container to operating status. This chapter provides brief descriptions and a quick walk-through of instrument operation. Read this chapter to gain a feel for instrument use. But please don't avoid reading Chapter 3 (for in-depth operation from the front panel) and Chapter 4 (for computer interface operation); the instrument is far more powerful than suggested in Chapter 2.

Chapter 3 Operating the Instrument from the Front Panel

Describes all capabilities available through front panel control. The features introduced in Chapter 2 are described more fully, including descriptions for setting up and using each type of measurement input (dc volts, thermocouple, etc.) and digital input (Totalizer, etc.) or output (such as alarms). Other features of the Hydra Series II Data Acquisition Unit and the Hydra Series II Data Logger are also more fully explained.

Chapter 4 Using the Computer Interface

Describes connecting the instrument to a terminal or host computer and operating the instrument over the RS-232 Interface. For the Hydra Series II Data Acquisition Unit only, use of the optional IEEE-488 Interface is also described here. This chapter is detailed and requires a good knowledge of instrument operation via the front panel (see Sections 2 and 3).

Chapter 5 Additional Considerations

Provides detailed operating information not provided elsewhere. This chapter also describes instrument operation for the advanced user. This chapter is written with the assumption that you have full knowledge of instrument operation from the front panel (Chapter 3).

Chapter 6 Maintenance

Provides performance tests (suitable as acceptance testing procedures) and routine maintenance information. Refer to this chapter for explanation of error codes encountered during instrument operation. Also, this chapter provides parts ordering information for such commonly used items as fuses, accessories, and publications.

Refer to the "Hydra Series II Service Manual" (P/N 688868) for complete service, repair, and parts ordering information.

Appendices

- A. Specifications
- B. ASCII/IEEE-488 Bus Codes
- C. IEEE-488.2 Device Documentation Requirements
- D. Making Mixed Measurements Service Centers
- E. Binary Upload of Logged Data (LOG_BIN?) (2625A only)

Index

Chapter 2 Overview

Title	Page
Introduction	2-3
Setting Up the Instrument.....	2-3
Unpacking and Inspecting the Instrument.....	2-3
Adjusting the Handle	2-3
Line Power	2-4
Front/Rear Panel Features.....	2-4
Input Channels	2-9
Operating Modes	2-9
Turning the Instrument On	2-9
Front Panel Display	2-10
Reading the Display	2-10
Left Display.....	2-10
Right Display	2-10
Specific Annunciators.....	2-10
Front Panel Buttons	2-11
Selecting a Channel.....	2-11
Using the Buttons.....	2-11
Setting up a Channel.....	2-12
Setting Alarm Limits and Mx+B Scaling Values.....	2-14
Alarm Limits	2-14
Mx+B Scaling	2-15
Setting the Scan Interval.....	2-15
Using the Monitor Function	2-16
Using the Scan Function.....	2-16
Reviewing Channel Data.....	2-16
Viewing the Totalizer Count	2-17
Using External DC Power	2-17
Using the Rack Mount Kit.....	2-18

Introduction

Chapter 2 provides an overview of the major features of the instrument. Comprehensive details on all instrument features are found in Chapter 3 (for front panel operation) and Chapter 4 (for computer interface operation.)

Setting Up the Instrument

Unpacking and Inspecting the Instrument

The following items are included in the shipping container:

- This manual
- Hydra Series II Starter Software
- Hydra Series II Data Acquisition Unit (2620A) or Hydra Series II Data Logger (2625A)
- Input Module
- Digital I/O and Alarms Connector
- Test leads
- Line cord

Carefully remove the instrument from its shipping container and inspect it for possible damage or missing items. If the instrument is damaged or something is missing, contact the place of purchase immediately. Save the container and packing material in case you have to return the instrument.

Rotate the rear feet 180 degrees so that their support pads extend slightly below the bottom of the case.

Adjusting the Handle

The handle can be positioned to four angles: one for carrying, two for viewing, and one for handle removal. To change the angle, simultaneously pull both handle ends outward to hard stops (about 1/4 inch on each side) and then rotate the handle to one of the four stop positions shown in Figure 2-1. With the handle in the straight-up removal position (4 in Figure 2-1), you can disengage and free one handle side at a time.

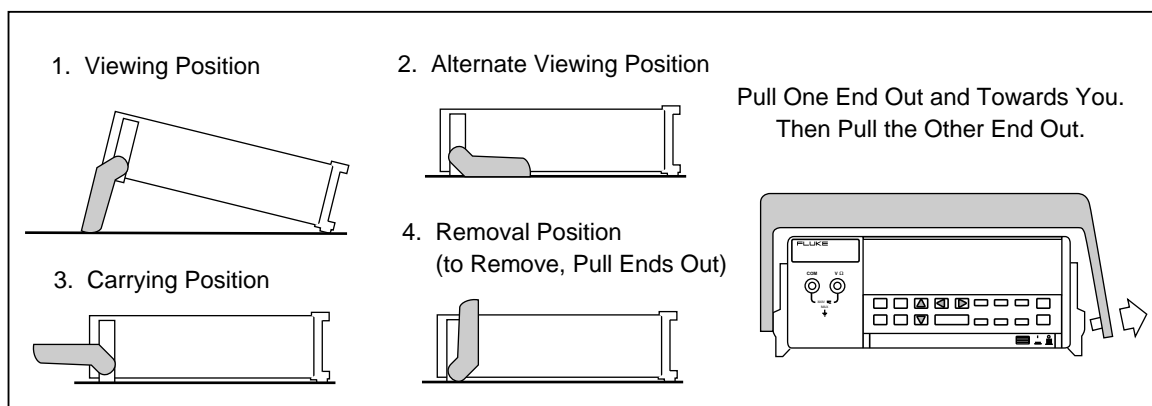

Figure 2-1. Adjusting Handle

0001f.eps

Line Power

Warning

To avoid shock hazard, connect the instrument power cord to a power receptacle with earth ground.

Plug the line cord into the connector on the rear of the instrument. The instrument operates on any line voltage between 90 and 264V ac without adjustment, and at any frequency between 45 and 440 Hz. However, the instrument is warranted to meet published specifications only at 50/60 Hz.

Front/Rear Panel Features

The Front Panel (shown in Figure 2-2) provides a two-terminal input for channel 0, a multipurpose display, and a set of control buttons. The display includes the following elements:

- A major numeric chapter (called the Left Display). See Figure 2-3.
- An auxiliary alphanumeric chapter (called the Right Display). See Figure 2-4.
- A set of Display Annunciators. See Figure 2-5 and Table 2-1.

The buttons control all instrument operations: channel configuration, instrument configuration, measurement functions, and print/communications selections. The buttons are introduced in this chapter, with a more detailed description following in Chapter 3.

The Rear Panel (shown in Figure 2-6) provides input and output connections: power input, measurement input, digital input/output, Totalizer input, alarm output, and computer interface connections. These connections are introduced in this chapter and explained in greater detail in subsequent chapters of this manual. Inputs and outputs are described with their related functions (Measuring DC Voltage, Totalizing, etc.) in Chapter 3. RS-232 and IEEE-488 Computer Interface connections are detailed in Chapter 4.

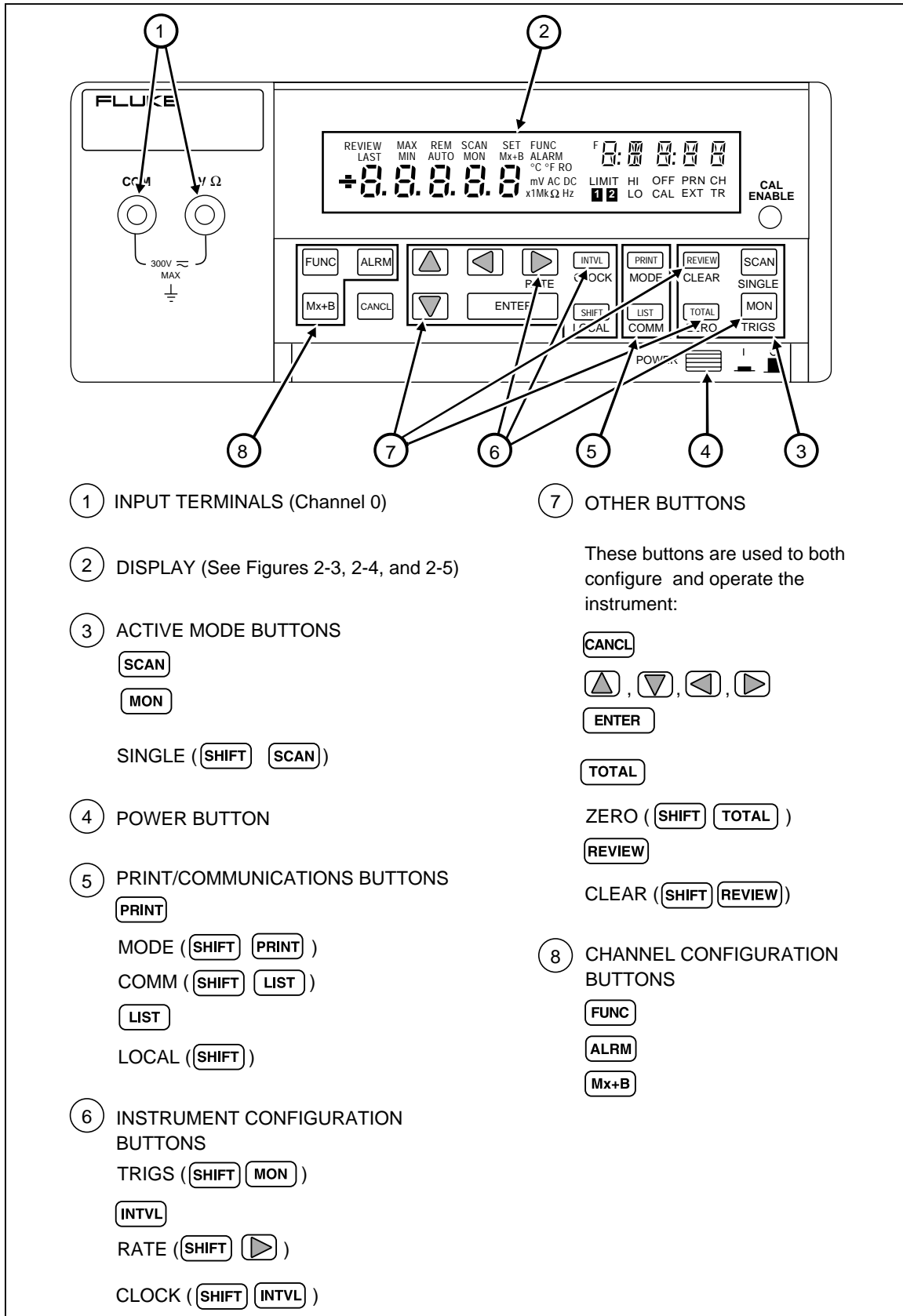

Figure 2-2. Front Panel

0002f.eps

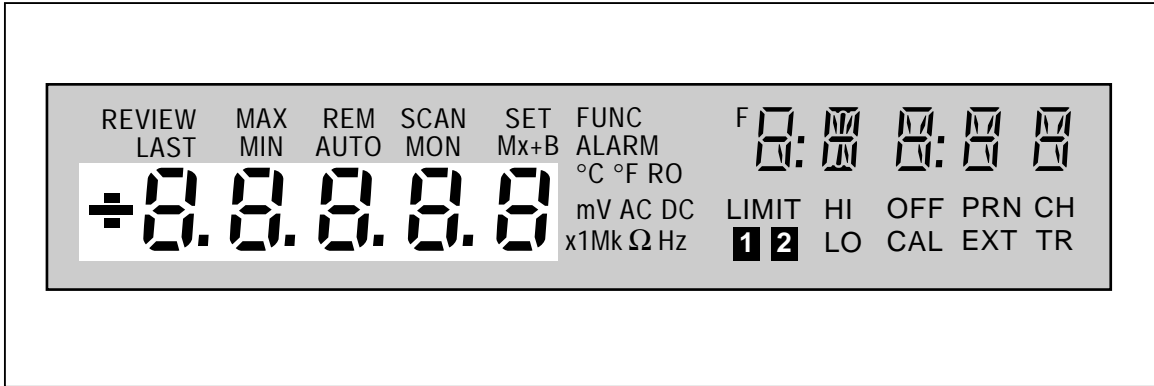

Figure 2-3. Left Display

oo03f.eps

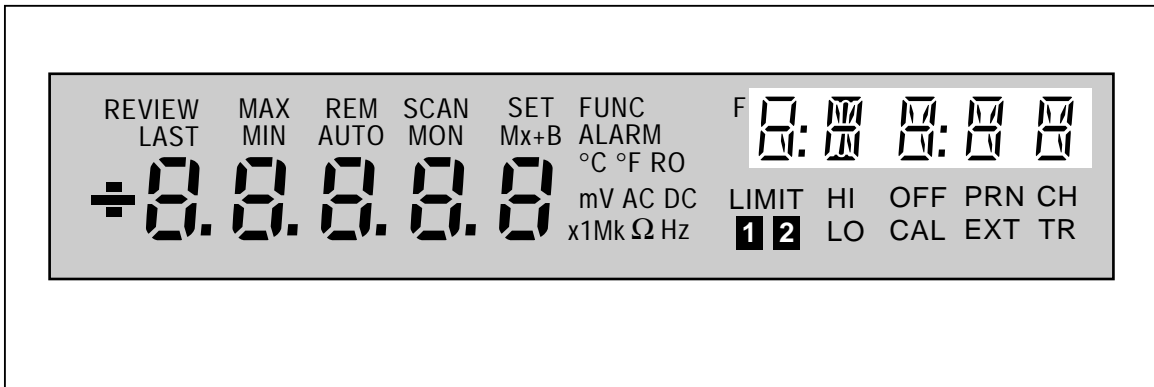

Figure 2-4. Right Display

oo04f.eps

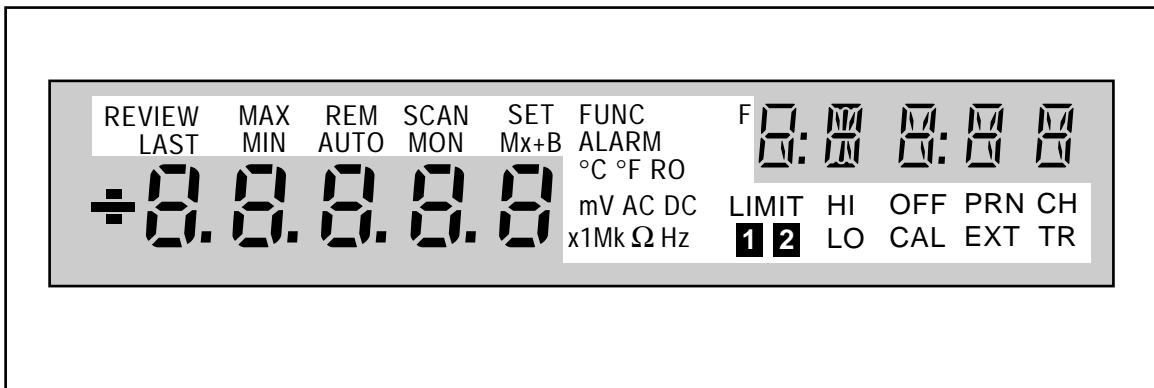

Figure 2-5. Annunciators

oo05f.eps

Table 2-1. Display Annunciators

MON	Indicates that the Monitor function is enabled.
SCAN	Indicates that the Scan function is enabled. Scanning can be enabled as a single scan (SINGLE SHIFT SCAN), with a scan interval, with an alarm-triggered scan, or as an externally triggered scan.
CH	Indicates that the channel number is displayed immediately above, in the right display.
SET	Lit when the instrument is in Configuration Mode.
Mx+B	Lit while Mx+B scaling is being defined and when a measurement on the display has been scaled with an M value other than 1 and/or a B value other than 0. Also dimly lit when in the Inactive Mode to indicate that an M value other than 1 and/or a B value other than 0 has been defined for this channel.
FUNC	Lit when a measurement function is being defined for this channel.
ALARM	Lit when alarm values are being defined for this channel or when an alarm limit has been exceeded while measuring.
V	Indicates that the measurement function is volts for this channel (used with the AC or DC annunciator).
DC	Indicates that the measurement function is dc voltage for this channel.
AC	Indicates that the measurement function is ac voltage for this channel.
Ω	Indicates that the measurement function is resistance for this channel.
Hz	Indicates that the measurement function is frequency for this channel.
°C	Indicates that the measurement function is temperature for this channel and that the degree unit is Celsius.
°F	Indicates that the measurement function is temperature for this channel and that the degree unit is Fahrenheit.
m	(milli) a multiplier for the displayed value, e.g., mV for millivolts. Also used when defining alarm and Mx+B values.
x1	(times 1) a multiplier for the displayed value. Used when defining alarm and Mx+B values.
k	(kilo) a multiplier for the displayed value, e.g., kHz for kilohertz. Also used when defining alarm and Mx+B values.
M	(mega) a multiplier for the displayed value, e.g., MΩ for megohms. Also used when defining alarm and Mx+B values.
R0	Lit when the ice point resistance is being defined for RTD measurements on the displayed channel.
OFF	Indicates there is no measurement function defined for the displayed channel; OFF channels are skipped over when scanning. OFF is also used when defining an alarm value to indicate that the alarm limit is to be ignored.
AUTO	Indicates that autoranging is enabled for the displayed channel.
LIMIT	Used with the 1 and 2 annunciators when you are setting an alarm limit value. Also lit when displaying a measurement value (LAST, Monitor) which has exceeded an alarm limit.

Table 2-1. Display Annunciators (cont)

"1"	Lit when alarm limit 1 is being defined. Also lit when displaying a measurement value (LAST, Monitor) which has exceeded alarm limit 1.
"2"	Lit when alarm limit 2 is being defined. Also lit when displaying a measurement value (LAST, Monitor) which has exceeded alarm limit 2.
HI, LO	Identifies alarm limit sensing (high or low) during channel configuration. At other times, identifies an alarm condition.
REVIEW	Indicates that review data is being displayed (used in conjunction with the MIN, MAX, and LAST annunciators).
MIN, MAX	Indicates that the displayed value is the minimum (maximum) value measured on this channel.
LAST	Indicates that the displayed value is the most recent scan measurement taken on this channel.
PRN	Indicates that the autoprnt function is enabled (to send readings to a printer) or the memory storage function is on (to store readings in internal memory.) Internal memory is available with Hydra Data Logger only.
F	Bright when memory storage is full, dim when memory storage is nearly full. Hydra Data Logger only.
EXT	Indicates that external triggering (on the rear panel) is enabled.
TR	Indicates that internal triggering (from the monitor alarm) is enabled. Also used with EXT when external triggering is enabled.
REM	Indicates that the instrument is under the remote control of one of the computer interfaces.
CAL	Indicates that the instrument's internal calibration constants have been corrupted.

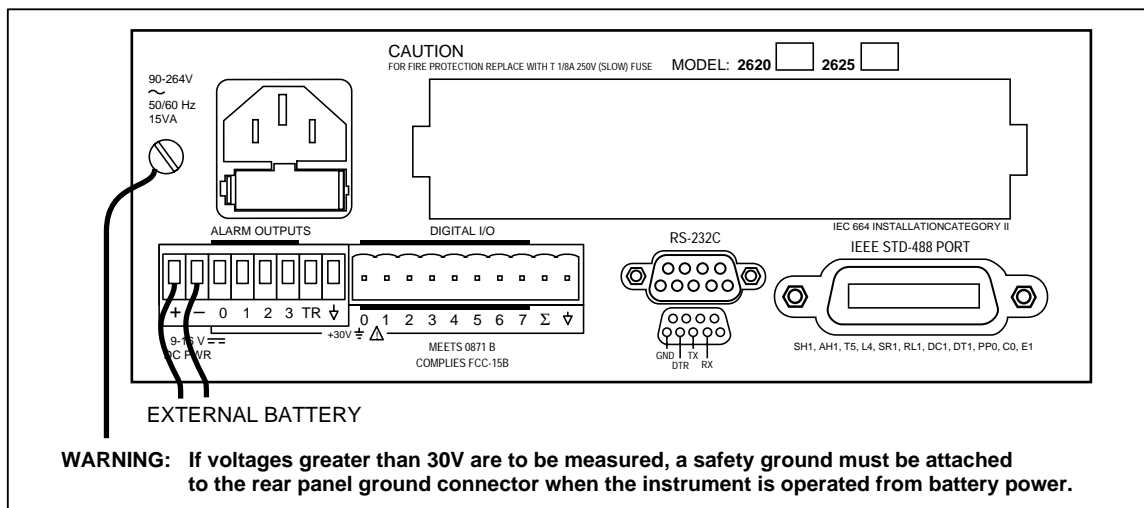

Figure 2-6. Rear View

0006f.eps

Input Channels

The instrument provides one input (channel 0) on the front panel and 20 inputs (channels 1 .. 20) through a connector on the rear panel. Channels 0, 1, and 11 can measure a maximum of 300V; all other channels can measure a maximum of 150V.

Caution

The maximum input that can be applied between any terminal of channels 2..10 and 12..20 is 150V dc or ac rms. The maximum input that can be applied between any terminal of channels 0, 1, and 11 and ground is 300V dc or ac rms. The maximum common mode input that can be applied is 300V dc or ac rms.

Operating Modes

The instrument provides three modes of operation:

- Active Mode

The instrument is in Active Mode whenever the Monitor and/or Scan functions are enabled. Scans are activated by the interval timer, an external trigger, an alarm trigger, or a single scan (SINGLE **SHIFT** **SCAN**) command. When in Active Mode, the MON and/or SCAN annunciators are lighted.

- Configuration Mode

The instrument is in Configuration Mode whenever settings (channel function, alarm values, Mx+B scaling values, scan interval, trigger type, etc.) are being examined or changed. When in the Configuration Mode, the SET annunciator is on, along with other annunciators indicating the parameter(s) being set.

- Inactive Mode

The instrument is in Inactive Mode when no measurement functions are enabled and no instrument settings are being examined or changed. This is a quiescent state; only summary channel information is displayed.

Turning the Instrument On

Turn the instrument on by pressing POWER on the lower right of the front panel. Initially, the entire display lights while the instrument conducts several internal self tests.

Note

*You can familiarize yourself with the instrument by holding the display fully lit. Press and hold **SHIFT**, then press **POWER** ON and wait a moment for the instrument to beep. Then release **SHIFT**. The entire display will now stay on until you press any button; the power-up sequence then resumes.*



A deviation in mainframe software Version 5.5 will not allow the display to remain ON. Versions 5.4 and below will allow the display to remain ON.

Any error conditions are momentarily displayed during this test sequence. Even in the presence of an error, the instrument still attempts to complete the self-test sequence and begin normal operation. However, if you encounter an error, note the number and refer to Self Test Diagnostics and Error Codes in Chapter 6 for additional information.

Once the self tests are completed, the instrument enters Inactive or Active Mode, depending on the following circumstances:

- Active Mode if this mode was in effect prior to the cycling of power. Scanning, monitoring, or combined scanning/monitoring is resumed.
- Inactive Mode if the instrument was in Inactive Mode or Configuration Mode prior to cycling of power.

When in Inactive Mode, the instrument shows configuration information for the displayed channel. The channel number appears in the right display, and other annunciators are dimly lit to show the present setup for this channel. For example, if the channel is set up to measure $k\Omega$, the "k" and " Ω " annunciators are dimly lit. Alternatively, if this channel has not been set up to measure anything, the "OFF" annunciator is lit dimly.

You can change the channel by pressing  or .

Front Panel Display

Full descriptions of the display annunciators are presented in Table 2-1.

Reading the Display

The instrument display uses both alphanumeric characters and fixed annunciators. When in Configuration Mode, these features are used to provide user prompting. In Inactive Mode, they provide status information. In Active Mode, they provide both status information and measurement data.

Information is presented on the display during both front panel control and computer interface control. If the instrument is being controlled through a computer interface, the display shows the results of computer-interface initiated actions (even if the front panel controls have been disabled.)

The remainder of Chapter 2 (as well as Chapter 3) relates to front panel control of the instrument. Refer to Chapter 4 for additional information about computer interface operation.

Left Display

The left display has five large numeric characters to show measurement results, "otc" when an open thermocouple is detected, or "OL" when a measurement is over range.

During Configuration Mode, the left display is also used to display the numeric values and instrument parameters being chosen.

Right Display

The right display has five small alphanumeric characters to show the channel number, display prompting information during setups, or to count down the scan interval.



Specific Annunciators

The rest of the display is devoted to specific annunciators, combinations of which are used to describe the operating mode, the type of measurement being displayed, or the type of setup information to be entered. These annunciators are described in Table 2-1 and shown in Figure 2-5.

Front Panel Buttons

Go ahead and press any front panel button. The instrument always provides an audible response to each button press. Valid entries yield a short beep; incorrect entries yield a longer beep. Don't worry if you press an inappropriate button and get a long beep; you can't damage the instrument. It will discard the button entry and wait for another entry.

Selecting a Channel

The channel number appears in the right display. Press  or  to select a channel. You can change the channel when in Inactive Mode, when looking at data in the Review array, or when the Monitor function is on.

Using the Buttons

Table 2-2 presents a summary of the control buttons.

Special button sequences cause a total instrument Configuration Reset or change the temperature units between °C and °F.



- Holding  down while turning the power on causes the instrument to perform a Configuration Reset. Hold the button down until the instrument beeps, indicating that the action has been taken. All channels will be reset OFF. All alarm and scaling values will be reset. Scanning and monitoring will be turned off.
- Holding  down while cycling POWER ON toggles the degree unit used with temperature measurements (°C or °F). Again, the instrument will beep and display °C or °F when this action is complete.

Table 2-2. Front Panel Pushbuttons













	Calls up the menu to set the function for the channel.
	Calls up the menu to set alarm limits 1 and 2 for the channel.
	Calls up the menu to set scaling on the channel.
   	Used to change the channel number and to step through choices in any of the setup menus. These arrow buttons have an automatic repeat action when held down for more than 1 second.  generates a service request when the instrument is under remote control without local lockout (REMS).
	Used to accept a selection just made in any setup menu.
	Used to exit setup menu and return to Inactive Mode, without saving settings you've selected thus far. Exceptions exist under the following two conditions: <ul style="list-style-type: none"> • If you cancel out of the alarm menu part way through defining alarm limit 2, any just-made entries for alarm limit 1 will still take effect. • If you cancel out of the Mx+B menu partway through defining the B value, any just-made changes to the M value will still take effect. This button also provides a handy way to remove the Totalizer value or Review data from the display.
	Turns the Scan function on or off.  triggers a single scan when the instrument is under remote control without lockout (REMS).

Table 2-2. Front Panel Pushbuttons (cont)

MON	Turns the Monitor function on or off.
INTVL	Allows you to change the scan interval. Scanning becomes continuous when the interval is set to 0:00:00.
PRINT	Enables/disables logging measurements to the printer (Autoprint - RS-232 only) or to internal data memory (Memory Storage). Only the Hydra Data Logger provides internal Memory Storage.
REVIEW	Calls up the Review array of MIN, MAX and LAST values to the display.
TOTAL	Calls up the present Totalizer count to the display.
LIST	(RS-232 only) Prints out the Last values of the Review array (2620A and 2625A) or Data Logger memory (2625A only) via the RS-232 interface.
SHIFT	Accesses secondary functions under various keys, as described below. When this button is pressed, "SHIFT" appears on the right display, but automatically disappears if you have not made a selection within 5 seconds or if you press ▼ .
LOCAL (SHIFT)	When under remote control without lockout (REMS), this returns control to the front panel.
RATE (SHIFT ▶)	Allows you to change the scanning speed: "Slo" for highest accuracy, or "FAST" for highest throughput.
CLOCK (SHIFT INTVL)	Allows you to set the internal day/date clock.
MODE (SHIFT PRINT)	Allows you to select the conditions for which scan measurements will be automatically printed or logged.
CLEAR (SHIFT REVIEW)	This button sequence clears the entire contents of the Review array. Review data must be presently shown on the display to clear the array.
COMM (SHIFT LIST)	Allows you to set up a computer interface port.
ZERO (SHIFT TOTAL)	While the Totalizer count is displayed, resets the Totalizer to 0.
SINGLE (SHIFT SCAN)	Forces an immediate scan of all defined channels. If a scan is presently in progress, this new request is ignored. Once begun, the full scan is completed. Configuration changes are not allowed while a scan is in progress.
TRIGS (SHIFT MON)	Allows you to set up the auxiliary scan trigger mechanisms.

Setting up a Channel

Channel set ups are made in Configuration Mode, which must be entered from Inactive Mode. If the instrument is in Active Mode, turn the Scan and/or Monitor function off before proceeding.

Follow the steps below to change the channel setup. More detailed instructions for setting all instrument parameters are provided in Chapter 3.

During the following steps, note that some items on the display are brightly lit, and others are dimly lit. The bright item is intended to focus your attention on the choice the instrument is offering you at that moment.

Note

Press **▼** to exit the channel setup menu at any time, leaving the old setup unchanged.

1. Select a channel to set up:
 - ▲ ▼ Look for the desired channel number in the right display.
2. Press the following buttons to change the setup:
 - FUNC** SET and FUNC come on bright, along with the present setting for measurement function.
 - ▲ ▼ Cycle through the choices for measurement function.
 - ENTER** Accept your choice of measurement function.

For resistance measurements, continue on with steps 3 and 4. For temperature measurements, skip to step 5.
3. For dc volts, ac volts, resistance, or frequency, the instrument now provides a choice of measurement ranges. Press the buttons as follows:
 - ▲ ▼ Cycle through the choices.
 - ENTER** Accept your choice.

For dc volts, ac volts, or frequency, the configuration is now complete for this channel. The instrument returns to Inactive Mode.
4. For resistance measurements, one more step is required to specify 2-terminal (2T) or 4-terminal (4T) measurements. Since 4-terminal measurements require two channels, 4-terminal measurements can be set up on channels 1-10 only. For each 4-terminal channel, a corresponding channel (11-20) ten numbers higher is reserved for the additional two connections required. Press the buttons as follows:
 - ▲ ▼ Choose between two terminals (2T) and four terminals (4T).
 - ENTER** Accept your choice. The instrument returns to Inactive Mode.
5. If you've specified temperature measurements, the instrument provides a choice of thermocouple types or Platinum RTD. Press the buttons as follows:
 - ▲ ▼ Cycle through the thermocouple choices. "Pt" is the RTD choice.
 - ENTER** Accept your choice.

If you selected one of the thermocouple types, channel configuration is complete; the instrument returns to Inactive Mode.
6. If you selected "Pt" (for RTD-based measurements), use the following buttons to specify 2-terminal (2T) or 4-terminal (4T) measurements and the R0 value.

Since 4T measurements require two channels, 4-terminal measurements can be set up on channels 1-10 only. For each 4T channel, a corresponding channel (11-20) ten numbers higher is reserved for the additional two connections required.

 - ▲ ▼ Choose between two terminals (2T) and four terminals (4T).
 - ENTER** Accept your choice.

Now choose the R0 (ice point) value (preset to 100.00). Use ► or ◀ to move between digits. Use ▲ or ▼ to select a value for each digit.

- ENTER** Accept your choice. Channel configuration is complete; the instrument returns to Configuration Mode.

Note

Any old alarm status/limits, Review array values, or scaling parameters are automatically cleared whenever you change a channel's function.

Setting Alarm Limits and Mx+B Scaling Values

Alarm limits and Mx+B scaling values are set in a manner very similar to that used for the channel function. Begin by pressing either of the following buttons:

ALRM To begin alarm limits settings for this channel.

Mx+B To begin scaling value settings for this channel.

The setup sequences are briefly discussed below. Refer to Chapter 3 for more details about these and other instrument parameters.

Alarm Limits

The menu for setting alarm limits allows you to set up both setpoints (**1** and **2**). After choosing a setpoint, the following settings must be made:

- The alarm sense HI, LO or OFF.
- The limit value (sign and number).
- The decimal point location.
- The value multiplier (m, x1, k, M).

Use **▲**, **▼**, **◀** and **▶** to cycle through the selections at each setting. Then press **ENTER** to accept your choice and move on to the next setting.

For example, to set a high limit of +5.35 for alarm **1** on channel 7, do the following:







1. Select channel 7 by pressing **▲** or **▼**.
2. Press **ALRM** to begin alarm setting for channel 7. "LIMIT" and **1** (for alarm limit 1) now appear in the display. Press **ENTER** **ENTER** to accept that you are setting up alarm limit 1.
3. Use the arrow buttons to select "HI". Then press **ENTER**.
4. Now use the arrow buttons again to set "+53500". Press **◀** or **▶** to move between digits. Press **▲** or **▼** to select the value for each digit. (Ignore the decimal point). Press **ENTER** to accept these digits.
5. Use the arrow buttons to select the decimal point position (" +5.3500"). Then press **ENTER** to accept this position.
6. Next, use the arrow buttons again to select the multiplier ("x1"). Press **ENTER** to accept this multiplier and save alarm limit 1.
7. Limit **1** for channel 7 is now set for a high value of +5.35. Continue pressing **ENTER** to step through alarm limit 2 and return to the Inactive Mode. Or, press **▼** to immediately return to the Inactive Mode.

Pressing **▼** while partway through setting limit **1** undoes any changes entered thus far for limit **1**, returning the instrument to Inactive Mode. Pressing **▼** while partway through setting limit **2** cancels entries made thus far for limit **2**, but does not affect any changes already made to limit "1".















Mx+B Scaling

The menu for setting Mx+B scaling values takes you through the following steps:



- Set the M value (sign and number).
- Set the decimal point location for the M value.
- Set the multiplier for the M value (m, x1, k, M).
- Set the B value (sign and number).
- Set the decimal point location for the B value.
- Set the multiplier for the B value (m, x1, k, M).

Use , ,  and  to cycle through the selections at each step. Then press   to accept your choice and advance to the next step.







For example, to set an M value of 1.8 and a B value of 32 for channel 7, do the following:

1. Select channel 7 by pressing  or .
2. Press  to begin Mx+B scaling setting for channel 7.
3. Use the arrow buttons to select "+18000". Press  or  to move between digits. Press  or  to select the value for each digit. (Ignore the decimal point). Press   to accept these digits.
4. Use the arrow buttons to select the decimal point position ("+1.8000"). Then press  to accept this position.
5. Next, use the arrow buttons again to select the multiplier ("x1"). Press  to accept this multiplier.
6. Use the arrow buttons to select +00320. Then press  .
7. Use the arrow buttons to select the decimal point position ("+0032.0"). Then press  to accept this position.
8. Next, use the arrow buttons again to select the multiplier ("x1"). Press  to accept this multiplier as the multiplier for the B value.

Mx+B scaling is now set at 1.8x+32 for channel 7.

Pressing  while partway through setting the M value undoes all changes entered thus far, returning the instrument to Inactive Mode. Pressing  while partway through setting the B value cancels entries made thus far for the B value, but does not affect any changes already made to the M value.

Setting the Scan Interval

Press  to set the scan interval. The latest value appears on the right display. The format of the display is H:MM:SS. Use  and  to move between digits. Use  and  to select the new value for a digit. Values ranging from 0:00:00 to 9:99:99 are allowed. Press  to accept the displayed value.

Set the interval to 0:00:00 for continuous scanning. If you set the interval to a value shorter than the time required to measure all channels, scanning effectively becomes continuous.

Using the Monitor Function

The Monitor function repeatedly measures the displayed channel. Press **MON** to activate the Monitor function. Use **▲** and **▼** to change the monitored channel; undefined channels (those set to OFF) are automatically skipped over.

Since the instrument cannot take measurements on a channel that has not been set up, it responds with a long beep if you try to activate the Monitor function on a channel that is defined as OFF. Press **▲** or **▼** to find a channel that has been set up, then activate the Monitor function. If all channels are defined as OFF, you must first set up one or more channels before activating the Monitor function.

Note

The Monitor function does not update data in the Review array, an Autoprint listing, or data memory (2625A). These values are updated only with measurements taken by the Scan function.

Using the Scan Function

The Scan function takes measurements at the specified interval on all defined channels. Pressing **SCAN** to activate the Scan function causes all defined channels to be measured in sequence. This cycle repeats at the specified scan interval. When **SCAN** is pressed a second time, the Scan function is turned off, and the instrument returns to the Inactive Mode.

Note

During a scan, a channel set up with autoranging will momentarily slow the scanning rate whenever the correct range must be determined. This will occur during the initial scan; the instrument remembers the range for subsequent scans. Scans then occur at the normal measurement rate. If the input signal later changes sufficiently, the scanning rate will again slow momentarily while the instrument determines the new range.

If scanning is deactivated while the instrument is actually taking scan measurements, the display changes immediately, but the full scan is still completed. The instrument always completes a scan in progress.

You can also trigger a single scan of all defined channels. Select SINGLE (**SHIFT** **SCAN**) to scan all the defined channels once.

Reviewing Channel Data

The instrument automatically stores minimum, maximum, and last-scanned values for each defined channel. These values are stored in the Review array and are updated with each set of scan measurements. Measurements taken by the Monitor function are not included in the Review array.

The contents of the Review array can be called up to the display when in Active or Inactive Mode by pressing **REVIEW**. The displayed channel must be defined (i.e., not OFF) to call up Review array data from Inactive Mode; otherwise, a long beep results.

You can move around in the Review array using the arrow buttons. The access scheme is shown in Table 2-3. Either the Review array or the Totalizer count can be displayed at one time; you must deactivate one before activating the other.

To remove the Review data from the display and restore the previous display, press **REVIEW** again, or press **▼**.

To clear out the contents of the Review array, press **REVIEW** to call the review data up to the display, and then select **CLEAR** (**SHIFT** **REVIEW**). The entire array is then cleared. All array values, including the displayed value, are changed to "----". If a scan is occurring when a review clear is requested, new review values are taken from the next scan. If the Scan function is not active, "----" continues to be shown for all values.

Alarms are shown with the LAST review values. Refer to Alarm Indications in Chapter 3 for a description of alarm annunciation.

Table 2-3. Review Array

Activate	Review Points	Deactivate
<p>REVIEW</p> <p style="text-align: right;">20</p> <p style="text-align: center;">▲</p> <p style="text-align: center;">•</p> <p style="text-align: center;">↑</p> <p style="text-align: center;">•</p> <p style="text-align: center;"> </p> <p style="text-align: center;">•</p> <p style="text-align: center;">↓</p> <p style="text-align: center;">•</p> <p style="text-align: center;">▼</p> <p style="text-align: right;">0</p>	<p>◀ ↔ ▶</p> <p>LAST MIN MAX</p> <p>LAST MIN MAX</p>	<p>REVIEW</p> <p style="text-align: center;">or</p> <p>CANCL</p>

Viewing the Totalizer Count

The Totalizer continuously samples the Totalizer input on the rear panel. The present count can be called up to the display when in Active or Inactive Mode by pressing **TOTAL**. The word "totAL" appears on the right display, and the present Totalizer count appears on the left display.

The maximum count is 65535, after which "OL" is displayed. To reset the Totalizer to zero, press **TOTAL** to call the Totalizer value to the display, and then select **ZERO** (**SHIFT** **TOTAL**).

To remove the Totalizer value from the display and restore the previous display, press **TOTAL** again, or press **▼**.

Note that either the Review array or the Totalizer count can be displayed at one time; you must deactivate one before activating the other.

Using External DC Power

The instrument can be powered from an external 9 to 16V dc source. Refer to Appendix A, Specifications, for additional information about dc power requirements.

Terminals for positive, negative, and ground connections are provided on the instrument rear panel. Figure 2-6 shows connection locations.

⚠ Warning

If voltages greater than 30V are to be measured, a safety ground must be attached to the rear panel ground connector when the instrument is operated from battery power.

Using the Rack Mount Kit

Use the M00-200-634 Rack Mount Kit to mount the instrument in a standard 19-inch rack. First, rotate the two bottom feet on the instrument 180 degrees so that the support pads point up. Then install the instrument per the instructions provided with the Rack Mount Kit.

Chapter 3

Operating the Instrument from the Front Panel

Title	Page
Introduction	3-3
Operating Modes	3-3
Other Displayed Data	3-4
What is the Present Configuration?.....	3-4
If Power is Interrupted	3-4
If the Configuration is Reset	3-4
Channel Configuration	3-4
Selecting Channel, Function, and Range	3-4
Setting Alarms.....	3-9
Alarm Limits.....	3-9
Alarm Indications	3-10
Resetting Alarm Conditions	3-11
Using the Digital I/O Lines	3-11
Mx+B Scaling	3-12
Instrument Configuration	3-14
Entering and Changing Numeric Values.....	3-14
Selecting Scan Interval.....	3-15
Selecting the Measurement Rate.....	3-15
Triggering.....	3-16
External Triggering	3-16
Changing the Temperature Unit.....	3-16
Setting Date and Time of Day.....	3-17
Measurement Connections	3-17
DC Volts, AC Volts, Frequency, and Thermocouples.....	3-18
Resistance and RTD.....	3-20
Totalizing.....	3-22
General	3-22
Connections.....	3-22
Review Array.....	3-22
List Button Functions	3-23
Autoprint	3-25
Memory Storage	3-25
Front Panel Lock out Conditions.....	3-26

Front Panel Review Only Function.....	3-26
Front Panel Monitor Only Function.....	3-26
Computer Interface-Initiated Lockouts	3-27
REM Annunciator	3-27
Calibration	3-27

Introduction

Chapter 3 describes how to use the instrument features that were introduced in Chapter 2. The introductory information in Chapter 2 is designed to give you a feel for the instrument's controls and display. The information presented here in Chapter 3 adds more detail about connecting and operating the instrument.

Operating Modes

The instrument has three modes of operation. These modes are summarized as follows:

- Active Mode

The instrument is in Active Mode whenever the Monitor and/or Scan functions are enabled; "MON" and/or "SCAN" annunciators are lighted, as appropriate. Note that the Scan function can be activated by the scan interval timer, external trigger, alarm trigger, or a single scan command.

- Configuration Mode

The instrument is in Configuration Mode whenever any of the settings are being examined or changed. Examples of Configuration Mode are: channel function selection, alarm value setting, Mx+B scaling value setting, scan interval setting, and trigger type selection. During Configuration Mode, the "SET" annunciator is on, along with other annunciators indicating the parameter being set. Configuration Mode is summarized in Figure 3-1.

- Inactive Mode

The instrument is in Inactive Mode when no measurement functions are enabled and no instrument settings are being changed. This is a quiescent mode, from which Active or Configuration Mode can be entered. The display presents summary information, identifying the channel number (brightly lit, right display) and its present function (dimly lit annunciator).

Configuration Mode

Start from Inactive Mode. For full configuration sequence descriptions, refer to the appropriate description in Section 3 or 4. Exit any configuration sequence early (and discard changes) by pressing **CANCL**.

FUNC		Define a measurement function for this channel.
ALRM		Set alarm parameters for a defined channel.
Mx+B		Set scaling and offset parameters for this defined channel.
INTVL		Set time interval between scans.
SHIFT	MON	Select scan triggering type.
	TRIGS	
SHIFT	INTVL	Set date and time.
	CLOCK	
SHIFT	▶	Select measurement rate.
	RATE	
SHIFT	PRINT	Select autoprint/memory storage.
SHIFT	LIST	Set computer interface parameters.
	COMM	

Figure 3-1. Configuration Mode

Other Displayed Data

An array of "MIN", "MAX", and "LAST" values for each channel is updated whenever scan measurements are taken. This Review array can be displayed from Active or Inactive (but not Configuration) Mode by pressing **REVIEW**.

The constantly updated Totalizer count can also be displayed (Active or Inactive Mode only) by pressing **TOTAL**.

Note that either the Review array or the Totalizer count can be displayed at one time; you must deactivate one before activating the other. Deactivate the Review array by pressing **REVIEW** a second time. Deactivate the Totalizer display by pressing **TOTAL** a second time. Pressing **CANCL** also deactivates either function.

What is the Present Configuration?

If Power is Interrupted

All configuration settings (function, range, scan interval, etc.) are stored in nonvolatile memory. If power is interrupted (**POWER** pressed off or due to power loss), these settings are retained. When turned on, the instrument first executes a self test, then resumes the state it was in prior to interruption of power. This feature is handy for applications where power may be inadvertently lost; the instrument automatically resumes taking measurements, as originally configured, once power is restored.

If the Configuration is Reset

You can perform a Configuration Reset in either of two ways:

- From the front panel, press and hold **•** when cycling POWER ON.
- Through the computer interface, send the *RST command.

Refer to Table 3-1 for the configuration reset settings.

Channel Configuration

Configuration Mode involves selecting an entry from a list of choices (and may involve setting number values.) Measurements are not taken when the instrument is in Configuration Mode. Configuration Mode is discussed throughout this chapter; it is used whenever a parameter for a channel or for the whole instrument needs to be set.

Selecting Channel, Function, and Range

Steps necessary for setting each type of measurement function are shown in the following tables:

- DC Voltage Measurement (Table 3-2)
- AC Voltage Measurement (Table 3-2)
- Resistance Measurement (Table 3-3)
- Frequency Measurement (Table 3-4)
- Temperature Measurement Using Thermocouples (Table 3-5)
- Temperature Measurement Using RTDs (Table 3-6)

Additional channel configuration steps (alarms, scaling, etc) are discussed later in this chapter.

Table 3-1. Configuration Reset Settings

Perform a Configuration Reset to restore these conditions by pressing and holding CANCL while cycling POWER ON.																															
Channels 0 - 20:	OFF.																														
Measurement rate:	Slow.																														
Scaling (M):	1 (all channels)																														
(B):	0 (all channels)																														
Alarm parameters:	Limit-1 and Limit-2 OFF. All limit values 0.																														
Alarm assignments:	Channels 0-3 assigned to outputs 0-3 respectively. Channels 4-20 assigned to digital I/O lines 4-7, as follows (appropriate channels are OR'ed to drive each I/O line):																														
	<table border="1" style="margin-left: auto; margin-right: auto; border-collapse: collapse;"> <tr> <td style="padding: 2px;">DIGITAL I/O LINE</td> <td style="padding: 2px;">4</td> <td style="padding: 2px;">5</td> <td style="padding: 2px;">6</td> <td style="padding: 2px;">7</td> </tr> <tr> <td style="padding: 2px;">ASSIGNED TO</td> <td style="padding: 2px;">4</td> <td style="padding: 2px;">5</td> <td style="padding: 2px;">6</td> <td style="padding: 2px;">7</td> </tr> <tr> <td style="padding: 2px;">CHANNELS</td> <td style="padding: 2px;">8</td> <td style="padding: 2px;">9</td> <td style="padding: 2px;">10</td> <td style="padding: 2px;">11</td> </tr> <tr> <td></td> <td style="padding: 2px;">12</td> <td style="padding: 2px;">13</td> <td style="padding: 2px;">14</td> <td style="padding: 2px;">15</td> </tr> <tr> <td></td> <td style="padding: 2px;">16</td> <td style="padding: 2px;">17</td> <td style="padding: 2px;">18</td> <td style="padding: 2px;">19</td> </tr> <tr> <td></td> <td style="padding: 2px;">20</td> <td></td> <td></td> <td></td> </tr> </table>	DIGITAL I/O LINE	4	5	6	7	ASSIGNED TO	4	5	6	7	CHANNELS	8	9	10	11		12	13	14	15		16	17	18	19		20			
DIGITAL I/O LINE	4	5	6	7																											
ASSIGNED TO	4	5	6	7																											
CHANNELS	8	9	10	11																											
	12	13	14	15																											
	16	17	18	19																											
	20																														
Scan interval time:	0:00:00 (continuous)																														
Review values (MIN, MAX, LAST):	cleared for all channels.																														
Digital I/O lines:	set high (non-alarm)																														
Totalizer:	0, with debounce disabled.																														
Autoprint:	OFF.																														
Memory Storage (2625A only):	OFF, empty																														
RTD R0 parameter:	100.00 (all channels)																														
Open Thermocouple Detection (OTC):	enabled.																														

Note

During a scan, a channel set up with autoranging will momentarily slow the scanning rate whenever the correct range must be determined. This will occur during the initial scan, with the instrument remembering the range for subsequent scans. Scans then occur at the normal measurement rate. If the input signal later changes sufficiently, the scanning rate will again slow momentarily while the instrument determines the new range.

AC voltage measurements can be made over a wide range of frequencies. The instrument's true rms converter insures accuracy for both sine wave and non-sine wave signals. Refer to Chapter 5 for additional information about true rms measurements.

Resistance measurements can be made to determine either resistance or the value of another directly related parameter. Slide wire potentiometers, thermistors, and other sensors with variable resistance outputs are often used to indicate temperature, position, and other physical parameters. The instrument measures resistance by passing a current

through both a known resistance and the sensed resistance. The resulting voltages are measured and appropriate conversions are applied to the measurement, yielding a displayed output in ohms.

Frequency is measured by counting cycles for a known time period. The measurement represents the frequency observed during the sampling time. The instrument can measure a wide range of frequency inputs. Test applications might include measuring line voltage sine wave signals or measuring the output of a voltage-to-frequency converter used in a servo system.

Thermocouple temperature measurements can be made using linearizations for the following nine standard thermocouples: J, K, E, T, N, R, S, B, C. You specify what type of thermocouple is connected to the channel. The reference temperature sensor is built into the Input Module. The instrument applies compensation automatically for thermocouple channels. Open thermocouple detection is indicated by "otc" in the left display. The thermocouples are further described in Table 3-14.

Table 3-2. DC Voltage, AC Voltage

Channel		Function (DC or AC)		Range (Note)	
PRESS	▲	▲	▲	▲	▲
THESE		FUNC		ENTER	ENTER
BUTTONS:	▼	▼	▼	▼	▼
TO	0	OFF		Auto	(Completes
SELECT	1	V DC		300.00 mV	Selection
FROM	.	V AC		3.0000V	and returns
THESE	.	Ω		30.000V	to Inactive
CHOICES:		Hz		150.00*V	Mode)
	20	°C or °F			
				* 300.00 CH 0, 1, and 11	
<i>Note: Determine the highest ac or dc voltage value anticipated for this channel. Then select a range large enough to accommodate this value. If the highest voltage cannot be anticipated, select "Auto".</i>					

Table 3-3. Resistance













Channel		Function		Range (Note 1)		Terminals	
PRESS THESE BUTTONS:							
							
TO SELECT FROM THESE CHOICES:	0 1 . . 20	OFF V DC V AC Ω Hz $^{\circ}$ C or $^{\circ}$ F		Auto 300.00 Ω 3.0000 k Ω 30.000 k Ω 300.00 k Ω 3.0000 M Ω 10.000 M Ω		2T 4T	(Completes Selection and returns to Inactive Mode)
<p>Note 1. Determine the highest resistance value anticipated for this channel. Then select a range large enough to accommodate this value. If the highest resistance cannot be anticipated, select "Auto".</p> <p>Note 2. "4T" allowed on channels 1 through 10 only. For each 4T channel, an additional channel (10 channels higher) is reserved to provide the third and fourth terminals. Channels 11 through 20 are available for this purpose. Any channel so reserved cannot be used for other definitions.</p>							

Table 3-4. Frequency









Channel		Function		Range (Note)		
PRESS THESE BUTTONS:						
						
TO SELECT FROM THESE CHOICES:	0 1 . . 20	OFF V DC V AC Ω Hz $^{\circ}$ C or $^{\circ}$ F		Auto 900.00 Hz 9.0000 kHz 90.000 kHz 900.00 kHz 1.0000 MHz		(Completes Selection and returns to Inactive Mode)
<p>Note: Determine the highest frequency anticipated for this channel. Then select a range large enough to accommodate this value. If the highest frequency cannot be anticipated, select "Auto". "Auto" does not cause any delays for frequency measurements.</p>						

Table 3-5. Thermocouple Temperature

Channel		Function	Range (Note)
PRESS THESE BUTTONS:	▲ ▼	▲ ▼	▲ ▼
	FUNC	ENTER	ENTER
TO SELECT FROM THESE CHOICES:	1 . . 20	OFF V DC V AC Ω Hz °C or °F	J K E T N R S b C Pt
(Completes Selection and returns to Inactive Mode)			
<p><i>Note: The nine thermocouple choices and related temperature measurement ranges are:</i></p> <p>"J" Type J (-210 to 760 °C) "K" Type K (-270 to 1372 °C) "E" Type E (-270 to 1000 °C) "T" Type T (-270 to 400 °C) "N" Type N (-270 to 1300 °C) "R" Type R (0 to 1767 °C) "S" Type S (0 to 1767 °C) "b" Type B (0 to 1820 °C) "C" Type C (0 to 2316 °C)* (Tungsten - 5% Rhenium vs. Tungsten - 26% Rhenium)</p> <p>"Pt" selects RTD temperature measurement (DIN/IEC 751). See Table 3-6.</p> <p>* Hoskins Engineering Co.</p>			

Table 3-6. RTD Temperature

	Channel	Function	Type (Note 1)	Terminals (Note 2)	R0 (Ice Point) (Note 3)
PRESS THESE BUTTONS:	▲ ▼	▲ ▼	▲ ▼	▲ ▼	▲ ▼ ◀ ▶
TO SELECT FROM THESE CHOICES:	0 1 . . 20	OFF V DC V AC Ω Hz °C or °F	J K E T N R S b C Pt	2T 4T	100.00
<p><i>Note 1. Pt selects RTD temperature measurement (DIN/IEC 751). See Table 3-5 for J, K, E, T, N, R, S, b, and C thermocouple selections.</i></p> <p><i>Note 2. 4T not available on channels 0 and 11 through 20.</i></p> <p><i>Note 3. R0 default is 100.00Ω. A unique R0 value can be set for each channel.</i></p>					

Note

Temperature units can be displayed in degrees Celsius (°C) or Fahrenheit (°F). To switch this setting between °C and °F, start with the instrument powered off, then press and hold (Mx+B) while pressing POWER ON. The setting can also be changed through the Computer Interface with the TEMP_CONFIG command (refer to Chapter 4.)

RTD temperature measurement uses a resistance-temperature detector (RTD). RTDs, while usually larger and more expensive than thermocouples, are frequently used where accuracy, stability, and repeatability are important. The resistance of an RTD varies directly with the sensor temperature. Passing a current through this resistance generates a proportional voltage that can be accurately translated into a temperature reading. The instrument supports the DIN/IEC 751 RTD type.

Setting Alarms

Alarm Limits

Note

If you press (ALRM) for a channel that is OFF, an error beep will result. Therefore, for a new channel, use (FUNC) to define the channel's measurement function before selecting (ALRM).

Two alarm limits (1 and 2) can be defined for each analog input channel. An alarm occurs when the measured value on the channel moves above the HI value or below the LO value. With the desired channel already selected from Inactive Mode, verify or change these limits using the procedure shown in Table 3-7. If necessary, refer to "Entering and Changing Numeric Values" for a more detailed description of the number changing technique used here.

Alarm evaluation is not carried out for a channel if:

- The limit sense is changed to "OFF". Alarm checking and the alarm limit values are re-enabled by setting limit sense to "HI" or "LO".
- An open thermocouple has been detected on that channel (thermocouple temperature function only).

Table 3-7. Alarm Selection

Channel	Alarm					
PRESS THESE BUTTONS:					Complete Alarm Parameters (Below)	
TO SELECT FROM THESE CHOICES:	0	1 or 2		.	.	20
Alarm Parameters						
	Alarm Limit (Note 1)	Sign, Value	Decimal Point Position	Multiplier (Note 2)		
PRESS THESE BUTTONS:						
TO SELECT FROM THESE CHOICES:	OFF	±0000	0.0000	m		
	HI		00.000	x1		
	LO		000.00	k		
			0000.0	M		
<i>Note 1. Alarm limit can be cycled through HI, LO, and OFF without resetting the alarm value.</i>						
<i>Note 2. Multiplier definitions (available for each decimal point position):</i>						
	m .001					
	x1 1.0					
	k 1000					
	M 1000000					

Alarm Indications

Generally, the ALARM annunciator is dimly lit whenever the last measurement on any channel was found to be in alarm. When the displayed channel is in alarm during review, the ALARM annunciator flashes, LIMIT is lit, and additional annunciators show the alarm limit as 1 and/or 2 and the alarm sense as "HI" or "LO".

Alarm annunciation is disabled when the instrument is in Inactive or Configuration Mode.

ALARM annunciation and evaluation follow these rules:

1. When any channel reading from the latest scan is in alarm (but the presently displayed channel is not in alarm or a scan interval countdown is in progress):
 "ALARM" annunciator is dimly lit.
2. If the presently displayed channel (i.e., the Monitor or the Review array Last channel) is in alarm:
 "ALARM" annunciator flashes. **1** and/or **2** limit annunciator on brightly. "HI" and/or "LO" sense annunciator on brightly. "LIMIT" annunciator on brightly.
3. If the present channel is in alarm with a value of "OL" displayed:
 "OL" means that a very large positive number is used for alarm evaluation.
 "-OL" means that a very large negative number is used for alarm evaluation.
4. If the present channel shows a value of "otc":
 Alarm limit checking is no longer occurring for that channel. Alarm status remains as it was prior to the "otc" condition.
5. If no channels are in alarm:

All alarm-related annunciators ("ALARM", **1**, **2**, "HI", "LO", "LIMIT") are off.

Note

Alarms encountered during scan measurement can generate a low level on an assigned output. If an alarm is encountered and just the monitor function is selected without the scan function, the front panel will indicate the alarm; but, the alarm output will not change to indicate the alarm. An IEEE-488.1 SRQ can also be generated when an alarm condition is set or cleared.

Resetting Alarm Conditions

When review values are cleared, all alarm status is also removed. This action occurs in the following instances:

- A channel function is changed or set to OFF.
- A channel range is changed.
- CLEAR (SHIFT REVIEW) is selected while Review array data is being examined.
- Configuration Reset occurs (power up CANCEL or *RST)

Changing an alarm definition clears the alarm status for the changed alarm limit.

Using the Digital I/O Lines

The rear panel Digital I/O Connector provides eight lines (numbered 0 through 7) that are individually usable as inputs or outputs. No preconfiguring for the use of these lines is necessary; an input low signifies that the line is an input, and an output low signifies that the line is an output. Output low conditions take precedence over input low conditions.

Both alarm limits **1** and **2** for channels 0 through 3 are permanently assigned to alarm outputs 0 through 3, respectively, on the rear panel Alarm Output Connector.

At any Configuration Reset (power up **CANCL** or computer interface *RST), alarm limits on channels 4 through 20 are assigned to Digital I/O lines 4 through 7 in the "ORed" pattern shown in Table 3-8. These assignments can be changed via the Computer Interface. Each limit (**1** or **2**) for a channel can be assigned to any one digital output.

Table 3-8. Initial Alarm Assignments, Digital I/O Lines 4 Through 7

Digital I/O Line	4	5	6	7
Assigned to Channels	4	5	6	7
	8	9	10	11
	12	13	14	15
	16	17	18	19
	20			

(Appropriate channels are OR'ed to drive each I/O line.)

All Digital I/O lines are set high (non-active) whenever power is cycled. These lines remain high until a new scan detects an alarm condition on an assigned limit or until a new Computer Interface command is received.

Note

Measurements taken with the Monitor function do not affect the digital outputs.

At the completion of a scan, an alarm condition sets the assigned digital output to a logic 0 (low) state. The digital output returns to a logic 1 (high) state when all assigned alarm conditions are cleared. Note that digital outputs for alarms are updated only at the end of each scan. This technique prevents unnecessary toggling of the digital lines during a scan.

Mx+B Scaling

Any analog input channel (0 through 20) can be assigned scaling ("M" and "B") values that are applied to subsequent measurements of that channel. Scaling values can be set via the front panel or over a computer interface.

The "M" value is used as a multiplier of the actual reading; the "B" value is then added in the same units as the resultant. If no scaling values are specified for a channel, the Configuration Reset values of 1 ("M") and 0 ("B") are used, leaving the measurement reading unaltered.

In the Inactive Mode, the "Mx+B" annunciator lights to indicate that an M value other than 1 and/or a B value other than 0 has been specified for the displayed channel. When a measurement is displayed for a channel so configured, no measurement units ("Ω", "V", etc.) are shown.

Note

*If you press **Mx+B** for a channel that is OFF, an error beep will result. Always use **FUNC** to define the channel's measurement function before using **Mx+B** to define the scaling values.*

You can familiarize yourself with the Mx+B setup procedure by pressing **Mx+B**. Then press **ENTER** a few times to cycle through the elements of the scaling values. If only **ENTER** is pressed, no changes are introduced. Note that the scaling value element that can

be changed at any point is brightly lit (solid for digits, flashing for other annunciators); all other elements are dimly lit at this time. Table 3-9 presents a full description of the Mx+B configuration sequence.

If you press **CANCL** while setting the "M" value (anytime prior to showing the "B" value), no changes entered thus far are stored. If you press **CANCL** while setting the "B" value, changes to M are stored and changes to "B" are discarded. In either case, the instrument returns to Inactive Mode.

The final **ENTER** press shown in Table 3-9 stores all changes and returns the instrument to Inactive Mode.

Note

Once Mx+B scaling values are defined for a channel, the instrument uses the range chosen for the B value as the display range for the resulting scaled value. If the result is larger than the display range chosen, an overload ("OL") is displayed.

For example, you could monitor the output of a high-pressure pump by using Mx+B scaling to convert the millivolt output of a pressure transducer to PSI. Such a transducer might output 0 to 30 mV, corresponding to pressure of 0 to 5000 PSI. The scaling values to convert the transducer millivolts to PSI would be M = 166.67 PSI/V and B = 0 PSI, calculated as follows:

$$M = \frac{\text{Max Display Value} - \text{Min Display Value}}{\text{Max Transducer Output} - \text{Min Transducer Output}} = \frac{5000}{30} = 166.67$$

$$B = \text{Min Display Value} - (M * \text{Min Transducer Output}) = 0 - 166.67 * 0 = 0$$

When a channel that has had scaling values entered is scanned or monitored, the resulting scaled value is displayed without the underlying function annunciation. The decimal point location and scale factor for the result is fixed by the "B" value entered. If the scaled value is too small to be represented in 5 digits given this scaling, zero is displayed. If the scaled value is too large, "OL" (overload) is displayed (even if the underlying measurement was on scale.) "OL" is also displayed if the measurement is in overload.

If scanning or monitoring a scaled channel gives unexpected results (like zero or overload), make the following checks:

1. Verify that the values and scale factors of "M" and "B" are set as intended.
2. Verify that the desired values are the correct values: calculate the result for a few measured values using the entered "M" and "B".
3. Temporarily set "M" to 1 and "B" to 0; verify that the measurements are returning values in the expected range. Unexpected measurements could result from a wiring error or the wrong range/function being selected.

This number editing technique occurs during Configuration Mode operations whenever you are setting a numeric value. Instances of number editing include the following:

- R0 (RTD) Table 3-6
- Alarms Table 3-7
- Mx+B Scaling Table 3-9
- Scan Interval Time Table 3-10
- Time/Date Table 3-13

Selecting Scan Interval

The scan interval is the period between starts of measurement scans. The resolution of the scan interval is one second; the maximum scan interval is 9 hours: 99 minutes: 99 seconds. The format of the scan interval is x:xx:xx; 1:30:45 translates to 1 hour, 30 minutes and 45 seconds.

If scan interval of "0:00:00" is specified, continuous scanning will occur when the Scan function is activated. If more than a few seconds are required to scan all defined channels, a short scan interval (a few seconds) effectively becomes continuous scanning.

If the Monitor function is turned on when the instrument is continuously scanning, a Monitor channel measurement is still taken between each scan.

Table 3-10 illustrates the button sequence used for setting scan interval. If necessary, refer to "Entering and Changing Numeric Values" for a more detailed description of the number editing technique used here.

Table 3-10. Scan Interval

	Hour	Minute	Second
PRESS	(INTVL)	▶	▶
THESE	▲	▶	▶
BUTTONS:	▼	▶	▶
TO	0:00:00	0:00:00	0:00:00
CHANGE		0	0
THE			0
INDICATED			
DIGIT:			
<p><i>Note: Go backward (from SECOND to MINUTE to HOUR) by pressing ◀.</i></p> <p>Press (ENTER) at any time to accept the displayed scan interval and exit scan interval selection. Press (CANCEL) at any time to exit interval selection without storing any changes.</p>			

Selecting the Measurement Rate

The slow measurement rate provides the highest accuracy and resolution. A fast rate can be selected, but keep in mind that fast rate provides one less digit of resolution than does slow rate. Measurement rate selection is illustrated in Table 3-11.

Table 3-11. Measurement Rate Selection

Press these buttons:	RATE (SHIFT [▶])]	▲ ▼	ENTER
To select from these choices:		SLO FAST	(Completes selection and returns to Inactive Mode)

Triggering

To set the scan triggering type from the front panel, use the procedure shown in Table 3-12.

Table 3-12. Trigger Type Selection

Press these buttons:	TRIGS (SHIFT [▶])]	▲ ▼	ENTER
To select from these choices:		OFF On ALAr	
<p><i>Note: The three trigger types signify:</i></p> <p>"OFF" External triggering is disabled. Scan trigger is controlled by scan interval.</p> <p>"ON" External triggering is enabled. A low input on the rear-panel TR terminal affects scanning as follows:</p> <p>If the instrument is in Inactive Mode, or just the Monitor Function is on, the low input enables scanning. When the signal on the TR terminal returns to high, scanning is disabled.</p> <p>If scanning is already enabled, the external trigger initiates a single scan. If a scan is already in progress, this request is ignored.</p> <p>"ALAr" An alarm condition on the monitor channel automatically triggers a scan. (External triggering is disabled.)</p>			

External Triggering

The external trigger setting offers additional control of scan starts through a separate trigger line on the rear panel. Refer to Chapter 5 for an in-depth discussion of external triggering.

Changing the Temperature Unit

The displayed temperature unit can be degrees Celsius (°C) or Fahrenheit (°F). To switch this setting, start with the instrument powered off, then press and hold (Mx+B) while pressing POWER ON. After the instrument beeps and the new temperature unit is shown in the display, release (Mx+B).

The units setting can also be changed through the Computer Interface with the TEMP_CONFIG command (refer to Chapter 4.)

Setting Date and Time of Day

The instrument features a built-in, battery-maintained clock and calendar. Verify or change the settings using the steps shown in Table 3-13. If necessary, refer to "Entering and Changing Numeric Values" for a more detailed description of the number changing technique used here.

3-13. Date/Time Selection

	Year "YEAR"	Month.Day "Mn.dY"	Hour.Minut e" Hr.nn"
PRESS THESE BUTTONS:	CLOCK ▲ (SHIFT INTVL ▼))	▲ ▼ ENTER ◀ ▶	▲ ▼ ENTER ◀ ▶
TO SELECT FROM THESE CHOICES:	00-99	01-12.01-31	00-23.00-59
<p><i>Note: The last ENTER press completes clock and calendar setting and returns the instrument to Inactive Mode.</i></p> <p><i>Pressing CANCL during this sequence also returns the instrument to Inactive Mode; all entries to this point are discarded, and the clock/calendar settings are left unchanged.</i></p>			

Measurement Connections

⚠ Warning

To avoid electric shock:

- **When the input module is installed, consider all channels with connections as accessible terminals that may be hazardous live.**
- **Disconnect the input module before touching or changing external wiring.**
- **Remove inputs from live voltages before opening the input module.**

DC Volts, AC Volts, Frequency, and Thermocouples

Any analog input channel (0 through 20) can be used to measure dc volts, ac volts, or frequency. For channel 0, use the two terminals on the front panel. For channels 1 through 20, use the H (high) and L (low) inputs on the rear panel Input Module.

Note

The terminals for channel 0 on the front panel do not support thermocouple measurements.

Front panel channel 0 and Input Module channels 1 and 11 accept a maximum input of 300V dc or ac rms. All other channels (2 through 10 and 12 through 20) accept a maximum of 150V dc or ac rms.

Use the following procedure for connections to the Input Module:

1. Remove the Input Module from the rear panel.
2. Loosen the two large screws on top and open the module.
3. Connect wires to H (high) and L (low) terminals for each channel.
4. Thread these wires through the strain-relief pins and out the back of the module. Refer to Figure 3-2.
5. Close the module cover, secure the screws, and put the module back in the instrument.

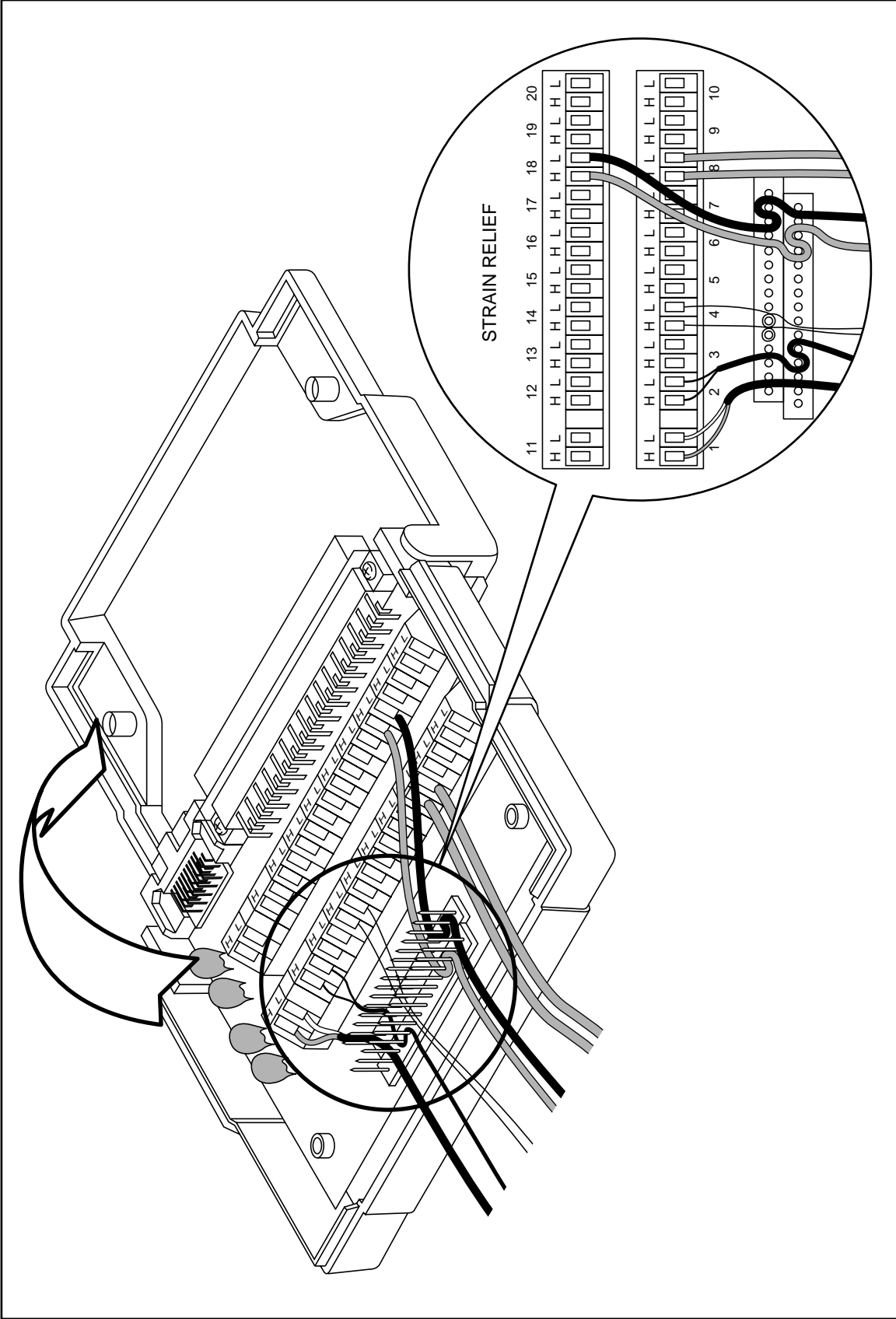

Figure 3-2. Input Module Connections

oo08f.eps

Resistance and RTD

For all channels (0 through 20), 2-terminal resistance or RTD measurements are allowed. Four-terminal measurements can be made on channels 1 through 10 only. Refer to Figure 3-3.

For each channel configured for 4-terminal measurements (channels 1-10 only), a second channel (numbered 10 higher than the first) becomes unavailable for any other type of measurement. For example, using channel 7 to make 4-terminal resistance measurements requires the use of input terminals for both channels 7 and 17. Channel 17 cannot be used to take any other measurements as long as channel 7 remains configured for 4-terminal measurements.

Table 3-14. Thermocouple Ranges

Positive Lead		Positive Lead Color		Negative Lead*	Usable Range (°C)
Type	Material	(ANSI)	(IEC)	Material	
J	Iron	WHITE	BLACK	Constantan	-210 to 760
K	Chromel	YELLPW	GREEN	Alumel	-270 to 1372
E	Chromel	PURPLE	VIOLET	Constantan	-270 to 1000
T	Copper	BLUE	BROWN	Constantan	-270 to 400
N	NISIL- NOCROSIL				-270 to 1300
R	Platinum	BLACK	ORANGE	Platinum (13% Rhodium)	0 to 1767
S	Platinum	BLACK	ORANGE	Platinum (10% Rhodium)	0 to 1767
B	Platinum (30% Rhodium)	GRAY		Platinum (6% Rhodium)	0 to 1820
C**	Tungsten	WHITE		Tungsten (26% Rhenium)	0 to 2316

* ANSI negative lead always RED, IEC negative lead always WHITE
 ** Hoskins Engineering Co.

Use the following procedure for resistance or RTD measurement connections to the Input Module:

1. Remove the Input Module from the rear panel.
2. Loosen the two large screws on top and open the module.
3. Connect wires to H (high) and L (low) terminals for each channel (channel 7 for 2-terminal configuration or channels 7 and 17 for 4-terminal configuration, in this example.)
4. Thread these wires through the strain-relief pins and out the back of the module. Refer to Figure 3-2.
5. Close the module cover, secure the screws, and put the module back in the instrument.

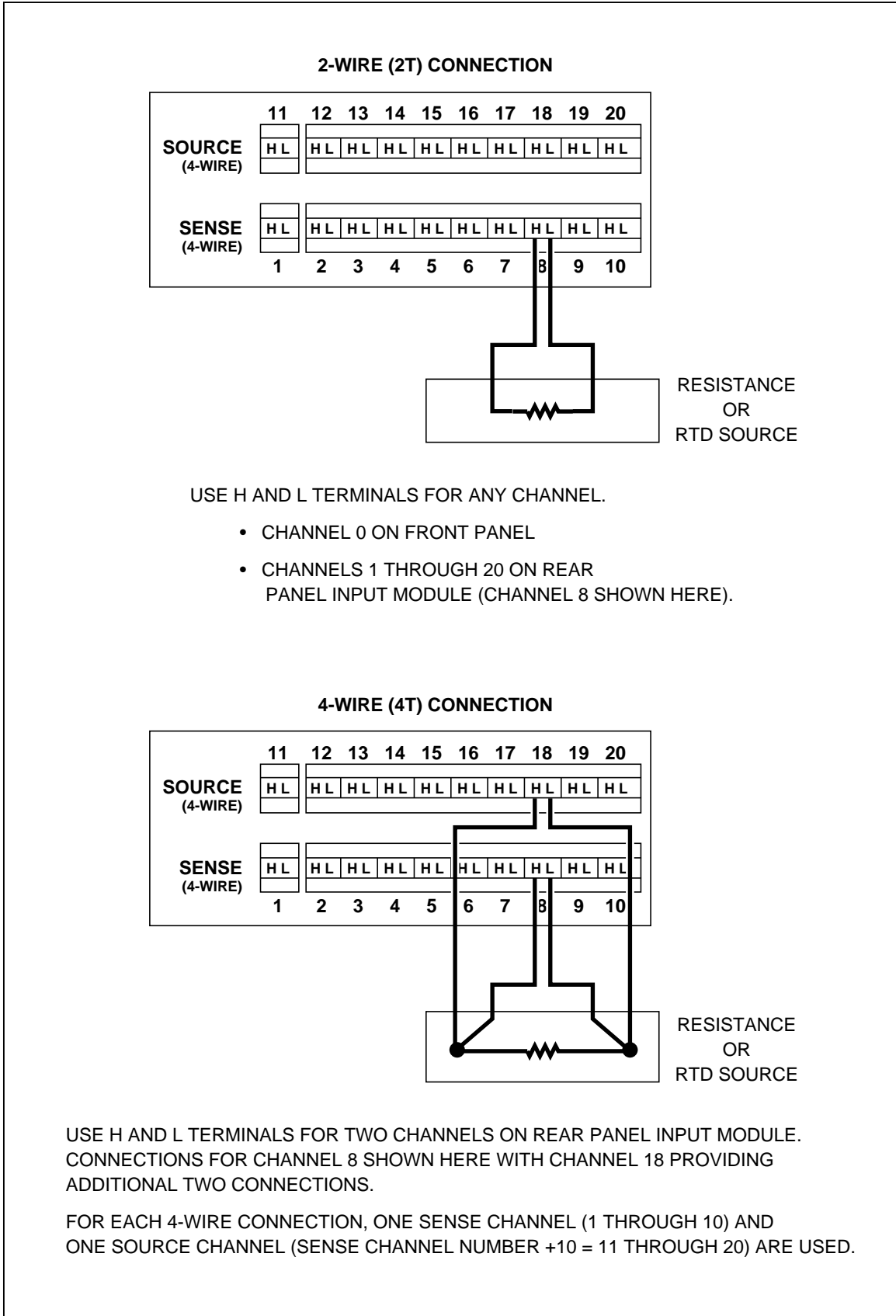

Figure 3-3. 2-Terminal and 4-Terminal Connections

oo09f.eps

Totalizing

General

Event counting (totalizing) is commonly used on production lines for counting items. The instrument counts events by detecting low-to-high voltage transitions; each low-to-high transition increments the totalizer value by one. The maximum count is 65535; "OL" (for "overload") is displayed when the count exceeds this limit.

Connections

The totalizing input is made at the input labeled Σ (sigma) on the rear panel Digital I/O Connector (see Figure 3-4). This input accepts a minimum input of 2.0V pk, which translates to 1.4V rms for a sinewave or 1V rms for a square wave. If the input is a contact-closure type, input debouncing of 300 Hz (1.67 ms) is available. A maximum rate of 5 kHz can be accommodated through the totalizing input, but only if the input debouncing is disabled. Input debounce settings are available only through the computer interface (see Chapter 4.)

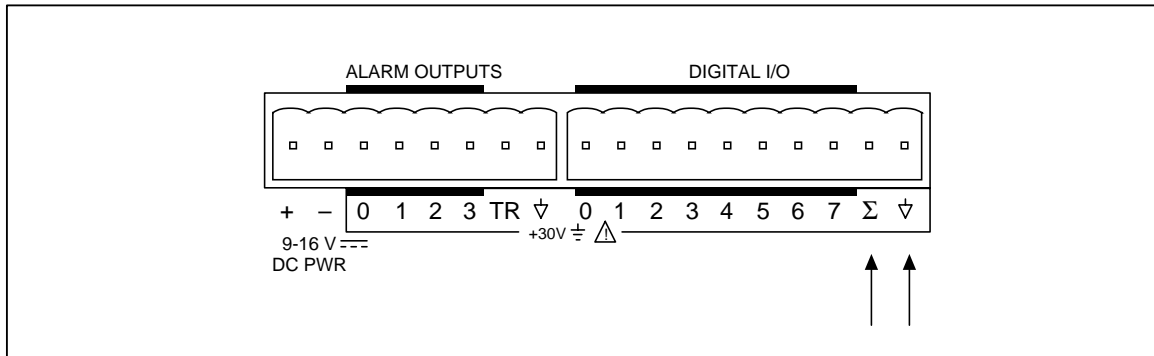

Figure 3-4. Totalizing Connection

oo10f.eps

Review Array

Readings from every scan are checked for minimum and maximum values. These values, along with the last value measured, are stored in the Review array and can be recalled by pressing **REVIEW**. To cycle through the three values for the displayed channel, press **◀** or **▶**. If no value has been stored, or if the value has just been cleared, the display shows dashes ("----").

These values are updated by all scans (scan intervals, continuous scans, single scans, or scans initiated with an external trigger input.) Measurements taken with the Monitor function do not update these values.

Note that either the Review array or the Totalizer count can be displayed at one time; you must deactivate one before activating the other. Press **REVIEW** a second time (or press **CANCL**) to remove Review data from the display.

Table 3-15 illustrates how to examine the Review array contents.

Table 3-15. Review Array

Activate (Note 1)	Review Points	Deactivate (Note 3)
<div style="border: 1px solid black; padding: 2px; display: inline-block; margin-bottom: 5px;">REVIEW</div> <div style="display: flex; justify-content: space-between; align-items: center;"> <div style="text-align: center;"> 20 • • • • </div> <div style="text-align: center;"> 0 </div> </div>	<div style="display: flex; justify-content: space-between; align-items: center; margin-bottom: 5px;"> </div> <div style="display: flex; justify-content: space-around; text-align: center;"> LAST MIN MAX </div> <div style="display: flex; justify-content: space-around; text-align: center; margin-top: 10px;"> LAST MIN MAX </div>	<div style="border: 1px solid black; padding: 2px; display: inline-block; margin-bottom: 5px;">REVIEW</div> or <div style="border: 1px solid black; padding: 2px; display: inline-block;">CANCL</div>
<p><i>Note 1. Review array can be entered only from a channel that is defined for some type of measurement ("VDC", "VAC", etc.) Review array cannot be entered from a channel that is OFF.</i></p> <p><i>Note 2. All review values (MIN, MAX, LAST for all channels) can be cleared (to "-----") by pressing:</i> CLEAR SHIFT REVIEW</p> <p><i>This clearing action can be initiated only while viewing the Review values. Any scan in progress is completed before a requested Review clear is carried out.</i></p> <p><i>Review values are cleared when any channel configuration is changed.</i></p> <p><i>Review values are not cleared automatically at the start of a new scan.</i></p> <p><i>Note 3. When returning to Inactive Mode, the instrument returns to the last channel examined in the Review array. This may not be the same channel from which you started viewing the Review array.</i></p> <p><i>Note 4. Alarms are shown with the LAST Review values. See Alarm Indications for a description of alarm annunciation.</i></p>		

All review values for all channels are cleared with any of the following actions:

- CLEAR SHIFT REVIEW is selected. This must be done while review data is on the display; otherwise, an error beep results.
- Function or number of terminals for any channel is changed.
- Range or thermocouple/RTD type for any channel is changed.
- The M and/or B scaling value for any channel is changed.
- The RTD R0 value for any channel is changed.
- The temperature unit is changed.
- The measurement rate is changed.

List Button Functions

If the RS-232 interface is active, you can print out the Last values from the Review array (2620A and 2625A) or all values from Data Logger memory (2625A only). This procedure is described in Table 3-16.

In the LAsT printout, channels that are defined as OFF are not included. Following is a sample LAsT printout:

```

07:41:37 02/09/91
CH   LAST VALUE      MAX VALUE      MIN VALUE
1:   097.32 mVDC     098.51 mVDC     096.10 mVDC
2:   0.0973 VDC      0.0985 VDC      0.0961 VDC
3:   00.097 VDC      00.099 VDC      00.096 VDC
4:   000.10 VDC      000.10 VDC      000.10 VDC
5:   OL   mVAC       OL   mVAC       OL   mVAC
6:   OL   VAC        OL   VAC        OL   VAC
7:   05.511 VAC      05.582 VAC      05.414 VAC
8:   005.51 VAC      005.58 VAC      005.41 VAC
9:   OL   OHMS       OL   OHMS       OL   OHMS
10:  OL   kOHMS      OL   kOHMS      OL   kOHMS
11:  08.276 kOHMS    08.374 kOHMS    08.231 kOHMS
12:  008.28 kOHMS    008.37 kOHMS    008.23 kOHMS
13:  0.0083 MOHMS    0.0084 MOHMS    0.0082 MOHMS
14:  00.008 MOHMS    00.008 MOHMS    00.008 MOHMS
15:  OL   HZ        OL   HZ        OL   HZ
16:  9.7193 kHz      9.7239 kHz      9.6771 kHz
17:  09.719 kHz      09.724 kHz      09.677 kHz
18:  009.72 kHz      009.72 kHz      009.68 kHz
19:  0.0097 MHz      0.0097 MHz      0.0097 MHz

```

With the Hydra Series II Data Logger (2625A), a sample Store printout of stored values for three scans would be as follows:





```

07:41:5202/09/91
5: -3.2345 mMX+B12:123.87 kOHMS17:31.268VAC
ALM:15DIO:255TOTAL:0
07:41:5302/09/91
5: -3.2345 mMX+B12:123.87 kOHMS17:31.268VAC
ALM:15DIO:255TOTAL:0
07:41:5402/09/91
5: -3.2345 mMX+B12:123.87 kOHMS17:31.268VAC
ALM:15DIO:255TOTAL:0

```

The Hydra Series II Data Logger can hold 2047 scans, with each scan containing 21 channels of data.

Table 3-16. List Button Operation

	(Note 1)	(Note 2)	(Note 3)
Press these buttons:			
To select from these choices:		 LAsT StorE	
<p><i>Note 1. RS-232 computer interface must be active. If the IEEE-488 interface is active, an error results.</i></p> <p><i>Note 2. "LAsT" prints out all values in the Review array. Review array values are not affected. An error results if Review array data has been cleared.</i></p> <p><i>"StorE" prints out logged scan data from the Hydra Data Logger (2620A) memory. Logged data is not affected. An error results if there is no logged data.</i></p> <p><i>Note 3. Press  to abort a printout while it is occurring.</i></p>			

Autoprint

The front panel setup procedure is summarized in Table 3-17. Begin this procedure by selecting MODE (**SHIFT** **PRINT**). Select the scan data destination ("dESt" in right display) as "Print" (left display). For the Hydra Series II Data Logger, a destination of "both" can also be selected, allowing for simultaneous printing and storage. (For the Hydra Series II Data Acquisition Unit, "Print" is the only possible selection.) Then select the mode ("MOde" in right display) from "ALL", "ALAr", or "trAnS" (left display).

With the Autoprint function defined, press **PRINT** to enable or disable Autoprint. The "PRN" annunciator lights when Autoprint is enabled.

Memory Storage

Memory Storage is only available with the Hydra Series II Data Logger. Initiate the Memory Storage setup by selecting MODE (**SHIFT** **PRINT**).

Now refer to Table 3-17. Select the scan data destination ("dESt" in right display) as "StorE" for memory storage only or "both" for simultaneous storage and printing. Then select the mode ("MOde" in right display) from "ALL", "ALAr", or "trAnS" (left display).

Once the destination and mode have been set, enable Memory Storage by pressing:

PRINT

The "PRN" annunciator lights to indicate that Memory Storage is enabled.

Front panel controls allow you to send memory contents over the RS-232 computer interface to a printer. Retrieval can also be made through the RS-232 computer interface for data storage that has been accomplished either from the front panel or through the computer interface.

Warning

No data will be saved unless the "prn" annunciator is lit on the hydra series ii front panel florescent display.

For memory clearing, refer to Table 3-18. You can clear scan data memory by holding **SHIFT** pressed while momentarily pressing **PRINT** and answering "YES" in the left display as "CLEAR" appears in the right display. The instrument must be in Active or Inactive Mode; you cannot clear memory from Configuration Mode.

The F annunciator is dimly lit when the logging storage is nearly full (more than 1800 scans have been stored). The F annunciator is brightly lit when the logging storage is full (2047 scans). Storing additional scans causes the oldest scans to be overwritten.

Table 3-17. Autoprint/Memory Storage Selection

		Destination ("dEst") (Note 1)		Mode ("MOdE") (Note 2)	
Press these buttons:P	MODE (SHIFT) (PRINT)	▲ ▼	ENTER	▲ ▼	ENTER
To select from these choices:		Print StorE both		ALL ALAR trAnS	
Note 1.	"Print"	Sends data to be printed through the RS-232 interface.			
	"StorE"	Sends data to be stored in memory. (Hydra Data Logger only.)			
	"both"	Sends data to be stored and printed (Hydra Data Logger only.)			
Note 2.	"ALL"	Measurements for all defined channels are printed/stored when a scan occurs.			
	"ALAR"	Measurements for all defined channels are printed/stored when a scan occurs and at least one channel is in alarm.			
	"trAnS"	Measurements for all defined channels are printed/stored when a scan occurs and at least one channel has transitioned into or out of alarm since the last scan.			

Table 3-18. Clearing Memory Storage

To Initiate	To Confirm	To Activate
Hold (SHIFT), and press (PRINT) "CLEAR" appears in right display	"no" to exit without clearing ▲ ▼ "YES" (CANCL) to exit without clearing	ENTER

Front Panel Lock out Conditions

Various methods are available to prevent accidental use of the front panel buttons. These actions can be initiated from either the front panel or the computer interface.

Front Panel Review Only Function

Access the Review Array (press (REVIEW), REVIEW annunciator comes on)

Press (FUNC) and (Mx+B) simultaneously to activate the Review Only function (REM annunciator comes dim).

▶, ◀, ▲, and ▼ can now be used to view the various elements of the Review Array. All other front panel buttons are locked out, yielding a long beep when pressed. Press both (FUNC) and (Mx+B) again to deactivate the Review Only function and return the instrument to normal front panel button operation (regular Review Array display.)

Front Panel Monitor Only Function

First place the instrument in the Monitor Function (press (MON), MON annunciator comes on). Then press (FUNC) and (Mx+B) simultaneously to activate the Monitor Only Function (REM annunciator comes on).

▲ and ▼ can now be used to change the monitored channel. All other front panel buttons are locked out; a long beep results from their use. Press both FUNC and Mx+B again to deactivate the Monitor Only function and return the instrument to normal front panel button operation (regular Monitor Function on.)

Computer Interface-Initiated Lockouts

Front Panel lockout can also be specified over the Computer Interface with the following commands.

- REMS (RS-232 only): four front panel buttons remain active (SCAN, ▲, SHIFT, and POWER).
- RWLS (RS-232 only): only the POWER button remains active.
- LOCK 1 ▶, H, ▲, and ▼ can now be used to view the various elements of the Review Array. All other front panel buttons are locked out, yielding a long beep when pressed. Press both FUNC and Mx+B again to deactivate the Review Only function and return the instrument to normal front panel button operation (regular Review Array display.)
- LOCK 2 ▲ and ◀ can now be used to change the monitored channel. All other front panel buttons are locked out; a long beep results from their use.

Refer to Chapter 4 for additional information on these commands.

REM Annunciator

The front panel REM annunciator identifies the status of both computer interface control and front panel lockout. REM may be lit due to actions taken from the computer interface or the front panel; it can be off, dim, or bright as shown in Table 3-19.

Table 3-19. REM Annunciation

Remote	Lock	REM Annunciation
False	False	Off
False	True	Dim
True	False	Bright
True	True	Dim

Calibration

Refer to Chapter 6 (Maintenance) of this manual for a general discussion of instrument calibration. Refer to the Hydra Series II Service Manual (P/N 688868) for complete calibration procedures.

The CAL ENABLE control point is located in the lower-right corner of the display. When the instrument is correctly calibrated, this control should be covered with a calibration decal; removing the decal voids assurance of correct calibration.

Note

Do not press CAL ENABLE unless you have a copy of the Service Manual and intend to calibrate the instrument. If you have accidentally activated Calibration and wish to exit immediately, press CAL ENABLE (until CAL disappears from the display) or turn power OFF.

Chapter 4

Using the Computer Interface

Title	Page
Introduction	4-3
Front Panel and Computer Interface Operations.....	4-3
Types of Computer Interface	4-3
Using the RS-232 Computer Interface	4-3
Setting Communication Parameters (RS-232)	4-4
Autoprint and Memory Storage (RS-232).....	4-5
Autoprint: Computer Interface Control	4-5
Autoprint: Output Format	4-5
Memory Storage: Computer Interface Control.....	4-6
Memory Retrieval.....	4-6
Memory Full Operation	4-7
Clearing Memory	4-7
Cabling the Instrument to a Host or Printer (RS-232)	4-7
Installation Test.....	4-8
RS-232 Information.....	4-8
Character Echoing	4-8
Character Deletion.....	4-8
Device Clear Using Ctrl C.....	4-8
RS-232 Prompts	4-9
Sample Program Using the RS-232 Computer Interface	4-9
Using the IEEE-488 Interface.....	4-9
IEEE-488 Operating Limitations	4-9
Installing the IEEE-488 Interface.....	4-9
Enabling the IEEE-488 Interface	4-12
Installation Test.....	4-13
General Information (RS-232 and IEEE-488).....	4-13
How the Instrument Processes Input.....	4-13
Input Strings.....	4-14
Input Terminators	4-14
Typical Input Strings	4-14
Sending Numeric Values to the Instrument (RS-232 and IEEE-488)	4-16
Sending Input Strings to the Instrument	4-16
How the Instrument Processes Output.....	4-16
Service Requests (IEEE-488 only) and Status Registers	4-17
Event Status and Event Status Enable Registers	4-19

Status Byte Register.....	4-19
Reading the Status Byte Register	4-20
Service Request Enable Register	4-21
Instrument Event Register	4-21
Computer Interface Command Set	4-22

Introduction

The instrument can be operated from a host via commands sent through the rear panel computer interface. The host can be a terminal, controller, PC, or other computer.

This chapter describes how to set up and operate the instrument via the RS-232 interface (standard with Hydra Series II Data Acquisition Unit and Hydra Series II Data Logger) or the IEEE-488 computer interface (optional with Hydra Series II Data Acquisition Unit only.) The RS-232 interface can also be connected to a serial printer for direct output of data in printed format.

With the IEEE-488 computer interface installed in the Hydra Series II Data Acquisition Unit, the instrument is fully programmable for use on the IEEE Standard 488.1 interface bus (1987). The instrument is also designed in compliance with supplemental IEEE Std. 488.2-1987.

This chapter assumes you are familiar with the basics of data communication, the RS-232 interface, and/or the IEEE-488 bus. For an introduction to the IEEE-488 interface, request Fluke Application Bulletin AB-36, "IEEE Standard 488-1978 Digital Interface for Programmable Instrumentation."

An annotated sample program, illustrating the use of the RS-232 computer interface, is provided at the end of this chapter. Calibration procedures using the computer interface are provided in the Hydra Series II Service Manual (P/N 110731).

Front Panel and Computer Interface Operations

When the instrument is operated from the front panel, it is said to be under front panel control. When the instrument is operated from a host, it is said to be operating under computer interface control.

Most operations that can be performed from the front panel can also be performed over the computer interface. Some operations, like setting communications parameters for the RS-232 interface and selecting the instrument address for IEEE-488 operations, can only be performed from the front panel.

Types of Computer Interface

Only one interface can be selected or used at a time.

The optional IEEE-488 interface is contained on a single printed circuit assembly and can be selected if it is installed in the Hydra Series II Data Acquisition Unit. The IEEE-488 interface cannot be used with the Hydra Series II Data Logger. Of course, the RS-232 interface can be re-selected even if the IEEE-488 interface is installed.

If you are going to use the RS-232 interface, continue reading. If you are going to use the IEEE-488 interface, skip to "USING THE IEEE-488 INTERFACE" later in this chapter.

Note

To determine which computer interface is enabled, select COMM (**SHIFT**) (**LIST**). If "IEEE" appears on the display, the IEEE-488 interface is enabled. Otherwise, if a baud rate appears, the RS-232 interface is enabled.

Using the RS-232 Computer Interface

The RS-232 interface allows ASCII, asynchronous, serial communication between the instrument and a host, a serial printer, or a terminal.

Setting Communication Parameters (RS-232)

Baud rate ("bAUd"), parity ("PAR"), and echo ("Echo") parameters can be set directly by the user; number of data bits and number of stop bits cannot be set. Refer to Figure 4-1.

For the instrument and host to communicate via the RS-232 interface, the communication parameters of the instrument must match those of the host. RS-232 communication parameters can be set only from the front panel. If the communication parameters of the host and the instrument do not match, proceed as follows to select the appropriate baud rate and parity parameters for the instrument (summarized in Table 4-1):

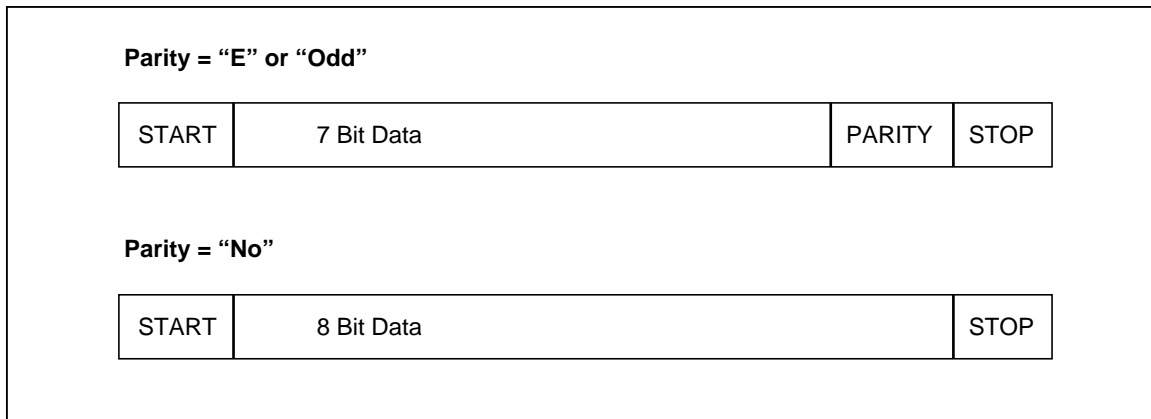

oo11f.eps

Figure 4-1. Data/Stop Bits

Table 4-1. RS-232 Setup

	Baud (Note)		Parity		Echo		
Press these buttons:	COMM (SHIFT LIST)	▲	ENTER	▲	ENTER	▲	ENTER
To select from these choices:		▼		▼		▼	
		IEEE		Odd		OFF	
		300		E		On	
		600		no			
		1200					
		2400					
		4800					
		9600					

Note: If "IEEE" is selected here (2620A only), the RS-232 setup sequence is exited and the IEEE setup sequence is begun. Refer to Table 4-3.

1. Select COMM (SHIFT LIST).
2. The baud rate presently selected is now shown in the left display, and "bAUd" is shown in the right display. If "IEEE" appears, press ▲ until a baud number appears.
3. Press ▲ or ▼ to scroll to the desired baud (9600, 4800, etc., but not "IEEE".) Press ENTER ENTER to select the displayed baud rate.
4. "PAR" appears in the right display. The parity selection ("Odd", "E", or "no") is now shown in the left display.

5. Press **▲** or **▼** to scroll to odd, even, or no parity, respectively. Press **ENTER** **ENTER** to select the displayed parity.
6. "Echo" now appears in the right display, with "On" or "OFF" appearing on the left display.

When Echo is "On", each character sent to the instrument over the RS-232 interface is "echoed" back to the host. If Echo is "OFF", commands are not echoed.

Press **▼** or **▲** to select echo "On" or "OFF". Then press **ENTER** to accept the displayed setting.

Autoprint and Memory Storage (RS-232)

Instrument measurements can be automatically sent to an RS-232 serial printer (Autoprint) or to internal Memory Storage. Both the Hydra Series II Data Acquisition Unit and the Hydra Series II Data Logger have the Autoprint function; only the Hydra Series II Data Logger has internal Memory Storage.

Note

During Autoprint operations, consider setting the instrument echo mode to "OFF". Although Autoprint does operate when echo mode is "on", the "OFF" setting prevents mixing of echoed command characters with autoprinted data.

Autoprint can be controlled from the front panel or over the RS-232 interface. Setting up storage into (and retrieving data from) memory in the Hydra Series II Data Logger can be controlled either from the front panel or over the RS-232 interface. Refer to Chapter 3 for front panel operation. The stored data cannot be viewed from the front panel; data must be requested through the RS-232 computer interface or listed on a printer.

Here are some rules to follow when using Autoprint and Memory Storage:

1. The RS-232 interface must be enabled before Autoprint can be enabled. (RS-232 is always enabled on the Hydra Series II Data Logger.)
2. Since the instrument does not print over the IEEE-488 interface, Autoprint is automatically turned off when you enable the IEEE-488 interface (Hydra Series II Data Acquisition Unit only.)
3. If you have selected Memory Storage (Hydra Series II Data Logger only), verify that the RS-232 interface is configured correctly before you upload the memory contents to a PC or printer.

Autoprint: Computer Interface Control

Autoprint can be controlled from the front panel or over the RS-232 interface. Refer to Chapter 3 for front panel operation.

Through the RS-232 interface, the PRINT_TYPE command can be used to set up Autoprint, and the PRINT command can be used to enable Autoprint. These commands follow a structure paralleling the front panel procedure. PRINT_TYPE selects destination (0 for Print Scans, 1 for Store Scans, or 2 for both) and type (0 for ALL, 1 for ALAr, or 2 for trAnS.) PRINT sets printing on (1) or off (0).

Autoprint: Output Format

The first line of an autoprint printout contains time and date values that identify when the scan was started. Time values include Hour:Minute:Seconds, and date values include Month/Year/Day. As an example, the following line is a valid start-of-scan time:

10:33:45 5/11/90

Lines following the time and date contain measurement data for channels that have been set up for this session. The last line of the printout contains the Totalizer count and the status of the digital I/O lines.

Channel data is formatted to fit three readings onto an 80-column line. Each reading provides the following information:

- Channel number, followed by a colon and a space (4 characters)
- space or minus sign (1 character)
- Digits and decimal point. Measurements taken at the fast rate use 5 characters (4 digits plus a decimal point.) Measurements taken at the slow rate use 6 characters (5 digits plus a decimal point.)
- Space(1 character)
- Measurement multiplier - 'm' for X0.001, space for X1, 'k' for X1,000, 'M' for X1,000,000
- Measurement units - VDC, VAC, OHMS, HZ, C, F, Mx+B (4 characters, left justified)
- Space(1 character)
- Alarm indication for Limit-1 (H=High, L=Low, R=Return) (1 character); a blank space = no alarm limit is used, or alarm inactive.
- Slash (/) used as a separator when either alarm indicator is shown (1 character)
- Alarm indication for Limit-2 (H, L, R); space = no alarm limit is used, or alarm inactive.
- Two spaces between channel measurements (2 characters)
- The following example illustrates this format:

```
07:42:0102/09/91
 5: -3.2345 mMX+B H/R12:123.87 kOHMS/L17:31.268VAC
ALM:15DIO:204TOTAL:0
```

Memory Storage: Computer Interface Control

Memory Storage can be controlled from the front panel or over the RS-232 interface. Refer to Chapter 3 for front panel operation.

Through the RS-232 interface, the PRINT_TYPE and PRINT commands can be used to set up and enable Memory Storage. PRINT_TYPE selects the destination (0 for printer, 1 for Memory Storage, and 2 for both) and the mode used to select the scans to store (0 for ALL, 1 for ALAr, or 2 for trAnS.) PRINT sets storage on (1) or off (0).

The PRINT_TYPE? and PRINT? queries can be used to determine present settings for the PRINT_TYPE (destination, type) and PRINT commands, respectively.

Memory Retrieval

Note

The LOG? query does not return channel numbers with scan data. Therefore, if you add or delete defined channels, you may want to clear the memory contents so that subsequent LOG? queries return only data for the new set of scanned channels.

Data for the oldest set of scan readings in Hydra Series II Data Logger memory can be retrieved with the LOG? query. Each set of scan readings is cleared from memory when read with LOG?. The LOG? query returns the following information:

- Date and time at the start of the logged scan. Date and time are returned as integer values in the same format as used with the TIME_DATE? query (hours 0-23, minutes 0-59, seconds 0-59, month 1-12, day 1-31, year 00-99.)
- Values for the channels measured. This measurement data is returned as a list of values in scientific notation format.
- State of the Digital I/O lines and totalize count at the time the channels were scanned. The state of the digital I/O lines may reflect evaluation of alarms for this set of scan measurements. Alarm outputs and digital I/O values are returned as integer values. The Totalizer value is returned as a scientific notation value.

Data for a specific scan can be retrieved with the LOGGED? <index> query. The <index> parameter can be 1 through 2047, signifying the number of the scan. Scan data is not removed from memory with this query.

The number of stored scans can be retrieved with LOG_COUNT?

Memory Full Operation

If Data Logger memory is full, two methods of handling additional scan data are available. With the LOG_MODE 0 command, older scans are written over by newer scans on a first-in, first-out basis. Therefore, the instrument can continue to make scans until a certain event occurs, and storage of all data leading up to the event is assured.

With the LOG_MODE 1 command, new scans are stored only when memory is available. All data following a specific event (e.g., an alarm) can thereby be saved. Memory can be made available in one of the following two ways:

- LOG? command clears each scan as it is read.
- Memory Clear (Front Panel or LOG_CLR) removes all scans.

The LOG_MODE setting is non-volatile and cannot be changed from the instrument front panel.

Clearing Memory

Memory clearing is available with the Hydra Series II Data Logger (2625A) only. With the RS-232 interface active, use the LOG_CLR command to clear all stored Data Logger memory values. Refer to Chapter 3 for the front panel version of memory clearing.

Cabling the Instrument to a Host or Printer (RS-232)

Communications with a host are handled through a DB-9 interface connector on the rear panel of the instrument. Pin usage is diagramed on the instrument's rear panel and shown in Figure 2-6.

Connect the instrument to the host (or terminal) using a cable appropriate to your application. Usually, total cable length should not exceed 50 feet (15 meters). Longer cables are permitted if the load capacitance measured at the interface point (including the signal terminator) does not exceed 2500 picofarads.

To connect the instrument to an IBM PC/AT (DB-9 connector), use RS40 and RS41 cables connected in series, or use any other cable designed for interconnecting two IBM PC/ATs. The RS40 and RS41 cables are described in Chapter 1.

To connect the instrument to a specific brand of RS-232 printer, use the cable that would be used to connect that printer to an RS-232 port on an IBM PC/AT (DB-9 connector). The RS42 cable is compatible with most serial printers; contact Fluke for printer compatibility information.

Once the cable is connected, turn the instrument back on. You are now ready to operate the instrument over the RS-232 interface.

Installation Test

The procedure below demonstrates the instrument processing a computer interface command and, at the same time, confirms that the instrument has been properly set up and cabled for computer interface operations:

1. Ask for the instrument identification by sending the following query:

```
*IDN? <CR>
```

2. Verify that the instrument sends either of the following responses:

```
FLUKE,2620A,0,Mn.n An.n Dn.n  
=>
```

```
FLUKE,2625A,0,Mn.n An.n Dn.n  
=>
```

Mn.n identifies the main software version.
An.n identifies the A/D software version.
Dn.n identifies the display software version.

The RS-232 prompt => means that the command has been executed and the instrument is ready to accept another command.

RS-232 Information

Character Echoing

With the RS-232 interface, characters sent to the instrument can be automatically echoed back to the host. When Echo is set "On", characters sent to the instrument are echoed back to the host. With Echo "OFF", characters are not echoed back. To set the Echo parameter, refer to the procedure earlier in this chapter under "Setting Communication Parameters (RS-232)".

Character Deletion

Characters sent directly from a host to the instrument can be deleted by pressing the <DELETE> or <BACKSPACE> key. Backspaces are echoed to the host if Echo is "On".

Device Clear Using Ctrl C

CTRL C is the RS-232 equivalent of IEEE-488 DC1 (device clear), causing the output sequence:

```
=> <CR> carriage return <LF> line feed.
```

Use of CTRL C clears the RS-232 input buffer.

RS-232 Prompts

The instrument parses and executes, in turn, each command received from the host over the RS-232 interface. The instrument returns one of the following three response prompts to indicate the results of command execution:

- => No errors; the command was successfully parsed and executed.
- ?> The command was not understood. Used when an IEEE-488.2 Command Error or Query Error was generated by the command.
- !> The command was successfully parsed but could not be executed for some reason. Used when an IEEE-488.2 Execution Error or Device Dependent Error was generated for the command. An example of this would be trying to execute a calibration command when calibration mode is not enabled.

Sample Program Using the RS-232 Computer Interface

Figure 4-2 presents a sample program for controlling the instrument over the RS-232 interface. This program is written in BASIC and is compatible with IBM PC, PC/AT, or equivalent personal computers.

Using the IEEE-488 Interface

IEEE-488 Operating Limitations

The following limitations govern the IEEE-488 interface:

- A maximum of 15 devices can be connected to a single IEEE-488 bus system.
- The maximum length of an IEEE-488 cable used in one IEEE-488 system must be the lesser of 20 meters or 2 meters times the number of devices in the system.

With an IEEE-488 interface installed and active, the instrument (2620A/05 or Hydra Series II with 2620A-05K) supports the IEEE-488 capabilities shown in Table 4-2.

Installing the IEEE-488 Interface

The following instructions pertain to the 2620A/05 Data Acquisition Unit or a Hydra Series II Data Acquisition Unit equipped with a 2620A-05K IEEE-488 kit. A standard IEEE-488 cable attaches to the instrument rear panel. The following cables are available from Fluke: Y8021 (1-meter), Y8022 (2-meter), and Y8023 (4-meter).

Select COMM (**SHIFT** **LIST**) to check the interface setting. If "IEEE" is displayed, the IEEE-488 interface is already installed and selected. If a numeric baud rate appears in the left display, the RS-232 interface is selected; press **▼** so that "IEEE" is displayed, then press **ENTER** **ENTER**, select the address, and press **ENTER** **ENTER** again.

```

10 ' EXAMPLE.BAS  Hydra program to scan VDC, VAC, OHMS, FREQ, or TEMP
20 '           - initialize RS232 communication and set up Hydra
30 '           - display and record measurement data in "TESTDATA.PRN"
40 ' Hydra must be set up for RS232, 9600 baud, no parity (from front panel)
50 KEY OFF
60 ' Open communications port 9600 baud, no parity, 8 bit data,
70 ' ignor Clear to Send, Data Set Ready, Carrier Detect
80 OPEN "COM1:9600,N,8,,cs,ds,cd" FOR RANDOM AS #1
90 IF ERRORCODE <> 0 THEN PRINT "ERROR - Could not open com1:" : END
100 '
110 OPEN "testdata.prn" FOR OUTPUT AS #2      'Open data file
120 IF ERRORCODE <> 0 THEN PRINT "ERROR - Could not open data file" : END
130 '
140 PRINT #1, "ECHO 0"                       'Turn off command echo
150 '
160 NUMBEROFCHANS = 0
170 WHILE (NUMBEROFCHANS < 1) OR (NUMBEROFCHANS > 20)
180   INPUT "Enter number of channels (1-20): ", NUMBEROFCHANS
190 WEND
200 PRINT "(Wait...)"
210 FOR I = (NUMBEROFCHANS + 1) TO 20        ' Turn unused channels off
220   PRINT #1, "FUNC" + STR$(I) + ",OFF"
230   GOSUB 800
240 NEXT I
250 '
260 CLS
270 LOCATE 2,25 : PRINT "Sample Program for Hydra"
275 PRINT #1, "*IDN?" : GOSUB 800 : LINE INPUT #1, RESULT$
276 LOCATE 3,20 : PRINT RESULT$;
280 '
290 WHILE (1)
300 '  Print banner line at bottom of screen
310   LOCATE 25,1
320   PRINT "1 = VDC  2 = VAC  3 = OHMS  4 = FREQ  5 = TEMP  6 = QUIT";
330 '
340   FUNC$ = "0"
350   WHILE (FUNC$ < "1") OR (FUNC$ > "6")
360     LOCATE 23,1 : INPUT "      Selection: ", FUNC$
370   WEND
380 '  Exit and clean up if "Quit"
390   IF FUNC$ = "6" THEN CLOSE 1, 2 : CLS : KEY ON : END
400 '
410 '  Set up later part of command string to Hydra (function and range)
420   IF FUNC$ = "1" THEN CMD$ = "VDC, 1"
430   IF FUNC$ = "2" THEN CMD$ = "VAC, 1"
440   IF FUNC$ = "3" THEN CMD$ = "OHMS, 1, 2"
450   IF FUNC$ = "4" THEN CMD$ = "FREQ, 1"
460   IF FUNC$ = "5" THEN CMD$ = "TEMP, K"
470 '
480 '  Set up Hydra
485   LOCATE 23,1 : PRINT "Programming...  ";
490   FOR I = 1 TO NUMBEROFCHANS             ' Program channels

```

Figure 4-2. Sample Program

```
500     PRINT #1, "FUNC " + STR$(I) + "," + CMD$
510     GOSUB 800
520 NEXT I
530 '
540 LOCATE 23,1
550 PRINT "Measuring " + CMD$ + "          " ' Print to screen
560 '
570 FOR I = 1 TO 3                ' Scan 3 times
580     PRINT #1, "**TRG"          ' Start a single
590     GOSUB 800                ' Get prompt
595     PRINT #1, "SCAN_TIME? : GOSUB 800 ' Get scan time stamp
597     LINE INPUT #1, RESULTS$
598     PRINT #2, RESULTS$        ' save time stamp in data file
600     FOR J = 1 TO NUMBEROFCHANS ' Request scan data
610         PRINT #1, "LAST? " + STR$(J) ' Request channel data
612         GOSUB 800                ' Get prompt
620         INPUT #1, RESULT$        ' Get channel result
640         LOCATE J+3, 25 : PRINT "Chan " + STR$(J) + ": ";
650         PRINT RESULT$           ' Print results to screen
660         PRINT #2, RESULT$ + ","; ' Print results to file
670     NEXT J
680     PRINT #2, ""
690 NEXT I
700 WEND
710 '
720 ' Subroutine: response
730 ' Checks prompt for errors
740 ' The possible command responses are:
750 '     "=> (CR) (LF)" (command successful)
760 '     "?> (CR) (LF)" (command syntax error)
770 '     "!> (CR) (LF)" (Command execution error)
780 '
800 PROMPT$ = INPUT$(4, #1)        ' Get prompt
810 IF INSTR(1, PROMPT$, "=>" <> 0 THEN RETURN ' Command successful
820 IF INSTR(1, PROMPT$, "?>" <> 0 THEN PRINT "Command Syntax Error!!"
830 IF INSTR(1, PROMPT$, "!>" <> 0 THEN PRINT "Command Execution Error!!"
840 PRINT "Program execution halted due to communication errors."
850 END
```

Figure 4-2. Sample Program (cont)

Table 4-2. IEEE-488.1 Capabilities

Capability	Description
SH1 and AH1	Read and write bus handshaking, including hold off.
T5	Basic talker with serial poll and without talk only mode. Serial poll is used to return the instrument status byte to the controller.
TE0	No extended talker.
L4	Basic listener without listen only mode. Listen only mode is only useful for an IEEE-488 device like a printer.
LE0	No extended listener.
SR1	Service request interface; allows SRQs (service requests). The SRQ function allows the instrument to notify the controller when an operation is complete.
RL1	Remote local capability with local lock out. Usually the instrument front panel will not be operational while the instrument is in use by the IEEE-488 interface. Remote local capability enables the front panel. Local lock out disables the front panel.
PP0	No parallel poll capability. Parallel poll is rarely used in the industry. It was intended as a fast way to get a status bit from several devices, but failed in gaining acceptance.
DC1	Device clear capability. This allows the instrument to be initialized to a known state. The IEEE-488.2 standard describes exactly what this known state is.
C0	Not a controller.
E1	Open Collector Outputs

Enabling the IEEE-488 Interface

The IEEE-488 interface can be enabled only from the front panel, using the following procedure. This procedure is also summarized in Table 4-3.

Table 4-3. IEEE-488 Setup

		Baud		Address	
Press these buttons:	COMM (SHIFT LIST)	▲	ENTER	▲	ENTER
To select from these choices:		▼		▼	
		IEEE		0	
		300		1	
		600		•	
		1200		•	
		2400		30	
		4800			
		9600			

1. Select COMM (SHIFT LIST).

The left display shows "IEEE" or an RS-232 baud rate, and "bAUd" appears in the right display. Proceed with the following steps.

If "IEEE" is shown in the left display, the IEEE-488 interface is already enabled.

2. Press **▼** to scroll to "IEEE"; then press **ENTER** to enable the IEEE-488 interface and disable the RS-232 interface. "IEEE" will not appear in the left display if the IEEE-488 interface is not installed.
3. The instrument must now be assigned an address ("0" to "30", inclusive). If you want to make a change, scroll to the desired address with the **▲** and **▼** buttons. Then press **ENTER** to select the displayed address. The address remains selected until it is changed.

Note

*Pressing **CANCL** at any point returns the instrument to the Inactive Mode, leaving the original interface selection unchanged. If RS-232 was active, the instrument returns to RS-232, with all parameters unchanged.*

Installation Test

The procedure below demonstrates how the instrument processes a computer interface command and, at the same time, confirms that the instrument has been properly set up and cabled for IEEE-488 operations:

Note

This is a program as entered from a Fluke 1722A Instrument Controller using Fluke BASIC commands. Syntax may vary with the host computer and language.

Enter the following at the host:

```
INIT PORT 0 <CR>
CLEAR PORT 0 <CR>
PRINT @ <address of instrument>, "*IDN?" <CR>
INPUT LINE @ <address of instrument>, A$ <CR>
PRINT A$ <CR>
```

1. Verify that the instrument sends the following identification response:

```
FLUKE,2620A,0,Mn.n An.n Dn.n
```

Mn.n identifies the main software version.
 An.n identifies the A/D software version.
 Dn.n identifies the display software version.

If the instrument does not respond to the test procedure as indicated, make the following checks:

1. Check all cable connections.
2. Check that the interface has been properly enabled and addressed.

General Information (RS-232 and IEEE-488)

How the Instrument Processes Input

The following paragraphs summarize how the instrument processes input that is received from a host (or stand-alone terminal).

Note

*In this manual "input" means a string sent to the instrument from a host.
 "Output" means a string sent from the instrument to the host.*

Input Strings

The instrument processes and executes valid input strings sent by the host. A valid input string is one or more syntactically correct commands, separated by semicolons (;), followed by an input terminator. ASCII and IEEE-488 bus codes are provided in Appendix B.

The instrument stores received input in a 350-byte input buffer.

Note

Input strings received over the RS-232 interface are not executed or checked for proper syntax until an input terminator is received. If the RS-232 input buffer becomes full, a Device Dependent Error prompt is returned, and the input string is ignored.

The instrument accepts alphabetic characters in either upper- or lower-case. If a command cannot be understood (i.e., the equivalent of an IEEE-488 "Command Error"), the command and the rest of the command line are ignored.

Input Terminators

An input terminator is a character or command (IEEE-488.1), sent by the host, that identifies the end of a string of one or more commands.

When an input terminator is received (RS-232 applications), the instrument executes all commands entered since the last terminator was received, on a first-in, first-out basis. (In IEEE-488 applications, commands are not delayed until receipt of an input terminator; commands are executed as they are received.)

As input characters are processed and commands executed, space is made available in the input buffer for new characters. In RS-232 applications, if a communications error (e.g., parity, framing, overrun) is detected or the input buffer fills, a device-dependent error is generated. If the input buffer is full, new characters are ignored as the instrument waits for a termination character.

If, on the other hand, the input buffer becomes full when the IEEE-488 interface is used, the instrument stops accepting characters until there is room in the buffer. Characters in the input buffer cannot be overwritten with the IEEE-488 interface.

The following are valid terminators for the RS-232 interface:

- LF (Line Feed)
- CR (Carriage Return)
- CR LF
- LF CR

The following are valid terminators for the IEEE-488 interface:

- EOI (End or Identity) on any character
- LF (Line Feed)

In some instances, a terminator is automatically transmitted by the host at the end of the command string (i.e., the instrument's input string). For example, in Fluke BASIC, the PRINT statement finishes with a CR LF pair.

Typical Input Strings

Example strings that could be sent to the instrument over either IEEE-488 interface are shown in Figure 4-3.

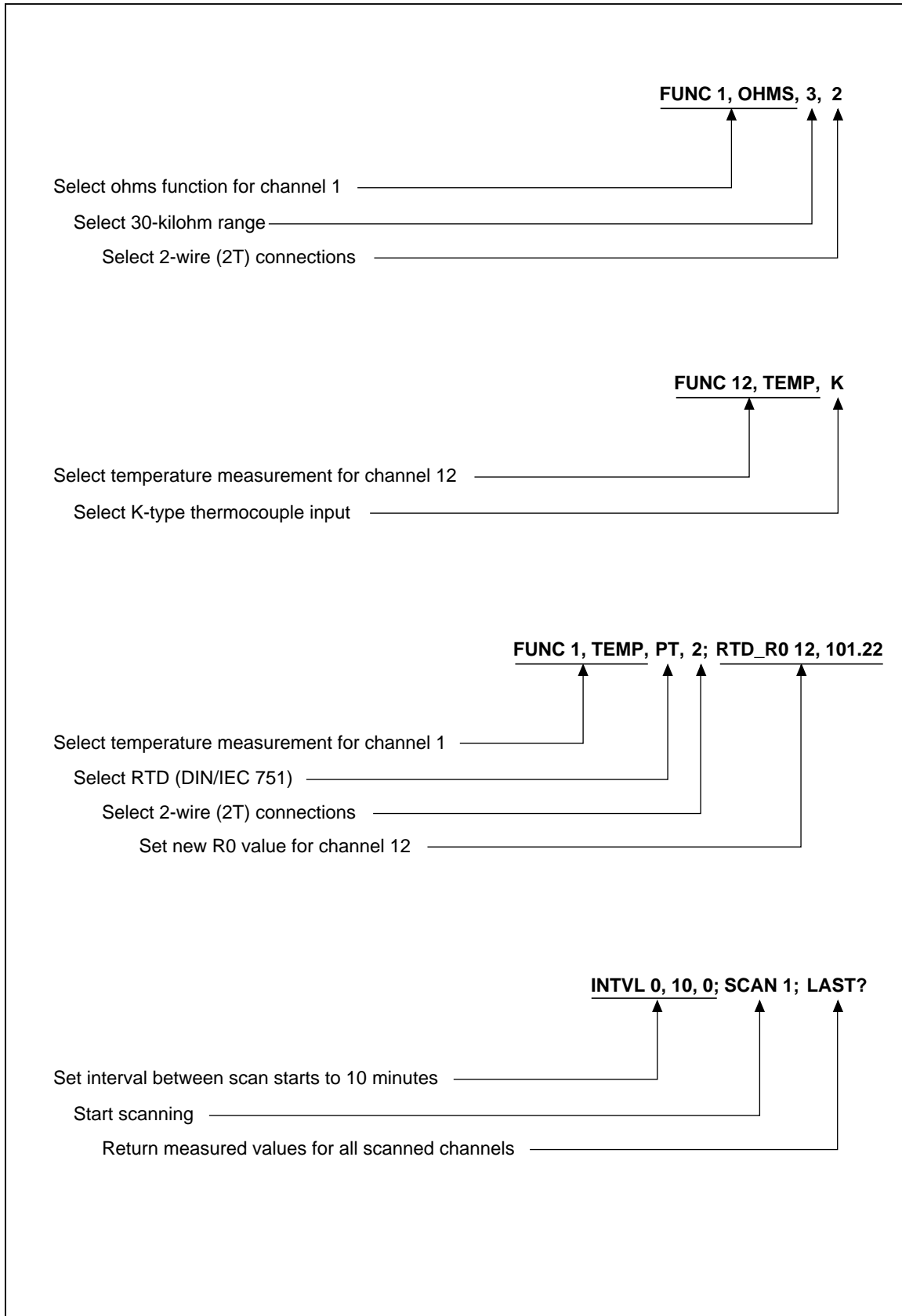

0013f.eps

Figure 4-3. Typical Input Strings

Sending Numeric Values to the Instrument (RS-232 and IEEE-488)

Numeric values can be sent to the instrument as integers, real numbers, or real numbers with exponents, as shown in the following examples:

EXAMPLE	EXPLANATION
+12345	Sends the signed integer "+12345"
123.45	Sends the real number "123.45"
-1.2345E2	Sends -1.2345×10^2

Sending Input Strings to the Instrument

Observe the following rules when you construct strings to be sent to the instrument over the computer interface:

- **RULE 1: READ THE INSTRUMENT'S OUTPUT BUFFER ONLY ONCE FOR EACH QUERY COMMAND.**

This rule applies to the IEEE-488 interface only. The instrument's output buffer is cleared after it has been read. This prevents previously read data from being read a second time by mistake. If you attempt to read the instrument's output buffer twice the instrument generates a query error.

- **RULE 2: READ QUERY RESPONSES BEFORE SENDING ANOTHER INPUT STRING.**

This rule applies to the IEEE-488 interface only. Output data remains available in the output buffer until it is read by the host or until the next input string is received by the instrument. This means the instrument's output buffer must be read by the host before, rather than after, the next input string is sent to the instrument. Otherwise, unread data in the buffer is overwritten.

- **RULE 3: THE INSTRUMENT EXECUTES EACH COMMAND COMPLETELY, IN THE ORDER RECEIVED, BEFORE MOVING ON TO THE NEXT COMMAND.**

If an input string contains a trigger, enter the commands from left to right, as follows:

1. Commands to configure the instrument (if any).
2. The trigger command (*TRG).
3. Queries to read the result of a triggered measurement (LAST?), or to reconfigure the instrument (if any).
4. The terminator.

How the Instrument Processes Output

The instrument outputs an alphanumeric string in response to any query from the host. (Query commands are easily identified because they all end with "?".) An output string is terminated by a Carriage Return and Line Feed (<CR> <LF>) for RS-232 applications or a Line Feed with End or Identity (<LF> <EOI>) for IEEE-488 applications.

After sending the instrument a command string via the RS-232 interface, wait for the instrument to return a prompt before sending another command string. (A command string can consist of 1 or more syntactically correct commands.) If you do not do so, a device-dependent command error is generated, and the second string is discarded.

If the instrument is used in an IEEE-488 bus system, the output data is not actually sent onto the bus until the host addresses the instrument as a talker. When the output buffer is

loaded, the Message Available (MAV) bit in the Status Byte Register is set true. (For more information, see "Status Byte Register" later in this chapter.)

Numeric output from the instrument is returned as shown in the following examples:

- Integer Values Examples
 - 3 In response to RANGE? query, range is 3 for the selected function.
 - 0 In response to ALARMS? query, there are no alarms on this channel.
- Scientific Notation Values
 - +1.2345E+6 Measured value of 1.2345×10^6
 - +12.345E+6 OHM Measured value of 12.345×10^6 ohms (format 2)
 - +1E+9 Positive overload ("OL" appears on the display).
 - 1E+9 Negative overload ("-OL" appears on the display).
 - +9E+9 Open thermocouple indication ("otc" appears on the display).

Service Requests (IEEE-488 only) and Status Registers

Service requests let an instrument on the IEEE-488 bus get the attention of the host. Service requests are sent over the service request (SRQ) line.

Note

If the instrument is in the remote state without front panel lockout (i.e., REMS), a service request can be sent from the front panel by pressing (up button picture).

If more than one instrument on the bus is capable of sending service requests, the host can determine which instrument made the request by taking a "serial poll". Each instrument on the bus responds to the poll by sending the contents of its Status Byte Register (STB). If an instrument on the bus has made a service request, the request service bit (RQS, bit 6) of its Status Byte Register (STB) will be set to 1, identifying it as an instrument that requested service.

The contents of the Status Byte Register (STB) are defined by the Service Request Enable Register (SRE), Event Status Register (ESR), Event Status Enable Register (ESE), and the output buffer. These status registers are discussed in the following paragraphs. Figure 4-4 shows the relationship of these registers.

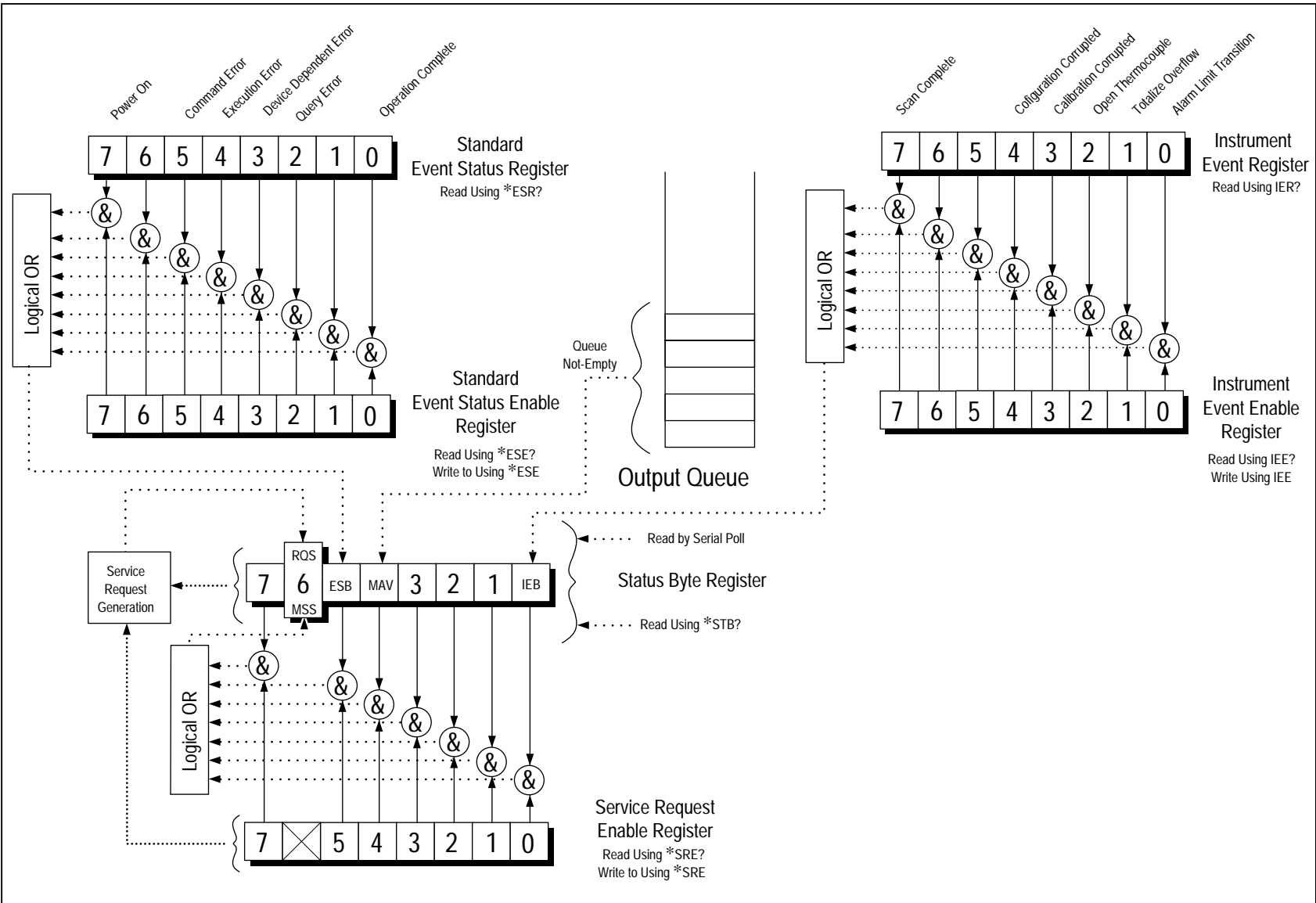

Figure 4-4. Overview of Status Data Registers

00144f.aprs

Table 4-4. Status Byte Register

Bit	Name	Description
0	IEB	Instrument Event Bit. When any bit in the Instrument Event Register is set and the corresponding mask bit(s) in the Instrument Event Enable register is set, this Instrument Event Bit in the Status Byte will be set. When read, the Instrument Event Bit is recomputed based on the new value from the Instrument Event Register and its mask, the Instrument Event Enable Register.
1,2,3	not used	
4	MAV	Message Available
5	ESB	Event Status Bit
6	RQS/MSS	Request Service/Master Summary Status
7	not used	

Event Status and Event Status Enable Registers

The Event Status Register (ESR) records specified events in specific bits. (See Figure 4-4 and Table 4-5). When a bit in the ESR is set (i.e., 1), the event that corresponds to that bit has occurred since the register was last read or cleared. For example, if bit 3 (DDE) is set to 1, a device-dependent error has occurred.

The Event Status Enable Register (ESE) is a mask register that allows the host to enable or disable (mask) each bit in the ESR. When a bit in the ESE is 1, the corresponding bit in the ESR is enabled. When any enabled bit in the ESR changes from 0 to 1, the ESB bit in the Status Byte Register also goes to 1. When the ESR is read (using the *ESR? query) or cleared (using the *CLS command), the ESB bit in the Status Byte Register returns to 0.

Status Byte Register

The Status Byte Register (STB) is a binary-encoded register that contains eight bits. Note that the Service Request Enable Register (SRE) uses bits 1 through 5 and bit 7 to set bit 6, the request service (RQS) bit, as enabled by the SRE. When the RQS bit is set true (1), the instrument sets the SRQ line true (1), which generates a service request. The eight bits of the Status Byte Register (as read by the *STB? query) are described in Table 4-4.

Table 4-5. Event Status Register

Bit	Name	Description
0	OPC	Operation Complete. Set true (1) upon execution of the *OPC command, indicating that the instrument has completed all selected pending operations.
1	not used	Always set to 0.
2	QYE	Query Error. Generated true (1) by the INTERRUPTED or UNTERMINATED message exchange state transitions. (See IEEE-488.2.) Sets the QYE bit of the Event Status Register. Under RS-232, this causes the "?>" prompt to be returned.
3	DDE	Device Dependent Error. Generated true (1) by overflows of the RS-232 input buffer or by calibration errors. Sets the DDE bit of the Event Status Register. Under RS-232, this causes the "!>" prompt to be returned.
4	EXE	Execution Error. Generated true (1) by parameters out of bounds or by a valid command that could not be processed due to an internal condition (such as calibration commands being received when calibration is not enabled). Sets the EXE bit of the Event Status Register. Under RS-232, this causes the "!>" prompt to be returned.
5	CME	Generated true (1) by syntax errors, including: unrecognized command, incorrect command sequences, and GET messages inside a <program message>. Sets the CME bit of the Event Status Register. Under RS-232, this causes the "?>" prompt to be returned.
6	not used	Always set to 0.
7	PON	Always set to 0 Power On. Set true (1) after an off-to-on transition has occurred in the instrument's power supply.

Reading the Status Byte Register

The host can read the Status Byte Register by taking a serial poll or by sending the instrument a *STB? query. The value of the status byte is not affected by the *STB? query.

Note

Changes to the status or enable registers are evaluated immediately. Therefore, an adequate change in cause or enabling criteria will change the status byte.

When the Status Byte Register is read, an integer is returned. This integer is the decimal equivalent of an 8-bit binary number. For example, 48 is the decimal equivalent of the binary 00110000, meaning that bit 4 (MAV) and bit 5 (ESB) are set to "1". Bit 4 contributes integer 16, and bit 5 contributes integer 32.

If the status byte is read by serial poll, bit 6 is returned as a request service (RQS); if it is read with an *STB? query, bit 6 is returned as Master Summary Status (MSS).

EXAMPLE EXPLANATION

*STB? Reads the Status Byte Register. Assume that "32" is returned. Converting 32 to the binary 00100000 indicates that bit 5 (ESB) is set to 1. To determine the event status, you would have to read the Event Status Register in the same manner, using the *ESR? query.

Service Request Enable Register

The Service Request Enable Register (SRE) is an 8-bit register that enables or disables (i.e., masks) corresponding summary messages in the Status Byte Register (STB). The instrument can be programmed to make a service request on errors or when output is available. Conditions that trigger a service request are specified by writing a binary-weighted value to the Service Request Enable Register, using the *SRE command.

EXAMPLE EXPLANATION

*SRE 16 Enables the generation of an SRQ when bit 4 (MAV) in the Status Byte Register (STB) is set to 1.

16 is the decimal equivalent of 00010000 binary. This means that bit 4 in the Service Request Enable Register (SRE, which corresponds to the MAV bit in the Status Byte Register) is 1, and all other bits are 0.

*SRE 48 Enables the generation of an SRQ when bits 4 or 5 (MAV or ESB) in the Status Byte Register are set to 1. The binary equivalent of 48 is 00110000, indicating that bits 4 and 5 are set to 1.

If any bit in the SRE is set to 1 and the matching bit(s) in the STB become 1, the RQS bit (bit 6) in the Status Byte Register (STB) is set and a service request can be generated.

Use the *SRE? query to read the Service Request Enable Register. The instrument returns a binary-weighted integer that represents the enabled bits in the register. (The value of bit 6 will always be zero.) Convert the returned value to binary to determine the status of register bits.

EXAMPLE EXPLANATION

*SRE? Reads the value of the SRE Register. Assume "4" is returned. Converting 4 to the binary 00000100 indicates that bit 2 in the SRE is set to 1.

Instrument Event Register

The Instrument Event Register (IER) is used in conjunction with the Instrument Event Enable Register (IEE) to determine the conditions under which the Instrument Event Bit of the Status Byte Register is set. Bits used in the Instrument Event Register are described in Table 4-6. Whenever the Instrument Event Register is read, the instrument bits are cleared.

Table 4-6. Instrument Event Register (IER)

Note		
Whenever the Instrument Event Register is read, the condition bits are cleared.		
This register is used in conjunction with the Instrument Event Enable Register to determine the conditions under which the Instrument Event Bit of the Status Byte is set.		
Bit	Name	Description
0	ALT	Alarm Limit Transition. Set high (1) when any measurement value has transitioned into or out of alarm. Alarms are defined through the front panel or the computer interface (ALARM_LIMIT). This bit is cleared when alarms or review values are cleared.
1	TOB	Totalize Overflow. Set high (1) when the Totalizer overflows (>65,535). This bit is cleared when the Totalizer is zeroed from the front panel or set to some other non-overflow value (<65,535) with the computer interface TOTAL command.
2	OTC	Open Thermocouple. Set high (1) when open thermocouple checking is enabled and any thermocouple channel is measured with a source impedance greater than 1 to 4 kilohms.
3	CCB	Calibration Corrupted. Set high (1) when the instrument calibration data is corrupted. When a calibration data check shows a corruption of calibration data, the calibration alarm bit remains set in the Instrument Status Register until the instrument is recalibrated.
4	CNC	Configuration Corrupted. The instrument configuration stored in NVRAM has been found to be corrupted. The RAM CRC is no longer valid.
5,6	not used	
7	SCB	Scan Complete. Set high (1) when a measurement scan has been completed.

Computer Interface Command Set

Generally, RS-232 and IEEE-488 commands are identical. A few exceptions apply only when the RS-232 interface is active.

See Table 4-7 for a summary of computer interface commands and queries. A detailed description of each command or query can be found in Table 4-8. (alphabetically arranged.)

Note

Computer interface command descriptions use angle brackets (< >) to denote a parameter that must be supplied by the user or a string that is returned by the instrument.

Table 4-7. Command and Query Summary

Alarms	
ALARMS?	Active Alarms Query
ALARM_ASSOC	Associate Alarm Output
ALARM_ASSOC?	Alarm Association Query
ALARM_ASSOC_CLR	Clear Alarm Association
ALARM_DO_LEVEL	Set Alarm Output Level
ALARM_DO_LEVELS?	Alarm Output State Query
ALARM_LIMIT	Set Alarm Limit
ALARM_LIMIT?	Alarm Limit Assignments Query
Digital I/O	
DIO_LEVELS?	Digital I/O State Query
DO_LEVEL	Set Digital Output Level
Function and Range	
FUNC	Channel Function Definition
FUNC?	Channel Function Query
RTD_R0	RTD Ice Point (R0)
RTD_R0?	RTD Ice-Point (R0) Query
RANGE?	Channel Range Query
IEEE Common Commands (includes Status Registers)	
*CLS	Clear Status
*ESE	Event Status Enable
*ESE?	Event Status Enable Query
*ESR?	Event Status Register Query
*IDN?	Identification Query
*OPC	Operation Complete
*OPC?	Operation Complete Query
*RST	Reset
*SRE	Service Request Enable
*SRE?	Service Request Enable Query
*STB?	Read Status Byte Query
*TRG	Trigger
*TST?	Self Test Query
*WAI	Wait-to-continue
IEE	Instrument Event Enable
IEE?	Instrument Event Enable Query
IER?	Instrument Event Register Query

Table 4-7. Command and Query Summary (cont)

Lock	
LOCK	Lock/unlock front panel control keys
LOCK?	Returns instrument front panel lock status
Measurement Rate	
RATE	Select Measurement Rate
RATE?	Measurement Rate Query
Measurement Values	
LAST?	Channel's Last Scan Value
MAX?	Channel's Maximum Value
MIN?	Channel's Minimum Value
NEXT?	Next Scan's Values
Monitor	
MON	Enable/Disable Monitoring
MON_CHAN?	Monitor Channel Number
MON_VAL?	Monitor Channel Value
Mx+B Scaling	
SCALE_MB	Set Mx+B Scaling Values
SCALE_MB?	Mx+B Scaling Values Query
RS-232 Commands (includes Autoprint)	
LOG?	Retrieve Logged Data Query
LOG_CLR	Clear Logged Scans
LOG_COUNT?	Logged Scan Count Query
LOG_MODE	Action when Internal Memory is Full
LOG_MODE?	Action when Internal Memory is Full Query
LOGGED?	Retrieve Scanned Data Query
LOG_BIN?	Binary Upload of Logged Data
PRINT	Data Logging Enable/Disable
PRINT?	Data Logging Query
PRINT_TYPE	Set Data Logging Type
PRINT_TYPE?	Data Logging Type Query
LOCS	Local without Lockout
LWLS	Local with Lockout
REMS	Remote without Lockout
RWLS	Remote with Lockout
ECHO	Enable/disable echoing

Table 4-7. Command and Query Summary (cont)

Response Format	
FORMAT	Response Format
FORMAT?	Query Response Format
Review Array	
REVIEW_CLR	Clear Review Values
Scan	
INTVL	Set Scan Interval
INTVL?	Scan Interval Query
SCAN	Enable/Disable Scanning
SCAN?	Return Scan Status
SCAN_TIME?	Time of Scan
Temperature Unit	
TEMP_CONFIG	Temperature Configuration
TEMP_CONFIG?	Temperature Configuration Query
Time/Date	
DATE	Set Date
TIME	Set the instrument clock.
TIME_DATE?	Retrieve Time and Date
Totalizer	
TOTAL	Set Totalizer Count
TOTAL?	Totalizer Value Query
TOTAL_DBNC	Set Totalizing Debounce
TOTAL_DBNC?	Totalizer Debounce Query
Triggering	
TRIGGER	Select Trigger Type
TRIGGER?	Trigger Type Query

Table 4-8. Command and Query Reference

*CLS	<p>Clear Status</p> <p>Clears all event registers summarized in the status byte, except for Message Available, which is cleared only if *CLS is the first message in the queue.</p>										
*ESE	<p>Event Status Enable</p> <p>Sets the Event Status Enable Register to the given value.</p> <p>*ESE <value> <value> = (0 .. 255)</p> <p>This is a mask for the Event Status Register and is the first step in determining which Events may issue an SRQ. The mask selects which events may set the Instrument Event Bit of the Status Byte. If the value is not in the range 0 to 255, an Execution Error is generated.</p>										
*ESE?	<p>Event Status Enable Query</p> <p>Returns an integer representing the present value of the Event Status Enable Register.</p>										
*ESR?	<p>Event Status Register Query</p> <p>First returns an integer representing the value of the Event Status Register, then clears the register.</p>										
*IDN?	<p>Identification Query</p> <p>Returns the instrument identification code.</p> <p>The identification code consists of four descriptive fields separated by commas. Note that commas are reserved as field separators and cannot be used within the fields.</p> <table border="1"> <thead> <tr> <th>FIELD</th> <th>DESCRIPTION</th> </tr> </thead> <tbody> <tr> <td>1</td> <td>Manufacturer's name (FLUKE).</td> </tr> <tr> <td>2</td> <td>Instrument model number (2620A or 2625A).</td> </tr> <tr> <td>3</td> <td>0</td> </tr> <tr> <td>4</td> <td>Firmware revision levels.</td> </tr> </tbody> </table> <p>As an example, for main software version M2.41, display software version D1.3, A/D software version A3.7, the response would be:</p> <p style="text-align: center;">FLUKE,2620A,0,M2.41 A3.7 D1.3</p>	FIELD	DESCRIPTION	1	Manufacturer's name (FLUKE).	2	Instrument model number (2620A or 2625A).	3	0	4	Firmware revision levels.
FIELD	DESCRIPTION										
1	Manufacturer's name (FLUKE).										
2	Instrument model number (2620A or 2625A).										
3	0										
4	Firmware revision levels.										
*OPC	<p>Operation Complete</p> <p>Causes the instrument to generate an Operation Complete when parsed.</p>										
*OPC?	<p>Operation Complete Query</p> <p>Causes the instrument to place an ASCII 1 in the output queue when parsed.</p>										
*RST	<p>Reset</p> <p>Performs a Configuration Reset (equals front panel power-up CANCEL. The computer interface parameters (RS-232 and IEEE-488) are not changed. Also, the Status Byte and Event Status Registers are not changed, and calibration data is retained.</p>										

Table 4-8. Command and Query Reference (cont)

*SRE	<p>Service Request Enable</p> <p>Sets the Service Request Enable Register to the given value.</p> <p>*SRE <value> <value> = (0 .. 255)</p> <p>If the value is greater than 255, a Command Error is generated. The value of bit 6 is ignored, since it is not used by the Service Request Enable Register.</p>																																										
*SRE?	<p>Service Request Enable Query</p> <p>Returns the integer value of the Service Request Enable Register, with bit 6 set to 0.</p>																																										
*STB?	<p>Read Status Byte Query</p> <p>Returns the integer value of the Status Byte, with bit 6 as the master summary bit. Note that a serial poll returns bit 6 as the RQS message.</p>																																										
*TRG	<p>Trigger</p> <p>When parsed, this command causes the instrument to request a Single Scan. If a scan is already in progress when this command is parsed, an additional scan is not executed.</p>																																										
*TST?	<p>Self Test Query</p> <p>Causes an internal self test to be run, returning the result as an integer (representing the binary encoded value.) The self test does not require any local operator interaction and returns the instrument to the power-up state. The binary coding is:</p> <table style="margin-left: 40px; border: none;"> <thead> <tr> <th style="text-align: left;">Bit</th> <th style="text-align: left;">Binary Value</th> <th style="text-align: left;">Error</th> </tr> </thead> <tbody> <tr><td>0</td><td>1</td><td>ROM test failed (bad CRS)</td></tr> <tr><td>1</td><td>2</td><td>External RAM test failed</td></tr> <tr><td>2</td><td>4</td><td>Internal RAM test failed</td></tr> <tr><td>3</td><td>8</td><td>Display selft test failed</td></tr> <tr><td>4</td><td>16</td><td>Display bad or not installed</td></tr> <tr><td>5</td><td>32</td><td>Instrument configuration corrupted.</td></tr> <tr><td>6</td><td>64</td><td>EEPROM instrument configuration bad</td></tr> <tr><td>7</td><td>128</td><td>EEPROM calibration data bad</td></tr> <tr><td>8</td><td>256</td><td>A/D bad or not installed</td></tr> <tr><td>9</td><td>512</td><td>A/D ROM test failed</td></tr> <tr><td>10</td><td>1024</td><td>A/D RAM test failed</td></tr> <tr><td>11</td><td>2048</td><td>A/D self test failed</td></tr> <tr><td>12</td><td>4096</td><td>Memory RAM test failed (2625A only).</td></tr> </tbody> </table>	Bit	Binary Value	Error	0	1	ROM test failed (bad CRS)	1	2	External RAM test failed	2	4	Internal RAM test failed	3	8	Display selft test failed	4	16	Display bad or not installed	5	32	Instrument configuration corrupted.	6	64	EEPROM instrument configuration bad	7	128	EEPROM calibration data bad	8	256	A/D bad or not installed	9	512	A/D ROM test failed	10	1024	A/D RAM test failed	11	2048	A/D self test failed	12	4096	Memory RAM test failed (2625A only).
Bit	Binary Value	Error																																									
0	1	ROM test failed (bad CRS)																																									
1	2	External RAM test failed																																									
2	4	Internal RAM test failed																																									
3	8	Display selft test failed																																									
4	16	Display bad or not installed																																									
5	32	Instrument configuration corrupted.																																									
6	64	EEPROM instrument configuration bad																																									
7	128	EEPROM calibration data bad																																									
8	256	A/D bad or not installed																																									
9	512	A/D ROM test failed																																									
10	1024	A/D RAM test failed																																									
11	2048	A/D self test failed																																									
12	4096	Memory RAM test failed (2625A only).																																									
*WAI	<p>Wait-to-continue</p> <p>This command is accepted by Hydra, but has no effect. *WAI is required by the IEEE-488.2 standard, but is non-operational in Hydra.</p>																																										

Table 4-8. Command and Query Reference (cont)

ALARMS?	<p>Active Alarms Query</p> <p>Returns alarm status for the indicated channel(s). The value returned represents data from the most recent scan. The most recent scan is the scan in progress or, if scanning is not in progress, the last completed scan.</p> <p>ALARMS? <channel> <channel> = (0 .. 20)</p> <p>If the channel specification field is left blank, values for all defined channels are returned (values for channels defined as OFF are not included.) An Execution Error results if a request is made for a channel defined as OFF, the channel specified is invalid, no scan measurements have been made, or review values have been cleared.</p> <p>Data is returned as comma-separated integer values, indicating which limits were in alarm when last scanned. The returned values are interpreted as follows:</p> <ul style="list-style-type: none">0 neither limit is in alarm and/or alarm(s) not defined1 Limit "1" in alarm2 Limit "2" in alarm3 Limit "1" and Limit "2" in alarm <p>If measurements are not active, the last known value is returned. The value 0 is returned for measured channels that do not have alarms defined.</p> <p>For alarm status of all defined channels (no channel specification made), undefined (OFF) channels are not included. For each defined channel, an integer value (0, 1, 2, or 3) is returned. Commas separate integers for different channels, and no blank spaces are included. For example, if channel 1 has no alarm, channel 12 has Limit "2" in alarm, channel 13 has Limit "1" and Limit "2" in alarm, and channel 14 has Limit "1" in alarm, the return is "0,2,3,1".</p>
ALARM_ASSOC	<p>Associate Alarm Output</p> <p>For the indicated channel and alarm limit, associate the given digital output line.</p> <p>ALARM_ASSOC <channel>,<limit_num>,<DO_line></p> <p><channel> = (4 .. 20) <limit_num> = 1 2 <DO_line> = (0 .. 7)</p> <p>Any other values or use of an invalid channel cause an Execution Error to be generated. If an association already exists for the specified channel and limit, executing this command revises the association. When switching alarm associations, the output being left (switched away from) is set to a high (non-alarm) state. To set multiple channels to a single DO_line, issue this command for each association to be made.</p>

Table 4-8. Command and Query Reference (cont)

<p>ALARM_ASSOC?</p>	<p>Alarm Association Query</p> <p>Returns alarm output associations for the indicated channel and alarm limit.</p> <p>ALARM_ASSOC? <channel>,<limit_num></p> <p><channel> = (4 .. 20) <limit_num> = 1 2</p> <p>Returns the digital output line number associated with the indicated alarm limit. An Execution Error is generated if no output is associated with this alarm limit, if invalid channel numbers are used, or if limits other than 1 or 2 are used.</p>
<p>ALARM_ASSOC_CLR</p>	<p>Clear Alarm Association</p> <p>Clear the digital output association for the indicated channel and alarm limit.</p> <p>ALARM_ASSOC_CLR <channel>,<limit_num></p> <p><channel> = (4 .. 20) <limit_num> = 1 2</p> <p>When the association is cleared, the output pin is left in a high (non-alarm) state. If the alarm limit specified is not 1 or 2, or if the channel is invalid, an Execution Error is generated.</p>
<p>ALARM_DO_LEVEL</p>	<p>Set Alarm Output Level</p> <p>Set or clear the indicated alarm digital output.</p> <p>ALARM_DO_LEVEL <DO_line>,<DO_state></p> <p><DO_line> = (0 .. 3) <DO_state> = 1 (high) 0 (low)</p> <p>Alarm outputs 0-3 correspond to channels 0-3, respectively. If the digital output line requested is not in the range 0 through 3, an Execution Error is generated. If the DO_state specified is not 1 (high) or 0 (low), an Execution Error is generated.</p>
<p>ALARM_DO_LEVELS?</p>	<p>Alarm Output State Query</p> <p>Returns digital output levels for the four alarm digital outputs.</p> <p>Returns an integer value representing the state of each of the digital I/O lines. The low order four bits are the status of the alarm digital outputs; 0 indicates line is low (in alarm), and 1 indicates line is high (not in alarm). These lowest four bits correspond to alarm digital outputs 0 through 3, which are permanently associated to channels 0 through 3, respectively. A value of 15 indicates that all alarm outputs are in the non-alarm (high) state.</p>

Table 4-8. Command and Query Reference (cont)

<p>ALARM_LIMIT</p>	<p>Set Alarm Limit</p> <p>Store alarm limit information for the indicated channel and limit. The fields to be given (in order) are:</p> <p>ALARM_LIMIT <channel>,<limit_num>,<sense>,<value></p> <p><channel> = (0 .. 20) <limit_num> = 1 2 <sense> = HI LO OFF <value> = Signed numeric quantity</p> <p>A Command Error is generated if a value is supplied when the sense is OFF. An Execution Error is generated under any of the following circumstances:</p> <p><value> is outside the range +/-9999.9 Mega (E+6). <channel>, <limit_num>, or <sense> are not specified from the given list. A <channel> that is defined as OFF is specified.</p> <p>Note that old alarm settings for a channel are lost when the function for that channel is changed.</p>
<p>ALARM_LIMIT?</p>	<p>Alarm Limit Assignments Query</p> <p>Return alarm limit data for specified channel and limit.</p> <p>ALARM_LIMIT? <channel>,<limit_num></p> <p><channel> = (0 .. 20) <limit_num> = 1 2</p> <p>Returns HI, LO, or OFF, indicating the sense of that limit. For HI or LO limits, the value is returned in scientific notation format with five digits of resolution. If the channel specified is invalid, or the requested limit is not 1 or 2, an Execution Error is generated.</p> <p>Remember that old alarm settings for a channel are lost when the function for that channel is changed.</p>
<p>DATE</p>	<p>Set Date</p> <p>Set instrument calendar values.</p> <p>DATE <month>,<date>,<year></p> <p><month> = (1 .. 12) <date> = (1 .. 31) <year> = (00 .. 99)</p> <p>Invalid values generate an Execution Error.</p>

Table 4-8. Command and Query Reference (cont)

<p>DIO_LEVELS?</p>	<p>Digital I/O State Query</p> <p>Returns digital input and output levels for the eight configurable digital I/O lines.</p> <p>Returns an integer value representing the actual states of the digital I/O lines. The low-order eight bits are used to indicate the status of each configurable I/O line (0 indicates low; 1 indicates high.) Bits 0 through 7 correspond to I/O lines 0 through 7. The highest possible integer value is 255, indicating that all eight digital I/O lines are set high.</p> <p style="text-align: center;"><i>NOTE</i></p> <p><i>The digital I/O line levels returned by the DIO_LEVELS? query may not match the levels set with the DO_LEVEL command. Lines that were set to 1 (high) may have been externally driven low. The DIO_LEVELS? query causes the actual state of the lines to be read.</i></p>
<p>DO_LEVEL</p>	<p>Set Digital Output Level</p> <p>Set or clear the indicated digital output.</p> <p>DO_LEVEL <DO_line>,<DO_state> <DO_line> = (0 .. 7) <DO_state> = 1 0</p> <p>If the digital output line requested is not in the range 0 through 7, an Execution Error is generated. If the DO_state specified is not 1 (high) or 0 (low), an Execution Error is generated. Low is the active alarm state. At power up, all digital outputs are set high.</p>
<p>ECHO</p>	<p>Enable/Disable RS-232 Echo Mode (RS-232 only)</p> <p>ECHO <1 0></p> <p>1 = Turn RS-232 echoing on. 0 = Turn RS-232 echoing off.</p> <p>If the IEEE-488 interface is selected, use of ECHO results in an execution error.</p>
<p>FORMAT</p>	<p>Response Format</p> <p>Set the output format type.</p> <p>FORMAT <f_type> <f_type> = 1 2</p> <p>The default is 1, which is IEEE-488.2 compatible. Since no measurement units are allowed in IEEE, an alternative (2) is provided. When format 2 is in effect the responses are no longer IEEE-488.2 compatible. The primary use for format 2 is with RS-232, as it provides a means of recording the units with the measurement value. Any parameter other than 1 or 2 causes an Execution Error to be generated. The units strings used are as follows:</p>

Table 4-8. Command and Query Reference (cont)

	<p>MEASUREMENT</p> <p>Scaled "MX+B"</p> <p>Volts DC</p> <p>Volts AC</p> <p>Resistance</p> <p>Frequency</p> <p>Temperature</p> <p>Temperature</p>	<p>UNITS STRING</p> <p>"VDC"</p> <p>"VAC"</p> <p>"OHMS"</p> <p>"Hz"</p> <p>"C"</p> <p>"F"</p>																												
FORMAT?	<p>Query Response Format</p> <p>Returns the format presently in use:</p> <p>The default. IEEE-488.2-compatible. No measurement units are allowed.</p> <p>Responses are RS-232-compatible, allowing a means of recording the units with the measurement value.</p>																													
FUNC	<p>Channel Function Definition</p> <p>Define the measurement function and range for the indicated channel. Attempting to use the FUNC command when measurements are active results in an Execution Error.</p> <p style="text-align: center;"><i>Note</i></p> <p><i>Successful execution of the FUNC command clears any alarm limits and scaling values for this channel. Therefore, you must define a channel's function before setting alarm limits and/or scaling values for that channel. Also, the FUNC command clears all values in the Review array. FUNC <channel>,<OFF></i></p> <p>FUNC <channel>,<VAC VDC FREQ>,<range> FUNC <channel>,<OHMS>,<range>,<terminals> FUNC <channel>,<TEMP>,<thermocouple type> FUNC <channel>,<TEMP>,<PT>,<terminals></p> <p><channel> = (0 .. 20)</p> <p>If the channel number is invalid, an Execution Error is generated.</p> <p><function> = VAC VDC OHMS FREQ TEMP OFF</p> <p>If the function is OFF, any additional supplied parameters generate a Command Error.</p> <p><range> = AUTO (1 .. 6) (Thermocouple/RTD_type)</p> <p>Ranges for VAC, VDC, OHMS, and FREQ are listed in the following table. Enter AUTO to select autoranging. Use of any other values causes an Execution Error.</p> <table border="1"> <thead> <tr> <th>RANGE</th> <th>VOLTAGE</th> <th>OHMS</th> <th>FREQUENCY</th> </tr> </thead> <tbody> <tr> <td>1</td> <td>300 mV</td> <td>300Ω</td> <td>900 Hz</td> </tr> <tr> <td>2</td> <td>3 V</td> <td>3kΩ</td> <td>9 kHz</td> </tr> <tr> <td>3</td> <td>30 V</td> <td>30 kΩ</td> <td>90 kHz</td> </tr> <tr> <td>4</td> <td>150/300 V</td> <td>300 kΩ</td> <td>900 kHz</td> </tr> <tr> <td>5</td> <td>Error</td> <td>3 MΩ</td> <td>1 Mhz</td> </tr> <tr> <td>6</td> <td>Error</td> <td>10 MΩ</td> <td>Error</td> </tr> </tbody> </table>		RANGE	VOLTAGE	OHMS	FREQUENCY	1	300 mV	300Ω	900 Hz	2	3 V	3kΩ	9 kHz	3	30 V	30 kΩ	90 kHz	4	150/300 V	300 kΩ	900 kHz	5	Error	3 MΩ	1 Mhz	6	Error	10 MΩ	Error
RANGE	VOLTAGE	OHMS	FREQUENCY																											
1	300 mV	300Ω	900 Hz																											
2	3 V	3kΩ	9 kHz																											
3	30 V	30 kΩ	90 kHz																											
4	150/300 V	300 kΩ	900 kHz																											
5	Error	3 MΩ	1 Mhz																											
6	Error	10 MΩ	Error																											

Table 4-8. Command and Query Reference (cont)

	<p>For temperature functions, the "range" is a thermocouple type (J, K, E, T, N, R, S, B, C) or DIN/IEC 751 RTD (PT).</p> <p>Use of any other value causes an Execution Error.</p> <p><terminals> = 2 (2-terminal) 4 (4-terminal)</p> <p>Specification of terminals is necessary when the function type is OHMS or when an RTD temperature measurement is being defined. When this field is called for, a value must be supplied, or a Command Error is generated. Defining a 4-terminal channel (1 through 10) automatically sets the additional channel (11 through 20) to OFF.</p> <p>If a value is supplied in this field when it is not necessary, a Command Error is generated. An Execution Error is generated if values other than 2 or 4 are used.</p>
<p>FUNC?</p>	<p>Channel Function Query</p> <p>Return the function for the indicated channel.</p> <p>FUNC? <channel> <channel> = (0 .. 20)</p> <p>If the channel indicated is invalid, an Execution Error is generated. For valid channels, two or three comma-separated data fields are returned. One of the following function definitions is returned in the first data field: TEMP, VAC, VDC, OHMS, FREQ, OFF</p> <p>For a 4-terminal configuration, two channels are used. For the lower channel, the instrument responds to FUNC? with OHMS or TEMP in the first field. For the upper channel (lower channel +10), the instrument responds with OFF in the first field.</p> <p>The second data field indicates the range when a function has been chosen. If the channel is set up to autorange, AUTO is returned. If the function is TEMP, the thermocouple/RTD_type is returned in this field. If the function is OFF, there is no range data returned.</p> <p>If the type is OHMS or RTD-temperature, a third field is included to indicate the number of terminals used. See the Channel Function Definition (FUNC) command for a definition of the data returned for the range and number-of-terminals fields.</p>
<p>IEE</p>	<p>Instrument Event Enable</p> <p>Sets the Instrument Event Enable Register to the given value.</p> <p>IEE <value> <value> = (0 .. 255)</p> <p>This is a mask for the Instrument Event Register and is the first step in determining which conditions may issue an SRQ. The mask selects which conditions may set the Instrument Event Bit of the Status Byte. If the value is not in the range 0 to 255, an Execution Error is generated.</p>

Table 4-8. Command and Query Reference (cont)

IEE?	<p>Instrument Event Enable Query</p> <p>Returns the present value of the Instrument Event Enable Register as an integer.</p>
IER?	<p>Instrument Event Register Query</p> <p>Returns the value of the Instrument Event Register as an integer, then clears all bits.</p>
INTVL	<p>Set Scan Interval</p> <p>Set scan interval time.</p> <p>INTVL <hours>,<minutes>,<seconds></p> <p><hours> = (0 .. 9) <minutes> = (0 .. 99) <seconds> = (0 .. 99)</p> <p>An Execution Error is generated if values outside the specified ranges are used or if measurements are active.</p>
INTVL?	<p>Scan Interval Query</p> <p>Return scan interval time. Returns three values: hours, minutes, and seconds.</p>
LAST?	<p>Channel's Last Scan Value</p> <p>Returns value(s) for channels measured in the most recent scan. The value returned represents data from the most recent scan. The most recent scan is the scan in progress or, if scanning is not in progress, the last completed scan.</p> <p>LAST? <channel> <channel> = (0 .. 20)</p> <p>Returns measurement values for either the indicated channel or all defined channels. If the channel specification field is left blank, values for all defined channels are returned (values for channels defined as OFF are not included.) An Execution Error results if a request is made for a channel defined as OFF, the channel specified is invalid, the channel specified has been set up but not yet measured, or Review array values have been cleared.</p> <p>The response is a signed number with decimal point and exponent. For slow scanning rate, 5 digits are returned (+/-XX.XXXE+/-X); for fast scanning rate, 4 digits are returned (+/-XX.XXE+/-X). The range setting determines placement of the decimal point.</p> <p>For values of all defined channels (no channel specification made), undefined (OFF) channels are not included. For each defined channel, a separate signed number with decimal point and exponent is returned. Commas separate numbers for different channels, and no blank spaces are included.</p>

Table 4-8. Command and Query Reference (cont)

LOCK	<p>Lock the instrument front panel so that only use of the arrow keys and the simultaneous use of FUNC and MX+B are recognized. The following LOCK commands are recognized:</p> <p>Unlock</p> <p>Lock and begin review. If the instrument is not in review, a review is begun (even if there are no defined channels.)</p> <p>Monitor lock. If the instrument is not already in monitor, an Execution Error is generated.</p> <p>The three LOCK states are non-volatile. If power is interrupted, the instrument retains the last LOCK setting.</p>
LOCK?	<p>Retrieve instrument front panel lock status.</p> <p>0, 1, or 2 is returned, identifying the state set with the LOCK command.</p>
LOCS	<p>Local without Lockout (RS-232 only)</p> <p>Enter the IEEE-488.1 local without front panel lockout (LOCS) state. All front panel buttons are enabled, and the REM annunciator is not lit. This is the state assumed by the instrument at power-up reset.</p> <p>If this command is used with the IEEE-488 interface, an Execution Error is generated.</p>
LOG?	<p>Retrieve Logged Data Query (RS-232 only)</p> <p>Return the oldest logged scan values for all configured channels and remove them from storage. This query is valid during scanning. The remaining count of stored scans (LOG_COUNT?) is decremented by 1. Channels defined as OFF are not included. If there are no (more) logged scans or if the instrument is a Hydra Data Acquisition Unit, an Execution Error is generated.</p> <p>The response includes the following information:</p> <p>Date and time at the start of the logged scan.</p> <p>Date and time are returned as integer values. For example, returned values of "20,32,44,5,18,90" signify May 18, 1990 20:32:44.</p> <p>Values for the channels measured.</p> <p>The measurement data is returned as a list of scientific notation values, separated by commas. For example, "+3.4567E-3,-4.9876E+6" are valid measurement values. If the fast measurement rate is used, the values have one less digit of resolution ("+3.457E-3, -4.988E+6").</p> <p>If you are using the RS-232 interface format 2, valid data responses would include: +894.45E+3 OHM,-9.1234E-3 C.</p> <p>State of the Digital I/O lines and totalize count at the end of the scan.</p> <p>Two values are returned. The first is an integer in the range 0 through 15, identifying the four alarm output states. The second is an integer in the range 0 through 255, identifying digital I/O line states.</p>

Table 4-8. Command and Query Reference (cont)

	<p>The Totalizer count is returned as a scientific notation value in the range 0 through 65535 (00.000E+3 through 65.535E+3). If the Totalizer has overflowed, a value of 1E+9 is returned.</p> <p>An Execution Error is generated if this query is used with the IEEE-488 interface.</p> <p>The following example shows the type of data received in response to LOG?. The first line shows time and date. The second line shows measurement values. The third line shows alarm outputs state, DIO state, and totalizer value. Note that the actual response combines all this information on one line; three lines are shown here for presentation clarity.</p> <pre>16,15,30,10,3,90, -034.53E-3,+09.433E+0,+09.433E+0,+09.434E+0,+09.434E+0, 15,255,+00.000E+3</pre>
LOGGED?	<p>Retrieve specified scan data from memory (RS-232 only)</p> <pre>LOGGED? <index> <index> = (1 .. 2047)</pre> <p>Scan data is not removed from memory with this query. Use of <index> values outside the range causes an Execution Error. Use of <index> values within the range and have no data stored will also cause an Execution Error. An Execution Error is generated if the instrument is a Hydra Data Acquisition Unit.</p> <p>Scan data is returned in the same format as for the LOG? query.</p>
LOG_BIN?	<p>Binary Upload of Logged Data (RS-232 only)</p> <p>For quick upload of logged data from a 2625A. See Appendix E. An Execution Error is generated if the instrument is a Hydra Data Acquisition Unit, or <index> is out of range or invalid.</p> <pre>LOG_BIN? <index></pre>
LOG_CLR	<p>Clear Logged Scans (RS-232 only)</p> <p>Clear all stored scan data. An Execution Error is generated if the instrument is a Hydra Data Acquisition Unit.</p>
LOG_COUNT?	<p>Logged Scan Count Query (RS-232 only)</p> <p>Return the number of stored scans. Returns an integer value representing the number of scans presently stored in memory. The maximum value that can be returned is 2047; 0 indicates that there are no stored scans. An Execution Error is generated if the instrument is a Hydra Data Acquisition Unit.</p>

Table 4-8. Command and Query Reference (cont)

LOG_MODE	<p>Determines treatment of new scan data when memory is full (RS-232 only)</p> <p>LOG_MODE <mode></p> <p>0 Wrap around. When memory is full, oldest scans are discarded to make room for new scans. This is the default mode.</p> <p>1 Discard new scans. New scans are stored only when memory becomes available. (See LOG? and LOG_CLR.)</p> <p>The LOG_MODE setting is non-volatile and cannot be changed from the instrument front panel. An Execution Error is generated if the instrument is a Hydra Data Acquisition Unit.</p>
LOG_MODE?	<p>Query treatment of new scan data when memory is full (RS-232 only)</p> <p>0 or 1 is returned, signifying the mode set with the LOG_MODE command. An Execution Error is generated if the instrument is a Hydra Data Acquisition Unit</p>
LWLS	<p>Local with Lockout (RS-232 only)</p> <p>Enter the IEEE-488.1 local with front panel lockout (LWLS) state. All front panel buttons are disabled. The REM annunciator is not lit.</p>
MAX?	<p>Channel's Maximum Value</p> <p>Returns maximum value(s) for channels measured in the most recent scan. The value returned represents data from the most recent scan. The most recent scan is the scan in progress or, if scanning is not in progress, the last completed scan.</p> <p>MAX? <channel> <channel> = (0 .. 20)</p> <p>Leave the channel specification field blank if values for all defined channels are desired. An Execution Error results if a request is made for a channel defined as OFF, the channel specified is invalid, the channel specified has been set up but not yet measured, or Review array values have been cleared. The response is a signed number with decimal point and exponent. For slow scanning rate, 5 digits are returned (+/-XX.XXXE+/-X); for fast scanning rate, 4 digits are returned (+/-XX.XXE+/-X). The range setting determines placement of the decimal point.</p> <p>For maximum values of all defined channels (no channel specification made), undefined (OFF) channels are not included. For each defined channel, a separate signed number with decimal point and exponent is returned. Commas separate numbers for different channels, and no blank spaces are included.</p>

Table 4-8. Command and Query Reference (cont)

<p>MIN?</p>	<p>Channel's Minimum Value</p> <p>Returns minimum value(s) for channels measured in the most recent scan. The value returned represents data from the most recent scan. The most recent scan is the scan in progress or, if scanning is not in progress, the last completed scan.</p> <p>MIN? <channel> <channel> = (0 .. 20)</p> <p>If the channel specification field is left blank, values for all defined channels are returned. Channels defined as OFF are not included. An Execution Error results if a request is made for a channel defined as OFF, the channel specified is invalid, the channel specified has been set up but not yet measured, or Review array values have been cleared.</p> <p>The response is a signed number with decimal point and exponent. For slow scanning rate, 5 digits are returned (+/-XX.XXXE+/-X); for fast scanning rate, 4 digits are returned (+/-XX.XXE+/-X). The range setting determines placement of the decimal point.</p> <p>For minimum values of all defined channels (no channel specification made), undefined (OFF) channels are not included. For each defined channel, a separate signed number with decimal point and exponent is returned. Commas separate numbers for different channels, and no blank spaces are included.</p>
<p>MON</p>	<p>Enable/Disable Monitoring</p> <p>This command performs the same function as MON on the front panel.</p> <p>MON 1,<channel> Enables monitoring of given channel (if monitoring is disabled). Changes monitored channel (if monitoring is already enabled).</p> <p>MON 0 Disables monitoring.</p> <p>The <channel> parameter can be 0 through 20. A command error is generated if no <channel> parameter is given when enabling monitoring. If the channel to be monitored is invalid or defined as OFF, or if values other than 0 or 1 are given, an Execution Error is generated.</p> <p>The MON and SCAN commands work in conjunction with the front panel controls. The Monitor and Scan functions can be enabled or disabled from either the front panel or the computer interface. The most recently specified monitor channel (from front panel or computer interface) becomes the one channel monitored.</p> <p>Front panel SCAN and MON buttons work only when the lockout state is LOCS.</p>
<p>MON_CHAN?</p>	<p>Monitor Channel Number</p> <p>This query asks for the number of the presently defined monitor channel. If monitoring is not active, an Execution Error is generated.</p>
<p>MON_VAL?</p>	<p>Monitor Channel Value</p> <p>This query asks for a measurement on the monitor channel. If monitoring is not active, an Execution Error results.</p>

Table 4-8. Command and Query Reference (cont)

NEXT?	<p>Next Scan's Values</p> <p>The NEXT? query returns data values for the next scan to complete. If a scan is in progress when the NEXT? query is processed, the data values returned are from the scan in progress. If a scan is not presently in progress, the NEXT? query waits for data to become available. When scanning is occurring, use the NEXT? query to return data from each scan.</p> <p>NEXT? returns comma-separated information for the date and time at the start of the next measurement scan, the values for channels measured, the state of the Digital I/O lines, and the totalize count.</p> <p>The time and date are returned in the following order: Hours (0-23), Minutes (0-59), Seconds (0-59), Month (1-12), Date (1-31), Year (0-99)</p> <p>Measurement data is returned as a list of scientific notation values. For an overload (OL), "1E+9" is returned. If an open thermocouple is detected, "9E+9" is returned.</p> <p>Alarm output and digital I/O values are returned as integer values. The Totalizer value is returned as a scientific notation value.</p> <p>Channels defined as OFF are not included. If all channels are defined as OFF, an Execution Error is generated.</p>
PRINT	<p>Data Logging Enable/Disable (RS-232 only)</p> <p>Turn data logging on or off.</p> <p>PRINT <state> <state> = 1 (on) 0 (off)</p> <p>An Execution Error is generated if any other value is used or if this command is used with the IEEE-488 interface.</p>
PRINT?	<p>Data Logging Query (RS-232 only)</p> <p>Return the status of data logging. Returns 0 (OFF) or 1 (ON).</p> <p>An Execution Error is generated if this query is used with the IEEE-488 interface.</p>
PRINT_TYPE	<p>Set Data Logging Type (RS-232 only)</p> <p>Enable internal Memory Storage or Autoprint and set the type of scan data logged.</p> <p>PRINT_TYPE <destination>,<type> <destination> = 0 (PRINT SCANS) 1 (STORE SCANS) 2 (BOTH)</p> <p> <type> = 0 (ALL) 1 (channel in ALARM) 2 (channel had alarm TRANSition)</p> <p>An Execution Error is generated if any other value is used, if this command is used with a 2620A and you attempt to select STORE SCANS or BOTH.</p> <p>The Hydra Data Logger can hold 2047 scans, with each scan containing 21 channels of data. Refer to "List Button Functions" in Section 3 for an example of some printed scans.</p>

Table 4-8. Command and Query Reference (cont)

PRINT_TYPE?	<p>Data Logging Type Query (RS-232 only)</p> <p>Return the Autoprint or internal Memory Storage type and the type of scan data logged. Returns 0 (AUTOPRINT), 1 (STORE), OR 2 (BOTH), and 0 (ALL), 1 (ALARM), or 2 (TRANS). For example, "1,0" could be returned, signifying that all scan data is sent to internal Memory Storage.</p> <p>An Execution Error is generated if this query is used with the IEEE-488 interface.</p>
RANGE?	<p>Channel Range Query</p> <p>Returns the range used for the most recent scan involving this channel. The most recent scan is the scan in progress or, if scanning is not in progress, the last completed scan.</p> <p>This is the range presently in use for channels set up to autorange. Note that measurements on the monitor channel do not affect the response to this command.</p> <p>RANGE? <channel> <channel> = (0 .. 20)</p> <p>If the channel specification field is left blank, values for all defined channels are returned. Channels defined as OFF are not included. An Execution Error results if a request is made for a channel defined as OFF, the channel specified is invalid, or if the channel has been set up but not measured. The range value returned is the measurement range and is not affected by Mx+B scaling. Temperature functions (thermocouple and RTD) have only one range, which is considered fixed (1).</p> <p>For each defined channel, an integer value (1-6) is returned. Commas separate integers for different channels, and no blank spaces are included. For example, if channel 1 last used the 30V range during a scan measurement, channel 11 used the 3 MΩ range, channel 12 used the 900 Hz range, and channel 13 measured a thermocouple, the response is "3,5,1,1". Refer to the FUNC description for range definitions.</p>
RATE	<p>Select Measurement Rate</p> <p>Specify the measurement rate. Successful execution of this command clears all values in the Review array.</p> <p>RATE <rate> <rate> = 0 (slow) 1 (fast)</p> <p>An Execution Error is generated if the argument is not 0 or 1 or if measurements are active.</p>
RATE?	<p>Measurement Rate Query</p> <p>Return measurement rate for the instrument.</p> <p>Returns 0 (SLOW) or 1 (FAST).</p>

Table 4-8. Command and Query Reference (cont)



REMS	<p>Remote without Lockout (RS-232 only)</p> <p>Enter the IEEE-488.1 remote without front panel lockout (REMS) state. The REM annunciator is lit, and only the following three front panel buttons are now active (with special REMS functionality):</p> <p> triggers a single scan.</p> <p> generates a service request.</p> <p> returns the instrument to normal front panel control.</p> <p>If this command is used with the IEEE-488 interface, an Execution Error is generated.</p>
REVIEW_CLR	<p>Clear Review Values</p> <p>Clear all minimum, maximum, and last values (all channels) in the Review array. (It is not possible to selectively clear individual entries in the Review array.) The Review clearing operation is carried out only at the completion of any scan in progress.</p> <p>Clearing the Review array also clears all alarm status.</p>
RTD_R0	<p>RTD Ice Point (R0)</p> <p>For the indicated channel, store the numeric data as RTD R0. Successful execution of this command clears all Review array values (all channels.)</p> <p>RTD_R0 <channel>,<R0></p> <p style="padding-left: 40px;"><channel> = (0 .. 20)</p> <p style="padding-left: 40px;"><R0> 0 <= R0 <= 999.99</p> <p>An Execution Error is generated if the R0 value supplied is not within the indicated range, the channel specified is invalid, the channel is defined as OFF, or measurements are active.</p>
RTD_R0?	<p>RTD Ice-Point (R0) Query</p> <p>Return RTD R0 (ice-point resistance) value for the indicated channel.</p> <p>RTD_R0? <channel></p> <p style="padding-left: 40px;"><channel> = (0 .. 20)</p> <p>If the channel number is invalid, an Execution Error is generated. If a channel is defined OFF, or if no change has been made to R0 for a channel, the value "100.00" is returned.</p>

Table 4-8. Command and Query Reference (cont)

RWLS	<p>Remote with Lockout (RS-232 only)</p> <p>Enter the IEEE-488.1 remote with front panel lockout (RWLS) state. All front panel buttons are disabled, and the REM annunciator is lit.</p> <p>If this command is used with the IEEE-488 interface, an Execution Error is generated.</p>																																																												
SCALE_MB	<p>Set Mx+B Scaling Values</p> <p>Set the M and B scaling values for the indicated channel, and display the results of the Mx+B calculation in the indicated display range. Successful execution of this command clears all values in the Review array (all channels.)</p> <p>SCALE_MB <channel>,<M_value>,<B_value>,<disp_range></p> <p><channel> = (0 .. 20) <M_value> = signed numeric quantity <B_value> = signed numeric quan<disp_range> = (16) <disp_range> = (1 .. 16)</p> <table border="1"> <thead> <tr> <th>CODE</th> <th>DISPLAY</th> <th>MAX OFFSET</th> <th>CODE</th> <th>DISPLAY</th> <th>MAX</th> </tr> <tr> <th>OFFSET</th> <th></th> <th>VALUE</th> <th></th> <th></th> <th>VALUE</th> </tr> </thead> <tbody> <tr> <td>1</td> <td>0.0000 m</td> <td>0.01</td> <td>9</td> <td>0.0000 k</td> <td>1.0E4</td> </tr> <tr> <td>2</td> <td>00.000 m</td> <td>0.1</td> <td>10</td> <td>00.000 k</td> <td>1.0E5</td> </tr> <tr> <td>3</td> <td>000.00 m</td> <td>1.0</td> <td>11</td> <td>000.00 k</td> <td>1.0E6</td> </tr> <tr> <td>4</td> <td>0000.0 m</td> <td>1.0</td> <td>12</td> <td>0000.0 k</td> <td>1.0E6</td> </tr> <tr> <td>5</td> <td>0.0000 x1</td> <td>10.0</td> <td>13</td> <td>0.0000 M</td> <td>1.0E7</td> </tr> <tr> <td>6</td> <td>00.000 x1</td> <td>100.0</td> <td>14</td> <td>00.000 M</td> <td>1.0E8</td> </tr> <tr> <td>7</td> <td>000.00 x1</td> <td>1000.0</td> <td>15</td> <td>000.00 M</td> <td>1.0E9</td> </tr> <tr> <td>8</td> <td>0000.0 x1</td> <td>1000.0</td> <td>16</td> <td>0000.0 M</td> <td>1.0E10</td> </tr> </tbody> </table> <p>When M=1 and B=0, Mx+B scaling is effectively nonexistent. The values for M and B must be in the span +/-9999.9 Mega (E+6).</p> <p>An Execution Error is generated for any of the following:</p> <ul style="list-style-type: none"> Invalid entries for channel number, M or B values, or display range code are used. The range required by the B value is larger than allowed by the display range code. The channel is defined as OFF. Measurements are active. <p>Mx+B scaling values for a channel are automatically reset to 1 (M) and 0 (B) when the function for that channel is changed.</p>	CODE	DISPLAY	MAX OFFSET	CODE	DISPLAY	MAX	OFFSET		VALUE			VALUE	1	0.0000 m	0.01	9	0.0000 k	1.0E4	2	00.000 m	0.1	10	00.000 k	1.0E5	3	000.00 m	1.0	11	000.00 k	1.0E6	4	0000.0 m	1.0	12	0000.0 k	1.0E6	5	0.0000 x1	10.0	13	0.0000 M	1.0E7	6	00.000 x1	100.0	14	00.000 M	1.0E8	7	000.00 x1	1000.0	15	000.00 M	1.0E9	8	0000.0 x1	1000.0	16	0000.0 M	1.0E10
CODE	DISPLAY	MAX OFFSET	CODE	DISPLAY	MAX																																																								
OFFSET		VALUE			VALUE																																																								
1	0.0000 m	0.01	9	0.0000 k	1.0E4																																																								
2	00.000 m	0.1	10	00.000 k	1.0E5																																																								
3	000.00 m	1.0	11	000.00 k	1.0E6																																																								
4	0000.0 m	1.0	12	0000.0 k	1.0E6																																																								
5	0.0000 x1	10.0	13	0.0000 M	1.0E7																																																								
6	00.000 x1	100.0	14	00.000 M	1.0E8																																																								
7	000.00 x1	1000.0	15	000.00 M	1.0E9																																																								
8	0000.0 x1	1000.0	16	0000.0 M	1.0E10																																																								

Table 4-8. Command and Query Reference (cont)

SCALE_MB?	<p>Mx+B Scaling Values Query</p> <p>Return the M and B scaling values for the indicated channel.</p> <p>SCALE_MB? <channel> <channel> = (0 .. 20)</p> <p>If the channel number given is invalid, an Execution Error is generated. Remember that Mx+B scaling values are automatically reset to 1 (M) and 0 (B) when the function for that channel is changed.</p> <p>This command returns three values. The first two are the M and B values for the channel indicated, even when M=1 and B=0 or the function is defined as OFF. These first two values are returned in M and B order and in scientific notation format with five digits of resolution. The third value returned indicates the Mx+B resultant display range.</p>
SCAN	<p>Enable/Disable Scanning</p> <p>This command performs the same function as SCAN on the front panel.</p> <p>SCAN 1 Enable scanning. SCAN 0 Disable scanning (any scan in progress is completed first.)</p> <p>If there are no configured channels (all are defined as OFF) or values other than 0 or 1 are given, an Execution Error is generated.</p> <p>The MON and SCAN commands work in conjunction with the front panel controls. The Monitor and Scan functions can be enabled or disabled from either the front panel or the computer interface. The most recently specified monitor channel (from front panel or computer interface) becomes the one channel monitored.</p> <p>Front panel SCAN and MON buttons work only when the lockout state is LOCS.</p>
SCAN?	<p>Return scan status. If a scan is in progress, a "1" is returned at the end of the scan. (A response delay may occur if SCAN? is sent early in a scan.) This feature allows synchronization for other commands that would not be recognized if received during a scan. For example, SCAN?;*TRG could be used to trigger a new scan after completion of the current scan. Otherwise, a *TRG command sent while a scan is in progress would be discarded. If a scan is not in progress, a "0" is returned immediately.</p>
SCAN_TIME?	<p>Time of Scan</p> <p>Returns values indicating the time and date at start of last scan. Uses the same format and order as the TIME_DATE? query. The data is returned in the following order: Hours (0-23), Minutes (0-59), Seconds (0-59), Month (1-12), Date (1-31), Year (0-99). Setting of time does not include seconds, but retrieval of time does.</p>
TEMP_CONFIG	<p>Temperature Configuration</p> <p>Set temperature configuration using the given value. Successful execution of this command clears all Review array values (all channels.)</p> <p>TEMP_CONFIG <value> <value> = encoded bit fields</p>

Table 4-8. Command and Query Reference (cont)

	<p>Use the lowest two bits of the value given as individual flags to specify the temperature configuration. Therefore, the value given must be in the range from 0 through 3 or an Execution Error is generated. These settings affect every channel; they cannot be set for each channel individually. If this command is attempted when measurements are active, an Execution Error results.</p> <table border="1"> <thead> <tr> <th>Bit Number</th> <th>Value</th> <th>Meaning</th> </tr> </thead> <tbody> <tr> <td rowspan="2">0</td> <td>0</td> <td>°C</td> </tr> <tr> <td>1</td> <td>°F</td> </tr> <tr> <td rowspan="2">1</td> <td>0</td> <td>Disable open thermocouple detection</td> </tr> <tr> <td>1</td> <td>Enable open thermocouple detection</td> </tr> </tbody> </table>	Bit Number	Value	Meaning	0	0	°C	1	°F	1	0	Disable open thermocouple detection	1	Enable open thermocouple detection
Bit Number	Value	Meaning												
0	0	°C												
	1	°F												
1	0	Disable open thermocouple detection												
	1	Enable open thermocouple detection												
TEMP_CONFIG?	<p>Temperature Configuration Query</p> <p>Response to this query corresponds to settings made with the TEMP_CONFIG command, as follows:</p> <table border="1"> <thead> <tr> <th>Bit Number</th> <th>Value</th> <th>Meaning</th> </tr> </thead> <tbody> <tr> <td rowspan="2">0</td> <td>0</td> <td>°C</td> </tr> <tr> <td>1</td> <td>°F</td> </tr> <tr> <td rowspan="2">1</td> <td>0</td> <td>Disable open thermocouple detection</td> </tr> <tr> <td>1</td> <td>Enable open thermocouple detection</td> </tr> </tbody> </table>	Bit Number	Value	Meaning	0	0	°C	1	°F	1	0	Disable open thermocouple detection	1	Enable open thermocouple detection
Bit Number	Value	Meaning												
0	0	°C												
	1	°F												
1	0	Disable open thermocouple detection												
	1	Enable open thermocouple detection												
TIME	<p>Set the instrument clock.</p> <p>TIME <hours>,<minutes></p> <p><hours> = (0 .. 23) (24-hour scale, 18:00 = 6:00 pm). <minutes> = (0 .. 59)</p> <p>Invalid values generate an Execution Error. Seconds are automatically set to 00 with the TIME command.</p>													
TIME_DATE?	<p>Retrieve Time and Date</p> <p>Returns comma-separated integer values for time, date, and year as maintained by the instrument clock. These returned values use the TIME and DATE command integer formats as follows:</p> <table border="1"> <tbody> <tr> <td>hours</td> <td>0-23</td> </tr> <tr> <td>minutes</td> <td>0-59</td> </tr> <tr> <td>seconds</td> <td>0-59</td> </tr> <tr> <td>month</td> <td>1-12</td> </tr> <tr> <td>day</td> <td>1-31</td> </tr> <tr> <td>year</td> <td>00-99</td> </tr> </tbody> </table> <p>Seconds are returned, but cannot be set other than to 00.</p>	hours	0-23	minutes	0-59	seconds	0-59	month	1-12	day	1-31	year	00-99	
hours	0-23													
minutes	0-59													
seconds	0-59													
month	1-12													
day	1-31													
year	00-99													

Table 4-8. Command and Query Reference (cont)

TOTAL	<p>Set Totalizer Count</p> <p>Give the Totalizer count a new initial value.</p> <p>TOTAL <t_value> <t_value> = (0 .. 65535)</p> <p>If the value is not in the range 0 through 65,535, an Execution Error is generated.</p> <p>Clear the Totalizer count by setting the Totalizer to zero (0).</p>
TOTAL?	<p>Totalizer Value Query</p> <p>Returns the value of the present Totalizer count. Format of the value is +00.000E+3. When the Totalizer has overflowed, the value returned is +001.00E+9.</p>
TOTAL_DBNC	<p>Set Totalizing Debounce</p> <p>Set totalizing input debounce state.</p> <p>TOTAL_DBNC <dbnc_state> <dbnc_state> = 1 (on) 0 (off)</p> <p>Use of any other value causes an Execution Error to be generated. At initial power up, totalize debounce is disabled (0).</p>
TOTAL_DBNC?	<p>Totalizer Debounce Query</p> <p>Returns the totalizing input's debounce state as an integer. When disabled, the response is 0, indicating debounce is not in use. When enabled, the response is 1, indicating debounce is being used.</p>
TRIGGER	<p>Select Trigger Type</p> <p>Select the type of scan triggering.</p> <p>TRIGGER <trig_type> <trig_type> = 0 (off) 1 (on) 2 (alarm)</p> <p>Off (0) signifies that external triggering is disabled. Only normal scan interval triggering can be used. If the scan interval is 0, continuous scanning results. On (1) means that external triggering is enabled. An acceptable low input on the External Trigger input (TR terminal on the rear panel) then affects scanning as follows:</p> <p>If the instrument is in Inactive Mode or Monitor Mode, the low input enables scanning. When the TR input returns to high, scanning is disabled.</p> <p>If scanning is already enabled, the external trigger requests a single scan. This request is ignored if a scan is presently in progress.</p> <p>Alarm (2) signifies that an alarm condition on the monitor channel triggers a single scan. When the scan is completed, the Monitor function is resumed. This cycle repeats as long as the alarm condition is encountered on the monitor channel. The external trigger input is disabled. The *TRG and GET commands can still be used.</p> <p>If the type given is not one of the listed values, an Execution Error is generated.</p>

Table 4-8. Command and Query Reference (cont)

TRIGGER?	Trigger Type Query
	Returns an integer representing the present trigger type:
	0 (off)
	1 (on)
	2 (alarm)

Chapter 5

Additional Considerations

Title	Page
Introduction	5-3
Measurement Rate	5-3
Advanced Trigger Mechanisms.....	5-3
Front Panel Trigger Control.....	5-3
Computer Interface Trigger Control	5-3
Both External and Monitor Alarms Disabled (Type 0)	5-4
External Trigger Enabled (Type 1)	5-4
Monitor Alarm Enabled (Type 2)	5-6
Thermal Voltages	5-6
When Measuring Resistance or Temperature (RTD).....	5-6
True RMS Measurements.....	5-8
Effects of Internal Noise in AC Measurements	5-8
Waveform Comparison (True RMS vs Average Responding)	5-8
Making Mixed Measurements	5-9
Using Shielded Wiring	5-11
General Rule	5-11
Alternate Suggestions	5-11
Non-Isolated Sensor Configuration	5-11
Isolated and Shielded Sensor Configuration	5-11
In More Detail.....	5-12

Introduction

Chapter 5 discusses some topics that will help you use the instrument more effectively. These considerations assume that you are familiar with the basic operation of the instrument and have some basic understanding of electronics.

Measurement Rate

The two measurement rates provide a choice of maximum accuracy and noise rejection (slow rate) or maximum throughput (fast rate). The selected rate applies to all channels on the instrument. Therefore, your rate selection will be based on overall consideration of the speed and accuracy you need.

Exact measurement rates vary somewhat by type of measurement. Refer to Appendix A, Specifications for complete measurement rate information.

Advanced Trigger Mechanisms

Normally, the built-in scan interval timer controls when scan measurements are taken. However, two additional mechanisms are available for activating scans:

1. An external trigger signal, connected at the rear panel "TR" input.
2. An alarm condition on the Monitor channel.

Note

These two additional trigger mechanisms are mutually exclusive.

The External Trigger input and Monitor-Alarm trigger can be enabled from the front panel or through computer interface commands

Front Panel Trigger Control

To access the trigger controls from the front panel, select TRIGS (**SHIFT** **MON**). Then press **▲** or **▼** to cycle through the choices for trigger types:

OFF Both External and Monitor-Alarm triggers are disabled.

On The External Trigger input is enabled.

ALAr The Monitor-Alarm trigger is enabled.

Press **ENTER** **ENTER** once you've selected the desired trigger type. Note that internal scan interval triggering is not affected by this selection and remains available.

Computer Interface Trigger Control

Select a scan trigger type over the computer interface by sending the command:

```
TRIGGER<type>
```

where <type> is:

- 0 Both External and Monitor-Alarm triggers are disabled.
- 1 The External Trigger input is enabled.
- 2 The Monitor-Alarm trigger is enabled.

If one of these types is not specified, an Execution Error is generated.

Verify the trigger type over the computer interface by sending the query:

TRIGGER?

Single scans can be triggered via the RS-232 interface or the IEEE-488 interface by sending the *TRG command. Note that the IEEE-488 interface GET command can be used only when the IEEE-488 interface is enabled.

Note

*If the instrument is in the remote state without front panel lockout (i.e., REMS), a *TRG can be generated from the front panel by pressing **SCAN**.*

Both External and Monitor Alarms Disabled (Type 0)

External trigger input is disabled (Front Panel OFF, Computer Interface TRIGGER=0). The *TRG and GET commands can still be used, and only normal scan interval triggering can be used. If the scan interval is 0:00:00, continuous scanning results. Also, a small scan interval (specifying a time less than that required by the instrument to complete a full scan) effectively becomes continuous scanning. The number of channels in the scan and the types of measurement determine the time necessary to complete one scan.

External Trigger Enabled (Type 1)

This corresponds to the Front Panel ON or Computer Interface TRIGGER=1 setting. When External Trigger is enabled, a low signal on the rear panel TR terminal affects scanning as follows:

- If the scan function has already been activated, the trigger signal causes a single set of scan measurements to be taken. This feature is convenient in cases where you want to collect normal scheduled scans, as well as scan measurements in response to some abnormal situation. When the condition arises, a trigger signal can be sent to the instrument, causing it to take an extra set of scan measurements.
- If scan measurements are occurring when the trigger requesting a single scan arrives, this request for another scan is ignored. (This stipulation applies whether the scan in progress was initiated by the scan interval timer, a command over the computer interface, or from a previous external-trigger signal.)
- If the instrument is in Inactive Mode, or just the Monitor function is selected, the low trigger signal enables interval scanning. Scans are executed at the specified scan interval. (If the scan interval is 0, continuous scanning results; a small scan interval time effectively becomes continuous scanning.) When the TR input returns high, interval scanning is disabled. This feature is handy in cases where you want to begin normal scheduled scans after the system under test has reached some particular operating condition. When that condition arises, a trigger signal can be sent to the instrument, causing it to begin interval scanning.
- If the instrument is in Configuration Mode, all external trigger signals are ignored. The instrument must be in Inactive Mode or Active Mode before any external trigger signal will be recognized.

The external trigger accepts a contact closure or logic low signal; the input is non-isolated and TTL compatible. Note that scanning is enabled on the falling edge of the trigger signal. This trigger signal must be held low for a minimum of 5 microseconds; it must also have previously been unasserted (high) for at least 100 milliseconds. Refer to Figure 5-1. Signal level constraints are as follows:

High 2.0V min., 7.0V max.
Low -0.6V min., 0.8V max

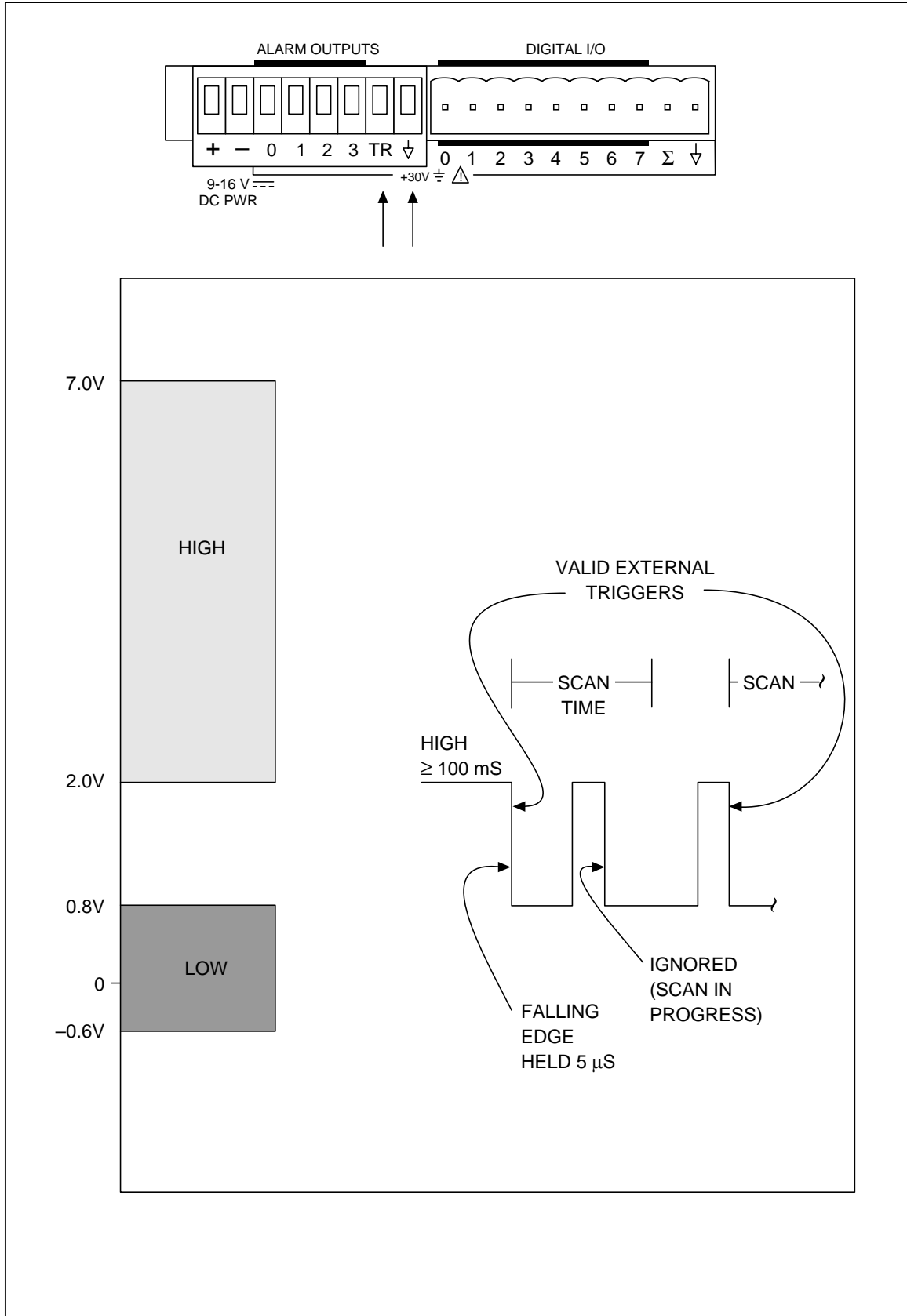

Figure 5-1. External Trigger Timing

oo15f.eps

Monitor Alarm Enabled (Type 2)

This corresponds to the Front Panel ALAr or Computer Interface TRIGGER=2 setting. When the Monitor Alarm trigger is enabled and the Monitor function is on, a scan is triggered if the monitor measurement is found to be in alarm. After this scan occurs, a monitor measurement is again made. If the monitor measurement is still in alarm, another scan is triggered. This pattern continues as long as the monitor channel remains in alarm.

Monitor alarm trigger can be used when interval scanning is enabled. This feature is convenient when you want to take normal scheduled scans and also use the monitor function as a "watchdog" on a particular channel. Whenever an alarm condition arises on that monitored channel, the instrument automatically takes additional scan measurements.

If you change the Monitor function to a different channel while the Monitor-alarm trigger is in use, measurements on the new monitor channel are used to trigger scans when the monitor measurement is in alarm. When monitor and scanning are both enabled, at least one monitor channel measurement is taken after every set of scan measurements - even in the case of continuous scanning.

Thermal Voltages

Thermal voltages are the thermovoltaic potentials that appear at the junction between dissimilar metals. Thermal voltages, which can easily exceed 1 μV , typically arise where wires are attached to binding posts.

With low-level dc voltage and thermocouple temperature measurements, these thermal voltages can be an additional source of measurement error.

Thermal voltages can also cause problems in the low ohms ranges. Some low value resistors are constructed with dissimilar metals. Just handling such resistors can cause thermal voltages large enough to introduce measurement errors.

On Hydra Series II, the rear panel Input Module (channels 1 through 20) contains an isothermal block to minimize thermal voltage errors. The front connector pair (channel 0), which does not attach directly to this block, is more susceptible to thermal voltage errors. Use the following techniques to reduce the effect of thermal voltages:

1. Use similar metals for connections wherever possible (e.g., copper-to-copper, gold-to-gold, etc.).
2. Use tight connections.
3. Use clean connections (especially free of grease and dirt).
4. Use caution when handling the measurement source.
5. Wait for all measurement connections to reach thermal equilibrium. (Thermal voltages are generated only where there is a temperature gradient.)

When Measuring Resistance or Temperature (RTD)

The instrument can measure a resistance with two or four terminal connections. Advantages for each configuration are discussed below:

- **2-Terminal Configuration**
The instrument measures resistance in a 2-terminal configuration using a resistance ratio (sometimes called ratio-ohms) technique. Using only the high (H) and low (L) terminals for one channel, 2-terminal resistance measurements are simple to set up and yield good results for many measurement conditions. However, if lead wire and internal relay resistances are significant in relation to the resistances being measured, the 4-terminal configuration should be used. (Internal relay resistances are noted in Appendix A, Specifications.) A 2-terminal configuration is illustrated in Figure 5-2.
The full-scale voltage for each resistance range is shown in Table 5-1. The $V\Omega$ (or H) input test lead is positive with respect to the COM (or L) lead.

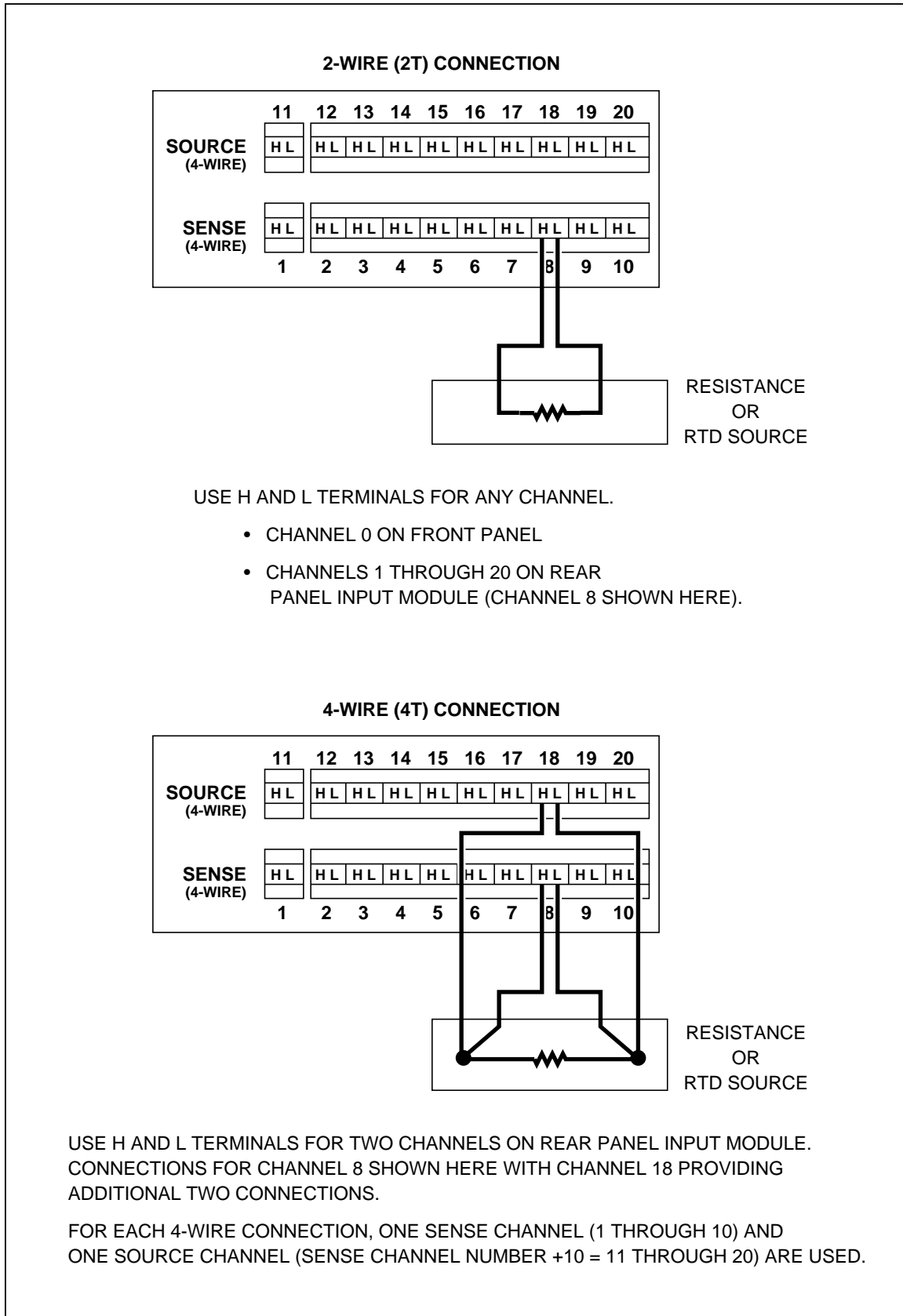

oo16f.eps

Figure 5-2. 2T and 4T-Connections

Table 5-1. Ohms Test Voltage

Range	Typical Full Scale Voltage
300.00 Ω	0.22
3.0000 kΩ	0.25
30.000 kΩ	0.29
300.00 kΩ	0.68
3.0000 MΩ	2.25
10.000 MΩ	2.72

- 4-Terminal Configuration

In 4-terminal configuration, the instrument uses a second pair of leads to automatically eliminate measurement-lead and internal-relay resistance errors.

With measurement lead and internal relay resistances eliminated, this configuration yields the most accurate readings.

Four-terminal measurements are allowed on channels 1 through 10 only. However, two pairs of high (H) and low (L) terminals are needed for this type of measurement. The first pair is provided by the selected channel (any of channels 1 through 10). The second pair is provided by the channel 10 numbers higher. For example, channels 2 and 12 (or 7 and 17) could provide the two pairs of terminals. This second channel provides the necessary two additional terminals, and is therefore not available for any other use until the first channel is changed to a function other than 4-terminal OHMS or RTD.

A 4-terminal configuration is illustrated in Figure 5-2.

True RMS Measurements

The instrument measures the true rms value of ac voltages. In physical terms, the rms (root-mean-square) value of a waveform is the equivalent dc value that causes the same amount of heat to be dissipated in a resistor. True rms measurement greatly simplifies the analysis of complex ac signals. Since the rms value is the dc equivalent of the original waveform, it provides a reliable basis for comparing dissimilar waveforms.

Effects of Internal Noise in AC Measurements

With the input shorted and the instrument set for ac volts (VAC) measurement, internal amplifier noise causes a typical display reading of approximately 0.50 mV. Since the instrument is a true rms responding measurement device, this noise contributes minimally to the reading at the specified floor of each range. When the rms value of the two signals (internal noise and range floor) is calculated, the effect of the noise is shown as:

$$\text{total rms digits} = \sqrt{0.50^2 + 15.00^2} = 15.008$$

The display will read 15.01. At the 28.00 mV input level on the 300.00 mV range in the slow rate, the display will read 28.00 with no observable error.

Waveform Comparison (True RMS vs Average Responding)

Figure 5-3 illustrates the relationship between ac and dc components for common waveforms and compares readings for true-rms measurements (such as with the instrument) and average-responding measurements. For example, consider the first waveform, a 1.41421V (zero-to-peak) sine wave. Both the instrument and rms-calibrated

average-responding measurement devices display the correct rms reading of 1.0000V (the dc component equals 0). However, consider the 2V (peak-to-peak) square wave.

Both types of measurement correctly display the dc component (0V), but the instrument also correctly measures the ac component (1.0000V). The average-responding device measures 1.111V, which amounts to an 11% error.

Average-responding measurement devices have been in use for a long time; you may have accumulated test or reference data based on such instruments. The conversion factors in Figure 5-3 can aid in converting between the two measurement methods.

Making Mixed Measurements

With multiple channels, Hydra Series II allows mixing of measurement types. But the possibility of the ac signal on one channel affecting measurements on other channels must be considered. This effect is known as cross talk.

The ac volts signal could be either a voltage that is to be measured on another channel (which is known as a normal mode signal) or an ac voltage signal on another channel that is present between the channel inputs and earth ground (which is known as a common mode signal). A common mode signal could occur, for example, if an unshielded thermocouple were to be used to measure the metal case temperature of an ac power line diode.

AC voltage cross talk can affect the various measurement types differently. It can cause other ac voltage measurements to read too high. DC and resistance (OHMS) measurements could either shift or read noisy. Frequency measurements could be noisy, or, in the extreme case, the cross talk frequency could actually become the measured signal.

Cross talk can occur at numerous places: in the device or process being monitored, in the wiring to the Hydra Series II instrument, or within the Hydra Series II instrument itself.

Fortunately, precautions can be taken to provide error-free measurements by minimizing the effects of cross talk. Use the following guidelines to minimize cross talk between ac volts signal inputs and other sensitive channels:

- Keep any input wiring carrying ac volts signals physically separate from other sensitive channel's input wiring.
- Avoid connecting inputs with ac volts signals adjacent to sensitive channel inputs. (Leave unconnected channels between the inputs, if possible).

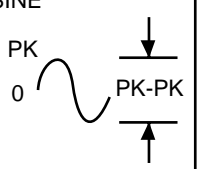
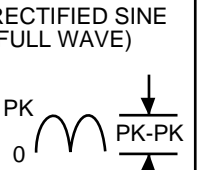
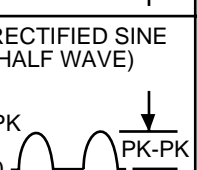
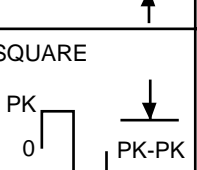
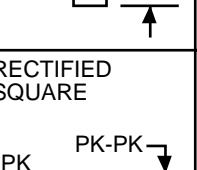
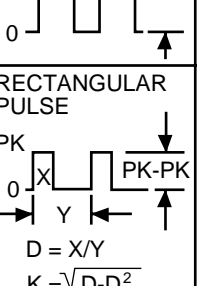
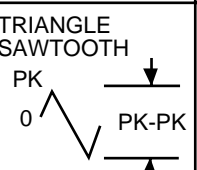
AC-COUPLED INPUT WAVEFORM	PEAK VOLTAGES		MEASURED VOLTAGES			DC AND AC TOTAL RMS TRUE RMS = $\sqrt{ac^2 + dc^2}$
	PK-PK	0-PK	AC COMPONENT ONLY		DC COMPONENT ONLY	
			RMS CAL*	HYDRA		
SINE 	2.828	1.414	1.000	1.000	0.000	1.000
RECTIFIED SINE (FULL WAVE) 	1.414	1.414	0.421	0.436	0.900	1.000
RECTIFIED SINE (HALF WAVE) 	2.000	2.000	0.779	0.771	0.636	1.000
SQUARE 	2.000	1.000	1.111	1.000	0.000	1.000
RECTIFIED SQUARE 	1.414	1.414	0.785	0.707	0.707	1.000
RECTANGULAR PULSE  <p> $D = X/Y$ $K = \sqrt{D-D^2}$ </p>	2.000	2.000	$4.442 K^2$	2K	2D	$2\sqrt{D}$
TRIANGLE SAWTOOTH 	3.464	1.732	0.962	1.000	0.000	1.000

* RMS CAL IS THE DISPLAYED VALUE FOR AVERAGE RESPONDING INSTRUMENTS THAT ARE CALIBRATED TO DISPLAY RMS FOR SINE WAVES

oo17f.eps

Figure 5-3. Comparison of Common Waveforms

- Avoid connecting inputs with ac volts signals to any channel 10 numbers away from a sensitive channel (i.e. 4-terminal input channels.)
- Avoid tying L (low) or (especially) H (high) inputs of a sensitive channel to earth (chassis) ground. This is very important in resistance measurements.
- Avoid high source impedances on sensitive channels, or minimize the capacitance of the sensitive channel to earth (chassis) ground for high impedance inputs.
- Whenever high ohms measurements ($> 10 \text{ k}\Omega$) must be made accurately, avoid connecting any inputs carrying ac volts signals to the Hydra Series II instrument.

Note

If frequencies other than 50 or 60 Hz must be present on other channels while measuring resistance, temperature, or dc voltage, frequencies of 40 Hz + multiples of 80 Hz (40, 120, 200, etc.) up to 2 kHz should be avoided. Otherwise, frequencies at intervals of 5 Hz will generally contribute no more error to a resistance measurement than frequencies of 50 or 60 Hz.

It is not necessary to follow all of these guidelines. In fact, for most applications, adhering to just one of these guidelines will provide satisfactory results. Refer to Appendix D for detailed information about cross talk.

Using Shielded Wiring

Shielded wires and sensors, such as sheathed thermocouples, are often used in noisy environments to reduce measurement errors. When you are connecting these sensors to a measuring instrument, the proper connection of the shield depends on the entire measurement system and environment.

General Rule

Connect the shield to L (low) at the input terminals for each Hydra Series II channel.

Alternate Suggestions

In specific instances, following the General Rule may not result in the optimum noise rejection; it may be necessary to try alternate configurations and check for improved performance.

Non-Isolated Sensor Configuration

If non-isolated sensors are used, (e.g. a thermocouple probe where the sensor and its shield are electrically connected), try leaving the shield disconnected (open) at the 2620A-100 Input Module.

Isolated and Shielded Sensor Configuration

⚠ Warning

The following suggestions rely on the shield being kept electrically isolated from the sensor h (high) and l (low) wiring, except where specifically stated otherwise

If isolated and shielded sensors are used with the instrument, (e.g., an isolated thermocouple probe where the thermocouple junction is electrically isolated from shield), two additional configurations to try are:

1. Connect the shield to L (low) at the 2620A-100 Input Module, and try connecting the sensor shield to a quiet earth ground at or very near the measurement sensor end (and at only one place), or
2. Connect the shield to L (low) at the Input Module, and try connecting the shield to earth ground (only) as close to the rear of the instrument as possible. Isolated and shielded sensors will likely result in the best instrument measurement performance possible in a noisy environment.

In More Detail

If a low noise configuration is required, adhering to the following two rules minimizes measurement errors and noise when using shielded sensors and wiring:

1. Connect the shield so that it and the L (low) terminal are at the same or very nearly the same voltage, and
2. Connect the shield so that common-mode voltages will not cause current to flow through the L (or H) source resistance(s).

One key to applying these rules is to note that very high, but finite impedances exist between H (high) and L (low), between H and earth ground, and between L and earth ground inside the instrument.

Chapter 6

Maintenance

Title	Page
Introduction	6-3
Cleaning.....	6-3
Line Fuse	6-3
Self-Test Diagnostics and Error Codes	6-3
Performance Tests	6-4
Accuracy Verification Test.....	6-7
Channel Integrity Test.....	6-7
Thermocouple Measurement Range Accuracy Test	6-9
4-Terminal Resistance Test.....	6-10
Thermocouple Temperature Accuracy Test.....	6-11
Open Thermocouple Response Test	6-13
RTD Temperature Accuracy Test	6-14
RTD Temperature Accuracy Test (Using Decade Resistance Source)	6-14
RTD Temperature Accuracy Test (Using DIN/IEC 751)	6-15
Digital Input/Output Verification Tests	6-15
Digital Output Test	6-16
Digital Input Test.....	6-16
Totalizer Test.....	6-17
Totalizer Sensitivity Test.....	6-18
Dedicated Alarm Output Test	6-19
External Trigger Input Test.....	6-21
Calibration	6-21
Variations in the Display.....	6-22
Service	6-22

Introduction

This chapter describes basic maintenance that the instrument user can perform. Do not attempt any maintenance not described in this chapter. For additional maintenance, service, and calibration procedures, qualified service personnel can refer to the Hydra Series II Service Manual (P/N 688868).

Cleaning

Warning

To avoid electrical shock or damage to the instrument, never get water inside the case. To avoid damaging the instrument's housing, never apply solvents to the instrument.

For cleaning, wipe the instrument with a cloth that is lightly dampened with water or mild detergent. Do not use aromatic hydrocarbons, chlorinated solvents, or methanol-based fluids.

Line Fuse

The instrument uses a T 125 mA, 250V (Slow blow) line fuse in series with the power supply. To replace this fuse (located on the rear panel), unplug the line cord and remove the fuse holder with the fuse as shown in Figure 6-1. The instrument is shipped with a replacement fuse that is loosely secured in the fuse holder.

Self-Test Diagnostics and Error Codes

When the instrument is powered up, the entire display lights.

Note

*To hold the display fully lit, press and hold **SHIFT**, then press **POWER ON** and wait a moment for the instrument to beep. Then release **SHIFT**. The entire display will now stay on until you press any button; the power-up sequence then resumes.*

Self-test diagnostics are performed each time the instrument is powered up. Any errors encountered during this initial 4-second period are displayed momentarily. Even in the presence of an error, the instrument still attempts to complete the self-test routine and begin normal operation.

An error indicates that a malfunction has occurred and maintenance is required. If you encounter an error, note the number or letter and consult Table 6-1. See if the instrument repeats the error. If the problem persists and you intend to repair the instrument yourself, refer to the Service Manual. Otherwise, package the instrument securely (using the original container if available.) Then forward the package, postage paid, to the nearest Fluke Service Center. Include a brief description of the problem. Fluke assumes no responsibility for damage in transit.

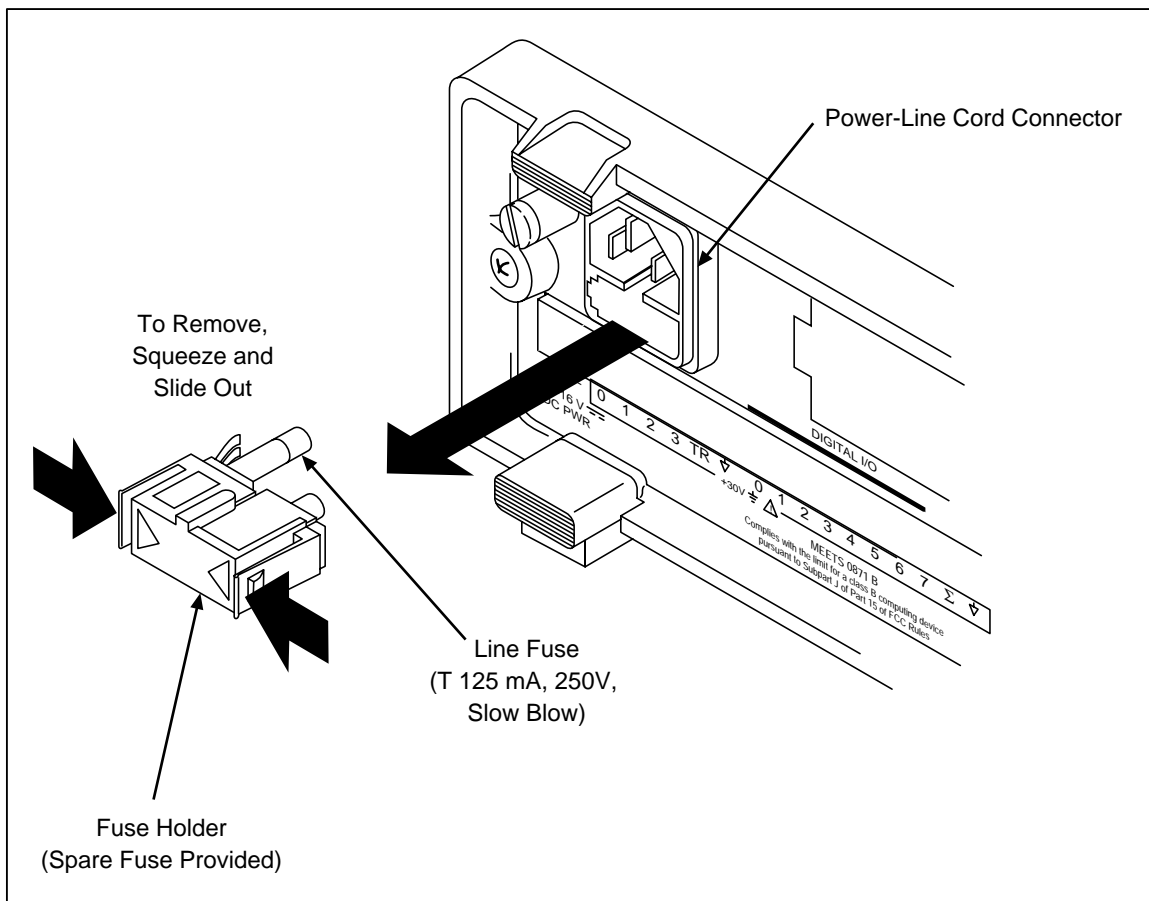

0018f.eps

Figure 6-1. Replacing the Line Fuse

Performance Tests

When received, the 2620A/2625A Hydra Series II instrument is calibrated and in operating condition. The following Performance Verification Procedures are provided for acceptance testing upon initial receipt or to verify correct operation at any time. All tests may be performed in sequence to verify overall operation, or the tests may be run independently.

If the instrument fails any of these performance tests, calibration adjustment and/or repair is needed. To perform these tests, you will need a Fluke 5700A Multifunction Calibrator or equipment meeting the minimum specifications given in Table 6-2.

Table 6-1. Power-Up Error Codes

Error	Description
1	ROM checksum error
2	External RAM test failed
3	Internal RAM test failed
4	Display power-up test failure
5	Display not responding
6	Instrument configuration corrupted
7	EEPROM instrument configuration corrupted
8	EEPROM calibration data corrupted
9	A/D not responding
A	A/D ROM test failure
b	A/D RAM test failure
C	A/D self test failure

Each of the measurements listed in the following steps assume the instrument is being tested after a 1/2 hour warm up, in an environment with an ambient temperature of 18 to 28 degrees C, and a relative humidity of less than 70%.

Note

All measurements listed in the performance test tables are made in the slow reading rate unless otherwise noted.

 Warning

The 2620A/2625A instrument contains high voltages that can be dangerous or fatal. Only qualified personnel should attempt to service the instrument. Turn off the Hydra Series II and remove all power sources before performing the following procedures.

Table 6-2. Recommended Test Equipment

Instrument Type	Minimum Specification	Recommended Model		
Multifunction Calibrator	DC Voltage:	Fluke 5700A		
	Range: 90 mV to 300V dc Accuracy: .005%			
	AC Voltage:			
	Frequency		Voltage	Accuracy
	1 kHz		29 mV to 300V	0.05%
	100 kHz		15 mV to 300V	1.25%
Decade Resistance Source	Frequency:	General Resistance Inc. Model RDS 66A		
	10 kHz		1V rms	.0125%
	Ohms		Accuracy	
	290Ω	0.0125%		
	2.9 kΩ	0.0125%		
	29 kΩ	0.0125%		
	290 kΩ	0.0125%		
	2.9 MΩ	0.0125%		
	<i>Note</i>			
	<i>The 5700A Calibrator can be used for 0.05% accuracy (rated) on the 3.0 kΩ, 30 kΩ, and 3.0 MΩ ranges. The 5700A can be used for 0.06% accuracy on the 300Ω range.</i>			
Mercury Thermometer	0.02 degrees Celsius resolution	Princo ASTM-56C		
Thermocouple Probe	Type K	Fluke P-20K		
Room Temperature Oil/Water Bath	Thermos bottle and cap			
Multimeter	Measures +5V dc	Fluke 77		
Signal Generator	Sinewave, 0.5 to 1V rms 10 Hz to 5 kHz	Fluke 6011A		
Alternate Equipment List (Minimum specifications are the same as in the Standard Equipment List)				
Instrument Type	Recommended Model			
DC Voltage Calibrator	Fluke 5440B			
DMM Calibrator	Fluke 5100B (for AC Volts only)			
Function/Signal Generator	Philips PM5193 or Fluke 6011A			

Accuracy Verification Test

1. Power up the instrument and allow it to temperature stabilize for 1/2 hour.
2. Connect a cable from the Output VA HI and LO connectors of the 5700A to the V Ω and COM connectors on the front panel of the Hydra Series II Instrument. Select the channel 0 function and range on the Hydra Series II and the input level from the 5700A using the values listed in Table 6-3. Press the MON (monitor) button to measure and display the measurement value for channel 0. The display should read between the minimum and maximum values listed in the table.

Channel Integrity Test

Assure the Accuracy Verification Test for channel 0 meets minimum acceptable levels before performing this test.

1. Switch OFF power to the instrument and disconnect all high voltage inputs.
2. Remove the Input Module from the rear of the instrument. Open the Input Module and connect a pair of test leads to the H (high) and L (low) terminals of channel 1. Install the Input Module back into the instrument.
3. Connect the ends of the test leads together to apply a short (0 ohms).
4. Reconnect power and switch the instrument ON.
5. For channel 1, select the 2-terminal ohms function and 300 ohms range on the Hydra Series II Instrument. Press MON and ensure the display reads a resistance of less than or equal to 4.0 ohms. (This test assumes that lead wire resistances are less than 0.1 Ω .)
6. Open the ends of the test leads and ensure that the display reads "OL" (overload).
7. Press MON. This will stop the measurement.
8. Connect a cable from the Output VA HI and LO of the 5700A to the Input Module test leads (observe proper polarity).
9. Select the VDC function and 300 volt range on the Hydra Series II and apply first 0V dc then 290V dc input from the 5700A. Ensure the display reads between the minimum and maximum values as shown in Table 6-3 for the 0 and 290V dc input levels.

Note

Channels 0, 1, and 11 can accommodate a maximum input of 300V dc or ac. However, the maximum input for all other channels can only be 150V dc or ac.

10. With the exception of the selected voltage range and input voltage from the 5700A, repeat steps 1 through 9 for each remaining Input Module channel (2 through 20). Channels 2 through 10 and 12 through 20 should be configured for the 150V dc range and an input voltage of 150 volts.

Table 6-3. Performance Tests (Voltage, Resistance, and Frequency)

Function	Range	Input Level	Frequency	Display Accuracy (1 year, 18-28°C)	
				MIN	MAX
DC Volts	300 mV	0V	--	-0.02	0.02
	300 mV	150 mV	---	149.94	150.06
	300 mV	290 mV	---	289.91	290.09
	3V	2.9V	---	2.8991	2.9009
	-3V	-2.9V	---	-2.9009	-2.8991
	30V	29V	---	28.991	29.009
	150V	150V	---	149.94	150.06
	300V	290V	---	289.91	290.09
<i>Note</i>					
<i>Voltages greater than 150V can only be applied to channels 0,1, and 11.</i>					
	300 mV	20 mV	1 kHz	19.71	20.29
	300 mV	20 mV	100 kHz	18.50	21.50
	300 mV	290 mV	1 kHz	289.28	290.72
	3V	290 mV	100 kHz	275.00	305.00
	3V	2.9V	1 kHz	2.8937	2.9063
	30V	29V	1 kHz	28.931	29.069
	150V	150V	1 kHz	149.54	150.46
	300V	290V	1 kHz	289.34	290.66
<i>Note</i>					
<i>Voltages greater than 150V can only be applied to channels 0, 1, and 11. The rear Input Module must be installed when measuring ac volts on channel 0.</i>					
<i>Note</i>					
<i>For 2-terminal measurements, the resistance accuracy given in this table applies to Channel 0 and makes allowance for up to 0.05 ohm of lead wire resistance. You must add any additional lead wire resistance present in your set up to the resistance values given in this table.</i>					
Resistance	Using inputs in decades of 3:				
	300 Ω	short		0.00	0.09
		300 Ω		299.90	300.15
	3 kΩ	short		0.0000	0.0003
		3 kΩ		2.9989	3.0011
	30 kΩ	30 kΩ		29.990	30.010
	300 kΩ	300 kΩ		299.88	300.12
	3 MΩ	3 MΩ		2.9979	3.0021

Table 6-3. Performance Tests (Voltage, Resistance, and Frequency) (cont)

Using inputs in decades of 1.9:					
300 Ω	short			0.00	0.09
	190 Ω			189.93	190.12
3 kΩ	short			0.0000	0.0003
	1.9 kΩ			1.8992	1.9008
30 kΩ	19 kΩ			18.992	19.008
300 kΩ	190 kΩ			189.91	190.09
3 MΩ	1.9 MΩ			1.8983	1.9017
Using inputs in decades of 1:					
300 Ω	short			0.00	0.09
	100 Ω			99.95	100.10
3 kΩ	short			0.0000	0.0003
3 kΩ	1 kΩ			0.9995	1.0006
30 kΩ	10 kΩ			9.995	10.005
300 kΩ	100 kΩ			99.94	100.06
3 MΩ	1 mΩ			0.9990	1.0010
10 MΩ*	10 MΩ			9.979	10.021
*Optional test point if standards available.					
<i>Note</i>					
<p><i>All channels (0 through 20) can accommodate 2-terminal resistance measurements. Channel 0, with only two connections, cannot be used for 4-terminal measurements. Four-terminal resistance measurements can be defined for channels 1 through 10 only. Channels 11 through 20 are used, as required, for 4-terminal to provide the additional two connections. For example, a 4-terminal set up on channel 1 uses channels 1 and 11, each channel providing two connections.</i></p>					
Frequency	90 kHz	10 kHz/2V p-p		9.994	10.006

Thermocouple Measurement Range Accuracy Test

Assure the Accuracy Verification Test for channel 0 meets minimum acceptable levels before performing this test.

Thermocouple temperature measurements are accomplished using Hydra Series II's internal 100 mV and 1V dc ranges. (The ranges are not configurable by the operator.) This procedure will provide the means to test these ranges.

To test the 100 mV and 1V dc ranges requires computer interfacing with a host (terminal or computer). The host must send commands to select these ranges. These ranges cannot be selected from the front panel of Hydra Series II.

1. Ensure that communication parameters (i.e., transmission mode, baud rate, parity, and echo mode) on the Hydra Series II and the host are properly configured to send and receive serial data. Refer to Chapter 4.
2. Power up Hydra Series II and allow it to temperature stabilize for 1/2 hour.

3. Connect a cable from the Output VA HI and LO connectors of the 5700A to the V Ω and COM connectors on the front panel of the Hydra Series II Instrument.
4. Set the 5700A to output 0V dc
5. Using either a terminal or a computer running a terminal emulation program as the selected host, send the following commands to Hydra Series II:

```
FUNC 0,VDC,I100MV <CR>
```

```
MON 1,0 <CR>
```

```
MON_VAL? <CR>
```

The returned value for channel 0 should be 0 mV \pm 0.006 mV.

Set the 5700A to output 90 mV DC. Send the following command:MON_VAL?
<CR>

The value returned should now be 90 mV \pm 0.028 mV (between 89.972 and 90.028 mV).

6. Change Hydra Series II's channel 0 function to the internal 1V dc range by redefining channel 0. Send the following commands:

```
MON 0 <CR>
```

```
FUNC 0,VDC,I1V <CR>
```

Set the 5700A to output 0.9V dc. Send the following commands:

```
MON 1,0 <CR>
```

```
MON_VAL? <CR>
```

The value returned should be 900 mV \pm 0.21 mV (899.79 to 900.21 mV).

4-Terminal Resistance Test

Assure Channel 0's Accuracy Verification Test for DC Volts and Resistance meets minimum acceptable levels.

1. Switch OFF power to the instrument and disconnect all high voltage inputs.
2. Remove the Input Module from the rear of the instrument. Open the Input Module and connect a pair of test leads (keep as short as possible) to the H (high) and L (low) terminals of channel 1 and a second pair of test leads to the H and L terminals of channel 11. Install the Input Module back into the instrument.
3. Observing polarity connect channel 1's test leads to the Sense HI and LO terminals of the 5700A and channel 11's test leads to the Output HI and LO terminals of the 5700A. Connect as shown in Figure 6-2.
4. Switch the instrument ON.
5. Select the 4-terminal OHMS function, AUTO range, for channel 1 on the Hydra Series II Instrument.
6. Set the 5700A to output the resistance values listed in Table 6-3 (Use decades of 1.9).
7. On Hydra Series II press MON and ensure the display reads between the minimum and maximum values shown on Table 6-3.
8. The 4-terminal Resistance Test is complete. However if you desire to perform this test on Input Module channels (2 through 10) repeat steps 1 through 7 substituting in the appropriate channel number.

Note

4-terminal connections are made using pairs of channels. 4-terminal measurements can only be made on channels 1 through 10. The accompanying pairs are channels 11 through 20.

Thermocouple Temperature Accuracy Test

Assure the Thermocouple Measurement Range Accuracy Test meets minimum acceptable levels before performing this test.

1. Switch OFF power to the instrument and disconnect all high voltage inputs.
2. Remove the Input Module from the rear of the instrument. Open the Input Module and connect a K-type thermocouple to the H (high) and L (low) terminals of channel 1. Install the Input Module back into the instrument.

Note

If other than a K type thermocouple is used, be sure that the instrument is set up for the type of thermocouple used.

3. Reconnect power and switch the instrument ON.
4. Insert the thermocouple and a mercury thermometer in a room temperature bath. Allow 20 minutes for thermal stabilization.
5. Select the temperature and K-type thermocouple function for channel 1. Press MON.
6. The value displayed should be the temperature of the room temperature bath as measured by the mercury thermometer (within tolerances given in Table 6-4, plus any sensor inaccuracies.)
7. The Thermocouple Temperature Accuracy Test is complete. However if you desire to perform this test on any other Input Module channel (2 through 20) repeat steps 1 through 6 substituting in the appropriate channel number.

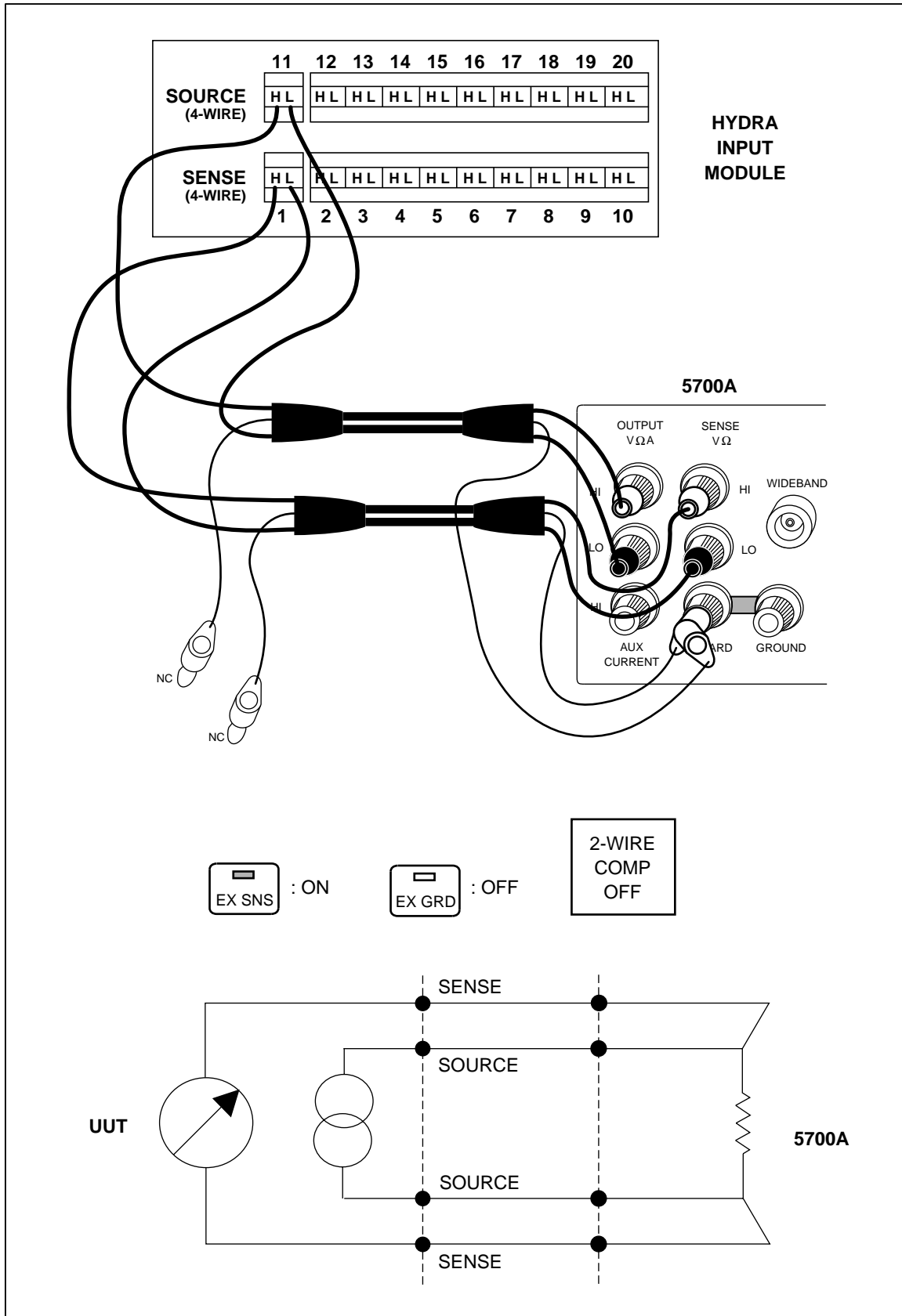

Figure 6-2. 4-Terminal Connections to 5700A

oo19f.eps

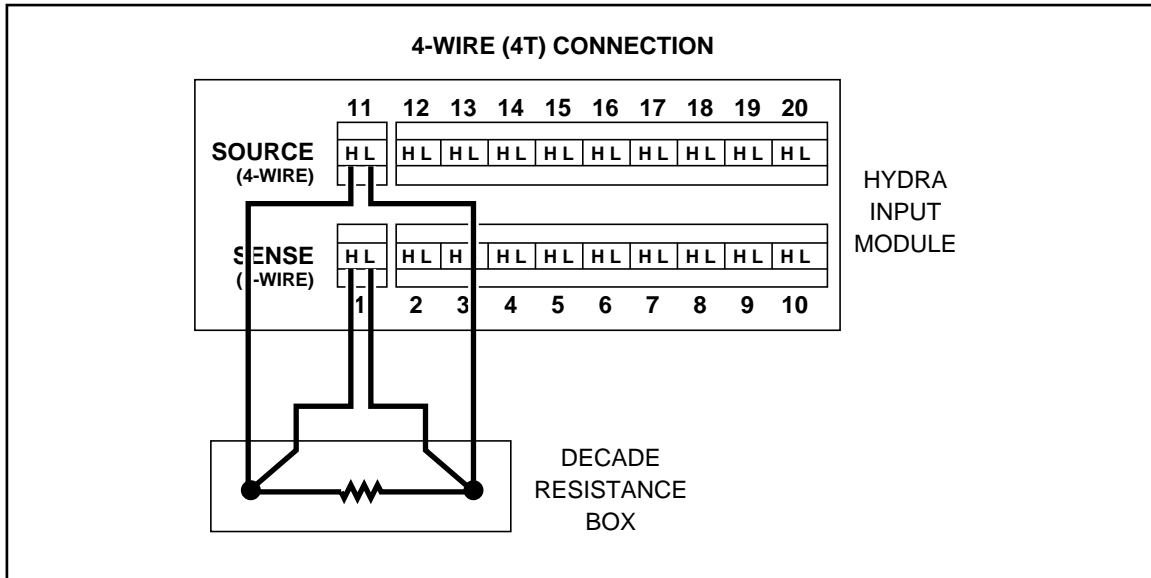

Figure 6-3. 4-Terminal Connections to Decade Resistance Box

oo20f.eps

Table 6-4. Performance Tests for Thermocouple Temperature Function (IPTS-68/ITS-90)

Thermocouple Type	Thermocouple Accuracy Specifications 1 Year @ 18-28 Degrees C
J	±0.40°C
K	±0.44°C
N	±0.53°C
E	±0.38°C
T	±0.45°C

Open Thermocouple Response Test

1. Switch OFF power to the instrument and disconnect all high voltage inputs.
2. Remove the Input Module from the rear of the instrument. Open the Input Module and connect test leads to the H (high) and L (low) terminals of channel 1. Install the Input Module back into the instrument.
3. Reconnect power and switch the instrument ON.
4. Connect the test leads from the Input Module to an 820 ohm resistor.
5. Select the temperature and K-type thermocouple function for channel 1. Press MON.
6. The value displayed should approximate the ambient temperature.
7. Replace the 820 ohm resistor with a 4 kilohm resistor to simulate a high resistance or open thermocouple.
8. Verify a reading of "otc".
9. The Open Thermocouple Response Test is complete. However if you desire to perform this test on any other Input Module channel (2 through 20) repeat steps 1 through 8 substituting in the appropriate channel number.

RTD Temperature Accuracy Test

The following two RTD Temperature Accuracy Tests are different in that one uses a Decade Resistance Source and the other uses an RTD. Only one of the tests need to be performed to assure operation.

RTD Temperature Accuracy Test (Using Decade Resistance Source)

Assure Channel 0's Accuracy Verification Test for DC Volts and 300 Ohm Resistance Range meets minimum acceptable levels.

1. Switch OFF power to the instrument and disconnect all high voltage inputs.
2. Remove the Input Module from the rear of the instrument. Open the Input Module and connect a pair of test leads (keep as short as possible) to the H (high) and L (low) terminals of channel 1. For 4-terminal performance testing, connect a second pair of test leads to the H (high) and L (low) terminals of channel 11. Install the Input Module back into the instrument.
3. Connect channel 1's test leads to the Output HI and LO terminals of the Decade Resistance Source. For 4-terminal performance testing, also connect channel 11's test leads to the Output HI and LO terminals of the Decade Resistance Source. Connect as shown in Figure 6-3.

Note

4-terminal connections are made using pairs of channels. 4-terminal measurements can only be made on channels 1 through 10. The accompanying pairs are channels 11 through 20.

4. Switch the instrument ON.
5. Select the 4-terminal RTD temperature function, RTD type PT, for channel 1 on the Hydra Series II Instrument. Press MON and ensure the display reads between the minimum and maximum values shown on Table 6-5.
6. The RTD Temperature Accuracy test is complete. However if you desire to perform this test on Input Module channels (2 through 10) repeat steps 1 through 5 substituting in the appropriate channel number.

Note

The only type of temperature measurement that can be made on channel 0 is 2-terminal RTD. Channels 11 through 20 will support only 2-terminal RTD's.

**Table 6-5. Performance Tests for RTD Temperature Function (Resistance)
(DIN/IEC 751 Amendment 1) (IPTS-68)**

DECADE RESISTANCE SOURCE	TEMPERATURE SIMULATED °C	TEMPERATURE ACCURACY 1 YEAR @ 18-28°C
100 Ω	0	± 0.12°C
200 Ω	266.42	± 0.22°C
300 Ω	558.00	± 0.37°C

These figures assume that RTD R0 is set to 100.00 ohms for each channel.

Accuracy given is for 4-wire measurements only. For 2-wire measurements, degrade the accuracy specifications by 5.2 °C per ohm of single lead wire resistance. For 2-wire measurements, degrade the accuracy by an additional 11°C (channels 1 .. 20) or 0.05°C (channel 0).

RTD Temperature Accuracy Test (Using DIN/IEC 751)

1. Switch OFF power to the instrument and disconnect all other high voltage inputs.
2. Remove the Input Module from the rear of the instrument. Open the Input Module and connect a Platinum RTD, conforming to the European Standards IEC 751 (DIN 43760).

2-terminal RTD: Connect the RTD's excitation leads to the H (high) and L (low) terminals of channel 1.

4-terminal RTD: Connect the RTD's excitation leads (one red and one black wire) to the H (high) and L (low) terminals of channel 1. Connect the RTD's second pair of red and black leads to the H and L leads of channel 11 (refer to Figure 6-3 for proper connection). Install the Input Module back into the instrument.

Note

4-terminal connections are made using pairs of channels. 4-terminal measurements can only be made on channels 1 through 10. Their accompanying pairs are channels 11 through 20.

3. Switch the instrument ON.
4. Insert the RTD probe and a mercury thermometer in a room temperature bath. Allow 20 minutes for thermal stabilization.
5. Dependent on the type connection made in step 2, select either the 2-Terminal or 4-Terminal RTD temperature function, RTD type PT (DIN IEC 751), for channel 1 on the Hydra Series II Instrument. Press **MON** and ensure the display reads the temperature of the room temperature bath (within tolerances shown in Table 6-6) as measured by the mercury thermometer.

Table 6-6. Performance Tests for RTD Temperature Function (DIN/IEC 751 Amendment 1)(ITS-68)

RTD TYPE	TEMPERATURE ACCURACY SPECIFICATIONS 1 YEAR @ 18-28 DEGREES C
2-wire (channel 0)	-0.54°C to + 0.59°C
2-wire (channels 1-20)	-0.54°C to 11.54°C
4-wire	+/-0.54°C
Assumes RTD R0 is set to 100.00 ohms for each channel	

6. The RTD Temperature Accuracy test is complete. However if you desire to perform this test on any other channel (0 or 2 through 20) repeat steps 1 through 5 substituting in the appropriate channel number.

Note

The only type of temperature measurement that can be made on channel 0 is 2-terminal RTD. Channels 11 through 20 will support only 2-terminal RTD's.

Digital Input/Output Verification Tests

Digital Input/Output verification testing requires computer interfacing with a host (terminal or computer). The host must send commands to the instrument to control the digital lines for this test. Refer to Chapter 4 for a description of configuring and operating the instrument.

Digital Output Test

1. Ensure that communication parameters (i.e., transmission mode, baud rate, parity, and echo mode) on the Hydra Series II and the host are properly configured to send and receive serial data. Refer to Chapter 4.
2. Switch OFF power to the instrument and disconnect all high voltage inputs.
3. Remove the Digital I/O ten terminal connector from the rear of the instrument and all external connections to it. Connect short wires (to be used as test leads) to the ground (\perp) and 0 through 7 terminals. Leave the other wire ends unconnected at this time. Reinstall the connector.
4. Switch power ON to both Hydra Series II and the host. Verify that Hydra Series II is not scanning. If Hydra Series II is scanning, press SCAN to turn scanning off, then cycle power off-on again.
5. Using a digital multimeter (DMM), verify that all digital outputs (0-7) are in the OFF or HIGH state. This is done by connecting the low or common of the multimeter to the ground test lead and the high of the multimeter to the digital output and verifying a voltage greater than +3.8V dc.
6. Using either a terminal or a computer running a terminal emulation program, set up Hydra Series II to turn Digital Outputs ON (LOW state). In sequence send the following commands to Hydra Series II and measure that the correct Digital Output line transitioned LOW measures less than +0.8V dc.

DO_LEVEL 0,0 <CR>

Assure output 0 measures a LOW state.

DO_LEVEL 1,0 <CR>

Assure output 1 measures a LOW state.

DO_LEVEL 2,0 <CR>

Assure output 2 measures a LOW state.

Repeat the command for all eight outputs.

7. Set up Hydra Series II to turn Digital Outputs OFF (HIGH state).

In sequence send the following commands to Hydra Series II and measure that the correct Digital Output line transitioned HIGH measures greater than +3.8V dc.

DO_LEVEL 0,1 <CR>

Assure output 0 measures a HIGH state.

DO_LEVEL 1,1 <<CR>>

Assure output 1 measures a HIGH state.

Repeat the command for all eight outputs.

Digital Input Test

1. Perform the DIGITAL OUTPUT TEST steps 1 through 5.
2. Using either a terminal or a computer running a terminal emulation program, set up Hydra Series II to read the Digital Input lines.

Send the following command to Hydra Series II:

DIO_LEVELS? <CR>

Verify that the returned value as shown on the Host screen = 255.

Note

The number returned is the decimal equivalent of the Digital Input binary word (inputs 0 through 7's status). See Table 6-7 to determine if the number returned corresponds to the bits jumpered to ground in this test.

3. Jumper input 0 to ground by connecting the ground test lead to input 0's test lead.
Then send the following command to Hydra Series II:
DIO_LEVELS? <CR>
Verify that the returned value as shown on the Host screen = 254.
4. Disconnect input 0 from ground then jumper input 1 to ground.
Send the command: DIO_LEVELS? <CR>
Verify the returned value is 253.
5. Repeat step 4 for each input and verify the correct returned value (See Table 6-7).

Table 6-7. Digital Input Values

TERMINAL GROUNDED	STATE OF DIGITAL INPUTS	DECIMAL VALUE
none	inputs 0-7, all HIGH	255
0	inputs 1-7 HIGH, input 0 LOW	254
1	inputs 0,2-7 HIGH, input 1 LOW	253
2	inputs 0-1 and 3-7 HIGH, input 2 LOW	251
3	inputs 0-2 and 4-7 HIGH, input 3 LOW	247
4	inputs 0-3 and 5-7 HIGH, input 4 LOW	239
5	inputs 0-4 and 6-7 HIGH, input 5 LOW	223
6	inputs 0-5 and 7 HIGH, input 6 LOW	191
7	inputs 0-6 HIGH, input 7 LOW	127

Totalizer Test

This totalizer verification test requires toggling the Digital Output line 0 and using it as the Total input. The test requires computer interfacing with a host (terminal or computer). The host must send commands to the 2620A/2625A instrument to control the digital line for this test. Refer to Chapter 4 for a description of configuring and operating the Hydra Series II instrument.

1. Ensure that communication parameters (i.e., transmission mode, baud rate, parity, and echo mode) on the Hydra Series II and the host are properly configured to send and receive serial data. Refer to Chapter 4.
2. Switch OFF power to the instrument and disconnect all high voltage inputs.
3. Remove the Digital I/O ten terminal connector from the rear of the instrument and all external connections to it. Connect short wires (to be used as test leads) to the 0 terminal and the Total (Σ) terminal. Leave other ends of wires unconnected at this time. Reinstall the connector.
4. Switch ON power to both Hydra Series II and the host.

5. Press the TOTAL button on the front panel of Hydra Series II.
Assure Hydra Series II displays a 0 value.
6. Jumper output 0 to the Total (Σ) input by connecting the (Σ) terminal test lead to output 0's test lead.
7. Using either a terminal or a computer running a terminal emulation program, set up Hydra Series II to toggle (turn ON and OFF) Digital Output 0.
In sequence send the following commands to Hydra Series II and assure Hydra Series II measures and displays the correct total value:
DO_LEVEL 0,0 <CR>
DO_LEVEL 0,1 <CR>
Assure Hydra Series II displays a totalizer count of 1.
8. Again in sequence send the commands:
DO_LEVEL 0,0 <CR>
DO_LEVEL 0,1 <CR>
A totalizer count of 2 should now be displayed.
9. Repeat step 8 for each incremental totalizing count.
10. Set the Hydra Series II's totalized count to a value near full range (65535) and test for overload.
Send the following commands to Hydra Series II:
TOTAL 65534 <CR>
DO_LEVEL 0,0 <CR>
DO_LEVEL 0,1 <CR>
A totalizer count of 65535 should be displayed.
11. Send:
DO_LEVEL 0,0 <CR>
DO_LEVEL 0,1 <CR>
Hydra Series II's display should now read "OL". This indicates that the counter has been overrun.

Totalizer Sensitivity Test

1. Perform the Totalizer Test and assure it is operational.
2. Remove the jumper connecting the (Σ) terminal test lead to output 0's test lead.
3. Assure Hydra Series II is still in the total measuring mode. If not press the TOTAL button. Reset the totalizer count shown on the display by pressing Hydra Series II's front panel SHIFT button followed by ZERO (total) button.
Hydra Series II's display should now show a value of 0.
4. Connect the output of the signal generator to the (Σ) and ground \perp terminals.
5. Program the signal generator to output a 1.5V rms sine signal at 10 Hz.

Hydra Series II's display should now show the totalizing value incrementing at a 10 count per second rate.

Dedicated Alarm Output Test

The Dedicated Alarm Output Test verifies that Alarm Outputs 0 through 3 are functioning properly. Because this test is dependent on voltage readings the Accuracy Verification Test for channel 0 and the Channel Integrity Test for channels 1 through 3 should be performed if voltage readings are suspect.

1. Switch OFF power to the instrument and disconnect all high voltage inputs.
2. Remove the Alarm Output eight terminal connector module from the rear of Hydra Series II and all external connections to it. Connect short wires (to be used as test leads) to the ground (\perp) and 0 through 3 terminals. Leave other ends of wires unconnected at this time. Reinstall the connector.
3. Remove the Input Module from the rear of Hydra Series II. Open the Input Module and jumper the H (high) terminal of channels 1, 2, and 3 together. Connect a test lead to the H of channel 1. Also jumper the L (low) terminals of channel 1, 2, and 3 together. Connect a second test lead to the L of channel 1. Install the Input Module back into Hydra Series II. Refer to Figure 6-4.
4. Switch power ON.
5. Using a digital multimeter (DMM), verify that alarm outputs 0 through 3 are in the OFF or HIGH state. Perform this test by connecting the low or common of the multimeter to the ground test lead and the high of the multimeter to the alarm output. Verify a voltage greater than +3.8V dc.
6. Connect a cable from the Output VA HI and LO connectors of the 5700A to the V Ω and COM connectors on the front panel of Hydra Series II. Then jumper Hydra Series II's V Ω terminal to the H (high) test lead of the Input Module and the COM terminal to the L (low) test lead (See Input Connection diagram).
7. On Hydra Series II, select the VDC function, 3V range, and assign a HI alarm limit of +1.0000 for channels 0 through 3. Set up all other channels (4-20) to the OFF function. Select a scan interval of 5 seconds.
8. Set the 5700A to output +0.9900 volts.
9. Press Hydra Series II's SCAN button. Hydra Series II should scan channels 0 through 3 every 5 seconds.
10. Using a digital multimeter, again verify that alarm outputs 0 through 3 are in the OFF or HIGH state.
11. Set the 5700A to output +1.1000 volts. Verify that the alarm outputs 0 through 3 are in the ON or LOW state (measure less than +0.8V dc).

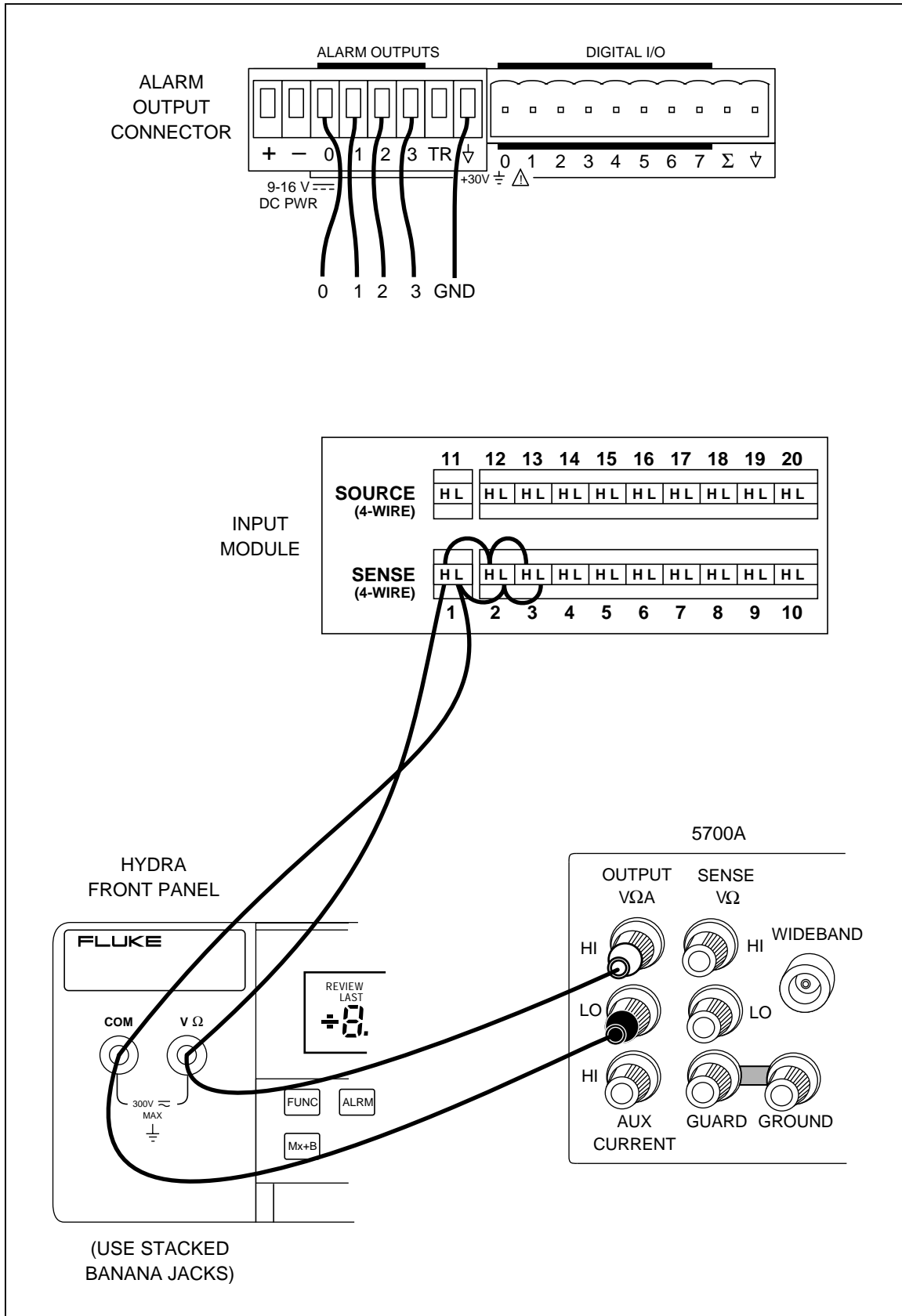

oo21f.eps

Figure 6-4. Dedicated Alarms Output Test

External Trigger Input Test

The External Trigger Input Test verifies that the rear panel trigger input of Hydra Series II is functioning properly.

1. Switch OFF power to the instrument and disconnect all high voltage inputs.
2. Remove the Alarm Output eight terminal connector module from the rear of Hydra Series II and all external connections to it. Connect short wires (to be used as test leads) to the ground (\perp) and TR terminals. Leave other ends of wires unconnected at this time. Reinstall the connector. Refer to Figure 6-5.

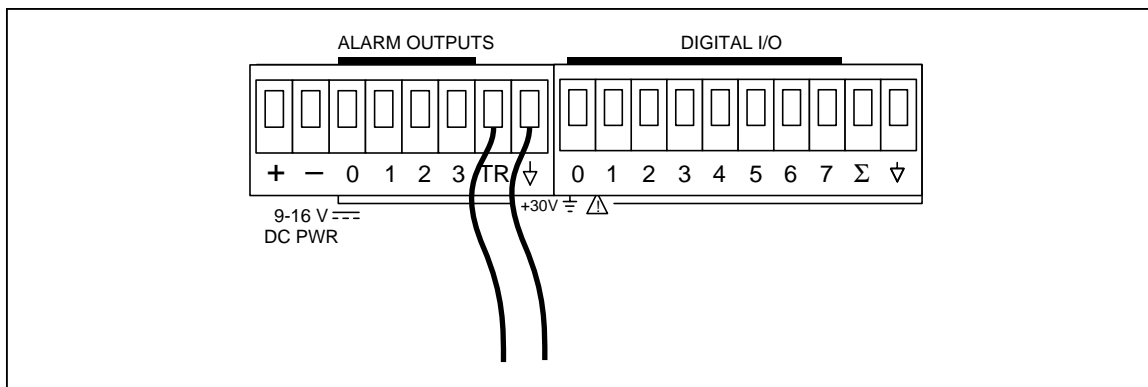

Figure 6-5. External Trigger Test

oo22f.eps

3. Switch power ON.
4. On Hydra Series II, select the VDC function, 30V range for channels 0 through 5. Select a scan interval of 30 seconds.
5. Select trigger ON to enable the external trigger input. Press the SHIFT and MON(TRIGS) buttons (the display shows TRIG), then press either the up or down arrow buttons to display ON. Press ENTER.
6. Press Hydra Series II's SCAN button. Hydra Series II should scan channels 0 through 5 once every 30 seconds.
7. During the interval when scanning is not occurring, connect (short) the test leads of the TR and ground Alarm Output terminals.
Ensure the connection causes a single scan to occur.
8. Disconnect (open) the TR and ground connection.
Ensure the scan continues to execute at its specified interval.

Calibration

Note

Refer to the Fluke Hydra Series II Service Manual (P/N 688868) for calibration procedures. The instrument must be stabilized in an environment with ambient temperature of 22 to 24°C and relative humidity of less than 70% and have been turned on for at least 1/2 hour prior to calibration.

The instrument features closed-case calibration controlled over the Computer Interface. Using known reference sources, closed-case calibration has many advantages. There are

no parts to disassemble, no mechanical adjustments to make, and the instrument can be calibrated by an automated instrumentation system.

The instrument should normally be calibrated on a regular cycle, typically every 90 days or 1 year. The chosen calibration cycle depends on the accuracy specification you wish to maintain. The instrument should also be calibrated if it fails the performance test or has undergone repair.

Note

Do not press CAL ENABLE unless you have a copy of the Service Manual and intend to calibrate the instrument. If you have activated calibration and wish to exit calibration, press CAL ENABLE until CAL disappears from the display (or press power OFF).

Refer to the Hydra Series II Service Manual for the essential calibration procedures.

Variations in the Display

Note

This feature is not available with instruments having Main Firmware version 5.5.

Under normal operation, the display presents various combinations of brightly and dimly lit annunciators and digits. However, you may encounter other, random irregularities across different areas of the display under the following circumstances:

- After prolonged periods of displaying the same information.
- If the display has not been used for a prolonged period.

This phenomenon can be cleared by activating the entire display and leaving it on overnight (or at least for several hours). Use the following procedure to keep the display fully lit:

1. With power OFF, press and hold SHIFT, then press power ON.
2. Wait a moment for the instrument to beep, then release SHIFT. The entire display will now stay on until you are ready to deactivate it.
3. At the end of the activation period, press any button on the front panel; the instrument resumes the mode in effect prior to the power interruption (Active or Inactive.)

Service

If the instrument fails, check that operating instructions presented earlier in this manual are being followed. If the problem cannot be remedied, forward the instrument, postage paid, to the nearest Fluke Service Center. Be sure to pack the instrument securely; use the original container if available. Include a brief description of the problem. Fluke assumes NO responsibility for damage in transit.

To locate an authorized service center, visit us on the World Wide Web: www.fluke.com or call Fluke using any of the phone numbers listed below.

1-800-44-FLUKE (1-800-443-5853) in U.S.A. and Canada
+31 402-678-200 in Europe
+81-3-3434-0181 Japan
+65-*-276-6196 Singapore
+1-425-356-5500 in other countries

Appendices

Appendix	Title	Page
A	Specifications.....	A-1
B	ASCII & IEEE-488 Bus Codes.....	B-1
C	IEEE-488.2 Devise Documentation Requirements.....	C-1
D	Making Mixed Measurements	D-1
E	Binary Upload of Logged Data (LOG_BIN?) (2625A only).....	E-1
F	RS-232 Cabling.....	F-1

Appendix A Specifications

Introduction

The instrument specifications presented here are applicable within the conditions listed in the Environmental chapter.

The specifications state total instrument accuracy following calibration, including:

- A/D errors
- Linearization conformity
- Initial calibration errors
- Isothermality errors
- Relay thermal emf's
- Reference junction conformity
- Temperature coefficients
- Humidity errors

Sensor inaccuracies are not included in the accuracy figures.

Accuracies at Ambient Temperatures Other Than Specified

To determine typical accuracies at temperatures intermediate to those listed in the specification tables, linearly interpolate between the applicable 0°C to 60°C and 18°C to 28°C accuracy specifications.

Response Times

Refer to Typical Scanning Rate and Maximum Autoranging Time later in this Appendix.

DC Voltage Inputs

Range	Resolution	
	Slow	Fast
300 mV	10 μ V	0.1 mV
3 V	0.1 mV	1 mV
30 V	1 mV	10 mV
300 V	10 mV	0.1 V

Range	Accuracy \pm (% \pm V)				
	18°C to 28°C			0°C to 60°C	
	90 Days, Slow	1 Year, Slow	1 Year, Fast	1 Year, Slow	1 Year, Fast
300 mV	0.018% + 20 μ V	0.023% + 20 μ V	0.040% + 0.2 mV	0.067% + 20 μ V	0.084% + 0.2 mV
3V	0.019% + 0.2 mV	0.024% + 0.2 mV	0.041% + 2 mV	0.065% + 0.2 mV	0.082% + 2 mV
30V	0.019% + 2 mV	0.024% + 2 mV	0.041% + 20 mV	0.086% + 2 mV	0.103% + 20 mV
150/300V	0.019% + 20 mV	0.024% + 20 mV	0.041% + 0.2V	0.087% + 20 mV	0.104% + 0.2V

Input Impedance

100 M Ω minimum in parallel with 150 pF maximum for all ranges 3V and below 10 M Ω in parallel with 100 pF maximum for the 30V and 300V ranges

Normal Mode Rejection

53 dB minimum at 60 Hz \pm 0.1%, slow rate
47 dB minimum at 50 Hz \pm 0.1%, slow rate

Common Mode Rejection

120 dB minimum at dc, 1 k Ω imbalance, slow rate
120 dB minimum at 50 or 60 Hz \pm 0.1%, 1 k Ω imbalance, slow rate

Maximum Input

300V dc or ac rms on any range for channels 0,1, and 11
150V dc or ac rms for channels 2 to 10 and 12 to 20

Cross-Talk Rejection

Refer to Appendix D

Thermocouple Inputs

Temperature Measurements - Accuracy (Thermocouples) (IPTS-68)

Thermocouple		Accuracy ($\pm^{\circ}\text{C}$)*				
		18°C to 28°C			0°C TO 60°C	
Type	Temperature (C°)	90 Days Slow	1 Year Slow	1 Year Fast	1 Year Slow	1 Year Fast
J	-100 to -30	0.43	0.44	0.91	0.55	1.09
	-30 to 150	0.38	0.40	0.81	0.58	1.02
	150 to 760	0.43	0.47	0.92	0.87	1.36
K	-100 to -25	0.52	0.53	1.13	0.65	1.31
	-25 to 120	0.43	0.45	0.94	0.63	1.17
	120 to 1000	0.60	0.67	1.37	1.27	2.02
	1000 to 1372	0.98	1.08	1.96	1.94	2.88
N	-100 to -25	0.62	0.63	1.43	0.74	1.60
	-25 to 120	0.52	0.54	1.21	0.66	1.38
	120 to 410	0.46	0.48	1.07	0.68	1.27
	410 to 1300	0.66	0.73	1.47	1.40	2.18
E	-100 to 25	0.45	0.46	0.91	0.58	1.09
	-25 to 350	0.38	0.39	0.77	0.62	0.99
	350 to 650	0.39	0.43	0.82	0.80	1.22
	650 to 1000	0.49	0.55	1.04	1.10	1.63
T	-150 to 0	0.68	0.69	1.49	0.82	1.71
	0 to 120	0.45	0.46	0.95	0.59	1.13
	120 to 400	0.36	0.38	0.78	0.61	1.01
R	250 to 400	0.83	0.85	2.47	1.03	2.66
	400 to 1000	0.80	0.82	2.31	1.16	2.54
	1000 to 1767	0.93	1.02	2.51	1.80	3.31
S	250 to 1000	0.87	0.89	2.60	1.27	2.79
	1000 to 1400	0.83	0.89	2.35	1.47	2.94
	1400 to 1767	1.08	1.17	2.90	2.00	3.76
B	600 to 1200	1.07	1.09	3.50	1.24	3.66
	1200 to 1550	0.73	0.76	2.24	1.17	2.56
	1550 to 1820	0.79	0.85	2.32	1.39	2.87
C	0 to 150	0.75	0.77	1.94	0.89	2.12
	150 to 650	0.63	0.65	1.63	0.98	1.94
	650 to 1000	0.71	0.76	1.82	1.30	2.39
	1000 to 1800	1.12	1.25	2.86	2.39	4.05
	1800 to 2316	1.96	2.18	4.71	4.15	6.76

*Sensor inaccuracies are not included

Temperature Measurements - Accuracy (Thermocouples) (ITS-90)

Thermocouple		Accuracy ($\pm^{\circ}\text{C}$)*				
		18°C to 28°C			0°C to 60°C	
Type (°C)	Temperature (°C)	90 Days Slow	1 Year Slow	1 Year Fast	1 Year Slow	1 Year Fast
J	-100 to -30	0.44	0.45	0.92	0.57	1.10
	-30 to 150	0.41	0.43	0.83	0.61	1.06
	150 to 760	0.48	0.53	0.98	0.92	1.42
K	-100 to -25	0.53	0.54	1.14	0.66	1.33
	-25 to 120	0.46	0.48	0.96	0.66	1.19
	120 to 1000	0.79	0.85	1.55	1.45	2.20
	1000 to 1372	1.32	1.42	2.30	2.29	3.23
N	-100 to -25	0.63	0.64	1.44	0.75	1.61
	-25 to 120	0.53	0.54	1.21	0.66	1.39
	120 to 410	0.45	0.48	1.05	0.73	1.30
	410 to 1300	0.88	0.95	1.70	1.63	2.41
E	-100 to -25	0.46	0.47	0.92	0.59	1.10
	-25 to 350	0.39	0.42	0.77	0.65	1.02
	350 to 650	0.47	0.51	0.90	0.88	1.30
	650 to 1000	0.63	0.70	1.18	1.24	1.77
T	-150 to 0	0.68	0.69	1.49	0.82	1.71
	0 to 120	0.45	0.46	0.95	0.59	1.13
	120 to 400	0.37	0.39	0.80	0.61	1.02
R	250 to 400	0.86	0.88	2.49	1.03	2.68
	400 to 1000	0.90	0.94	2.28	1.34	2.63
	1000 to 1767	1.49	1.58	3.12	2.39	3.95
S	250 to 1000	1.00	1.05	2.68	1.47	2.93
	1000 to 1400	1.22	1.29	2.74	1.86	3.33
	1400 to 1767	1.66	1.76	3.54	2.61	4.43
B	600 to 1200	1.18	1.19	3.61	1.35	3.77
	1200 to 1550	1.14	1.19	2.57	1.60	2.99
	1550 to 1820	1.33	1.39	2.86	1.93	3.41
C	0 to 150	0.74	0.76	1.93	0.89	2.11
	150 to 650	0.69	0.73	1.66	1.08	2.04
	650 to 1000	0.89	0.95	2.00	1.48	2.57
	1000 to 1800	1.72	1.85	3.46	2.99	4.65
	1800 to 2316	2.60	2.82	5.35	4.80	7.40

* Sensor inaccuracies are not included.

Input Impedance

100 MΩ minimum in parallel with 150 pF maximum

Common Mode and Normal Mode Rejection

See Specifications, DC Voltage Inputs

Cross-Talk Rejection

Refer to Appendix D

Open Thermocouple Detect

Small ac signal injection and detection scheme before each measurement detects greater than 1 to 4 kΩ as open. Performed on each channel unless defeated by computer command.

RTD Inputs

Type

DIN/IEC 751, 100Ω Platinum (385)

IEC 751, Amendment 1, 100 Ω Platinum (IPTS-68)

RTD Temperature (°C)	4 Wire Accuracy* (±°C)						
	Resolution		18°C to 28°C			0°C to 60°C	
	Slow	Fast	90 Day Slow	1 Year Slow	1 Year Fast	1 Year Slow	1 Year Fast
-200.00	0.02	0.1	0.06	0.06	0.48	0.07	0.49
0.00	0.02	0.1	0.09	0.09	0.55	0.13	0.59
100.00	0.02	0.1	0.10	0.11	0.58	0.17	0.64
300.00	0.02	0.1	0.14	0.14	0.65	0.24	0.75
600.00	0.02	0.1	0.19	0.20	0.76	0.37	0.93

* Sensor inaccuracies are not included

IEC 751, Amendment 1, 100 Ω Platinum (ITS-90)

RTD Temperature (°C)	4 Wire Accuracy* (±°C)						
	Resolution		18°C to 28°C			0°C to 60°C	
	Slow	Fast	90 Day Slow	1 Year Slow	1 Year Fast	1 Year Slow	1 Year Fast
-200.00	0.02	0.1	0.06	0.06	0.48	0.07	0.49
0.00	0.02	0.1	0.09	0.09	0.55	0.13	0.59
100.00	0.02	0.1	0.13	0.13	0.60	0.19	0.67
300.00	0.02	0.1	0.17	0.18	0.69	0.28	0.79
600.00	0.02	0.1	0.30	0.31	0.87	0.48	1.04

* Sensor inaccuracies are not included

IEC 751, Amendment 2, 100 Ω Platinum (ITS-90)

RTD Temperature (°C)	4 Wire Accuracy* (\pm °C)						
	Resolution		18°C to 28°C			0°C to 60°C	
	Slow	Fast	90 Day Slow	1 Year Slow	1 Year Fast	1 Year Slow	1 Year Fast
-200.00	0.02	0.1	0.13	0.13	0.54	0.13	0.55
0.00	0.02	0.1	0.09	0.09	0.55	0.13	0.59
100.00	0.02	0.1	0.12	0.12	0.59	0.18	0.66
300.00	0.02	0.1	0.23	0.24	0.74	0.34	0.85
600.00	0.02	0.1	0.55	0.56	1.12	0.73	1.29

* Sensor inaccuracies are not included

2-Wire Accuracy

For 2-wire sensors with $R_0 = 100\Omega$: degrade accuracy by 5.0°C per lead-ohm, plus degrade accuracy an additional 11°C for channels 1 to 20 and 0.05°C for channel 0.

Maximum Current Through Sensor

1 mA

Typical Full Scale Voltage

0.22 V

Maximum Open Circuit Voltage

3.2 V

Maximum Sensor Temperature

600°C nominal

999.99°F max displayed

Cross-talk Rejection

Refer to Appendix D.

AC Voltage Inputs

Range	Resolution		Minimum Input For Rated Accuracy
	Slow	Fast	
300 mV	10 μ V	100 μ V	20 mV
3 V	100 μ V	1 mV	200 mV
30 V	1 mV	10 mV	2 V
300 V	10 mV	100 mV	20 V

Range	Frequency	1 Year Accuracy $\pm(\% \pm V)$			
		18°C to 28°C		0°C to 60°C	
		Slow	Fast	Slow	Fast
300 mV	20 Hz - 50 Hz	1.43% + 0.25 mV	1.43% + 0.4 mV	1.54% + 0.25 mV	1.54% + 0.4 mV
	50 Hz - 100 Hz	0.30% + 0.25 mV	0.30% + 0.4 mV	0.41% + 0.25 mV	0.41% + 0.4 mV
	100 Hz - 10 kHz	0.16% + 0.25 mV	0.16% + 0.4 mV	0.27% + 0.25 mV	0.27% + 0.4 mV
	10 kHz - 20 kHz	0.37% + 0.25 mV	0.37% + 0.4 mV	0.68% + 0.25 mV	0.68% + 0.4 mV
	20 kHz - 50 kHz	1.9% + 0.30 mV	1.9% + 0.5 mV	3.0% + 0.30 mV	3.0% + 0.5 mV
	50 kHz - 100 kHz	5.0% + 0.50 mV	5.0% + 1.0 mV	7.0% + 0.50 mV	7.0% + 1.0 mV
3V	20 Hz - 50 Hz	1.42% + 2.5 mV	1.42% + 4 mV	1.53% + 2.5 mV	1.53% + 4 mV
	50 Hz - 100 Hz	0.29% + 2.5 mV	0.29% + 4 mV	0.40% + 2.5 mV	0.40% + 4 mV
	100 Hz - 10 kHz	0.13% + 2.5 mV	0.13% + 4 mV	0.24% + 2.5 mV	0.24% + 4 mV
	10 kHz - 20 kHz	0.22% + 2.5 mV	0.22% + 4 mV	0.35% + 2.5 mV	0.35% + 4 mV
	20 kHz - 50 kHz	0.6% + 3.0 mV	0.6% + 5 mV	0.9% + 3.0 mV	0.9% + 5 mV
	50 kHz - 100 kHz	1.0% + 5.0 mV	1.0% + 10 mV	1.4% + 5.0 mV	1.4% + 10 mV
30V	20 Hz - 50 Hz	1.43% + 25 mV	1.43% + 40 mV	1.58% + 25 mV	1.58% + 40 mV
	50 Hz - 100 Hz	0.29% + 25 mV	0.29% + 40 mV	0.45% + 25 mV	0.45% + 40 mV
	100 Hz - 10 kHz	0.15% + 25 mV	0.15% + 40 mV	0.30% + 25 mV	0.30% + 40 mV
	10 kHz - 20 kHz	0.22% + 25 mV	0.22% + 40 mV	0.40% + 25 mV	0.40% + 40 mV
	20 kHz - 50 kHz	0.9% + 30 mV	0.9% + 50 mV	1.1% + 30 mV	1.1% + 50 mV
	50 kHz - 100 kHz	2.0% + 50 mV	2.0% + 100 mV	2.2% + 50 mV	2.2% + 100 mV
300V	20 Hz - 50 Hz	1.42% + 0.25V	1.42% + 0.4V	1.57% + 0.25V	1.57% + 0.4V
	50 Hz - 100 Hz	0.29% + 0.25V	0.29% + 0.4V	0.44% + 0.25V	0.44% + 0.4V
	100 Hz - 10 kHz	0.14% + 0.25V	0.14% + 0.4V	0.29% + 0.25V	0.29% + 0.4V
	10 kHz - 20 kHz	0.22% + 0.25V	0.22% + 0.4V	0.38% + 0.25V	0.38% + 0.4V
	20 kHz - 50 kHz	0.9% + 0.30V	0.9% + 0.5V	1.0% + 0.30V	1.0% + 0.5V
	50 kHz - 100 kHz	2.5% + 0.50V	2.5% + 1.0V	2.6% + 0.50V	2.6% + 1.0V

Frequency	Maximum Input at Upper Frequency
20 Hz - 50 Hz	300 V rms
50 Hz - 100 Hz	300 V rms
100 Hz - 10 kHz	200 V rms
10 kHz - 20 kHz	100 V rms
20 kHz - 50 kHz	40 V rms
50 kHz - 100 kHz	20 V rms

Input Impedance

1 M Ω in parallel with 100 pF maximum Maximum

Maximum Crest Factor

3.0
2.0 for rated accuracy

Crest Factor Error

Non-sinusoidal input signals with crest factors between 2 and 3 and pulse widths 100 μ s and longer add 0.2% to the accuracy specifications.

Common Mode Rejection

80 dB minimum at 50 or 60 Hz \pm 0.1%, 1 k Ω imbalance, slow rate

Maximum AC Input

300V rms or 424V peak on channels 0, 1, and 11
150V rms or 212V peak on channels 2 to 10 and 12 to 20
Voltage ratings between channels must not be exceeded

2 x 10⁶ Volt-Hertz product on any range, normal mode input
1 x 10⁶ Volt-Hertz product on any range, common mode input

DC Component Error

SCAN and first MONitor measurements will be incorrect if the dc signal component exceeds 60 counts in slow rate or 10 counts in fast rate. To measure ac with a dc component present, MONitor the input and wait 5 seconds before recording the measurement.

Cross-Talk Rejection

Refer to Appendix D.

Ohms Inputs

Range	Resolution		Typical Full Scale Voltage	Maximum Current Through Unknown	Maximum Open Circuit Voltage
	Slow	Fast			
300 Ω	10 mΩ	0.1 Ω	0.22 V	1 mA	3.2V
3 kΩ	0.1 Ω	1 Ω	0.25V	110 μA	1.5 V
30 kΩ	1 Ω	10 Ω	0.29 V	13 μA	1.5 V
300 kΩ	10 Ω	100 Ω	0.68 V	3.2 μA	3.2 V
3 MΩ	100 Ω	1 kΩ	2.25 V	3.2 μA	3.2 V
10 MΩ	1 kΩ	10 kΩ	2.72 V	3.2 μA	3.2 V

Range	4-Wire Accuracy ±(%±Ω)				
	18°C to 28°C			0°C to 60°C	
	90 Days, Slow	1 Year, Slow	1 Year, Fast	1 Year, Slow	1 Year, Fast
300 Ω	0.013% + 20 mΩ	0.014% + 20 mΩ	0.014% + 0.2 Ω	0.031% + 20 mΩ	0.031% + 0.2 Ω
3 kΩ	0.015% + 0.2 Ω	0.016% + 0.2 Ω	0.016% + 2 Ω	0.039% + 0.2 Ω	0.039% + 2 Ω
30 kΩ	0.013% + 2 Ω	0.014% + 2 Ω	0.014% + 20 Ω	0.039% + 2 Ω	0.039% + 20 Ω
300 kΩ	0.020% + 20 Ω	0.021% + 20 Ω	0.021% + 200 Ω	0.050% + 20 Ω	0.050% + 200 Ω
3 MΩ	0.059% + 200 Ω	0.063% + 200 Ω	0.063% + 2 kΩ	0.231% + 200 Ω	0.231% + 2 kΩ
10 MΩ	0.168% + 2 kΩ	0.169% + 2 kΩ	0.709% + 20 kΩ	0.573% + 2 kΩ	0.923% + 20 kΩ

2-Wire Accuracy

Add 4.0Ω to accuracy specifications for channels 1 to 20, and add 20 mΩ for channel 0.

Lead wire resistances are not included.

Input Protection

300V dc or ac rms on all ranges

Cross-Talk Rejection

Refer to Appendix D.

Frequency Inputs

Frequency Range

15 Hz to greater than 1 Mhz

Range	Resolution		Accuracy + (% ± Hz)	
	Slow	Fast	Slow	Fast
15 Hz - 900 Hz	0.01 Hz	0.1 Hz	0.05% + 0.02 Hz	0.05% + 0.2 Hz
9 kHz	0.1 Hz	1 Hz	0.05% + 0.1 Hz	0.05% + 1 Hz
90 kHz	1 Hz	10 Hz	0.05% + 1 Hz	0.05% + 10 Hz
900 kHz	10 Hz	100 Hz	0.05% + 10 Hz	0.05% + 100 Hz
1 MHz	100 Hz	1 kHz	0.05% + 100 Hz	0.05% + 1 kHz

Sensitivity

Frequency	Level (Sine Wave)
15 Hz - 100 kHz	100 mV rms
100 kHz - 300 kHz	150 mV rms
300 kHz - 1 MHz	2 V rms
Above 1 MHz	Not specified

Maximum AC Input

300V rms or 424V peak on channels 0, 1, and 11
 150V rms or 212V peak on channels 2 to 10 and 12 to 20
 Voltage ratings between channels must not be exceeded

2×10^6 Volt-Hertz product on any range, normal mode input

1×10^6 Volt-Hertz product on any range, common mode input

Cross-Talk Rejection

Refer to Appendix D.

Typical Scanning Rate

See table below. The measurement conditions are: averaged rate over 20 scans; continuous scanning; alarm limits and Mx+B scanning set on all channels; logging data to internal memory; and RS-232 communications set at 9600 baud. Measurements were taken with short-circuit inputs on all channels, except frequency, which was taken with 5V at 15 Hz on all channels.

FUNCTION	RANGE	CHANNELS					
		SLOW			FAST		
		1	10	20	1	10	20
VDC	300 mV	1.8	3.9	4.1	2.5	13.2	18.3
	3V	1.8	3.9	4.1	2.5	13.2	18.4
	30V	1.8	3.9	4.1	2.5	13.2	18.2
	150/300V	1.8	3.9	4.1	2.5	13.2	18.1
	AUTO	1.8	3.6	3.9	2.4	11.3	14.1
TEMPERATURE	J (TC)	1.0	3.3	3.8	2.1	10.9	15.2
	PT (RTD)	1.7	3.1	3.2	2.1	6.0	6.7
VAC	300 mV	1.1	1.5	1.6	1.3	2.5	2.6
	3V	1.1	1.5	1.6	1.3	2.5	2.6
	30V	1.1	1.5	1.6	1.3	2.5	2.6
	150/300V	1.1	1.5	1.6	1.3	2.5	2.6
	AUTO	1.0	1.5	1.5	1.3	2.4	2.5
OHMS	300Ω	1.7	3.1	3.2	2.1	6.0	6.7
	3 kΩ	1.7	3.1	3.2	2.1	6.0	6.7
	30 kΩ	1.7	3.1	3.2	2.1	6.0	6.7
	300 kΩ	1.2	1.8	1.8	1.8	4.1	4.4
	3 MΩ	1.1	1.6	1.7	1.8	3.9	4.2
	10 MΩ	1.1	1.6	1.6	1.7	3.8	4.0
	AUTO	1.7	3.1	3.2	2.1	6.0	6.7
FREQUENCY	ANY	0.5	0.6	0.6	0.6	0.7	0.7

Maximum Autoranging Time

(Seconds per Channel)

Function	Range Change		Slow	Fast
VDC	300 mV	----->	150 V	0.25
150 V	300 mV	----->	0.26	0.19
VAC	300 mV	----->	150V	4.50
150 V	300 mV	----->	1.38	1.08
Ohms	300 Ω	----->	10.0 M Ω	1.30
10.0 M Ω	300 Ω	----->	1.81	0.75

Totalizing Input

Input Voltage

30V maximum
4V minimum
2V peak minimum signal

Isolation

None
dc-coupled

Threshold

1.4V

Hysteresis

500 mV

Input Debouncing

None or 1.66 ms

Rate

0 to 5 kHz with debouncing off

Maximum Count

65,535

Digital Inputs

Input Voltage

30V maximum
-4V minimum

Isolation

none
dc-coupled

Threshold

1.4V

Hysteresis

500 mV

Trigger Input**Input Voltages**

contact closure and TTL compatible
“high” = 2.0V min, 7.0V max
“low” = -0.6V min, 0.8V max

Isolation

None
dc-coupled

Minimum Pulse Width

5 μ s

Maximum Frequency

5 Hz

Specified Conditions

The instrument must be in the quiescent state, with no interval scans in process, no commands in the queue, no RS-232 or IEEE interface activity, and no front panel activity if the latency and repeatability performance is to be achieved. For addition information, refer to Chapter 5.

Maximum Latency

Latency is measured from the edge of the trigger input to the start of the first channel measurement for the Specified Conditions (above).

480 ms for fast rate, scanning DCV, ACV, ohms, and frequency only
550 ms for fast rate, scanning any thermocouple or 100 mV dc channels
440 ms for slow rate, scanning DCV, ACV, ohms, and frequency only
890 ms for slow rate, scanning any thermocouple or 100 mV dc channels

Repeatability

3 ms for the Specified Conditions (above)

Digital and Alarm Outputs

Output Logic Levels

Logical “zero”: 0.8V max for an I_{out} of -1.0 mA (1LSTTL load)
Logical “one”: 3.8V min for an I_{out} of 0.05 mA (1LSTTL load)

For non-TTL loads: 1.8V max for an I_{out} or -20 mA
Logical “zero”: 3.25 max for an I_{out} of -50 mA

Isolation

none

Real-Time Clock and Calendar

Accuracy

Within 1 minute per month for 0°C to 50°C range

Battery Life

10 years minimum for Operating Temperature range

Environmental

Warmup Time

1 hour to rated specifications

15 minutes when relative humidity is kept below the rated maximum minus 20% (e.g. below 70% for a 90% maximum rating).

Operating Temperature

0°C to 60°C

Storage Temperature

-40°C to +75°C

Instrument storage at temperature extremes may necessitate adding up to 0.008% to the dc and ac voltage accuracy specifications. Alternatively, any resulting shift can be compensated for by recalibrating the instrument.

Relative Humidity (Non-Condensing)

90% maximum for 0°C to 28°C
75% maximum for 28°C to 35°C
50% maximum for 35°C to 50°C
35% maximum for 50°C to 60°C

(Except 70% maximum for 0°C to 35°C, 30% maximum for 40°C to 50°C, and 20% maximum for 50°C to 60°C, for the 300 k Ω , 3 M Ω , and 10 M Ω ranges.)

Altitude

Operating: 2,000 m maximum
Non-operating: 12,200 m maximum

Vibration

0.7 g at 15 Hz
1.3 g at 25 Hz
3 g at 55 Hz

Shock

30 g half sine per Mil-T-28800
Bench handling per Mil-T-28800

General**Channel Capacity**

21 Analog Inputs
4 Alarm Outputs
8 Digital I/O (inputs/outputs)

Measurement Speed

Slow rate: 4 readings/second nominal
Fast rate: 17 readings/second nominal

1.5 readings/second nominal for ACV and high- Ω inputs

For additional information, refer to Typical Scanning Rate and Maximum Autoranging Time.

Memory Life

10 years minimum over Operating Temperature range
Stores: real-time clock, set-up configuration, and measurement data

Common Mode Voltage

300V dc or ac rms maximum from any analog input (channel) to earth provided that channel to channel maximum voltage ratings are observed.

Voltage Ratings

Channels 0,1, and 11 are rated at 300V dc or ac rms maximum from a channel terminal to earth and from a channel terminal to any other channel terminal.

Channels 2 to 10 and 12 to 20 are rated at 150V dc or ac rms maximum from a channel terminal to any other channel terminal within channels 2 to 10 and 12 to 20.

IEC Overvoltage Category II.

Size

9.3 cm high, 21.6 cm wide, 31.2 cm deep

Weight

Net, 2.95 kg
Shipping, 4.0 kg

Power

90V to 264V ac (no switching required), 50 and 60 Hz, 10 VA maximum

9V dc to 16V dc, 10W maximum

If both sources are applied simultaneously, ac is used if it exceeds approximately 8.3 times dc.

Automatic switchover occurs between ac and dc without interruption.

(At 120V ac the equivalent dc voltage is ~14.5V).

Standards

IEC 1010-1, ANSI/ISA S82.01-1994, CSA-C22.2 No.1010.1-92, and EN61010-1:1993.

Complies with EN 50081-1, EN 50082-1, Vfg. 243/1991 and FCC-15B at the Class B level, when shielded cables are used.

RS-232-C

Connector:	9 pin male (DB-9P)
Signals:	TX, RX, DTR, GND
Modem Control:	full duplex
Baud rates:	300, 600, 1200, 2400, 4800, and 9600
Data format:	8 data bits, no parity bit, one stop bit, or 7 data bits, one parity bit
Flow control:	XON/XOFF
Echo:	on/off

2625A Data Storage

Stores 2047 scans

Each scan includes:

- Time stamp
- Readings for all defined analog input channels
- Status of the eight digital I/O
- Totalizer count

Memory is battery-backed

Memory life: 5 years minimum at 25°C

2620A Options**IEEE-488 (Option -05k)**

Capability codes: SH1, AH1, T5, L4, SR1, RL1, PP0, DC1, DT1, E1, TE0, LE0, and C0

Complies with IEEE-488.1 standard.

Appendix B
ASCII & IEEE-488 Bus Codes

FLUKE ASCII & BUS CODES

B ⁷ B ⁶ B ⁵ BITS B ⁴ B ³ B ² B ¹ B ⁰	0 0 0 0				0 0 1 0				0 1 0 1				0 1 1 0				0 1 1 1			
	CONTROL				NUMBERS SYMBOLS				UPPER CASE				LOWER CASE							
0 0 0 0	0 NUL	8 ρ	16 SP	24 0	32 @	40 P	48 ' ,	56 p	64 NUL	72 DLE	80 SPACE	88 MLA0	96 0	104 MLA16	112 @	120 MTA0	128 P	136 MTA16		
0 0 0 1	1 SOH	9 GTL	17 DC1	25 !	33 MLA1	41 1	49 MLA17	57 A	65 MTA1	73 Q	81 MTA17	89 a	97 MSA1	105 q	113 MSA17	121	129	137		
0 0 1 0	2 STX	10 GTL	18 DC2	26 "	34 MLA2	42 2	50 MLA18	58 B	66 MTA2	74 R	82 MTA18	90 b	98 MSA2	106 r	114 MSA18	122	130	138		
0 0 1 1	3 ETX	11 DC3	19 DC3	27 #	35 MLA3	43 3	51 MLA19	59 C	67 MTA3	75 S	83 MTA19	91 c	99 MSA3	107 s	115 MSA19	123	131	139		
0 1 0 0	4 EOT	12 SDC	20 DC4	28 \$	36 MLA4	44 4	52 MLA20	60 D	68 MTA4	76 T	84 MTA20	92 d	100 MSA4	108 t	116 MSA20	124	132	140		
0 1 0 1	5 ENQ	13 PPC	21 NAK	29 %	37 MLA5	45 5	53 MLA21	61 E	69 MTA5	77 U	85 MTA21	93 e	101 MSA5	109 u	117 MSA21	125	133	141		
0 1 1 0	6 ACK	14 SYN	22 ψ	30 &	38 MLA6	46 6	54 MLA22	62 F	70 MTA6	78 V	86 MTA22	94 f	102 MSA6	110 v	118 MSA22	126	134	142		
0 1 1 1	7 BEL	15 ETB	23 ω	31 ' ,	39 MLA7	47 7	55 MLA23	63 G	71 MTA7	79 W	87 MTA23	95 g	103 MSA7	111 w	119 MSA23	127	135	143		
1 0 0 0	8 BS	16 GET	24 Ω	32 (40 MLA8	48 8	56 MLA24	64 H	72 MTA8	80 X	88 MTA24	96 h	104 MSA8	112 x	120 MSA24	128	136	144		
1 0 0 1	9 HT	17 TCT	25 √	33)	41 MLA9	49 9	57 MLA25	65 I	73 MTA9	81 Y	89 MTA25	97 i	105 MSA9	113 y	121 MSA25	129	137	145		
1 0 1 0	10 LF	18 A	26 →	34 *	42 MLA10	50 :	58 MLA26	66 J	74 MTA10	82 Z	90 MTA26	98 j	106 MSA10	114 z	122 MSA26	130	138	146		
1 0 1 1	11 VT	19 B	27 ESC	35 +	43 MLA11	51 ;	59 MLA27	67 K	75 MTA11	83 [91 MTA27	99 k	107 MSA11	115 {	123 MSA27	131	139	147		
1 1 0 0	12 FF	20 C	28 ↑	36 ,	44 MLA12	52 <	60 MLA28	68 L	76 MTA12	84 \	92 MTA28	100	108 MSA12	116 :	124 MSA28	132	140	148		
1 1 0 1	13 CR	21 D	29 ÷	37 -	45 MLA13	53 =	61 MLA29	69 M	77 MTA13	85]	93 MTA29	101 m	109 MSA13	117 }	125 MSA29	133	141	149		
1 1 1 0	14 SO	22 E	30 Σ	38 .	46 MLA14	54 >	62 MLA30	70 N	78 MTA14	86 ^	94 MTA30	102 n	110 MSA14	118 ~	126 MSA30	134	142	150		
1 1 1 1	15 SI	23 F	31 ≈	39 /	47 MLA15	55 ?	63 UNL	71 O	79 MTA15	87 —	95 UNT	103 o	111 MSA15	119 RUB-OUT	127 MSA31	135	143	151		
2 ³ 2 ² 2 ¹ 2 ⁰	ADDRESSED COMMANDS		UNIVERSAL COMMANDS		LISTEN ADDRESSES				TALK ADDRESSES				SECONDARY ADDRESSES OR COMMANDS							

KEY decimal 38 & 26 hex 1722A DISPLAY
ASCII & MLA6 

Appendix C

IEEE-488.2 Device Documentation Requirements

Introduction

Section 4.9 of the IEEE Standard 488.2-1987 states: "All devices shall supply information to the user about how the device has implemented this standard." (In this context, "device" means the Fluke 2620A Hydra Series II Data Acquisition Unit. The Fluke Hydra Series II Data Logger cannot be equipped for IEEE-488 operation.) The information in Appendix C is provided in compliance with this requirement.

Implementation of IEEE Standard 488.2-1987

Items 1-23 below correspond to the specific items of information required by Section 4.9, "Device Documentation Requirements", of the Standard. The information supplied by Fluke in response is italicized. (Throughout Appendix C, the word "Section" refers to the section[s] in the Standard, not this manual.)

1. A list of IEEE 488.2 Interface Function subsets implemented, Section 5.

IEEE-488.1 interface functions implemented in the Fluke Data Acquisition Unit are listed under "IEEE-488" capability codes in Appendix A.

2. A description of device behavior when the address is set outside the range 0-30, Section 5.2.

It is not possible to set the Fluke Data Acquisition Unit address outside the specified range.

3. A description of when a user initiated address change is recognized by the device.

An address change is recognized when set via the IEEE setup menu, which is entered by pressing COMM ([sft] [lst]). This address will be used until it is changed. The address change is recognized after ENTER is pressed to accept the address shown on the display.

4. A description of the device setting at power-on, Section 5.12. Any commands which modify the power-on settings shall also be included.

The initial power-up device setting is:

Channels 0 - 20:OFF.

Measurement rate: Slow.

Scaling (M): 1 (all channels)

Offset (B): 0 (all channels)

Alarm parameters: Limit-1 and Limit-2 OFF. All limit values 0.

Alarm assignments: Channels 0-3 assigned to outputs 0-3, respectively.

Channels 4-20 assigned to digital

I/O lines 4-7, as shown in Table 3-8.

Scan interval time: 0:00:00 (continuous)

Review values (MIN, MAX, LAST) cleared for all channels.

Digital I/O lines: high (non-alarm)

Totalizer: 0, with debounce disabled.

Autoprint/Memory Storage: OFF.

RTD R0 parameter: 100.00 (all channels)

Open Thermocouple Detection (OTC) enabled.

5. A description of message exchange options:

The size and behavior of the input buffer.

The input buffer size is 350 bytes. If the input buffer fills, the IEEE-488.1 bus will be held off until there is room in the buffer for a new byte.

Which queries return more than one <RESPONSE MESSAGE UNIT>, Section 6.4.3.

The following queries always return more than one <RESPONSE MESSAGE UNIT>:

LOG?, NEXT?, INTVL?, TIME_DATE?, PRINT_TYPE?, *IDN?, SCAN_TIME?, SCALE_MB?

The following queries may return more than one <RESPONSE MESSAGE UNIT>:

FUNC?, MIN?, MAX?, LAST?, ALARMS?, RANGE?, ALARM_LIMIT?

Which queries generate a response when parsed, Section 6.4.5.4.

All queries generate a response when parsed.

Which queries generate a response when read, Section 6.4.5.4.

No queries generate a response when read by the controller.

Which commands are coupled, Section 6.4.5.3.

No commands are coupled.

6. A list of functional elements used in constructing device-specific commands. Whether <compound command program header> elements are used must also be included, Section 7.1.1 and 7.3.3.

Device-specific commands used:

<PROGRAM MESSAGE>

<PROGRAM MESSAGE TERMINATOR>

<PROGRAM MESSAGE UNIT>
 <PROGRAM MESSAGE UNIT SEPARATOR>
 <COMMAND MESSAGE UNIT>
 <QUERY MESSAGE UNIT>
 <COMMAND PROGRAM HEADER>
 <QUERY PROGRAM HEADER>
 <PROGRAM DATA>
 <CHARACTER PROGRAM DATA>
 <DECIMAL NUMERIC PROGRAM DATA>

7. A description of any buffer size limitations related to block data, Section 7.7.6.5.
No block data is used.
8. A list of <PROGRAM DATA> elements which may appear within an <expression> as well as the maximum sub-expression nesting depth. Any additional syntax restrictions which the device may place on the <expression> shall also be included.
No sub-expressions are used. The only <PROGRAM DATA> functional elements used are <CHARACTER PROGRAM DATA> AND <DECIMAL NUMERIC PROGRAM DATA>.
9. A description of the response syntax for every query, Section 8.
 <NR1 NUMERIC RESPONSE DATA> is returned for:
**ESE?, *ESR?, *OPC?, *SRE?, *STB?, *TST?, IEE?, IER?, RATE?, RANGE?, INTVL?, TEMP_CONFIG?, MON_CHAN?, FORMAT?, ALARMS?, ALARM_ASSOC?, ALARM_DO_LEVELS?, TOTAL_DBNC?, TIME_DATE?, TRIGGER?, EEREG?, SCAN_TIME?, LOG_COUNT?, DIO_LEVELS?*
 <NR3 NUMERIC RESPONSE DATA> is returned for:
MON_VAL?, TOTAL?, RTD_R0?, MIN?, MAX?, LAST?
 <CHARACTER RESPONSE DATA> is returned for:
**IDN?, FUNC?*
The following queries return data in two formats:
ALARM_LIMIT?
Sense (HI, LO, OFF) in <CHARACTER RESPONSE DATA> Value (if HI or LO) in <NR3 NUMERIC RESPONSE DATA>
SCALE_MB?
M and B values in <NR3 NUMERIC RESPONSE DATA> Resultant display range in <NR1 NUMERIC RESPONSE DATA>
NEXT?, LOG?
Time, date, and digital I/O values in <NR1 NUMERIC RESPONSE DATA> Measurement data and Totalizer in <NR3 NUMERIC RESPONSE DATA>
10. A description of any device-to-device message transfer traffic which does not follow the rules for <RESPONSE MESSAGE> elements, Section 8.1.

There are no device-to-device messages.

11. The size of any block data responses, Section 8.7.9.4.

There are no block data responses.

12. A list of common commands and queries which are implemented, Section 10.

**CLS, *ESE, *ESE?, *ESR?, *IDN?, *OPC, *OPC?, *RST, *SRE, *SRE?, *STB?, *TRG, *TST?, *WAI*

13. A description of the state of the device after successful completion of the Calibration query, Section 10.2.

*The *CAL? command not implemented (an optional command).*

14. The maximum length of the block used to define the trigger macro, if *DDT is implemented, Section 10.4.

**DDT is not implemented.*

15. The maximum length of macro labels, the maximum length of the block used to define a macro, and how recursion is handled during macro expansion, if the macro commands are implemented, Section 10.7.

Macros are not implemented.

16. A description of the response to the identification common query, *IDN?, Section 10.14.

*The *IDN? query returns:*

FLUKE,2620A,0,M2.41 A3.7 D1.3

The version number of the main software is "M2.41", "A3.7" is the version number of the analog sub-system software, and "D1.3" is the version number of the display sub-system software.

17. The size of the protected user data storage area, *PUD, Section 10.27.

**PUD not implemented. There is no protected user data storage area.*

18. The size of the resource description, if the *RDT command or *RDT? query are implemented, Sections 10.30 and 10.31.

*The *RDT and *RDT? commands are not implemented.*

19. A description of the states affected by *RST (Section 10.32), *LRN? (Section 10.17), *RCL (Section 10.29), and *SAV (Section 10.33).

**RST restores the device to the state assumed at initial power-up, except for those items specifically forbidden by the *RST command definition. The initial power-up state is defined under item "4.", above.*

**LRN?, *RCL, and *SAV are not implemented.*

20. A description of the scope of the self-test performed by the *TST? query, Section 10.38.

** TST? performs the tests listed under "*TST?" in Table 4-8 of the User's Manual. The device reverts to the power-up state after performing these tests.*

21. A description of additional status data structures used in the device's status reporting, Section 11.

The Instrument Event Enable (IEE) register and the Instrument Event Register (IER) are described in Figure 4-4.

22. For each command, a statement describing whether is overlapped or sequential.

All commands are sequential; none are overlapped.

23. For each command, the device documentation shall specify the functional criteria that are met when an operation complete message is generated in response to that command, Section 12.8.3.

Operation complete is generated when the command is parsed.

Appendix D

Making Mixed Measurements

Introduction

This appendix augments the discussion of ac signal effects on other channels (cross talk) found in Chapter 5 ("Making Mixed Measurements"). Effects on each measurement function are discussed below. These numbers should only be considered as references. Since cross talk can be introduced into a measurement system in many places, each setup must be considered individually.

The effect of cross talk could be much better than shown for "Typical"; in extreme cases, the effect could be worse than the "Worst Case" numbers. In general, the "Worst Case" information assumes that none of the guidelines for minimizing cross talk (Chapter 5) have been followed; the "Typical" information assumes that the guidelines have been followed where reasonable.

These numbers assume that input L (low) is tied to earth ground; refer to "Using Shielded Wiring" in Chapter 5. For dc volts and thermocouple temperature measurements, a source impedance of 1 k in series with the H (high) input is assumed (except where otherwise noted.)

Signal Cross Talk in a DC Voltage Channel

$$\text{DCV Error Ratio (CTRR)} = \left[\frac{VDC(error)}{VACrms} \right]$$

Worst case	Typical	_____	_____
50, 60 Hz, ±0.1%:		1.1×10^{-7}	2.0×10^{-8}
Other Frequencies:		3.8×10^{-6}	8.6×10^{-7}

For example, to find the typical effect of a 300V ac signal at 60 Hz on another channel for the 300 mV range, you would calculate: $300 \times 2.0 \times 10^{-8} = 0.01 \text{ mV}$.

AC Signal Crosstalk Into a Temperature Channel

Frequency = 50, 60 Hz

$$\text{TEMPERATURE Error Ratio} = \left[\frac{^{\circ}\text{C}(\text{error})}{VAC_{rms}(\text{crosstalk})} \right]$$

Types J, K, E, T, N:	<u>Worst case</u>	<u>Typical</u>
	$2.7 \times 10^{-3} \left[\frac{^{\circ}\text{C}}{V_{rms}} \right]$	$5.0 \times 10^{-4} \left[\frac{^{\circ}\text{C}}{V_{rms}} \right]$
Types R, S, B, C:	$1.1 \times 10^{-2} \left[\frac{^{\circ}\text{C}}{V_{rms}} \right]$	$2.0 \times 10^{-3} \left[\frac{^{\circ}\text{C}}{V_{rms}} \right]$
Type PT (RTD):	$8.6 \times 10^{-5} \left[\frac{^{\circ}\text{C}}{V_{rms}} \right]$	<i>No Effect</i>

Appendix E

Binary Upload of Logged Data (LOG_BIN?) (2625A only)

Introduction

The LOG_BIN? <index> query can be used to quickly upload logged data from a 2625A. The response is a single ASCII string, which encodes the raw binary data stored at the specified <index> position. The logged data is also retained in the 2625A.

The measurement data returned from the 2625A is in the (binary) IEEE single-precision floating point format. Making use of this data can be difficult and is very machine dependent. A working example, using the C programming language on an IBM PC, is provided in this appendix. This example uses a pre-computed LOG_BIN? response string, and checks that the conversion process works as expected.

Two steps are required in adapting the LOG_BIN? response string for use with your computer.

- First, you must decode the ASCII string into binary data.

For example, one possible LOG_BIN? response string is:

```
LOG_BIN? 1
42@Y40BA00oo000007o0001oP000?h000
=>
```

This ASCII string represents the following binary (hex) data:

```
10 24 29 10 04 91 00 0f ff
00 00 00 00 7f c0 00 00 7f
80 00 00 3f 80 00 00 00 00
```

- Second, you must convert this binary data into valid floating point numbers for your underlying computer architecture.

Decoding the ASCII String

The ASCII response string contains six bits of raw data for each ASCII character, offset from ASCII '0' (0x30 hex, 48 decimal). Therefore, the conversion process subtracts 48 from the integer value of each character, then shifts it into place. Each set of four ASCII characters form three bytes of raw data. The number of bytes of raw data depends on the number of channels for the scan. The following C code converts a LOG_BIN? response string into a byte array:

The raw data output array contains the information listed below. Note that the number of floating point values is equal to the number of channels in use, plus one. (The totalizer count is always present in the data, and is stored as a floating point number.)

- Time stamp (BCD format)
 - byte0: hours
 - byte1: minutes
 - byte2: seconds
 - byte3: month
 - byte4: date
 - byte5: year
- Temperature units, measurement rate, and I/O
 - byte6: temperature units and rate (0x10 bit means degrees Fahrenheit, else Centigrade; 0x01 bit means fast rate, else slow rate)
 - byte7: Alarm outputs
 - byte8: Digital I/O
- Totalizer value as 32-bit single-precision IEEE floating point number stored using the byte ordering shown below. The format of this number is explained under "Floating Point Conversion".
 - byte 9: MMSB of float
 - byte 10: MLSB of float
 - byte 11: LMSB of float
 - byte 12: LLSB of float
- Measurement data; only defined channels are included (exactly like LOG?query); same floating point format, but with a wider range of values. NaN (Not a Number) is used to indicate open thermocouple, and plus or minus Inf (infinity) to indicate overload. The bit values for NaN and Inf are explained in the next section.
 - byte 13: MMSB of float
 - byte 14: MLSB of float
 - byte 15: LMSB of float
 - byte 16: LLSB of float
 - bytes 17-20: Second measurement result, if any
 - bytes 21-24: Third measurement result, if any
 -

Since the ASCII decoding (explained above) creates data multiples of three in length, it is possible that there will be one or two unused bytes at the end of the decoded byte stream.

Floating Point Conversion

ANSI/IEEE Std 754-1985, "IEEE Standard for Binary Floating-Point Arithmetic," describes the single-precision floating point format used to return measurement data. This standard defines the format for single-precision floating point as:

$$X = (-1)^s 2^{(e-127)} \times 1.m$$

where

s = sign

e = exponent

m = mantissa

The floating point format used is 32-bit with a 1-bit sign, 8-bit exponent, and 24-bit mantissa with the most significant bit hidden under the LSB of the exponent. The number is formatted as shown in Table F-1.

Table E-1. Floating Point Format

sign 1 bit	exponent 8 bits	mantissa 23 bits (plus one hidden bit)	
high byte (MMSB)	hi-mid byte (MLSB)	low mid byte (LMSB)	low byte (LLSB)

For all other measurement queries, Hydra Series II returns the string "+9E+9" for open thermocouple (OTC) measurement values. However, for the LOG_BIN?query, NaN (not a number) is returned instead. The IEEE floating point standard defines NaN as a positive, maximum exponent number with non-zero mantissa bits. Hydra Series II sets just the most significant mantissa bit, so the raw binary byte stream value is 7f c0 00 00 (hex).

For all other measurement queries, Hydra Series II usually returns $\pm 1e9$ for overload (OL) measurement values. However, for the LOG_BIN? query, Hydra Series II returns Inf (infinity) instead. The IEEE floating point standard defines Inf as a positive or negative maximum exponent number with a zero mantissa. Hydra Series II returns +Inf as the byte stream 7f 80 00 00 (hex) and -Inf as ff 80 00 00 (hex).

The C code in Figure F-2 converts raw data into a useful format for the Intel x86 (IBM PC) architecture. The BCD time stamp is converted to integers, and floating point numbers created for the totalizer and measurement values.

Example

Figure F-3 is a short example that uses the routines in Figures F-1 and F-2 to decode a fixed (pre-computed) LOG_BIN? response string.

When compiled and run on an Intel architecture computer, the program should print "Conversion worked".

Although this example is useful for educational purposes, it is not very efficient. If desired, the decoding and conversion processes can be combined into a single, fast algorithm.

```

/* Import globals from main program */
extern int timestamp[];
extern int misc[];
extern float values[];

/*
** convert(): Convert a LOG_BIN? array of binary data into useful data
**
** Converts BCD values to integer, raw floating point values into float
** values usable under the Intel x86 (IBM PC) architecture.
**
** Inputs:
**     src           Array of binary data, from LOG_BIN? query
**     length        Number of bytes in src array
**
** Outputs:
**     timestamp[]   Set to decimal timestamp values
**     misc[]         Set to temp units, rate, and digital I/O values
**     values[]       Set to floating point values found in binary data
**                    (must be room for a maximum of 22 floats)
**
*/

void
convert(src, length)
    unsigned char *src;
    int length;
{
    unsigned char *m;
    int n;

    /* Convert timestamp from BCD to decimal */
    for (n=0; n < 6; n++, src++) {
        /* Binary Coded Decimal (BCD) format, packs the upper nibble as the
*/
        /* tens digit, the lower nibble as the ones digit. Convert this
*/
        /* into an integer number.
*/
        timestamp[n] = (10 * (*src >> 4) + (*src & 0x0f));
    }

    /* Save temperature units, measurement rate, and digital I/O values */
    for (n=0; n < 3; n++) {
        misc[n] = *src++;
    }

    /* Convert raw measurement data into floating point */
    m = (unsigned char *)values;
    for (length -= 9; length > 3; length -= 4) {
#ifdef sun
        /* SunOS architecture (also works for Motorola CPUs) */
        *m++ = src[0];
        *m++ = src[1];
        *m++ = src[2];
        *m++ = src[3];
#else
        /* Assume Intel x86 architecture */
        *m++ = src[3];
        *m++ = src[2];
        *m++ = src[1];
        *m++ = src[0];
#endif
        src += 4;
    }
}

```

Figure E-2. Floating Point Conversion

```

/* Globals convert() uses for destination */
int timestamp[6];      /* Scan timestamp */
int misc[3];          /* Temperature units, measurement rate, digital I/O */
float values[22];     /* Measurement values */

extern int isnan();    /* Floating point value is NaN (not a number) */
extern int isinf();   /* Floating point value is Inf (infinity) */

/*
-* main(): LOG_BIN? query response example program
**
** Converts a hard-coded LOG_BIN? response string into usable data.
*/
main()
{
    extern int decode();      /* ASCII to binary decoding */
    extern void convert();   /* Convert Hydra binary to usable types */

    /* Canned response for three channels: channel 1 is OTC, channel 5 is */
    /* OL and channel 10 is 1.0; remaining encoded data described below */
    /* (note that you can not determine the channel number, measurement */
    /* units, or measurement range, from this string; you must keep track */
    /* of that elsewhere) */
    char *log_bin_response = "42@Y40BA00oo000007o0001oP000?h000";

    /* Place to temporarily store raw data; 100 bytes is more than enough */
    /* for any LOG_BIN? response string */
    unsigned char raw_data[100];

    /* Decode string into raw data, then convert raw data into usable data */
    convert(raw_data, decode(raw_data, log_bin_response));

    /* Above global variables now usable; check example LOG_BIN? data */
    /* against expected values */

    if ((timestamp[0] == 10) &&          /* Hours           */
        (timestamp[1] == 24) &&          /* Minutes         */
        (timestamp[2] == 29) &&          /* Seconds         */
        (timestamp[3] == 10) &&          /* Month           */
        (timestamp[4] == 4) &&           /* Day             */
        (timestamp[5] == 91) &&          /* Year            */
        (misc[0] == 0) &&                /* Temp units and rate */
        (misc[1] == 15) &&               /* Alarm outputs   */
        (misc[2] == 255) &&              /* Digital I/O     */
        (values[0] == 0.0) &&            /* Totalizer       */
        isnan(values[1]) &&              /* Channel 1 data  */
        isinf(values[2]) &&              /* Channel 5 data  */
        (values[3] == 1.0)) {            /* Channel 10 data */

        printf("Conversion worked\n");
    }
    else {
        printf("ERROR: conversion did not succeed!\n");
    }

    exit(0);
}

/* If your math library supplies alternatives to isnan() or isinf(), */
/* use them instead! */

int
isnan(f)
float f;
{
    /* This is not portable, or completely accurate (since NaN mantissa */
    /* must only be non-zero, and the sign bit can be set), but this works */
    /* for NaN values returned by Hydra */

    /* Compiler was free to promote to double */
    float ff = f;

    return ((*((unsigned long *)&ff) == 0x7fc00000L);
}

int
isinf(f)
float f;
{
    /* Again, this is not portable, but this time it is accurate */

    /* Compiler was free to promote to double */
    float ff = f;

    return ((*((unsigned long *)&ff) == 0x7f800000L) ||
            ((*((unsigned long *)&ff) == 0xff800000L);
}

```

Figure E-3. Example

Appendix F

RS-232 Cabling

Introduction

This appendix details the RS-232 cabling between the instrument and a PC, instrument controller (Fluke 17XXA series), printer, or modem. All connections can be made using the Fluke RS-series of cables (see Options and Accessories in Chapter 1). RS-232 cables should not exceed 50 feet (15 meters) although longer cables are permitted if the load capacitance measured at a connection point (including signal terminator) does not exceed 2500 picofarads. The Fluke RS cables are 6 feet (1.83 meters) in length.

Connections

Figure G-1 summarizes the cable requirements for all typical RS-232 connections; Figure G2 through G6 summarize instrument cabling diagrams; Figure G7 shows the pin arrangement for DB-9 and DB-25 connectors. There are two wiring schemes (modem and null-modem), two types of connectors (DB-9 and DB-25), two cable end conditions (male and female), and two equipment configurations (Data Terminal Equipment [DTE] and Data Communications Equipment [DCE]). Because of variations in RS-232 connectors, it is not possible to identify all possible configurations. In this application, “null-modem” refers to a reversing of the following lines; receive (RX) and transmit (TX), data terminal ready (DTR) and data set ready (DSR), and request to send (RTS) and clear to send (CTS). Not all interfaces use all lines. Check the documentation for the equipment you are interfacing with the instrument.

Cables

The Fluke RS-series of RS-232 cables are in the following standard configurations:

- RS40 - Null modem with DB-9/female and DB-25/female connectors
- RS41 - Modem with DB-9/female and DB-25/male connectors
- RS42 - Null modem with DB-9/female and DB-25/male connectors
- RS43 - Null modem with DB-9/female and DB-9/female connectors

Cables from other sources may be used, or cables can be fabricated based on the figures in this appendix. The RS40 and RS42 cables are identical, except for the DB-25 connectors (female and male, respectively). Some interfaces allow a selection of cables.

For example, connection to a serial-to-parallel converter (when using a printer with a parallel input) may be as a DTE (cable RS42) or DCE (cable RS41).

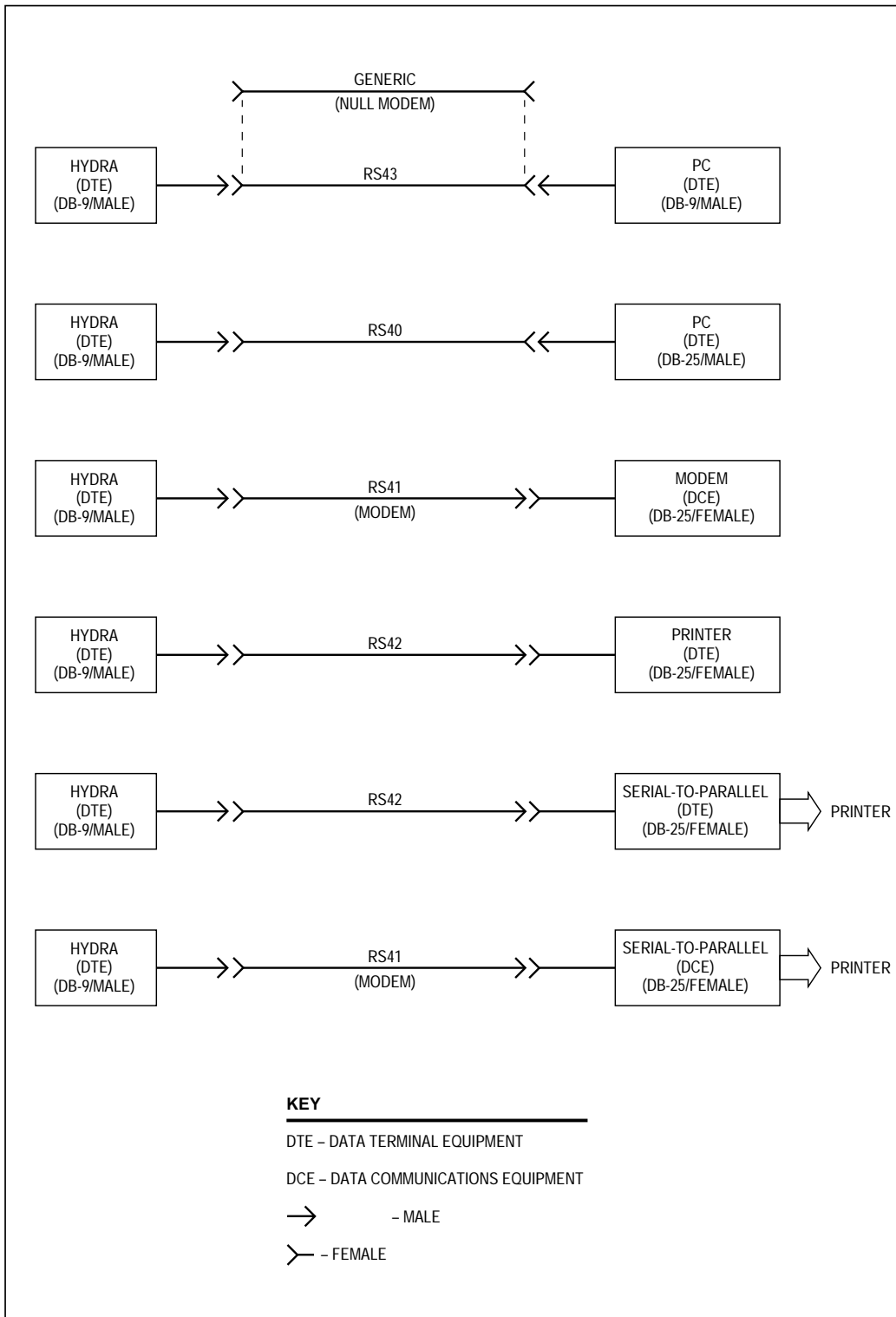
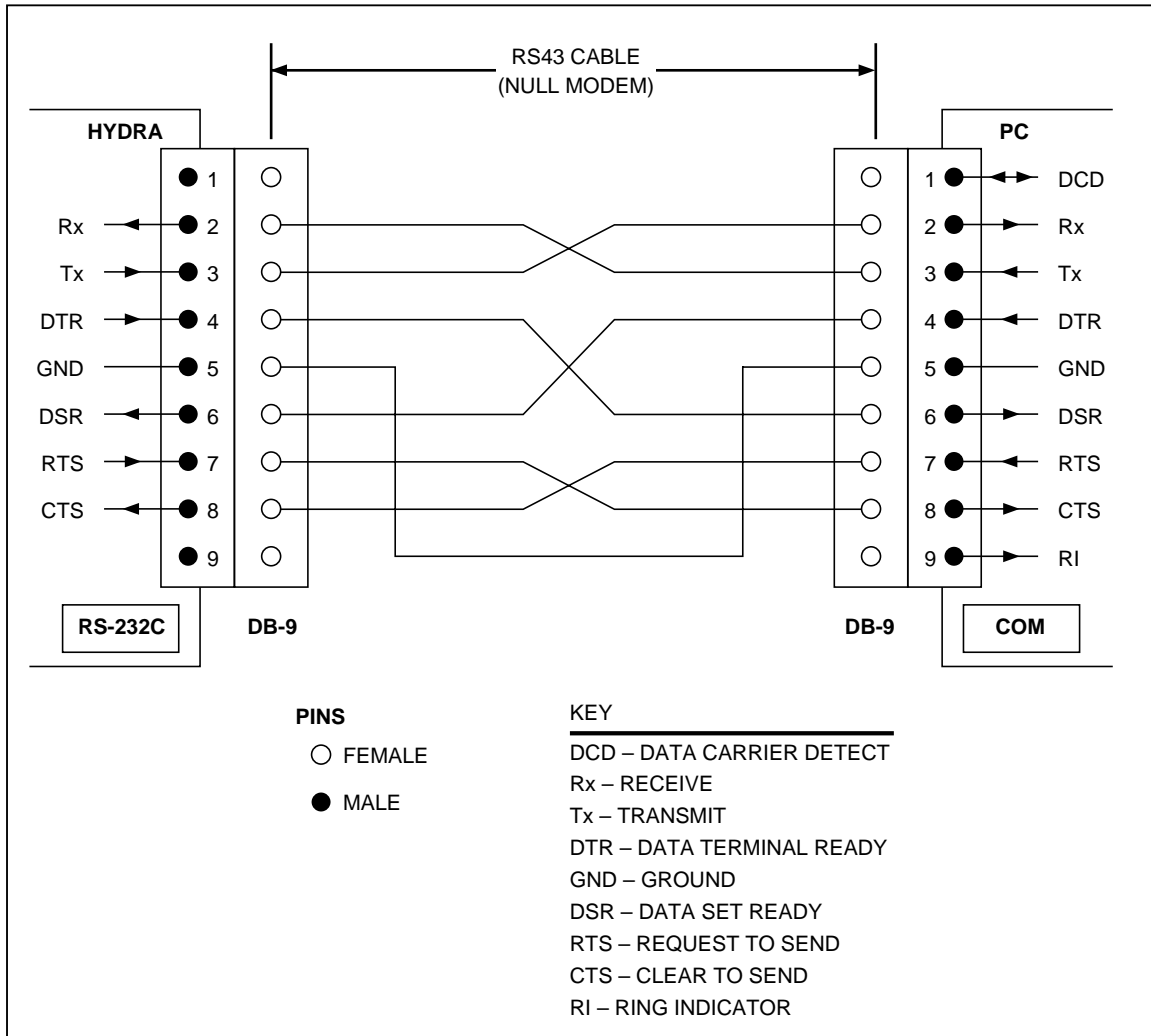

Figure F-1. Summary of RS-232 Connections

0071f.eps



oo73f.eps

Figure F-2. Hydra (DB-9) to PC (DB-9) RS-232 Connection (Generic)

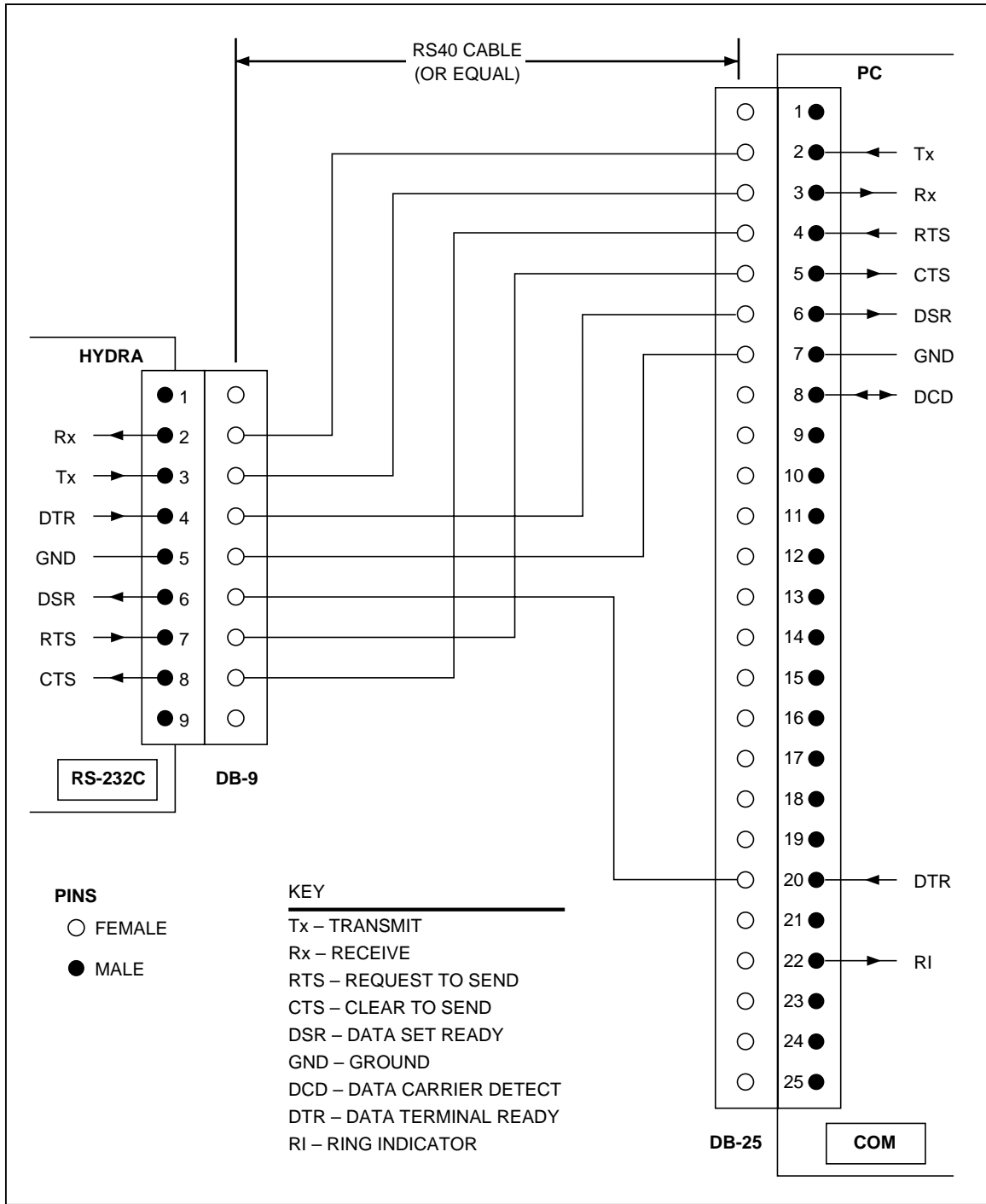

oo74f.eps

Figure F-3. Hydra (DB-9) to PC (DB-25) RS-232 Connection

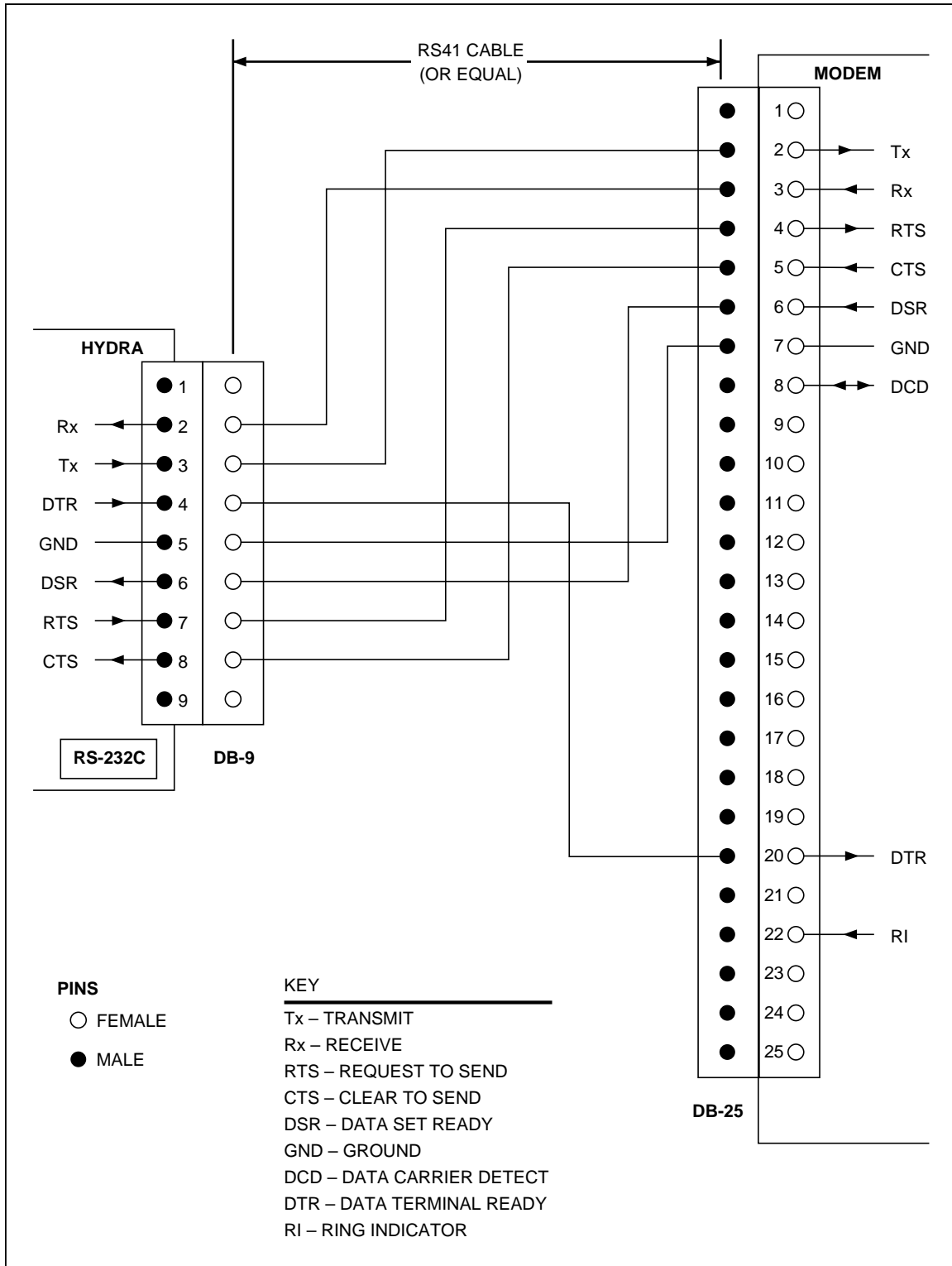

oo07f.eps

Figure F-4. Hydra (DB-9) to Modem (DB-25) RS-232 Connection

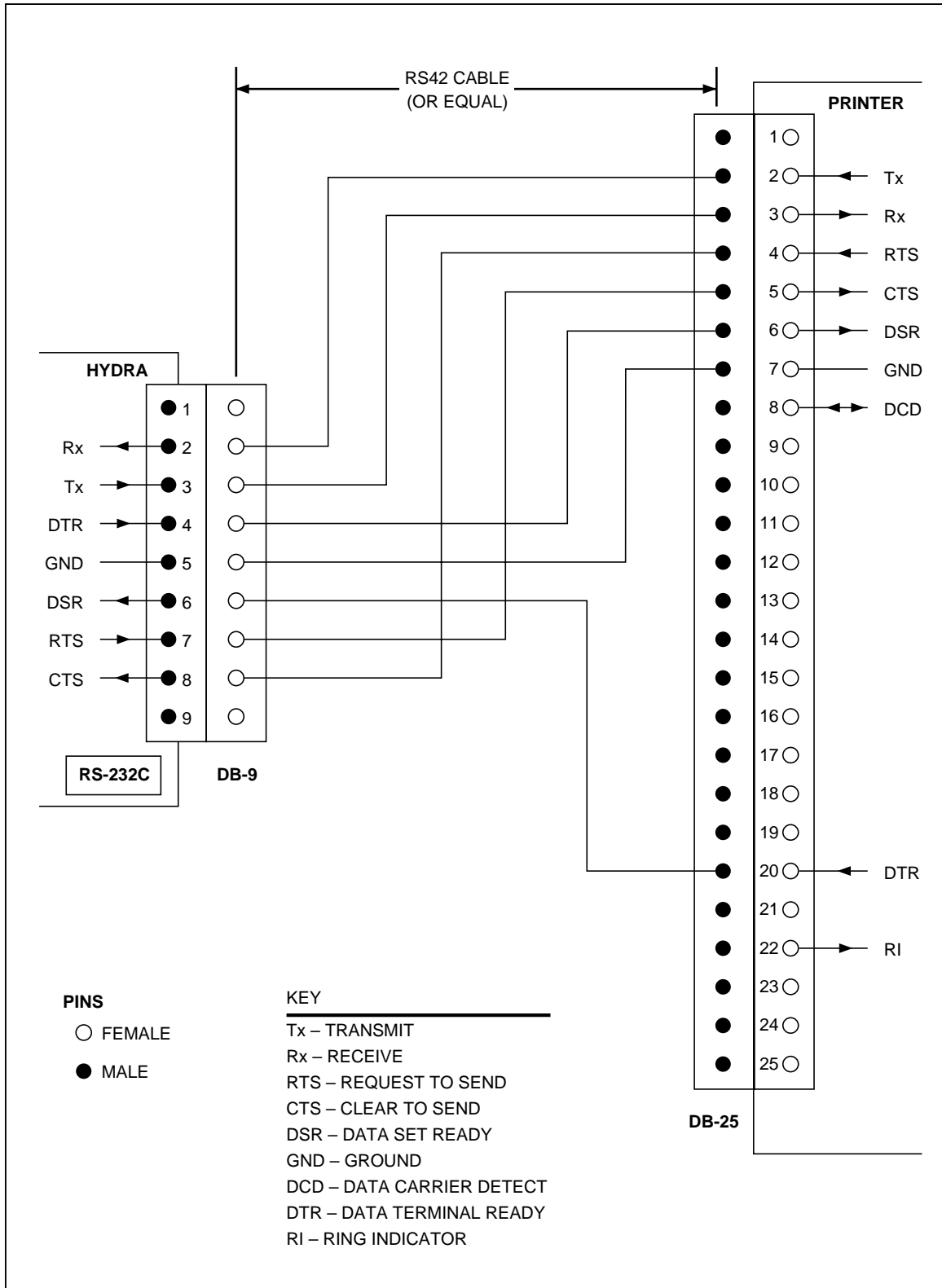

oo76f.eps

Figure F-5. Hydra (DB-9) to Printer (DB-25) RS-232 Connection

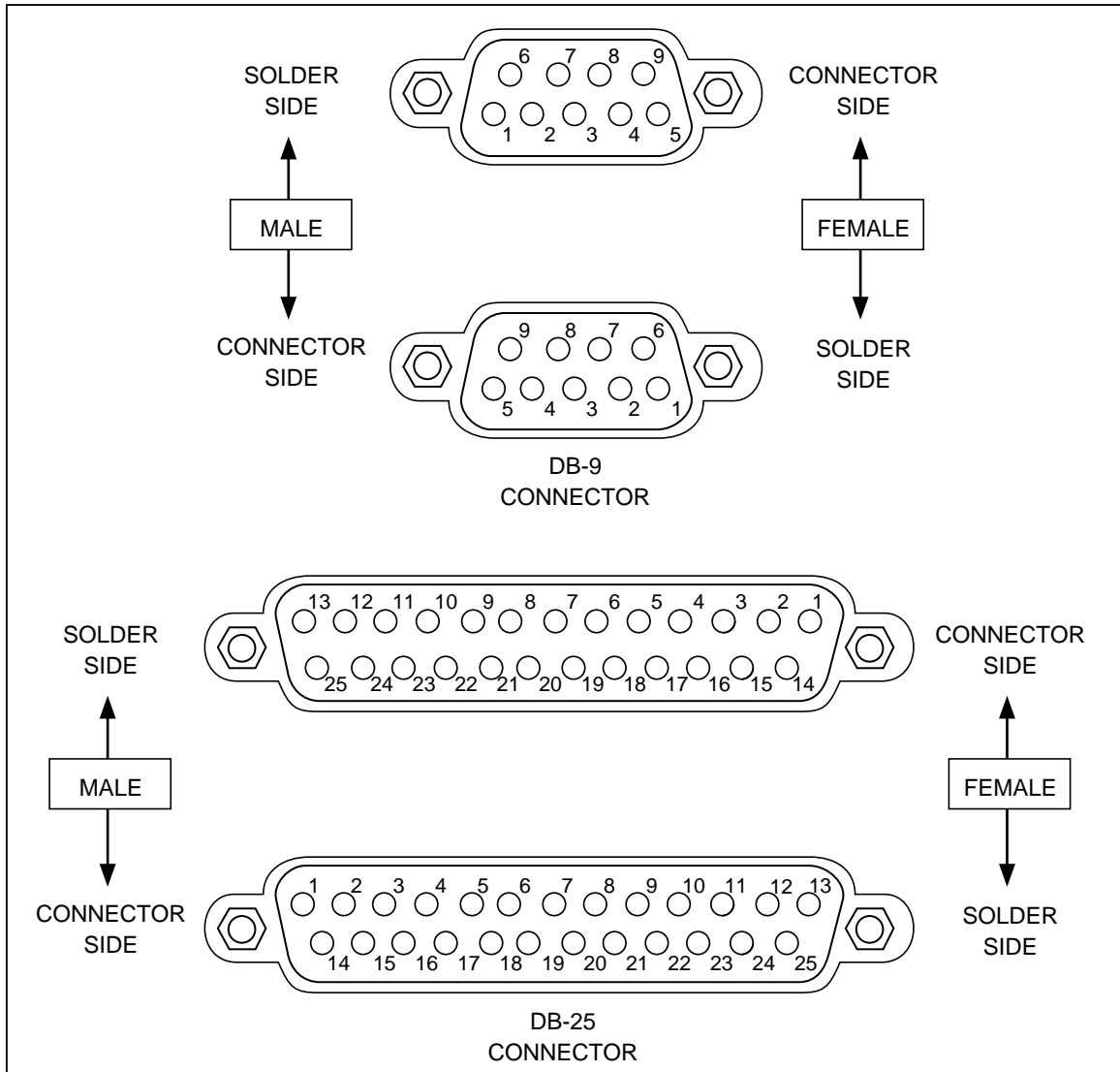

oo771.eps

Figure F-6. RS-232 DB9 and DB-25 Connectors

Index

—2—

2-wire accuracy, A-6, A-9

—4—

4-terminal resistance test, 6-10

—A—

AC signal cross talk in a dc voltage channel, D-1

AC signal cross talk into a frequency channel, D-2

AC signal cross talk into an ac voltage channel, D-2

AC signal cross talk into an ohms channel, D-2

AC signal crosstalk into a temperature channel, D-3

Accuracy verification test, 6-7

Advanced trigger mechanisms, 5-3

Alarm indications, 3-10

Alarm limits, 3-9

Autoprint, 3-25

 computer interface control, 4-5

 output format, 4-5

Autoprint and memory storage (RS-232), 4-5

—B—

Both external and monitor alarms disabled (type 0), 5-4

—C—

Cabling the instrument to a host or printer (RS-232), 4-7

Calibration, 3-27, 6-21

Changing the temperature unit, 3-16

Channel configuration, 3-4

Channel integrity test, 6-7

Character deletion, 4-8

Character echoing, 4-8

Cleaning, 6-3

Clearing memory, 4-7

Common mode rejection, A-8

Computer interface trigger control, 5-3

Computer interface-initiated lockouts, 3-27

Connections, 3-22

Cross-talk rejection, A-6

—D—

DC volts, ac volts, frequency, and thermocouples, 3-18

Decoding the ascii string, E-1

Dedicated alarm output test, 6-19

Device clear using ctrl c, 4-8

Digital input test, 6-16

Digital input/output verification tests, 6-15

Digital output test, 6-16

—E—

Enabling the IEEE-488 interface, 4-12

Entering and changing numeric values, 3-14

Example, E-4

External trigger enabled (type 1), 5-4

External trigger input test, 6-21

External triggering, 3-16

—F—

Floating point conversion, E-3

Front panel and computer interface operations, 4-3

Front panel lock out conditions, 3-26

Front panel monitor only function, 3-26

Front panel review only function, 3-26

Front panel trigger control, 5-3

—G—

General, 3-22

General information (RS-232 and IEEE-488), 4-13

—H—

How the instrument processes input, 4-13

Hysteresis, A-12

—I—

IEEE-488 operating limitations, 4-9

If power is interrupted, 3-4

If the configuration is reset, 3-4

Implementation of IEEE standard 488.2-1987, C-1

Input debouncing, A-12

Input protection, A-9

Input strings, 4-14

Input terminators, 4-14

Input voltage, A-12

Installation test, 4-8, 4-13

Installing the IEEE-488 interface, 4-9

Instrument configuration, 3-14

Isolation, A-12

—L—

Line fuse, 6-3

List button functions, 3-23

—M—

Maximum autoranging time, A-12

Measurement connections, 3-18

Measurement rate, 5-3

Memory full operation, 4-7

Memory retrieval, 4-6

Memory storage, 3-25

computer interface control, 4-6

Mx+B scaling, 3-12

—O—

Operating modes, 3-3

Other displayed data, 3-4

—P—

Performance tests, 6-4

—R—

Rate, A-12

REM annunciator, 3-27

Resetting alarm conditions, 3-11

Resistance, 3-7

Resistance and RTD, 3-20

Review array, 3-22

RS-232 information, 4-8

RS-232 prompts, 4-9

RTD temperature accuracy test, 6-14

RTD temperature accuracy test (using decade resistance source), 6-14

RTD temperature accuracy test (using DIN/IEC 751), 6-15

—S—

Sample program using the RS-232 computer interface, 4-9

Selecting scan interval, 3-15

Selecting the measurement rate, 3-15

Self-test diagnostics and error codes, 6-3

Sending numeric values to the instrument (RS-232 and IEEE-488), 4-16

Service, 6-22

Setting alarms, 3-9

Setting communication parameters (RS-232), 4-4

Setting date and time of day, 3-17

—T—

Thermocouple measurement range accuracy test, 6-9

Thermocouple temperature accuracy test, 6-11

Threshold, A-12

Totalizer sensitivity test, 6-18

Totalizer test, 6-17

Totalizing, 3-22

Totalizing input, A-12

Triggering, 3-16

Types of computer interface, 4-3

Typical input strings, 4-14

—U—

Using the digital I/O lines, 3-11

Using the IEEE-488 Interface, 4-9

Using the RS-232 computer interface, 4-3

—V—

Variations in the display, 6-22

—W—

What is the present configuration?, 3-4

Free Manuals Download Website

<http://myh66.com>

<http://usermanuals.us>

<http://www.somanuals.com>

<http://www.4manuals.cc>

<http://www.manual-lib.com>

<http://www.404manual.com>

<http://www.luxmanual.com>

<http://aubethermostatmanual.com>

Golf course search by state

<http://golfingnear.com>

Email search by domain

<http://emailbydomain.com>

Auto manuals search

<http://auto.somanuals.com>

TV manuals search

<http://tv.somanuals.com>