

**FLUKE®**

# **80 Series III**

Multimeters

Users Manual

October 1997 Rev.5, 12/03

©1997-2003 Fluke Corporation, All rights reserved.

All product names are trademarks of their respective companies.

## Lifetime Limited Warranty

Each Fluke 20, 70, 80, 170 and 180 Series DMM will be free from defects in material and workmanship for its lifetime. As used herein, "lifetime" is defined as seven years after Fluke discontinues manufacturing the product, but the warranty period shall be at least ten years from the date of purchase. This warranty does not cover fuses, disposable batteries, damage from neglect, misuse, contamination, alteration, accident or abnormal conditions of operation or handling, including failures caused by use outside of the product's specifications, or normal wear and tear of mechanical components. This warranty covers the original purchaser only and is not transferable.

For ten years from the date of purchase, this warranty also covers the LCD. Thereafter, for the lifetime of the DMM, Fluke will replace the LCD for a fee based on then current component acquisition costs.

To establish original ownership and prove date of purchase, please complete and return the registration card accompanying the product, or register your product on <http://www.fluke.com>. Fluke will, at its option, repair at no charge, replace or refund the purchase price of a defective product purchased through a Fluke authorized sales outlet and at the applicable international price. Fluke reserves the right to charge for importation costs of repair/replacement parts if the product purchased in one country is sent for repair elsewhere.

If the product is defective, contact your nearest Fluke authorized service center to obtain return authorization information, then send the product to that service center, with a description of the difficulty, postage and insurance prepaid (FOB Destination). Fluke assumes no risk for damage in transit. Fluke will pay return transportation for product repaired or replaced in-warranty. Before making any non-warranty repair, Fluke will estimate cost and obtain authorization, then invoice you for repair and return transportation.

THIS WARRANTY IS YOUR ONLY REMEDY. NO OTHER WARRANTIES, SUCH AS FITNESS FOR A PARTICULAR PURPOSE, ARE EXPRESSED OR IMPLIED. FLUKE SHALL NOT BE LIABLE FOR ANY SPECIAL, INDIRECT, INCIDENTAL OR CONSEQUENTIAL DAMAGES OR LOSSES, INCLUDING LOSS OF DATA, ARISING FROM ANY CAUSE OR THEORY. AUTHORIZED RESELLERS ARE NOT AUTHORIZED TO EXTEND ANY DIFFERENT WARRANTY ON FLUKE'S BEHALF. Since some states do not allow the exclusion or limitation of an implied warranty or of incidental or consequential damages, this limitation of liability may not apply to you. If any provision of this warranty is held invalid or unenforceable by a court or other decision-maker of competent jurisdiction, such holding will not affect the validity or enforceability of any other provision.

Fluke Corporation  
P.O. Box 9090  
Everett WA  
98206-9090

Fluke Europe B.V.  
P.O. Box 1186  
5602 B.D. Eindhoven  
The Netherlands

# Table of Contents

Title	Page
Introduction.....	1
Safety Information .....	1
Your Meter's Features .....	4
Power-Up Options .....	11
Automatic Power-Off.....	11
Input Alert™ Feature .....	12
Making Measurements .....	12
Measuring AC and DC Voltage.....	12
Testing for Continuity.....	14
Measuring Resistance .....	16
Using Conductance for High Resistance or Leakage Tests .....	18
Measuring Capacitance .....	18
Testing Diodes.....	21
Measuring AC or DC Current.....	22
Measuring Frequency.....	25
Measuring Duty Cycle.....	27
Determining Pulse Width .....	28

Analog Bar Graph .....	28
Model 87 Bar Graph.....	28
Models 83 and 85 Bar Graph .....	29
4-1/2 Digit Mode (Model 87) .....	29
MIN MAX Recording Mode .....	30
Touch Hold <sup>®</sup> Mode .....	32
Relative Mode .....	32
Zoom Mode (Models 83 and 85) .....	32
Uses for the Zoom Mode (Models 83 and 85).....	33
Maintenance .....	33
General Maintenance.....	33
Testing the Fuses.....	34
Replacing the Battery.....	35
Replacing the Fuses .....	35
Service and Parts.....	36
Specifications.....	41

# List of Tables

Table	Title	Page
1.	International Electrical Symbols .....	2
2.	Inputs .....	4
3.	Rotary Switch Positions .....	5
4.	Pushbuttons .....	6
5.	Display Features .....	9
6.	Estimating Capacitance Values Over 5 Microfarads .....	20
7.	Functions and Trigger Levels for Frequency Measurements .....	26
8.	MIN MAX Functions .....	31
9.	Replacement Parts.....	38
10.	Accessories.....	40
11.	Models 85 and 87 AC Voltage Function Specifications.....	42
12.	Model 83 AC Voltage Function Specifications .....	43
13.	DC Voltage, Resistance, and Conductance Function Specifications .....	44
14.	Current Function Specifications .....	45
15.	Capacitance and Diode Function Specifications .....	47
16.	Frequency Counter Specifications .....	47
17.	Frequency Counter Sensitivity and Trigger Levels.....	48
18.	Electrical Characteristics of the Terminals .....	49
19.	MIN MAX Recording Specifications .....	50



# *List of Figures*

<b>Figure</b>	<b>Title</b>	<b>Page</b>
1.	Display Features (Model 87 Shown).....	8
2.	Measuring AC and DC Voltage.....	13
3.	Testing for Continuity.....	15
4.	Measuring Resistance.....	17
5.	Measuring Capacitance.....	19
6.	Testing a Diode.....	21
7.	Measuring Current.....	23
8.	Components of Duty Cycle Measurements.....	27
9.	Testing the Current Fuses.....	34
10.	Battery and Fuse Replacement.....	37
11.	Replaceable Parts.....	39





## Introduction

### **Warning**

**Read "Safety Information" before you use the meter.**

Except where noted, the descriptions and instructions in this manual apply to Series III Models 83, 85, 87, and 87/E multimeters. Model 87 is shown in all illustrations.

### **Safety Information**

This meter complies with:

- EN61010.1:1993
- ANSI/ISA S82.01-1994
- CAN/CSA C22.2 No. 1010.1-92
- 1000 V Overvoltage Category III, Pollution Degree 2
- UL3111-1

Use the meter only as specified in this manual, otherwise the protection provided by the meter may be impaired.

In this manual, a **Warning** identifies conditions and actions that pose hazards to the user. A **Caution** identifies conditions and actions that may damage the meter or the equipment under test.











International symbols used on the meter and in this manual are explained in Table 1.

### **Warning**

**To avoid possible electric shock or personal injury, follow these guidelines:**

- **Do not use the meter if it is damaged. Before you use the meter, inspect the case. Look for cracks or missing plastic. Pay particular attention to the insulation surrounding the connectors.**
- **Make sure the battery door is closed and latched before you operate the meter.**
- **Replace the battery as soon as the battery indicator () appears.**

**Table 1. International Electrical Symbols**

	AC (Alternating Current)		Earth ground
	DC (Direct Current)		Fuse
	AC or DC		Conforms to European Union directives
	Refer to the manual for information about this feature.		Conforms to relevant Canadian Standards Association directives
	Battery		Double insulated
	Inspected and licensed by TÜV Product Services.		

- **Remove test leads from the meter before you open the battery door.**
- **Inspect the test leads for damaged insulation or exposed metal. Check the test leads for continuity. Replace damaged test leads before you use the meter.**
- **Do not use the meter if it operates abnormally. Protection may be impaired. When in doubt, have the meter serviced.**
- **Do not operate the meter around explosive gas, vapor, or dust.**
- **Use only a single 9 V battery, properly installed in the meter case, to power the meter.**
- **When servicing the meter, use only specified replacement parts.**

### **Caution**

**To avoid possible damage to the meter or to the equipment under test, follow these guidelines:**

- **Disconnect circuit power and discharge all high-voltage capacitors before testing resistance, continuity, diodes, or capacitance.**
- **Use the proper terminals, function, and range for your measurements.**
- **Before measuring current, check the meter's fuses. (See "Testing the Fuses".)**

To protect yourself, use the following guidelines:

- Use caution when working with voltages above 30 V ac rms, 42 V ac peak, or 60 V dc. Such voltages pose a shock hazard.
- When using the probes, keep your fingers behind the finger guards.
- Connect the common test lead before you connect the live test lead. When you disconnect test leads, disconnect the live test lead first.
- Avoid working alone.
- When measuring current, turn off circuit power before connecting the meter in the circuit. Remember to place the meter in series with the circuit.

### **Your Meter's Features**

Tables 2 through 5 briefly describe your meter's features and give page numbers where you can find more detailed information about the features.

**Table 2. Inputs**

<b>Terminal</b>	<b>Description</b>	<b>Page</b>
<b>A</b>	Input for 0 A to 10.00 A current measurements	22
<b>mA <math>\mu</math>A</b>	Input for 0 $\mu$ A to 400 mA current measurements	22
<b>COM</b>	Return terminal for all measurements	NA
<b>V <math>\Omega</math> <math>\rightarrow</math></b>	Input for voltage, continuity, resistance, diode, capacitance, frequency, and duty cycle measurements	V: 12 $\Omega$ : 16 $\rightarrow$ : 21 $\rightarrow$ : 18 Frequency: 25 Duty cycle: 27

Table 3. Rotary Switch Positions

Switch Position	Function	Page
$\tilde{V}$	AC voltage measurement	12
$\bar{V}$	DC voltage measurement	12
$\bar{mV}$	400 mV dc voltage range	12
))) $\Omega$ - $\text{+}$	))) Continuity test	14
	$\Omega$ Resistance measurement	16
	- $\text{+}$ Capacitance measurement	18
$\text{+}$	Diode test	21
mA A	DC or AC current measurements from 0 mA to 10.00 A	22
$\mu\text{A}$	DC or AC current measurements from 0 $\mu\text{A}$ to 4000 $\mu\text{A}$	22

**Table 4. Pushbuttons**











Button	Function	Button Function	Page
 (Blue button)		Selects capacitance.	18
	mA/A, $\mu$ A	Switches between dc and ac current.	22
	Power-up	Disables automatic power-off feature.	11
	Any switch position	Starts recording of minimum and maximum values. Steps the display through MIN, MAX, AVG (average), and present readings.	30
	Power-up	Enables high-accuracy 1-second response time for MIN MAX recording.	30
	Any switch position	Switches between the ranges available for the selected function. To return to autoranging, hold the button down for 1 second.  Manually selecting a range causes the meter to exit the Touch Hold <sup>®</sup> , MIN MAX, and REL (relative) modes.	See ranges in specifications.
	Power-up	For servicing purposes only.	NA
	Any switch position	Touch Hold captures the present reading on the display. When a new, stable reading is detected, the meter beeps and displays the new reading.	32
	MIN MAX recording	Stops and starts recording without erasing recorded values.	30
	Frequency counter	Stops and starts the frequency counter.	25

Table 4. Pushbuttons (cont)

Button	Function	Button Function	Page
 Model 87: yellow button   Models 83, 85: gray button	Any switch position	<p>Turns the backlight on and off.</p> <p>For Model 87, hold the yellow button down for one second to enter the 4-1/2 digit mode. To return to the 3-1/2 digit mode, hold the button down only until all display segments turn on (about one second).</p>	<p>NA</p> <p>29</p>
	Continuity  MIN MAX recording Power-up	<p>Turns the continuity beeper on and off.</p> <p>On Model 87, switches between 250 <math>\mu</math>s and 100 ms or 1 s response times.</p> <p>Disables the beeper for all functions.</p>	<p>14</p> <p>30</p> <p>NA</p>
 (Relative mode)	Any switch position Power-up	<p>Stores the present reading as a reference for subsequent readings. The display is zeroed, and the stored reading is subtracted from all subsequent readings.</p> <p>For Models 83 and 85, enables zoom mode for the bar graph.</p>	<p>32</p> <p>32</p>
 Hz	Any switch position Power-up	<p>Starts the frequency counter.</p> <p>Press again to enter duty cycle mode.</p> <p>Provides &gt;4000 M<math>\Omega</math> input impedance for the 400 mV dc range.</p>	<p>25</p> <p>27</p> <p>NA</p>

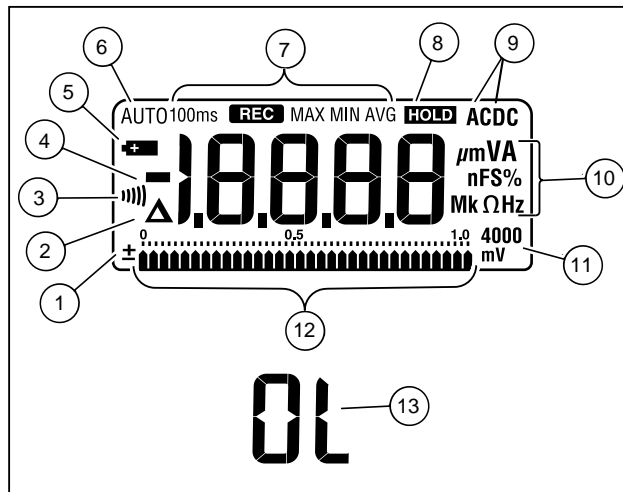





Figure 1. Display Features (Model 87 Shown)

iy1f.eps



Table 5. Display Features

Number	Feature	Indication	Page
①	±	Polarity indicator for the analog bar graph.	28
②	△	Relative (REL) mode is active.	32
③	)	The continuity beeper is on.	14
④	—	Indicates negative readings. In relative mode, this sign indicates that the present input is less than the stored reference.	32
⑤		The battery is low. <b>⚠ Warning: To avoid false readings, which could lead to possible electric shock or personal injury, replace the battery as soon as the battery indicator appears.</b>	35
⑥	<b>AUTO</b>	The meter is in autorange mode and automatically selects the range with the best resolution.	NA
⑦	100 ms  MAX MIN AVG	Indicators for minimum-maximum recording mode.	30
⑧		Touch Hold is active.	32
⑨	<b>AC DC</b>	Indicator for ac or dc voltage or current. AC voltage and current is displayed as an rms (root mean square) value.	12, 22

**Table 5. Display Features (continued)**

Number	Feature	Indication	Page
⑩	<b>A, <math>\mu</math>A, mA</b>	A: Amperes (amps). The unit of current. $\mu$ A: Microamp. $1 \times 10^{-6}$ or 0.000001 amperes. mA: Milliamp. $1 \times 10^{-3}$ or 0.001 amperes.	22
	<b>V, mV</b>	V: Volts. The unit of voltage. mV: Millivolt. $1 \times 10^{-3}$ or 0.001 volts.	12
	<b><math>\mu</math>F, nF</b>	F: Farad. The unit of capacitance. $\mu$ F: Microfarad. $1 \times 10^{-6}$ or 0.000001 farads. nF: Nanofarad. $1 \times 10^{-9}$ or 0.000000001 farads.	18
	<b>nS</b>	S: Siemen. The unit of conductance. nS: Nanosiemen. $1 \times 10^{-9}$ or 0.000000001 siemens.	18
	<b>%</b>	Percent. Used for duty cycle measurements.	27
	<b><math>\Omega</math>, M<math>\Omega</math>, k<math>\Omega</math></b>	$\Omega$ : Ohm. The unit of resistance. M $\Omega$ : Megohm. $1 \times 10^6$ or 1,000,000 ohms. k $\Omega$ : Kilohm. $1 \times 10^3$ or 1000 ohms.	16
	<b>Hz, kHz, MHz</b>	Hz: Hertz. The unit of frequency. kHz: Kilohertz. $1 \times 10^3$ or 1000 hertz. MHz: Megahertz. $1 \times 10^6$ or 1,000,000 hertz.	25

Table 5. Display Features (continued)

Number	Feature	Indication	Page
⑪	<b>4000 mV</b>	Displays the currently selected range.	See specifications for ranges for each function.
⑫	Analog bar graph	Provides an analog indication of the present inputs.	28
⑬	<b>OL</b>	The input (or the relative value when in relative mode) is too large for the selected range. For duty cycle measurements OL is displayed when the input signal stays high or low.	Duty cycle: 27

**Power-Up Options**

Holding a button down while turning the meter on activates a power-up option. Table 4 includes the power-up options available. These options are also listed on the back of the meter.

**Automatic Power-Off**

The meter automatically turns off if you do not turn the rotary switch or press a button for 30 minutes. To disable automatic power-off, hold down the blue button while turning the meter on. Automatic power-off is always disabled in MIN MAX recording mode.

### **Input Alert™ Feature**

If a test lead is plugged into the **mA/μA** or **A** terminal, but the rotary switch is not correctly set to the **mA/μA** or **A** position, the beeper warns you by making a chirping sound. This warning is intended to stop you from attempting to measure voltage, continuity, resistance, capacitance, or diode values when the leads are plugged into a current terminal. *Placing the probes across (in parallel with) a powered circuit when a lead is plugged into a current terminal can damage the circuit you are testing and blow the meter's fuse.* This can happen because the resistance through the meter's current terminals is very low, so the meter acts like a short circuit.

### **Making Measurements**

The following sections describe how to take measurements with your meter.

### **Measuring AC and DC Voltage**

Voltage is the difference in electrical potential between two points. The polarity of ac (alternating current) voltage varies over time, while the polarity of dc (direct current) voltage is constant over time. The meter presents ac voltage values as rms (root mean square) readings. The rms value is the equivalent dc voltage that would produce the same amount of heat in a resistance as the measured sinewave voltage. Models 85 and 87 feature true rms readings, which are accurate for other wave forms (with no dc offset) such as square waves, triangle waves, and staircase waves.

The meter's voltage ranges are 400 mV, 4 V, 40 V, 400 V, and 1000 V. To select the 400 mV dc range, turn the rotary switch to mV.

To measure ac or dc voltage, set up and connect the meter as shown in Figure 2.

The following are some tips for measuring voltage:

- When you measure voltage, the meter acts approximately like a  $10\text{ M}\Omega$  ( $10,000,000\ \Omega$ ) impedance in parallel with the circuit. This loading effect can cause measurement errors in high-impedance circuits. In most cases, the error is negligible (0.1% or less) if the circuit impedance is  $10\text{ k}\Omega$  ( $10,000\ \Omega$ ) or less.
- For better accuracy when measuring the dc offset of an ac voltage, measure the ac voltage first. Note the ac voltage range, then manually select a dc voltage range equal to or higher than the ac range. This procedure improves the accuracy of the dc measurement by ensuring that the input protection circuits are not activated.

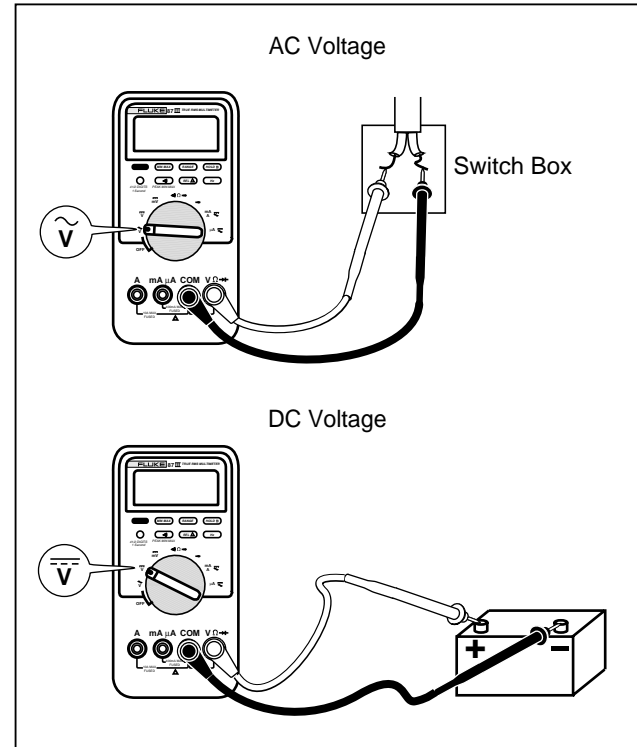

ly2f.eps

Figure 2. Measuring AC and DC Voltage

## ***Testing for Continuity***

### **Caution**

**To avoid possible damage to the meter or to the equipment under test, disconnect circuit power and discharge all high-voltage capacitors before testing for continuity.**

Continuity is the presence of a complete path for current flow. The continuity test features a beeper that sounds if a circuit is complete. The beeper allows you to perform quick continuity tests without having to watch the display.

To test for continuity, set up the meter as shown in Figure 3.

Press  to turn the continuity beeper on or off.

The continuity function detects intermittent opens and shorts lasting as little as 1 millisecond (0.001 second). These brief contacts cause the meter to emit a short beep.

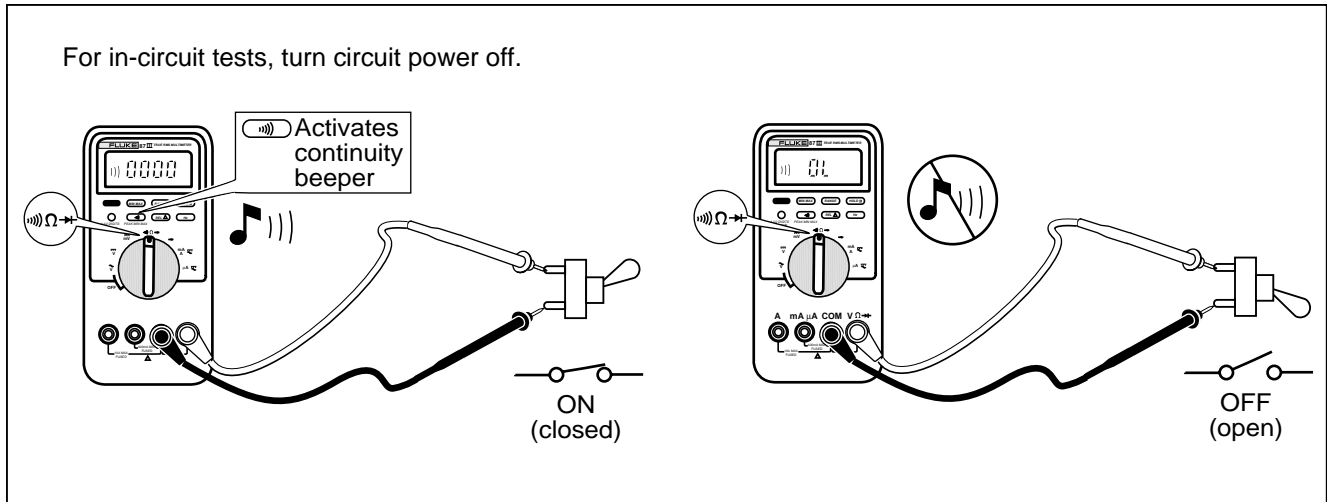

iy4f.eps

Figure 3. Testing for Continuity

## **Measuring Resistance**

### **Caution**

**To avoid possible damage to the meter or to the equipment under test, disconnect circuit power and discharge all high-voltage capacitors before measuring resistance.**

Resistance is an opposition to current flow. The unit of resistance is the ohm ( $\Omega$ ). The meter measures resistance by sending a small current through the circuit. Because this current flows through all possible paths between the probes, the resistance reading represents the total resistance of all paths between the probes.

The meter's resistance ranges are 400  $\Omega$ , 4 k $\Omega$ , 40 k $\Omega$ , 400 k $\Omega$ , 4 M $\Omega$ , and 40 M $\Omega$ .

To measure resistance, set up the meter as shown in Figure 4.

The following are some tips for measuring resistance:

- Because the meter's test current flows through all possible paths between the probe tips, the measured value of a resistor in a circuit is often different from the resistor's rated value.
- The test leads can add 0.1  $\Omega$  to 0.2  $\Omega$  of error to resistance measurements. To test the leads, touch the probe tips together and read the resistance of the leads. If necessary, you can use the relative (REL) mode to automatically subtract this value.
- The resistance function can produce enough voltage to forward-bias silicon diode or transistor junctions, causing them to conduct. To avoid this, do not use the 40 M $\Omega$  range for in-circuit resistance measurements.



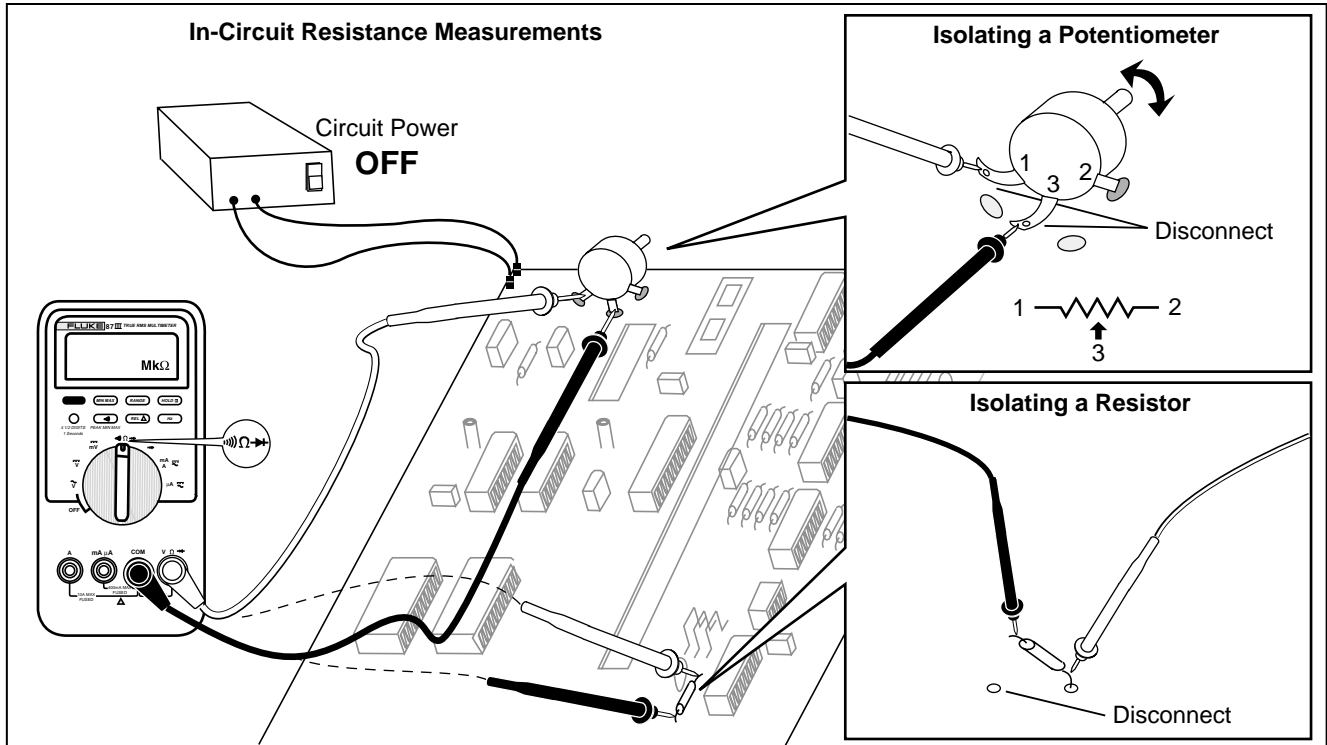

Figure 4. Measuring Resistance

iy6f.eps

### **Using Conductance for High Resistance or Leakage Tests**

Conductance, the inverse of resistance, is the ability of a circuit to pass current. High values of conductance correspond to low values of resistance.

The unit of conductance is the Siemen (S). The meter's 40 nS range measures conductance in nanosiemens (1 nS = 0.000000001 Siemens). Because such small amounts of conductance correspond to extremely high resistance, the nS range lets you determine the resistance of components up to 100,000 M $\Omega$ , or 100,000,000,000  $\Omega$  (1/1 nS = 1,000 M $\Omega$ ).

To measure conductance, set up the meter as shown for measuring resistance (Figure 4); then press **(RANGE)** until the nS indicator appears on the display.

The following are some tips for measuring conductance:

- High-resistance readings are susceptible to electrical noise. To smooth out most noisy readings, enter the MIN MAX recording mode; then scroll to the average (AVG) reading.
- There is normally a residual conductance reading with the test leads open. To ensure accurate readings, use the relative (REL) mode to subtract the residual value.

### **Measuring Capacitance**

#### **Caution**

**To avoid possible damage to the meter or to the equipment under test, disconnect circuit power and discharge all high-voltage capacitors before measuring capacitance. Use the dc voltage function to confirm that the capacitor is discharged.**

Capacitance is the ability of a component to store an electrical charge. The unit of capacitance is the farad (F). Most capacitors are in the nanofarad to microfarad range.

The meter measures capacitance by charging the capacitor with a known current for a known period of time, measuring the resulting voltage, then calculating the capacitance. The measurement takes about 1 second per range. The capacitor charge can be up to 1.2 V.

The meter's capacitance ranges are 5 nF, 0.05  $\mu$ F, 0.5  $\mu$ F, and 5  $\mu$ F.

To measure capacitance, set up the meter as shown in Figure 5.

The following are some tips for measuring capacitance:

- To speed up measurements of similar values, press **RANGE** to manually select the proper range.
- To improve the accuracy of measurements less than 5 nF, use the relative (REL) mode to subtract the residual capacitance of the meter and leads.

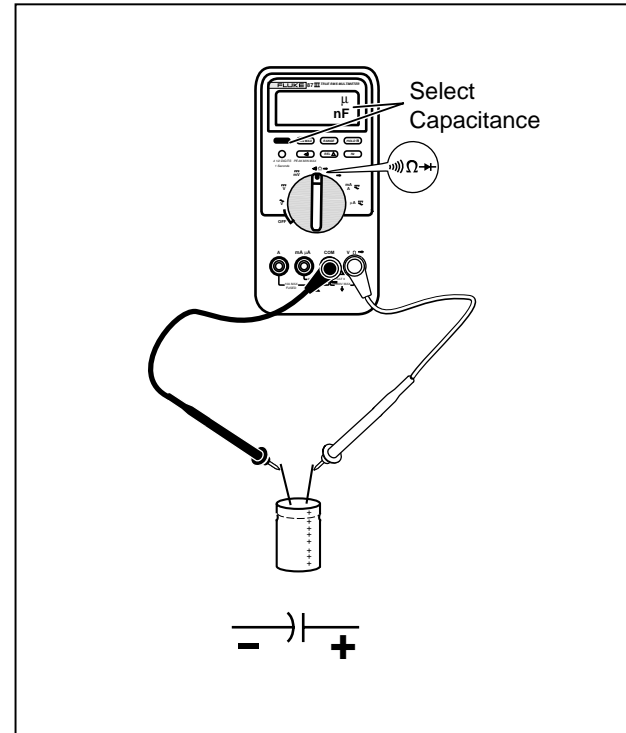

Figure 5. Measuring Capacitance

iy10f.eps

- To estimate capacitance values above 5  $\mu\text{F}$ , use the current supplied by the meter's resistance function, as follows:
  1. Set up the meter to measure resistance.
  2. Press **RANGE** to select a range based on the value of capacitance you expect to measure (refer to Table 6.)
  3. Discharge the capacitor.
  4. Place the meter's leads across the capacitor; then time how long it takes for the display to reach OL.
  5. Multiply the charge time from step 4 by the appropriate value in the  **$\mu\text{F}/\text{second of Charge Time}$**  column in 6. The result is the estimated capacitance value in microfarads ( $\mu\text{F}$ ).

**Table 6. Estimating Capacitance Values Over 5 Microfarads**

<b>Expected Capacitance</b>	<b>Suggested Range*</b>	<b><math>\mu\text{F}/\text{second of Charge Time}</math></b>
Up to 10 $\mu\text{F}$	4 $\text{M}\Omega$	0.3
11 $\mu\text{F}$ to 100 $\mu\text{F}$	400 $\text{k}\Omega$	3
101 $\mu\text{F}$ to 1000 $\mu\text{F}$	40 $\text{k}\Omega$	30
1001 $\mu\text{F}$ to 10,000 $\mu\text{F}$	4 $\text{k}\Omega$	300
10,000 $\mu\text{F}$ to 100,000 $\mu\text{F}$	400 $\Omega$	3000
*These ranges keep the full-charge time between 3.7 seconds and 33.3 seconds for the expected capacitance values. If the capacitor charges too quickly for you to time, select the next higher resistance range.		

## Testing Diodes

### Caution

**To avoid possible damage to the meter or to the equipment under test, disconnect circuit power and discharge all high-voltage capacitors before testing diodes.**

Use the diode test to check diodes, transistors, silicon controlled rectifiers (SCRs), and other semiconductor devices. This function tests a semiconductor junction by sending a current through the junction, then measuring the junction's voltage drop. A good silicon junction drops between 0.5 V and 0.8 V.

To test a diode out of a circuit, set up the meter as shown in Figure 6. For forward-bias readings on any semiconductor component, place the red test lead on the component's positive terminal and place the black lead on the component's negative terminal.

In a circuit, a good diode should still produce a forward-bias reading of 0.5 V to 0.8 V; however, the reverse-bias reading can vary depending on the resistance of other pathways between the probe tips.

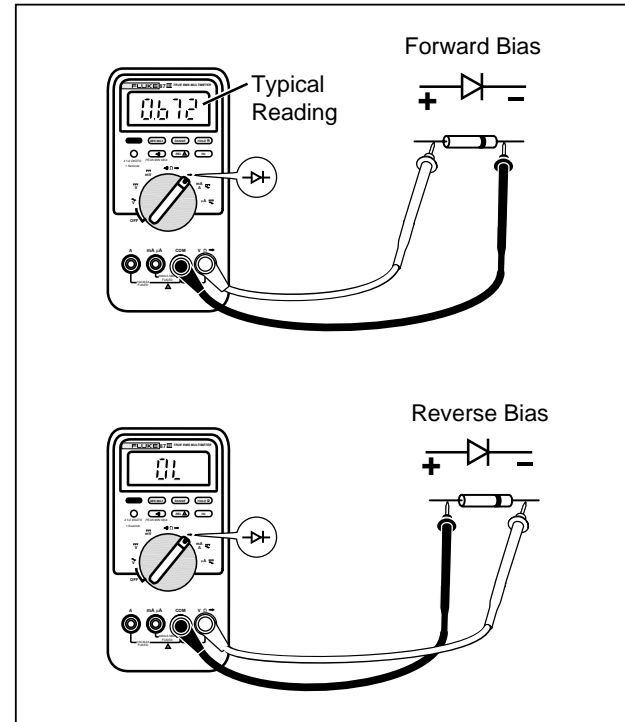

Figure 6. Testing a Diode

iy9f.eps

## Measuring AC or DC Current

### **⚠ Warning**

**Never attempt an in-circuit current measurement where the open-circuit potential to earth is greater than 1000 V. You may damage the meter or be injured if the fuse blows during such a measurement.**

### **Caution**

**To avoid possible damage to the meter or to the equipment under test, check the meter's fuses before measuring current. Use the proper terminals, function, and range for your measurement. Never place the probes across (in parallel with) any circuit or component when the leads are plugged into the current terminals.**

Current is the flow of electrons through a conductor. To measure current, you must break the circuit under test, then place the meter in series with the circuit.

The meter's current ranges are 400  $\mu$ A, 4000  $\mu$ A, 40 mA, 400 mA, 4000 mA, and 10 A. AC current is displayed as an rms value.

To measure current, refer to Figure 7 and proceed as follows:

1. **Turn off power to the circuit. Discharge all high-voltage capacitors.**
2. Insert the black lead into the COM terminal. For currents between 4 mA and 400 mA, insert the red lead into the mA/ $\mu$ A terminal. For currents above 400 mA, insert the red lead into the A terminal.

### *Note*

*To avoid blowing the meter's 400 mA fuse, use the mA/ $\mu$ A terminal only if you are sure the current is less than 400 mA.*

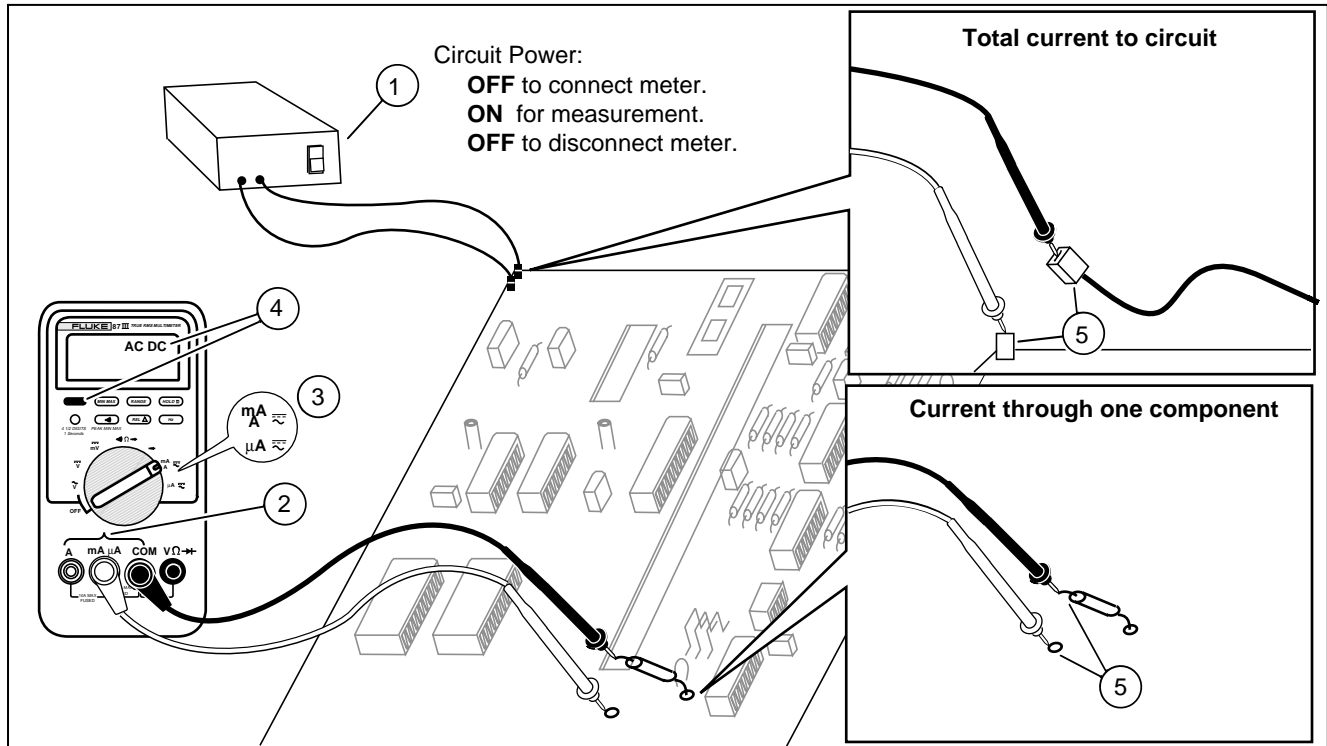

Figure 7. Measuring Current

iy7f.eps

3. If you are using the A terminal, set the rotary switch to mA/A. If you are using the mA/ $\mu$ A terminal, set the rotary switch to  $\mu$ A for currents below 4000  $\mu$ A (4 mA), or mA/A for currents above 4000  $\mu$ A.
4. To measure ac current, press the blue button.
5. Break the circuit path to be tested. Touch the black probe to the more negative side of the break; touch the red probe to the more positive side of the break. Reversing the leads will produce a negative reading, but will not damage the meter.
6. Turn on power to the circuit; then read the display. Be sure to note the unit given at the right side of the display ( $\mu$ A, mA, or A).
7. Turn off power to the circuit and discharge all high-voltage capacitors. Remove the meter and restore the circuit to normal operation.

The following are some tips for measuring current:

- If the current reading is 0 and you are sure the meter is set up correctly, test the meter's fuses as described under "Testing the Fuses".
- A current meter drops a small voltage across itself, which might affect circuit operation. You can calculate this burden voltage using the values listed in the specifications in Table 14.



## Measuring Frequency

Frequency is the number of cycles a signal completes each second. The meter measures the frequency of a voltage or current signal by counting the number of times the signal crosses a threshold level each second.

Table 7 summarizes the trigger levels and applications for measuring frequency using the various ranges of the meter's voltage and current functions.

To measure frequency, connect the meter to the signal source; then press **Hz**. Pressing **|||||** switches the trigger slope between + and -, as indicated by the symbol at the left side of the display (refer to Figure 8 under "Measuring Duty Cycle"). Pressing **HOLD** stops and starts the counter.

The meter autoranges to one of five frequency ranges: 199.99 Hz, 1999.9 Hz, 19.999 kHz, 199.99 kHz, and greater than 200 kHz. For frequencies below 10 Hz, the display is updated at the frequency of the input. Between 0.5 Hz and 0.3 Hz, the display may be unstable. Below 0.3 Hz, the display shows 0.000 Hz.

The following are some tips for measuring frequency:

- If a reading shows as 0 Hz or is unstable, the input signal may be below or near the trigger level. You can usually correct these problems by selecting a lower range, which increases the sensitivity of the meter. In the  $\bar{V}$  function, the lower ranges also have lower trigger levels.
- If a reading seems to be a multiple of what you expect, the input signal may be distorted. Distortion can cause multiple triggerings of the frequency counter. Selecting a higher voltage range might solve this problem by decreasing the sensitivity of the meter. You can also try selecting a dc range, which raises the trigger level. In general, the lowest frequency displayed is the correct one.

**Table 7. Functions and Trigger Levels for Frequency Measurements**

Function	Range	Approximate Trigger Level	Typical Application
$\tilde{V}$	4 V, 40 V, 400 V, 1000 V	0 V	Most signals.
$\tilde{V}$	400 mV	0 V	High-frequency 5 V logic signals. (The dc-coupling of the $\tilde{V}$ function can attenuate high-frequency logic signals, reducing their amplitude enough to interfere with triggering.)
$\bar{\bar{V}}$	400 mV	40 mV	Refer to the measurement tips given before this table.
$\bar{\bar{V}}$	4 V	1.7 V	5 V logic signals (TTL).
$\bar{\bar{V}}$	40 V	4 V	Automotive switching signals.
$\bar{\bar{V}}$	400 V	40 V	Refer to the measurement tips given before this table.
$\bar{\bar{V}}$	1000 V	400 V	
$\Omega \rightarrow$	Frequency counter characteristics are not specified for these functions.		
$A \sim$	All ranges	0 A	AC current signals.
$\mu A \bar{\bar{\bar{\cdot}}}$		400 $\mu A$	Refer to the measurement tips given before this table.
$mA \bar{\bar{\bar{\cdot}}}$		40 mA	
$A \bar{\bar{\bar{\cdot}}}$		4 A	

## Measuring Duty Cycle

Duty cycle (or duty factor) is the percentage of time a signal is above or below a trigger level during one cycle (Figure 8). The duty cycle mode is optimized for measuring the on or off time of logic and switching signals. Systems such as electronic fuel injection systems and switching power supplies are controlled by pulses of varying width, which can be checked by measuring duty cycle.

To measure duty cycle, set up the meter to measure frequency; then press Hz a second time. As with the

frequency function, you can change the slope for the meter's counter by pressing .

For 5 V logic signals, use the 4 V dc range. For 12 V switching signals in automobiles, use the 40 V dc range. For sine waves, use the lowest range that does not result in multiple triggering. (Normally, a distortion-free signal can be up to ten times the amplitude of the selected voltage range.)

If a duty cycle reading is unstable, press MIN MAX; then scroll to the AVG (average) display.

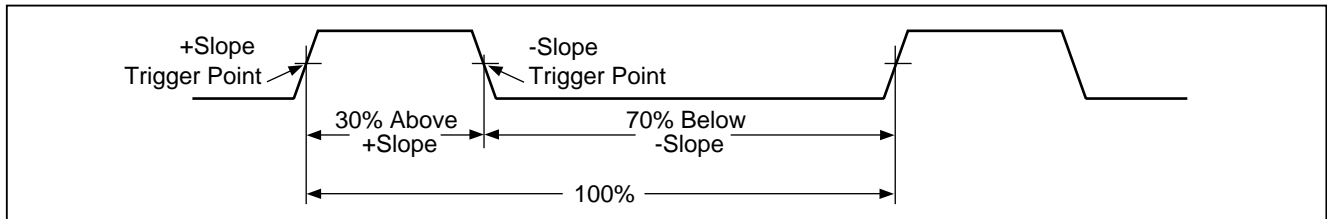



**Figure 8. Components of Duty Cycle Measurements**

ly3f.eps

### **Determining Pulse Width**

For a periodic waveform (its pattern repeats at equal time intervals), you can determine the amount of time that the signal is high or low as follows:

1. Measure the signal's frequency.
2. Press  a second time to measure the signal's duty cycle. Press  to select a measurement of the signal's positive or negative pulse. (Refer to Figure 8.)
3. Use the following formula to determine the pulse width:

$$\text{Pulse Width (in seconds)} = \frac{\% \text{ Duty Cycle} \div 100}{\text{Frequency}}$$

### **Analog Bar Graph**

The analog bar graph functions like the needle on an analog meter, but without the overshoot. The bar graph is updated 40 times per second. Because the graph responds 10 times faster than the digital display, it is useful for making peak and null adjustments and observing rapidly changing inputs.

### **Model 87 Bar Graph**

Model 87's bar graph consists of 32 segments. The position of the pointer on the display represents the last three digits of the digital display. For example, for inputs of 500  $\Omega$ , 1500  $\Omega$ , and 2500  $\Omega$ , the pointer is near 0.5 on the scale. If the last three digits are 999, the pointer is at the far right of the scale. As the digits increment past 000, the pointer wraps back to the left side of the display. The polarity indicator at the left of the graph indicates the polarity of the input.

### **Models 83 and 85 Bar Graph**

The bar graph on Models 83 and 85 consists of 43 segments. The number of lit segments is relative to the full-scale value of the selected range. The polarity indicator at the left of the graph indicates the polarity of the input. For example, if the 40 V range is selected, the "4" on the scale represents 40 V. An input of -30 V would light the negative sign and the segments up to the "3" on the scale.

If the input equals or exceeds the 4096 counts on a manually-selected range, all segments are lit and ► appears to the right of the bar graph. The graph does not operate with the capacitance or frequency counter functions.

The bar graph on Models 83 and 85 also has a zoom function, as described under "Zoom Mode".

### **4-1/2 Digit Mode (Model 87)**

On a Model 87 meter, pressing the yellow button for one second causes the meter to enter the high-resolution, 4-1/2 digit mode. Readings are displayed at 10 times the normal resolution with a maximum display of 19,999 counts. The display is updated once per second. The 4-1/2 digit mode works in all modes except capacitance and the 250  $\mu$ s and 100 ms MIN MAX modes.

To return to the 3-1/2 digit mode, press the yellow button only until all of the display segments turn on (about one second).

## **MIN MAX Recording Mode**

The MIN MAX mode records minimum and maximum input values. When the inputs go below the recorded minimum value or above the recorded maximum value, the meter beeps and records the new value. This mode can be used to capture intermittent readings, record maximum readings while you are away, or record readings while you are operating the equipment under test and cannot watch the meter. MIN MAX mode can also calculate an average of all readings taken since the MIN MAX mode was activated. To use MIN MAX mode, refer to the functions in Table 8.







Response time is the length of time an input must stay at a new value to be recorded. A shorter response time captures shorter events, but with decreased accuracy. Changing the response time erases all recorded readings. Models 83 and 85 have 100 millisecond and 1 second response times; Model 87 has 1 second, 100 millisecond, and 250  $\mu$ s (peak) response times. The 250  $\mu$ s response time is indicated by "1 ms" on the display.

The 100 millisecond response time is best for recording power supply surges, inrush currents, and finding intermittent failures. This response time follows the update time of the analog display.

The high-accuracy 1 second response time has the full accuracy of the meter and is best for recording power supply drift, line voltage changes, or circuit performance while line voltage, temperature, load, or some other parameter is being changed.

The true average value (AVG) displayed in the 100 ms and 1 s modes is the mathematical integral of all readings taken since you started recording. The average reading is useful for smoothing out unstable inputs, calculating power consumption, or estimating the percent of time a circuit is active.

Table 8. MIN MAX Functions

Button	MIN MAX Function
	Enter MIN MAX recording mode. The meter is locked in the range displayed before you entered MIN MAX mode. (Select the desired measurement function and range before entering MIN MAX.) The meter beeps each time a new minimum or maximum value is recorded.
 (While in MIN MAX mode)	Scroll through minimum (MIN), maximum (MAX), and average (AVG) values.
 PEAK MIN MAX	Model 87 only: Select 100 ms or 250 $\mu$ s response time. (The 250 $\mu$ s response time is indicated by "1 ms" on the display.) Stored values are erased. The present and AVG (average) values are not available when 250 $\mu$ s is selected.
	Stop recording without erasing stored values. Press again to resume recording.
 (hold for 1 second)	Exit MIN MAX mode. Stored values are erased. The meter stays in the selected range.
Hold down  while turning the meter on	Select 1 s high-accuracy response time. See text under "MIN MAX Recording Mode" for more explanation. MIN MAX readings for the frequency counter are recorded only in the high-accuracy mode.



## Touch Hold<sup>®</sup> Mode

### Warning

**The Touch Hold mode will not capture unstable or noisy readings. Do not use Touch Hold mode to determine that circuits are without power.**

The Touch Hold mode captures the present reading on the display. When a new, stable reading is detected, the meter beeps and displays the new reading. To enter or exit Touch Hold mode, press .

## Relative Mode

Selecting relative mode (  ) causes the meter to zero the display and store the present reading as the reference for subsequent measurements. The meter is locked into the range selected when you pressed  . Press  again to exit this mode.

In relative mode, the reading shown is always the difference between the present reading and the stored reference value. For example, if the stored reference value is 15.00 V and the present reading is 14.10 V, the display shows -0.90 V.

On Model 87, the relative mode does not change the operation of the analog display.

## Zoom Mode (Models 83 and 85)

Selecting relative mode on a Model 83 or 85 meter causes the bar graph to enter Zoom mode. In zoom mode, the center of the graph represents zero and the sensitivity of the bar graph increases by a factor of 10. Measured values more negative than the stored reference light segments to the left of center; values more positive light segments to the right of center.



### **Uses for the Zoom Mode (Models 83 and 85)**

The relative mode, combined with the increased sensitivity of the bar graph's zoom mode, helps you make fast and accurate zero and peak adjustments.

For zero adjustments, set the meter to the desired function, short the test leads together, press (RELΔ); then connect the leads to the circuit under test. Adjust the circuit's variable component until the display reads zero. Only the center segment on the Zoom bar graph is lit.

For peak adjustments, set the meter to the desired function, connect the leads to the circuit under test; then press (RELΔ). The display reads zero. As you adjust for a positive or negative peak, the bar graph length increases to the right or left of zero. If an overrange symbol lights (◀ ▶), press (RELΔ) twice to set a new reference; then continue with your adjustment.

## **Maintenance**

Repairs or servicing not covered in this manual should be performed only by qualified personnel as described in the *80 Series III Service Manual*.

### **General Maintenance**

Periodically wipe the case with a damp cloth and mild detergent. Do not use abrasives or solvents.

Dirt or moisture in the terminals can affect readings and can falsely activate the Input Alert feature. Clean the terminals as follows:

1. Turn the meter off and remove all test leads.
2. Shake out any dirt that may be in the terminals.
3. Soak a new swab with a cleaning and oiling agent (such as WD-40). Work the swab around in each terminal. The oiling agent insulates the terminals from moisture-related activation of the Input Alert feature.

### Testing the Fuses

Before measuring current, test the appropriate fuse as shown in Figure 9. If the tests give readings other than those shown, have the meter serviced.

#### **⚠ Warning**

**To avoid electrical shock or personal injury, remove the test leads and any input signals before replacing the battery or fuses. To prevent damage or injury, install ONLY specified replacement fuses with the amperage, voltage, and speed ratings shown in Table 9.**

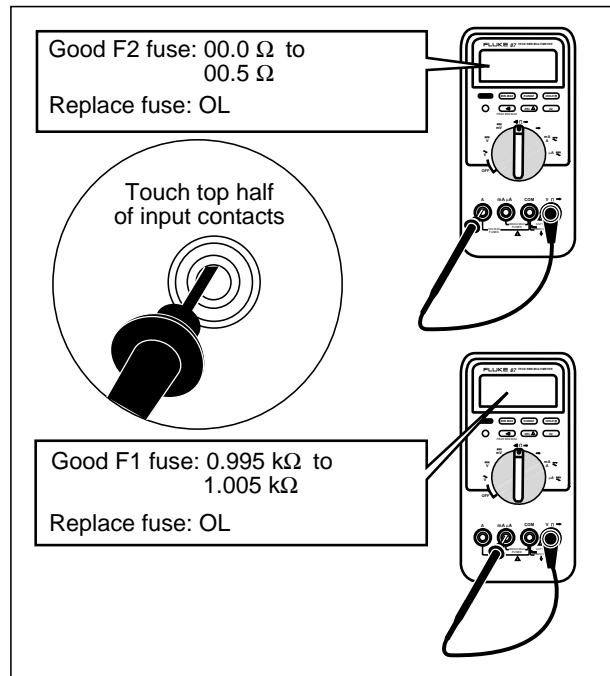

**Figure 9. Testing the Current Fuses**

iy5f.eps

### Replacing the Battery

Replace the battery with a 9 V battery (NEDA A1604, 6F22, or 006P).

#### **Warning**

**To avoid false readings, which could lead to possible electric shock or personal injury, replace the battery as soon as the battery indicator (  ) appears.**

Replace the battery as follows (refer to Figure 10):

1. Turn the rotary switch to OFF and remove the test leads from the terminals.
2. Remove the battery door by using a standard-blade screwdriver to turn the battery door screws one-quarter turn counterclockwise.
3. Replace the battery and the battery door. Secure the door by turning the screws one-quarter turn clockwise.

### Replacing the Fuses

Referring to Figure 10, examine or replace the meter's fuses as follows:

1. Turn the rotary switch to OFF and remove the test leads from the terminals.
2. Remove the battery door by using a standard-blade screwdriver to turn the battery door screws one-quarter turn counterclockwise.
3. Remove the three Phillips-head screws from the case bottom and turn the case over.
4. Gently lift the input terminal-end of the top case to separate the two halves of the case.
5. Remove the fuse by gently prying one end loose, then sliding the fuse out of its bracket.
6. Install **ONLY** specified replacement fuses with the amperage, voltage, and speed ratings shown in Table 9.

6. Verify that the rotary switch and the circuit board switch are in the OFF position.
7. Replace the case top, ensuring that the gasket is properly seated and case snaps together above the LCD (item ①).
8. Reinstall the three screws and the battery door. Secure the door by turning the screws one-quarter turn clockwise.

## ***Service and Parts***

If the meter fails, check the battery and fuses. Review this manual to verify proper use of the meter.

Replacement parts and accessories are shown in Tables 9 and 10 and Figure 11.

To contact Fluke, call one of the following telephone numbers:

USA: 1-888-99-FLUKE (1-888-993-5853)  
Canada: 1-800-36-FLUKE (1-800-363-5853)  
Europe: +31 402-678-200  
Japan: +81-3-3434-0181  
Singapore: +65-738-5655  
Anywhere in the world: +1-425-356-5500

Or, visit Fluke's Web site at [www.fluke.com](http://www.fluke.com).

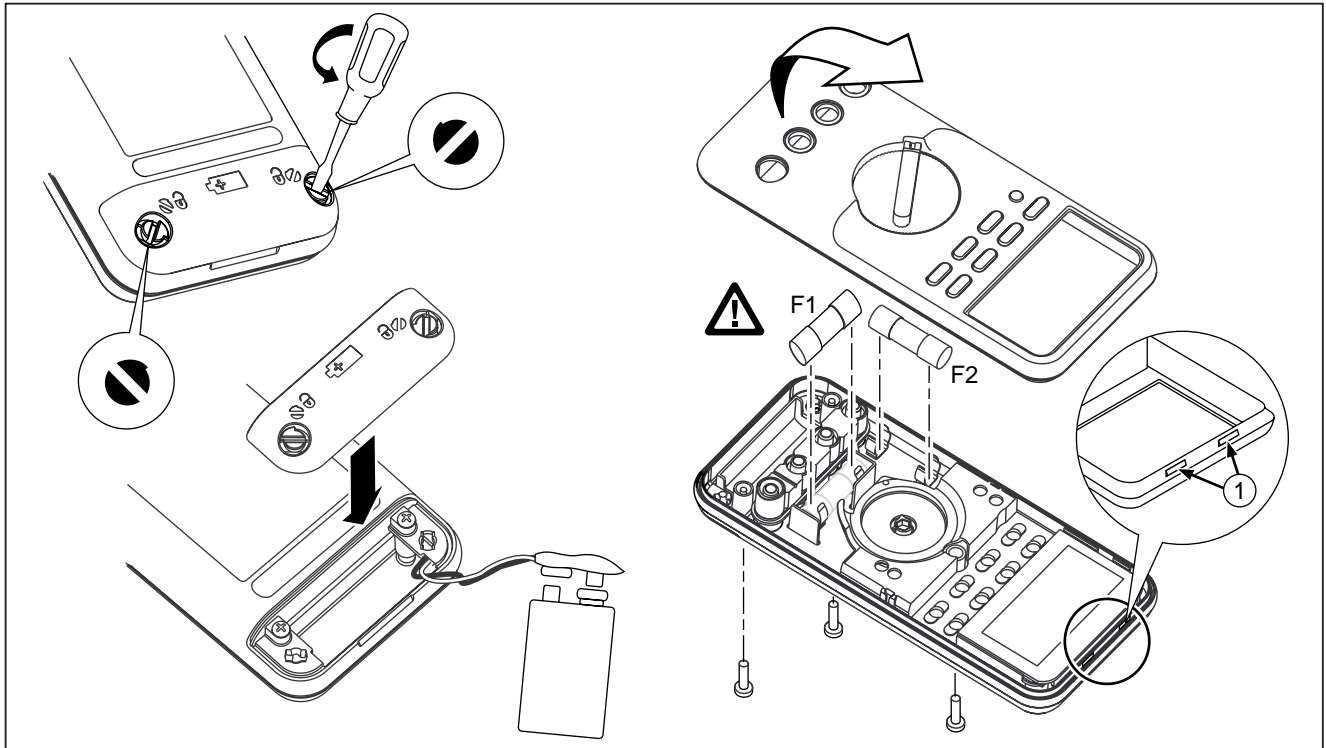



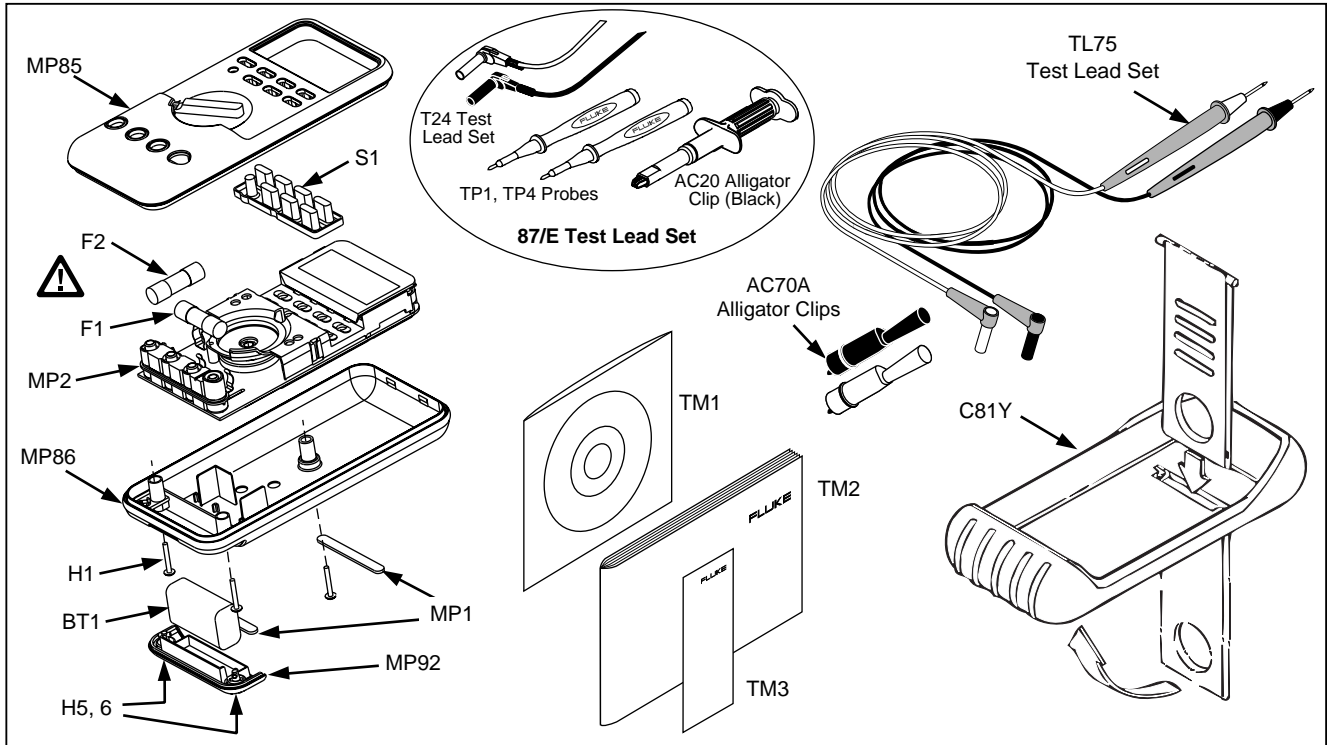

Figure 10. Battery and Fuse Replacement

iy12f.eps

**Table 9. Replacement Parts**

Item	Description	Fluke Part or Model Number	Quantity
BT1	Battery, 9 V	614487	1
F1 	Fuse, 0.440 A, 1000 V, FAST	943121	1
F2 	Fuse, 11 A, 1000 V, FAST	803293	1
H1	Screw, Case	832246	3
MP1	Foot, Non-Skid	824466	2
MP2	O-Ring, Input Receptacle	831933	1
TM1	CD-ROM (contains Users Manual)	1611720	1
TM2	Getting Started Manual	1611712	1
TM3	Quick Reference Guide, Fluke 80 Series III	688168	1
TM4	Service Manual	688645	Optional
 To ensure safety, use exact replacement only.			



iy11f.eps

**Figure 11. Replaceable Parts**

**Table 10. Accessories\***

Item	Description	Fluke Part Number	Quantity
TL20	Industrial Test Lead Set (Optional)	TL20	—
AC70A	Alligator Clips for use with TL75 test lead set	AC70A	1
TL75	Test Lead Set	TL75	1
TL24	Test Lead Set, Heat-Resistant Silicone	TL24	—
TP1	Test Probes, Flat Blade, Slim Reach	TP1	—
TP4	Test Probes, 4 mm diameter, Slim Reach	TP4	—
AC20	Safety Grip, Wide-Jaw Alligator Clips	AC20	—
C81Y	Holster, Yellow	C81Y	1
C81G	Holster, Gray (Optional)	C81G	—
C25	Carrying Case, Soft (Optional)	C25	—
* Fluke accessories are available from your authorized Fluke distributor.			



## Specifications

**Maximum Voltage between any Terminal and Earth Ground:** 1000 V rms

**⚠ Fuse Protection for mA or  $\mu$ A inputs:** 44/100 A, 1000 V FAST Fuse

**⚠ Fuse Protection for A input:** 11 A, 1000 V FAST Fuse

**Display:** Digital: 4000 counts updates 4/sec; (Model 87 also has 19,999 counts in 4½-digit mode, updates 1/sec.). Analog: updates 40/sec. Frequency: 19,999 counts, updates 3/sec at >10 Hz. Model 87: 4 x 32 segments (equivalent to 128); Models 83, 85: 43 segments.

**Temperature:** Operating: -20°C to +55°C; Storage: -40°C to +60°C

**Altitude:** Operating: 2000 m; Storage: 10,000 m

**Temperature Coefficient:** 0.05 x (specified accuracy)/ °C (<18°C or >28°C)

**Electromagnetic Compatibility:** In an RF field of 3 V/m total accuracy = specified accuracy except: Models 85,87: Total Accuracy = Specified Accuracy + 0.4% of range above 800 MHz ( $\mu$ ADC only). (mVAC and  $\mu$ AAC unspecified). Model 83: Total Accuracy = Specified Accuracy + 5% of range above 300 MHz ( $\mu$ ADC only). (VDC unspecified).

**Relative Humidity:** 0% to 90% (0°C to 35°C); 0% to 70% (35°C to 55°C)

**Battery Type:** 9 V zinc, NEDA 1604 or 6F22 or 006P

**Battery Life:** 400 hrs typical with alkaline (with backlight off)

**Shock Vibration:** Per MIL-T-28800 for a Class 2 instrument

**Size (HxWxL):** 1.25 in x 3.41 in x 7.35 in (3.1 cm x 8.6 cm x 18.6 cm)

**Size with Holster and Flex-Stand:** 2.06 in x 3.86 in x 7.93 in (5.2 cm x 9.8 cm x 20.1 cm)

**Weight:** 12.5 oz (355 g)

**Weight with Holster and Flex-Stand:** 22.0 oz (624 g)

**Safety:** Complies with ANSI/ISA S82.01-1994, CSA 22.2 No. 1010.1:1992 to 1000 V Overvoltage Category III. UL listed to UL3111-1. Licensed by TÜV to EN61010-1.

**Table 11. Models 85 and 87 AC Voltage Function Specifications**

Function	Range	Resolution	Accuracy <sup>1</sup>			
			50 Hz - 60 Hz	45 Hz - 1 kHz	1 kHz - 5 kHz	5 kHz - 20 kHz <sup>2</sup>
$\tilde{V}$ <sup>3</sup>	400.0 mV	0.1 mV	$\pm(0.7\% + 4)$	$\pm(1.0\% + 4)$	$\pm(2.0\% + 4)$	$\pm(2.0\% + 20)$
	4.000 V	0.001 V	$\pm(0.7\% + 2)$	$\pm(1.0\% + 4)$	$\pm(2.0\% + 4)$	$\pm(2.0\% + 20)$
	40.00 V	0.01 V	$\pm(0.7\% + 2)$	$\pm(1.0\% + 4)$	$\pm(2.0\% + 4)$	$\pm(2.0\% + 20)$
	400.0 V	0.1 V	$\pm(0.7\% + 2)$	$\pm(1.0\% + 4)$	$\pm(2.0\% + 4)$ <sup>4</sup>	unspecified
	1000 V	1 V	$\pm(0.7\% + 2)$	$\pm(1.0\% + 4)$ <sup>5</sup>	unspecified	unspecified

1. Accuracy is given as  $\pm$ ([% of reading] + [number of least significant digits]) at 18°C to 28°C, with relative humidity up to 90%, for a period of one year after calibration. For Model 87 in the 4 ½-digit mode, multiply the number of least significant digits (counts) by 10. AC conversions are ac-coupled and valid from 5% to 100% of range. Models 85 and 87 are true rms responding. AC crest factor can be up to 3 at full scale, 6 at half scale. For non-sinusoidal wave forms add -(2% Rdg + 2% full scale) typical, for a crest factor up to 3.
2. Below 10% of range, add 6 counts.
3. Models 85 and 87 are true rms responding meters. When the input leads are shorted together in the ac functions, the meters display a reading (typically <25 counts) that is caused by internal amplifier noise. The accuracy on Models 85 and 87 is not significantly affected by this internal offset when measuring inputs that are within 5% to 100% of the selected range. When the rms value of the two values (5% of range and internal offset) is calculated, the effect is minimal as shown in the following example where 20.0 = 5% of 400 mV range, and 2.5 is the internal offset:  $RMS = \sqrt{(20.0)^2 + (2.5)^2} = 20.16$ . If you use the REL function to zero the display when using the ac functions, a constant error that is equal to the internal offset will result.
4. Frequency range: 1 kHz to 2.5 kHz.
5. Below 10% of range, add 16 counts.

Table 12. Model 83 AC Voltage Function Specifications

Function	Range	Resolution	Accuracy <sup>1</sup>		
			50 Hz - 60 Hz	45 Hz - 1 kHz	1 kHz - 5 kHz
$\tilde{V}^2$	400.0 mV	0.1 mV	$\pm(0.5\% + 4)$	$\pm(1.0\% + 4)$	$\pm(2.0\% + 4)$
	4.000 V	0.001 V	$\pm(0.5\% + 2)$	$\pm(1.0\% + 4)$	$\pm(2.0\% + 4)$
	40.00 V	0.01 V	$\pm(0.5\% + 2)$	$\pm(1.0\% + 4)$	$\pm(2.0\% + 4)$
	400.0 V	0.1 V	$\pm(0.5\% + 2)$	$\pm(1.0\% + 4)$	$\pm(2.0\% + 4)^3$
	1000 V	1 V	$\pm(0.5\% + 2)$	$\pm(1.0\% + 4)$	unspecified
<ol style="list-style-type: none"> <li>1. See the first sentence in Table 11 for a complete explanation of accuracy.</li> <li>2. Below a reading of 200 counts, add 10 counts.</li> <li>3. Frequency range: 1 kHz to 2.5 kHz.</li> </ol>					

Table 13. DC Voltage, Resistance, and Conductance Function Specifications

Function	Range	Resolution	Accuracy <sup>1</sup>		
			Model 83	Model 85	Model 87
$\bar{V}$	4.000 V	0.001 V	$\pm(0.1\% + 1)$	$\pm(0.08\% + 1)$	$\pm(0.05\% + 1)$
	40.00 V	0.01 V	$\pm(0.1\% + 1)$	$\pm(0.08\% + 1)$	$\pm(0.05\% + 1)$
	400.0 V	0.1 V	$\pm(0.1\% + 1)$	$\pm(0.08\% + 1)$	$\pm(0.05\% + 1)$
	1000 V	1 V	$\pm(0.1\% + 1)$	$\pm(0.08\% + 1)$	$\pm(0.05\% + 1)$
$\bar{mV}$	400.0 mV	0.1 mV	$\pm(0.3\% + 1)$	$\pm(0.1\% + 1)$	$\pm(0.1\% + 1)$
$\Omega$	400.0 $\Omega$	0.1 $\Omega$	$\pm(0.4\% + 2)^2$	$\pm(0.2\% + 2)^2$	$\pm(0.2\% + 2)^2$
	4.000 k $\Omega$	0.001 k $\Omega$	$\pm(0.4\% + 1)$	$\pm(0.2\% + 1)$	$\pm(0.2\% + 1)$
	40.00 k $\Omega$	0.01 k $\Omega$	$\pm(0.4\% + 1)$	$\pm(0.2\% + 1)$	$\pm(0.2\% + 1)$
	400.0 k $\Omega$	0.1 k $\Omega$	$\pm(0.7\% + 1)$	$\pm(0.6\% + 1)$	$\pm(0.6\% + 1)$
	4.000 M $\Omega$	0.001 M $\Omega$	$\pm(0.7\% + 1)$	$\pm(0.6\% + 1)$	$\pm(0.6\% + 1)$
	40.00 M $\Omega$	0.01 M $\Omega$	$\pm(1.0\% + 3)$	$\pm(1.0\% + 3)$	$\pm(1.0\% + 3)$
nS	40.00 nS	0.01 nS	$\pm(1.0\% + 10)$	$\pm(1.0\% + 10)$	$\pm(1.0\% + 10)$
<ol style="list-style-type: none"> <li>See the first sentence in Table 11 for a complete explanation of accuracy.</li> <li>When using the REL <math>\Delta</math> function to compensate for offsets.</li> </ol>					



Table 14. Current Function Specifications

Function	Range	Resolution	Accuracy <sup>1</sup>			Burden Voltage (typical)
			Model 83 <sup>2</sup>	Model 85 <sup>3, 4</sup>	Model 87 <sup>3, 4</sup>	
<b>mA</b> <b>A~</b> (45 Hz to 2 kHz)	40.00 mA	0.01 mA	$\pm(1.2\% + 2)^6$	$\pm(1.0\% + 2)^6$	$\pm(1.0\% + 2)$	1.8 mV/mA
	400.0 mA	0.1 mA	$\pm(1.2\% + 2)^6$	$\pm(1.0\% + 2)^6$	$\pm(1.0\% + 2)$	1.8 mV/mA
	4000 mA	1 mA	$\pm(1.2\% + 2)^6$	$\pm(1.0\% + 2)^6$	$\pm(1.0\% + 2)$	0.03 V/A
	10.00 A <sup>5</sup>	0.01 A	$\pm(1.2\% + 2)^6$	$\pm(1.0\% + 2)^6$	$\pm(1.0\% + 2)$	0.03 V/A
<b>mA</b> <b>A=</b>	40.00 mA	0.01 mA	$\pm(0.4\% + 4)$	$\pm(0.2\% + 4)$	$\pm(0.2\% + 4)$	1.8 mV/mA
	400.0 mA	0.1 mA	$\pm(0.4\% + 2)$	$\pm(0.2\% + 2)$	$\pm(0.2\% + 2)$	1.8 mV/mA
	4000 mA	1 mA	$\pm(0.4\% + 4)$	$\pm(0.2\% + 4)$	$\pm(0.2\% + 4)$	0.03 V/A
	10.00 A <sup>5</sup>	0.01 A	$\pm(0.4\% + 2)$	$\pm(0.2\% + 2)$	$\pm(0.2\% + 2)$	0.03 V/A
<ol style="list-style-type: none"> <li>1. See the first sentence in Table 11 for a complete explanation of accuracy.</li> <li>2. AC conversion for Model 83 is ac coupled and calibrated to the rms value of a sinewave input.</li> <li>3. AC conversions for Models 85 and 87 are ac coupled, true rms responding, and valid from 5% to 100% of range.</li> <li>4. See note 3 in Table 11.</li> <li>5. <math>\Delta</math> 10 A continuous; 20 A for 30 seconds maximum; &gt;10 A: unspecified.</li> <li>6. Below a reading of 200 counts, add 10 counts.</li> </ol>						

**Table 14. Current Function Specifications (continued)**

Function	Range	Resolution	Accuracy <sup>1</sup>			Burden Voltage (typical)
			Model 83 <sup>2</sup>	Model 85 <sup>3, 4</sup>	Model 87 <sup>3, 4</sup>	
$\mu\text{A} \sim$ (45 Hz to 2 kHz)	400.0 $\mu\text{A}$	0.1 $\mu\text{A}$	$\pm(1.2\% + 2)^5$	$\pm(1.0\% + 2)^5$	$\pm(1.0\% + 2)$	100 $\mu\text{V}/\mu\text{A}$
	4000 $\mu\text{A}$	1 $\mu\text{A}$	$\pm(1.2\% + 2)^5$	$\pm(1.0\% + 2)^5$	$\pm(1.0\% + 2)$	100 $\mu\text{V}/\mu\text{A}$
$\mu\text{A} \text{---}$	400.0 $\mu\text{A}$	0.1 $\mu\text{A}$	$\pm(0.4\% + 4)$	$\pm(0.2\% + 4)$	$\pm(0.2\% + 4)$	100 $\mu\text{V}/\mu\text{A}$
	4000 $\mu\text{A}$	1 $\mu\text{A}$	$\pm(0.4\% + 2)$	$\pm(0.2\% + 2)$	$\pm(0.2\% + 2)$	100 $\mu\text{V}/\mu\text{A}$
<ol style="list-style-type: none"> <li>1. See the first sentence in Table 11 for a complete explanation of accuracy.</li> <li>2. AC conversion for Model 83 is ac coupled and calibrated to the rms value of a sinewave input.</li> <li>3. AC conversions for Models 85 and 87 are ac coupled, true rms responding, and valid from 5% to 100% of range.</li> <li>4. See note 3 in Table 11.</li> <li>5. Below a reading of 200 counts, add 10 counts.</li> </ol>						

**Table 15. Capacitance and Diode Function Specifications**

Function	Range	Resolution	Accuracy <sup>1</sup>
	5.00 nF	0.01 nF	$\pm(1\% + 3)$
	0.0500 $\mu$ F	0.0001 $\mu$ F	$\pm(1\% + 3)$
	0.500 $\mu$ F	0.001 $\mu$ F	$\pm(1\% + 3)$
	5.00 $\mu$ F	0.01 $\mu$ F	$\pm(1.9\% + 3)$
	3.000 V	0.001 V	$\pm(2\% + 1)$
1. With a film capacitor or better, using Relative mode to zero residual. See the first sentence in Table 11 for a complete explanation of accuracy.			

**Table 16. Frequency Counter Specifications**

Function	Range	Resolution	Accuracy <sup>1</sup>
Frequency (0.5 Hz to 200 kHz, pulse width >2 $\mu$ s)	199.99	0.01 Hz	$\pm(0.005\% + 1)$
	1999.9	0.1 Hz	$\pm(0.005\% + 1)$
	19.999 kHz	0.001 kHz	$\pm(0.005\% + 1)$
	199.99 kHz	0.01 kHz	$\pm(0.005\% + 1)$
	>200 kHz	0.1 kHz	unspecified
1. See the first sentence in Table 11 for a complete explanation of accuracy.			

**Table 17. Frequency Counter Sensitivity and Trigger Levels**

Input Range <sup>1</sup>	Minimum Sensitivity (RMS Sinewave)		Approximate Trigger Level (DC Voltage Function)
	5 Hz - 20 kHz	0.5 Hz - 200 kHz	
400 mV dc	70 mV (to 400 Hz)	70 mV (to 400 Hz)	40 mV
400 mV dc	150 mV	150 mV	—
4 V	0.3 V	0.7 V	1.7 V
40 V	3 V	7 V ( $\leq 140$ kHz)	4 V
400 V	30 V	70 V ( $\leq 14.0$ kHz)	40 V
1000 V	300 V	700 V ( $\leq 1.4$ kHz)	400 V
Duty Cycle Range	Accuracy		
0.0 to 99.9%	Within $\pm(0.05\%$ per kHz + 0.1%) of full scale for a 5 V logic family input on the 4 V dc range. Within $\pm((0.06 \times \text{Voltage Range}/\text{Input Voltage}) \times 100\%)$ of full scale for sine wave inputs on ac voltage ranges.		
1. Maximum input for specified accuracy = 10X Range or 1000 V.			



**Table 18. Electrical Characteristics of the Terminals**

Function	Overload Protection <sup>1</sup>	Input Impedance (nominal)	Common Mode Rejection Ratio (1 kΩ unbalance)		Normal Mode Rejection						
$\bar{\bar{V}}$	1000 V rms	10 MΩ<100 pF	>120 dB at dc, 50 Hz or 60 Hz		>60 dB at 50 Hz or 60 Hz						
$\bar{mV}$	1000 V rms	10 MΩ<100 pF	>120 dB at dc, 50 Hz or 60 Hz		>60 dB at 50 Hz or 60 Hz						
$\tilde{V}$	1000 V rms	10 MΩ<100 pF (ac-coupled)	>60 dB, dc to 60 Hz								
			Open Circuit Test Voltage	Full Scale Voltage		Typical Short Circuit Current					
				To 4.0 MΩ	40 MΩ or nS	400 Ω	4 k	40 k	400 k	4 M	40 M
Ω	1000 V rms	<1.3 V dc	<450 mV dc	<1.3 V dc	200 μA	80 μA	12 μA	1.4 μA	0.2 μA	0.2 μA	
$\rightarrow$	1000 V rms	<3.9 V dc	3.000 V dc		0.6 mA typical						
1. 10 <sup>6</sup> V Hz max											

**Table 19. MIN MAX Recording Specifications**

Model	Nominal Response	Accuracy
83	100 ms to 80%  1 s	Specified accuracy $\pm 12$ counts for changes >200 ms in duration ( $\pm 40$ counts in ac with beeper on)  Same as specified accuracy for changes >2 seconds in duration ( $\pm 40$ counts in ac with beeper on)
85, 87	100 ms to 80% (DC functions)  120 ms to 80% (AC functions)  1 s  250 $\mu$ s (Model 87 only)	Specified accuracy $\pm 12$ counts for changes >200 ms in duration  Specified accuracy $\pm 40$ counts for changes >350 ms and inputs >25% of range  Same as specified accuracy for changes >2 seconds in duration  Specified accuracy $\pm 100$ counts for changes >250 $\mu$ s in duration ( $\pm 250$ digits typical for mV, 400 $\mu$ A dc, 40 mA dc, 4000 mA dc)

## Free Manuals Download Website

<http://myh66.com>

<http://usermanuals.us>

<http://www.somanuals.com>

<http://www.4manuals.cc>

<http://www.manual-lib.com>

<http://www.404manual.com>

<http://www.luxmanual.com>

<http://aubethermostatmanual.com>

Golf course search by state

<http://golfingnear.com>

Email search by domain

<http://emailbydomain.com>

Auto manuals search

<http://auto.somanuals.com>

TV manuals search

<http://tv.somanuals.com>