

FLUKE®

Biomedical

Nuclear Associates 76-907 and 76-908

AAPM MRI Phantoms

Users Manual

March 2005
Manual No. 38616 Rev. 3
©2003, 2005 Fluke Corporation, All rights reserved. Printed in U.S.A.
All product names are trademarks of their respective companies

**Fluke Biomedical
Radiation Management Services**

6045 Cochran Road
Cleveland, Ohio 44139
440.498.2564

www.flukebiomedical.com/rms

Table of Contents

Section 1:	General Information	1-1
1.1	Introduction	1-1
1.2	Phantom Description.....	1-1
1.2.1	3D Resolution and Slice (3DRAS) Phantom (Model 76-908)	1-2
1.2.2	Uniformity and Linearity (UAL) Phantom (76-907).....	1-4
Section 2:	Operations	2-1
2.1	Phantom Preparation	2-1
2.1.1	Signal Producing Solution	2-1
2.1.2	Filling the Phantom.....	2-1
2.2	Preparation for Scanning	2-2
2.2.1	Positioning the Phantom.....	2-2
2.2.2	Scanning Parameters	2-2
2.3	Tests with 3D Resolution and Slice (3DRAS) Phantom	2-2
2.3.1	Resonance Frequency	2-2
2.3.2	Signal-To-Noise Ratio	2-3
2.3.3	High-Contrast Spatial Resolution	2-3
2.3.4	Slice Thickness	2-4
2.3.5	Slice Position and Separation.....	2-4
2.3.6	Example Images.....	2-5
2.4	Tests with Uniformity and Linearity (UAL) Phantom	2-10
2.4.1	Image Uniformity	2-10
2.4.2	Spatial Linearity (Distortion)	2-10
2.4.3	Image Artifacts	2-11
2.4.4	Action Criteria	2-12
2.4.5	Example Images.....	2-12

(Blank page)

Section 1

General Information

1.1 Introduction

This user's manual describes a set of MRI phantoms that were manufactured based on the AAPM recommendations and their use in measuring the MRI system performance. These phantoms were designed to measure them conveniently and quickly. The AAPM recommended image parameters described in this document are:

- Image uniformity
- Resonance frequency
- Slice position/separation
- Spatial linearity
- Phase related image artifacts
- Signal-to-noise
- Slice thickness
- Spatial resolution

This set of parameters is measured for monitoring the sensitivity and geometric characteristics of MR imaging clinical systems as specified in the AAPM document.

Two phantoms were designed to meet the AAPM specifications. This manual describes a set of test procedures associated with the phantoms that can be used to evaluate the performance of clinical magnetic resonance imaging systems. These procedures and tests, which are described in the AAPM document, can be used to establish absolute performance standards as well as routine quality assurance programs.

The manual does not include procedures to measure any T1, T2, or proton density, because at the present time there are no commonly accepted standard methods for determining T1, T2, and proton density from image data and because the assessment of these parameters is not currently a part of clinical practice.

1.2 Phantom Description

AAPM specifications provide a framework of requirements for MRI phantoms and their use, but it defines neither how phantoms should be constructed nor how inserts are to be organized. The AAPM MR Phantoms take into consideration a number of factors that maximize convenience and time efficiency for the user. The phantoms were designed to provide maximum amount of information in a reproducible manner with the shortest data acquisition time.

The set consists of two phantoms: a three dimensional resolution and slice (3DRAS) phantom and an uniformity and linearity (UAL) phantom

1.2.1 3D Resolution and Slice (3DRAS) Phantom (Model 76-908)

The 3DRAS phantom has outer dimensions of 6" x 6" x 5" (Figure 1-1). Six resolution inserts and slice thickness 4 ramp sets were placed inside of the rectangular box to allow image acquisition in any one of the three directions (sagittal, coronal, and transaxial) without repositioning the phantom.

Outer Shape 6" X 6" X 5" Cubical Box

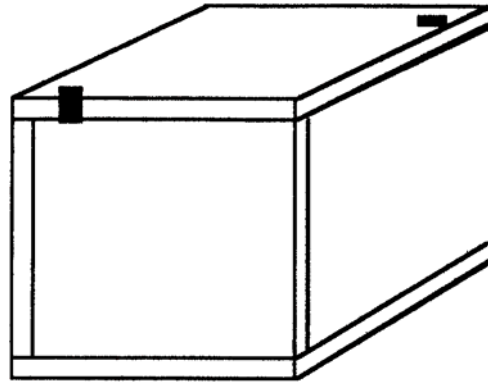

Figure 1-1. 3DRAS Phantom

The resolution section (Figure 1-2) has square holes of 0.5 mm, 0.75 mm, 1.0 mm and 2.0 mm side dimensions. The spacing between the holes is equal to their side dimensions. The holes are precisely parallel to each other and are $\frac{3}{4}$ " long. Square holes are used rather than drilled cylindrical holes because square holes can be manufactured more precisely than cylindrical holes.

Resolution Block Detail - 2 Required

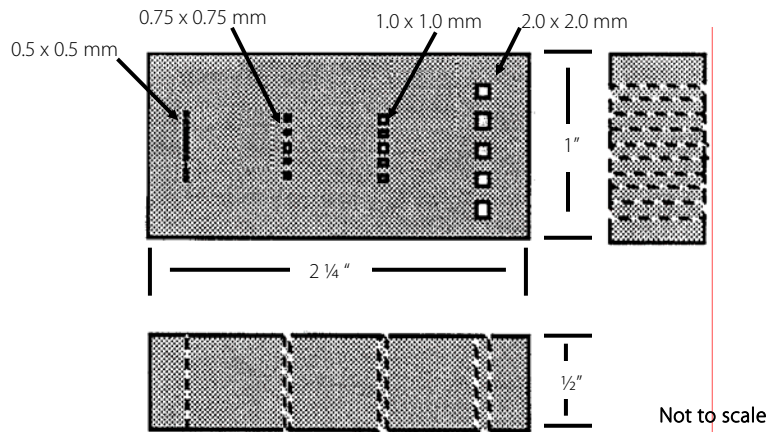
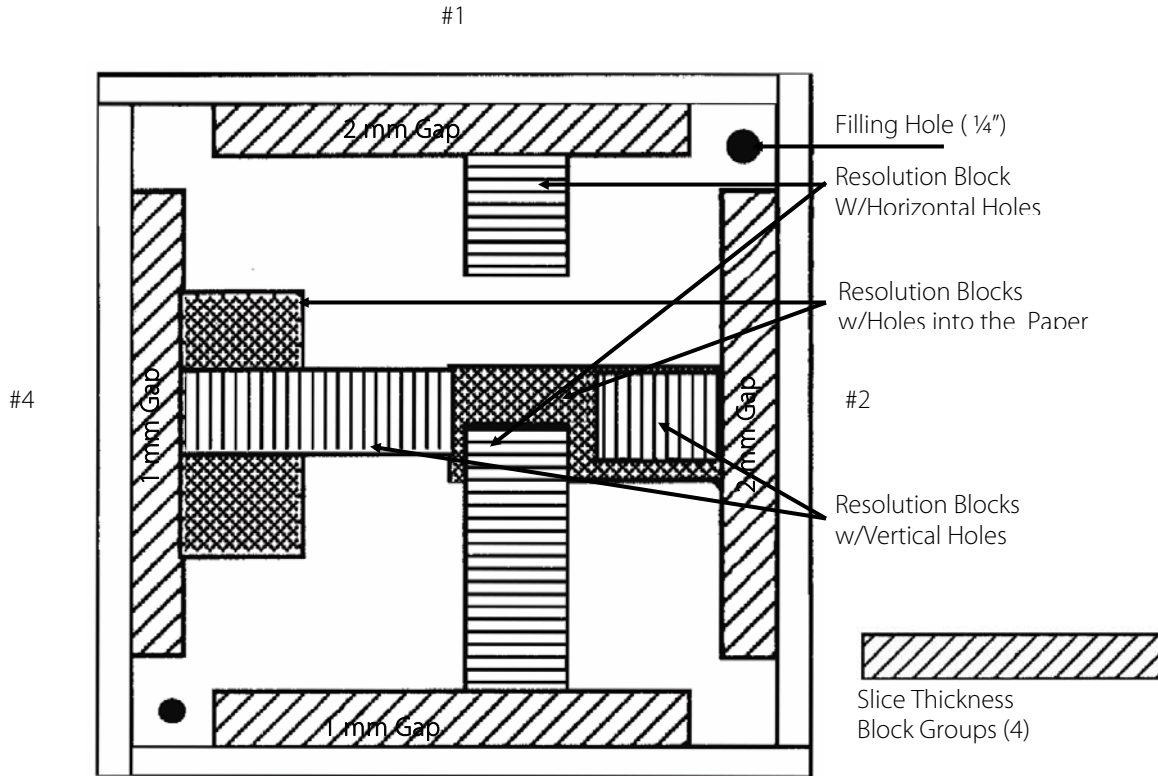

Figure 1-2. Resolution Block Detail

A set of two resolution sections are positioned perpendicular to each other (Figure 1-3) in three imaging planes (sagittal, coronal, and transaxial). Two sections are used per imaging plane since the spatial resolution of MR images can be asymmetric between the encoding and frequency (read-out) direction.



Box Dimension of the Box 6" x 6" #3
Walls are Made with 1/4" Material

Figure 1-3. Resolution Sections in Three Imaging Planes

The slice-thickness phantom consists of two crossed thin ramps (Figure 1-4).

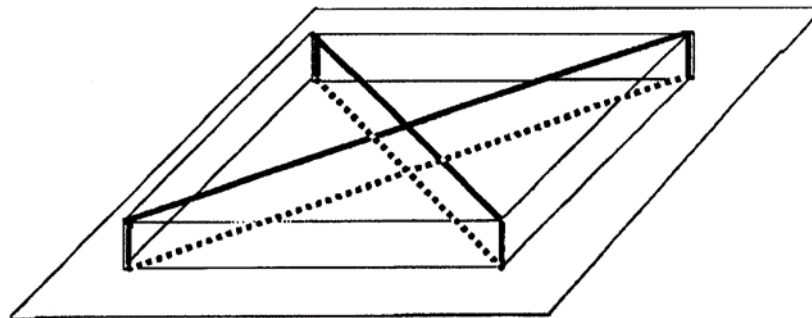

Figure 1-4. Slice Thickness Phantom

Triangular blocks make 4" x 4" square with diagonal gaps of 1 or 2 mm. Four triangular blocks are glued with 1 mm or 2 mm gap.

A ramp-crossing angle of 90° yields an angle of 45° between the ramp and the imaging slice plane. Each slice thickness section consists of four triangular blocks arranged to form (signal producing) hot ramps filling the gaps of 1 mm or 2 mm (Figure 1-5).

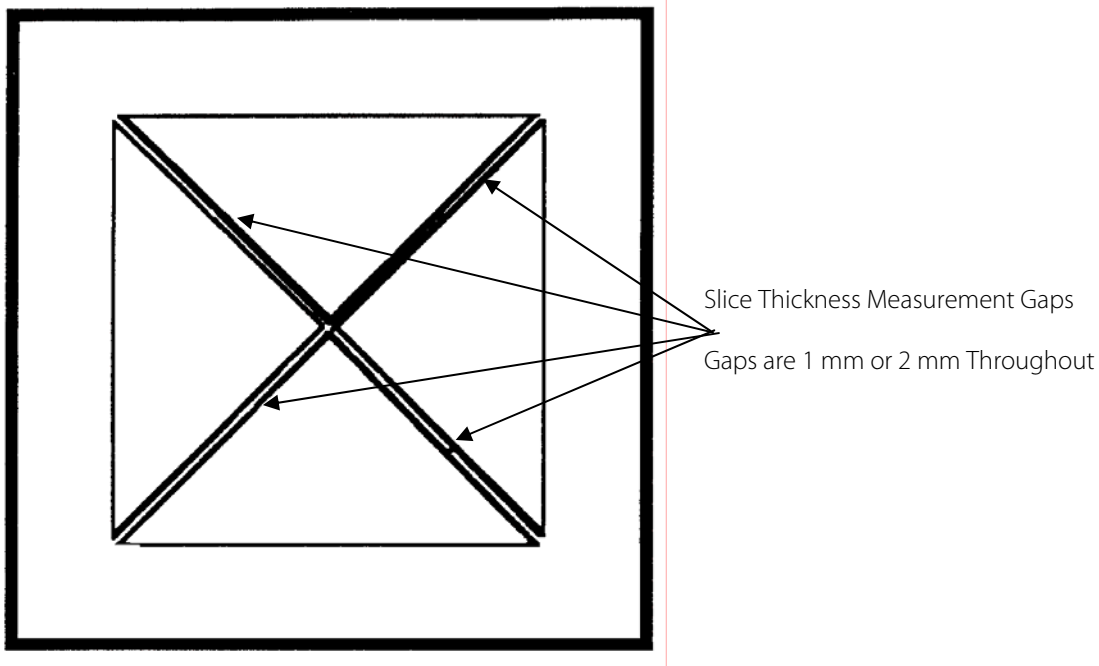

Figure 1-5. Slice Thickness Sections

The ramps of the 1 mm gaps (forming diagonal lines) are glued at the opposite side inner wall of the 3DRAS phantom. Two sets of ramp sections are included in the phantom in order to allow the slice thickness measurements in all three dimensions.

In a single multi-slice scan, the user can obtain images for signal-to-noise ratio, resolution in two directions, slice thickness, and slice-to-slice gap.

1.2.2 Uniformity and Linearity (UAL) Phantom (76-907)

The UAL phantom has outer dimensions of 13" x 13" x 4" (Figure 1-6) with a small bubble (Figure 1-7) filled with a solution attached on the surface of the phantom. A rectangular shape was adopted for ease of reproducible positioning. Two parts of the phantom, flood and grid, are incorporated into one.

MR Phantom for Spatial Linearity, Signal-To-Noise, and Image Artifact

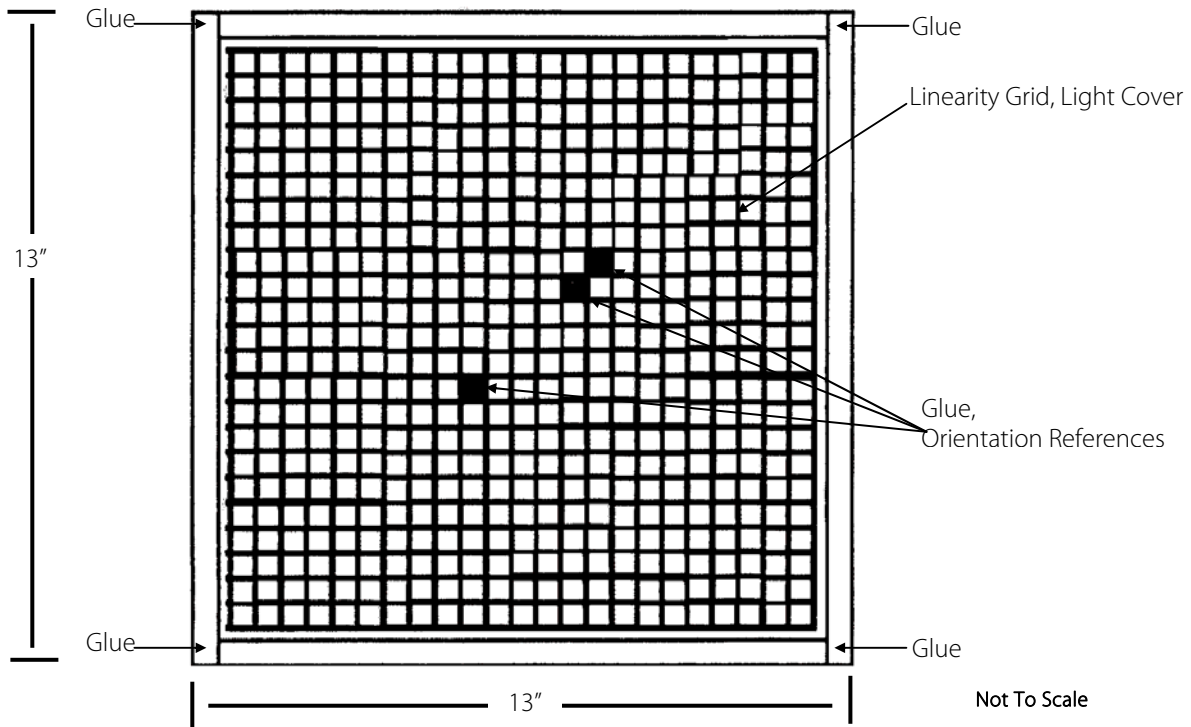

Figure 1-6. UAL Phantom

MRI Phantom for Spatial Linearity, Signal-To-Noise, and Image Artifact

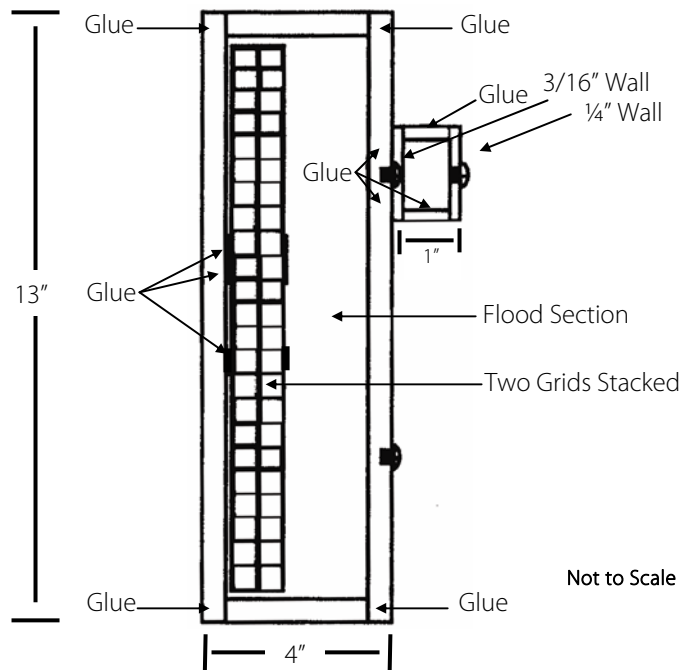

Figure 1-7. UAL Phantom with Side View

The flood phantom has a uniform solution, the image of which can be used to measure the uniformity in signal intensity in the images. The grid section consists of grids that can be used to assess geometric linearity.

A small pancake shaped container holding producing solution is attached on the diagonal surface of the phantom. It is used to detect phase errors.

Section 2

Operation

2.1 Phantom Preparation

The phantoms can be shipped filled with solutions or solutions can be shipped separately. Each user can also prepare a solution.

2.1.1 Signal Producing Solution

At each operating field strength, AAPM recommends that the chosen NMR material should exhibit the following characteristics:

100 msec < T1 < 1200 msec

400 msec > T2 > 50 msec

proton density = H₂O density

One of the following solutions is suggested as a signal producing solution. It should be noted that relaxation times are both temperature and field strength dependent. The relaxation rates (inverse of relaxation times) are approximately linear with ion concentration.

<u>Agent</u>	<u>Concentration</u>	<u>T1</u>	<u>T2</u>
CuSO ₄	1-25mM	860-40 msec	625-38 msec
NiC ₁₂	1-25mM	806-59 msec	763-66 msec
Propanediol	0-100%	2134-217 msec	485-72 msec
MnC ₁₂	0.1-1mM	982-132 msec	--

2.1.2 Filling the Phantom

Degassed water should be used to make MR solution. Water can be degassed by boiling and cooling. The following amount of water should be prepared:

Cubical Phantom: 4,000 cc/4 liters

Flood Phantom: 12,000 cc/12 liters

Once the solution has been prepared, it is recommended that several drops of wetting agent be added to reduce surface tension and that some hydrochloric acid be added as a fungicide. As the solution is poured into the phantom one should watch for air bubbles, especially any trapped in the resolution section. It is recommended that the phantom be placed in a vacuum chamber for several hours to remove the trapped bubbles.

2.2 Preparation for Scanning

2.2.1 Positioning the Phantom

The 3DRAS phantom can be placed in a head coil or a body coil. The center of the phantom should coincide approximately with the center of the RF coil. The UAL phantom can be used only with a body coil.

2.2.2 Scanning Parameters

For all measurements, scan conditions should be carefully recorded. Scan conditions records should include:

- Any image processing which may have been used
- Field-of-view or zoom factor
- Image matrix size
- Imaging coil
- Number of signal (excitation) acquisitions
- Phantom and phantom material
- Pulse sequence name or code and software version number
- RF power settings
- Scan timing parameters (TE, TI, TR)
- Slice excitation order
- Slice number and thickness
- Tuning parameters

2.3 Tests with 3D Resolution and Slice (3DRAS) Phantom

2.3.1 Resonance Frequency

Resonance frequency is defined as that RF frequency (f) which matches the static B-field (B_0) according to the Larmor equation. For protons, the Larmor frequency is 42.58 MHz/Tesla, e.g., for a 1.5 Tesla system, the resonance frequency should be 63.87 MHz.

Prior to the performance of any imaging protocol, the resonance frequency must be checked first. Changes in the resonance frequency reflect changes in the static magnetic field (B-field). Changes in the B-field may be due to superconductor "run down" (typically on the order of 1 ppm/day, e.g., about 60 Hz/day at 1.5 Tesla), changes in current density due to thermal or mechanical effects, shim-coil changes, or effects due to external ferromagnetic materials.

The effects of off-resonance operation relate primarily to a reduction in image signal-to-noise. Secondary effects are reflected in image linearity due to the summation of the image gradients with the inconsistent static B-field value.

It is recommended that a resonance frequency check be performed prior to any measurements and each time a different phantom is used.

The phantom is positioned in the center of the magnet (with all gradient fields turned off) and the RF frequency is adjusted by controlling the RF synthesizer center frequency to achieve maximum signal. Some resistive systems may also allow adjustment of the magnet current in order to alter the magnetic field strength so as to achieve resonance. Most vendors will provide a specific user protocol for

resonance frequency adjustment and some may be completely automated. Resonance frequency should be recorded daily for trend analysis.

Values of resonance frequency should generally not deviate by more than 50 ppm between successive daily measurements.

2.3.2 Signal-To-Noise Ratio

The signal is defined as the mean pixel value within the region-of-interest minus any pixel offset. Noise is defined as the random variations in pixel intensity. Images with obvious artifacts are not suitable for signal-to-noise ratio (SNR) determinations.

Factors contributing to variations in signal-to-noise include:

- (1) General system calibration (resonance frequency, flip angles)
- (2) Slice thickness
- (3) Coil tuning
- (4) RF shielding
- (5) Coil loading
- (6) Image processing
- (7) Scan parameters (TR, TE)
- (8) T-1 and T-2 solution values

When using large volume fluid-filled phantoms, it should be recognized that thermal and mechanically induced motions can introduce artifacts. The unloaded coil allows the evaluation of system noise that is the parameter of interest. In a clinical scan, it is recognized that the patient is the dominant source of noise. In order to approximate the clinical situation, the coil must be electrically loaded by using an appropriate filler material.

The signal is measured using a ROI that contains at least 100 pixels or 10% of the area of the signal producing material, whichever is greater. The ROI should be positioned in the center of the image and should not include any obvious artifacts. The signal is the mean value of the pixel intensity in the ROI minus any offset. (An indication of the existence of an image intensity offset may be gained from an examination of intensity values from ROI's taken over non-signal producing portions of a phantom. Specific offset values should be obtained from the system manufacturer). The noise is the standard deviation derived from the same ROI. The signal-to-noise ratio is then calculated.

2.3.3 High-Contrast Spatial Resolution

High contrast spatial resolution is a measure of the capacity of an imaging system to show separation of objects when there is no significant noise contribution. High contrast spatial resolution for MRI systems is typically limited by pixel size (field-of-view divided by the sampling in x or y). Traditionally, resolution has been quantified by the point spread function (PSF), line spread function (LSF), or modulation transfer function (MTF); however, these methods are not practical for routine measurements. Therefore, a visual evaluation of test objects is used.

Factors contributing to high-contrast resolution include:

- Field-of-view (determined by gradient strength, acquisition matrix, sampling period), and image reconstruction and display method.
- The image will be evaluated visually. Image analysis consists of viewing the image to determine the smallest resolvable hole array (magnification may be used if desired). For an array to be resolved, all holes and spaces must be displayed as separate and distinct then viewed with the narrowest window width. The window level should be adjusted for optimum visualization.

- The high contrast resolution should remain constant for repeated measurements under the same scan conditions and should be equal to the pixel size. For example, for a 25.6 cm field of view with a 256 x 256 acquisitions matrix, the resolution should be 1 mm.

2.3.4 Slice Thickness

Slice thickness is defined as the full width at half maximum (FWHM) of a slice profile. The full width at tenth maximum (FWTM) is an additional descriptor of the slice profile. The slice profile is defined as the response of the magnetic resonance imaging system to a point source as it moves through the plane of the reconstruction at that point.

Factors Affecting Slice Thickness include the following:

- (1) Gradient field non-uniformity
- (2) RF field non-uniformity
- (3) Non-uniform static magnetic field,
- (4) Non-coplanar slice selection pulses between excitation and readout gradient
- (5) TR/T1 ratio
- (6) RF pulse shape and stimulated echoes

Any typical multi-slice acquisition may be used provided TR is greater than 3T1 of the filler material and the highest pixel resolution is used. Slice thickness should be measured both centrally and peripherally within an image and at both central (magnet isocenter) and offset slice locations.

High signal ramps (HSR) at 90 degrees to each other are used for slice thickness measurement. The ramps have 1 mm gaps on one side and 2 mm gaps on the opposite side

Slice thickness (FWHM, FWTM):

In the resultant image, the signal level is read out across the ramp on a pixel-by-pixel basis along a line-of-interest oriented orthogonally to the ramp width dimension. As noted previously, to assure adequate S/N, it may be necessary to either use multiple excitations or several line profiles. The FWHM or FWTM parameters should be determined for each of the dual ramps. The FWHM from imaging opposed high signal ramps oriented at a 45 degree angle with respect to the image plane is equal to the square root of the product of a and b where a and b are the FWHM of the intensity profile of ramps 1 and 2.

Assuring adequate measurement accuracy, the measured value of slice thickness should generally agree with the indicated slice thickness within the 1 mm for slice thicknesses greater than 5 mm.

2.3.5 Slice Position and Separation

Slice position is the absolute location of the midpoint of the FWHM of the slice profile. Slice separation is the distance between any two-slice positions. Slice locations are indicated by external positioning devices or by the selected inter-slice spacing.

Factors Affecting Slice Position/Separation

- (1) Misalignment of positioning devices
- (2) Gradient field non-uniformity
- (3) B-1 non-uniformity
- (4) Non-coplanar slice selection pulses
- (5) Static magnetic field

The midpoint of the FWHM of the slice profile in the image of interest is determined. The distance from the profile midpoint to a landmark that remains stationary from slice-to-slice (parallel to the slice selection

direction) is measured and related to the slice position. For a 45° ramp, the distance from a centered reference pin to the slice profile midpoint will be equal to the point of the ramps located at the isocenter.

All measurements should be made along the line made up of the magnet isocenter and the centers of the imaging planes.

Comparison of external position marker should generally agree with the actual slice position within +2 mm. Slice separation disagreement should typically be less than 20% of the total slice separation or whichever is greater.

2.3.6 Example Images

Figures 2-1 through 2-12 represent examples of images obtained using the phantom in a 1.5 T MR system.

Figure 2-1 is an axial image with imaging parameters of TR=60 msec, TE=22 msec and slice thickness of 3 mm. This axial image from a body coil shows resolution holes of 2 mm, 1 mm, and 0.75 mm well resolved. There are two sets of holes shown in vertical and horizontal directions. The resolution image can be viewed in a zoom mode. Thin vertical lines from the resolution pin within two black blocks are placed in other orientations and have no meaning in axial orientation.

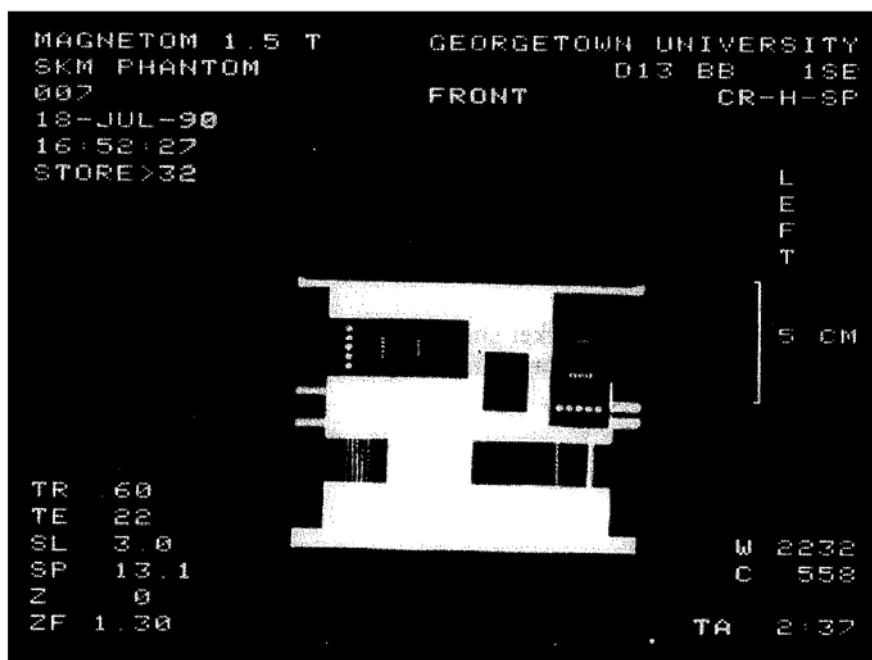

Figure 2-1.

On the right and left-hand sides of the phantom image two sets of horizontal short lines are shown. They represent the slice thickness image of hot ramps sandwiched between two cold ramps. The thinner set is from the 1 mm ramp and the thicker set comes from the 2 mm ramp. A set of two crossed ramps are used as shown in Figure 1-4.

It should also be noted that the gap between the slice thickness lines on the left side of the figure is larger than that on the right, indicating that the phantoms were not placed properly in the MRI system. In a proper setting the gaps should be identical on both sides.

Figures 2-2 and 2-3 represent two adjacent sagittal views of the phantom. The resolution holes are well resolved in vertical and horizontal direction and the two slices are 6 mm apart (SP = 14.5 and 20.5). The slice thickness images of short vertical lines on top and bottom of the phantom image again are from the crossed hot ramps of 2 mm (top) and 1 mm (bottom).

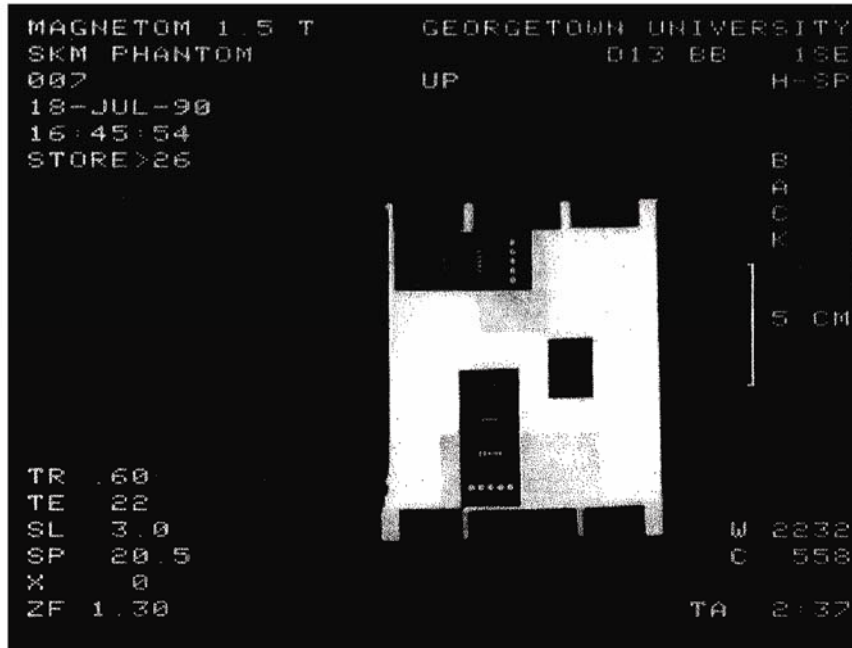

Figure 2-2.

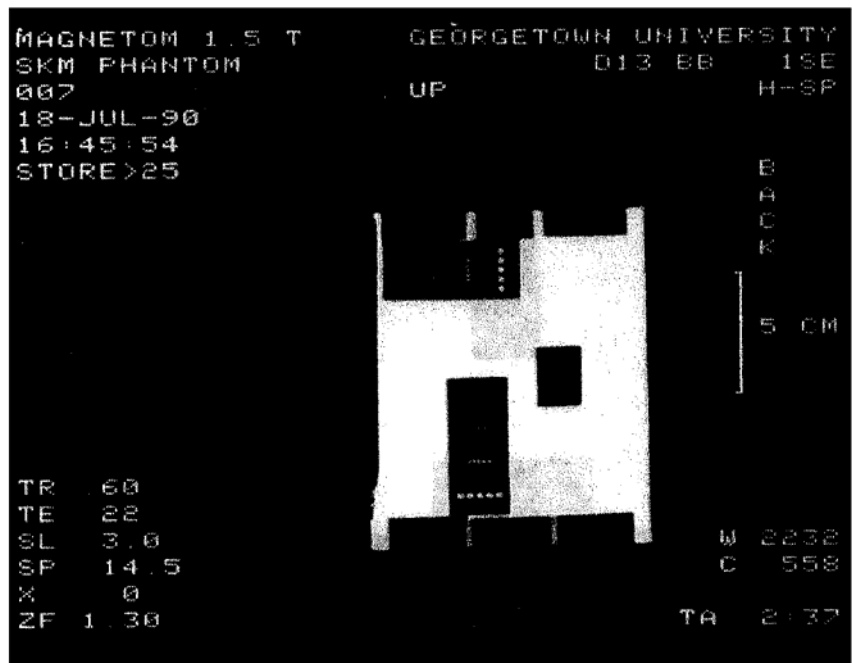

Figure 2-3.

Figures 2-4 and 2-5 show two adjacent coronal views of the phantom. The slice thickness lines of 1 mm ramps on the right and bottom of the images are too faint to be seen.

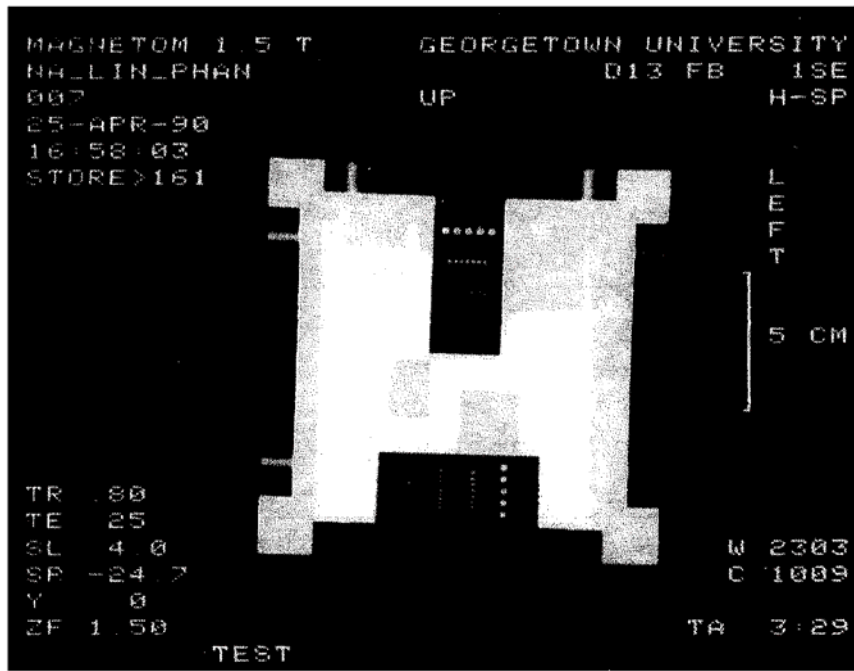

Figure 2-4.

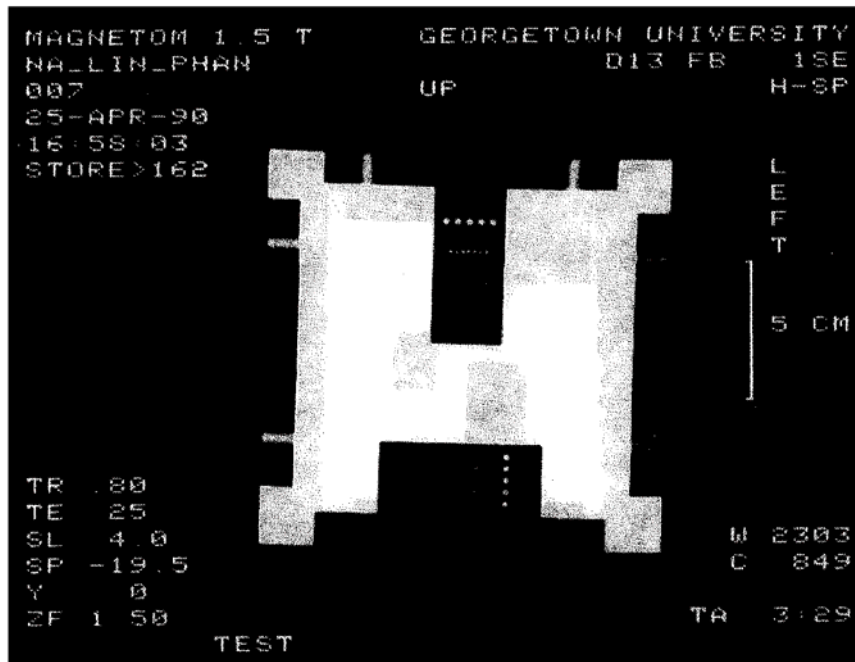

Figure 2-5

Figure 2-6 shows a resolution hole image against a background less opaque than in previous images, indicating that the position of the resolution block is such that it is partially covered by the slice. For resolution measure, it is advised to use a slice that covers the central portion of the slice hole section.

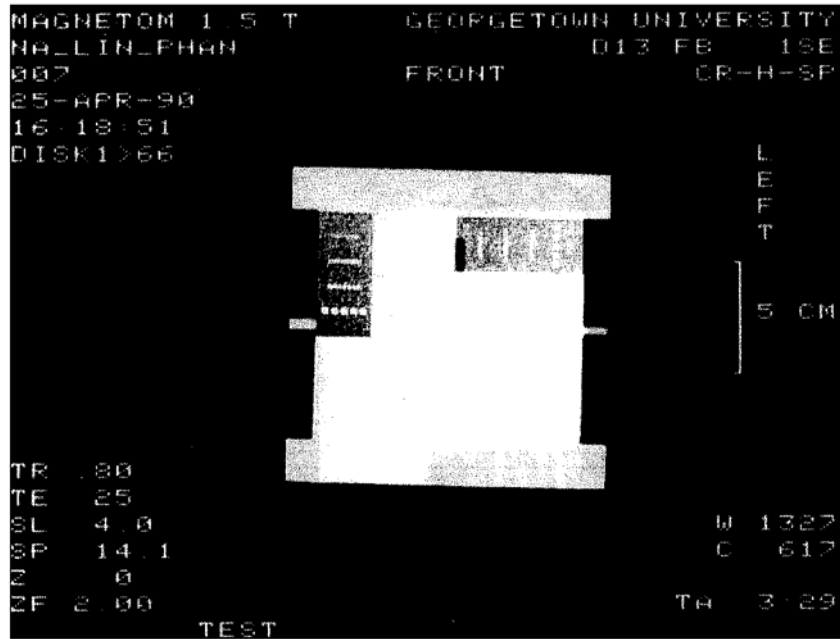

Figure 2-6

Figures 2-7 and 2-8 show an example of the slice thickness measurement analysis. A signal intensity profile is drawn vertically through a set of slice thickness ramp Images. The profile is the slice thickness profile. One can also obtain the slice thickness by measuring full width half maximum of the profile. Figure 2-8 represents the same data using a larger zoom factor.

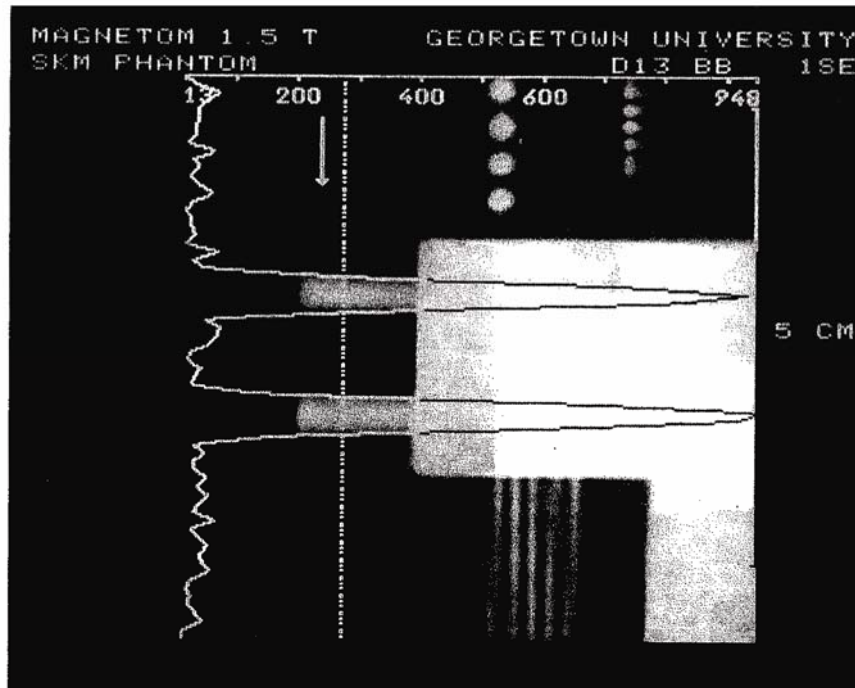

Figure 2-7.

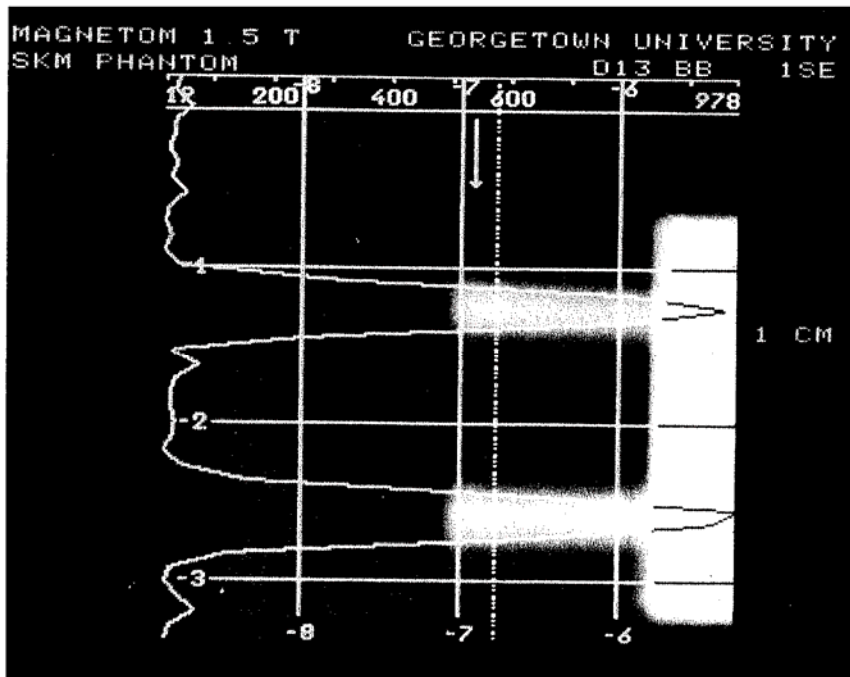

Figure 2-8

2.4 Tests With Uniformity and Linearity (UAL) Phantom

2.4.1 Image Uniformity

Image uniformity refers to the ability of the MR imaging system to produce a constant signal response throughout the scanned volume when the object being imaged has homogeneous MR characteristics.

Factors Affecting Image Uniformity include:

- (1) Static-field inhomogeneities
- (2) RF field non-uniformity
- (3) Eddy currents
- (4) Gradient pulse calibration
- (5) Image processing

Any typical multi-slice acquisition may be used provided the signal-to-noise ratio is sufficiently large so that it does not affect the uniformity measurement. Adequate signal-to-noise may be insured by either increasing the number of acquisitions (NEX) or by applying a low-pass smoothing filter. In practice, it has been found that a signal-to-noise ratio of 80:1 or greater will yield good results.

For pixels within a centered geometric area that encloses approximately 75% of the phantom area, the maximum (S max) and minimum (S min) values are determined. Care should be taken to not include edge artifacts in the ROI.

A range (R) and mid-range value S are calculated as follows:

$$R = (S \text{ max} - S \text{ min}) / 2$$

$$S = (S \text{ max} + S \text{ min}) / 2$$

The relationship for calculating integral uniformity (U) is:

$$U = (1 - (R/S)) \times 100\%$$

Perfect integral uniformity using this relationship is when U = 100%

In some cases (e.g., low-field imaging) signal-to-noise may be a limiting factor in the measurement of image uniformity. To help minimize the effect of noise on the measurement the image may be convolved with a 9-point low-pass filter.

For a 20 cm field-of-view or less, the uniformity should be typically 80% or better. It should be realized that for larger fields-of-view, the uniformity may diminish. Image uniformity in the above context is not defined for surface coils.

SNR results are only applicable to the specific system, phantom and scan conditions. It is important to re-emphasize that the signal and noise measurements are dependent on essentially all scan parameters and test conditions. SNR should be normalized to voxel size for comparison.

2.4.2 Spatial Linearity (Distortion)

Spatial linearity describes the degree of geometrical distortion present in images produced by any imaging system. Geometrical distortion can refer to either displacement of displayed points within an image relative to their known location, or improper scaling of the distance between points anywhere within the image.

The primary factors that introduce geometrical distortion in MR imaging are:

- (1) Inhomogeneity of the main magnetic field

(2) Non-linear magnetic field gradients

Variability is best observed over the largest field-of-view. The phantom should occupy at least 60% of the largest field-of-view. Figure 1-1 provides an illustration of a pattern that is used to evaluate spatial linearity.

Consideration should be given to determining the spatial linearity for a typical multi-slice acquisition with the largest available image matrix to maximize spatial resolution. Since NMR imaging is inherently a volumetric imaging technique, the evaluation should be performed for each orthogonal plane to define the useful imaging volume. Spatial linearity is not expected to depend significantly on image timing parameters such as TE, TR, and the number of signal acquisitions.

$$\text{Percent distortion} = (\text{true dimension} - \text{observed dimension}) / \text{true} \times 100\%$$

Distortion measurement may be performed between any two points within the field-of-view, provided that pixel-resolution is not a significant source of error. It is recommended that the true dimension be greater than 10 pixels. Spatial linearity measurements performed directly on the image-processing unit will provide information only about the MR imaging system. Measurements can also be performed upon filmed images and will provide combined performance information about the MR imager, as well as the video and filming systems.

Percent distortions in the linearity are generally acceptable if they are less than 5%.

2.4.3 Image Artifacts

Phase related errors are defined in terms of inappropriate (either increased or decreased) image signal at specified spatial locations. Generally, these artifacts are characterized by increased signal intensity in areas that are known to contain no signal producing material. Commonly called "ghosts," the application of phase-encoding gradients for imaging and errors in both RF transmit and receive quadrature phase, result in unique ghost artifacts. A "DC-offset" error is defined here as high-intensity or low-intensity pixels at the center of the image matrix due to improper scaling of low-frequency components (typically DC) in the Fourier transformation of the NMR time domain signal.

- (1) Phase encoding gradient instability
- (2) Quadrature phase maladjustment in the synthesis of slice selective RF pulses (transmit error)
- (3) Improper quadrature phase decoding on receive

Any typical multi-slice sequence may be used. Separate scans must be made to assess both transmit and receive errors if a phantom similar to the phantom in Figure 1-5 is used. More complex volume phantoms may be designed which both transmit and receive errors and may be assessed with a single scan sequence. The scan for assessing receive quadrature errors is made with the phantom placed at the magnet isocenter with the central slice of the multi-slice sequence passing through the phantom. The same scan may be used to assess both DC-offset and phase encoding errors. The scan for assessing transmit quadrature errors is made with the phantom placed at a convenient offset slice position (typically either + or - S cm from the isocenter slice) with the center slice passing through the magnet isocenter and an offset slice passing through the phantom.

Phase Encoding Errors: Phase-encoding ghosts will appear as multiple images (possibly smeared into a column) originating at the true object position but displaced along the phase-encoding axis of the image (perpendicular to the frequency encoding direction). The presence of these characteristic ghost images will generally identify the two axes; however, the orientations should be verified by the manufacturer or the operator's manual. Regions-of-interest values are taken from both the true image and the brightest ghost image. The magnitude of the error (E) is quantified by expressing the ghost ROI value (G) as a percent of the true ROI (T):

$$E = ((T-G)/T) \times 100\%$$

DC-Offset Errors

DC-offset errors typically appear as a single bright pixel (sometimes as a dark pixel if overflow or processing has occurred) at the center of the image matrix. The existence of this error is assessed visually.

Receive Quadrature Errors

Receive quadrature ghosts will be evaluated using the central slice of the multi-slice sequence acquired with the phantom at the isocenter. Receive ghosts will appear upside down and reversed from the true signal producing objects (object in the upper left-hand corner will appear as a ghost in the lower right-hand corner). Regions-of-interest values are taken from both the true image and the ghost image. The receive Quadrature Error (E) is quantified by expressing the ghost ROI value (G) as a percent of the true ROI (T).

$$E = ((T-G)/T) \times 100\%$$

Transmit Quadrature Errors

Transmit quadrature ghosts are evaluated using images acquired in the multi-slice mode in which the phantom is placed at a location offset from the isocenter. A transmit ghost appears in the slice located in the opposite offset direction at a distance equal to the distance at which the true object is located from the isocenter (mirror image from the isocenter). The ghost and true object image will be located at the same relative positions in their respective images. For example, a true object located in the upper left corner at a distance of +5 cm from the isocenter will produce a transmit quadrature ghost in the upper left corner of the image at -5 cm ROI's taken over the true object and the ghost are used to determine the percent error (E).

$$E = ((T-G)/T) \times 100\%$$

2.4.4 Action Criteria

Phase related errors should typically be less than 5% of the true signal value. DC-offset errors should not be present in images from a properly functioning system.

2.4.5 Example Images

Figure 2-9 is an image of the linearity section of the phantom demonstrating the non-linearity that exists in the magnetic field especially on the outer edge of the field of view. Three black squares are markers for phantom orientations.

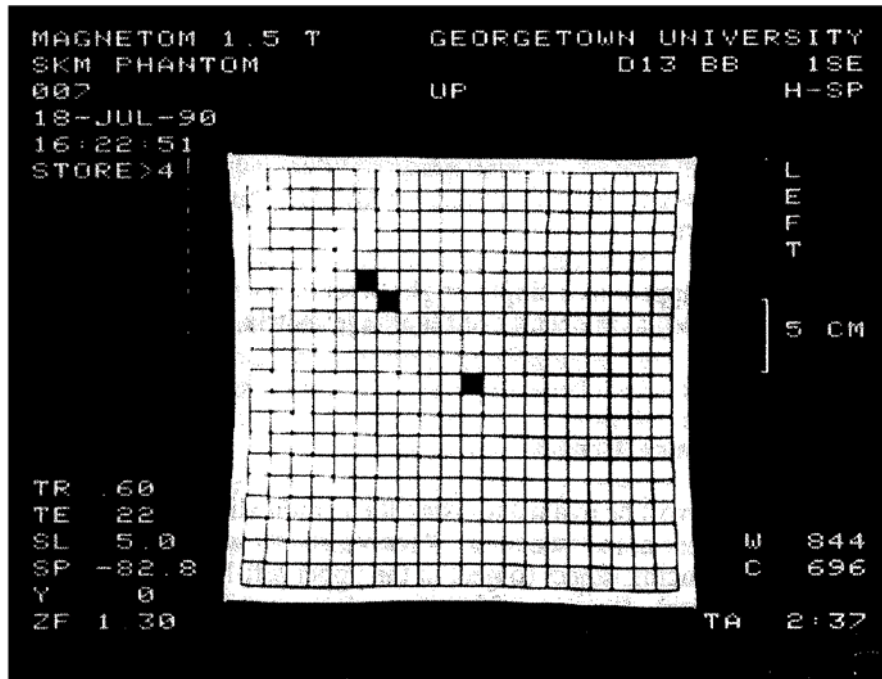

Figure 2-9

Figure 2-10 is a flood image showing the uniformity of signal intensity. Field non-uniformity is also shown on the outer edges.

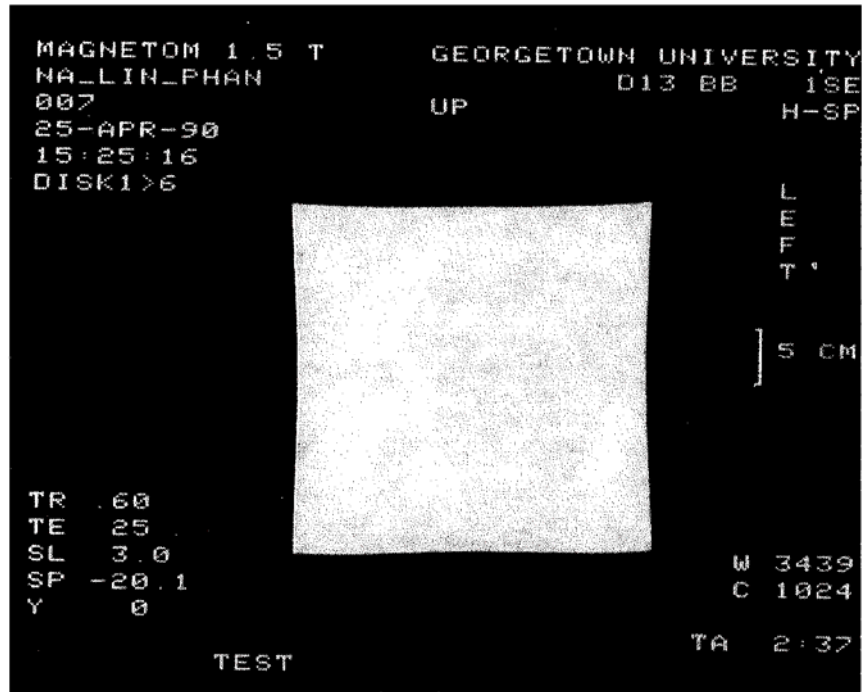

Figure 2-10

Figure 2-11 shows a horizontal intensity profile with a narrow window setting. Such information can be used as baseline data.

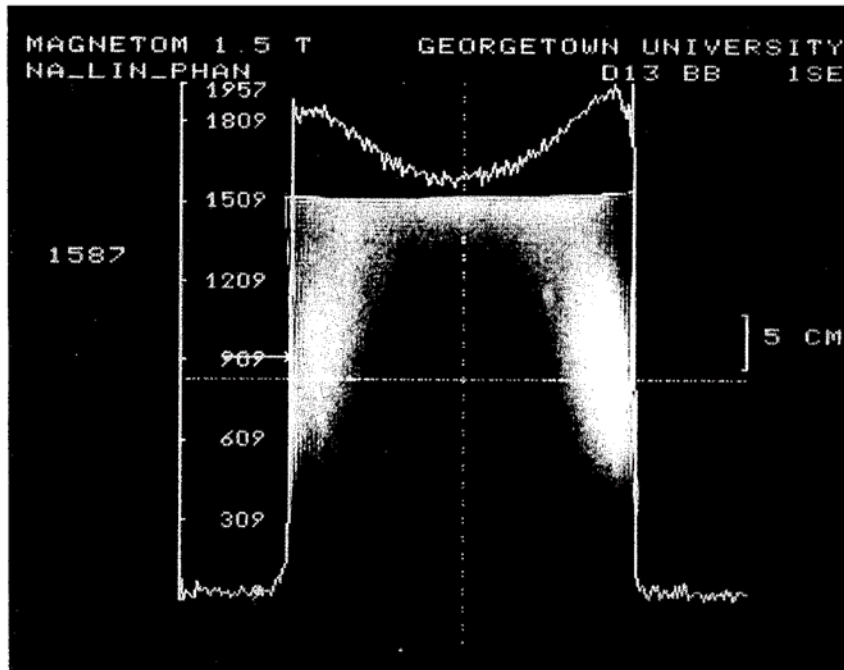

Figure 2-11

Figure 2-12 is an image of the signal bubble for quadrature error. If there were any quadrature phase error, another ghost circle would be visible in the lower right-hand corner of the image. Quadrature error has become less common in most of the recent MRI systems.

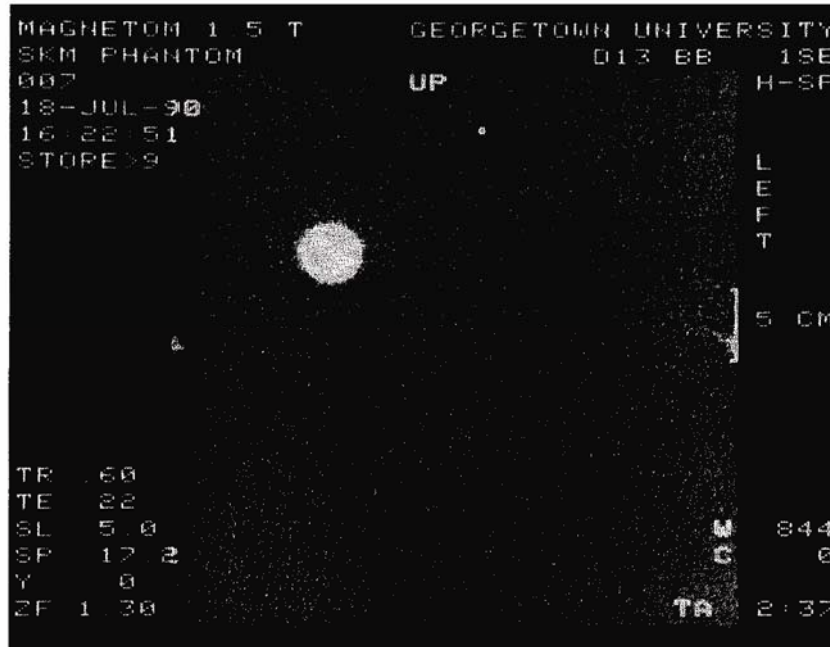

Figure 2-12

Fluke Corporation
Radiation Management Services

6045 Cochran Road
Cleveland, Ohio 44139
440.498.2564

www.flukebiomedical.com/rms

Free Manuals Download Website

<http://myh66.com>

<http://usermanuals.us>

<http://www.somanuals.com>

<http://www.4manuals.cc>

<http://www.manual-lib.com>

<http://www.404manual.com>

<http://www.luxmanual.com>

<http://aubethermostatmanual.com>

Golf course search by state

<http://golfingnear.com>

Email search by domain

<http://emailbydomain.com>

Auto manuals search

<http://auto.somanuals.com>

TV manuals search

<http://tv.somanuals.com>