

FLUKE®

Hart Scientific®

1529

*Chub-E4 Thermometer Readout
User's Guide*

Rev. 692801

Limited Warranty & Limitation of Liability

Each product from Fluke Corporation, Hart Scientific Division ("Hart") is warranted to be free from defects in material and workmanship under normal use and service. The warranty period is 2 years for the Thermometer Readout. The warranty period begins on the date of the shipment. Parts, product repairs, and services are warranted for 90 days. The warranty extends only to the original buyer or end-user customer of a Hart authorized reseller, and does not apply to fuses, disposable batteries or to any other product, which in Hart's opinion, has been misused, altered, neglected, or damaged by accident or abnormal conditions of operation or handling. Hart warrants that software will operate substantially in accordance with its functional specifications for 90 days and that it has been properly recorded on non-defective media. Hart does not warrant that software will be error free or operate without interruption. Hart does not warrant calibrations on the Thermometer Readout.

Hart authorized resellers shall extend this warranty on new and unused products to end-user customers only but have no authority to extend a greater or different warranty on behalf of Hart. Warranty support is available if product is purchased through a Hart authorized sales outlet or Buyer has paid the applicable international price. Hart reserves the right to invoice Buyer for importation costs of repairs/replacement parts when product purchased in one country is submitted for repair in another country.

Hart's warranty obligation is limited, at Hart's option, to refund of the purchase price, free of charge repair, or replacement of a defective product which is returned to a Hart authorized service center within the warranty period.

To obtain warranty service, contact your nearest Hart authorized service center or send the product, with a description of the difficulty, postage, and insurance prepaid (FOB Destination), to the nearest Hart authorized service center. Hart assumes no risk for damage in transit. Following warranty repair, the product will be returned to Buyer, transportation prepaid (FOB Destination). If Hart determines that the failure was caused by misuse, alteration, accident or abnormal condition or operation or handling, Hart will provide an estimate or repair costs and obtain authorization before commencing the work. Following repair, the product will be returned to the Buyer transportation prepaid and the Buyer will be billed for the repair and return transportation charges (FOB Shipping Point).

THIS WARRANTY IS BUYER'S SOLE AND EXCLUSIVE REMEDY AND IS IN LIEU OF ALL OTHER WARRANTIES, EXPRESS OR IMPLIED, INCLUDING BUT NOT LIMITED TO ANY IMPLIED WARRANTY OF MERCHANTABILITY OR FITNESS FOR A PARTICULAR PURPOSE. HART SHALL NOT BE LIABLE FOR ANY SPECIAL, INDIRECT, INCIDENTAL, OR CONSEQUENTIAL DAMAGES OR LOSSES, INCLUDING LOSS OF DATA, WHETHER ARISING FROM BREACH OF WARRANTY OR BASED ON CONTRACT, TORT, RELIANCE OR ANY OTHER THEORY.

Since some countries or states do not allow limitation of the term of an implied warranty, or exclusion or limitation of incidental or consequential damages, the limitations and exclusions of this warranty may not apply to every buyer. If any provision of this Warranty is held invalid or unenforceable by a court of competent jurisdiction, such holding will not affect the validity or enforceability of any other provision.

Fluke Corporation, Hart Scientific Division

799 E. Utah Valley Drive • American Fork, UT 84003-9775 • USA
Phone: +1.801.763.1600 • Telefax: +1.801.763.1010
E-mail: support@hartscientific.com

www.hartscientific.com

Subject to change without notice. • Copyright © 2005 • Printed in USA

Table of Contents

1	Before You Start	1
1.1	Symbols Used	1
1.2	Safety Information	2
1.2.1	Warnings	2
1.2.2	Cautions	3
1.3	Authorized Service Centers.	4
2	Introduction	7
3	Specifications and Environmental Conditions	9
3.1	Specifications	9
3.2	Environmental Conditions.	10
4	Quick Start	11
4.1	Unpacking	11
4.2	Use Proper Care	11
4.3	Learn About the Features and Components	11
4.4	Connect the Probe	11
4.4.1	Using the Clamp-on Ferrites	12
4.5	Connect the Power Source	12
4.6	Switch the Power On	12
4.7	Measure Temperature	13
5	Parts and Controls	15
5.1	Front Panel Buttons	15
5.2	Back Panel.	17
5.3	Accessories	17
6	General Operation	19
6.1	Display	19
6.2	Changing Units	19
6.3	Battery.	19
6.4	Probe Input Modules	20
6.4.1	Connecting a PRT or Thermistor Probe	21
6.4.2	Connecting a Thermocouple	21
6.5	DC Power Source	23

6.6	Power On Self-Test	23
6.7	Display Backlight and Contrast	23
6.8	Taking Measurements	23
6.8.1	Connecting the Sensor	23
6.8.2	Enabling the Channel	24
6.8.3	Selecting Conversion Type and Probe Characterization	24
6.9	Fast Measurement Mode	24
6.10	Data Logging	25
7	Menu Functions.	27
7.1	Channel Menu	27
7.1.1	Measure Period and Fast Measurement Mode	28
7.1.2	Enable Channel	30
7.1.3	Channel Mode.	31
7.1.4	Moving Average.	31
7.1.5	Display Options/Auto-Cal	32
7.2	Probe Menu	33
7.2.1	Edit Probe	34
7.2.1.1	ITS-90 Conversion	36
7.2.1.2	ITS-SR5.	37
7.2.1.3	PT-100 Conversion	38
7.2.1.4	Callendar-Van Dusen (CVD) conversion.	38
7.2.1.5	RES Conversion.	39
7.2.1.6	Thermistor T(R) Conversion [THERM-T]	39
7.2.1.7	Thermistor R(T) Conversion [THERM-R]	40
7.2.1.8	YSI-400 Conversion	40
7.2.1.9	Thermocouple Volts [Vin[mV]]	40
7.2.1.10	Standard Thermocouple Conversions.	41
7.2.1.11	Thermocouple Polynomial Conversion.	41
7.2.2	Copy Probe	42
7.2.3	Test Probe	43
7.2.4	Print Probe	43
7.2.5	Default Probe	44
7.3	Fields Menu	45
7.3.1	Clear Stats.	46
7.3.2	Select Fields.	47
7.3.3	Edit Fields.	49
7.3.4	Default Fields	49
7.3.5	Display Options.	50
7.4	Logging Menu.	51
7.4.1	Demand Log	52
7.4.1.1	Store Reading	53
7.4.1.2	Log History	54
7.4.1.3	View Data.	55
7.4.1.4	Print Data	56
7.4.1.5	Delete Data	57
7.4.2	Auto Log	58
7.4.2.1	Logging Options	59
7.4.2.2	Start Stop	60
7.4.2.3	View Data.	62
7.4.2.4	Print Data	63

7.4.2.5	Delete Data	63
7.4.3	Log Stats	64
7.4.4	Data Labels	65
7.4.5	Default Labels	66
7.5	System Menu	67
7.5.1	Comm Setup	68
7.5.1.1	Serial	69
7.5.1.2	GPIB (Optional)	70
7.5.2	Date Time	70
7.5.3	Password	71
7.5.4	Calibration	73
7.5.5	System Reset	75

8 Digital Communications Interface 77

8.1	Overview	77
8.2	Communications	77
8.2.1	Serial Wiring	77
8.2.2	GPIB Communications	78
8.2.2.1	Capability	78
8.2.2.2	Connection	78
8.2.2.3	Device Setup	78
8.3	Interface Commands	78
8.3.1	Command Summary	78
8.3.2	Command Syntax	83
8.4	Commands	84
8.4.1	Measurement Commands	86
8.4.1.1	CALCulate:AVERage:CLEar	86
8.4.1.2	CALCulate<chn>:AVERage<n>:DATA?	86
8.4.1.3	CALCulate:AVERage<n>:TYPE?	86
8.4.1.4	FETCh? [<chn>]	87
8.4.1.5	FORMat:STAMp?	88
8.4.1.6	FORMat:STAMp <bool>	88
8.4.1.7	MEASure? [<chn>]	88
8.4.1.8	READ? [<chn>]	88
8.4.1.9	SENSe<chn>:DATA?	88
8.4.2	Measurement Control Commands	88
8.4.2.1	INITiate	89
8.4.2.2	INITiate:CONTinuous?	89
8.4.2.3	SENSe:AVERage:COUNT? [MINIMAXIDEF]	89
8.4.2.4	SENSe:AVERage:COUNT <num> MINIMAXIDEF	89
8.4.2.5	SENSe<chn>:RESistance:RANGe? [MINIMAXIDEF]	89
8.4.2.6	SENSe<chn>:RESistance:RANGe <num> MINIMAXIDEF	90
8.4.2.7	SENSe<chn>:RESistance:WIRE? [MINIMAXIDEF]	90
8.4.2.8	SENSe<chn>:RESistance:WIRE <num> MINIMAXIDEF	90
8.4.2.9	TRIGger:TIMER? [MINIMAXIDEF]	91
8.4.2.10	TRIGger:TIMER <num> MINIMAXIDEF	91
8.4.3	Channel Commands	91
8.4.3.1	ROUTE:CLOSe? <chn>	91
8.4.3.2	ROUTE:CLOSe <chn>	92
8.4.3.3	ROUTE:OPEN? <chn>	92
8.4.3.4	ROUTE:OPEN <chn>	92
8.4.3.5	ROUTE:SCAN?	92
8.4.3.6	ROUTE:SCAN <chn list>	92
8.4.3.7	ROUTE:SCAN:MODE? [MINIMAXIDEF]	92
8.4.3.8	ROUTE:SCAN:MODE <num> MINIMAXIDEF	93

8.4.4	Probe Commands	93
8.4.4.1	CALCulate<chn>:CONVert:CATalog?	93
8.4.4.2	CALCulate<chn>:CONVert:COPY <dest chn> ALL	93
8.4.4.3	CALCulate<chn>:CONVert:NAME?	94
8.4.4.4	CALCulate<chn>:CONVert:NAME <conv>	94
8.4.4.5	CALCulate<chn>:CONVert:PARAmeter:CATalog?	94
8.4.4.6	CALCulate<chn>:CONVert:PARAmeter:VALue? [<param> ALL]	95
8.4.4.7	CALCulate<chn>:CONVert:PARAmeter:VALue <param>,<num>[,< param>,<num>...]	95
8.4.4.8	CALCulate:CONVert:PRINt [<chn> ALL [,<port>]]	95
8.4.4.9	CALCulate<chn>:CONVert:SNUMber?	96
8.4.4.10	CALCulate<chn>:CONVert:SNUMber <serl>.	96
8.4.4.11	CALCulate<chn>:CONVert:TEST? <res><volt>	96
8.4.5	Calibration Coefficient Commands	97
8.4.5.1	CALibrate:AUTo	97
8.4.5.2	CALibrate<chn>:DATE:CALibrate? [MINIMAXIDEF]	97
8.4.5.3	CALibrate<chn>:DATE:CALibrate (<year>,<month>,<day>) MINIMAXIDEF	97
8.4.5.4	CALibrate<chn>:DATE:DUE? [MINIMAXIDEF]	97
8.4.5.5	CALibrate<chn>:DATE:DUE (<year>,<month>,<day>) MINIMAXIDEF	98
8.4.5.6	CALibrate<chn>:PARAmeter:OFFSet<n>? [MINIMAXIDEF]	98
8.4.5.7	CALibrate<chn>:PARAmeter:OFFSet<n> <num> MINIMAXIDEF	99
8.4.5.8	CALibrate<chn>:PARAmeter:SCALE<n>? [MINIMAXIDEF]	99
8.4.5.9	CALibrate<chn>:PARAmeter:SCALE<n> <num> MINIMAXIDEF	99
8.4.5.10	CALibrate<chn>:PARAmeter:LINearity<n>? [MINIMAXIDEF]	100
8.4.5.11	CALibrate<chn>: PARAmeter:LINearity<n> <num> MINIMAXIDEF	100
8.4.5.12	CALibrate<chn>:PARAmeter:RJC? [MINIMAXIDEF]	101
8.4.5.13	CALibrate<chn>:PARAmeter:RJC <num> MINIMAXIDEF	101
8.4.6	Display Commands	101
8.4.6.1	DISPlay:RESolution? [MINIMAXIDEF]	101
8.4.6.2	DISPlay:RESolution <num> AUTIMINIMAXIDEF	101
8.4.6.3	DISPlay:LAMP? [MINIMAXIDEF]	102
8.4.6.4	DISPlay:LAMP <bool><nnum> MINIMAXIDEF	102
8.4.6.5	DISPlay:DECimal:FORMat? [MINIMAXIDEF]	102
8.4.6.6	DISPlay:DECimal:FORMat <num> MINIMAXIDEF	102
8.4.6.7	DISPlay:WINDow? [MINIMAXIDEF]	103
8.4.6.8	DISPlay:WINDow <num> MINIMAXIDEF	103
8.4.6.9	DISPlay:WINDow<n>:FIELD<n>:FEED?	103
8.4.6.10	DISPlay:WINDow<n>:FIELD<n>:FEED <chn>[,<num>]	103
8.4.7	Logging Commands	103
8.4.7.1	LOGging:AUTomatic:DELeTe [<num> ALL]	103
8.4.7.2	LOGging:AUTomatic:COUNt? [MINIMAXIDEF]	104
8.4.7.3	LOGging:AUTomatic:COUNt <num> MINIMAXIDEF	104
8.4.7.4	LOGging:AUTomatic:FREE?	104
8.4.7.5	LOGging:AUTomatic:LAbel? [MINIMAXIDEF]	104
8.4.7.6	LOGging:AUTomatic:LAbel <num> MINIMAXIDEF	105
8.4.7.7	LOGging:AUTomatic:POINt? [MAX]	105
8.4.7.8	LOGging:AUTomatic:PRINt [<num> ALL [,<port>]]	105
8.4.7.9	LOGging:AUTomatic:STATus?	105
8.4.7.10	LOGging:AUTomatic:STATus <bool>	106
8.4.7.11	LOGging:AUTomatic:TIME? [MINIMAXIDEF]	106
8.4.7.12	LOGging:AUTomatic:TIME <num> MINIMAXIDEF	106
8.4.7.13	LOGging:AUTomatic:VALue? <num> MINIMAXIDEF	106
8.4.7.14	LOGging:DEMAND:DELeTe [<num> ALL]	107
8.4.7.15	LOGging:DEMAND:FREE?	107
8.4.7.16	LOGging:DEMAND:LAbel? [MINIMAXIDEF]	107
8.4.7.17	LOGging:DEMAND:LAbel <num> MINIMAXIDEF	107
8.4.7.18	LOGging:DEMAND:POINt?	107
8.4.7.19	LOGging:DEMAND:PRINt [<num> ALL [,<port>]]	108
8.4.7.20	LOGging:DEMAND:STORe	108
8.4.7.21	LOGging:DEMAND:VALue? <num> MINIMAXIDEF	108
8.4.7.22	LOGging:LAbel<n>:NAME?	108
8.4.7.23	LOGging:LAbel<n>:NAME <label>	109
8.4.8	System Commands	109
8.4.8.1	*IDN?	109

8.4.8.2	*OPT?	109
8.4.8.3	*RST	109
8.4.8.4	SYSTem:BOOT:VERSion?	110
8.4.8.5	SYSTem:CODE:VERSion?	110
8.4.8.6	SYSTem:ERRor?	110
8.4.8.7	SYSTem:SNUMber?	110
8.4.8.8	SYSTem:VERSion?	110
8.4.8.9	UNIT:TEMPerature?	111
8.4.8.10	UNIT:TEMPerature <unit>	111
8.4.9	Communication Interface Commands	111
8.4.9.1	SYSTem:COMMunicate:SERial:BAUD? [MINIMAXIDeF]	111
8.4.9.2	SYSTem:COMMunicate:SERial:BAUD <baud> MINIMAXIDeF	111
8.4.9.3	SYSTem:COMMunicate:SERial:FDUPlex? [MINIMAXIDeF]	111
8.4.9.4	SYSTem:COMMunicate:SERial:FDUPlex <bool> MINIMAXIDeF	112
8.4.9.5	SYSTem:COMMunicate:SERial:FEED? [MINIMAXIDeF]	112
8.4.9.6	SYSTem:COMMunicate:SERial:FEED <bool> MINIMAXIDeF	112
8.4.9.7	SYSTem:COMMunicate:SERial:LINefeed? [MINIMAXIDeF]	112
8.4.9.8	SYSTem:COMMunicate:SERial:LINefeed <bool> MINIMAXIDeF	113
8.4.9.9	SYSTem:COMMunicate:SERial:TIME? [MINIMAXIDeF]	113
8.4.9.10	SYSTem:COMMunicate:SERial:TIME <num> MINIMAXIDeF	113
8.4.9.11	SYSTem:KLOCKout? [MINIMAXIDeF]	113
8.4.9.12	SYSTem:KLOCKout <bool> MINIMAXIDeF	113
8.4.9.13	SYSTem:POWer:BATTery?	114
8.4.9.14	SYSTem:POWer:SOURce?	114
8.4.10	Date and Time Commands	114
8.4.10.1	DISPlay:DATE:FORMat? [MINIMAXIDeF]	114
8.4.10.2	DISPlay:DATE:FORMat <num> MINIMAXIDeF	114
8.4.10.3	DISPlay:TIME:FORMat? [MINIMAXIDeF]	115
8.4.10.4	DISPlay:TIME:FORMat <num> MINIMAXIDeF	115
8.4.10.5	SYSTem:DATE? [MINIMAXIDeF]	115
8.4.10.6	SYSTem:DATE <year>,<month>,<day>	115
8.4.10.7	SYSTem:TIME?	116
8.4.10.8	SYSTem:TIME <hour>,<minute>,<second>	116
8.4.11	Password Commands	116
8.4.11.1	SYSTem:PASSword:CDISable	116
8.4.11.2	SYSTem:PASSword:CENable <pass>	116
8.4.11.3	SYSTem:PASSword:CENable:STATe?	116
8.4.11.4	SYSTem:PASSword:CONVersion? [MINIMAXIDeF]	117
8.4.11.5	SYSTem:PASSword:CONVersion <bool> MINIMAXIDeF	117
8.4.11.6	SYSTem:PASSword:NEW <pass>	117
8.4.12	Status Commands	118
8.4.12.1	*CLS	118
8.4.12.2	*ESE?	118
8.4.12.3	*ESE <num> MINIMAXIDeF	118
8.4.12.4	*ESR?	118
8.4.12.5	*SRE?	118
8.4.12.6	*SRE <num> MINIMAXIDeF	118
8.4.12.7	*STB?	118
8.4.12.8	*TST?	119
8.4.12.9	STATus:MEASure?	119
8.4.12.10	STATus:MEASure:CONDition?	119
8.4.12.11	STATus:MEASure:ENABle?	119
8.4.12.12	STATus:MEASure:ENABle <num>	119
8.4.12.13	STATus:OPERation?	120
8.4.12.14	STATus:OPERation:CONDition?	120
8.4.12.15	STATus:OPERation:ENABle?[MINIMAXIDeF]	120
8.4.12.16	STATus:OPERation:ENABle <num> MINIMAXIDeF	120
8.4.12.17	STATus:QUEStionable?	120
8.4.12.18	STATus:QUEStionable:CONDition?	121
8.4.12.19	STATus:QUEStionable:ENABle? [MINIMAXIDeF]	121
8.4.12.20	STATus:QUEStionable:ENABle <num> MINIMAXIDeF	121
8.4.13	Statistical Calculation Types	122
8.4.14	Field Types	122

8.4.15	Conversion Types and Parameters	124
8.4.16	Port Numbers	125
8.4.17	Date and Time Formats	126
9	Calibration	127
9.1	PRT and Thermistor Calibration	127
9.1.1	PRT Calibration Parameters	127
9.1.2	PRT Calibration Procedure	128
9.1.3	Thermistor Calibration Parameters	129
9.1.4	Thermistor Calibration Procedure	129
9.2	Thermocouple Calibration	130
9.2.1	Calibration Parameters	130
9.2.2	Calibration Procedure	131
10	Maintenance	133
11	Troubleshooting	135
11.1	Troubleshooting	135
11.1.1	Self-Test Error Messages	136
11.1.2	Start-up Error Messages	137
11.2	Downloading Auto Logged Data	137
11.3	CE Comments	138
11.3.1	EMC Directive	138
11.3.1.1	Immunity Testing	139
11.3.1.2	Emission Testing	139
11.3.2	Low Voltage Directive (Safety)	139
11.4	Frequently Asked Questions	139
11.4.1	Battery	139
11.4.2	Input	140
11.4.3	Logging	141
11.4.4	Output	141
11.4.5	Other	142

Figures

Figure 1	Using the Clamp-on Ferrites	12
Figure 2	Front Panel	15
Figure 3	Back Panel	16
Figure 4	Thermocouple Connections	21
Figure 5	Probe Connection Wiring Diagram	22
Figure 6	Main Menu	27
Figure 7	Measure Period.	28
Figure 8	Channel Menu	28
Figure 9	Enable Channel	30
Figure 10	Channel Mode	31
Figure 11	Moving Average	32
Figure 12	Display Options	33
Figure 13	Probe Menu	34
Figure 14	Edit Probe	35
Figure 15	Copy Probe.	42
Figure 16	Test Probe	43
Figure 17	Print Probe	44
Figure 18	Default Probe.	45
Figure 19	Clear Stats	46
Figure 20	Fields Menu	46
Figure 21	Select Fields	47
Figure 22	Edit Fields	49
Figure 23	Default Fields	50
Figure 24	Display Options	51
Figure 25	Logging Menu	52
Figure 26	Demand Log Submenu.	53
Figure 27	Store Readings	54
Figure 28	Log History	55
Figure 29	Demand Log View Data	56
Figure 30	Print Data.	57
Figure 31	Delete Data.	58
Figure 32	Logging Options	59
Figure 33	Auto Log Submenu	59
Figure 34	Log Statistics (Auto Log Started)	61
Figure 35	Start Stop.	61
Figure 36	Auto Log View Data	62
Figure 37	Print Data.	63
Figure 38	Delete Data.	64
Figure 39	Log Stats	65
Figure 40	Data Labels.	66

Figure 41	Default Labels	67
Figure 42	System Menu.	68
Figure 43	Comm Setup	69
Figure 44	Date Time	71
Figure 45	Password	72
Figure 46	Password for Calibration Access.	73
Figure 47	Select Calibration Channel.	74
Figure 48	Pass Cal Reset	75
Figure 49	Serial Cable Wiring	77
Figure 50	Using a Shorting Wire	128

Tables

Table 1	International Electrical Symbols	1
Table 2	Conversion Types	36
Table 3	Alphabetical List of Commands	79
Table 4	Statistical Calculation Types	122
Table 5	Field Types	122
Table 6	Reference (REF) Keywords.	123
Table 7	Conversion Types, Mnemonics, and Serial Port Responses	124
Table 8	Conversion Types and Parameters	124
Table 9	RJC Settings	125
Table 10	Port Numbers	125
Table 11	Date Formats	126
Table 12	Time Formats	126
Table 13	PRT and Thermistor Calibration Parameter Description	127
Table 14	Calibration Parameters	131













1 Before You Start





1.1 Symbols Used

Table 1 lists the symbols that may be used on the instrument or in this manual

Table 1 International Electrical Symbols

and the meaning of each symbol.

Symbol	Description
	AC (Alternating Current)
	AC-DC
	Battery
	Complies with European Union Directives
	DC (Direct Current)
	Double Insulated
	Electric Shock
	Fuse
	PE Ground
	Hot Surface (Burn Hazard)
	Read the User's Manual (Important Information)
	Off

Symbol	Description
	On
	Canadian Standards Association
CAT II	OVERVOLTAGE (Installation) CATEGORY II, Pollution Degree 2 per IEC1010-1 refers to the level of Impulse Withstand Voltage protection provided. Equipment of OVERVOLTAGE CATEGORY II is energy-consuming equipment to be supplied from the fixed installation. Examples include household, office, and laboratory appliances.
	C-TIC Australian EMC mark
	The European Waste Electrical and Electronic Equipment (WEEE) Directive (2002/96/EC) mark.

1.2 Safety Information

Use this instrument only as specified in this manual. Otherwise, the protection provided by the instrument may be impaired. Refer to the safety information in Sections 1.2.1 and 1.2.2.

The following definitions apply to the terms “Warning” and “Caution”.

- “Warning” identifies conditions and actions that may pose hazards to the user.
- “Caution” identifies conditions and actions that may damage the instrument being used.

1.2.1 Warnings

- **DO NOT** use this unit in environments other than those listed in the User's Guide.
- Follow all safety guidelines listed in the User's Guide.
- Calibration equipment should only be used by trained personnel.
- This instrument can measure extreme temperatures. Precautions must be taken to prevent personal injury or damage to objects. Probes may be extremely hot or cold. Cautiously handle probes to prevent personal injury. Carefully place probes on a heat/cold resistant surface or rack until they reach room temperature.
- If this equipment is used in a manner not specified by the manufacturer, the protection provided by the equipment may be impaired.
- Before initial use, or after transport, or after storage in humid or semi-humid environments, or anytime the instrument has not been energized for more than 10 days, the instrument needs to be energized for a "dry-out" period of 2 hours before it can be assumed to meet all of the safety re-

quirements of the IEC 1010-1. If the product is wet or has been in a wet environment, take necessary measures to remove moisture prior to applying power such as storage in a low humidity temperature chamber operating at 50°C for 4 hours or more.

- The AC adapter can present safety concerns if misused or damaged. To avoid the risk of electric shock or fire, do not use the AC adapter outdoors or in a dusty, dirty, or wet environment. If the cord, case, or plug of the adapter is damaged in any way, discontinue its use immediately and have it replaced. Never disassemble the AC adapter. Use only the AC adapter provided with the instrument or equivalent adapter recommended by the manufacturer of this instrument.
- The AC adapter has circuits with high voltage inside that could present danger of electrical shock or fire if exposed. If the AC adapter is damaged in any way or becomes hot, discontinue its use immediately, disconnect it from any AC supply, and have it replaced. Do not attempt to open, repair, or continue using a damaged or defective AC adapter.
- The instrument batteries can present danger if not handled properly. To avoid the risk of exposure to dangerous substances or explosion, immediately remove the batteries and discontinue use if they leak or become damaged. Never allow the batteries to be shorted, heated, punctured, or dropped. If the instrument is physically damaged, immediately remove the batteries to insure that they do not become shorted. While removed from the instrument, store the batteries in a location so that they do not come into contact with metal or fluids that might short circuit the batteries and where they are safe from excessive temperatures. Used batteries must be disposed of properly. Check your local regulations for additional information. Never dispose of batteries in fire which may result in explosion with the possibility of personal injury or property damage.
- **DO NOT** use this instrument in combination with any probe (PRT, thermistor, or thermocouple) to measure the temperature or resistance of any device where the probe might come in contact with a conductor that is electrically energized. Severe electric shock, personal injury, or death may occur.

1.2.2

Cautions

- If the instrument is dropped, struck, or handled in a way that causes internal or external physical damage, immediately unplug the AC adapter, remove the batteries, discontinue use, and contact the factory for repair. Do not attempt to disassemble or repair the instrument, batteries, or AC adapter. Refer repairs or replacement components to the manufacturer.
- The instrument and thermometer probes are sensitive and can be easily damaged. Always handle these devices with care. **DO NOT** allow them to be dropped, struck, stressed, or overheated.
- Probes are fragile devices which can be damaged by mechanical shock, overheating, and absorption of moisture or fluids in the wires or hub.

Damage may not be visibly apparent but nevertheless can cause drift, instability, and loss of accuracy. Observe the following precautions:

- **DO NOT** allow probes to be dropped, struck, bent, or stressed.
- **DO NOT** overheat probes beyond their recommended temperature range.
- **DO NOT** allow any part of the probe other than the sheath to be immersed in fluid.
- **DO NOT** allow the probe hub or wires to be exposed to excessive temperatures.
- Keep the probe wires clean and away from fluids.

1.3 Authorized Service Centers

Please contact one of the following authorized Service Centers to coordinate service on your Hart product:

Fluke Corporation, Hart Scientific Division

799 E. Utah Valley Drive
American Fork, UT 84003-9775
USA

Phone: +1.801.763.1600
Telefax: +1.801.763.1010
E-mail: support@hartscientific.com

Fluke Nederland B.V.

Customer Support Services
Science Park Eindhoven 5108
5692 EC Son
NETHERLANDS

Phone: +31-402-675300
Telefax: +31-402-675321
E-mail: ServiceDesk@fluke.nl

Fluke Int'l Corporation

Service Center - Instrimpex
Room 2301 Sciteck Tower
22 Jianguomenwai Dajie
Chao Yang District

Beijing 100004, PRC
CHINA

Phone: +86-10-6-512-3436
Telefax: +86-10-6-512-3437
E-mail: xingye.han@fluke.com.cn

Fluke South East Asia Pte Ltd.

Fluke ASEAN Regional Office
Service Center
60 Alexandra Terrace #03-16
The Comtech (Lobby D)
118502
SINGAPORE

Phone: +65 6799-5588
Telefax: +65 6799-5588
E-mail: antng@singa.fluke.com

When contacting these Service Centers for support, please have the following information available:

- Model Number
- Serial Number
- Voltage
- Complete description of the problem

2 Introduction

The Hart 1529 is a low-cost, high-accuracy, digital thermometer readout designed to be used with 25 and 100 Ω PRTs, thermistors, and thermocouples. Its unique combination of features makes it suitable for a wide variety of applications from laboratory measurement to industrial processes. Features of the 1529 include:

- Measures 25 Ω and 100 Ω PRTs, thermistors, and thermocouples
- Four inputs: two PRT/thermistor and two thermocouple (standard configuration)
- Four-wire connection eliminates lead resistance effects in PRTs
- Three-wire measurement mode for three-wire RTDs
- Exclusive patented mini-DWF connectors (U.S. Patent No. 5,964,625)
- Automatic current reversal eliminates thermoelectric EMF errors
- Accuracy: PRTs to 0.006 $^{\circ}$ C, thermistors to 0.002 $^{\circ}$ C, and thermocouples to 0.3 $^{\circ}$ C
- Typical resolution: PRTs 0.001 $^{\circ}$ C, thermistors 0.0001 $^{\circ}$ C, thermocouples 0.01 $^{\circ}$ C
- Measures four sensors simultaneously with a fast one-second measurement cycle
- Measures one sensor at 10 readings per second (limited accuracy)
- Adjustable moving average for extra precision
- Stores over 8,000 measurements internally
- Accepts ITS-90, PT-100 (ASTM E1137, DIN 43760, or IEC-751), and Callendar-Van Dusen PRT characterizations
- Accepts Steinhart-Hart R(T) or T(R) and YSI-400 type thermistor characterizations
- Accepts thermocouple types B, E, J, K, N, R, S, T, Au-Pt, and polynomial specified
- Temperature offsets for improved thermocouple accuracy
- Stores 10 additional sets of probe parameters
- Eight programmable display sets for display probe information, measurement statistical data, or difference between measurements
- Password protection of settings
- Large, LCD, user-configurable, display viewable in bright or dim lighting
- Serial RS-232 interface standard; IEEE-488 GPIB interface optional
- Powered by external AC supply, 12-15V DC source, or internal rechargeable battery

3 Specifications and Environmental Conditions

3.1 Specifications

	PRT	Thermistor	Thermocouple
Inputs	2 channels PRT/thermistor and 2 channels thermocouple or 4 channels PRT/thermistor or 4 channels thermocouple PRT/thermistor channels accept 2,3, or 4 wires Thermocouple channels accept B, E, J, K, N, R, S, T, and Au-Pt thermocouple types		
Temperature Range¹	-189 to 960°C	-50 to 150°C	-270 to 1800°C
Measurement Range	0 to 400Ω	0 to 500kΩ	-10 to 100 mV
Resistance / Voltage Accuracy²	0 to 20Ω : ±0.0005Ω 20 to 400Ω: ±25 ppm of reading	0 to 5kΩ: ±0.0005kΩ 5 to 200kΩ: ±100 ppm of reading 200 to 500 KΩ: ±300 ppm of reading	-10 to 50 mV: ±0.005 mV 50 to 100 mV: ±100 ppm of reading (Internal RJC: ±0.25°C)
Characterizations	ITS-90, PT-100 (ASTM E1137, DIN 43760, IEC-751), Callendar-Van Dusen	Steinhart-Hart, YSI-400	NIST Monograph 175, 3-point deviation function applied to NIST 175, 6th-order polynomial
Temperature Accuracy (meter only)¹	±0.004°C at -100°C ±0.006°C at 0°C ±0.009°C at 100°C ±0.012°C at 200°C ±0.018°C at 400°C ±0.024°C at 600°C	±0.0025°C at 0°C ±0.0025°C at 25°C ±0.004°C at 50°C ±0.010°C at 75°C ±0.025°C at 100°C	Type Ext./Int.RJC B ±0.6°C/±0.6°C E ±0.07°C/±0.25°C J ±0.1°C/±0.35°C K ±0.15°C/±0.4°C N ±0.15°C/±0.3°C R ±0.4°C/±0.5°C S ±0.5°C/±0.6°C T ±0.1°C/±0.3°C
Temperature Resolution, typical³	0.001°	0.0001°	0.01 to 0.001°
Operating Range¹	16 to 30°C		
Measurement Interval	0.1 second to 1 hour; inputs may be read sequentially or simultaneously at 1 second or greater interval		
Excitation Current	1mA (reversing)	2 and 10 μA, automatically selected	N/A
Display	1.3" x 5" backlit LCD graphical display		
Display Units	°C, °F, K, Ω, KΩ, mV		
Data Logging	Up to 8,000 time- and date-stamped measurements can be logged		
Logging Intervals	0.1, 0.2, 0.5, 1, 2, 5, 10, 30, or 60 seconds; 2, 5, 10, 30, or 60 minutes		
Averaging	Moving average of most recent 2 to 10 readings, user selectable		
Statistical Data	Average, standard deviation, minimum, maximum, spread, N, difference (delta)		

	PRT	Thermistor	Thermocouple
Probe Connection	Patented DWF connectors accepts spade lug, bare-wire, or banana plug terminations		Universal receptacle accepts miniature and standard connectors
Communications	RS-232 port included, IEEE-488 (GPIB) optional		
AC Power	100 to 240 VAC, 50-60 Hz, 0.4A		
DC Power	12 to 16 VDC, 0.5 A (battery charges during operation from 14.5 to 16 VDC, 1.0A)		
Battery	NiMH, 8 hours operation typical without backlight, 3 hours to charge, 500 cycles		
Size	4.0" H x 7.5" W x 8.2" D (102 x 191 x 208 mm)		
Weight	4.5 lbs. (2 kg)		

¹The sensor generally limits the actual temperature range. Temperature accuracy specifications do not include sensor accuracy. Thermistor temperature accuracy assumes a 10kΩ sensor. Thermocouple accuracy is with internal reference junction compensation; accuracy is improved with external reference junction compensation. Thermocouple temperature accuracies are given for external reference junction compensation and internal reference junction compensation, respectively.

²Measurement accuracy specifications apply within the operating temperature range and assume 4-sample averaging and 4 lead wires for PRTs. With 3-wire RTDs add 0.05Ω to the measurement accuracy plus the maximum possible difference between the resistances of the lead wires.

³Actual resolution can be set greater than typical resolution, but the added digits (0.0001 max.) may not be meaningful to the measurement.

3.2 Environmental Conditions

Although the instrument has been designed for optimum durability and trouble-free operation, it must be handled with care. The instrument should not be operated in an excessively dusty, dirty, or wet environment. Maintenance and cleaning recommendations can be found in the Maintenance section of this manual.

For full accuracy, operate the instrument in ambient temperatures between 16–30°C (61–86°F). The battery may not charge properly at temperatures above 30°C. Do not operate the instrument in an environment colder than 5°C (41°F) or warmer than 40°C (104°F).

The instrument operates safely under the following conditions:

- Ambient temperature range: absolute 5–40°C (41–104°F) [full accuracy 16–30°C (61–86°F)]
- Ambient relative humidity: maximum 80% for temperature <31°C, decreasing linearly to 50% at 40°C
- Pressure: 75 kPa–106 kPa
- Vibration should be minimized
- Altitude less than 2,000 meters
- Indoor use only

4 Quick Start

This section briefly explains the basics of setting up and operating your 1529 Thermometer Readout.

4.1 Unpacking

Carefully unpack the 1529 thermometer readout. Verify that the following items are present:

- 1529 Thermometer Readout (The battery inside the 1529 is completely charged when shipped. Initial charging is not required.)
- AC Adapter/Charger and power cord
- Serial Cable
- User's Guide
- Report of Calibration with calibration label
- Probe (optional-must be purchased separately)
- Two ferrites (for use with probes as described in Section 4.4.1, Using the Clamp-on Ferrites)

If all items are not present, contact an Authorized Service Center (see Section 1.3)

4.2 Use Proper Care

You must understand the safety issues related to the 1529. Be aware that potential hazards exist due to high temperatures and battery chemicals. Carefully read the Warnings in Section 1.2.1 and Cautions in Section 1.2.2.

The 1529 and any thermometer probes used with it are sensitive instruments that can be easily damaged. Always handle these devices with care. DO NOT allow them to be dropped, struck, stressed, or over-heated.

4.3 Learn About the Features and Components

Familiarize yourself with the features and accessories of the 1529 by reading Section 5, Parts and Controls.

4.4 Connect the Probe

The PRT/thermistor or thermocouple probe connects on the back panel of the 1529 using patented mini-DWF connectors (PRT/thermistor) or the universal receptacles (thermocouples).

4.4.1 Using the Clamp-on Ferrites

Clamp-on ferrites are provided with this product for the use of improving its electromagnetic (EM) immunity in environments of excessive EM interference. During EMC testing we found that ferrites clamped around the probe cables and power cord reduced the risk that EM interference affects measurements. Therefore, we recommend that the clamp-on ferrites provided (Steward P/N 28A2025-0A2) be used on the cables of probes attached to this product, especially if it the product is used near sources of EM interference such as heavy industrial equipment.

To attach a ferrite to a probe cable, make a loop in the cable near the connector and clamp the ferrite around half of the loop as shown in Figure 1. The ferrite can be easily snapped open and moved to a new probe when needed.

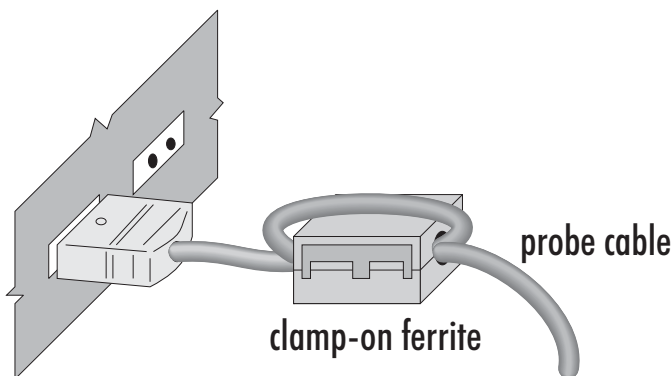

Figure 1 Using the Clamp-on Ferrites

4.5 Connect the Power Source

The 1529 draws power from either a 15-volt DC power supply (the included AC adapter) connected to the DC input or the internal re-chargeable battery pack. To use the AC adapter, plug it into a wall outlet of the appropriate voltage and insert the DC plug into the DC power input of the 1529 (see Figure 3 on page 16.)

4.6 Switch the Power On

Power is turned on and off with the power switch located on the top right corner of the back panel. To switch the power on, toggle the power switch to the 'ON' position. To switch power off, toggle the power switch to the 'OFF' position. The instrument takes a few seconds to power up, initialize, and begin normal operation. A self-test is performed displaying the channel configuration and status of the system, calibration, GPIB, memory, and buttons. If the thermometer readout calibration has expired, the user is notified and must press the

Enter button to continue initialization. If an error message is displayed on power up see Section 11.1, Troubleshooting.

4.7 **Measure Temperature**

After initialization, the temperature measurements for the configured channels are displayed. The appropriate sensor type must be selected and coefficients entered for the measurements to be accurate (see Section 7.2.1, Edit Probe). Place the sensors of the probe into the object(s) you want to measure. **DO NOT** force the probe(s) or otherwise allow them to be bent, stressed, or overheated. Probes can be easily damaged if misused. For further suggestions on handling the probe and using the 1529 and probe to measure temperature accurately, see Section 6, General Operation. For information on the various modes of operation of the 1529 see Section 7, Display Functions.

5 Parts and Controls

The functions of the various features of the 1529 are described below.

5.1 Front Panel Buttons

The front panel buttons **Enter/Menu**, **Unit**, **Contrast**, and **Exit** are used to select and alter the functions of the thermometer readout (see Figure 2).

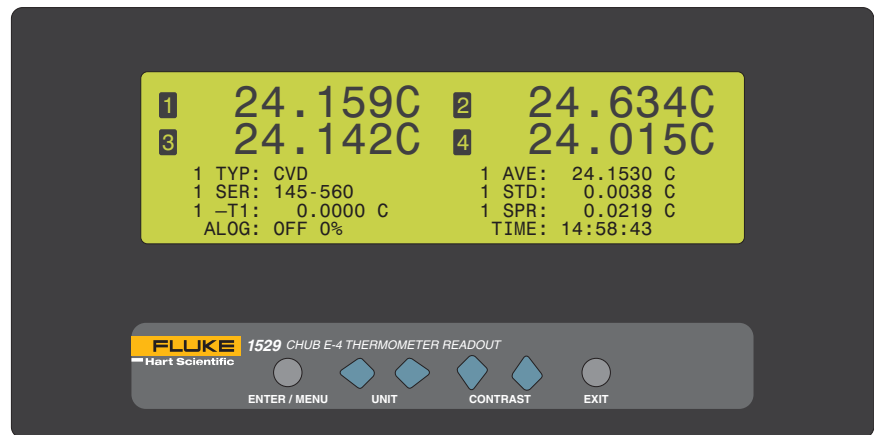

Figure 2 Front Panel

The function of each button is as follows:

Enter/Menu - This button displays and scrolls through the menu options. Use this button to select the menu to enter and to save changes made to menu choices.

Unit - ◀▶ Use these buttons to select the units C, F, or K when not in the menu structure. In conjunction with the **Menu** button, use these buttons to scroll left and right through menu options and choices.

Contrast - ▲▼ Use these buttons to lighten or darken the display when not in the menu structure. In conjunction with the **Menu** button, use these buttons to scroll up and down through menu options and choices.

Exit - Use this button to exit any menu. When editing a parameter, if the Exit button is pressed, the immediate operation is canceled and control skips to the next parameter. Holding the button down for several seconds, exits to the main display.

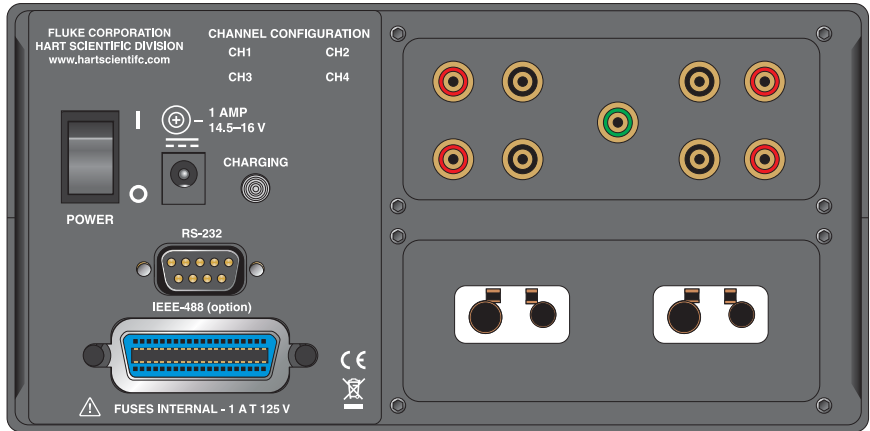

1529

1529-R

1529-T

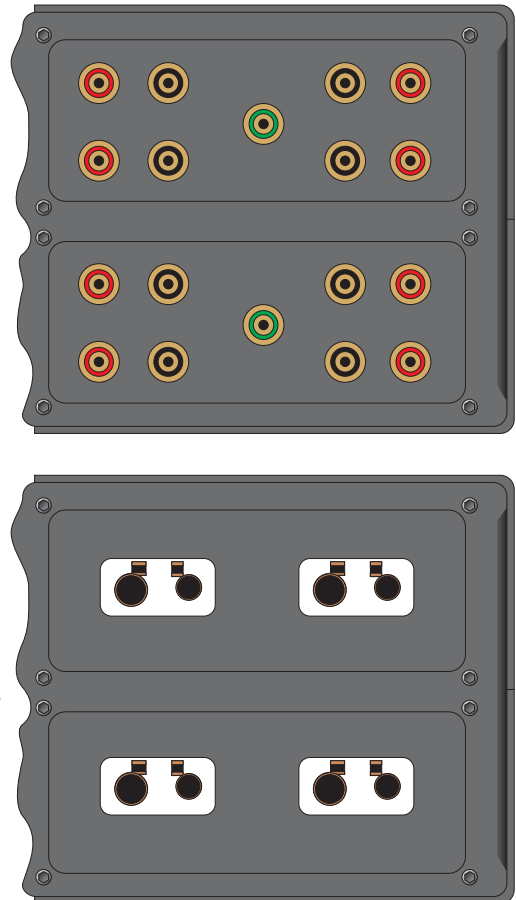

Figure 3 Back Panel

5.2 Back Panel

The back panel consists of the power switch, AC adapter connector, charging indicator, RS-232 port connector, IEEE-488 port connector (optional), serial label, and probe connectors. The 1529 thermometer readout can be configured in three different ways. The configuration affects the probe connectors on the back panel. The Model 1529 is configured with one PRT/thermistor input module of two channels and one thermocouple input module of two channels. The Model 1529-R is configured with two PRT/thermistor input modules of four channels. The Model 1529-T is configured with two thermocouple input modules of four channels. Figure 3 shows the back panel and the three different configurations.

Power Switch - The power switch turns the thermometer readout on and off.

AC Adapter Connector - The AC adapter plugs into the DC power input to recharge the battery and to power the instrument while the battery is being charged (see Section 6.3, Battery).

Charging Indicator - The charging indicator lights when the AC adapter is connected. It glows green when the battery is at full charge and amber when the battery is being charged.

RS-232 Port Connector - The DB-9 connector is for interfacing the thermometer readout to a computer or terminal with serial RS-232 communications.

IEEE-488 Port (optional) - The GPIB connector is for interfacing the thermometer readout to a computer or terminal with IEEE-488 communications.

Serial Label - The serial label shows the instrument model and serial number.

Probe Connectors - Probe(s) must be connected either to the patented mini-DWF connectors (PRT/thermistor probes) or to the universal receptacle (thermocouples) for operation.

5.3 Accessories

The 1529 thermometer readout comes standard with a hand strap on the side for easy carrying of the instrument. The following accessories are also available:

- 2513-1529 Rack Mount Kit
- 9323 Soft Carrying Case
- 9322 Hard Carrying Case
- 2380 Small Thermocouple Connector Kit
- 2381 Large Thermocouple Connector Kit



6 General Operation

This section explains basic operation of the 1529 thermometer readout. Detailed operation of the 1529 is explained in Sections 7 and 8. Section 7 explains the menu structure and the functions available in the menu structure and Section 8 explains the communications interface for operating the 1529 remotely.

6.1 Display

The 1529 display consists of two parts. The top portion of the display is used for displaying the measurements from one to four inputs. The bottom portion of the display is reserved for the programmable fields and field display sets. Information about the channels and measurements can be displayed in greater detail such as min, max, spread, standard deviation, and many other functions. When the measure period is 0.1 or 0.2 seconds (fast measurement mode), the programmable fields and field display set information are not displayed.

6.2 Changing Units

The 1529 thermometer readout is capable of displaying temperature in Celsius (C), Fahrenheit (F), or Kelvin (K). (Displaying in units of Ω , $K\Omega$, or mV is also available through the PROBE menu and is channel specific.) Temperature units are changed on all channels (not individually) by pressing the buttons on the front panel when not in the menu structure. Press the **Unit**, , , buttons to scroll forward and backward through C, F, or K. All channels or fields that are displaying temperature on the upper or lower display are updated to the new units.

Channels that are set to Ω , $K\Omega$, or mV in the PROBE menu are left unchanged when temperature units are modified. Changing the units resets the statistical calculations (displayed in the bottom portion of the display).

6.3 Battery

The 1529 thermometer readout has a built-in nickel-metal-hydride battery pack that can power the instrument for about eight hours before needing to be recharged. The battery discharges more quickly when the display backlight is used. The percent of battery charge remaining is displayed on the bottom portion of the display when the battery power is being used. The battery percentage is approximate and should only be used as a general guideline when determining the length of charge remaining. The battery is recharged *in situ* (while in place) using the AC adapter that is provided.

Plug the AC adapter into the wall outlet and connect the DC plug of the adapter into the 1529. The battery is charged as necessary whether or not the instrument is switched on. The power control circuit inside the instrument manages battery charging and stops charging the battery automatically when the battery

is fully charged. Only charge the battery when ambient temperature is between 16°C and 30°C (61°F and 86°F) It normally takes about three hours to fully charge the battery. The instrument can be operated while the battery is being charged. The charging indicator on the back panel is green when the battery is fully charged and amber when being charged using the AC adapter.

The battery may self-discharge over several months, especially if the temperature is warm. The battery pack can be used for a minimum of 500 charge-discharge cycles before needing to be replaced. Replacement battery packs are available from the manufacturer. The battery pack can be easily removed and replaced in the field by following this procedure:

1. Power the 1529 off and unplug the AC adapter from the unit.
2. Turn the 1529 over to expose the battery compartment. Remove the battery cover hex screw. Place the screw in a safe place so it won't get lost. Flip open the battery cover to reach the battery pack.
3. Remove the battery pack. Gently disconnect the battery plug connector.
4. Attach the polarized plug of the new battery pack onto the connector.
Note: The battery plug is polarized and can only be plugged in one direction. DO NOT force it. Place the battery pack in the battery compartment.
5. Close the battery cover and replace the screw. Avoid pinching the battery wires.
6. Plug in the AC adapter and charge for a minimum of four hours for the initial charge. Used batteries must be disposed of properly. Check your local regulations for additional information. You may return used batteries to the manufacturer. Never dispose of batteries in fire as this may result in an explosion with the possibility of personal injury or property damage.

When the battery charge is not at 100%, the measurement accuracy is not affected. If the power is interrupted while the instrument is logging measurements (on demand or automatically), the logged data is preserved and logging resumes when the power is restored.

6.4 Probe Input Modules

The 1529 can be configured in three ways:

- Two RTD/thermistor input modules.
- Two thermocouple input modules.
- One RTD/thermistor and one thermocouple input module.

Each input module supports two channels. Your 1529 thermometer readout is configured at the factory and is not field changeable. Input modules should never be removed for any reason.

All possible configurations are shown in Figure 3 on page 16.

6.4.1 Connecting a PRT or Thermistor Probe

PRT and thermistor probes are attached to the resistance input module via Hart Scientific mini-DWF connectors. These patented connectors accept bare wire, spade, or mini banana plug terminations. The connectors are color coded for ease in connecting lead-wires.

When using 2- and 3-wire sensors, the accuracy of the 1529 is reduced as stated in the specifications. Compensation is made for 3-wire PRTs, but the difference in lead resistance affects the measurement accuracy. The 1529 thermometer readout is unable to compensate for 2-wire lead resistance.

Attach the lead-wires of the probes as shown in Figure 5 on page 22. The top terminals sense current and the bottom terminals sense potential.

6.4.2 Connecting a Thermocouple

The 1529 thermocouple input module accepts both standard and sub-miniature size thermocouple connectors. The connection is made with the positive terminal on the right and the negative terminal on the left. You must use a connector that matches the thermocouple type for the internal RJC to be accurate. For example, if you are using a type K thermocouple you must also use a type K connector, which is made from the same type of metal. For best results, wait two minutes before measuring after inserting the thermocouple connector into the input module.

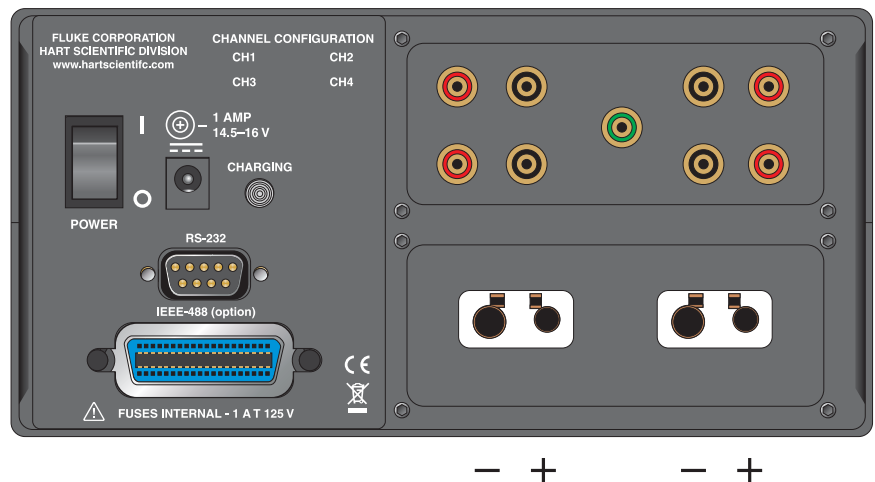
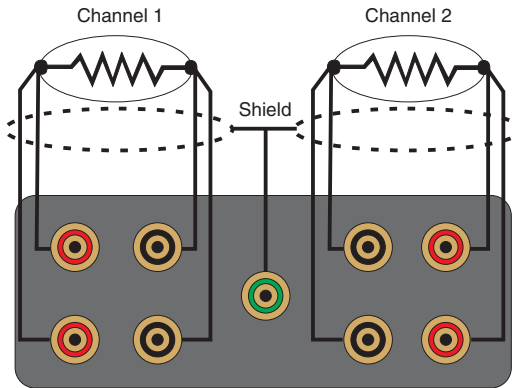
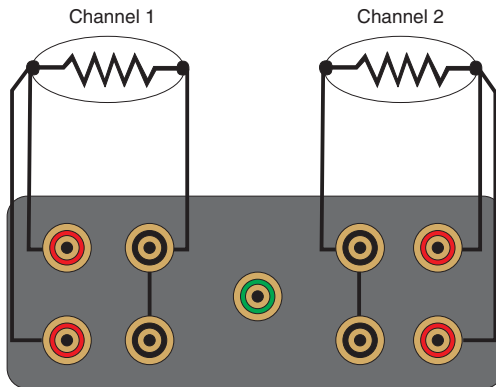

Figure 4 Thermocouple Connections



Connecting 4-wire probes



Connecting 3-wire probes

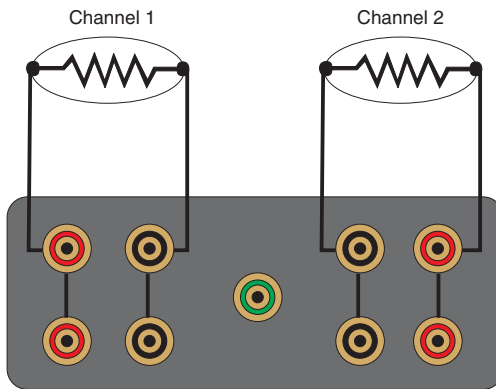

Connecting 2-wire probes

Figure 5 Probe Connection Wiring Diagram

6.5 DC Power Source



Caution: For CE compliance and for performance, use only the AC adapter shipped with the instrument by Hart Scientific. If the AC adapter needs to be replaced, contact an Authorized Service Center (see Section 1.3).

The DC power source provides power to charge the battery. It can also be used to power the 1529 while the battery is being charged. The AC adapter provided with the 1529 is intended for these purposes. The DC power source plugs into the DC power input on the back panel of the instrument. The AC adapter has circuits with high voltages inside that could present danger of electric shock or fire if exposed. If the AC adapter is damaged in any way or becomes hot, discontinue use immediately, disconnect the adapter from any AC supply, and replace the adapter. Do not attempt to open, repair, or continue using a damaged or defective AC adapter.

6.6 Power On Self-Test

When power is turned on, the 1529 performs a self-test checking the system, all channels, calibration, GPIB, memory, and buttons. If an error occurs, an error message is displayed. See Section 11.1, Troubleshooting for additional information on error messages.

6.7 Display Backlight and Contrast

The display backlight is adjustable for use in varying lighting conditions. The four backlight modes are accessible in the CHANNEL menu DISPLAY OPTIONS function. If the display appears faded, dark, or blank, adjust the contrast (off, low, medium, high) using the front panel contrast buttons.

6.8 Taking Measurements

The procedure for configuring the 1529 thermometer readout to take measurements on a particular input channel requires the following: (1) connecting the sensor to the appropriate input channel, (2) enabling the channel, and (3) selecting the conversion type and probe characterization values.

6.8.1 Connecting the Sensor

Connect the sensor to the RTD/Thermistor channel(s) or thermocouple channel(s) that you want to measure. Refer to Section 7.4, Probe Input Modules, for additional information.

6.8.2 Enabling the Channel

Channels are set first by selecting either simultaneous or scan mode in the CHANNEL menu CHANNEL MODE function. Simultaneous mode shows one to four channels in the upper display simultaneously. Scan mode shows one channel at a time (in large digit format) scanning through one to four channels depending on the channels that are enabled. After the mode has been selected, use the CHANNEL menu ENABLE CHANNEL function, to select the channel to be displayed. Any channel set to 'Off' is not displayed. See Sections 7.1.3, Channel Mode, and 7.1.2, Enable Channel, for more information.

6.8.3 Selecting Conversion Type and Probe Characterization

Before the 1529 can accurately measure temperature, it must be configured to calculate temperature from the resistance or voltage of the sensor. There are many temperature conversion algorithms available and the one to use depends on the type of sensor and its calibration. Many conversion algorithms use coefficients that characterize the sensor. Coefficients are determined when the sensor is calibrated. SPRTs and RTDs often use the ITS-90 algorithms and are provided with ITS-90 characterization coefficients. Thermistors often use the Steinhart-Hart algorithms and coefficients. Thermocouples use standard tables or equations depending on its type. For additional information on conversion types, see Section 7.2, Probe Menu.

The conversion type and characterization coefficients for a sensor are specified using the PROBE menu EDIT PROBE function (see Section 7.2.1).

6.9 Fast Measurement Mode

Fast Measurement Mode applies to measure periods of 0.1, 0.2, or 0.5 seconds. This mode allows measurements to be displayed or logged quickly.



Normally, when each measurement is made a self-calibration of the measurement circuit is performed simultaneously during the measurement process to offset errors from component drift and spurious EMFs. For measure periods of 0.1, 0.2, and 0.5 seconds, the fast measurement rate is achieved by foregoing the self-calibration. The drawback to this Fast Measurement Mode is the accuracy of the measurement may be poor and subject to drift. Accuracy can be temporarily improved using the AUTO-CAL function that appears in the CHANNEL menu when in this Fast Measurement Mode. The AUTO-CAL function causes the instrument to perform a single self-calibration of the measurement circuit then resume fast measuring (without automatic self-calibration).

See Section 8.1.1 for detailed information on using the Fast Measurement Mode.

6.10 Data Logging

Data can be logged either on demand or automatically at a user-selected interval. When data is logged, readings are stored to the instrument's memory and assigned a label for easy recall and organization of data. Up to 100-demand log and 8,160 auto log readings can be stored. When data is being logged, the left bottom corner of the main display shows a strip-recorder indicator.

7 Menu Functions

Selecting the **Enter/Menu** button from the front panel accesses the main menu of the 1529 thermometer readout. The main menu consists of the submenus: **CHANNEL**, **PROBE**, **FIELDS**, **LOGGING**, and **SYSTEM**. Each submenu has its own set of functions. The **Enter/Menu** button is used to select and save menu choices. The **Unit**   buttons are used to scroll forward or backward through the functions. The **Exit** button is used to return from a function to the previous menu or step through parameters.

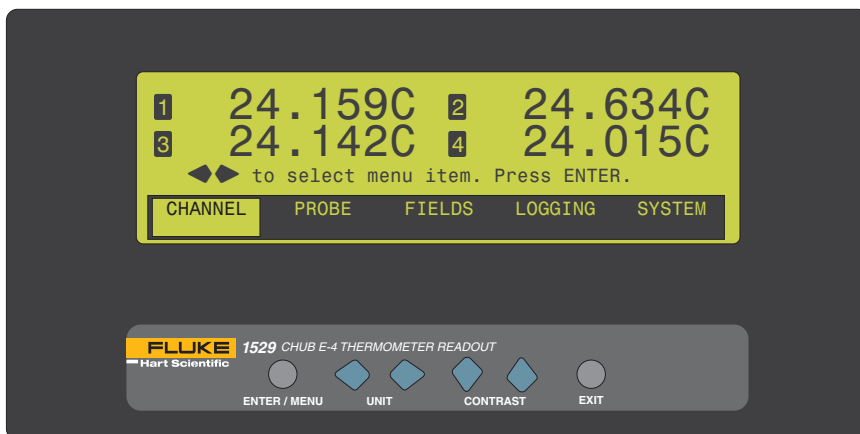

Figure 6 Main Menu

7.1 Channel Menu

The CHANNEL menu provides functions for setting the measurement period, selecting channels, setting the channel display mode, and setting measurement averaging. The functions that appear in the CHANNEL menu are MEASURE PERIOD, ENABLE CHANNEL, CHANNEL MODE, MOVING AVERAGE,

and DISPLAY OPTIONS/AUTO-CAL. (The DISPLAY OPTIONS changes to AUTO-CAL when the measure period is less than 1 second.)

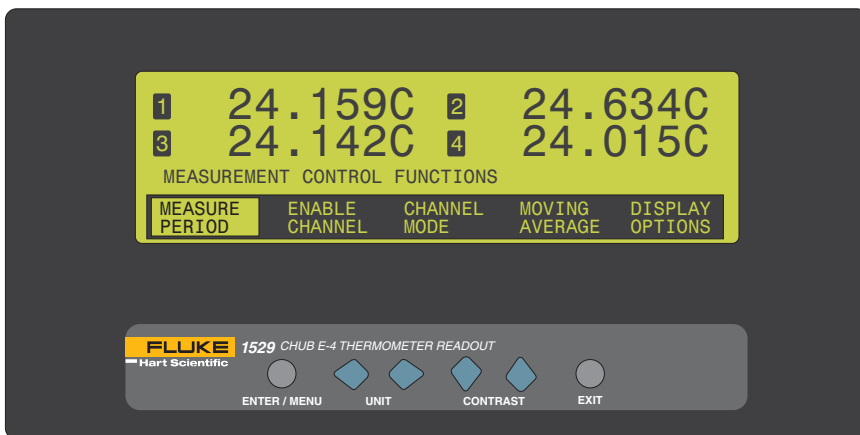

Figure 8 Channel Menu

7.1.1 Measure Period and Fast Measurement Mode

The MEASURE PERIOD function allows you to control the period (time) between measurements. You may select between 0.1, 0.2, 0.5, 1, 2, 5, 10 and 30 seconds, 1, 2, 5, 10, and 30 minutes, or 1 hour. **Note:** Accuracy may be reduced in measurement periods less than one second. When this function is selected, the bottom portion of the display shows the current setting and allows the setting to be changed.

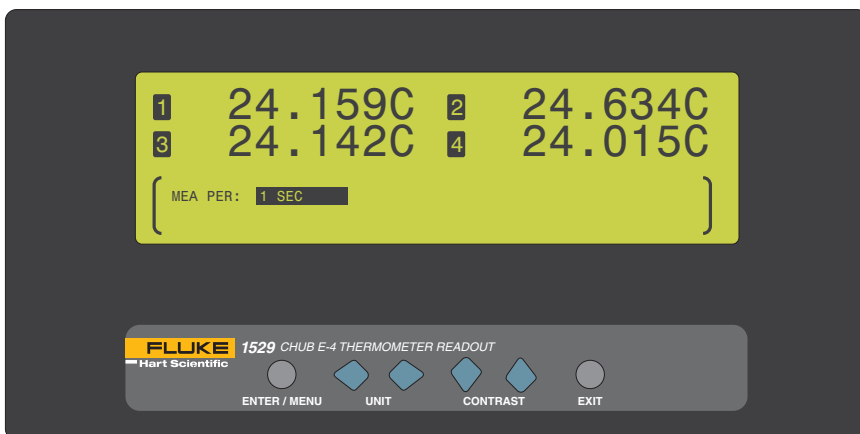



Figure 7 Measure Period

The   buttons are used to select the period between measurements. Press the **Enter** button to save the new setting. Press the **Exit** button to cancel and to exit to the menu.

When the measure period is set to less than 1 second (i.e. 0.1, 0.2, 0.5 seconds) the 1529 enters the Fast Measurement Mode. *The menu buttons may seem to be sluggish in this mode as the processor is making faster measurements.* When in the Fast Measurement Mode, the following changes occur at 0.1, 0.2, and 0.5 seconds.

- The channel display is updated quicker.
- The DISPLAY FUNCTIONS function changes to the AUTO-CAL function.
- The measurement accuracy is reduced and is subject to uncertainty factors that are not typically introduced in a normal full measurement cycle.
- With serial port printing (see Section 7.5.1.1) measurements are printed without the time and date and other associated information.

The following occur if the measure period is set to 0.1 or 0.2 seconds.

- The CHANNEL MODE function becomes unavailable.
- The 1529 measures one channel in scan mode.
- The field information normally displayed in the bottom portion of the display is not updated or displayed. The message, FIELD DATA NOT AVAILABLE AT THIS RATE, is displayed.

The following occur if the measure period is set to 0.5 seconds.

- The 1529 can measure up to four channels in scan or simultaneous mode.

The Fast Measurement Mode is automatically implemented when the measure period is set to less than 1 second. If the measure period is set to 0.1 or 0.2 seconds and the **Enter** button is pressed, the following message is display.

ONE CHANNEL ONLY. SETTINGS CHANGED.

SELECT CHANNEL USING ENABLE CHANNEL.

ACCURACY NOT GUARANTEED AT THIS RATE.

Press ENTER to continue ...

Press the **Enter** button to confirm and to continue. The display is automatically changed to display one channel in large digit format. If more than one channel is enabled, the first channel is left enabled and the other channels are automatically disabled. To enable a different channel, use the ENABLE CHANNEL function from the CHANNEL menu. See Section 8.1.2. Press the **Exit** button to cancel.

If the measure period is set to 0.5 seconds and the **Enter** button is pressed, the following message is display.

ACCURACY NOT GUARANTEED AT THIS RATE.

Press ENTER to continue ...

Press the **Enter** button to confirm and to continue. The display remains unchanged and all enabled channels remain enabled channels. Press the **Exit** button to cancel.

When the measure period is reset to 1 second or greater, the following message is displayed indicating that the 1529 is returning to normal operation.

FULL ACCURACY.

The DISPLAY FUNCTIONS function of the CHANNEL menu reappears and the CHANNEL MODE function is available.

Note: Accuracy in the Fast Measurement Mode is affected by ambient conditions, changes in measured temperature, higher measured temperature, and the time duration from using the AUTO-CAL function. To reduce the uncertainty in the Fast Measurement Mode, use the 1529 in a controlled ambient environment, in a very stable bath or dry block at lower temperatures, and use the AUTO-CAL function often.

7.1.2 Enable Channel

The ENABLE CHANNEL function enables and disables measuring of each channel. If a channel is off, its measurement is not displayed on the top portion of the display in either scan or simultaneous display modes. When this function is selected, the bottom portion of the display shows the on/off status of each configured channel and allows the setting to be changed. Each configured channel is identified by its channel number.

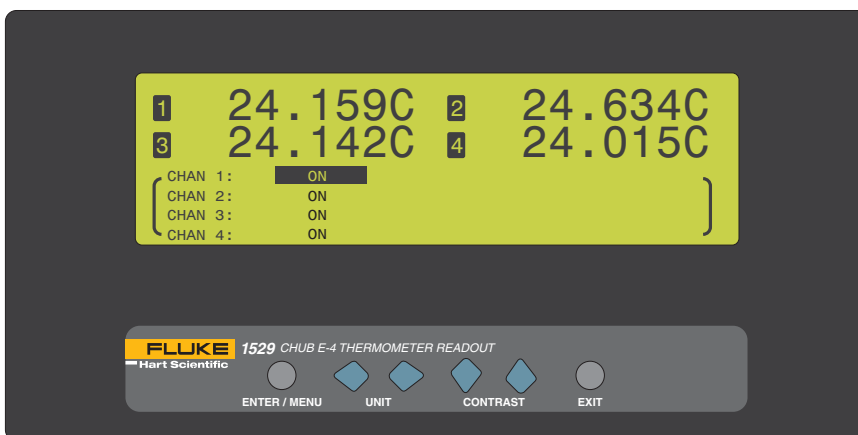

Figure 9 Enable Channel

Use the **▲▼** buttons to select the channel to change. The **◀▶** buttons are used to change the setting. Press the **Enter** button to save the setting. Press and

hold the **Exit** button to cancel to the main display or press the **EXIT** button to cancel and to move to the next parameter.

7.1.3 Channel Mode

The CHANNEL MODE function sets the channel display mode. When this function is selected, the bottom portion of the display shows the current scan mode and allows the setting to be changed.

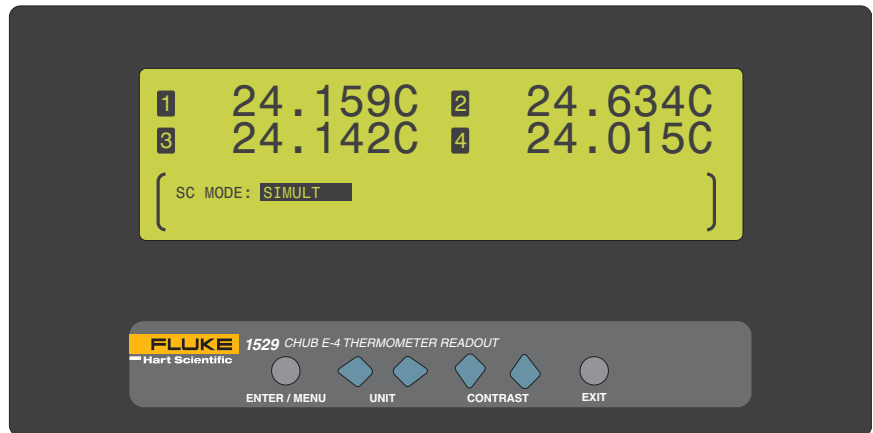

Figure 10 Channel Mode

The following scan modes are available:

- SCAN - measures enabled channels scanning through and displaying the channels one at a time, sequentially, in large digit format.
- SIMULT - measures and displays enabled channels simultaneously.

The ◀▶ buttons are used to select a setting. Press the **Enter** button to save the setting and exit. Press the **Exit** button to cancel and to exit to the menu.

If the measure period is 0.1 or 0.2 seconds, the CHANNEL MODE function is unavailable. The channel mode is automatically set to scan mode. The following message is displayed when the CHANNEL MODE function is selected.

NOT AVAILABLE AT THIS RATE.

Press ENTER to continue...

If the measure period is 0.5 seconds or greater, the channel mode operates normally.

7.1.4 Moving Average

The MOVING AVERAGE function sets the input averaging. The moving average filter is useful for smoothing variations in the measurements and for im-

proving resolution. When this function is selected, the bottom portion of the display shows the averaging setting and allows the setting to be changed. Select the number of raw measurements to be averaged to produce the displayed measurement. The range is from 1 to 10. The factory default is 1.

The measurements are averaged together until the selected number of measurements to average has been reached. Then the calculated average is based on the selected number of measurements to average. For example, if the selected number of measurements to average is selected as 3, the 1st measurement is displayed, the 1st and 2nd measurements are averaged and displayed, and then the 1st, 2nd, and 3rd measurements are averaged and displayed. From this point forward each displayed measurement consists of the last three measurements averaged together.

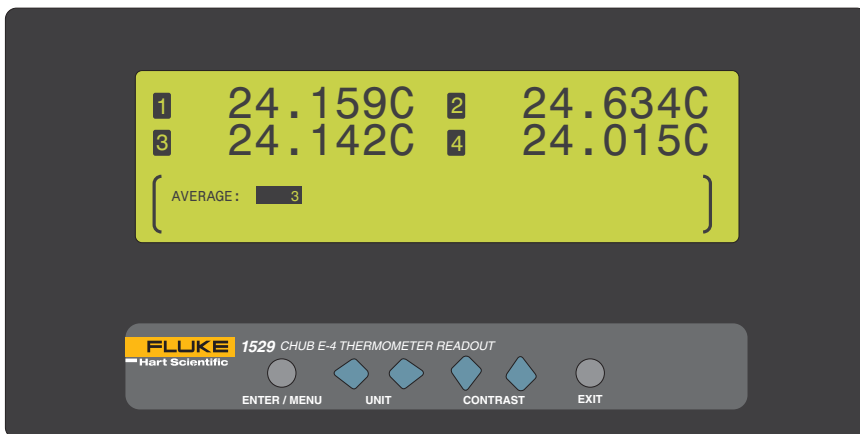

Figure 11 Moving Average

The **◀▶** buttons are used to select a setting. Press the **Enter** button to save the setting and exit. Press the **Exit** button to cancel and to exit to the menu.

7.1.5 Display Options/Auto-Cal

The DISPLAY OPTIONS function is displayed when the measure period is one second or greater and allows you to select the display resolution, decimal character, and lamp illumination. The AUTO-CAL function is displayed when the measure period is 0.1, 0.2, or 0.5 seconds and allows a full measurement to be taken. When the DISPLAY OPTIONS function is selected, the bottom portion

of the display shows the current display settings. This function is the same as the FIELDS menu DISPLAY OPTIONS function.

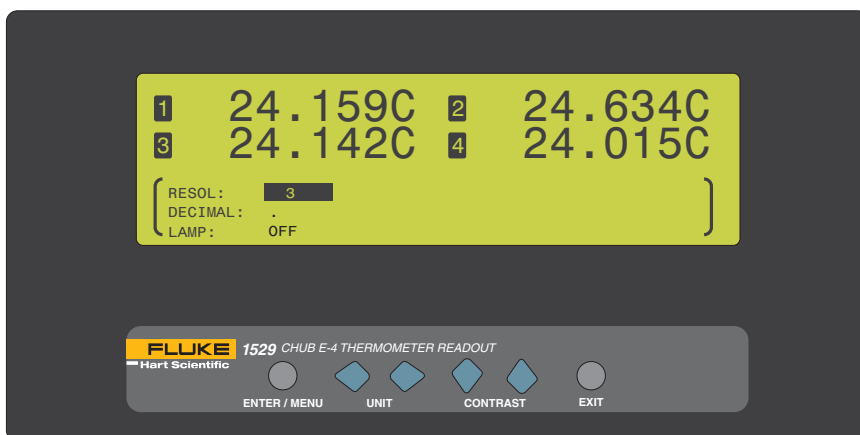





Figure 12 Display Options

The RESOL parameter determines the number of decimal places (0 through 4 or AUTO) to be displayed for the temperature measurements. If AUTO is selected, the instrument automatically determines the number of decimal places to display depending on the probe conversion type.

The DECIMAL parameter is for selecting the character used as the decimal separator. The choices are period (.) or comma (,).

The LAMP parameter specifies the brightness of the display (OFF, LOW, MED, HIGH). Enabling this parameter causes the battery to discharge faster.

Use the   buttons to change the parameter setting. Use the   buttons to scroll between the parameters. Press the **Enter** button to save the new setting. Press and hold the **Exit** button to cancel to the main display or press the **EXIT** button to cancel and to move to the next parameter.

When the AUTO-CAL function is selected, the following message is displayed.

FAST MODE AUTO CAL.

Press ENTER to continue...

Press the **Enter** button to perform the full measurement function. Press the **Exit** button to cancel and to exit to the menu.

7.2 Probe Menu

The PROBE menu provides functions for specifying the channel, probe type, the type of temperature conversion and coefficients, copying probe parameters,

testing conversion settings, viewing and printing probe parameters, and clearing the default probe. The functions that appear in this menu are EDIT PROBE, COPY PROBE, TEST PROBE, PRINT PROBE, and DEFAULT PROBE.

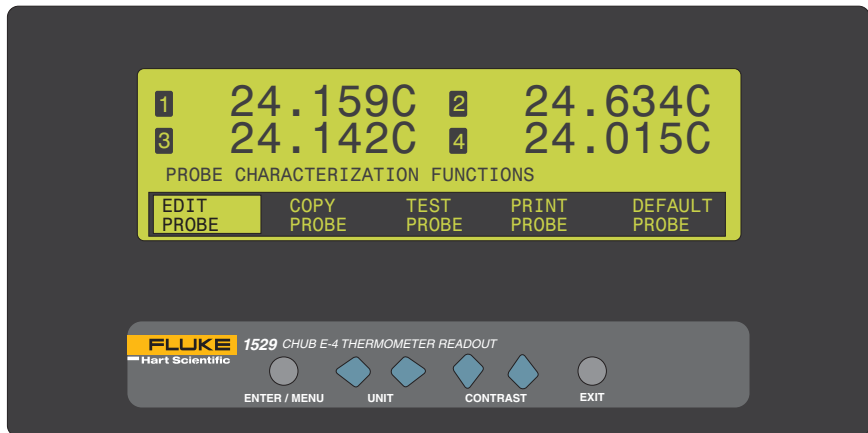

Figure 13 Probe Menu

7.2.1 Edit Probe

The EDIT PROBE function allows you to select a probe channel, enter the probe serial number, and select the conversion type and characterization coefficients and parameters. You select the probe channel from one of the four probe channel setups or from one of the ten memory setups.

The EDIT PROBE function can be password protected to restrict access. See Section 7.5.3, Password, for more information. If this function is password protected, the user is prompted to enter the password to gain access. If an incorrect password is entered, the display shows the message PASSWORD INCORRECT and access is denied. If the correct password is entered or if this function is not password protected, the bottom portion of the display shows the probe

channel, the probe serial number and the conversion type. The characterization coefficients and parameters are displayed after the conversion type is selected.

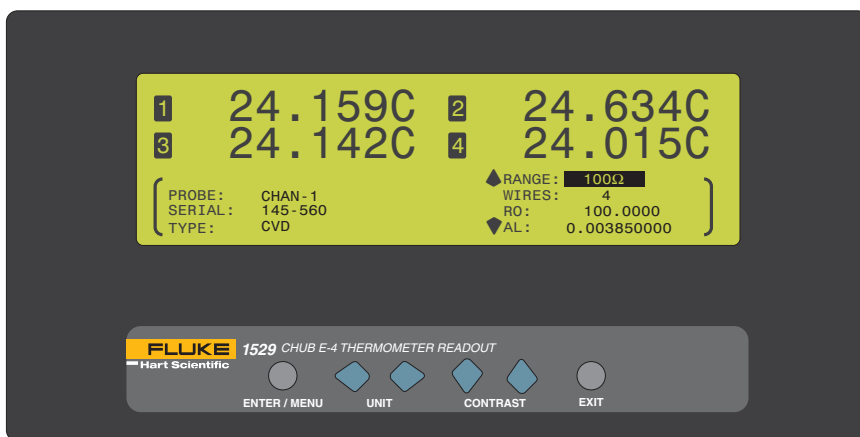

Figure 14 Edit Probe

The PROBE parameter is for selecting any one of the four input channels: CHAN1, CHAN2, CHAN3 and CHAN4 or one of the ten probe memory channels: PMEM0, PMEM1, PMEM2, PMEM3, PMEM4, PMEM5, PMEM6, PMEM7, PMEM8, and PMEM9. The probe memory channels are for storing probe settings that can later be used to copy to an input channel.

The SERIAL parameter is the serial number of the probe being edited. The serial number consists of a string of up to eight characters using any numeric digits, letters, and underscore.

The TYPE parameter is the conversion type for the corresponding input channel. The list of possible conversion types for each probe type is given in Table 2. The conversion types available are dependent on the probe or channel type as indicated in the table. The characterization coefficients and parameters are displayed after the conversion type is selected. These coefficients may change depending on the selected conversion type. The conversions and related coefficients and parameters are explained in the following sections.

The ◀▶ buttons are used to select the parameter setting. The ▲▼ buttons are used to scroll between and to change each digit of the parameter. Press the **Enter** button to change and save the new setting. Press and hold the **Exit** button to cancel to the main display or press the **EXIT** button to cancel and to move to





the next parameter. On the last parameter, press the **Exit** button to exit to the menu.

Table 2 Conversion Types

Probe Type	Conversion Type
SPRT, PRT, RTD	ITS-90 (default)
	ITS-SR5
	PT-100
	CVD
	RES (Ω)
Thermistor	THRM R(T)
	THRM T(R)
	YSI-400
	RES ($K\Omega$)
Thermocouple	TC-K (default)
	VIN [mV]
	TC-B
	TC-E
	TC-J
	TC-N
	TC-R
	TC-S
	TC-T
	TC-AU/PT
	Polynomial

7.2.1.1 ITS-90 Conversion

The ITS-90 conversion is for PRTs calibrated and characterized using the *International Temperature Scale of 1990* equations. The parameters that appear when ITS-90 is selected are RTPW, A4, B4, A, B, C, and D. These should be set with the corresponding values that appear on the calibration certificate for the PRT. The parameter RTPW takes the triple point of water resistance from the certificate. The parameters A, B, C, and D take the a_n , b_n , c_n , and d coefficients from the certificate, where n is a number from 6 to 11. Parameters A4 and B4 take the a_4 and b_4 coefficients on the certificate. *Any ITS-90 parameter of the 1529 that does not have a corresponding coefficient on the PRT certificate must be set to 0.*

When the ITS-90 conversion type is selected, the RANGE, WIRES, and coefficients are displayed on the right portion of the bottom of the display. The   buttons are used to scroll through the coefficients. Use the **Enter** button to edit and to save the new settings. Use the   buttons to change each digit of the settings. Press and hold the **Exit** button to cancel to the main display or press the **EXIT** button to cancel and to move to the next parameter. On the last parameter, press the **Exit** button to exit the menu.

The RANGE parameter is used to select the appropriate resistance range. For 25 ohm and 100 ohm PRTs select 100 ohms and for 1000 ohm PRTs select 10K ohms.

The WIRES parameter sets the appropriate number of lead wires from the sensor. This parameter can be set to 2-, 3-, or 4-wires. See Figure 5 on page 22 for the wiring configuration.

The following table shows which parameter to set for each of the coefficients that may appear on the certificate. **Note:** If the certificate has two sets of coefficients, one set for “zero-power” calibration and one set for 1 mA calibration, use the coefficients for the 1 mA calibration.)

Matching Certificate Values to the 1529 ITS-90 Coefficients

1529 ITS-90 Coefficients	Certificate Value
A	a6, a7, a8, a9, a10, or a11
B	b6, b7, b8, or b9
C	c6, c7
D	d
A4	a4
B4	b4



The following example demonstrates how to set the ITS-90 parameters for the case where a PRT was calibrated to ITS-90 and its calibration certificate states values for coefficients Rtpw, a4, b4, a8, and b8. Set the 1529 parameters with values from the certificate as follows.

Setting Coefficients Rtpw, a8, b8, a4, and b4

1529 ITS-90 Coefficients	Certificate Value
RTPW	Rtpw
A	a8
B	b8
C	0
D	0
A4	a4
B4	b4

7.2.1.2 ITS-SR5

The ITS-SR5 conversion is a special case of the ITS-90 conversion type. This conversion is for the ITS-90 sub-range 5 only.

When the ITS-SR5 conversion type is selected, the RTPW, A5, and B5 coefficients are displayed on the right portion of the bottom of the display. The   buttons are used to scroll through the coefficients. Use the **Enter** button to edit

and to save the new settings. Use the **◀▶** buttons to change each digit of the settings. Press and hold the **Exit** button to cancel to the main display or press the **EXIT** button to cancel and to move to the next parameter. On the last parameter, press the **Exit** button to exit the menu.

7.2.1.3 PT-100 Conversion

The parameters for the PT-100 conversion are R0 (R0), ALPHA (α), DELTA (δ), and BETA (β). These parameters cannot be changed by the user and are set to; R0: 100.0, ALPHA: 0.00385055, DELTA: 1.4998, and BETA: 0.109, which are applicable to the ASTM E1137 type PRTs, also known as DIN-43760 or IEC-751.

When the PT-100 conversion type is selected, the RANGE and WIRES parameters are displayed on the right portion of the bottom of the display. The **◀▶** buttons are used to scroll through the parameters. Use the **Enter** button to change and save the new settings. Press and hold the **Exit** button to cancel to the main display or press the **EXIT** button to cancel and to move to the next parameter. On the last parameter, press the **Exit** button to exit the menu.

The RANGE parameter is used to select the appropriate resistance range. Generally, this should be set to 100 ohms.

The WIRES parameter sets the appropriate number of lead wires from the sensor. This parameter can be set to 2-, 3-, or 4-wires. See Figure 4 on page 22 for the wiring configuration.

7.2.1.4 Callendar-Van Dusen (CVD) conversion

The following equations are used for the Callendar-Van Dusen conversion:

$$r(t[^\circ\text{C}]) = \begin{cases} R_0 \left\{ 1 + \alpha \left[t - \delta \frac{t}{100} \left(\frac{t}{100} - 1 \right) \right] \right\} & t \geq 0 \\ R_0 \left\{ 1 + \alpha \left[t - \delta \frac{t}{100} \left(\frac{t}{100} - 1 \right) - \beta \left(\frac{t}{100} - 1 \right) \left(\frac{t}{100} \right)^3 \right] \right\} & t \leq 0 \end{cases}$$



The user-defined parameters for the Callendar-Van Dusen conversion are R0 (R0), ALPHA (α), DELTA (δ), and BETA (β). The defaults are R0: 100.0, ALPHA: 0.00385055, DELTA: 1.4998, and BETA: 0.109, which are applicable with DIN-43760 or IEC-751 type PRTs.

Some probes may be provided with A, B, and C coefficients for the Callendar-Van-Dusen equation in the following form:

$$r(t[^\circ\text{C}]) = \begin{cases} R_0 (1 + At + B^2) & t \geq 0 \\ R_0 [1 + At + Bt^2 + C(t-100)t^3] & t \leq 0 \end{cases}$$



The A, B, and C coefficients can be converted to α , δ , and β coefficients using the following formulas:

$$\alpha = A + 100B \quad \delta = -\frac{100}{\frac{A}{100B} + 1} \quad \beta = -\frac{10^8 C}{A + 100B}$$

When the CVD conversion type is selected, the R0, ALPHA, DELTA, and BETA coefficients are displayed on the right portion of the bottom of the display. Use the   buttons to scroll through the coefficients. Use the **Enter** button to edit and save the new setting. Press and hold the **Exit** button to cancel to the main display or press the **EXIT** button to cancel and to move to the next parameter. On the last parameter, press the **Exit** button to exit to the menu.

7.2.1.5 RES Conversion

The RES conversion displays the measurement as resistance in ohms or K ohms depending on the range.

When the RES conversion type is selected, the RANGE and WIRES parameters are displayed on the right portion of the bottom of the display. The   buttons are used to scroll through the parameters. Use the **Enter** button to change and save the new settings. Press and hold the **Exit** button to cancel to the main display or press the **EXIT** button to cancel and to move to the next parameter. On the last parameter, press the **Exit** button to exit the menu.

The RANGE parameter is used to select the appropriate resistance range. For 25 ohm and 100 ohm PRTs, select 100 ohm and for 1000 ohm PRTs, select 10 K ohm.

The WIRES parameter sets the appropriate number of lead wires from the sensor. This parameter can be set to 2-, 3-, or 4-wires. See Figure 5 on page 22 for the wiring configuration.



7.2.1.6 Thermistor T(R) Conversion [THERM-T]

The following Steinhart-Hart equation is used for the thermistor T(R) conversion:

$$T(r)[K] = [A_0 + A_1 \ln r + A_2 \ln^2 r + A_3 \ln^3 r]^{-1}$$

The user-defined parameters for the thermistor T(R) conversion are A0 (A_0) through A3 (A_3) as shown on a typical Hart Scientific thermistor calibration report. If A_2 is not used, as is the case with some calibrations, A_2 should be set to 0.0.

Note: Thermistor coefficients stated on the thermistor calibration report may be labeled differently. The best way to identify the coefficients to use with this type is to match the equation above with the equation given on the calibration report. Also, recognize that the coefficients for this equation generally have negative exponents, e.g. A_3 : 1.39456E-07.

When the Thermistor T(R) conversion type is selected, the coefficients are displayed on the right portion of the bottom of the display. Use the   buttons to scroll through the coefficients. Use the **Enter** button to edit and save the new setting. Press and hold the **Exit** button to cancel to the main display or press the **EXIT** button to cancel and to move to the next parameter. On the last parameter, press the **Exit** button to exit to the menu.



7.2.1.7 Thermistor R(T) Conversion [THERM-R]

The following Steinhart-Hart equation is used for the thermistor R(T) conversion:

$$r(T[K]) = \exp[B_0 + B_1 T^{-1} + B_2 T^{-2} + B_3 T^{-3}]$$

The user-defined parameters for the thermistor R(T) conversion are B0 (B₀) through B3 (B₃) as shown on a typical Hart Scientific thermistor calibration report. If B₂ is not used, as is the case with some calibrations, B2 should be set to 0.0.

Note: Thermistor coefficients stated on the thermistor calibration report may be labeled differently. The best way to identify the coefficients to use with this type is to match the equation above with the equation given on the calibration report. Also, recognize that the coefficients for this equation generally have positive exponents, e.g. B3: -6.23659E+06.

When the Thermistor R(T) conversion type is selected, the coefficients are displayed on the right portion of the bottom of the display. Use the   buttons to scroll through the coefficients. Use the **Enter** button to edit and save the new setting. Press and hold the **Exit** button to cancel to the main display or press the **EXIT** button to cancel and to move to the next parameter. On the last parameter, press the **Exit** button to exit to the menu.

7.2.1.8 YSI-400 Conversion

The YSI-400 conversion type is for 2252Ω thermistors matching the characteristics of the YSI-400 series of thermistors.

There are no user programmable coefficients associated with this conversion type. Use the **Enter** button or **Exit** button to exit the menu.

7.2.1.9 Thermocouple Volts [Vin[mV]]

The thermocouple volts displays the measurement in volts rather than temperature.

Note: When selecting volts as the conversion type for thermocouples, no cold-junction compensation is available. The value measured and displayed is the uncompensated voltage as sensed at the input of the module.

There are no user programmable coefficients associated with this conversion type. Use the **Enter** button or **Exit** button to exit to the menu.

7.2.1.10 Standard Thermocouple Conversions



Note: An Application Note for use of Tungsten-Rhenium and other thermocouples is available at www.hartscientific.com.

Standard thermocouple conversions include types B, E, J, K, N, R, S, T, and Au-Pt. Voltage is converted to temperature using standard reference functions. (For additional information consult the publication NIST Monograph 175.)

You can specify internal or external reference junction compensation (RJC) with the RJC parameter. (See Table 9 on page 125.) With internal RJC, the temperature of the thermocouple cold junction is measured automatically and used to calculate the absolute temperature of the thermocouple. With external RJC, a reference junction at a known fixed temperature is used and the value of this fixed temperature reference must be entered in the RJT parameter and is used to calculate the absolute temperature of the thermocouple.



Conversions for each of the thermocouple types accept functional calibration data. This can be used to improve the measurement accuracy. The parameter, Tn, is the temperature of the point in degrees Celsius. The parameter, ADJn, is the temperature deviation from the reference function at the point in degrees Celsius. The temperature measurement is adjusted by this amount when measuring at this temperature. A polynomial interpolation function is used for measurements between calibration points. If calibration data is not available or is not to be used, the ADJn parameters should all be set to 0.0. This causes the temperature to be calculated according to the standard reference functions.

7.2.1.11 Thermocouple Polynomial Conversion



Note: An Application Note for use of Tungsten-Rhenium and other thermocouples is available at www.hartscientific.com.

The thermocouple polynomial conversion allows calculation of temperature by polynomial conversion.

When the Thermocouple Polynomial conversion type is selected, the coefficients are displayed on the right portion of the bottom of the display. Use the   buttons to scroll through the coefficients. Use the **Enter** button to edit and save the new setting. Press and hold the **Exit** button to cancel to the main display or press the **EXIT** button to cancel and to move to the next parameter. On the last parameter, press the **Exit** button to exit to the menu.

The following equation is used for the thermocouple polynomial conversion:

$$t(E[\text{mV}]][^{\circ}\text{C}] = \sum_{i=0}^6 C_i E^i$$

The user-defined parameters for the thermocouple polynomial conversion are the coefficients c_0 (C0) through c_6 (C6). The user can specify internal or external reference junction compensation (RJC; see Table 9 on page 125). If external RJC is selected, the user enters the temperature of the RJC reference in the reference junction temperature (RJT) parameter.

The output of the thermocouple, in millivolts, at 25°C with the reference junction at 0°C, is mV(25°C). For example, for a type K thermocouple, mV(25°C) is 1.0002.

7.2.2 Copy Probe

The COPY PROBE function allows you to copy a set of probe parameters from one channel or memory location to another. The parameters are copied from the user selected source channel or memory location into the current channel. The COPY PROBE function can be password protected to restrict access. See Section 7.5.3, Password, for more information. If this function is password protected, the user is prompted to enter the password to gain access. If an incorrect password is entered, the display shows the message PASSWORD INCORRECT and access is denied. If the correct password is entered or if this function is not password protected, the bottom portion of the display appears showing the source channel or memory location, the probe serial number, and the conversion type. The destination channel or memory location is displayed after the source channel type is selected.

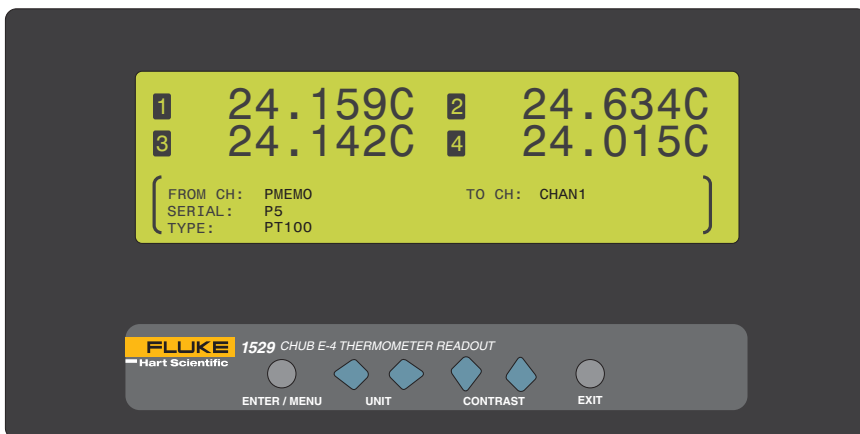

Figure 15 Copy Probe

Use the **◀▶** buttons to select the source channel or memory location. Press the **Enter** button to save the new setting. Press the **Exit** button to cancel and to exit to the menu.

7.2.3 Test Probe

The TEST PROBE function allows you to test the probe characterization algorithm and characterization coefficients for a specific probe. The probe and probe type must be setup in the EDIT PROBE function prior to entering the TEST PROBE function. When this function is selected, the bottom portion of the display shows the probe channel or memory location, the probe serial number, and the conversion type.

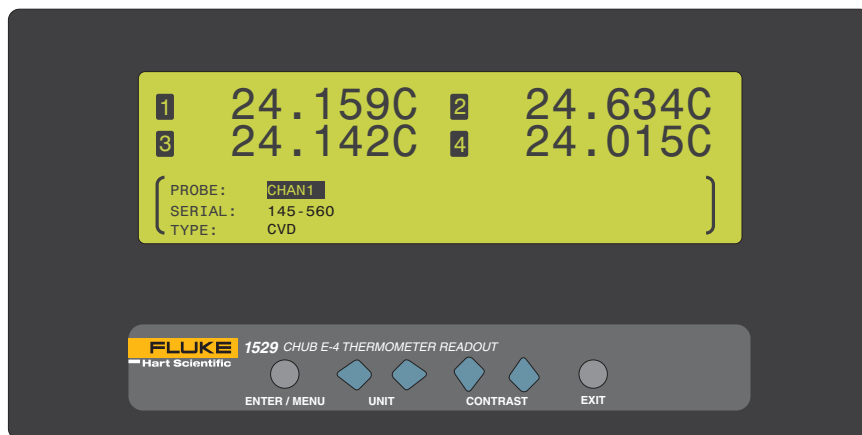



Figure 16 Test Probe

Use the   buttons to select the channel or memory location. After the channel is selected, press the **Enter** button to test the temperature calculation for the probe. You can enter an input value (Ω , $K\Omega$, or millivolts) and the corresponding output value (e.g. temperature) is shown. Press the **Exit** button to exit to the menu.

7.2.4 Print Probe

The PRINT PROBE function allows you to print probe characteristics to the serial port. Probe characteristics for a specific channel or memory location can be

printed or for all channel and memory locations. When this function is selected, the bottom portion of the display shows the probe channel.

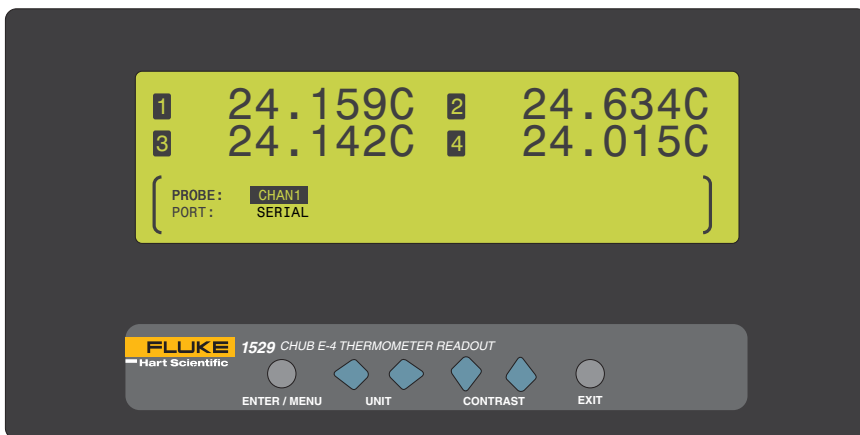





Figure 17 Print Probe

Use the   buttons to select the channel, memory location, or ALL. Use the   buttons to scroll between parameters. Press the **Enter** button to continue and to send the data to the selected port. A message is displayed stating the channel to print and the port. Press the **Enter** button to print the data. Press the **EXIT** button to cancel and to exit to the menu.

7.2.5 Default Probe

The DEFAULT PROBE function allows you to reset the probe coefficients for a

selected channel, memory location, or ALL to the factory defaults. When this function is selected, the bottom portion of the display shows the probe channel.

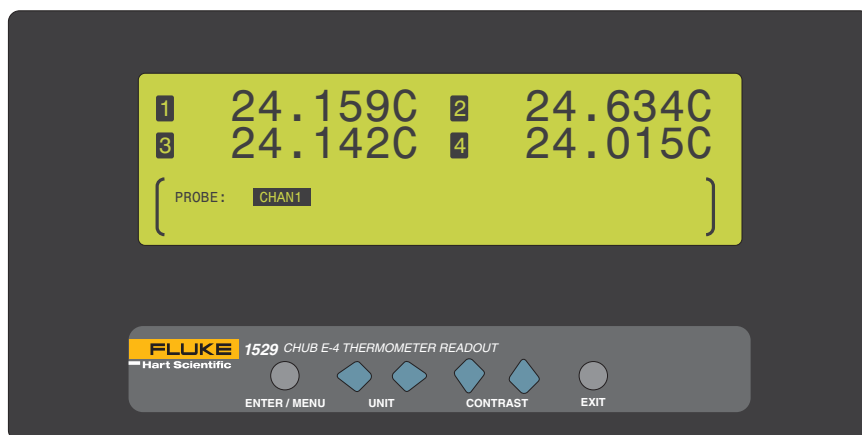



Figure 18 Default Probe

Use the   buttons to select the channel, memory location, or ALL. Press the **Enter** button to reset the probe coefficients. Press the **Exit** button to cancel and to exit to the menu.

7.3 Fields Menu

The FIELDS menu allows for the programming and altering of the data displayed in the lower portion of the display. Commands in this menu allow the user to select specific data fields to be displayed and stored by display sets. The

functions that appear in this menu are CLEAR STATS, SELECT FIELDS, EDIT FIELDS, DEFAULT FIELDS, and DISPLAY OPTIONS.

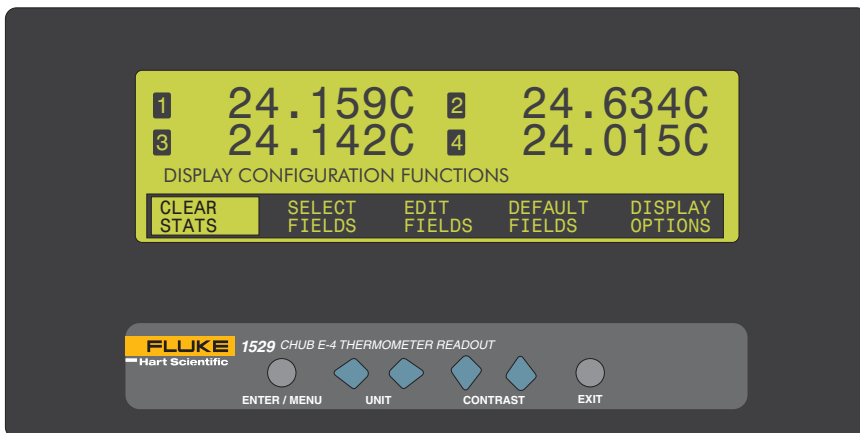

Figure 20 Fields Menu

7.3.1 Clear Stats

The CLEAR STATS function clears the statistical registers and resets all statistical calculations for all channels. Refer to Section 7.3.2, Select Fields, to display statistical data. When this function is selected, the bottom portion of the display states that you must press the **Enter** button to clear the statistical data.

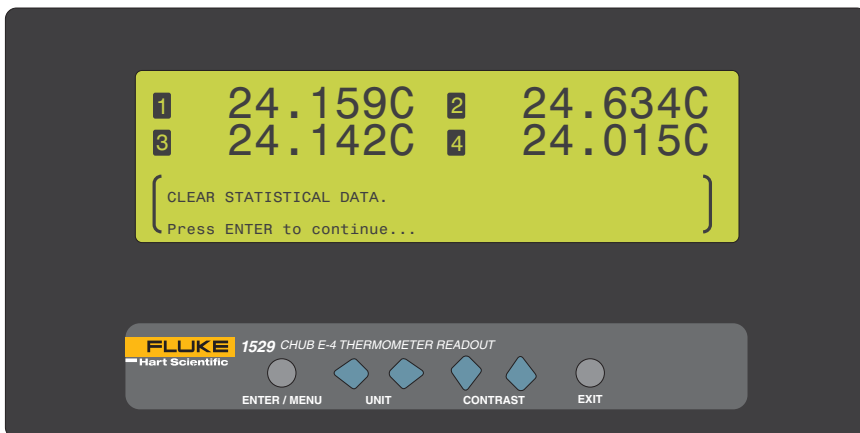

Figure 19 Clear Stats

Press the **Enter** button to clear the statistical data. Press the **Exit** button to abort clearing the statistical data and to exit to the menu.

7.3.2 Select Fields

The SELECT FIELDS function allows you to select a display set (1 through 9) to use for displaying information provided by the instrument. A display set can be customized to display up to eight different fields. See the table of Field Types below. When this function is selected, the bottom portion of the display allows you to select the display set and also shows the information that is displayed for each set. To edit a display set, see Section 7.3.3, Edit Fields.

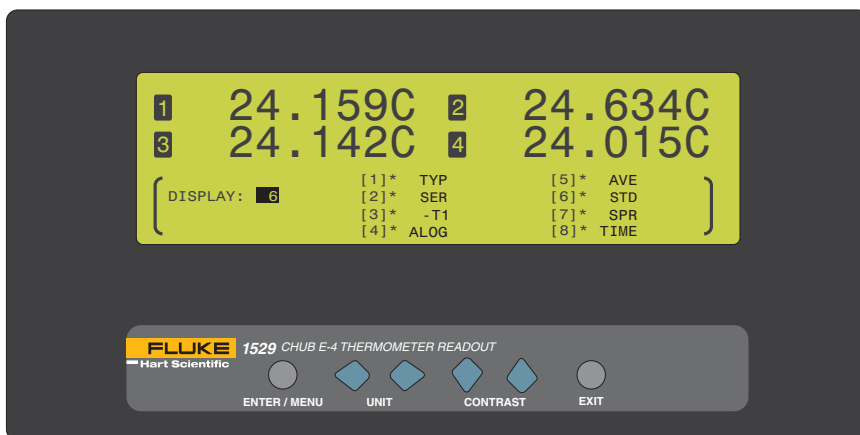



Figure 21 Select Fields

Use the   buttons to select the display set number. Press the **Enter** button to save the new setting and exit. Press the **Exit** button to cancel and to exit to the menu.

Keyword	Field Type
AVE	Average
BATT	Battery Percent Remaining
DATE	Date
INP	Input in ohms, K ohms, or mV
MAX	Maximum
MEAS	Number of Seconds Until Next Measurement
MIN	Minimum
REF	Reference (see below)
SER	Probe Serial Number
SPR	Spread
STD	Standard Deviation
STN	Count
-T1, -T2, -T3, -T4	Delta
TEM	Temperature
TIME	Time
TYP	Conversion Type
ALOG	Indicating of auto logging is on or off
----	Blank

Note: When the field type reference (REF) is selected, the displayed keyword changes depending on the probe type. The reference display keywords are detailed in the following table.

REF Display Keywords		
Probe Type	Keyword	Description
RES	RIN	Resistance
ITS-90 ITS-SR5	RTP	R(0.01°C)
PT-100 CVD	R0	R(0°C)
THERM-R THERM-T YSI-400	R25	R(25°C)
VIN[mV] Thermocouples	RJT	Reference Junction Temperature

7.3.3 Edit Fields

The EDIT FIELDS function allows editing of the display fields for a given display set (1 through 9). You can choose to display one to eight fields. The available fields and their corresponding keywords are given in the Field Types table above. When this function is selected, the bottom portion of the display allows you to select the display set to edit.

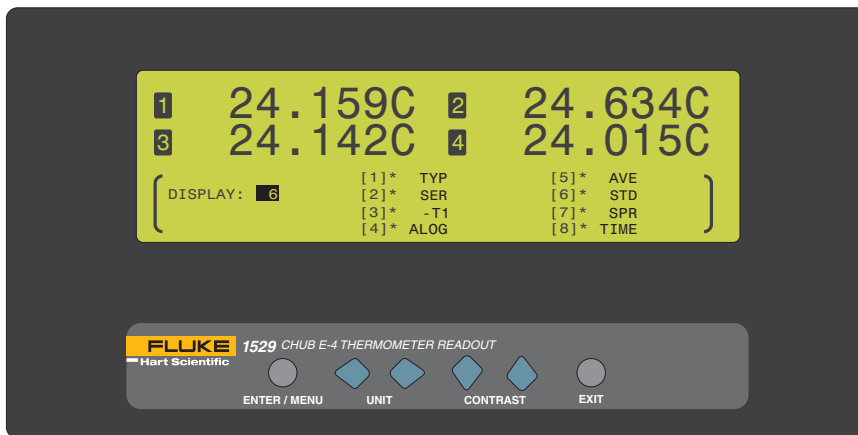

Figure 22 Edit Fields

The rightmost portion of the bottom of the display shows the current settings for the eight fields for the selected display set. The field numbers appear in the square brackets ([]) and are not editable. The character immediately to the right of the field number is editable and indicates the channel (*, or 1 through 4). If the * is selected and you are in simultaneous mode, channel one is displayed. If you are in scan mode, selecting the * displays the current channel. The field item is editable and is to the right of the channel. The table of Field Types above shows the keywords for each type of field item.

Press the ◀▶ buttons to select the display set. Press the **Enter** button to select the field parameters (channel and field type) to adjust. Use the ◀▶ buttons to adjust the parameter value. Use the ▲▼ buttons to move between parameters. Press the **Exit** button to exit to the menu.

7.3.4 Default Fields

The DEFAULT FIELDS function clears all display sets and resets them to the

factory defaults. When this function is selected, the bottom portion of the display instructs you to press **Enter** to revert to the default display set.

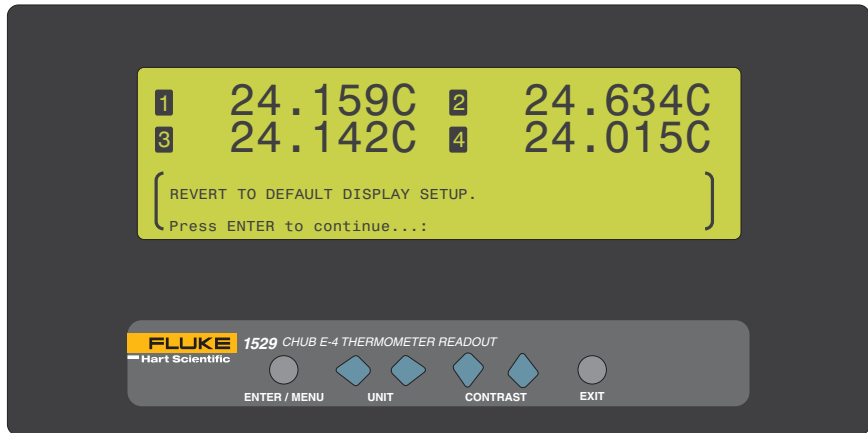

Figure 23 Default Fields

Press the **Enter** button to revert to the default display setup. Press the **Exit** button to exit to the menu.

7.3.5 Display Options

The DISPLAY OPTIONS function allows you to select the display resolution, decimal character, and lamp illumination. When this function is selected, the

bottom portion of the display shows the current display settings. This function is the same as the CHANNEL MODE menu DISPLAY OPTIONS function.

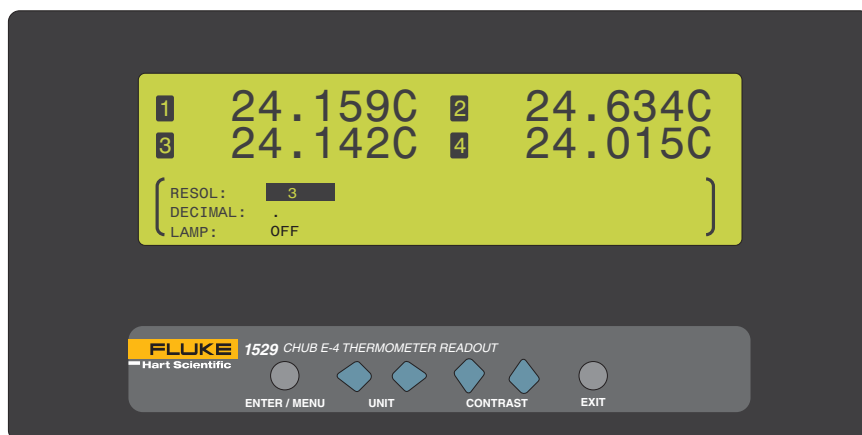

Figure 24 Display Options

The RESOL parameter determines the number of decimal places (0 through 4 or AUTO) to be displayed for the temperature measurements. If AUTO is selected, the instrument automatically determines the number of decimal places to display depending on the conversion type.

The DECIMAL parameter is for selecting the character used as the decimal separator. The choices are period (.) or comma (,).

The LAMP parameter specifies the brightness of the display (OFF, LOW, MED, HIGH). Enabling this parameter causes the battery to discharge faster.

Press the ◀▶ buttons to select the parameter setting. Use the ▲▼ buttons to scroll between the parameters. Press the **Enter** button to save the new setting. Press the **Exit** button to cancel and to exit to the menu.

7.4 Logging Menu

The LOGGING menu provides functions for logging measurements on demand and automatically, displaying log statistics, editing data labels, and resetting the data labels to their default values. The submenus and functions that appear in

this menu are DEMAND LOG, AUTO LOG, LOG STATS, DATA LABELS, and DEFAULT LABELS.

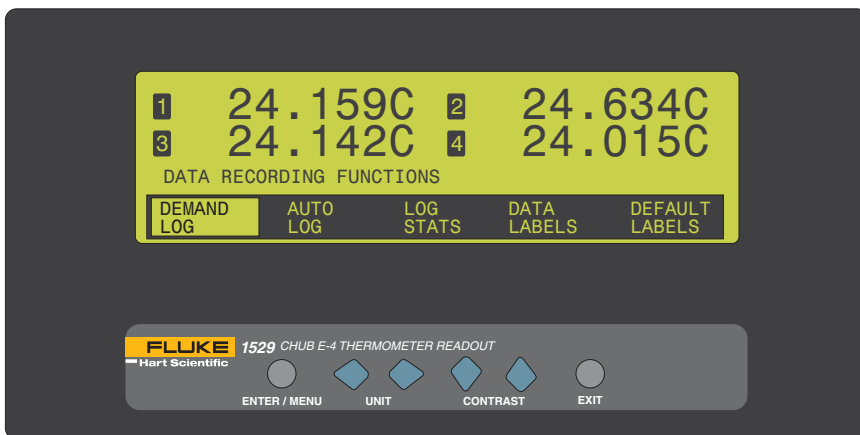

Figure 25 Logging Menu

7.4.1 Demand Log

The DEMAND LOG submenu allows measurements to be logged on demand, one reading at a time. Readings are stored to the instrument's memory and assigned a label for easy recall and organization of data. The instrument's memory can store up to 100 demand log readings.

Demand log values are stored exactly as they appear on the upper portion of the display. The resolution, temperature units, and the channels displayed should be set up prior to demand logging in order to ensure proper storage of data.

When this function is selected, the bottom portion of the display shows the de-

mand logging submenu which consists of the functions: STORE READING, LOG HISTORY, VIEW DATA, PRINT DATA, and DELETE DATA.

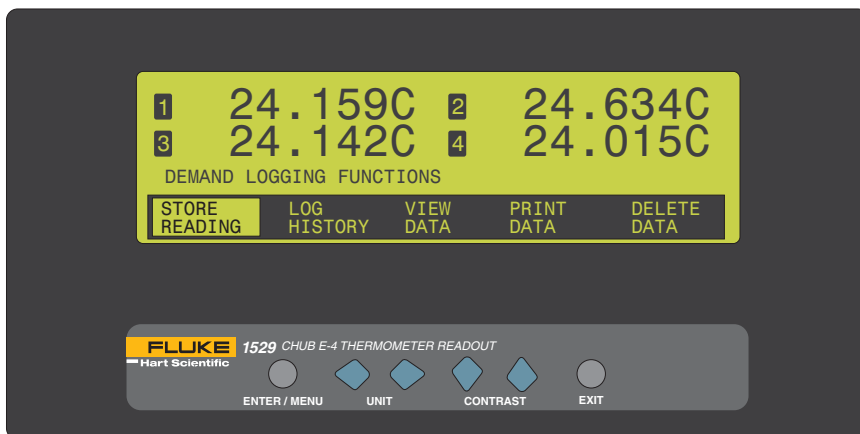

Figure 26 Demand Log Submenu

7.4.1.1 Store Reading

The STORE READING function stores the current measurements for all displayed channels. When the instrument is in simultaneous mode, all channels that are displayed on the upper portion of the 1529 display are stored simultaneously to the demand log. When the instrument is in scan mode, the channel currently displayed on the upper portion of the 1529 display is the only measurement that is stored to the demand log. For more information on the display modes see Section 8.1.3, Channel Mode.

When the STORE READING function is selected, the left side of the bottom portion of the display shows each channel, the measurement value (using the

current resolution setting), and the units as they are stored into memory. The right side of the bottom display shows the current label.

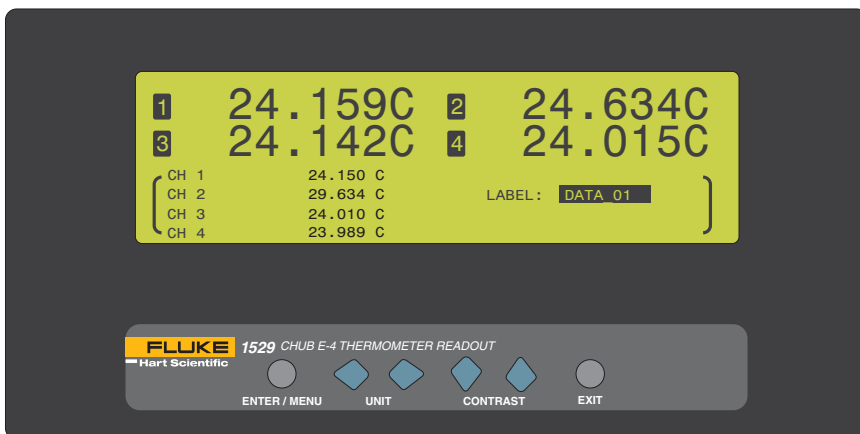



Figure 27 Store Readings

To change the label, press the   buttons to scroll through and select the label that applies to the demand log data being stored. For information on editing the labels see the DATA LABELS function of the LOGGING menu, Section 7.4.4.

After selecting the correct label, press the **Enter** button to store the label and measurement(s) to memory. Press the **Exit** button to cancel and to return to the DEMAND LOG menu.

7.4.1.2 Log History

The LOG HISTORY function displays the reading number, label, time, and date of each demand log entry in sequential order. To see the measurement values for each entry, use the DEMAND LOG menu VIEW DATA function.

When this function is selected, the bottom portion of the display shows the demand log history data.

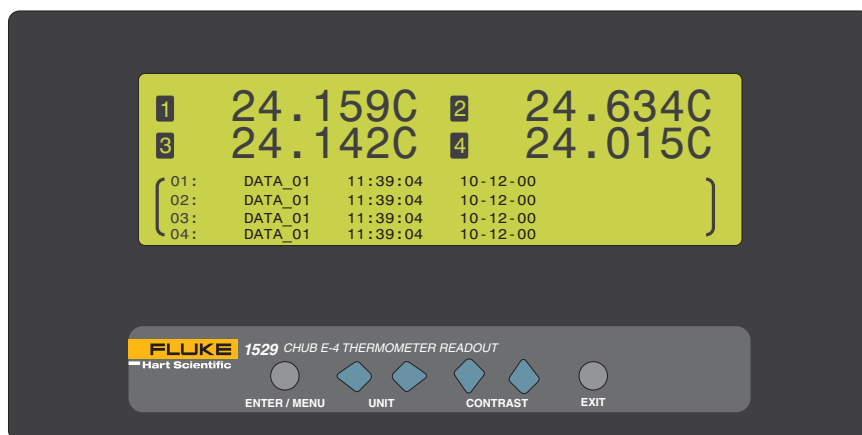

Figure 28 Log History

Press the buttons to scroll up and down through the stored readings sequentially one at a time. Press the buttons to scroll up and down through the stored readings sequentially by groups of 16. Press the **Enter** or **Exit** button to return to the DEMAND LOG menu.

7.4.1.3 View Data

The VIEW DATA function displays the reading number, label, channel, measurement value, units, and time (24 hour time format) of each demand log entry. To see the corresponding date, use the DEMAND LOG menu LOG

HISTORY function. When this function is selected, the bottom portion of the display shows the demand log data.

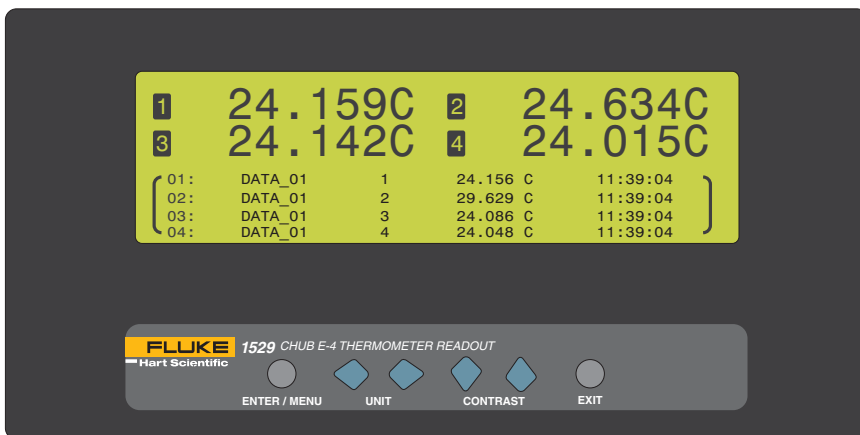





Figure 29 Demand Log View Data

Press the   buttons to scroll up and down through the stored readings sequentially. Press the   buttons to scroll up and down through the stored readings sequentially by groups of 16. Press the **Enter** or **Exit** button to return to the DEMAND LOG menu.

7.4.1.4 Print Data

The PRINT DATA function prints the demand log data for the selected label or for all labels. The demand log data is printed to the serial port. When this function is selected, the bottom portion of the display allows you to select the label of the demand log data to print or all data and the port. Select ALL DATA to

print all demand log entries, or select a specific label to print only the demand log data for that label.

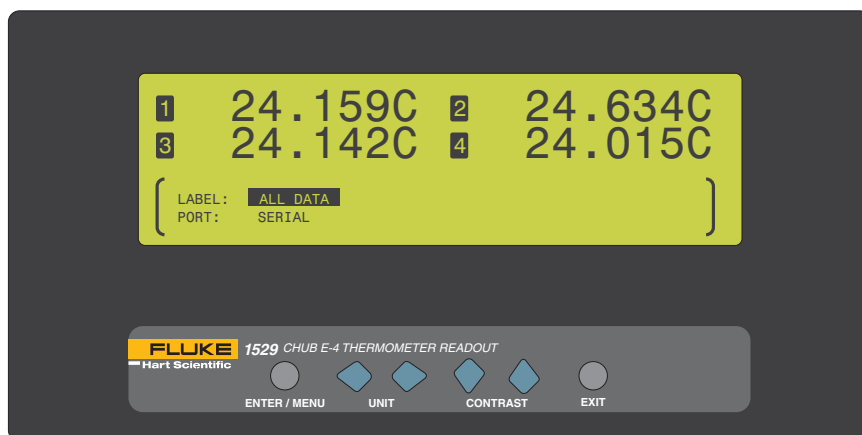

Figure 30 Print Data

Use the ◀▶ buttons to select the parameter settings. Use the ▲▼ buttons to scroll between parameters. Press the **Enter** button to continue. A message is displayed stating the label of the data to print and the port. Press the **Enter** button to print the data. Press the **EXIT** button to cancel and to exit to the menu.

7.4.1.5 Delete Data

The DELETE DATA function deletes the demand log data for a selected label or for all labels. When this function is selected, the bottom portion of the display allows the user to select the label of the demand log data to delete or all data. If readings for one label are deleted, the remaining entries are renum-

bered. Select ALL DATA to delete all demand log readings or select a specific label to delete only the demand log data for that label.

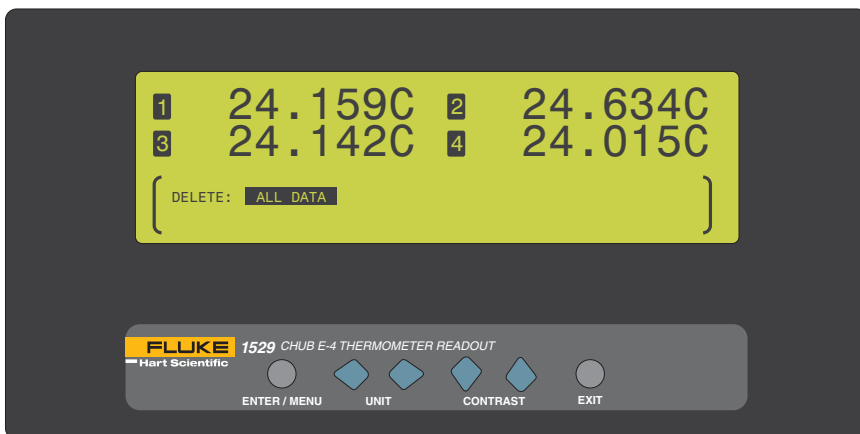



Figure 31 Delete Data

Use the   buttons to select the label of the data you want to delete. Press the **Enter** button to continue and delete the data. Press the **Exit** button to cancel and return to the DEMAND LOG menu.

7.4.2 Auto Log

The AUTO LOG function allows measurements to be logged automatically in user-selectable intervals. Readings are stored to the instrument's memory and assigned a label for easy recall and organization of data. The instrument's memory can store up to 8,160 auto log readings.

Auto log values are stored exactly as they appear on the upper portion of the display. The resolution, units, and the channels displayed should be set up prior to auto logging in order to ensure proper storage of data. All displayed channels are stored during an auto log session. If the upper portion of the display is changed while data is being auto logged, the data collected is modified from the time the display was changed. For example, if a channel is disabled while auto logging, that channel stops being stored from the time it was disabled.

When this function is selected, the bottom portion of the display shows the

AUTO LOG submenu and consists of the functions: LOGGING OPTIONS, START STOP, VIEW DATA, PRINT DATA, and DELETE DATA.

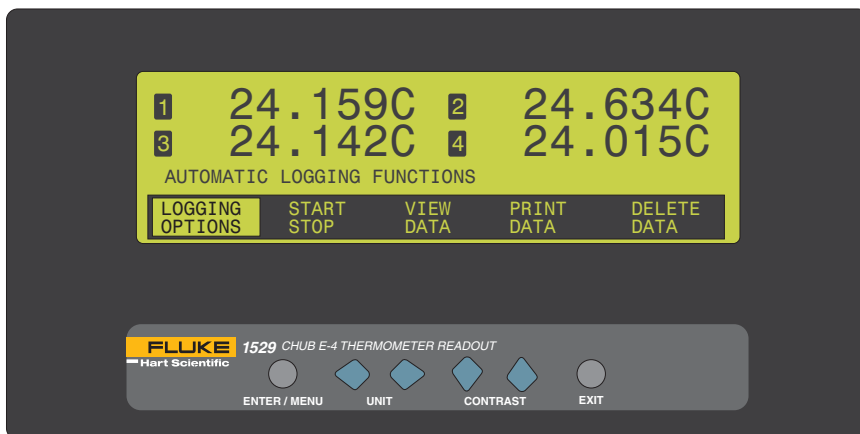

Figure 33 Auto Log Submenu

7.4.2.1 Logging Options

The LOGGING OPTIONS function allows the user to define the logging parameters. When this function is selected, the bottom portion of the display prompts the user to select the label, period, and count.

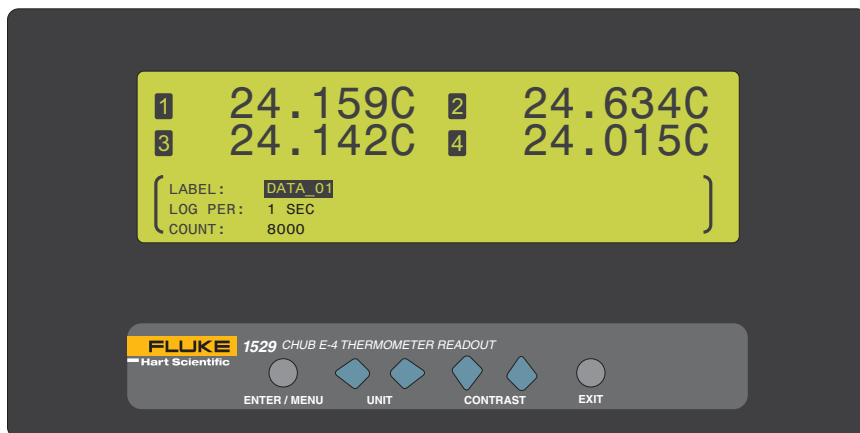

Figure 32 Logging Options

The LABEL parameter specifies the label for the auto log data. The labels are defined in the DATA LABELS function of the LOGGING menu or reset to the default labels in the DEFAULT LABELS function of the LOGGING menu.

The LOG PER parameter is for selecting the interval between measurements. You may select between 0.1, 0.2, 0.5, 1, 2, 5, 10, and 30 seconds, 1, 2, 5, 10, and 30 minutes or 1 hour. The LOG PER must be set to a value less than or equal to the measurement period. The 1529 will not log readings faster than the measurement period. The measurement period is set in the MEASURE PERIOD function of the CHANNEL menu and is the rate at which readings are taken.





If the log period is set to a value less than the measure period the following message is displayed in the lower portion of the display.

DATA WILL BE LOGGED NO FASTER THAN
THE MEASURE PERIOD (X SEC).

Press ENTER to continue...

The X in the message is the current measurement period. After the **Enter** button is pressed, the measurements are logged at the current measure period.

The COUNT parameter is for selecting the total number of readings to log. The default is 8,160, which is the maximum number of readings that can be logged. If the count is set to 10 and two channels are displayed on the screen at the time logging starts, five readings from each channel are logged for a total of 10 readings. The auto log automatically stops after the number of readings selected is reached or when the user stops the log manually.

Press the   buttons to change a setting and the   buttons to scroll between the parameters. Press **Enter** button to save the new setting. Press and hold the **Exit** button to cancel to the main display or press the **EXIT** button to cancel and to move to the next parameter.

7.4.2.2 Start Stop

The START STOP function starts and stops auto log sessions. When this function is selected, the user is prompted to either start or stop an auto log session by pressing the **Enter** button. If an auto log session is not currently running, the user is prompted to START RECORDING DATA. If an auto log session is running, the user is prompted to STOP RECORDING DATA.

Note: The log is not started or stopped until the **Enter** button is pressed to confirm the user action.

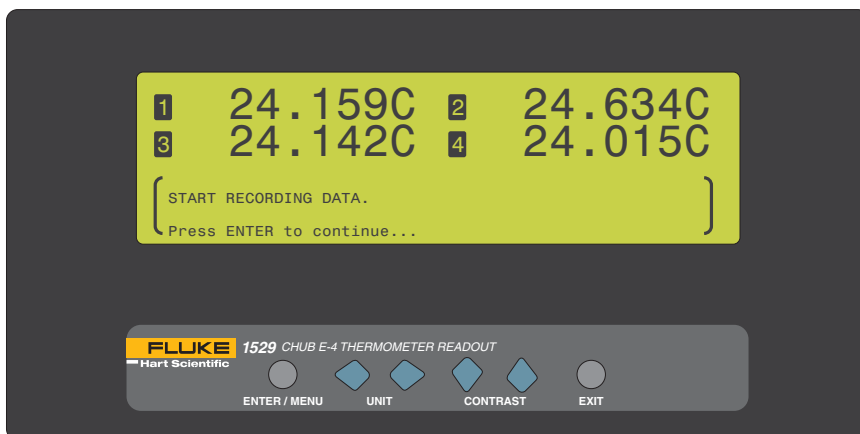

Figure 35 Start Stop

After a log session is started, the bottom portion of the display shows the log statistics. These statistics can also be viewed from the LOG STATS function of the LOGGING menu.

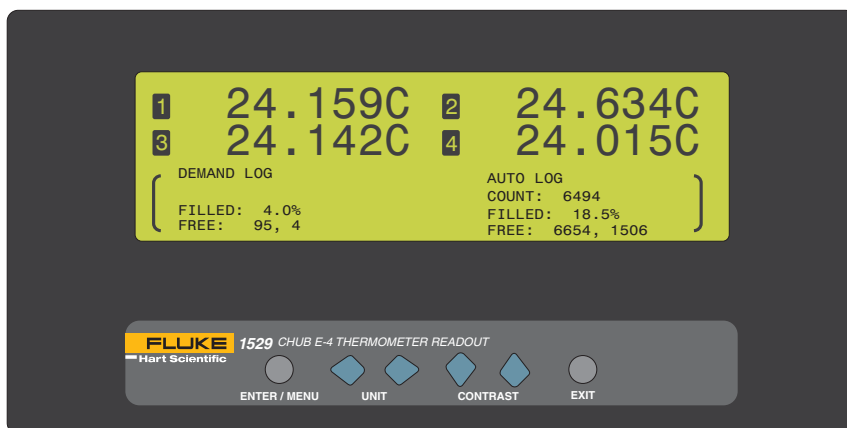

Figure 34 Log Statistics (Auto Log Started)

The left side displays demand log statistics and the right side displays the auto log statistics. The FILLED parameter shows the percentage of the total demand or auto log memory that is currently filled. The FREE parameter shows the number of readings remaining before the memory is full and the number of

readings currently stored in the demand or auto log memory. The COUNT parameter shows the number of auto log readings remaining during the current log session.

Press the **Enter** or **Exit** button to exit this display and to return to the AUTO LOG menu.

Only those channels that are enabled during the log session are logged. Although you may enable and disable channels during a log session we do not recommend this practice. If channels are disabled during the log session, the previously logged entries for those channels are not removed from the log.

From the main display, there are two ways to tell if data is being logged: (1) a logging indicator in the lower left-hand corner (looks like a strip-chart) and (2) by setting one of the display fields to the ALOG type (see Section 8.3.3, Edit Fields)

7.4.2.3 View Data

The VIEW DATA function displays the label, date, reading number, channel, measurement, units, and time of each auto log entry in sequential order. When this function is selected, the bottom portion of the display shows the auto log data.

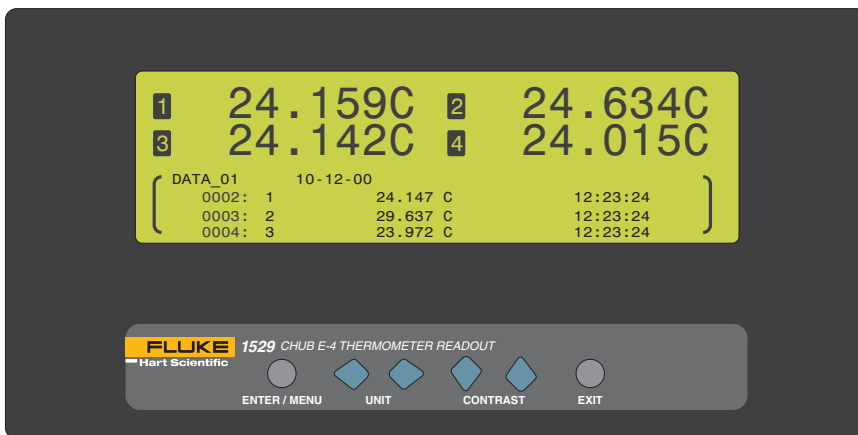

Figure 36 Auto Log View Data

Each time the view data function is accessed the current auto log memory is displayed. The data is updated each time the function is accessed; it is not updated continuously during a log session.

The entries are grouped by the label specified and displayed in the order that they were logged. For each log session, an entry is written into the log, which includes the label for all readings in that session and the date of the session.

Subsequent entries in the log consist of the reading number, channel, measurement value, units, and the time of each entry.

Press the ◀▶ buttons to jump 100 readings at a time. Hold the ▲▼ buttons down to advance quickly through the data. Press and hold the ◀ button to view the top reading, and the ▶ button to view the bottom reading. Press the **Enter** or **Exit** button to return to the AUTO LOG menu.

7.4.2.4 Print Data

The PRINT DATA function prints the auto log data for the selected label or for all labels. The auto log data is printed to the serial port. When this function is selected, the bottom portion of the display allows you to select the label of the auto log data or all data and the port. Select ALL DATA to print all auto log entries, or select a specific label to print only the auto log data for that label.

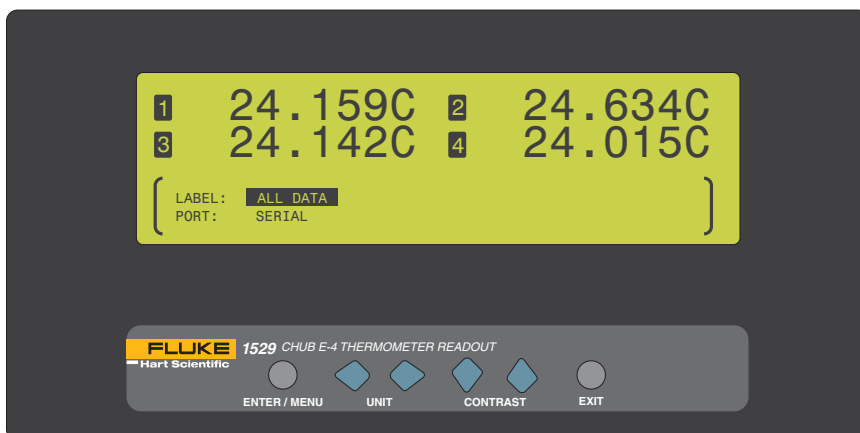

Figure 37 Print Data

Use the ◀▶ buttons to select the parameter settings. Use the ▲▼ buttons to scroll between parameters. Press the **Enter** button to continue. A message is displayed stating the label of the data to print and the port. Press the **Enter** button to print the data. Press the **EXIT** button to cancel and to exit to the menu.

7.4.2.5 Delete Data

The DELETE DATA function deletes the auto log data for the selected label or for all labels. When this function is selected, the bottom portion of the display allows the user to select the label of the auto log session to delete or all data.

Select ALL DATA to delete all auto log readings or select a specific label to delete only the auto log entries for that label.

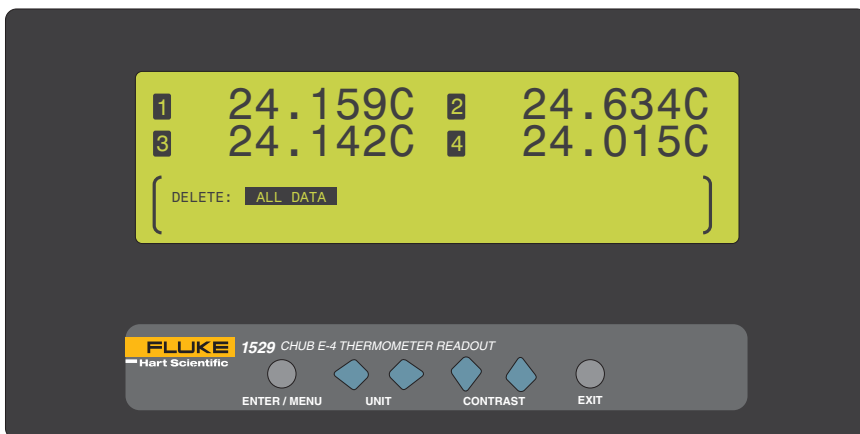



Figure 38 Delete Data

Use the   buttons to select the label of the data you want to delete. Press the **Enter** button to continue and to delete the data. Press the **Exit** button to cancel and to return to the AUTO LOG menu.

7.4.3 Log Stats

The LOG STATS function displays the number of measurements logged, the percentage of memory used, and the number of measurements to be logged for

both the demand and auto logs. When this function is selected, the bottom portion of the display shows the logging statistics.

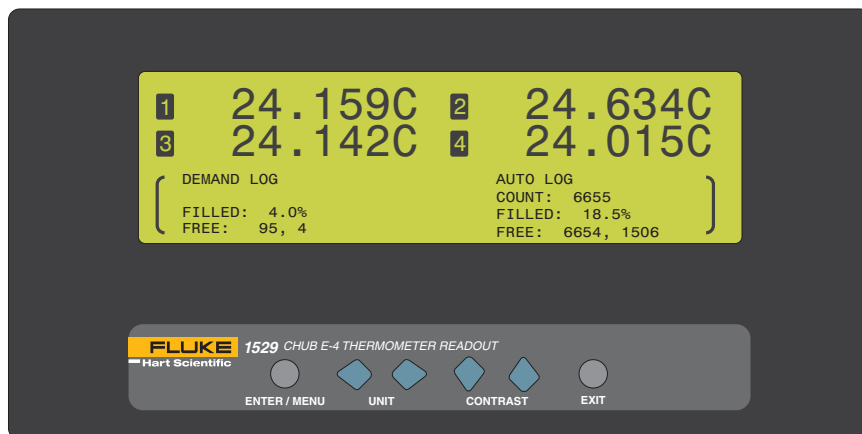

Figure 39 Log Stats

The left side displays demand log statistics and the right side displays the auto log statistics. The FILLED parameter shows the percentage of the total demand or auto log memory that is currently filled. The FREE parameter shows the number of readings remaining before the memory is full and the number of readings currently stored in the demand or auto log memory. The COUNT parameter is only displayed when an auto log session is running. This parameter shows the number of auto log readings remaining during the current log session.

Press the **Enter** or **Exit** button to exit this display and to return to the LOGGING menu.

7.4.4 Data Labels

The DATA LABELS function allows 25 demand log and auto log labels to be edited. When this function is selected, the bottom portion of the display allows the user to select the data label to edit. The labels contain up to 8 alphanumeric

digits. These labels are used to identify logged data when using the demand and auto log functions.

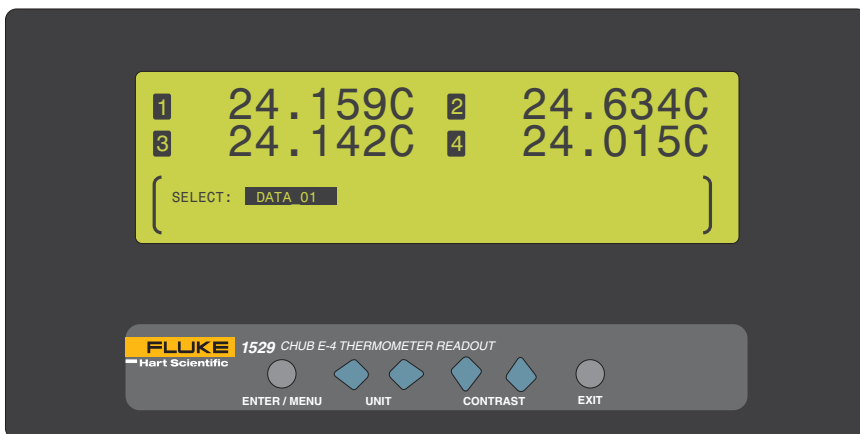

Figure 40 Data Labels

Press the ◀▶ buttons to select the label to edit. By default the labels are set to DATA_01, DATA_02, ... at the factory. Press the **Enter** button to begin editing the label. The word SELECT changes to EDIT, and the label can now be edited. Press the ◀▶ buttons to highlight the character you want to change. Use the ▲▼ buttons to scroll through the letters A-Z, numbers 0-9, and underscore (_). The blank space causes all characters to the right to be deleted when the **Enter** button is pressed.

Press the **Enter** button to store the new label or press the **Exit** button to cancel and to return to the menu.

7.4.5 Default Labels

The DEFAULT LABELS function resets the data labels to their default settings. By default the labels are set to DATA_01, DATA_02, ... at the factory. When

this function is selected, the bottom portion of the display instructs the user to press the **Enter** button to reset the data labels to their default settings.

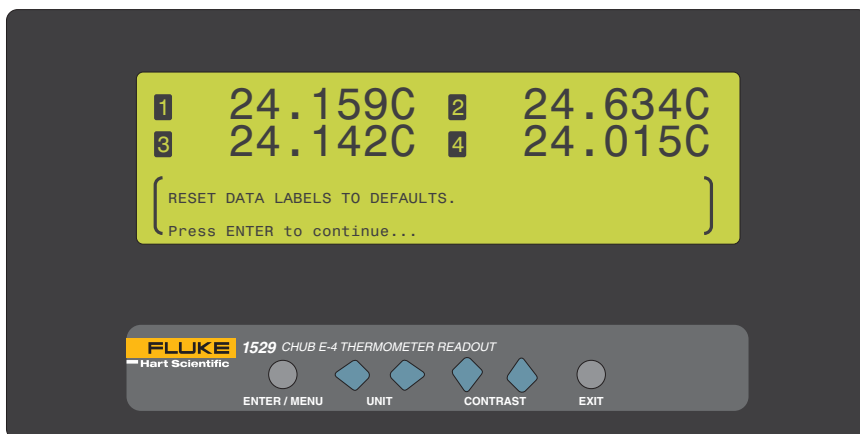

Figure 41 Default Labels

To exit without resetting the labels, press the **Exit** button.

7.5 System Menu

The SYSTEM menu provides functions for the communication ports, the date and time format, the password, the calibration, and system reset. When entering the SYSTEM menu, the instrument's model number, manufacturer, firmware version, and serial number are displayed above the menu. The functions that

appear in this menu are COMM SETUP, DATE TIME, PASSWORD, CALIBRATION, and SYSTEM RESET.

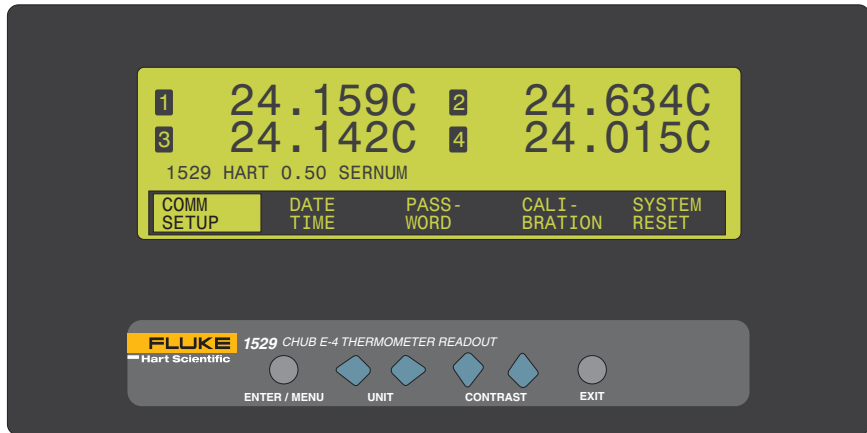

Figure 42 System Menu

7.5.1 Comm Setup

The COMM SETUP function is used to setup the communication parameters for the installed ports. Communications ports are used for communicating with a computer, printer, or other equipment. When this function is selected, the bottom portion of the display prompts the user to select the communication port to setup. The 1529 thermometer readout is shipped standard with one serial (RS-232) port. A GPIB port may optionally be installed. The GPIB port selection only appears if it is installed. ERRORS may also be selected for the port. This port selection allows the user to view any error messages stored in the er-

ror queue on the display. Once an error has been viewed, it is removed from the error queue.

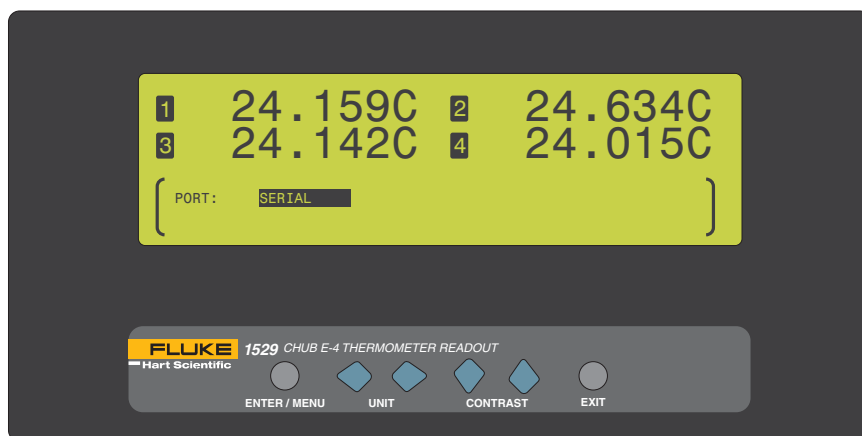



Figure 43 Comm Setup

Press the   buttons to select the port to setup. Press the **Enter** button to display the port parameters.

7.5.1.1 Serial

When the SERIAL option is selected, the parameters for the serial port are displayed on the bottom portion of the display. These parameters are: BAUD, SER PER, LF, PRINT, and ECHO.





The BAUD parameter allows the user to select the baud rate for communications on this port. The user may choose between 1200, 2400, 4800, 9600, and 19200. The default baud rate is 9600.

The SER PER parameter allows the user to select the interval at which measurements are transmitted over the serial port. The user may choose between 0.1, 0.2, 0.5, 1, 2, 5, 10, and 30 seconds, 1, 2, 5, 10, and 30 minutes, and 1 hour.

The LF parameter allows the user to specify whether a linefeed character (ASCII 0A hex or 10 decimal) is appended to the end of each line transmitted over the serial port. Selecting ON sends both a carriage return (ASCII 0D hex or 13 decimal) and a linefeed. Selecting OFF sends only a carriage return.

The PRINT parameter allows the user to enable printing measurements over the serial port. Selecting ON enables printing and selecting OFF disables printing. With slower MEA PER (see Section 7.1.1) and SER PER rates of 1 second or more, measurements are printed with the channel number, measured value, unit, time, and date, all separated with spaces. With faster rates, less than 1 second, only the measured value is printed.

The ECHO parameter allows the user to set the echo (duplex) mode. Selecting ON enables echoing so that all characters received on the serial port are echoed back over the serial port. This mode is useful when using terminal emulation software on a computer to communicate with the instrument. Selecting OFF disables echoing. This mode is commonly used when using control software on the computer.

Press the   buttons to select the parameter setting. Use the   buttons to scroll between the parameters. Press the **Enter** button to save the new setting. Press and hold the **Exit** button to cancel to the main display or press the **EXIT** button to cancel and to move to the next parameter.

7.5.1.2 GPIB (Optional)

When the GPIB option is selected, the parameters for the IEEE-488 port are displayed on the bottom portion of the display. These parameters are: GPIB, ADDR, and TERM.

The GPIB parameter allows the user to enable or disable the IEEE-488 port.

The ADDR parameter allows the user to specify the address of this instrument on the IEEE-488 bus. The default address is 22 and the range is 1 to 30.

The TERM parameter allows the user to select the termination character transmitted after each transmission. The default termination character is linefeed (LF).

7.5.2 Date Time

The DATE TIME function is used for setting the time-of-day clock, time format, date, and date format. When this function is selected, the bottom portion

of the display shows the hour, minute, second, time format, day, month, year, and date format.

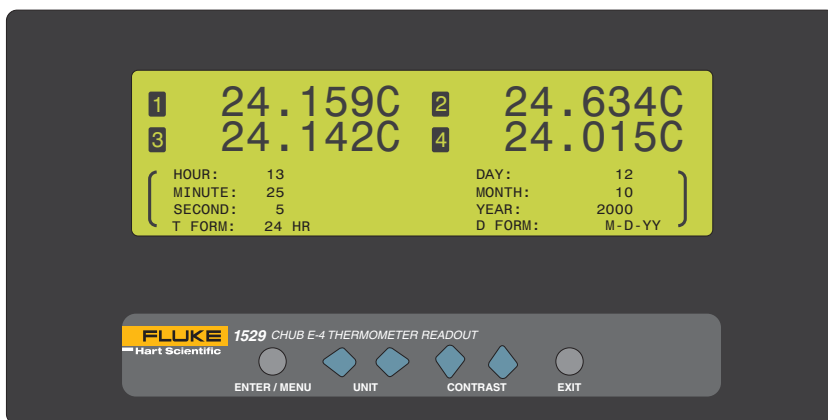

Figure 44 Date Time

The HOUR parameter allows the user to set the current hour (0 through 23).

The MINUTE parameter allows the user to set the current minutes (0 through 59).

The SECOND parameter allows the user to set the current seconds (0 through 59).

The T FORM parameter allows the user to set the time format used for displaying the time. The choices are 12-hour format or 24-hour format.

The DAY parameter allows the user to set the current day (1 through 31).

The MONTH parameter allows the user to set the current month (1 through 12).

The YEAR parameter allows the user to set the current year (1999 through 9999).

The D FORM parameter allows the user to set the date format used when displaying the date. The choices are M-D-YY, M-D-YYYY, D/M/YY, and D/M/YYYY.

Press the ◀▶ buttons to change the parameter setting. Use the ▲▼ buttons to scroll between the parameters. Press the **Enter** button to save the new setting. Press the **Exit** button to exit to the menu.

7.5.3

Password

The PASSWORD function is used for changing the password required for access to password-protected parameters and to determine whether to pass-

word-protect certain parameters. When this function is selected, the bottom portion of the display prompts the user to enter the current password to gain access to this function.

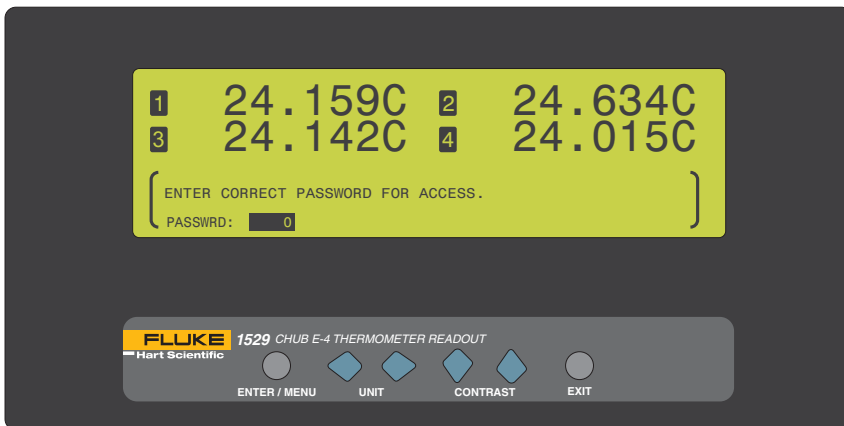

Figure 45 Password

By default the password is set to '1529' when the instrument ships from the factory. We recommend that the user change the default password to protect the password-protected settings. **Note:** Keep your password in a secure location and do not forget it.

To enter the password, press the **Enter** button. Press the ◀▶ buttons to highlight the digit you want to change. Use the ▲▼ buttons to scroll through the numbers 0-9 to set each digit of the password. Press the **Enter** button to accept the password or press the **Exit** button to cancel and to exit to the menu.

If an incorrect password is entered, the display shows the message PASSWORD INCORRECT and access to the password-protected parameters is denied. Press the **Enter** button to return to the menu. If the correct password is entered, the password-protected parameters are displayed in the bottom portion of the display. The password-protected parameters are PASSWRD and PRB SEC.

The PASSWRD parameter allows the user to change the password. Press the **Enter** button to edit the PASSWRD parameter. Press the ◀▶ buttons to highlight the digit to change. Use the ▲▼ buttons to scroll through the numbers 0-9. Press the **Enter** button to save the new setting. Press the **Exit** button to cancel and to move to the next parameter or to exit to the menu. **Note:** Keep your password in a secure location and do not forget the password.

The PRB SEC parameter allows the user to password protect the EDIT PROBE and COPY PROBE functions of the PROBE menu (see Sections 8.2.1, Edit Probe and 8.2.2, Copy Probe). If this parameter is set to ON, the user must en-

ter the correct password when entering the EDIT PROBE and COPY PROBE functions. If this parameter is set to OFF, a password is not required when entering these functions. Press the ◀▶ buttons to change the parameter setting. Press the **Enter** button to save the new setting. Press the **Exit** button to cancel and to exit to the menu.

7.5.4 Calibration

The CALIBRATION function is used for accessing parameters and functions related to the 1529 calibration. It first displays the date the current calibration is due and the date the instrument should be recalibrated. Typically, all channels should have the same due date. However, in the case that all channels do not have the same due date the earliest date is displayed. This function is password-protected (see Section 7.5.3). In order to access the parameters within this function you must enter the correct four-digit password. When this function is selected, the bottom portion of the display prompts the user to enter the current password to gain access to this option.

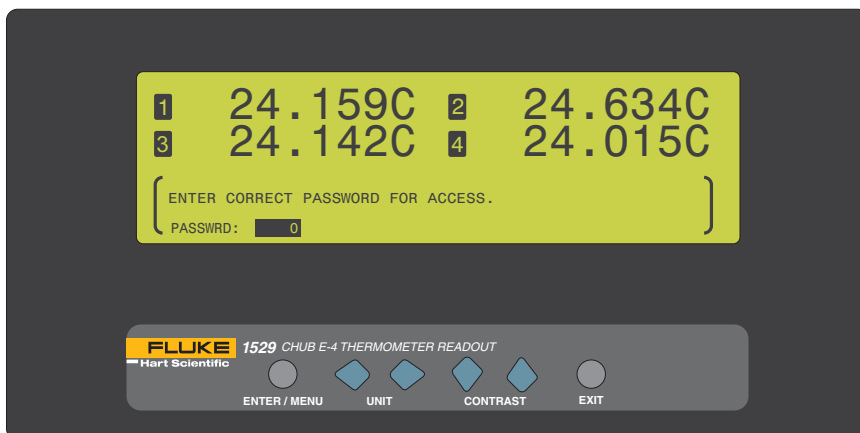

Figure 46 Password for Calibration Access

By default the password is set to '1529' when the instrument ships from the factory. We recommend that the user change the default password to protect the password-protected settings. **Note:** Keep your password in a secure location and do not forget it.

To enter the password, press the **Enter** button. Press the ◀▶ buttons to highlight the digit to change. Use the ▲▼ buttons to scroll through the numbers 0-9. Press the **Enter** button to save the new setting. Press the **Exit** button to cancel and to exit to the menu.

If an incorrect password is entered, the display shows the message PASSWORD INCORRECT and access to the password-protected parameters is denied. Press the **Enter** button to return to the menu. If the correct password is

entered, the bottom portion of the display allows the user to select the channel to view.

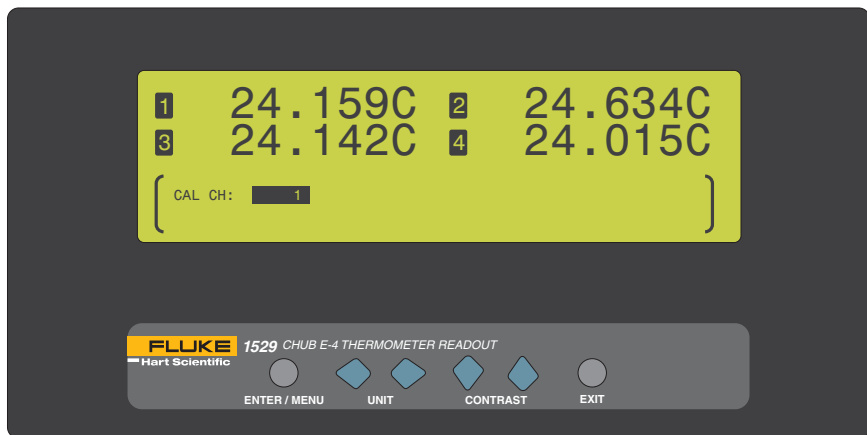

Figure 47 Select Calibration Channel

Each channel of the 1529 is calibrated independently and therefore each channel has its own set of calibration parameters which are displayed after the CAL CH parameter is entered.

Use the **◀▶** buttons to select the channel. Press the **Enter** button to view the calibration parameters for the selected channel. Press the **Exit** button to cancel and to exit to the menu.

For PRT/thermistor channels, the parameters C0, C100, C400, C0K, C10K, C100K, DATE, and DUE are displayed.

The C0, C100, and C400 parameters apply to the PRT probe types and 100Ω resistance range. Use these parameters to adjust the measurement at 0, 100 and 400Ω respectively. These values are in ohms.

The C0K, C10K, and C100K parameters apply to the thermistor probe types and 10KΩ resistance range. Use these parameters to adjust the measurement at 0K, 10K, and 100KΩ respectively. These values are in Kohms.

The DATE parameter is the date the current calibration was performed.

The DUE parameter is the date the current calibration expires.

For thermocouple channels, the parameters C0, C100, CRJ, DATE, and DUE are displayed.

The C0 and C100 parameters adjust the measurement at 0 and 100 mV respectively. These values are in mV.

The CRJ parameter adjusts the reference junction temperature measurement. This parameter is in °C.

The DATE parameter is the date the current calibration was performed.

The DUE parameter is the date the current calibration expires.

Press the ◀▶ buttons to change a setting and the ▲▼ buttons to scroll between parameters. Press the **Enter** button to save the new setting. Press the **Exit** button to exit to the menu.

7.5.5 System Reset

The SYSTEM RESET function resets all operating parameters to the factory default values. This function is password-protected (see Section 7.5.3, Password). In order to access the system reset, you must enter the correct four-digit password. When this function is selected, the bottom portion of the display prompts the user to enter the current password to gain access to this option.

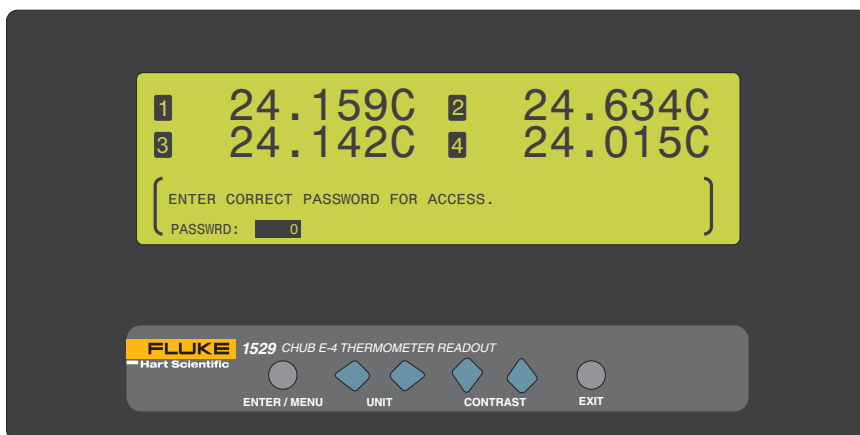

Figure 48 Pass Cal Reset

By default the password is set to '1529' when the instrument ships from the factory. We recommend that the user change the default password to protect the password-protected settings. **Note:** Keep your password in a secure location and do not forget it.

To enter the password, press the **Enter** button. Press the ◀▶ buttons to highlight the digit to change. Use the ▲▼ buttons to scroll through the numbers 0-9. Press the **Enter** button to save the new setting. Press the **Exit** button to cancel and to exit to the menu.

If an incorrect password is entered the display shows the message PASSWORD INCORRECT and access to the password-protected parameters is denied. Press the **Enter** button to return to the menu. If the correct password is entered, the bottom portion of the display instructs the user to press **Enter** to reset the settings to the defaults.

The system reset does the following:

- Sets the measure period to 1 second.
- Sets channel 1 ON, all others OFF.
- Sets the channel mode to SCAN.
- Sets moving average to 1.
- Sets printing to all ports OFF.
- Stops auto logging.
- Clears the statistical functions.
- Sets units to C.
- Sets the resolution to AUTO.

Reset does not affect any of the probe characterization parameters, logged data or channel calibration parameters.

8 Digital Communications Interface

8.1 Overview

The communication feature allows an external device, such as a computer, to communicate with the 1529 to obtain measurement data and control operating conditions. Communication is accomplished by issuing commands to the 1529 through RS-232 or IEEE-488 communication ports.

8.2 Communications

The thermometer readout is equipped with an RS-232 serial interface, and optionally a GPIB port. The serial interface allows communications up to distances of approximately 50 feet. The serial interface and GPIB port allow the user to access the functions, parameters, and settings discussed in Section 7, Menu Functions.

8.2.1 Serial Wiring

The serial communications cable attaches to the thermometer readout through the DB-9 connector at the back of the instrument. Figure 49 shows the pin-out of this connector and suggested cable wiring. This type of cable is typically referred to as a “null modem” cable. To eliminate noise, the serial cable should be shielded with low resistance between the connector (DB9) and the shield.

The serial period, baud rate, linefeed, and echo are programmable. Refer to Section 7.5.1.1, Serial Port, for instructions on accessing and setting these parameters.

All commands sent to the 1529 through the serial in-

RS-232 Cable Wiring for IBM PC and Compatibles

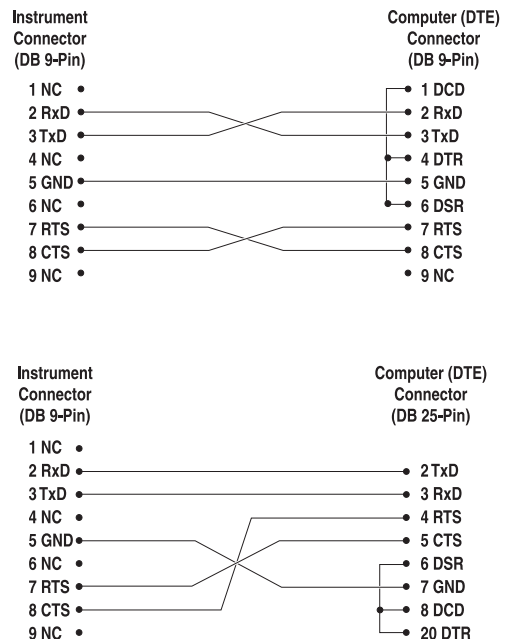

Figure 49 Serial Cable Wiring

terface must be terminated with a carriage return or linefeed character.

8.2.2 GPIB Communications

The GPIB interface allows the Model 1529 to be connected to an IEEE-488 bus along with other instruments. A system controller can remotely control the operation of the Model 1529 and read measurements.

8.2.2.1 Capability

The Model 1529 GPIB interface conforms to standard IEEE-488.2, 1992. Its capabilities are identified as SH1, AH1, T6, L4, SR1, DC1, and E2. The interface has the capabilities of talk, listen, serial poll, and device clear. There is no capability for talk-only, listen-only, extended talk or listen, parallel poll, remote-local control, or trigger nor can it act as a controller. The IEEE-488 commands GET, GTL, LLO, and REN are accepted without error but ignored.

8.2.2.2 Connection

The IEEE-488 port is located on the back of the 1529. Use a standard IEEE-488 cable to connect to your GPIB controller. A shielded cable should be used to prevent EM emission.

8.2.2.3 Device Setup

The Model 1529 system must be set up to respond to the controller address. Refer to Section 7.5.1.2, GPIB, for setting address and other parameters for the IEEE-488 port.

8.3 Interface Commands

8.3.1 Command Summary

An alphabetical listing of the commands implemented by the 1529 are shown in Table 3 starting on page 79. These commands can be used with either serial or IEEE-488 communications ports.

Table 3 Alphabetical List of Commands

Command	Description	Refer To
*CLS	Clears the status registers	Section 8.4.12
*ESE?	Returns the Event Status Enable Register	Section 8.4.12
*ESE <num>IMINIMAXIDEF	Sets the Event Status Enable Register	Section 8.4.12
*ESR?	Returns the Event Status Register	Section 8.4.12
*IDN?	Returns the instrument identification string that indicates the manufacturer, model number, serial number, and firm-ware version	Section 8.4.8
*OPT?	Returns a list of installed input card types	Section 8.4.8
*RST	Sets the instrument operating parameters to defined conditions	Section 8.4.8
*SRE?	Returns the Service Request Enable Register	Section 8.4.12
*SRE <num>IMINIMAXIDEF	Sets the Service Request Enable Register	Section 8.4.12
*STB?	Returns the Status Byte Register	Section 8.4.12
*TST?	Performs a self-test and reports any errors that are found	Section 8.4.12
CALCulate:AVERAge:CLEAr	Clears the statistical functions for all channels	Section 8.4.1
CALCulate<chn>:AVERAge<n>:DATA?	Returns the value of a statistical calculation for the specified channel	Section 8.4.1
CALCulate:AVERAge<n>:TYPE?	Returns the keyword for the specified calculation type number	Section 8.4.1
CALCulate<chn>:CONVert:CATAlog?	Returns a list of conversion types available for the specified channel	Section 8.4.4
CALCulate<chn>:CONVert:COpy<dest chn> ALL	Copies the conversion type, sub-ranges (ITS-90), serial number, and characterization coefficients from one channel to another	Section 8.4.4
CALCulate<chn>:CONVert:NAME?	Returns the name of the selected conversion type for the specified channel	Section 8.4.4
CALCulate<chn>:CONVert:NAME <conv>	Sets the conversion type by name for the specified channel	Section 8.4.4
CALCulate<chn>:CONVert:PARAmeter:CATAlog?	Returns the names of the probe characterization parameters used with the selected conversion type for the specified channel	Section 8.4.4
CALCulate<chn>:CONVert:PARAmeter:VALue? [<param> ALL]	Returns the value for the specified or All conversion parameters for the specified channel	Section 8.4.4
CALCulate<chn>:CONVert:PARAmeter:VALue <param>,<num>[,< param>,<num>...]	Sets the value of one or more conversion parameters for the specified channel number	Section 8.4.4
CALCulate:CONVert:PRINt [<chn> ALL [<port>]]	Returns the conversion parameters for the specified channel	Section 8.4.4
CALCulate<chn>:CONVert:SNUMber?	Returns the probe serial number for the specified channel	Section 8.4.4
CALCulate<chn>:CONVert:SNUMber <seri>	Sets the probe serial number for the specified channel	Section 8.4.4
CALCulate<chn>:CONVert:TEST? <res> <volt>	Tests the temperature conversion for the specified channel	Section 8.4.4

1529 Chub-E4 Thermometer Readout
User's Guide

Command	Description	Refer To
CALibrate:AUTO	Executes the automatic calibration procedure when using fast measurement mode.	Section 8.4.5
CALibrate<chn>:DATE:CALibrate? [MINIMAXIDEF]	Returns the channel calibration date for the specified channel	Section 8.4.5
CALibrate<chn>:DATE:CALibrate (<year>,<month>,<day>) MINIMAXIDEF	Sets the channel calibration date for the specified channel	Section 8.4.5
CALibrate<chn>:DATE:DUE? [MINIMAXIDEF]	Returns the recalibration date for the specified channel	Section 8.4.5
CALibrate<chn>:DATE:DUE (<year>,<month>,<day>) MINIMAXIDEF	Sets the recalibration date for the specified channel	Section 8.4.5
CALibrate<chn>:PARAmeter:LINearity<n>? [MINIMAXIDEF]	Returns the calibration linearity parameter for the specified channel	Section 8.4.5
CALibrate<chn>:PARAmeter:LINearity<n> <num> MINIMAXIDEF	Sets the calibration linearity parameter for the specified channel	Section 8.4.5
CALibrate<chn>:PARAmeter:OFFSet<n>? [MINIMAXIDEF]	Returns the calibration offset parameter for the specified channel	Section 8.4.5
CALibrate<chn>:PARAmeter:OFFSet<n> <num> MINIMAXIDEF	Sets the calibration offset parameter for the specified channel	Section 8.4.5
CALibrate<chn>:PARAmeter:RJC? [MINIMAXIDEF]	Returns the calibration RJC offset for the specified channel	Section 8.4.5
CALibrate<chn>:PARAmeter:RJC <num> MINIMAXIDEF	Sets the calibration RJC offset for the specified channel	Section 8.4.5
CALibrate<chn>:PARAmeter:SCALe<n>? [MINIMAXIDEF]	Returns the calibration scale parameter for the specified channel	Section 8.4.5
CALibrate<chn>:PARAmeter:SCALe<n> <num> MINIMAXIDEF	Sets the calibration scale parameter for the specified channel	Section 8.4.5
DISPlay:DATE:FORMat? [MINIMAXIDEF]	Returns a number indicating the date format	Section 8.4.10
DISPlay:DATE:FORMat <num> MINIMAXIDEF	Sets the date format	Section 8.4.10
DISPlay:DECimal:FORMat? [MINIMAXIDEF]	Returns the decimal format	Section 8.4.6
DISPlay:DECimal:FORMat <num> MINIMAXIDEF	Sets the decimal format	Section 8.4.6
DISPlay:LAMP? [MINIMAXIDEF]	Returns the lamp brightness	Section 8.4.6
DISPlay:LAMP <bool> <num> MINIMAXIDEF	Sets the lamp brightness	Section 8.4.6
DISPlay:RESolution? [MINIMAXIDEF]	Returns the display resolution	Section 8.4.6
DISPlay:RESolution <num> AUT MINIMAXIDEF	Sets the display resolution	Section 8.4.6
DISPlay:TIME:FORMat? [MINIMAXIDEF]	Returns the time format	Section 8.4.10
DISPlay:TIME:FORMat <num> MINIMAXIDEF	Sets the time format	Section 8.4.10
DISPlay:WINDow? [MINIMAXIDEF]	Returns the display set	Section 8.4.6
DISPlay:WINDow <num> MINIMAXIDEF	Sets the display set	Section 8.4.6
DISPlay:WINDow<n>:FIELd<n>:FEED?	Returns the value of a specified field for a specified display set	Section 8.4.6
DISPlay:WINDow<n>:FIELd<n>:FEED <chn>[,<num>]	Sets the value of a specified field for a specified display set	Section 8.4.6
FETCH? [<chn>]	Returns the most recent measurement for specified channel	Section 8.4.1

Command	Description	Refer To
FORMat:STAMP?	Returns the extended measurement data format setting	Section 8.4.1
FORMat:STAMP <bool>	Enables extended measurement data format with the FETCh?, MEASure?, and READ? commands	Section 8.4.1
INITiate	Provided for compatibility but has no effect	Section 8.4.2
INITiate:CONTinuous?	Provided for compatibility but has no effect	Section 8.4.2
LOGging:AUTomatic:COUNT? [MINIMAXIDEF]	Returns the number of entries to auto log	Section 8.4.7
LOGging:AUTomatic:COUNT <num> IMINIMAXIDEF	Sets the number of entries to auto log	Section 8.4.7
LOGging:AUTomatic:DELeTe [<num> ALL]	Deletes auto log entries	Section 8.4.7
LOGging:AUTomatic:FREE?	Returns the number of log entries free and stored	Section 8.4.7
LOGging:AUTomatic:LABel? [MINIMAXIDEF]	Returns the current auto log label number	Section 8.4.7
LOGging:AUTomatic:LABel <num> IMINIMAXIDEF	Sets the current auto log label number	Section 8.4.7
LOGging:AUTomatic:POINt? [MAX]	Returns the number of auto log entries	Section 8.4.7
LOGging:AUTomatic:PRINT [<num> ALL [,port]]	Prints stored auto log data	Section 8.4.7
LOGging:AUTomatic:STATus?	Returns the auto log status	Section 8.4.7
LOGging:AUTomatic:STATus <bool>	Sets the auto log state	Section 8.4.7
LOGging:AUTomatic:TIME? [MINIMAXIDEF]	Returns the auto log interval setting	Section 8.4.7
LOGging:AUTomatic:TIME <num> IMINIMAXIDEF	Sets the auto log interval setting	Section 8.4.7
LOGging:AUTomatic:VALue? <num> IMINIMAXIDEF	Returns an auto log reading	Section 8.4.7
LOGging:DEMAND:DELeTe [<num> ALL]	Deletes demand log entries	Section 8.4.7
LOGging:DEMAND:FREE?	Returns the number of log entries free and stored	Section 8.4.7
LOGging:DEMAND:LABel? [MINIMAXIDEF]	Returns the current demand log label number	Section 8.4.7
LOGging:DEMAND:LABel <num> IMINIMAXIDEF	Sets the current demand log label number	Section 8.4.7
LOGging:DEMAND:POINt? [MAX]	Returns the number of demand log entries	Section 8.4.7
LOGging:DEMAND:PRINT [<num> ALL [,<port>]]	Prints the demand log data	Section 8.4.7
LOGging:DEMAND:STORE	Stores the current measurement into the demand log	Section 8.4.7
LOGging:DEMAND:VALue? <num> IMINIMAXIDEF	Returns a demand log entry	Section 8.4.7
LOGging:LABel<n>:NAME?	Returns the name of the specified label	Section 8.4.7
LOGging:LABel<n>:NAME <label>	Sets the name of the specified label	Section 8.4.7
MEASure? [<chn>]	Returns the most recent measurement on the specified channel	Section 8.4.1
READ? [<chn>]	Returns the most recent measurement on the specified channel	Section 8.4.1
ROUTe:CLOSe? <chn>	Returns the state of the specified channel	Section 8.4.3
ROUTe:CLOSe <chn>	Enables the specified channel	Section 8.4.3
ROUTe:OPEN? <chn>	Returns the state of the specified channel	Section 8.4.3
ROUTe:OPEN <chn>	Disables the specified channel	Section 8.4.3
ROUTe:SCAN?	Returns the list of enabled channels	Section 8.4.3
ROUTe:SCAN [<chn list>]	Sets the input channels for scanning	Section 8.4.3

Command	Description	Refer To
ROUTe:SCAN:MODE? [MINIMAXIDEF]	Returns the current scan mode	Section 8.4.3
ROUTe:SCAN:MODE <num>IMINIMAXIDEF	Sets the scan mode	Section 8.4.3
SENSe:AVERAge:COUNT? [MINIMAXIDEF]	Returns the moving average filter setting	Section 8.4.2
SENSe:AVERAge:COUNT <num> IMINIMAXIDEF	Sets the moving average filter setting	Section 8.4.1
SENSe<chn>:DATA?	Returns the input value for the specified channel	Section 8.4.1
SENSe<chn>:RESistance:RANGe? [MINIMAXIDEF]	Returns the resistance range setting for the specified channel	Section 8.4.2
SENSe,<chn>:RESistance:RANGe <num> IMINIMAXIDEF	Sets the resistance range setting for the specified channel	Section 8.4.2
SENSe<chn>:RESistance:WIRE? [MINIMAXIDEF]	Returns the probe wire setting for the specified channel	Section 8.4.2
SENSe<chn>:RESistance:WIRE <num> IMINIMAXIDEF	Sets the probe wire setting for the specified channel	Section 8.4.2
STATus:MEASure?	Reads and clears the Measurement Status Register	Section 8.4.12
STATus:MEASure:CONDition?	Returns the Measurement Status Condition Register	Section 8.4.12
STATus:MEASure:ENABle?	Returns the Measurement Status Enable Register	Section 8.4.12
STATus:MEASure:ENABle <num>	Sets the Measurement Status Enable Register	Section 8.4.12
STATus:OPERation?	Reads and clears the Operation Status Register	Section 8.4.12
STATus:OPERation:CONDition?	Returns the Operation Status Condition Register	Section 8.4.12
STATus:OPERation:ENABle? [MINIMAXIDEF]	Returns the Operation Status Enable Register	Section 8.4.12
STATus:OPERation:ENABle <num> IMINIMAXIDEF	Sets the Operation Status Enable Register	Section 8.4.12
STATus:QUESTionable?	Reads and clears the Questionable Status Register	Section 8.4.12
STATus:QUESTionable:CONDition?	Returns the Questionable Status Condition Register	Section 8.4.12
STATus:QUESTionable:ENABle? [MINIMAXIDEF]	Returns the Questionable Status Enable Register	Section 8.4.12
STATus:QUESTionable:ENABle <num> IMINIMAXIDEF	Sets the Questionable Status Enable Register	Section 8.4.12
SYSTem:BOOT:VERSion?	Returns the boot ROM version	Section 8.4.8
SYSTem:CODE:VERSion?	Returns the firmware code version	Section 8.4.8
SYSTem:COMMunicate:SERial:BAUD? [MINIMAXIDEF]	Returns the serial port baud rate setting	Section 8.4.9
SYSTem:COMMunicate:SERial:BAUD <baud>IMINIMAXIDEF	Sets the serial port baud rate setting	Section 8.4.9
SYSTem:COMMunicate:SERial:FDUPlex? [MINIMAXIDEF]	Returns the serial port echo (duplex) setting	Section 8.4.9
SYSTem:COMMunicate:SERial:FDUPlex <bool>IMINIMAXIDEF	Sets the serial port echo (duplex) setting	Section 8.4.9
SYSTem:COMMunicate:SERial:FEED? [MINIMAXIDEF]	Returns the state of the serial port printing setting	Section 8.4.9
SYSTem:COMMunicate:SERial:FEED <bool>IMINIMAXIDEF	Sets the state of the serial port printing setting	Section 8.4.9
SYSTem:COMMunicate:SERial:LINEfeed? [MINIMAXIDEF]	Returns the state of the serial port linefeed setting	Section 8.4.9
SYSTem:COMMunicate:SERial:LINEfeed <bool>IMINIMAXIDEF	Sets the state of the serial port linefeed setting	Section 8.4.9
SYSTem:COMMunicate:SERial:TIME? [MINIMAXIDEF]	Returns the serial port sample period setting	Section 8.4.9
SYSTem:COMMunicate:SERial:TIME <num> IMINIMAXIDEF	Sets the serial port sample period setting	Section 8.4.9

Command	Description	Refer To
SYSTem:DATE? [MINIMAXIDEF]	Returns the date	Section 8.4.10
SYSTem:DATE (<year>,<month>,<day>)	Sets the date to the specified year, month, and day	Section 8.4.10
SYSTem:ERRor?	Returns a system error message from the system error queue	Section 8.4.8
SYSTem:KLOCKout? [MINIMAXIDEF]	Returns the state of the keypad lockout	Section 8.4.9
SYSTem:KLOCKout <bool>IMINIMAXIDEF	Enables or disables the keypad	Section 8.4.9
SYSTem:PASSword:CDISable	Disables password-protected commands	Section 8.4.11
SYSTem:PASSword:CENable <pass>	Enables password-protected commands	Section 8.4.11
SYSTem:PASSword:CENable:STATe?	Returns the current password-protection state	Section 8.4.11
SYSTem:PASSword:CONVersion? [MINIMAXIDEF]	Returns the current password-protected state of the conversion commands	Section 8.4.11
SYSTem:PASSword:CONVersion <bool> IMINIMAXIDEF	Sets the password-protection state of the conversion commands	Section 8.4.11
SYSTem:PASSword:NEW <pass>	Sets a new password	Section 8.4.11
SYSTem:POWer:BATTery?	Returns the current battery charge level	Section 8.4.9
SYSTem:POWer:SOURce?	Returns the source of power being used	Section 8.4.9
SYSTem:SNUMber?	Returns the instrument serial number	Section 8.4.8
SYSTem:TIME?	Returns the time	Section 8.4.10
SYSTem:TIME (<hour>,<minute>,<second>)	Sets the time to the specified hour, minute, second	Section 8.4.10
SYSTem:VERSion?	Returns the SCPI version number	Section 8.4.8
TRIGger:TIMer? [MINIMAXIDEF]	Returns the value of the scan sequence timer setting	Section 8.4.2
TRIGger:TIMer <num>IMINIMAXIDEF	Sets the scan sequence timer setting	Section 8.4.2
UNIT:TEMPerature?	Returns the system temperature units	Section 8.4.8
UNIT:TEMPerature <unit>	Sets the system temperature units	Section 8.4.8

8.3.2 Command Syntax

The 1529 accepts commands that set parameters, execute functions or respond with requested data. These commands are in the form of strings of ASCII-encoded characters. As far as possible, the 1529 conforms to IEEE-488.2, 1992 and SCPI-1994. One notable exception is that compound commands are not allowed as explained below.

Commands consist of a command header and, if necessary, parameter data. All commands must be terminated with either a carriage return (ASCII 0D hex or 13 decimal) or new line character (ASCII 0A hex or 10 decimal).

Command headers consist of one or more mnemonics separated by colons (:). Mnemonics may use letter characters, the underscore character (_), and possibly numeric digits as well. Commands are not case sensitive. Mnemonics often have alternate forms. Most mnemonics have a long form that is more readable and a short form consisting of three or four characters that is more efficient.

A mnemonic may end with a numeric suffix that specifies one of a set of independent function blocks such as input channel data paths. If a numeric suffix is omitted when a particular block must be specified, an error is generated (“Header suffix out of range”).

Query commands are commands that request data in response. Query commands have a question mark (?) immediately following the command header. Responses to query commands are generated immediately and placed in the output buffer. Responses are then transmitted automatically over the RS-232 port. When using the IEEE-488 interface, responses remain in the output buffer until read or until another command is received or the power is turned off. Responses are lost if not read before the next command is received. Each input buffer holds 128 characters and each output buffer holds 256 characters.

Some commands require parameter data to specify values for one or more parameters. The command header is separated from the parameter data by a space (ASCII 20 hex or 32 decimal). Multiple parameters are separated by a comma (,).

The 1529 does not allow compound commands (multiple commands per line separated with semicolons). All commands are sequential. The execution of each command is completed before subsequent commands are processed.

8.4 **Commands**

Table 3, Alphabetical List of Commands in Section 8.3.1, lists the commands in alphabetical order. In this section the commands are arranged into the following groups:

Measurement Commands – commands for reading measurement data.

Measurement Control Commands – commands for the timing and action of the measurement process.

Channel Commands – commands for selecting channels.

Probe Commands – commands for temperature conversion and probe characterization.

Calibration Coefficient Commands – commands for channel calibration coefficients.

Display Commands – commands for display options and settings.

Logging Commands – commands for automatic and demand logging.

System Commands – commands for general system configuration parameters.

Communication Interface Commands – commands for controlling the interface configuration(serial port and IEEE).

Date and Time Commands – commands for setting the date, time and the date and time formats.

Password Commands – commands for enabling and disabling the password, for setting the password, and for checking the state of the password.

Status Commands – commands to report the status and condition of the instrument.

Each section provides the command structure (long and short format), a description of the command purpose, a command example, an example of what the command returns (as applicable to query commands), and notes specific to the command. The following apply to each group of commands.

- Numeric data, specified by the mnemonic, <num>, uses ASCII characters to represent numbers. Numbers may contain a plus or minus ('+' or '-') sign, decimal point ('.'), and exponent ('E' or 'e') with its sign. If a fractional component is received when only an integer is required, the number is rounded to the nearest integer without any resulting error message. The mnemonics DEF, MIN, and MAX are often acceptable for the default, minimum, and maximum value respectively. Unit suffixes, such as V or OHM, can be appended to numeric parameters and are accepted without error but ignored.
- Unrecognized commands or commands with incorrect syntax or invalid parameters generate error messages in the error queue.
- Upper case letters designate syntax that is required when issuing the command. Lower case letters are optional and may be omitted.
- <> indicates a required parameter.
- [] indicates optional parameters.
- () indicates a group of parameters that must be used together.
- For query commands, specifying the MIN, MAX, or DEF parameter causes the instrument to respond with the minimum, maximum, or default setting respectively.
- For set commands, specifying the MIN, MAX, or DEF parameters causes the instrument to use the minimum, maximum, or default setting respectively.
- 'l' indicates alternate parameter values.
- <chn> indicates a channel number is required.
- <dest chn> indicates a destination channel is required.
- <n> indicates a number is required.
- <num> indicates numeric value is required.
- <chn list> indicates a list of channel numbers is required.
- <bool> indicates a Boolean value (0 or 1) is required. The mnemonics OFF and ON are also accepted for 0 and 1, respectively.
- <conv> indicates a conversion mnemonic is required.
- <param> indicates a parameter name is required.

- <seri> indicates a serial number is required.
- <res> indicates a resistance value is required.
- <volt> indicates a voltage value is required.
- <unit> indicates a temperature unit is required.
- <pass> indicates a password is required.
- <port> indicates a port number is required.
- <label> indicates an eight character label is required.
- <year> indicates a four digit number is required.
- <month> indicates a one or two digit number is required.
- <day> indicates a one or two digit number is required.
- <hour> indicates a one or two digit number is required.
- <minute> indicates a one or two digit number is required.
- <second> indicates a one or two digit number is required.
- <baud> indicates a valid baud number is required.

8.4.1 Measurement Commands

The measurement commands are used to read information on the statistical calculations and for reading the most recent measurement for a specified channel. The measurement commands are **not** password protected.

8.4.1.1 CALCulate:AVERage:CLEar

Clears the statistical functions for all channels.

CALC:AVER:CLE

The *RST command clears the statistical functions.

8.4.1.2 CALCulate<chn>:AVERage<n>:DATA?

Returns the value of a statistical calculation for a given channel.

CALC3:AVER1:DATA?

0.017

The CALCulate suffix, <chn>, specifies the channel (1 to 4). The AVERage suffix, <n>, specifies the calculation type. See Table 4 on page 122 for the Statistical Calculation Types.

8.4.1.3 CALCulate:AVERage<n>:TYPE?

Returns the keyword for the specified field type number.

CALC:AVER2:TYPE

STD

The AVERAge suffix, <n>, specifies the calculation type number. See Table 4 on page 122 for the Statistical Calculation Types.

8.4.1.4 FETCh? [<chn>]

Returns the most recent measurement for the specified channel.

FETC? 1

0.0000011

or

1,2,0.0011,mV,14,5,35,2000,9,5

The <chn> parameter specifies the channel (1 to 4). If the <chn> parameter is omitted, the most recent measurement is returned regardless of the channel. If simultaneous sampling is on, the measurement from the lowest enabled channel number is returned. This command does not affect the measurement action.

If the extended format setting is OFF (see Section 9.4.1.5, FORMat:STAMp <bool>) the response is only the measurement value in units of temperature, volts, or ohms depending on the selected probe type or temperature unit. With this format kohms and millivolts are converted to ohms and volts respectively.

If the extended format setting is ON the measurement is returned in a comma-delimited format as follows.

Measure status (0 if the measurement has been read previously or 1 if this is a new measurement,

channel number,

measurement value,

scale,

hour,

minute,

seconds,

year,

month,

day the measurement was made

With this format kohms and millivolts are not converted to ohms and volts.

This command may return the same reading if a new reading has not yet been obtained. If only new readings are desired, the FORMat:STAMp command can be used to enable the extended format option and any readings in which the value of the first field is 0 can be ignored or else the STATus:MEASure? command can be used to determine if a new reading is available for a desired channel.

8.4.1.5 FORMat:STAMp?

Returns the extended measurement data format setting. See Section 9.4.1.4, FETCh? for details.

FORM:STAM?

0

8.4.1.6 FORMat:STAMp <bool>

Enables extended measurement data format with the FETCh?, MEASure? And READ? commands. On power up this is always set to off.

FORM:STAM ON

8.4.1.7 MEASure? [<chn>]

Returns the most recent measurement for the specified channel.

MEAS? 1

0.0127

This command is the same as the FETCh? [<chn>] command

8.4.1.8 READ? [<chn>]

Returns the most recent measurement for the specified channel.

READ? 2

0.0113

This command is the same as the ?FETCh [<chn>] command.

8.4.1.9 SENSE<chn>:DATA?

Returns the input value for the specified channel.

SENS3:DATA?

100.0291, 0.0000

The SENSE suffix, <chn>, specifies the channel (1 to 4). The parameter is ohms for low range PRTs, Kohms for high range PRTs and thermistors, and millivolts for thermocouples. The second returned parameter is always 0 for PRTs and themistors and the reference junction temperature for thermocouples.

8.4.2 Measurement Control Commands

The measurement control commands are used to query and set the moving average filter, the resistance range, the number of probe wires, and the sequence timer. The measurement control commands for resistance range and the number of probe wires are password protected.

8.4.2.1 **INITiate**

Provided for compatibility but has no effect.

INIT

8.4.2.2 **INITiate:CONTinuous?**

Provided for compatibility but has no effect.

INIT:CONT?

1

8.4.2.3 **SENSe:AVERage:COUNT? [MINIMAXIDeF]**

Returns the moving average filter setting.

SENS:AVER:COUN?

4

Specifying the MIN parameter returns a value of 1, specifying the MAX parameter returns a value of 10, and specifying the DEF parameter returns a value of 1. The *RST command sets the average count to the default (1).

8.4.2.4 **SENSe:AVERage:COUNT <num>IMINIMAXIDeF**

Sets the moving average filter setting.

SENS:AVER:COUN MIN

The <num> parameter must be a number between 1 and 10. Specifying the MIN, MAX, or DEF parameter sets the moving average filter setting to the minimum, maximum, or default, respectively. The *RST command sets the moving average to 1.

8.4.2.5 **SENSe<chn>:RESistance:RANGe? [MINIMAXIDeF]**

Returns the resistance range setting.

SENS3:RES:RANG?

0

This command only applies to PRT/Thermistor channels. Executing this command on Thermocouple channels generates a -294, "Incompatible type", error message.

The SENSE suffix, <chn>, specifies the channel (1 to 4), or memory channel (5 to 14). Specifying the MIN parameter returns a value of 0. Specifying the MAX parameter returns a value of 1. Specifying the DEF parameter returns a value of 0. The *RST command sets the resistance range to the default (DEF).

8.4.2.6 **SENSe<chn>:RESistance:RANGe <num>IMINIMAXIDeF**

Sets the resistance range setting.

SENS4:RES:RANG MIN

This command only applies to PRT/Thermistor channels. Executing this command on Thermocouple channels generates a -294, "Incompatible type", error message.

The SENSE suffix, <chn>, specifies the channel (1 to 4), or memory channel (5 to 14). The <num> parameter must be a number between 0 and 1. Specifying the MIN, MAX or DEF parameter sets the resistance range setting to the minimum, maximum, or default value respectively.

This command may be password-protected. To access this command:

- If the SYST:PASS:CONV? command returns a 0 (probe password-protection is disabled), the password is not required.
- If the SYST:PASS:CONV? command returns a 1 (probe password-protection is enabled), the password must be successfully entered using the SYST:PASS:CEN <pass> command (see Section 9.4.11, Password Commands).

8.4.2.7 **SENSe<chn>:RESistance:WIRE? [MINIMAXIDeF]**

Returns the probe wire setting.

SENS1:RES:WIRE?

3

This command only applies to PRT/Thermistor channels. Executing this command on Thermocouple channels generates a -294, "Incompatible type", error message.

The SENSE suffix, <chn>, specifies the channel (1 to 4), or memory channel (5 to 14). Specifying the MIN parameter returns a value of 2. Specifying the MAX parameter returns a value of 4. Specifying the DEF parameter returns a value of 4.

8.4.2.8 **SENSe<chn>:RESistance:WIRE <num>IMINIMAXIDeF**

Sets the probe wire setting.

SENS2:RES:WIRE MIN

This command only applies to PRT/Thermistor channels. Executing this command on Thermocouple channels generates a -294, "Incompatible type", error message.

The SENSE suffix, <chn>, specifies the channel (1 to 4), or memory channel (5 to 14). The <num> parameter must either be 2, 3, or 4. Specifying the MIN, MAX or DEF parameter sets the wire setting to the minimum, maximum, or default value respectively.

This command may be password-protected. To access this command:

- If the SYST:PASS:CONV? command returns a 0 (probe password-protection is disabled), the password is not required.
- If the SYST:PASS:CONV? command returns a 1 (probe password-protection is enabled), the password must be successfully entered using the SYST:PASS:CEN <pass> command (see Section 9.4.11, Password Commands).

8.4.2.9 TRIGger:TIMer? [MINIMAXIDEF]

Returns the scan sequence timer setting.

TRIG:TIM?

4

Specifying the MIN parameter returns a value of 0.1. Specifying the MAX parameter returns a value of 3600. Specifying the DEF parameter returns a value of 1. The units are seconds.

8.4.2.10 TRIGger:TIMer <num>|MINIMAXIDEF

Sets the scan sequence timer setting.

TRIG:TIM 30

The <num> parameter can be one of the following values: 0.1, 0.2, 0.5, 1, 2, 5, 10, 30, 60, 120, 300, 600, 1800 or 3600. The units are seconds. If a value other than one listed here is used, the instrument automatically selects the nearest acceptable value that is less than the value entered. Values greater than 3600 or less than 0.1 are ignored. Specifying the MIN, MAX, or DEF parameter sets the scan sequence timer to the minimum, maximum, or default value respectively. The *RST command sets the scan sequence timer to 1 second.

8.4.3 Channel Commands

The channel commands are used for querying and setting the current channel, the channels to scan, the type of scanning, and the state of the channel scanning. The channel commands are not password protected.

8.4.3.1 ROUTe:CLOSe? <chn>

Returns the state of the specified channel.

ROUT:CLOS? 1

0

The <chn> parameter specifies the channel (1 to 4). If the specified channel is enabled, this query returns 1. If the specified channel is disabled, this query returns 0.

8.4.3.2 ROUTe:CLOSe <chn>

Enables the specified channel.

ROUT:CLOS 3

The <chn> parameter specifies the channel (1 to 4) to enable. This comand does not apply to memory channels.

8.4.3.3 ROUTe:OPEN? <chn>

Returns the state of the specified channel.

Example: ROUT:OPEN? 1

Response: 0

The <chn> parameter specifies the channel (1 to 4). If the specified channel is enabled this query returns 0. If the specified channel is disabled, this query returns 1.

8.4.3.4 ROUTe:OPEN <chn>

Disables the specified channel.

Example: ROUT:OPEN 4

The <chn> parameter specifies the channel (1 to 4) to disable. This command does not apply to memory channels.

8.4.3.5 ROUTe:SCAN?

Returns a comma delimited list of the enabled channels.

ROUT:SCAN?

(@2,3,4)

The list of channels is enclosed in parenthesis and preceded with the @ symbol.

8.4.3.6 ROUTe:SCAN <chn list>

Sets the channels for scanning.

ROUT:SCAN 2,3

The <chn list> parameter is a comma delimited list of the channels (1 to 4) to enable. Channels that are omitted from this list are disabled. If the <chn list> parameter is omitted, all channels are disabled. The *RST command sets channel 1 ON, and all other channels OFF.

8.4.3.7 ROUTe:SCAN:MODE? [MINIMAXIDEF]

Returns the current scan mode setting.

ROUT:SCAN:MODE? MIN

0

If 0 is returned, the scan mode is simultaneous. If a 1 is returned the scan mode is scan. Specifying the MIN parameter returns a value of 0. Specifying the MAX parameter returns a value of 1. Specifying the DEF parameter returns a value of 1.

8.4.3.8 ROUTe:SCAN:MODE <num>|MIN|MAX|DEF

Sets the scan mode setting.

ROUT:SCAN:MODE 1

The <num> specifies the scan mode (1 for scan, 0 for simultaneous). Specifying the MIN, MAX, or DEF parameter sets the mode to the minimum, maximum, or default, respectively. The *RST command sets scan mode to scan.

8.4.4 Probe Commands

The probe commands are used for querying, setting, and copying the probe conversion type, conversion parameters, and serial number and for testing the temperature conversion for a channel. The probe commands for copying and setting parameters are password protected.

8.4.4.1 CALCulate<chn>:CONVert:CATalog?

Returns a list of conversion types available for the specified channel.

CALC2:CONV:CAT?

“RES”, “ITS”, “ITS5”, “PT”, “CVD”, “TRES”, “TTEM”, “YSI”

The CALCulate suffix, <chn>, specifies the channel (1 to 4) or memory channel (5 to 14). Each item in the response list is enclosed in double quotes and separated from other items by a comma. See Table 7 on page 124, for the available conversion types.

8.4.4.2 CALCulate<chn>:CONVert:COPY <dest chn>|ALL

Copies the conversion type, sub-ranges (ITS-90), serial number, and characterization coefficients from one channel to another.

CALC2:CONV:COPY 8

The CALCulate suffix <chn> specifies the source channel (1 to 4). The <dest chn> parameter specifies the destination channel (1 to 4). When the copy is performed, the source channel parameters are not affected. If the destination channel type is different from the source channel type, the error -294, "Incompatible type" is generated. Specifying the ALL parameter copies the source channel parameters to all compatible channels. The example above copies the parameters from channel 2 to memory channel PMEM3.

This command may be password-protected. To access this command:

- If the SYST:PASS:CONV? command returns a 0 (probe password-protection is disabled), the password is not required.
- If the SYST:PASS:CONV? command returns a 1 (probe password-protection is enabled), the password must be successfully entered using the SYST:PASS:CEN <pass> command (see Section 9.4.11, Password Commands).

8.4.4.3 CALCulate<chn>:CONVert:NAME?

Returns the name of the selected conversion type for the specified channel.

CALC2:CONV:NAME?

ITS

The CALCulate suffix, <chn>, specifies the channel (1 to 4) or memory channel (5 to 14). The conversion types and their names are listed in Table 7 on page 124.

8.4.4.4 CALCulate<chn>:CONVert:NAME <conv>

Sets the conversion type for the specified channel.

CALC2:CONV:NAME CVD

The CALCulate suffix, <chn>, specifies the channel (1 to 4) or memory channel (5 to 14). The <conv> parameter is a mnemonic indicating the conversion type. The acceptable conversion types depend on the channel type. The conversion types and their names are listed in Table 7 on page 124.

This command may be password-protected. To access this command:

- If the SYST:PASS:CONV? command returns a 0 (probe password-protection is disabled), the password is not required.
- If the SYST:PASS:CONV? command returns a 1 (probe password-protection is enabled), the password must be successfully entered using the SYST:PASS:CEN <pass> command (see Section 9.4.11, Password Commands).

8.4.4.5 CALCulate<chn>:CONVert:PARAmeter:CATalog?

Returns the names of the probe characterization parameters associated with the current conversion type for the specified channel.

CALC2:CONV:PAR:CAT?

“RANGE”, “RTPW”, “A4”, “B4”, “A”, “B”, “C”, “D”

The CALCulate suffix, <chn>, specifies the channel (1 to 4) or memory channel (5 to 14). Each item in the response list is enclosed in double-quotes and separated from other items by a comma. Each item indicates the name of a characterization parameter for the current conversion type. If there are no pa-

parameters available for the current conversion type, an empty string is returned. The list of parameters depends on the selected conversion type. Characterization parameters for the various conversion types are listed in Table 8 on page 124, Conversion Types and Parameters.

8.4.4.6 **CALCulate<chn>:CONVert:PARAmeter:VALue? [<param>|ALL]**

Returns the value of the specified conversion parameter for the specified channel.

CALC2:CONV:PAR:VAL? RTPW

100.0145

The CALCulate suffix, <chn>, specifies the channel (1 to 4) or memory channel (5 to 14). The <param> parameter is the name of the parameter as given in Table 8, Conversion Types and Parameters. If the <param> parameter does not apply to the selected conversion type, an error -221, "Settings Conflict", is generated. Specifying the ALL parameter returns the name and value of all parameters associated with the specified channel in a comma delimited list. If no parameter is specified, the ALL parameter is assumed. The format of the response consists of a parameter name, enclosed in double quotes, followed by its value (i.e. "param1",value1,"param2",value2,"param3",value3,...).

8.4.4.7 **CALCulate<chn>:CONVert:PARAmeter:VALue <param>,<num>[,<param>,<num>...]**

Sets the value of one or more conversion parameters for the specified channel.

CALC2:CONV:PAR:VAL RTPW, 100.0145, A4, 0.0045

The CALCulate suffix, <chn>, specifies the channel (1 to 4) or memory channel (5 to 14). The <param> parameter is the name of the parameter as given in Table 8, Conversion Types and Parameters. If the <param> parameter is not applicable to the current conversion type, an error -221, "Settings Conflict", is generated. The <num> parameter is the desired value of the parameter. Multiple parameters can be set using a single command by separating the <param> and <num> parameters by commas. The order of the parameters is not important but the value must immediately follow the parameter name.

This command may be password-protected. To access this command:

- If the SYST:PASS:CONV? command returns a 0 (probe password-protection is disabled), the password is not required.
- If the SYST:PASS:CONV? command returns a 1 (probe password-protection is enabled), the password must be successfully entered using the SYST:PASS:CEN <pass> command (see Section 9.4.11, Password Commands).

8.4.4.8 **CALCulate:CONVert:PRINt [<chn>|ALL [,<port>]]**

Prints the conversion parameters for the specified channel.

CALC:CONV:PRIN 2

“PRB”,CHAN2,”ser”,090105,”TYP”,RES,”RANGE”,0

If no parameters are specified, the ALL parameter is assumed and the parameters for all channels are printed to the current port. Specifying the <chn> parameter prints only the parameters for the specified channel (1 to 4) to the current port. Optionally, the parameters may be printed to a specific port by specifying the <port> parameter (see Table 10 on page 125, Port Numbers)

8.4.4.9 **CALCulate<chn>:CONVert:SNUMber?**

Returns the probe serial number for the specified channel.

CALC2:CONV:SNUM?

A_336C

The CALCulate suffix, <chn>, specifies the channel (1 to 4) or memory channel (5 to 14). The returned serial number is in string format.

8.4.4.10 **CALCulate<chn>:CONVert:SNUMber <serl>**

Sets the probe serial number for the specified channel.

CALC2:CONV:SNUM A_336C

The CALCulate suffix, <chn>, specifies the channel (1 to 4) or memory channel (5 to 14). The <serl> parameter is in string format. The <serl> parameter can consist of up to eight characters that include any letters, numeric digits, and the underscore ‘_’.

This command may be password-protected. To access this command:

- If the SYST:PASS:CONV? command returns a 0 (probe password-protection is disabled), the password is not required.
- If the SYST:PASS:CONV? command returns a 1 (probe password-protection is enabled), the password must be successfully entered using the SYST:PASS:CEN <pass> command (see Section 9.4.11, Password Commands).

8.4.4.11 **CALCulate<chn>:CONVert:TEST? <res>|<volt>**

Tests the temperature conversion for the specified channel.

CALC2:CONV:TEST? 100.0145

0.0100

The CALCulate suffix, <chn>, specifies the channel (1 to 4) or memory channel (5 to 14). For PRT/Thermistor channels, the <res> parameter specifies a resistance value to convert to temperature. The <res> parameter is always in Ohms for PRTs and KOhms for Thermistors. For Thermocouple channels, the <volt> parameter specifies a voltage value to convert to temperature. The

<volt> parameter is always in mV. The response to this command is a temperature in the currently selected units. The current system units determine the scale of the response.

8.4.5 Calibration Coefficient Commands

The calibration coefficient commands are used for querying and setting the channel calibration date, due date, linearity, offset, scale, and RJC.

8.4.5.1 CALibrate:AUTo

Executes the automatic calibration procedure when using Fast Measurement Mode (see Sections 6.9, Fast Measurement Mode, 7.1.1, Measure Period and Fast Measurement Mode, and 7.1.5, Display Functions/Auto-Cal).

CAL:AUT

8.4.5.2 CALibrate<chn>:DATE:CALibrate? [MINIMAXIDEF]

Returns the calibration date for the specified channel.

CAL1:DATE:CAL?

2000,9,22

The CALibrate suffix, <chn>, specifies the channel (1 to 4). This command does not apply to memory channels. The response is returned in the format, <year>,<month>,<day>. Specifying the MIN parameter returns a value of 2000,1,1. Specifying the MAX parameter returns a value of 2099,12,31. Specifying the DEF parameter returns a value of 2000,1,1.

8.4.5.3 CALibrate<chn>:DATE:CALibrate (<year>,<month>,<day>)|MINIMAXIDEF

Sets the calibration date for the specified channel.

CAL1:DATE:CAL 2000,8,29

The CALibrate suffix, <chn>, specifies the channel (1 to 4). This command does not apply to memory channels. The <year>, <month>, and <day> parameters must all be supplied. The <year> parameter is a four-digit number (2000 to 2099). The <month> parameter is a one or two-digit number (1 to 12). The <day> parameter is a one or two-digit number (1 to 31). Specifying the MIN, MAX or DEF parameter sets the calibration date to the minimum, maximum, or default value respectively.

This command is password-protected. To access this command, the password must be successfully entered using the SYST:PASS:CEN <pass> command (see Section 8.4.11, Password Commands).

8.4.5.4 CALibrate<chn>:DATE:DUE? [MINIMAXIDEF]

Returns the recalibration date for the specified channel.

CAL1:DATE:DUE?

2001,9,21

The CALibrate suffix, <chn>, specifies the channel (1 to 4). This command does not apply to memory channels. The response is returned in the format, <year>,<month>,<day>. Specifying the MIN parameter returns a value of 2000,1,1. Specifying the MAX parameter returns a value of 2099,12,31. Specifying the DEF parameter returns a value of 2000,1,1.

8.4.5.5 CALibrate<chn>:DATE:DUE (<year>,<month>,<day>)[MINIMAXIDEF

Sets the recalibration date for the specified channel.

CAL1:DATE:DUE 2001,8,28

The CALibrate suffix, <chn>, specifies the channel (1 to 4). This command does not apply to memory channels. The <year>, <month>, and <day> parameters must all be supplied. The <year> parameter is a four-digit number (2000 to 2099). The <month> parameter is a one or two-digit number (1 to 12). The <day> parameter is a one or two-digit number (1 to 31). Specifying the MIN, MAX or DEF parameter sets the recalibration date to the minimum, maximum, or default value respectively.

This command is password-protected. To access this command, the password must be successfully entered using the SYST:PASS:CEN <pass> command (see Section 9.4.11, Password Commands).

8.4.5.6 CALibrate<chn>:PARAmeter:OFFSet<n>? [MINIMAXIDEF]

Returns the calibration offset parameter for the specified channel.

CAL1:PAR:OFFS2?

-1.2

The CALibrate suffix, <chn>, specifies the channel (1 to 4). This command does not apply to memory channels. For PRT/Thermistor channels, the calibration offset suffix <n> specifies the resistance range parameter for PRTs (1) or Thermistors (2). For Thermocouple channels, the calibration offset suffix <n> is ignored and may be omitted. **Note:** For PRT/Thermistor channels, the value returned by this command is always in ohms.

For PRT/Thermistor channels, specifying the MIN parameter returns a value of -9 when the offset suffix <n> is 1 (for PRTs) and -9000 when the offset suffix <n> is 2 (for Thermistors). For Thermocouple channels, specifying the MIN parameter returns a value of -9. For PRT/Thermistor channels, specifying the MAX parameter returns a value of 9 when the offset suffix <n> is 1 (for PRTs) and 9000 when the offset suffix <n> is 2 (for Thermistors). For Thermocouple channels, specifying the MAX parameter returns a value of 9. Specifying the DEF parameter returns a value of 0.

8.4.5.7 CALibrate<chn>:PARAmeter:OFFSet<n> <num>|MINIMAXIDeF

Sets the calibration offset parameter for the specified channel.

```
CAL1:PAR:OFFS2 5
```

The CALibrate suffix, <chn>, specifies the channel (1 to 4). This command does not apply to memory channels. For PRT/Thermistor channels, the calibration offset suffix <n> specifies the resistance range parameter (in ohms) for PRTs (1) or Thermistors (2). For Thermocouple channels, the calibration offset suffix <n> is ignored and may be omitted. The <num> parameter specifies the value for the specified offset parameter. Specifying the MIN, MAX or DEF parameter sets the offset parameter to the minimum, maximum, or default value respectively.

This command is password-protected. To access this command, the password must be successfully entered using the SYST:PASS:CEN <password> command (see Section 9.4.11, Password Commands).

8.4.5.8 CALibrate<chn>:PARAmeter:SCALE<n>? [MINIMAXIDeF]

Returns the calibration scale parameter for the specified channel.

```
CAL1:PAR:SCAL2?
```

0

The CALibrate suffix, <chn>, specifies the channel (1 to 4). This command does not apply to memory channels. For PRT/Thermistor channels, the calibration scale suffix <n> specifies the resistance range parameter for PRTs (1) or Thermistors (2). For Thermocouple channels, the calibration scale suffix <n> is ignored and may be omitted. **Note:** For PRT/Thermistor channels, the value returned by this command is always in ohms.

For PRT/Thermistor channels, specifying the MIN parameter returns a value of -9 when the scale suffix <n> is 1 (for PRTs) and -9000 when the scale suffix <n> is 2 (for Thermistors). For Thermocouple channels, specifying the MIN parameter returns a value of -9. For PRT/Thermistor channels, specifying the MAX parameter returns a value of 9 when the scale suffix <n> is 1 (for PRTs) and 9000 when the scale suffix <n> is 2 (for Thermistors). For Thermocouple channels, specifying the MAX parameter returns a value of 9. Specifying the DEF parameter returns a value of 0.

8.4.5.9 CALibrate<chn>:PARAmeter:SCALE<n> <num>|MINIMAXIDeF

Sets the calibration scale parameter for the specified channel.

```
CAL1:PAR:SCAL2 2
```

The CALibrate suffix, <chn>, specifies the channel (1 to 4). This command does not apply to memory channels. For PRT/Thermistor channels, the calibration scale suffix <n> specifies the resistance range parameter (in ohms) for PRTs (1) or Thermistors (2). For Thermocouple channels, the calibration scale suffix <n> is ignored and may be omitted. The <num> parameter specifies the

value for the specified scale parameter. Specifying the MIN, MAX, or DEF parameter sets the scale parameter to the minimum, maximum, or default value respectively.

This command is password-protected. To access this command, the password must be successfully entered using the SYST:PASS:CEN <pass> command (see Section 9.4.11, Password Commands).

8.4.5.10 CALibrate<chn>:PARAmeter:LINearity<n>? [MINIMAXIDEF]

Returns the calibration linearity parameter for the specified channel.

CAL1:PAR:LIN1?

2.8

This command only applies to PRT/Thermistor channels. Executing this command on Thermocouple channels generates a -294, "Incompatible type" error message.

The CALibrate suffix, <chn>, specifies the channel (1 to 4). This command does not apply to memory channels. For PRT/Thermistor channels, the calibration linearity suffix, <n>, specifies the resistance range parameter for PRTs (1) or Thermistors (2). **Note:** For PRT/Thermistor channels, the value returned by this command is always in ohms.

Specifying the MIN parameter returns a value of -9 when the linearity suffix <n> is 1 (for PRTs) and -9000 when the linearity suffix <n> is 2 (for Thermistors). Specifying the MAX parameter returns a value of 9 when the linearity suffix <n> is 1 (for PRTs) and 9000 when the linearity suffix <n> is 2 (for Thermistors). Specifying the DEF parameter returns a value of 0.

8.4.5.11 CALibrate<chn>: PARAmeter:LINearity<n> <num>IMINIMAXIDEF

Sets the calibration linearity parameter for the specified channel.

CAL1:PAR:LIN1 5

This command only applies to PRT/Thermistor channels. Executing this command on Thermocouple channels generates a -294, "Incompatible type" error message.

The CALibrate suffix, <chn>, specifies the channel (1 to 4). This command does not apply to memory channels. For PRT/Thermistor channels, the calibration scale suffix <n> specifies the resistance range parameter (in ohms) for PRTs (1) or Thermistors (2). The <num> parameter specifies the value for the specified linearity parameter. Specifying the MIN, MAX, or DEF parameter sets the linearity parameter to the minimum, maximum, or default value respectively.

This command is password-protected. To access this command, the password must be successfully entered using the SYST:PASS:CEN <password> command (see Section 9.4.11, Password Commands).

8.4.5.12 CALibrate<chn>:PARAmeter:RJC? [MINIMAXIDEF]

Returns the calibration RJC offset parameter for the specified channel.

CAL1:PAR:RJC?

2.1

This command only applies to Thermocouple channels. Executing this command on PRT/Thermistor channels generates a -294, "Incompatible type" error message.

The RJC suffix, <chn>, specifies the channel (1 to 4). This command does not apply to memory channels. Specifying the MIN parameter returns a value of -9. Specifying the MAX parameter returns a value of 9. Specifying the DEF parameter returns a value of 0.

8.4.5.13 CALibrate<chn>:PARAmeter:RJC <num>IMINIMAXIDEF

Sets the calibration RJC offset parameter for the specified channel.

CAL3:PAR:RJC 1.6

This command only applies to Thermocouple channels. Executing this command on PRT/Thermistor channels generates a -294, "Incompatible type" error message.

The RJC suffix, <chn>, specifies the channel (1 to 4). This command does not apply to memory channels. The <num> parameter specifies the RJC value for the specified channel. Specifying the MIN, MAX, or DEF parameter sets the RJC parameter to the minimum, maximum, or default value respectively.

This command is password-protected. To access this command, the password must be successfully entered using the SYST:PASS:CEN <pass> command (see Section 9.4.11, Password Commands).

8.4.6 Display Commands

The display commands are used for querying and setting the display resolution, lamp brightness, decimal format, window setting, and window fields.

8.4.6.1 DISPlay:RESolution? [MINIMAXIDEF]

Returns the display resolution setting.

DISP:RES?

2

Specifying the MIN parameter returns a value of 0. Specifying the MAX parameter returns a value of 4. Specifying the DEF parameter returns AUT.

8.4.6.2 DISPlay:RESolution <num>IAUTIMINIMAXIDEF

Sets the display resolution setting.

DISP:RES 3

The <num> parameter specifies the number of decimal places to display. This parameter can be 0, 1, 2, 3, or 4. Specifying the MIN, MAX or DEF parameter sets the display resolution to the minimum, maximum, or default value respectively. Specifying the AUT parameter sets the display resolution to automatic.

8.4.6.3 DISPlay:LAMP? [MINIMAXIDEF]

Returns the lamp brightness setting.

DISP:LAMP?

0

Specifying the MIN parameter returns a value of 0. Specifying the MAX parameter returns a value of 3. Specifying the DEF parameter returns a value of 0.

8.4.6.4 DISPlay:LAMP <bool>|<num>|MINIMAXIDEF

Sets the lamp brightness setting.

DISP:LAMP ON

The lamp can be turned on or off by using either the <bool> parameter (ON or OFF), the <num> parameter (0, 1, 2 or 3), or the MIN, MAX or DEF parameters. Specifying the <bool> parameter to ON turns on the lamp. Specifying the MIN, MAX, or DEF sets the lamp to the minimum, maximum, or default value respectively.

8.4.6.5 DISPlay:DECimal:FORMat? [MINIMAXIDEF]

Returns the current decimal format setting.

DISP:DEC:FORM?

0

A returned value of 0 indicates a period (.) is used as the decimal separator. A returned value of 1 indicates a comma (,) is used as the decimal separator. Specifying the MIN parameter returns a value of 0. Specifying the MAX parameter returns a value of 1. Specifying the DEF parameter returns a value of 0.

8.4.6.6 DISPlay:DECimal:FORMat <num>|MINIMAXIDEF

Sets the decimal format setting.

DISP:DEC:FORM 1

The <num> parameter can be either a 0 for a period (.) or a 1 for a comma (,). Specifying the MIN, MAX or DEF parameter sets the decimal format to the minimum, maximum, or default value respectively.

8.4.6.7 **DISPlay:WINDow? [MINIMAXIDEF]**

Returns the current display set.

DISP:WIND?

2

Specifying the MIN parameter returns a value of 1. Specifying the MAX parameter returns a value of 9. Specifying the DEF parameter returns a value of 1.

8.4.6.8 **DISPlay:WINDow <num>IMINIMAXIDEF**

Sets the current display set.

DISP:WIND MIN

The <num> parameter specifies the display set to select. Specifying MIN, MAX, or DEF parameter sets the current display set to the minimum, maximum, or default respectively.

8.4.6.9 **DISPlay:WINDow<n>:FIELd<n>:FEED?**

Returns the current setting of the specified field for the specified display set.

DISP:WIND1:FIEL2:FEED?

0,16

The WINDow suffix, <n>, specifies the display set (1 to 9). The FIELd suffix, <n>, specifies the field (1 to 8) within the display set. The response consists of two numbers separated by a comma. The first number represents the channel associated with the field. The second number represents the parameter to be displayed in the specified field. See Table 5 on page 122, Field Types, for the field types.

8.4.6.10 **DISPlay:WINDow<n>:FIELd<n>:FEED <chn>[,<num>]**

Sets the specified field within the specified display set.

DISP:WIND1:FIEL3:FEED 0,10

The WINDow suffix, <n>, specifies the display set (1 to 9). The FIELd suffix, <n>, specifies the field (1 to 8) within the display set. The <chn> parameter specifies channel (1 to 4) associated with the field. The <num> parameter specifies the parameter to be displayed in the specified field. See Table 5 on page 122, Field Types, for the field types.

8.4.7 **Logging Commands**

The logging commands are used for logging data automatically and on demand.

8.4.7.1 **LOGging:AUTomatic:DElete [<num>|ALL]**

Deletes entries from the auto log.

LOG:AUT:DEL 10

Specifying a number in the <num> parameter causes all auto log entries with that label number (1 to 25) to be deleted. If the ALL parameter is specified or no parameter is specified, all auto log entries are deleted.

8.4.7.2 LOGging:AUTomatic:COUNT? [MINIMAXIDEF]

Returns the number of measurements to be stored in the auto log during an auto log session.

LOG:AUT:COUN?

5000

Specifying the MIN parameter returns a value of 1. Specifying the MAX parameter value returns a value of 8160. Specifying the DEF parameter returns a value of 8160.

8.4.7.3 LOGging:AUTomatic:COUNT <num>IMINIMAXIDEF

Sets the number of measurements to be stored to the auto log during an auto log session.

LOG:AUT:COUN 100

The <num> parameter is the number of measurements to be stored in the auto log during the auto log session. Specifying the MIN, MAX, or DEF parameter sets the number of measurements to auto log to the minimum, maximum, or default respectively.

8.4.7.4 LOGging:AUTomatic:FREE?

Returns the number of auto log entries free and stored.

LOG:AUT:FREE?

8144,16

The response consists of two numbers separated by a comma. The first number indicates the number of auto log entries still available. The second number indicates the number of entries already stored.

Note: Every time an auto log session is started, the first entry in the log for that session consists of the data label and the date. All subsequent entries in the auto log for that session consist of the channel, measurement value, units, and time. Therefore, an auto log session that stores 100 measurements actually uses 101 log entries.

8.4.7.5 LOGging:AUTomatic:LABel? [MINIMAXIDEF]

Returns the current auto log label setting.

LOG:AUT:LAB?

24

Specifying the MIN parameter returns a value of 1, Specifying the MAX parameter returns a value of 25. Specifying the DEF parameter returns a value of 1.

8.4.7.6 **LOGging:AUTomatic:LABel <num>IMINIMAXIDeF**

Sets the current auto log label.

LOG:AUT:LAB 4

The <num> parameter specifies the auto log label number (1 to 25) to select. Specifying the MIN, MAX, or DEF parameter sets the auto log label to the minimum, maximum, or default respectively.

8.4.7.7 **LOGging:AUTomatic:POINt? [MAX]**

Returns the number of auto log entries already stored.

LOG:AUT:POIN?

28

Specifying the MAX parameter returns the total number of entries that can be stored in the auto log.

8.4.7.8 **LOGging:AUTomatic:PRINt [<num>|ALL [,<port>]]**

Prints the auto log entries.

LOG:AUT:PRIN ALL

```
DATA_25 1 22.676C 12:19:42 09-05-00
DATA_25 2 9.960 KO 12:19:44 09-05-00
DATA_25 3 23.220C 12:19:46 09-05-00
DATA_25 4 23.245C 12:19:48 09-05-00
DATA_25 1 22.765C 12:19:52 09-05-00
DATA_25 2 9.962 KO 12:19:54 09-05-00
DATA_25 3 23.087C 12:19:56 09-05-00
DATA_25 4 23.260C 12:19:58 09-05-00...
```

If no parameters are specified, the ALL parameter is assumed and all auto log entries are printed to the serial port. Specifying the <num> parameter prints only the log entries with the specified label number to the serial port. Optionally, the log entries may be printed to a specific port by specifying the <port> parameter (see Table 10 on page 125, Port Numbers).

8.4.7.9 **LOGging:AUTomatic:STATus?**

Returns the auto log status.

LOG:AUT:STAT?

0

If this query returns a 0, an auto log session is not running. If this query returns a 1, an auto log session is running.

8.4.7.10 LOGging:AUTomatic:STATus <bool>

Sets the auto log status.

LOG:AUT:STAT 0

The <bool> parameter turns auto logging on (1 or ON) or off (0 or OFF). If simultaneous scan mode is enabled, one measurement is stored for each channel in the auto log. The *RST command set the auto log status to off.

8.4.7.11 LOGging:AUTomatic:TIME? [MINIMAXIDEF]

Returns the auto log interval setting.

LOG:AUT:TIM?

1

Specifying the MIN parameter returns a value of 0.1. Specifying the MAX parameter value returns value of 3600. Specifying the DEF parameter returns a value of 1. The units are seconds.

8.4.7.12 LOGging:AUTomatic:TIME <num>IMINIMAXIDEF

Sets the auto log interval setting.

LOG:AUT:TIM 1

The <num> parameter can be one of the following values: 0.1, 0.2, 0.5, 1, 2, 5, 10, 30, 60, 120, 300, 600, 1800 or 3600. The units are seconds. If a value other than one listed is used, the instrument automatically selects the nearest acceptable value that is less than the value entered. Values greater than 3600 or less than 0.1 are ignored. Specifying the MIN, MAX or DEF parameter sets the log interval setting to the minimum, maximum, or default value respectively.

8.4.7.13 LOGging:AUTomatic:VALue? <num>IMINIMAXIDEF

Returns the specified auto log entry.

LOG:AUT:VAL? 10

,1,22.860,C,12,19,46,,,

The <num> parameter specifies the auto log entry to return. Specifying either the MIN or DEF parameter returns the first entry in the auto log. Specifying the MAX parameter returns the last entry in the auto log.

Note: Every time an auto log session is started, the first entry in the log for that session consists of the data label and the date. All subsequent entries in the auto log for that session consist of the channel, measurement value, units and time.

Therefore, an auto log session that stores 100 measurements actually uses 101 log entries.

8.4.7.14 LOGging:DEMAND:DELete [<num>|ALL]

Deletes entries from the demand log.

LOG:DEM:DEL 5

Specifying a number in the <num> parameter causes all demand log entries with that label number (1 to 25) to be deleted. If the ALL parameter is specified or no parameter, all demand log entries are deleted.

8.4.7.15 LOGging:DEMAND:FREE?

Returns the number of demand log entries free and stored.

LOG:DEM:FREE?

87,12

The response consists of two numbers separated by a comma. The first number indicates the number of demand log entries still available. The second number indicates the number of entries already stored.

Note: Every time a demand log reading is stored, the first entry in the log for that stored reading is the data label and the date. All subsequent entries in the demand log consist of the channel, measurement value, units, and time.

8.4.7.16 LOGging:DEMAND:LABel? [MINIMAXIDeF]

Returns the current demand log label setting.

LOG:DEM:LAB?

6

Specifying the MIN parameter returns a value of 1. Specifying the MAX parameter returns a value of 25. Specifying the DEF parameter returns a value of 1.

8.4.7.17 LOGging:DEMAND:LABel <num>|MINIMAXIDeF

Sets the current demand log label.

LOG:DEM:LAB 3

The <num> parameter specifies the demand log label number (1 to 25) to select. Specifying the MIN, MAX, or DEF parameter sets the demand log label to the minimum, maximum, or default respectively.

8.4.7.18 LOGging:DEMAND:POINT?

Returns the number of demand log entries already stored.

LOG:DEM:POIN?

21

Specifying the MAX parameter returns the total number of entries that can be stored in the demand log.

8.4.7.19 LOGging:DEMAND:PRINT [<num>|ALL [,<port>]]

Prints the demand log entries.

LOG:DEM:PRIN 23,1

```
DATA_23 1 22.862C 14:59:43 09-05-00
DATA_23 2 9.963 KO 14:59:44 09-05-00
DATA_23 3 23.097C 14:59:45 09-05-00
DATA_23 4 23.202C 14:59:46 09-05-00
```

If no parameters are specified, the ALL parameter is assumed and all demand log entries are printed to the serial port. Specifying the <num> parameter prints only the log entries with the specified label number to the serial port. Optionally, the log entries may be printed to a specific port by specifying the <port> parameter (see Table 10 on page 125, Port Numbers).

8.4.7.20 LOGging:DEMAND:STORE

Stores the current measurement into the demand log.

LOG:DEM:STOR

If simultaneous scan mode is enabled, one reading is stored in the log for each enabled channel.

8.4.7.21 LOGging:DEMAND:VALUE? <num>|MIN|MAX|DEF

Returns the specified demand log entry.

LOG:DEM:VAL? 10

```
DATA_25,2,9.961,KO,14,59,35,2000,9,5
```

The <num> parameter specifies the demand log entry to return. Specifying either the MIN or DEF parameter returns the first entry in the demand log. Specifying the MAX parameter returns the last entry in the demand log. Each entry in the demand log consist of the label, channel number, measurement value, scale, time and date.

8.4.7.22 LOGging:LABEL<n>:NAME?

Returns the name of the specified label.

LOG:LAB18:NAME?

```
DATA_18
```

The label suffix, <n>, specifies the number of the label (1 to 25) to retrieve. The label name is returned in string format.

8.4.7.23 **LOGging:LABel<n>:NAME <label>**

Sets the name of the specified label.

LOG:LAB18:NAME BATH

The label suffix, <n>, specifies the number of the label (1 to 25) to set. Label names can be up to 8 characters in length and can include any letters, numeric digits, and the underscore ('_').

8.4.8 **System Commands**

The system commands are used for querying instrument identification parameters, temperature units, and for setting operating parameters to the defined default values.

8.4.8.1 ***IDN?**

Returns the instrument identification string that indicates the manufacturer, model number, serial number, and code firmware version.

*IDN?

HART,1529,A09001,1.11

8.4.8.2 ***OPT?**

Returns a list of input modules installed.

*OPT?

PRT,TC

Input module types are reported by position, top to bottom, of the two input modules. The returned example is for a 1529 equipped with one 2-channel PRT input module and one 2-channel Thermocouple input module.

8.4.8.3 ***RST**

Sets the instrument operating parameters to defined conditions.

*RST

The following parameters are set when this command is issued.

- Sets the scanning sequence timer to 1 second.
- Sets channel 1 ON and all others OFF.
- Sets the scan mode to SCAN.
- Sets the moving average to 1.
- Sets the printing to all ports OFF.

- Sets the units to C.
- Sets the resolution to AUTO.
- Stops auto logging.
- Clears the statistical functions.

8.4.8.4 SYSTem:BOOT:VERSion?

Returns the boot ROM version.

SYST:BOOT:VERS?

0.50

8.4.8.5 SYSTem:CODE:VERSion?

Returns the firmware code version.

SYST:CODE:VERS?

1.11

8.4.8.6 SYSTem:ERRor?

Returns a system error message if any are present in the system error queue.

SYST:ERR?

0, "No error"

Each error condition produces only one error message at a time. The error queue may contain up to ten messages. The messages are reported in the order they occurred. Reading a message from the queue removes the message so the next message can be read. If more than ten errors occur before being read, the tenth error in the queue is -350, "Queue overflow" and all but the first nine errors are discarded. All errors cause the Error Bit (ERR, bit 2) for the Status BYTE Register to be set. Refer to Troubleshooting section for the error messages.

8.4.8.7 SYSTem:SNUMber?

Returns the instrument serial number.

SYST:SNUM?

A09002

If the serial number has not been set, a 0 is returned. The serial number is set at the factory and cannot be changed!

8.4.8.8 SYSTem:VERSion?

Returns the SCPI version number.

SYST:VERS?

1994.0

8.4.8.9 **UNIT:TEMPerature?**

Returns the system temperature units.

UNIT:TEMP?

C

The response is either C for Celsius, F for Fahrenheit, or K for Kelvin.

8.4.8.10 **UNIT:TEMPerature <unit>**

Sets the system temperature units.

UNIT:TEMP C

The <unit> parameter is either C or CEL for Celsius, F or FAR for Fahrenheit, or K or Kelvin for Kelvin. The *RST command sets the units to Celsius.

8.4.9 **Communication Interface Commands**

The communication interface commands are used for querying and setting serial port and IEEE configuration parameters.

8.4.9.1 **SYSTem:COMMunicate:SERial:BAUD? [MINIMAXIDEF]**

Returns the serial port baud rate setting.

SYST:COMM:SER:BAUD?

2400

Specifying the MIN parameter returns a value of 1200. Specifying the MAX parameter returns a baud rate of 19200. Specifying the DEF parameter returns a baud rate of 9600.

8.4.9.2 **SYSTem:COMMunicate:SERial:BAUD <baud>IMINIMAXIDEF**

Sets the serial port baud rate setting.

SYST:COMM:SER:BAUD MIN

The <baud> parameter can be one of the following values: 1200, 2400, 4800, 9600, or 19200. If a value other than one listed is used, the instrument automatically selects the nearest acceptable value. Values greater than 19200 or less than 1200 are ignored. Specifying the MIN, MAX or DEF parameter sets the port baud rate setting to the minimum, maximum, or default value respectively.

8.4.9.3 **SYSTem:COMMunicate:SERial:FDUPlex? [MINIMAXIDEF]**

Returns the serial port echo (duplex) setting.

SYST:COMM:SER:FDUP?

1

A value of 1 is returned if serial port echo (duplex) is ON. A value of 0 is returned if serial port echo (duplex) is OFF. Specifying the MIN parameter returns a value of 0. Specifying the MAX parameter returns a value of 1. Specifying the DEF parameter returns a value of 1.

8.4.9.4 SYSTem:COMMunicate:SERial:FDUPlex <bool>IMINIMAXIDEF

Sets the serial port echo (duplex) setting.

SYST:COMM:SER:FDUP MAX

The <bool> parameter turns serial port echo (duplex) mode on (1 or ON) or off (0 or OFF). Specifying the MIN, MAX, or DEF parameter sets the serial port echo (duplex) to the minimum, maximum, or default respectively.

8.4.9.5 SYSTem:COMMunicate:SERial:FEED? [MINIMAXIDEF]

Returns the state of the serial port printing.

SYST:COMM:SER:FEED?

0

A value of 1 is returned if serial port printing is enabled. A value of 0 is returned if serial port printing is disabled. Specifying the MIN parameter returns a value of 0. Specifying the MAX parameter returns a value of 1. Specifying the DEF parameter returns a value of 0.

8.4.9.6 SYSTem:COMMunicate:SERial:FEED <bool>IMINIMAXIDEF

Sets the state of the serial port printing.

SYST:COMM:SER:FEED DEF

The <bool> parameter turns serial printing on (1 or ON) or off (0 or OFF). Specifying the MIN, MAX, or DEF parameter sets the serial port printing value to the minimum, maximum, or default respectively. The *RST command sets the serial port printing to OFF.

8.4.9.7 SYSTem:COMMunicate:SERial:LINEfeed? [MINIMAXIDEF]

Returns the state of the serial port linefeed setting.

SYST:COMM:SER:LIN?

1

A value of 1 is returned if linefeed is enabled. A value of 0 is returned if linefeed is disabled. Specifying the MIN parameter returns a value of 0. Specifying the MAX parameter returns a value of 1. Specifying the DEF parameter returns a value of 1.

8.4.9.8 SYSTem:COMMunicate:SERial:LINEfeed <bool>|MINIMAXIDEF

Sets the state of the serial port linefeed setting.

SYST:COMM:SER:LIN ON

The <bool> parameter turns linefeed on (1 or ON) or off (0 or OFF). Specifying the MIN, MAX, or DEF parameter sets the linefeed to the minimum, maximum, or default respectively.

8.4.9.9 SYSTem:COMMunicate:SERial:TIME? [MINIMAXIDEF]

Returns the serial port sample period setting.

SYST:COMM:SER:TIM?

1

Specifying the MIN parameter returns a value of 0.1. Specifying the MAX parameter returns a value of 3600. Specifying the DEF parameter returns a value of 1.

8.4.9.10 SYSTem:COMMunicate:SERial:TIME <num>MINIMAXIDEF

Sets to serial port sample period setting.

SYST:COMM:SER:TIM 10

The <num> parameter can be one of the following values: 0.1, 0.2, 0.5, 1, 2, 5, 10, 30, 60, 120, 300, 600, 1800 or 3600. The units are seconds. If a value other than one listed here is used, the instrument automatically selects the nearest acceptable value that is less than the value entered. Values greater than 3600 or less than 0.1 are ignored. Specifying the MIN, MAX or DEF parameter sets the sample period setting to the minimum, maximum, or default value respectively.

8.4.9.11 SYSTem:KLOCKout? [MINIMAXIDEF]

Returns the state of the keypad lockout.

SYST:KLOC?

0

A value of 1 is returned if the keypad is locked out. A value of 0 is returned if the keypad is enabled (unlocked). Specifying the MIN parameter returns a value of 0. Specifying the MAX parameter returns a value of 1. Specifying the DEF parameter returns a value of 0.

8.4.9.12 SYSTem:KLOCKout <bool>|MINIMAXIDEF

Sets the state of the keypad lockout.

SYST:KLOC 1

The <bool> parameter turns the keypad lockout on (1 or ON) or off (0 or OFF). Specifying the MIN, MAX, or DEF parameter sets the keypad lockout to the minimum, maximum, or default respectively.

8.4.9.13 SYSTem:POWer:BATTery?

Returns the current battery charge level.

SYST:POW:BATT?

90

The returned value indicates the current percentage of charge remaining in the battery. The battery charge level is approximate and should be used only as a guideline.

8.4.9.14 SYSTem:POWer:SOURce?

Returns the source of power being used.

SYST:POW:SOUR?

0

Indicates whether the instrument is operating on the battery or the AC adapter. This command returns a 1 if the AC adapter is connected or a 0 if the instrument is running on the battery. The battery percentage is approximate and should only be used as a general guideline when determining the amount of charge remaining.

8.4.10 Date and Time Commands

The date and time commands are used for querying and setting the instrument date and time and the format that is used when displaying the date and time.

8.4.10.1 DISPlay:DATE:FORMat? [MINIMAXIDEF]

Returns a number indicating the current date format.

DISP:DATE:FORM?

0

The returned value is either a 0, 1, 2, or 3. See Table 11 on page 126, Date Formats, for a list of acceptable date formats. Specifying the MIN parameter returns a value of 0. Specifying the MAX parameter returns a value of 3. Specifying the DEF parameter returns a value of 0.

8.4.10.2 DISPlay:DATE:FORMat <num>IMINIMAXIDEF

Sets the date format setting.

DISP:DATE:FORM 1

The <num> parameter specifies the number of the desired date format. See Table 11 on page 126, Date Formats, for a list of acceptable time formats. Specifying the MIN, MAX, or DEF parameter sets the date format to the minimum, maximum, or default respectively.

8.4.10.3 **DISPlay:TIME:FORMat? [MINIMAXIDeF]**

Returns a number indicating the current time format.

DISP:TIME:FORM?

1

The return value is either a 0 or 1. See Table 12 on page 126, Time Formats, for a list of acceptable time formats. Specifying the MIN parameter returns a value of 0. Specifying the MAX parameter returns a value of 1. Specifying the DEF parameter returns a value of 1.

8.4.10.4 **DISPlay:TIME:FORMat <num>IMINIMAXIDeF**

Sets the time format setting.

DISP:TIME:FORM 1

The <num> parameter specifies the number of the desired time format. See Table 12 on page 126, Time Formats, for a list of acceptable time formats. Specifying the MIN, MAX, or DEF parameter sets the time format to the minimum, maximum, or default respectively.

8.4.10.5 **SYSTem:DATE? [MINIMAXIDeF]**

Returns the current system date.

SYST:DATE?

2000,9,1

The response is returned in the format, <year>,<month>,<day>. Specifying the MIN parameter returns a value of 2000,1,1. Specifying the MAX parameter returns a value of 2099,12,31. Specifying the DEF parameter returns a value of 2000,1,1.

8.4.10.6 **SYSTem:DATE <year>,<month>,<day>**

Sets the system date to the specified year, month, and day.

SYST:DATE 2000,8,24

The <year>, <month>, and <day> parameters must all be supplied. The <year> parameter is a four-digit number (2000 to 2099). The <month> parameter is a one or two-digit number (1 to 12). The <day> parameter is a one or two-digit number (1 to 31). Specifying the MIN, MAX or DEF parameter sets the system date to the minimum, maximum, or default value respectively.

8.4.10.7 SYSTem:TIME?

Returns the current system time.

SYST:TIME?

11,43,23

The response is returned in the format, <hour>,<minute>,<second>.

Note: The system time is always returned using 24-hour format regardless of the current time format setting.

8.4.10.8 SYSTem:TIME <hour>,<minute>,<second>

Sets the current system time to the specified hour, minute, and second.

SYST:TIME 11,43,23

The <hour>, <minute>, and <second> parameters must all be supplied. The <hour> parameter is a one or two-digit number (0 to 23). The <minute> parameter is a one or two-digit number (0 to 59). The <second> parameter is a one or two-digit number (0 to 59).

Note: The system time is always set using 24-hour format regardless of the current time setting.

8.4.11 Password Commands

The password commands are used for enabling and disabling the password-protected commands, for querying and setting the probe password-protected state, and for setting a new password.

8.4.11.1 SYSTem:PASSword:CDISable

Disables password protected commands.

SYST:PASS:CDIS

Sending this command prevents the user from accessing the password-protected settings.

8.4.11.2 SYSTem:PASSword:CENable <pass>

Enables password protected commands.

SYST:PASS:CEN 1234

The <pass> parameter is the current system password. This command must be sent to allow the user to access password-protected settings. After sending this command, use the SYST:PASS:CEN:STAT? command to verify success.

8.4.11.3 SYSTem:PASSword:CENable:STATe?

Returns the current password protection state.

SYST:PASS:CEN:STAT?

0

The response is either 0 (disabled) or 1 (enabled). A response of 0 indicates password-protected settings cannot be accessed. A response of 1 indicates the password was successfully entered and password-protected settings can be accessed.

8.4.11.4 **SYSTem:PASSword:CONVersion? [MINIMAXIDEF]**

Returns the current probe password-protected state.

SYST:PASS:CONV?

0

If the response to this command is 0, the indicated conversion settings are not password-protected and can be accessed without having to enter the password. If the response to this command is 1, the indicated conversion settings are password-protected and the password must be entered before they can be accessed. Specifying the MIN parameter returns a value of 0. Specifying the MAX parameter returns a value of 1. Specifying the DEF parameter returns a value of 0.

8.4.11.5 **SYSTem:PASSword:CONVersion <bool>IMINIMAXIDEF**

Sets the probe password-protection state.

SYST:PASS:CONV 0

The <bool> parameter allows the indicated conversion settings to be password protected (1 or ON) or not (0 or OFF). Setting this to 1 requires the password to be entered before the indicated conversion settings can be accessed. Setting this to 0 allows the indicated conversion settings to be accessed without having to enter the password. This command is password protected. To access this command, the password must be successfully entered using the SYST:PASS:CEN <pass> command (see section 9.4.11, Password Commands).

8.4.11.6 **SYSTem:PASSword:NEW <pass>**

Sets the current system password to a new password.

SYST:PASS:NEW 1212

The <pass> parameter must be a 4-digit number (0000 to 9999). The password is required to access the indicated settings. This command is password protected. To access this command, the password must be successfully entered using the SYST:PASS:CEN <pass> command (see Section 9.4.11, Password Commands).

8.4.12 Status Commands

The status commands are used for querying and setting the state of the instrument registers. For details on the operation of the status registers refer to the IEEE-488.2 and SCPI standards.

8.4.12.1 *CLS

Clears the status registers.

*CLS

8.4.12.2 *ESE?

Returns the Event Status Enable Register.

*ESE?

255

8.4.12.3 *ESE <num>IMINIMAXIDEF

Sets the Event Status Enable Register.

*ESE 48

8.4.12.4 *ESR?

Returns the Event Status Register.

*ESR?

0

8.4.12.5 *SRE?

Returns the Service Request Enable Register.

*SRE?

0

8.4.12.6 *SRE <num>IMINIMAXIDEF

Sets the Service Request Enable Register.

*SRE 32

8.4.12.7 *STB?

Returns the Status Byte Register.

*STB?

200

- 8.4.12.8 *TST?**
Performs a self-test and reports any errors that are found.
*TST?
0
- 8.4.12.9 STATus:MEASure?**
Reads and clears the Measurement Status Register.
STAT:MEAS?
1
The assignment of the bits in this register is as follows:
bit 0: channel 1 measurement complete
bit 1: channel 2 measurement complete
bit 2: channel 3 measurement complete
bit 3: channel 4 measurement complete
bits 4-15: not used
- 8.4.12.10 STATus:MEASure:CONDition?**
Returns the Measurement Status Condition Register.
STAT:MEAS:COND?
1
The assignment of the bits in this register is as follows:
bit 0: channel 1 measurement in process
bit 1: channel 2 measurement in process
bit 2: channel 3 measurement in process
bit 3: channel 4 measurement in process
bits 4-15: not used
- 8.4.12.11 STATus:MEASure:ENABLE?**
Returns the Measurement Status Enable Register.
STAT:MEAS:ENAB?
255
- 8.4.12.12 STATus:MEASure:ENABLE <num>**
Sets the Measurement Status Enable Register.

STAT:MEAS:ENAB 15

8.4.12.13 STATus:OPERation?

Reads and clears the Operation Status Register.

STAT:OPER?

16

The assignment of the bits in this register is as follows:

bits 0-3: not used

bit 4: measurement complete

bits 5-15: not used

8.4.12.14 STATus:OPERation:CONDition?

Returns the Operation Status Condition Register.

STAT:OPER:COND?

16

The assignment of the bits in this register is as follows:

bits 0-3: not used

bit 4: measurement in process

bits 5-15: not used

8.4.12.15 STATus:OPERation:ENABLE?[MINIMAXIDEF]

Returns the Operation Status Enable Register.

STAT:OPER:ENAB?

255

8.4.12.16 STATus:OPERation:ENABLE <num>|MINIMAXIDEF

Sets the Operation Status Enable Register.

STAT:OPER:ENAB 16

8.4.12.17 STATus:QUESTionable?

Reads and clears the Questionable Status Register.

STAT:QUES?

16

The assignment of the bits in this register is as follows:

bits 0-3: not used

bit 4: measurement invalid

bits 5-15: not used

8.4.12.18 STATus:QUEStionable:CONDition?

Returns the Questionable Status Condition Register.

STAT:QUES:COND?

16

The assignment of the bits in this register is as follows:

bits 0-3: not used

bit 4: measurement invalid

bits 5-15: not used

8.4.12.19 STATus:QUEStionable:ENABLE? [MINIMAXIDEF]

Returns the Questionable Status Enable Register.

STAT:QUES:ENAB?

255

8.4.12.20 STATus:QUEStionable:ENABLE <num>|MINIMAXIDEF

Sets the Questionable Status Enable Register.

STAT:QUES:ENAB 10

8.4.13 Statistical Calculation Types

The statistical calculation types are listed in the following table.

Table 4 *Statistical Calculation Types*

Number	Type	Keyword
1	Average	AVE
2	Standard Deviation	STD
3	Minimum	MIN
4	Maximum	MAX
5	Spread	SPR
6	N (Number of Samples)	STN

8.4.14 Field Types

The bottom portion of the main display is capable of showing up to eight fields. These fields are selectable from the following table.

Table 5 *Field Types*

Number	Keyword	Field Type
0	---	None
1	DATE	Date
2	TIME	Time
3	TYP	Conversion Type
4	SER	Probe Serial Number
5	INP	Input
6	REF	Reference
7	TEM	Temperature
8	-T1	Delta Between Specified Channel and Channel 1
9	-T2	Delta Between Specified Channel and Channel 2
10	-T3	Delta Between Specified Channel and Channel 3
11	-T4	Delta Between Specified Channel and Channel 4
12	AVE	Average
13	STD	Standard Deviation
14	MIN	Minimum
15	MAX	Maximum
16	SPR	Spread
17	STN	Statistical n (Number of Measurements Comprising Statistics)

Number	Keyword	Field Type
18	ALOG	Logging Indicator
19	BATT	Battery Percent Remaining
20	MEAS	Number of Seconds Until Next Measurement

Note: When the field type reference (REF) is selected, the displayed keyword changes depending on the probe type. The reference display keywords are detailed in the following table.

Table 6 Reference (REF) Keywords

Probe Type	Keyword	Description
RES	RIN	Resistance
ITS-90 ITS-SR5	RTP	R(0.01°C)
PT-100 CVD	R0	R(0°C)
THERM-R THERM-T YSI-400	R25	R(25°C)
VIN[mV] Thermocouples	RJT	Reference Junction Temperature

8.4.15 Conversion Types and Parameters

Table 7 lists the probe types, conversion types, mnemonics, and serial port responses. Table 8 lists the conversion types and their parameters.

Table 7 Conversion Types, Mnemonics, and Serial Port Responses

Probe Type	Conversion Type	Mnemonic	Port Response
SPRT, PRT, RTD, Thermistor	ITS-90 (default)	ITS-90	ITS
	ITS-SR5	ITS-SR5	ITS5
	PT-100	PT100	PT
	CVD	CVD	CVD
	THRM R(T)	THERM-R	TRES
	THRM T(R)	THERM-T	TTEM
	YSI-400 R(W)	YSI-400 RES	YSI RES
Thermocouple	TC-K (default)	TC-K	K
	MilliVolts	VIN[mV]	V
	TC-B	TC-B	B
	TC-E	TC-E	E
	TC-J	TC-J	J
	TC-N	TC-N	N
	TC-R	TC-R	R
	TC-S	TC-S	S
	TC-T	TC-T	T
	TC-AU/PT	TC-AU/PT	AuPT
Polynomial	TC-POLY	POLY	

Table 8 Conversion Types and Parameters

Conversion Type	Parameters
I90	Range, Wires, RTPW, A4, B4, A, B, C, D
ITS-SR5	Range, Wires, RTPW, A5, B5
PT100	Range, Wires
CVD	Range, Wires, R0, AL, DE, BE
YSI-400	Range, Wires
RES	Range Wires
THERM-R	B0, B1, B2, B3
THERM-T	A0, A1, A2, A3

Conversion Type	Parameters
TC-K VIN[mV]	RJC, RJT, T1, ADJ1, T2, ADJ2, T3, ADJ3 <none>
TC-B	RJC, RJT, T1, ADJ1, T2, ADJ2, T3, ADJ3
TC-E	RJC, RJT, T1, ADJ1, T2, ADJ2, T3, ADJ3
TC-J	RJC, RJT, T1, ADJ1, T2, ADJ2, T3, ADJ3
TC-N	RJC, RJT, T1, ADJ1, T2, ADJ2, T3, ADJ3
TC-R	RJC, RJT, T1, ADJ1, T2, ADJ2, T3, ADJ3
TC-S	RJC, RJT, T1, ADJ1, T2, ADJ2, T3, ADJ3
TC-T	RJC, RJT, T1, ADJ1, T2, ADJ2, T3, ADJ3
TC-AU/PT	RJC, RJT, T1, ADJ1, T2, ADJ2, T3, ADJ3
TC-POLY	RJC, RJT, mV(25C), C0, C1, C2, C3, C4, C5, C6

The following table lists the RJC settings and their corresponding number.

Table 9 RJC Settings

Number	Setting
0	External
1	Internal

8.4.16 Port Numbers

The following table lists the communication ports and their number setting.

Table 10 Port Numbers

Number	Port
0	Serial (default)

8.4.17 Date and Time Formats

The following tables list the acceptable date and time formats and their number setting.

Table 11 *Date Formats*

Number	Format
0	MM-DD-YY
1	MM-DD-YYYY
2	DD/MM/YY
3	DD/MM/YYYY

Table 12 *Time Formats*

Number	Format
0	H:MM:SSAM/PM (12-hour format)
1	HH:MM:SS (24-hour format)

9 Calibration

Each channel of the 1529 is calibrated independently of the other channels and has its own set of calibration parameters. The 1529 should be calibrated at regular intervals to ensure that it continues to measure with proper accuracy. Calibration should only be done by qualified, authorized personnel. When the 1529 is recalibrated, all four channels are calibrated each calibration cycle. The calibration label indicates the calibration date and recalibration due date for the entire instrument.

9.1 PRT and Thermistor Calibration

The following information is for PRT and thermistor channel calibrations. The adjustable parameters are listed in the following table.

Table 13 PRT and Thermistor Calibration Parameter Description

Parameter	Description
C0	PRT offset parameter
C100	PRT scale parameter
C400	PRT linearity parameter
C0K	Thermistor offset parameter
C10K	Thermistor scale parameter
C100K	Thermistor linearity parameter
DATE	Records the date the PRT or Thermistor channel was calibrated
DUE	Record the date the PRT or Thermistor channel calibration expires

9.1.1 PRT Calibration Parameters

Three adjustable parameters are used for calibration: C0, C100, and C400. The C0 parameter directly affects the measurement at 0Ω. It has negligible effect at 100Ω but significant affect at higher resistances. The C100 parameter directly affects the measurement at 100Ω. It has negligible effect at 0Ω and proportionately greater effect the higher the resistance. The C400 parameter directly affects the measurement at 400. It has negligible effect at 0Ω and 100Ω with greater effect as the resistance increases. Each of the parameters has positive effect at their primary resistances: increasing the value of the parameter increases the measured resistance. The theoretically normal value for each is 0.

The calibration parameters C0, C100, and C400 can be adjusted to optimize the accuracy. These password-protected parameters are accessed from the CALIBRATION function of the SYSTEM menu.

9.1.2 PRT Calibration Procedure

Calibration requires adjustment of the C0, C100, and C400 parameters at three specific input resistances. If the resistances used are approximately 0Ω, 100Ω and 400Ω respectively the adjustments are independent and the procedure is simple. The order in which the adjustments are performed is important. The adjustment of the C400 parameter must be done last as the adjustments of C0 and C100 affect the measurement at 400Ω but C400 does not affect the measurements at 0Ω or 100Ω. Each channel must be calibrated. Set the conversion type to RES to display resistance (see Section 7.2.1.5) and the RANGE parameter to 100Ω. The calibration should be performed with a four-wire connection and with the probe wiring parameter set to four-wire (see Section 6.4, Connecting the Probe). The accuracy required of the resistance standards is 1/4 of the instrument accuracy; that is $\pm 0.000125\Omega$ at 0Ω, $\pm 0.0006\Omega$ (6 ppm) at 100Ω, and $\pm 0.0024\Omega$ (6 ppm) at 400Ω. The recommended procedure is as follows:

1. Connect a 0Ω resistor to the input and measure its resistance. If a shorting wire is used the wire should run from the C2 terminal to the C1 terminal to the P1 terminal to the P2 terminal (See Figure 50). Note the average error in the measurement. Adjust the C0 parameter by subtracting the measured error. For example, if the input is exactly 0.0000 and the readout shows -0.0011, adjust the C0 parameter by adding 0.0011.

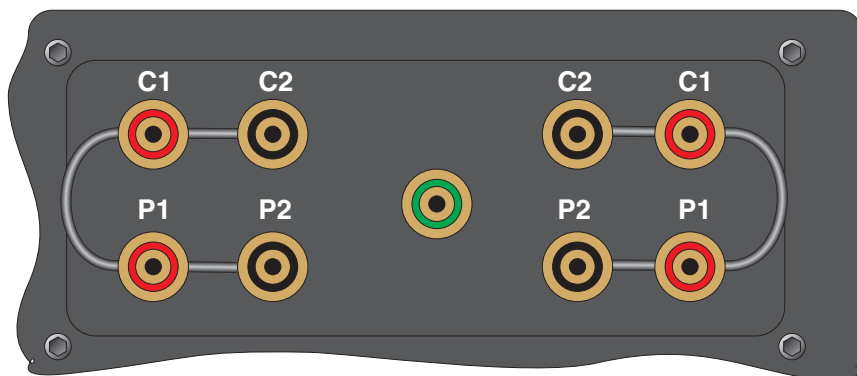

Figure 50 Using a Shorting Wire

2. Connect a 100Ω resistor (6 ppm accuracy) to the input and measure its resistance. Note the average error in the measurement. Adjust the C100 parameter by subtracting the measured error. For example, if the input is exactly 100.0000Ω and the readout shows 100.0295Ω, adjust the C100 parameter by subtracting 0.0295.

3. Connect a 400 Ω resistor (6 ppm accuracy) to the input and measure its resistance. Note the average error in the measurement. Adjust the C400 parameter by subtracting the measured error. For example, if the input is exactly 400.0000 Ω and the readout shows 399.9913 Ω , adjust the C400 parameter by adding 0.0087.
4. Record the date in the DATE parameter and set the DUE parameter to the desired calibration interval.
5. Verify the accuracy at 0 Ω , 25 Ω or 50 Ω , 100 Ω , 200 Ω , and 400 Ω on each channel.

9.1.3 Thermistor Calibration Parameters

Three adjustable parameters are used for calibration: C0K, C10K, and C100K. The C0K directly affects the measurement at 0 Ω . It has negligible effect at 10 k Ω but significant affect at higher resistances. The C10K directly affects the measurement at 10 k Ω . It has negligible effect at 0 Ω and proportionately greater effect the higher the resistance. The C100K directly affects the measurement at 100 k Ω . It has negligible effect at 0 Ω and 10 k Ω with greater effect as the resistance increases. Each of the parameters has positive effect at their primary resistances: increasing the value of the parameter increases the measured resistance. The theoretically normal value for each is 0.

The calibration parameters C0K, C10K, and C100K can be adjusted to optimize the accuracy. These parameters are accessed from the CALIBRATION function of SYSTEM menu.

9.1.4 Thermistor Calibration Procedure

Calibration requires adjustment of the C0K, C10K, and C100K parameters at three specific input resistances. If the resistances used are approximately 0 Ω , 10 k Ω and 100 k Ω respectively the adjustments are independent and the procedure is simple. The order in which the adjustments are performed is important. The adjustment of the C100K parameter must be done last as the adjustments of C0K and C10K affect the measurement at 100 k Ω but C100K does not affect the measurements at 0 Ω or 10 k Ω . Each channel must be calibrated. Set the conversion type to RES to display resistance and set the RANGE parameter to 10K Ω . The accuracy required of the resistance standards is 1/4 of the instrument accuracy; that is 0.12 Ω at 0 Ω , 0.25 Ω (25 ppm) at 10 k Ω , and 2.5 Ω (25 ppm) at 100 k Ω . The recommended procedure is as follows:

1. Connect a 0 Ω resistor to the input and measure its resistance. If a shorting wire is used the wire should run from the C2 terminal to the C1 terminal to the P1 terminal to the P2 terminal (See Figure 50 on page 128). Note the average error in the measurement. Adjust the C0K parameter by subtracting the measured error. For example, if the input is exactly 0.0 Ω and the readout shows -0.11 Ω , adjust the C0K parameter by adding 0.11.

2. Connect a 10 k Ω resistor (25 ppm accuracy) to the input and measure its resistance. Note the average error in the measurement. Adjust the C10K parameter by subtracting the measured error. For example, if the input is exactly 10.00000 k Ω and the readout shows 10.00295 k Ω , adjust the C10K parameter by subtracting 2.95.
3. Connect a 100 k Ω resistor (25 ppm accuracy) to the input and measure its resistance. Note the average error in the measurement. Adjust the C100K parameter by subtracting the measured error. For example, if the input is exactly 100.0000 k Ω and the readout shows 99.9913 k Ω , adjust the C100K parameter by adding 8.7.
4. Record the date in the DATE parameter and set the DUE parameter to the desired calibration interval.
5. Verify the accuracy at 0 Ω , 4k Ω , 10k Ω , 40k Ω , 100k Ω , and 500k Ω on each channel.

9.2 Thermocouple Calibration

The following information is for a Thermocouple calibration. See Section 9.1 for PRT and thermistor calibrations.

9.2.1 Calibration Parameters

Three adjustable parameters are used for calibration of each thermocouple channel. They are listed in Table 14, Calibration Parameters.

Table 14 Calibration Parameters

Parameter	Description
C0	Adjusts the voltage accuracy of at 0 mV
C100	Adjusts the voltage accuracy of at 100 mV
CRJ	Adjusts the internal RJC accuracy
DATE	Records the date the thermocouple channel was calibrated
DUE	Records the date the thermocouple channel calibration expires

The calibration parameters can be accessed from the CALIBRATION function of SYSTEM menu

9.2.2 Calibration Procedure

Calibration of each channel is performed in two steps. First the voltage measurement is calibrated then the internal RJC is calibrated. The equipment required are a programmable voltage source, a precision voltmeter with an accuracy of 10 ppm or better, a thermocouple (preferably type E), and a temperature source between 0 and 30°C. The combined accuracy of the reference thermocouple and temperature source must be 0.06°C or better between the reference temperature and ambient temperature. At each step during the calibration procedure the readings should be allowed to settle for at least two minutes before recording the measurement. Also, the 1529 should be allowed to warm up for at least one hour after power up prior to calibration. The recommended procedure is as follows:

1. Connect the voltage source to the thermocouple channel, set it for 0 mV, and measure the voltage with the 1529 and the voltmeter simultaneously. Adjust the C0 parameter by subtracting the measured error. For example, if the 1529 measures -0.0006 mV, adjust the C0 parameter by adding 0.0006. If it was previously 0.0000 it should now be 0.0006.
2. Set the voltage source to 100 mV and measure the voltage with the 1529 and the voltmeter simultaneously. Adjust the C100 parameter by subtracting the measured error. For example, if the input is exactly 100.0000 mV and the 1529 shows 100.2953 mV, the C100 parameter should be adjusted by subtracting 0.2953. If it was previously 0.0000 it should now be -0.2953.
3. Verify the voltage accuracy at 0, 50, and 100 mV. The accuracy must be within the short-term voltage accuracy given in the specifications.
4. Connect the calibrated thermocouple to the thermocouple channel and insert the thermocouple into the temperature source. Measure the temperature with the 1529 (be sure to program the channel with the correct thermocouple type). Adjust the CRJ parameter by subtracting the mea-

sured error. For example, if the thermocouple temperature is actually 0.0°C but the 1529 reads 0.184°C, the CRJ parameter should be adjusted by subtracting 0.184. If it was previously 0.000 it should now be -0.184.

6. Record the date with the DATE parameter. Set the DUE date to the desired calibration interval.
7. Repeat the procedure for any other thermocouple channels.

10 Maintenance

- The calibration instrument has been designed with the utmost care. Ease of operation and simplicity of maintenance have been a central theme in the product development. Therefore, with proper care the instrument should require very little maintenance. Avoid operating the instrument in oily, wet, dirty, or dusty environments.
- If the outside of the instrument becomes soiled, it may be wiped clean with a damp cloth and mild detergent. Do not use harsh chemicals on the surface, which may damage the LCD or the plastic front panel.
- If a hazardous material is spilt on or inside the equipment, the user is responsible for taking the appropriate decontamination steps as outlined by the national safety council with respect to the material.
- Before using any cleaning or decontamination method except those recommended by Hart, users should check with an Authorized Service Center (see Section 1.3) to be sure that the proposed method will not damage the equipment.
- If the AC adapter becomes damaged, have it replaced immediately. Never disassemble the AC adapter or attempt to repair it.
- If the instrument is used in a manner not in accordance with the equipment design, the operation of the thermometer readout may be impaired or safety hazards may arise.
- Periodic calibration of the instrument at regular intervals is required to ensure that it continues to measure with proper accuracy. Calibration should only be performed by qualified authorized personnel.

11 Troubleshooting

In case you run into difficulty while operating the 1529 system, this section provides some suggestions that may help you solve the problem. Below are several situations that may arise followed by possible causes and suggested actions you might take.

11.1 Troubleshooting

The following table lists possible error messages, their causes, and suggested actions.

Problem	Solution
Incorrect temperature reading	<p>While attempting to measure temperature, the display shows an incorrect value or no value at all (.....).</p> <ul style="list-style-type: none"> • If the temperature readings seem to be incorrect you should first check to see if the resistance, or voltage in the case of thermocouples, is being measured correctly. Set up the display to show the resistance or voltage for the channel. • If the resistance or voltage is incorrect refer to the next subsection for troubleshooting incorrect resistance or voltage readings. • If the resistance or voltage is being measured correctly but the displayed temperature value is incorrect consider the following possibilities: <ul style="list-style-type: none"> One or more coefficients are incorrect. This is a common mistake. While entering coefficients it is easy to miss a digit or sign. Check all the values carefully using the EDIT PROBE function (see Section 7.2.1) comparing them with the values on the calibration certificate for the probe. Use the TEST PROBE function to test the coefficients (see Section 7.2.1.10, Standard Thermocouple Conversions). The selected conversion type is incorrect. Check to make sure the correct conversion type is selected. In the case of thermocouples, make sure you have selected the correct type. You should also make sure that you have selected the proper reference junction compensation (RJC) made for your application (see Section 7.2.1.10, Standard Thermocouple Conversions). You can use the TEST PROBE function to test the temperature conversion calculation. The measurement is out of range. The 1529 may not be able to calculate temperature accurately if the resistance or voltage is outside the valid range. The measured resistance or voltage may be too low or too high if the actual temperature is too low or too high or if there is a problem with the sensor. • The measure period may be set to a long interval. Check the measure period setting.

Problem	Solution
Incorrect resistance or voltage reading	<p>While attempting to measure resistance or voltage, the display shows an incorrect value or no value at all (.).</p> <p>Consider the following possibilities:</p> <p>Poor or incorrect connection of the probe. A common mistake is to connect the wires of the probe to the wrong terminals. Check the wiring carefully, especially when using a four-wire PRT (see Section 6.4.1). Make sure the lead wires are fastened down tightly.</p> <p>Open, shorted, or damaged sensor or lead wires. In the case of resistance sensors check the resistance across the sensor using a hand-held DMM. Also check the resistance between common pairs of leads. Check to make sure there is no conductivity between any of the leads and the probe sheath. Use a good-quality sensor to avoid errors caused by drift, hysteresis, or insulation leakage. In the case of thermocouples, use a hand-held DMM to check its voltage.</p> <p>Improper setting for three or four-wire probe. Make sure the correct wiring type is selected. Selecting three-wire input while using four-wire probes may cause errors of 0.01 to 0.1 ohms. Selecting four-wire input while using three-wire probes will result in erratic or out-of-range readings (see Section 7.2.1.1).</p> <p>Electrical interference. Intense radio-frequency radiation near the 1529 or probes can induce noise into the measurement circuits resulting in erratic readings. The 1529 is intended to operate in a laboratory environment with limited radio-frequency noise. If interference seems to be a problem you might try eliminating the source of interference or moving the 1529 to a different location. A well-grounded, shielded cable should be used for the probe leads.</p> <p>Stem conduction error. The problem may be that the actual temperature of the sensor is not what you expect. This is often the result of stem conduction where heat flowing through the stem of the probe to ambient affects the temperature of the probe. It is very important that probes be inserted to an adequate depth into the material being measured. Measuring temperature using a surface sensor can be especially difficult as the sensor is directly exposed to ambient.</p> <p>Wrong calibration parameters. The problem may be that the calibration parameters for the 1529 are invalid. Check the parameters currently stored in the unit against those listed on the 1529 Report of Calibration.</p>
Blank screen	<p>The screen lights up when the 1529 is switched on but the screen appears blank. This problem can be caused by improper adjustment of the contrast. After the power is switched on allow the 1529 at least one minute to complete its self-test and power on sequence. Then, try to adjust the contrast using the contrast buttons.</p>
Error message at power up	<p>The 1529 reports an error during the power up self-test. On power up the 1529 performs a series of self-tests to check the operation of all its components and each of the modules. The results of the self-tests are reported on the screen. Normally, all tests report 'OK'. Below is a table of error messages and recommended actions to correct the error. Often these errors can be corrected by completing the actions listed. A failure of one or more component causes error messages to be reported. Component failures generally require a qualified factory technician to replace the faulty component. Contact an Authorized Service Center (see Section 1.3).</p>
Temperature not updating	<p>The 1529 measure period may be set to a long interval. Check the measure period.</p>

11.1.1 Self-Test Error Messages

The following messages may appear during the self-test. If the recommended action fails to correct the error, contact an Authorized Service Center (see Section 1.3) for assistance.

Message	Recommended Action
SYSTEMS: INVALID TIME	Set the date and time.
SYSTEMS: SERIAL PORT FAILURE	Cycle the power.

Message	Recommended Action
SYSTEMS: BATTERY NOT INSTALLED	Cycle the power. Check that the battery is properly connected. Replace the battery.
CHANNELS: FAILURE	Cycle the power.
CALIBRATION: DUE FOR RECAL	Check that the instrument date is correct. Recalibrate the instrument and set the recalibration date accordingly.
CALIBRATION: INVALID PARAMETERS	Check the correctness of the calibration parameters for each channel.
GPIB: NOT INSTALLED	Normal message if the IEEE-488 option is not installed.
MEMORY DATA: QUESTIONABLE	Reset the memory by pressing EXIT when prompted.
MEMORY DATA: INVALID DATA	Reset the memory by pressing ENTER when prompted. (This action requires that important data such as probe coefficients be restored.)
BUTTONS: [button name]	Check the stated button to ensure that it is not stuck. Loosen as necessary.

11.1.2 Start-up Error Messages

The following messages may appear after the self-test. If the recommended action fails to correct the error, contact an Authorized Service Center (see Section 1.3) for assistance.

Message	Recommended Action
CALIBRATION EXPIRED	Check that the instrument date is correct. Recalibrate the instrument and set the recalibration date accordingly.
INVALID CALIBRATION PARAMETERS	Check the correctness of the calibration parameters for each channel.
MEMORY QUESTIONABLE	Reset the memory by pressing EXIT when prompted.
MEMORY DATA INVALID, MEMORY WILL BE CLEARED	Reset the memory by pressing ENTER. (This action requires that important data such as probe coefficients be restored.)

11.2 Downloading Auto Logged Data

The 1529 “Chub-E4” Thermometer Readout stores up to 8,160 autolog readings or 100 demand log readings in its memory. These readings can be downloaded to a computer using the RS-232 serial port.

The following steps should be followed to download logged data using the serial port:

1. Connect the 1529 to a COM port on the computer using the serial cable.
2. Run a terminal program such as Windows® Terminal or HyperTerminal®.
 - a) Set up the terminal program to use the correct COM port and baud rate. Configure the communication settings to use 8 data bits, 1 stop bit, no parity and no flow control.

- b) If you want to save the downloaded data to a file, configure your terminal program to capture the incoming text and save it to a text file. Refer to your terminal program's documentation for details on how to do this.
3. Determine how many logged readings are stored in the 1529's memory.
 - a) For the autolog, send the command "LOG:AUT:POIN?". If the response to this command is "0", there are no autolog readings to download.
 - b) For the demand log, send the command "LOG:DEM:POIN?". If the response to this command is "0", there are no demand log readings to download.
4. Begin downloading the data.
 - a) To begin downloading the autolog data, send the command "LOG:AUT:PRIN" to initiate the download process.
 - b) To begin downloading the demand log data, send the command "LOG:DEM:PRIN" to initiate the download process.
 - c) The 1529 should immediately begin downloading the data. If no readings have been stored, the 1529 will not respond to these commands. For more details on using these commands, see Sections 9.4.7.8 and 9.4.7.19.
5. If the terminal program was set to capture the incoming data to a file, wait until no more data is being received, then stop capturing.

11.3 CE Comments

11.3.1 EMC Directive

Hart Scientifics' equipment has been tested to meet the European Electromagnetic Compatibility Directive (EMC Directive, 89/336/EEC). The Declaration of Conformity for your instrument lists the specific standards to which the unit was tested.

The instrument was designed specifically as a test and measuring device. Compliance to the EMC directive is through IEC 61326-1 *Electrical equipment for measurement, control and laboratory use – EMC requirements (1998)*.

As noted in the IEC 61326-1, the instrument can have varying configurations. The instrument was tested in a typical configuration with shielded, grounded probe and RS-232 cables. Emissions may, in non-typical applications, exceed the levels required by the standard. It is not practical to test all configurations, as the manufacturer has no control over the probes the user may connect to the instrument.

11.3.1.1 Immunity Testing

The instrument was tested to the requirements for industrial locations. This allows the instrument to be used in all types of locations from the laboratory to the factory floor. Criterion B was used for Radiated RF (IEC 61000-4-3) and

Conducted RF (IEC 61000-4-6). Therefore, the operation of the instrument may be affected by excessive electromagnetic interference and the instrument may not perform within the normal specification limits in such an environment. Criterion C was used for Electrostatic Discharge (ESD, IEC 61000-4-2) and Electric Fast Transit (EFT, Burst, IEC 61000-4-4). If the instrument is subjected to EFT conditions at 2kV, the instrument may require the user to cycle the power to return to normal operation.

11.3.1.2 Emission Testing

The instrument fulfills the limit requirements for Class A equipment but does not fulfill the limit requirements for Class B equipment. The instrument was not designed to be used in domestic establishments.

11.3.2 Low Voltage Directive (Safety)

In order to comply with the European Low Voltage Directive (73/23/EEC), Hart Scientific equipment has been designed to meet the IEC 1010-1 (EN 61010-1) and the IEC 1010-2-010 (EN 61010-2-010) standards.

11.4 Frequently Asked Questions

11.4.1 Battery

1. What type of batteries does the Model 1529 use? The Model 1529 uses a built-in Nickel-Metal-Hydrate battery pack.
2. How long do I need to charge the battery initially? The batteries come fully charged. If for some reason they are not fully charged, the front panel indicator shows this and you can recharge them as needed.
3. How long does the battery take to fully charge? About 3 hours from fully discharged.
4. How long does the battery last from full charge? About 8 hours from full charge with the backlight off.
5. How do I know when the battery is at full charge? The charging indicator LED located on the back panel displays amber while charging and then turns green when the batteries are fully charged (only when the AC adapter is connected). The front panel indicator at the bottom right shows when the batteries are in use and their approximate charge state.
6. How does the backlight affect the battery life? With the backlight on low the battery life is reduced by 25%, medium by 30%, and high by 40%.
7. Do I have to let the battery fully discharge before charging? No, the batteries do not need to be fully discharged before recharging. You may recharge them at any time.
8. Is it recommended that I allow the battery pack to fully discharge occasionally? In order to maintain the charge/discharge characteristics of the

battery, Hart recommends that you allow the battery to discharge completely once a month. You do this by allowing the Model 1529 to operate on battery power until it shuts down on its own.

9. If I allow the battery pack to fully discharge, what happens to the calibration parameters stored in the Model 1529? Parameters used by the Model 1529 are stored in non-volatile RAM (NVRAM). This IC stores the parameters even when power is not applied.
10. How many recharge cycles is the battery good for? Approximately 500.
11. What happens to my measurement accuracy when the battery is low? The Model 1529 does not display temperature when there is not sufficient power to make a correct measurement.
12. If I am using the autolog and the battery runs out will I lose my data? No, you won't lose any data. The Model 1529 simply stops logging data. When the AC adapter is plugged in, the data logging continues.
13. How do I dispose of the batteries used in the Model 1529? Disposal guidelines can be found by consulting your local governing authority.
14. If the AC adapter is plugged in and I have the unit turned on, is the battery still charging? Yes, the Model 1529 charges while in use without affecting the charging time or its performance.
15. If I am using the Model 1529 with AC power and a power outage occurs, will the batteries automatically take over? Yes, when AC power is removed from the Model 1529 for any reason, the batteries automatically supply back up power without risk of losing any data.

11.4.2 Input

1. Can I swap out measurement boards in the field? No, the measurement boards were not designed to be exchanged in the field.
2. What are the implications of the fast measurement mode in terms of accuracy? Accuracy is reduced when using the Model 1529 in fast measurement mode. Refer to Section 8.1.1 for a better description of the fast measurement mode and its limitations.
3. Why can I only see one channel in the fast measurement mode? Because of the time required to make a measurement and update the display, there is not enough time to display more than one channel when in the fast measurement mode.
4. Do I have to reprogram the Model 1529 each time I swap out a probe? In addition to the four main channels, there are nine memory locations available to store probe coefficients. If the new probe's information has been programmed into one of these locations, you can copy it to the channel to which it is connected.
5. How does the moving average affect the data that is logged? The data collected by the Model 1529 is stored as it appears on the display. If you

set the Model 1529 to average the measurements, the data it logs reflects the moving average setting.

6. How many probe coefficients can I store? Thirteen. Four sets in the main channels and nine sets in memory locations.
7. Are the readings really simultaneous in the simultaneous mode? Yes. There are four measurement circuits that collect the raw data simultaneously. The raw data is then converted to its corresponding temperature in sequence taking less than 0.5 seconds for all four channels.
8. How does the three-wire RTD setting affect my overall accuracy? When using the three-wire setting in the Model 1529, a partial compensation of lead-wire resistance is performed as per normal industry practices. Since a three-wire measurement can't fully compensate for lead resistance, accuracy is reduced. As stated in the specification section of this manual, you need to add 0.05Ω to the measurement accuracy plus the maximum possible difference between the resistances of the lead wires.

11.4.3 Logging

1. How many data points can the Model 1529 store? You can store up to 100 demand log readings and 8,000 autolog readings.
2. What happens when the log memory is full? Logging stops once the memory is full. Readings are not deleted to make room for new readings.
3. How can I tell when the log memory is full? Full memory is indicated in the log stats function in the logging menu. You can also program a field in the lower display to show the autolog memory status.
4. Can I use the Model 1529 for other applications while I am autologging? Yes, the Model 1529 can be used while logging. However, keep in mind that the channels that are displayed are also logged. Changing the channels affects the data that is logged.

11.4.4 Output

1. How do I get data from the Model 1529 to my PC? Data can be transferred to your PC via an RS-232 interface.
2. Can the Model 1529 be set to simultaneous measurement mode and log to the serial port? Yes. The Model 1529 makes the measurements simultaneously and transmits them to the serial port. However, most printers can't print as fast as the data is logged so it doesn't appear to be simultaneous.

11.4.5 Other

1. Can I update the Model 1529 firmware without sending in my unit? Yes. Firmware updates include a utility program that installs the upgrade via the RS-232 port.

2. How do I change the password? Changing the password is explained in Section 8.5.3, Password, of this manual.
3. How often does the Model 1529 need to be recalibrated? We suggest that the unit be calibrated annually, but that may vary based upon usage and your company's policies.

Index

!

- 2-wire probe 37 - 38
- 3-wire probe 37 - 38
- 4-wire probe 37 - 38

A

- AC adapter 19, 23
- accessories 17
- ASTM E1137 38
- AUTO LOG 58
- AUTO-CAL 33
- average 31

B

- backlight 23, 33, 51
- battery 19, 23
 - charging 19
- baud rate 69
- buttons 15, 137

C

- calibration 127, 137
- CALIBRATION 73
- CALIBRATION EXPIRED 137
- Callendar-Van Dusen 38
- channel
 - selection 30
- CHANNEL menu 27
- CHANNEL MODE 31
- CLEAR STATS 46
- coefficients

- probe 36, 39, 135

- COMM SETUP 68
- commands 78
- communication 68, 77
- conformity 138
- contrast 15, 23, 136
- COPY PROBE 42
- CVD 38

D

- DATA LABELS 59, 65
- data logging 25, 58, 137
- date 48, 70
- DATE TIME 70
- DC power 23
- decimal 33, 51
- DEFAULT FIELDS 49
- DEFAULT LABELS 66
- DEFAULT PROBE 44
- DELETE DATA 57, 63
- delta temperature 48
- DEMAND LOG 52
- difference temperature 48
- DIN-43760 38
- display 19
 - backlight 23, 33, 51
 - contrast 15, 23, 136
 - data 47 - 49
 - fields 47 - 49
- DISPLAY OPTIONS 32

E

EDIT FIELDS 49
EDIT PROBE 34
EMC 138
ENABLE CHANNEL 30
environment 10
error 136
exit 15, 27

F

fast measurement 24, 29
features 7, 15
field data 47 - 49
FIELDS menu 45
filter 31

G

GPIB 77
GPIB port 70

I

IEC-751 38
IEEE-488 70, 77
ITS-90 36 - 37

L

lamp 33, 51
linefeed 69
log count 60
LOG HISTORY 54
log period 60
LOG STATS 64
logging 25, 58, 137
LOGGING menu 51

LOGGING OPTIONS 59

M

maintenance 133
MEASURE PERIOD 28, 60
measurement 13, 23
memory 137
menu 15, 27
menu functions 27
MOVING AVERAGE 31

P

parts and controls 15
password 34, 42, 71, 73, 75
PASSWORD 71
PASSWORD INCORRECT 34, 42, 72 - 73, 75
period
 logging 60
 measurement 28, 60
 serial 69
polynomial 41
power 12, 23
PRINT DATA 56, 63
PRINT PROBE 43
printing
 serial 69
probe 21, 34 - 35
 coefficients 36, 39
 password 72
 serial number 35
 type 35
 wires 21, 37 - 39
PROBE menu 33

PRT 21
PT-100 38

R

rack mounting 17
range
 resistance 37 - 39
reference junction 41, 48
reset 75
resistance 39, 48
resolution 33, 51
RJC 41
RS-232 69, 77
RTD 38

S

scan 31
SELECT FIELDS 47
self-test 23, 136
sensor 21
serial interface 77
serial number 35, 67
serial period 69
serial port 69
specifications 9
START 60
statistics 46, 48
Steinhart-Hart 39
STOP 60
STORE READING 53
SYSTEM menu 67
SYSTEM RESET 75

T

TEST PROBE 43

thermistor 21, 39 - 40
thermocouple 21, 41
time 48, 70
troubleshooting 135
type
 probe 35

U

units 15, 19

V

version
 firmware 67
VIEW DATA 55, 62
volts 40, 48

W

wires
 probe 21, 37 - 39

Y

YSI-400 40

Free Manuals Download Website

<http://myh66.com>

<http://usermanuals.us>

<http://www.somanuals.com>

<http://www.4manuals.cc>

<http://www.manual-lib.com>

<http://www.404manual.com>

<http://www.luxmanual.com>

<http://aubethermostatmanual.com>

Golf course search by state

<http://golfingnear.com>

Email search by domain

<http://emailbydomain.com>

Auto manuals search

<http://auto.somanuals.com>

TV manuals search

<http://tv.somanuals.com>