

FLUKE®

561

Infrared Thermometer

Users Manual

PN 2562924

February 2006 Rev. 3, 4/08

© 2006-2008 Fluke Corporation, All rights reserved. Printed in China. Specifications are subject to change without notice. All product names are trademarks of their respective companies.

LIMITED WARRANTY AND LIMITATION OF LIABILITY

This Fluke product will be free from defects in material and workmanship for two years from the date of purchase. This warranty does not cover fuses, disposable batteries, or damage from accident, neglect, misuse, alteration, contamination, or abnormal conditions of operation or handling. Resellers are not authorized to extend any other warranty on Fluke's behalf. To obtain service during the warranty period, contact your nearest Fluke authorized service center to obtain return authorization information, then send the product to that Service Center with a description of the problem.

THIS WARRANTY IS YOUR ONLY REMEDY. NO OTHER WARRANTIES, SUCH AS FITNESS FOR A PARTICULAR PURPOSE, ARE EXPRESSED OR IMPLIED. FLUKE IS NOT LIABLE FOR ANY SPECIAL, INDIRECT, INCIDENTAL OR CONSEQUENTIAL DAMAGES OR LOSSES, ARISING FROM ANY CAUSE OR THEORY. Since some states or countries do not allow the exclusion or limitation of an implied warranty or of incidental or consequential damages, this limitation of liability may not apply to you.

Fluke Corporation
P.O. Box 9090
Everett, WA 98206-9090
U.S.A.

Fluke Europe B.V.
P.O. Box 1186
5602 BD Eindhoven
The Netherlands

11/99

Table of Contents

Title	Page
Introduction	1
Contacting Fluke	1
Safety Information	2
Features	3
Display	4
Buttons and Connector	5
How the Thermometer Works	6
Operating the Thermometer	6
Locating a Hot or Cold Spot	6
Distance and Spot Size	6
Field of View	7
Emissivity	7
Switching Between °C and °F	8
Using the Contact Temperature Probe	9
HOLD	10
Maintenance	10
Changing the Battery	10
Cleaning the Lens	10
Cleaning the Housing	10
Troubleshooting	11
CE Certification	11
Specifications	11

561 Infrared Thermometer

Introduction

The Fluke 561 Infrared Thermometer (hereafter, the Thermometer) can determine the surface temperature by measuring the amount of infrared energy radiated by the target's surface or by contact using a thermocouple probe. The Thermometer was designed specifically for use in heating, ventilating, and air conditioning (HVAC) applications. This manual covers all versions of the the Fluke 561. Note that the Japanese models indicate Celsius only.

Contacting Fluke

To contact Fluke, call one of the following telephone numbers:

USA: 1-888-44-FLUKE (1-888-443-5853)

Canada: 1-800-36-FLUKE (1-800-363-5853)

Europe: +31 40 267 5200

Japan: +81-3-3434-0181

Singapore: +65-738-5655

Anywhere in the world: +1-425-446-5500

For USA Service: 1-888-99-FLUKE (1-888-993-5853)



Or, visit Fluke's Web site at www.fluke.com.

To register your product, visit <http://register.fluke.com>.

Safety Information

Warning

A Warning identifies conditions and actions that pose hazards to the user. To avoid electrical shock or personal injury, follow these guidelines:

-  Do not point laser directly at eye or indirectly off reflective surfaces.
- Before using the Thermometer inspect the case. Do not use the Thermometer if it appears damaged. Look for cracks or missing plastic.
- Replace the batteries as soon as the battery indicator  appears.
- Do not use the Thermometer if it operates abnormally. Protection may be impaired. When in doubt, have the Thermometer serviced.
- Do not operate the Thermometer around explosive gas, vapor, or dust.
- Do not connect the optional external probe to live electrical circuits.
- To avoid a burn hazard, remember that highly reflective objects will often result in lower than actual temperature measurements.
- If the Thermometer is used in a manner not specified by the manufacturer, the protection provided by the Thermometer may be impaired.







Caution

To avoid damaging the thermometer or the equipment under test protect them from the following:

- EMF (electro-magnetic fields) from arc welders, induction heaters, etc.
- Static electricity.
- Thermal shock (caused by large or abrupt ambient temperature changes- allow 30 minutes for the Thermometer to stabilize before use).
- Do not leave the Thermometer on or near objects of high temperature.

Table 1 and Figure 1 show various symbols and safety markings that are on the Thermometer and in this manual.

Table 1. Symbols

Symbol	Explanation
	Risk of danger. Important information. See Manual.
	Hazardous voltage. Risk of electrical shock.
	Warning. Laser.
	Conforms to requirements of European Union and European Free Trade Association (EFTA).
	Do not dispose of this product as unsorted municipal waste. Go to Fluke's web site for recycling information.
	Battery
 沪制01120009号	China metrology certification mark for measuring instruments manufactured in the Peoples Republic of China (PRC).



efh010f.eps

Figure 1. Symbols and Safety Markings

Features

The Thermometer includes:

- Single-spot Laser Sighting
- Backlit Display
- Hard Case
- Current Temperature Plus MIN, MAX, DIF Temperature Displays
- Easy Emissivity Selector
- Type-K Thermocouple
- Two AA Batteries

Thermometer features are shown in Figure 2.

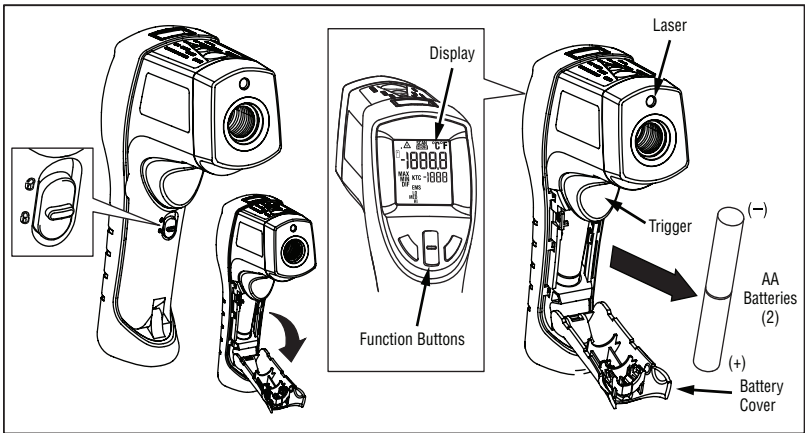

Figure 2. Infrared Thermometer

efh0071.eps

Display

The primary temperature display reports the current or last IR temperature read until the 7-second hold time elapses.

The secondary temperature display reports current thermocouple temperature when a type-K thermocouple is attached. When a thermocouple is not connected, the small temperature display reports a choice of maximum, minimum, or difference between maximum and minimum temperature.

You can toggle through the minimum, maximum, and difference IR temperatures anytime the display is on. The MIN, MAX, and DIF temperatures are constantly calculated and updated when the trigger is pressed. After the trigger is released, the MIN, MAX, DIF temperatures are held for 7 seconds.

Note

When the battery is low,  appears on the display.

The last selection (MIN/MAX/DIF) is maintained on the secondary display even after the Thermometer has been turned off, providing the batteries have not failed.

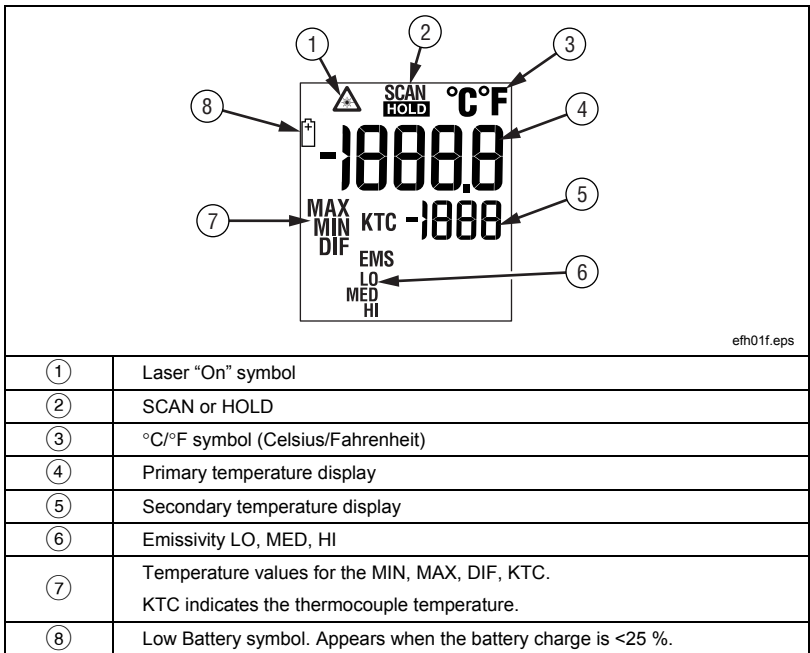

Figure 3. Thermometer Display

Buttons and Connector

Button/ Connector	Description
	Press and then press to toggle between the MIN, MAX, and DIF options.
	The button is used to show the MIN, MAX, and DIF functions in the secondary display, whichever was pressed most recently.
	Selects the emissivity setting. You can toggle between LO (0.3), MED (0.7), or HI (0.95) using .
	K-type thermocouple probe used to make contact temperature measurement.

How the Thermometer Works

Infrared thermometers measure the surface temperature of an opaque object. The Thermometer's optics sense infrared energy, which is collected and focused onto a detector. The Thermometer's electronics then translate the information into a displayed temperature reading which appears on the display. The laser is used for aiming purposes only.

Operating the Thermometer

The Thermometer turns on when you press the trigger. The Thermometer turns off when no activity is detected for 7 seconds.

To measure temperature, aim the Thermometer at the target, pull and hold the trigger. Release the trigger to hold a temperature reading.

Be sure to consider distance-to-spot size ratio and field of view. The laser is used for aiming only.

Locating a Hot or Cold Spot

To find a hot or cold spot, aim the Thermometer outside the target area. Then, slowly scan across the area with an up and down motion until you locate the hot or cold spot. See Figure 4.

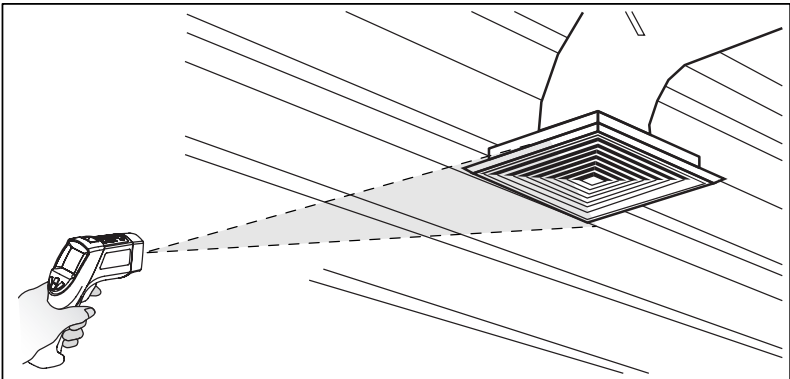

efh014f.eps

Figure 4. Locating a Hot or Cold Spot

Distance and Spot Size

As the distance (D) from the target being measured increases, the spot size (S) of the area measured by the unit becomes larger. The spot sizes indicates 90 % encircled energy. The maximum D:S is obtained when the Thermometer is 900 mm (36 in) from the target resulting in a spot size of 75 mm (3 in). See Figure 5.

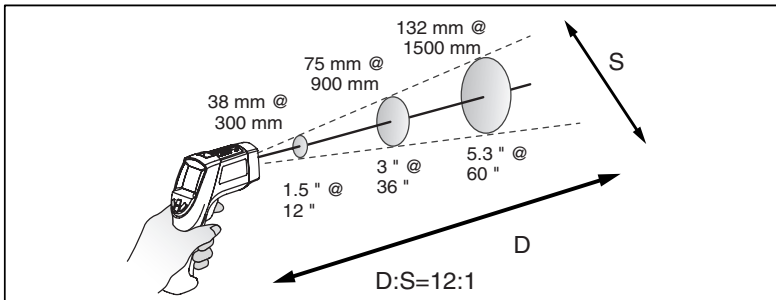

efh005f.eps

Figure 5. Distance and Spot Size

Field of View

Make sure that the target is larger than the spot size. The smaller the target, the closer you should be to it. See Figure 6.

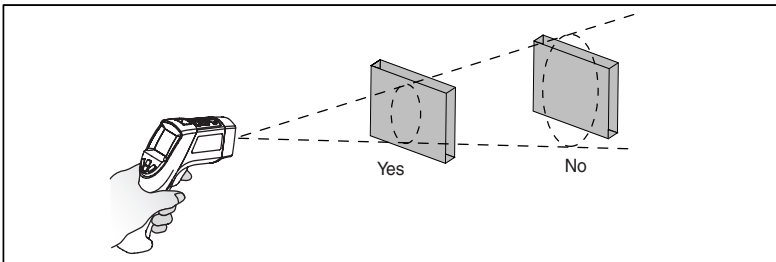

efh004f.eps

Figure 6. Field of View

Emissivity

Emissivity describes the energy-emitting characteristics of materials. Most organic materials and painted or oxidized surfaces have an emissivity of about 0.95.

If possible, to compensate for inaccurate readings that may result from measuring shiny metal surfaces, cover the surface to be measured with masking tape or flat black paint (<148 °C/300 °F) and use the high emissivity setting. Allow time for the tape or paint to reach the same temperature as the surface beneath it. Measure the temperature of the tape or painted surface.

If you cannot paint or use tape, then you can improve the accuracy of your measurements with the emissivity selector. Even with the emissivity selector, it can be difficult to get a completely accurate infrared measurement of a target with a shiny or metallic surface. Experimentation, using the probe to determine benchmark temperatures, and experience will help you choose the best setting for specific measurements.

The Thermometer has three emissivity settings: low (0.3), medium (0.7), and high (0.95). Refer to Table 2. The reference to emissivity settings in the table are suggestions for typical situations. Your particular situation may differ.

Table 2. Surface Emissivity

Measured Surface	Switch Setting	Measured Surface	Switch Setting
Aluminum		Iron, Cast	
Oxidized	Low	Oxidized	High, Medium
Alloy A3003		Unoxidized	Low
Oxidized	Low	Molten	Low
Roughened	Low	Iron, Wrought	
Brass		Dull	High
Burnished	Low	Lead	
Oxidized	Low	Rough	Low
Copper		Oxidized	Low, Medium
Oxidized	Medium	Molybdenum	
Electrical Terminal Blocks	Medium	Oxidized	Low, Medium
Haynes		Nickel	
Alloy	Medium	Oxidized	Low
Inconel		Platinum	
Oxidized	High, Medium	Black	High
Sandblasted	Medium	Steel	
Electropolished	Low	Cold-Rolled	High
Iron		Ground Sheet	Medium
Oxidized	High, Medium	Polished Sheet	Low
Rusted	Medium	Zinc	
		Oxidized	Low

Switching Between °C and °F

Open the battery compartment and locate the switch positioned between the left side of the battery near the Thermometer wall. To toggle between °C and °F, use a small screwdriver or paper clip to move the switch to the desired position. See Figure 7.

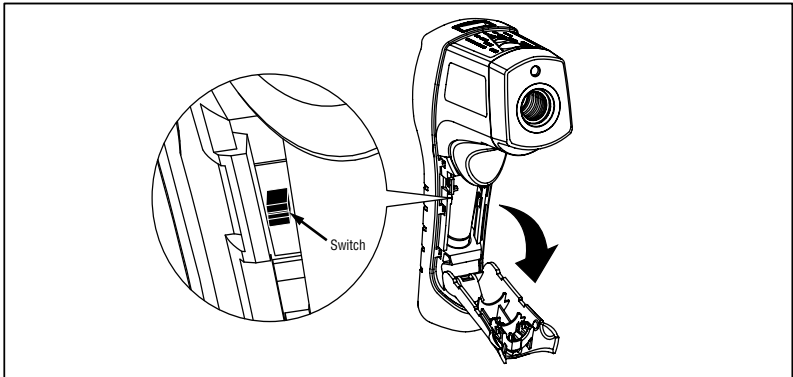

efh012f.eps

Figure 7. Switching Between °C and °F

Using the Contact Temperature Probe

⚠ ⚠ Warning

To avoid electrical shock or personal injury, do not connect the optional external probe to live electrical circuits.

Connect the probe to the input on the top of the Thermometer. The probe temperature and KTC appears in the secondary display. The live infrared temperature continues to show in the primary display. Connect the temperature probe as shown in Figure 8.

Note

With the probe inserted, the Thermometer stays on for 10 minutes (with laser off) after the trigger is released.

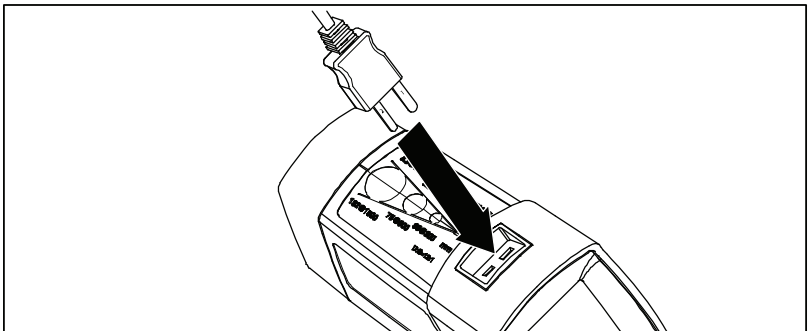

efh009f.eps

Figure 8. Connecting the Temperature Probe

Table 3 lists recommended Fluke temperature probes for use with the Thermometer:

Table 3. Recommended Temperature Probes

Probe	Usage
80PK-25	The piercing probe is the most versatile option. Good for checking air temperature in ducts, surface temperature under carpets/pads, liquids, thermometer wells, vent temperatures, and for penetrating pipe insulation.
80PK-1	The general purpose bead probe is an alternative, for quick, accurate surface temperatures and air temperatures within ducts, vent temperatures.
80PK-8	Pipe clamp probes (2) are essential for tracking continuously changing temperature differentials on hydronic tubing and pipe loops, and good for quick, accurate refrigerant temperatures.
80PK-26	The tapered probe is a good general-purpose gas and surface probe, with a good length and low mass tip casing for faster reaction to surface and air temperatures.
80PK-9	The insulation piercing probe provides a sharp tip to pierce pipe insulation and flat probe tip for good surface thermal contact, air temperatures within ducts, and vent temperatures.
80PK-11	The Velcro pipe probe is a convenient way to attach a thermocouple to a pipe while keeping hands free.

HOLD

The display will remain activated for 7 seconds after the trigger is released. HOLD appears in the upper middle of the display. When the trigger is pulled again, the Thermometer will begin measuring in the last function selected.

Maintenance

Changing the Battery

To install or change the two AA batteries, open the battery compartment and insert the batteries as shown in Figure 2.

Cleaning the Lens

Blow off loose particles using clean compressed air. Carefully wipe the surface with a moist cotton swab. The swab may be moistened with water.

Cleaning the Housing

Use soap and water on a damp sponge or soft cloth.

⚠ Caution

To avoid damaging the Thermometer, do NOT submerge it in water.

Troubleshooting

Symptom	Problem	Action
--- (on display)	Target temperature is over or under range	Select target within specifications
	Low battery	Replace battery
Blank display	Possible dead battery	Check and/or replace battery
Laser does not work	1. Low or dead battery 2. Ambient temperature above 40 °C (104 °F)	1. Replace battery 2. Use in area with lower ambient temperature

CE Certification

The Thermometer conforms to the following standards:

- EN61326-1 EMC Standard
- EN61010-1 Safety Standard
- EN60825-1 Laser Standard

Certification testing was conducted using a frequency range of 80 to 1000 MHz with the instrument in three orientations.

Specifications

Infrared

Measurement Range	-40 °C to 550 °C (-40 °F to 1022 °F)
Spectral Range.....	8 to 14 microns
Accuracy	±1 % or ± 1 °C (2 °F); <0 °C (32 °F), ±1 °C (2 °F) ± 0.1°/1° (Assumes ambient operating temperature of 23 to 25 °C (73 to 77 °F))
Repeatability.....	±0.5 % of reading or ±1 °C (2 °F)
Display Resolution.....	0.1 °C (0.1 °F)
Secondary Display Information	Maximum, Minimum, Differential, KTC
Response Time (95 %).....	500 ms
Distance to Spot (D:S).....	12:1
Emissivity Adjustment.....	Three settings: low (0.3), medium (0.7), high (0.95)
Contact Probe Input	
Input Temperature Range	-40 °C to 550 °C (-40 °F to 1022 °F)
Input Accuracy	Input accuracy ± 1.1 °C (± 2 °F)
Display Resolution.....	1 °C (1 °F)

Laser

Sighting.....	Single point laser
Power.....	Class 2 (II) operation; Output <1 mW, wavelength 630 to 670 nm

Wrap Thermocouple Probe (model-specific)

Type.....	Type K with miniconnector and Velcro strap, ASTM E230-03 Standard Tolerance
Measurement Range	0 °C to 100 °C (32 °F to 212 °F)
Accuracy	±2.2 °C (4.0 °F)
Total Length	505 mm (20 in) cable terminated with a Type K thermocouple inside a 495 mm (19.5 in) nylon Velcro cuff

Bead Thermocouple Probe (model-specific)

Type.....	Type K with miniconnector
Measurement Range	-40 °C to 260 °C (-40 °F to 500 °F)
Accuracy	±1.1 °C (2.0 °F) from 0 °C to 260 °C (32 °F to 500 °F). Typically within 1.1 °C (2.0 °F) from -40 °C to 0 °C (-40 °F to 32 °F)
Cable Length	1 m (40 in) terminated with Type K thermocouple beads

Electrical

Power Supply.....	2 AA Batteries (alkaline or NiCD)
Power Consumption.....	At least 12 hours battery life

Physical

Weight.....	0.322 kg (0.7099 lb)
Size.....	17.69 cm (6.965 in) x 16.36 cm (6.441 in) x 5.18 cm (2.039 in)

Environmental

Operating Temperature Range	0 °C to 50 °C (32 °F to 120 °F)
Relative Humidity	0 to 90 %, noncondensing up to 30 °C (86 °F)
Storage Temperature	-20 °C to 65 °C (-4 °F to 150 °F)
Optional Accessories	Soft Case

Free Manuals Download Website

<http://myh66.com>

<http://usermanuals.us>

<http://www.somanuals.com>

<http://www.4manuals.cc>

<http://www.manual-lib.com>

<http://www.404manual.com>

<http://www.luxmanual.com>

<http://aubethermostatmanual.com>

Golf course search by state

<http://golfingnear.com>

Email search by domain

<http://emailbydomain.com>

Auto manuals search

<http://auto.somanuals.com>

TV manuals search

<http://tv.somanuals.com>