

845AR

High Impedence Voltmeter Null Detector

Instruction Manual

P/N 294181
April 1968



WARRANTY

Notwithstanding any provision of any agreement the following warranty is exclusive:

The JOHN FLUKE MFG. CO., INC., warrants each instrument it manufactures to be free from defects in material and workmanship under normal use and service for the period of 1-year from date of purchase. This warranty extends only to the original purchaser. This warranty shall not apply to fuses, disposable batteries (rechargeable type batteries are warranted for 90-days), or any product or parts which have been subject to misuse, neglect, accident, or abnormal conditions of operations.

In the event of failure of a product covered by this warranty, John Fluke Mfg. Co., Inc., will repair and calibrate an instrument returned to an authorized Service Facility within 1 year of the original purchase; provided the warrantor's examination discloses to its satisfaction that the product was defective. The warrantor may, at its option, replace the product in lieu of repair. With regard to any instrument returned within 1 year of the original purchase, said repairs or replacement will be made without charge. If the failure has been caused by misuse, neglect, accident, or abnormal conditions of operations, repairs will be billed at a nominal cost. In such case, an estimate will be submitted before work is started, if requested.

THE FOREGOING WARRANTY IS IN LIEU OF ALL OTHER WARRANTIES, EXPRESS OR IMPLIED, INCLUDING BUT NOT LIMITED TO ANY IMPLIED WARRANTY OF MERCHANTABILITY, FITNESS, OR ADEQUACY FOR ANY PARTICULAR PURPOSE OR USE. JOHN FLUKE MFG. CO., INC., SHALL NOT BE LIABLE FOR ANY SPECIAL, INCIDENTAL, OR CONSEQUENTIAL DAMAGES, WHETHER IN CONTRACT, TORT, OR OTHERWISE.

If any failure occurs, the following steps should be taken:

1. Notify the JOHN FLUKE MFG. CO., INC., or nearest Service facility, giving full details of the difficulty, and include the model number, type number, and serial number. On receipt of this information, service data, or shipping instructions will be forwarded to you.
2. On receipt of the shipping instructions, forward the instrument, transportation prepaid. Repairs will be made at the Service Facility and the instrument returned, transportation prepaid.

SHIPPING TO MANUFACTURER FOR REPAIR OR ADJUSTMENT

All shipments of JOHN FLUKE MFG. CO., INC., instruments should be made via United Parcel Service or "Best Way" prepaid. The instrument should be shipped in the original packing carton; or if it is not available, use any suitable container that is rigid and of adequate size. If a substitute container is used, the instrument should be wrapped in paper and surrounded with at least four inches of excelsior or similar shock-absorbing material.

CLAIM FOR DAMAGE IN SHIPMENT TO ORIGINAL PURCHASER

The instrument should be thoroughly inspected immediately upon original delivery to purchaser. All material in the container should be checked against the enclosed packing list. The manufacturer will not be responsible for shortages against the packing sheet unless notified immediately. If the instrument is damaged in any way, a claim should be filed with the carrier immediately. (To obtain a quotation to repair shipment damage, contact the nearest Fluke Technical Center.) Final claim and negotiations with the carrier must be completed by the customer.

The JOHN FLUKE MFG. CO., INC., will be happy to answer all applications or use questions, which will enhance your use of this instrument. Please address your requests or correspondence to: JOHN FLUKE MFG. CO., INC., P.O. BOX 43210, MOUNTLAKE TERRACE, WASHINGTON 98043, ATTN: Sales Dept. For European Customers: Fluke (Holland) B.V., P.O. Box 5053, 5004 EB, Tilburg, The Netherlands.

*For European customers, Air Freight prepaid.

John Fluke Mfg. Co., Inc., P.O. Box 43210, Mountlake Terrace, Washington 98043

Rev. 4/80

SECTION I

INTRODUCTION AND SPECIFICATIONS

1-1. INTRODUCTION

1-2. The Fluke Model 845AR High Impedance Voltmeter-Null Detector allows measurement of dc voltages from one microvolt to 1000 volts dc in 19 ranges. When used as a null detector on the 100 millivolt range and below, the input impedance is an excellent 10 megohms. A linear recorder output allows the instrument to be used for production testing, and also as a dc amplifier with a maximum gain of 120 db.

1-3. The instrument may be wired to operate from a line power source of 115 volts ac or 230 volts ac, as desired. The instrument is designed to be mounted directly in a standard EIA 19 inch relay rack. Resilient feet are also provided for bench top use.

1-4. ELECTRICAL SPECIFICATIONS

INPUT VOLTAGE RANGE

1 microvolt to 1000 volts dc end scale in nineteen ranges, using X1 and X3 progression.

INPUT RESISTANCE

100 megohms on 300 millivolt range and above, 10 megohms on 100 millivolt range and below. *through the 3 100 millivolt range. 1 megohm on the*

ACCURACY

$\pm(3\%$ end scale + 0.1 microvolt). *0.05 10/10/86*

MAXIMUM NOISE (input shorted)

Range	Noise (peak-peak)
1 microvolt	0.20 microvolt
3 microvolt	0.25 microvolt
10 microvolt - 1000 volt	0.30 microvolt

METER RESPONSE TIME (to 90% of reading)

Range	Time
1 microvolt	5 seconds
3 microvolt	3 seconds
10 microvolt - 1000 volt	1-1/2 seconds

INPUT ISOLATION

Better than 10^{12} ohms at less than 50% relative humidity and 25°C regardless of line, chassis, or recorder

grounding. Better than 10^{10} ohms up to 80% relative humidity and 35°C. With driven guard, isolation improves by at least one order of magnitude up to 10^{13} ohms. Any input terminal may be floated 1100 volts off chassis ground.

DC COMMON MODE REJECTION

Better than 160 db, input short-circuited, 80% relative humidity; better than 140 db, open-circuited, 50% relative humidity; better than 120 db, open-circuited, 80% relative humidity.

AC COMMON MODE REJECTION (below 100 kHz)

100 volts rms or 120 db greater than end scale, whichever is less, will effect reading less than 2% of end scale. Input open-circuited.

AC NORMAL MODE REJECTION (60 Hz and above)

AC voltages 60 db above end scale will effect reading less than 2% of end scale. Maximum voltage not to exceed 750 volts rms.

RECORDER OUTPUT

0-1 volt, one side at chassis ground; linear to 0.5% of end scale. Source impedance, 5k to 7.5k.

STABILITY OF ZERO

Better than 0.15 microvolt/hr, better than 0.3 microvolt/day.

TEMPERATURE COEFFICIENT OF ZERO

Less than 0.1 microvolt/°C from 15°C to 35°C. Less than 0.2 microvolt/°C from 0°C to 50°C.

ZERO CONTROL RANGE

± 5 microvolt minimum.

OVERLOAD PROTECTION

Up to 1100 volts dc may be applied on any range. Typical recovery time is 4 seconds.

INPUT POWER

115/230 volts ac $\pm 10\%$, 50 to 440 Hz, approximately 3 watts.

1-5. ENVIRONMENTAL SPECIFICATIONS

OPERATING TEMPERATURE RANGE

Within all specifications from 15°C to 35°C.

Within all specifications from 0° to 50° C except:

- Derate by a factor of two —
- Maximum Noise and Meter Response Time.
- DC Common Mode Rejection —
- Derate by 20 db.

STORAGE TEMPERATURE RANGE

-40° C to +70° C.

RELATIVE HUMIDITY RANGE

0 to 80%.

SHOCK

Meets hammer blow requirements of MIL-T-945A and MIL-S-901B.

VIBRATION

Meets 10 Hz to 55 Hz tests of MIL-T-945A.

1-6. MECHANICAL SPECIFICATIONS

MOUNTING

Standard EIA relay rack. Resilient feet provided for bench use.

WEIGHT

9 pounds.

SIZE

3.47 inches high x 19 inches wide x 8.26 inches deep.

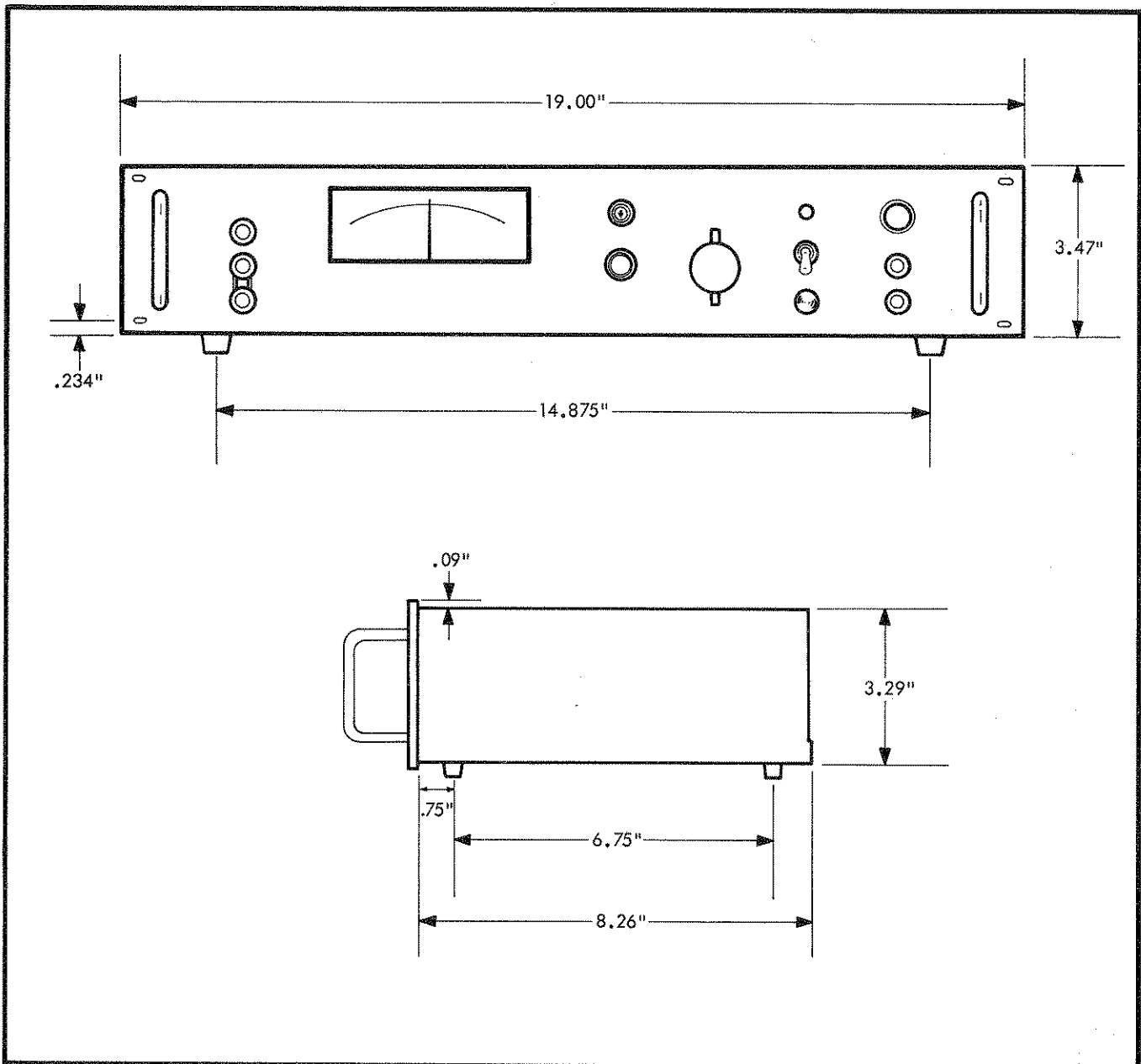

Figure 1-1. MODEL 845AR OUTLINE DRAWING



static awareness



A Message From
John Fluke Mfg. Co., Inc.

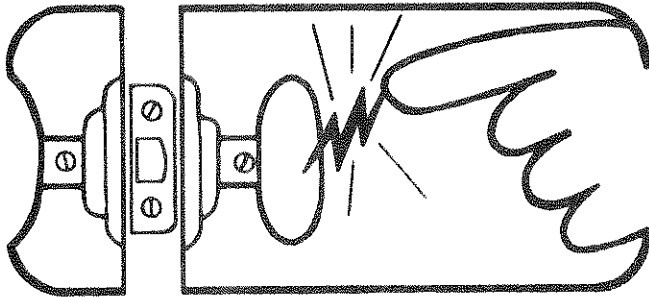

Some semiconductors and custom IC's can be damaged by electrostatic discharge during handling. This notice explains how you can minimize the chances of destroying such devices by:

1. Knowing that there is a problem.
2. Learning the guidelines for handling them.
3. Using the procedures, and packaging and bench techniques that are recommended.

The Static Sensitive (S.S.) devices are identified in the Fluke technical manual parts list with the symbol



The following practices should be followed to minimize damage to S.S. devices.

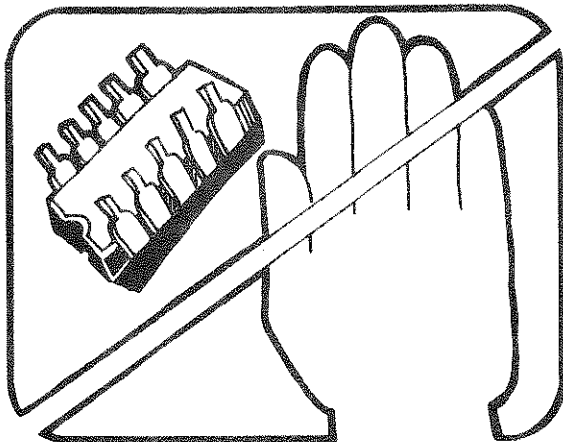

1. MINIMIZE HANDLING

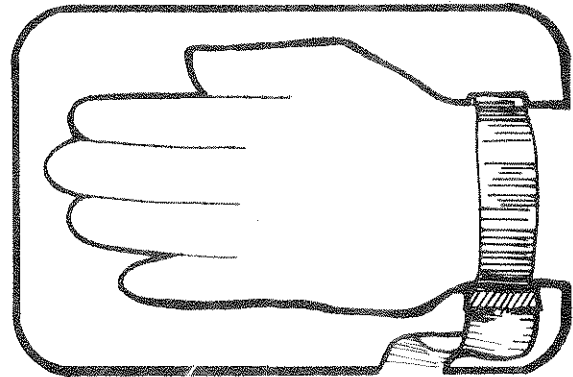

3. DISCHARGE PERSONAL STATIC BEFORE HANDLING DEVICES

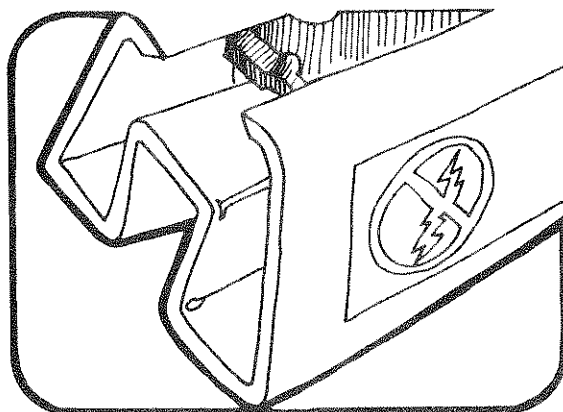

2. KEEP PARTS IN ORIGINAL CONTAINERS UNTIL READY FOR USE.

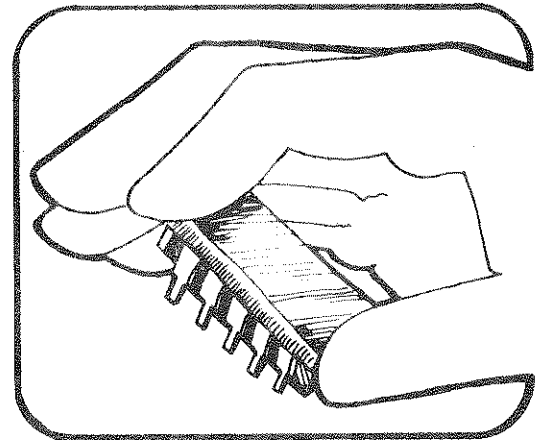

4. HANDLE S.S. DEVICES BY THE BODY

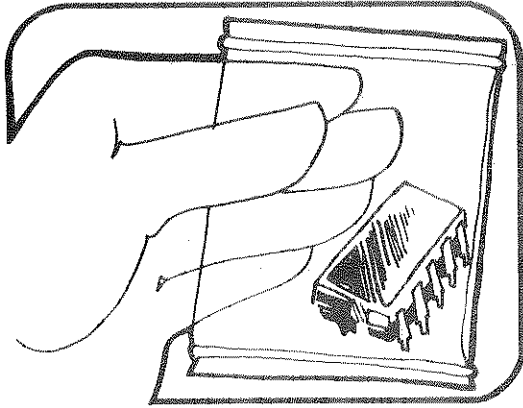

5. USE ANTI-STATIC CONTAINERS FOR HANDLING AND TRANSPORT

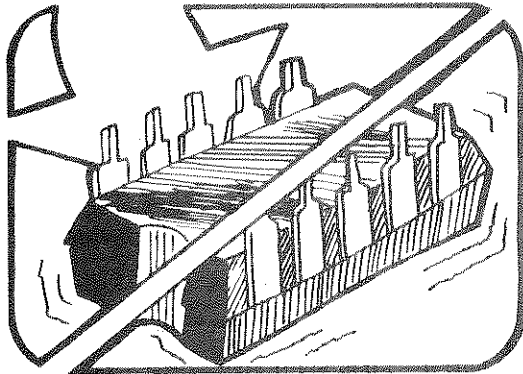

6. DO NOT SLIDE S.S. DEVICES OVER ANY SURFACE

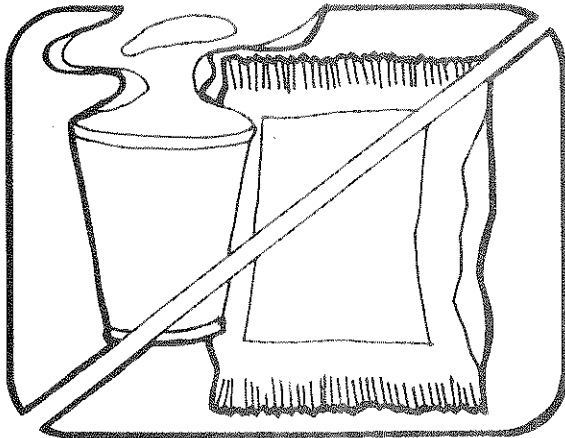

7. AVOID PLASTIC, VINYL AND STYROFOAM® IN WORK AREA

PORTIONS REPRINTED
WITH PERMISSION FROM TEKTRONIX, INC.
AND GENERAL DYNAMICS, POMONA DIV.

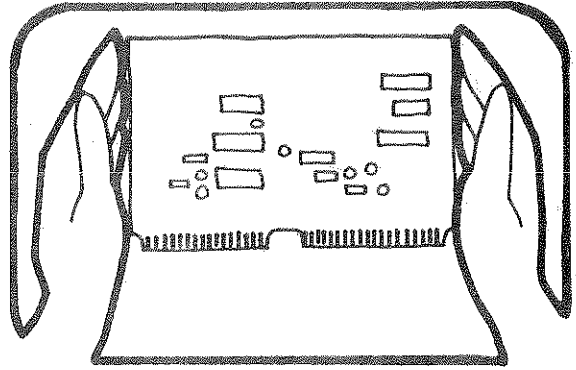

8. WHEN REMOVING PLUG-IN ASSEMBLIES, HANDLE ONLY BY NON-CONDUCTIVE EDGES AND NEVER TOUCH OPEN EDGE CONNECTOR EXCEPT AT STATIC-FREE WORK STATION. PLACING SHORTING STRIPS ON EDGE CONNECTOR USUALLY PROVIDES COMPLETE PROTECTION TO INSTALLED SS DEVICES.

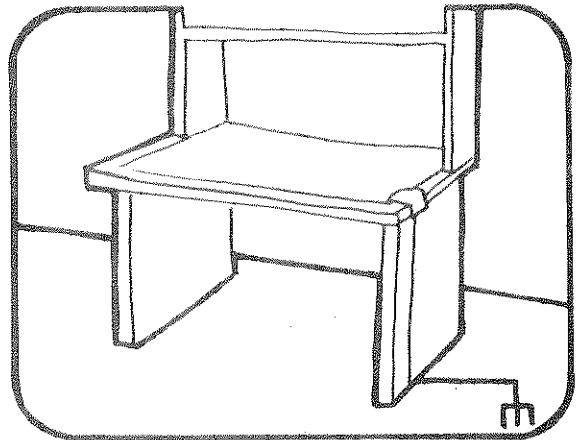

9. HANDLE S.S. DEVICES ONLY AT A STATIC-FREE WORK STATION
10. ONLY ANTI-STATIC TYPE SOLDER-SUCKERS SHOULD BE USED.
11. ONLY GROUNDED TIP SOLDERING IRONS SHOULD BE USED.

Anti-static bags, for storing S.S. devices or pcbs with these devices on them, can be ordered from the John Fluke Mfg. Co., Inc.. See section 5 in any Fluke technical manual for ordering instructions. Use the following part numbers when ordering these special bags.

John Fluke Part No.	Description
453522	6" X 8" Bag
453530	8" X 12" Bag
453548	16" X 24" Bag
454025	12" X 15" Bag
Pink Poly Sheet	Wrist Strap
30"x60"x60 Mil	P/N TL6-60
P/N RC-AS-1200	\$7.00
\$20.00	

SECTION II

OPERATING INSTRUCTIONS

2-1. RECEIVING INSPECTION

2-2. This instrument has been thoroughly tested and inspected before being shipped from the factory. Immediately upon receiving the instrument, carefully inspect for damage which may have occurred during shipment. If any damage is noted, follow the instructions outlined in the warranty page at the back of this manual.

2-3. CONTROLS, TERMINALS, AND INDICATOR

2-4. The location and function of the front-panel controls are described in Figure 2-1. Detailed operating descriptions are given in the following paragraphs.

2-5. PRELIMINARY OPERATION

2-6. Connect the Model 845AR line plug to a 115 volt ac power outlet or to 230 volts ac if the instrument is so wired.

WARNING!

The round pin on the polarized three-prong plug connects the instrument case to power system ground. Use a three-to-two pin adapter when connecting to a two-contact outlet. For personnel safety, connect the short lead from the adapter to a high-quality earth ground.

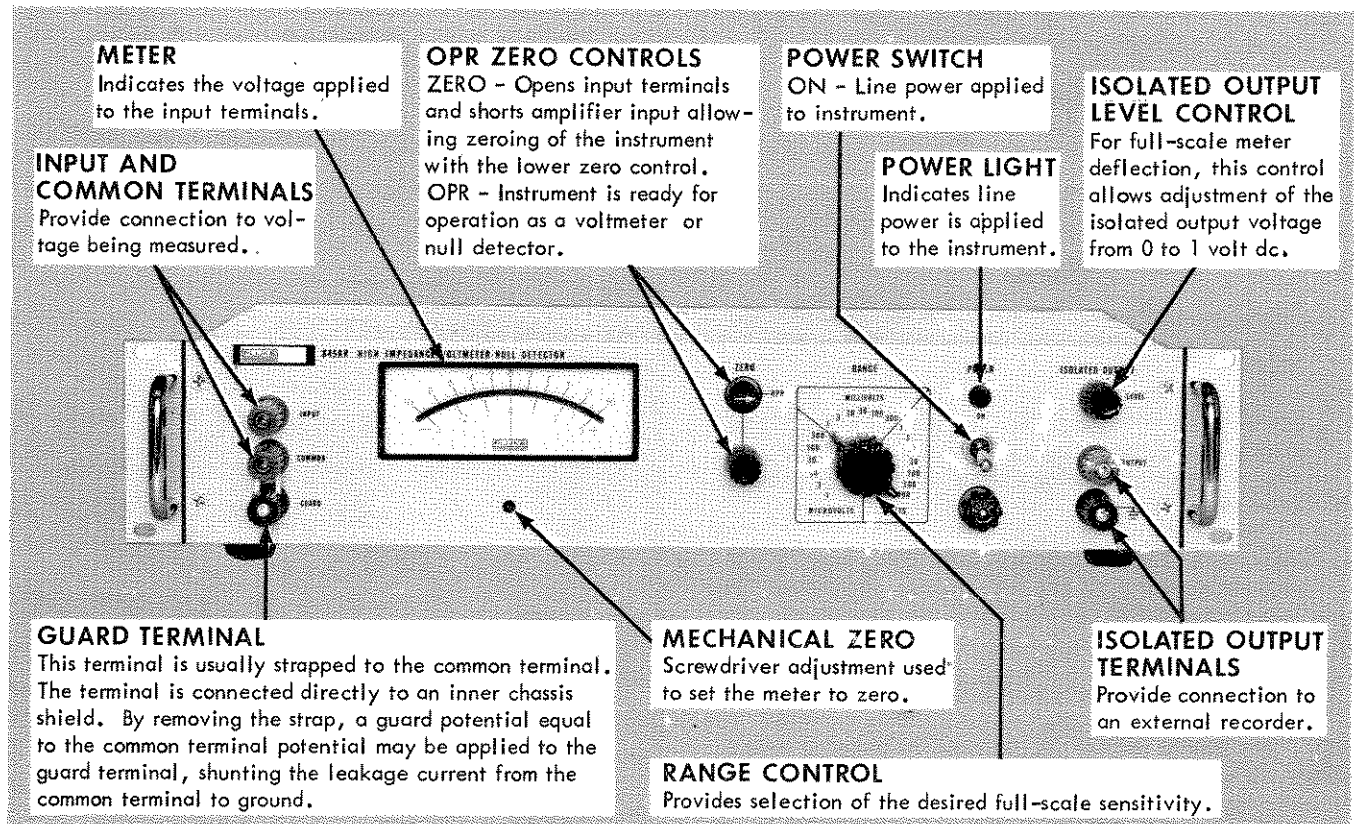

Figure 2-1. CONTROLS, TERMINALS, AND INDICATOR

- a. Place the Model 845AR controls as follows:

POWER	ON
RANGE	10 MICROVOLTS
OPR/ZERO	ZERO

- b. Adjust the zero control for an initial zero meter deflection. Place the RANGE switch to the 1 MICROVOLT RANGE and re-zero with the zero control.

2-7. MECHANICAL ZEROING

2-8. It may become necessary to adjust the mechanical zero control of the Model 845AR at more frequent intervals than complete calibration. To mechanically zero the instrument proceed as follows:

- Place the RANGE switch to 1000 VOLTS and the POWER switch to ON.
- Adjust the mechanical zero adjustment screw for zero meter deflection.
- Place the RANGE switch to 10 MICROVOLTS and electrically zero the instrument as outlined in paragraph 2-5.
- Repeat steps a and b.

2-9. OPERATION AS A HIGH IMPEDANCE VOLTMETER

2-10. To operate the Model 845AR as a High Impedance Voltmeter perform the preliminary operations according to paragraph 2-5 and proceed as follows:

- a. Place the controls as follows:

POWER	ON
OPR/ZERO	OPR
RANGE	1000 VOLTS

Note!

When measuring voltages in the microvolt ranges, use copper wire having low thermal EMF's.

- Connect the voltage to be measured to the Model 845AR INPUT terminal and connect the common point of the voltage being measured to the COMMON terminal.
- Deflection of the meter indicates the polarity and magnitude of the measured voltage. Increase the sensitivity of the Model 845AR for maximum on-scale deflection.

2-11. OPERATION AS A NULL DETECTOR

2-12. The Model 845AR may be used to monitor small voltage differences in bridge circuits, potentiometers, and other measuring apparatus. In most of these applications the circuits are adjusted for zero deflection or a null on the Model 845AR. Equipment connections for

various types of null detector configurations are illustrated by Figure 2-2 through 2-4. To operate the Model 845AR as a Null Detector, perform the preliminary operations according to paragraph 2-5 and proceed as follows:

- a. Select the desired equipment application as illustrated by Figure 2-2 through 2-4 and make the appropriate equipment connections.

- b. Place the Model 845AR controls as follows:

POWER	ON
OPR/ZERO	OPR
RANGE	as desired

- c. Adjust the circuit being measured for zero or a null deflection on the Model 845AR meter.

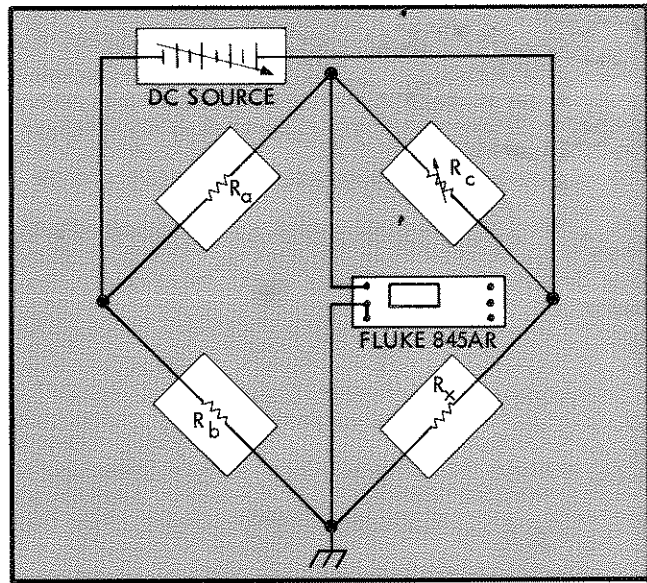

Figure 2-2. BRIDGE DETECTOR - FLOATING SUPPLY

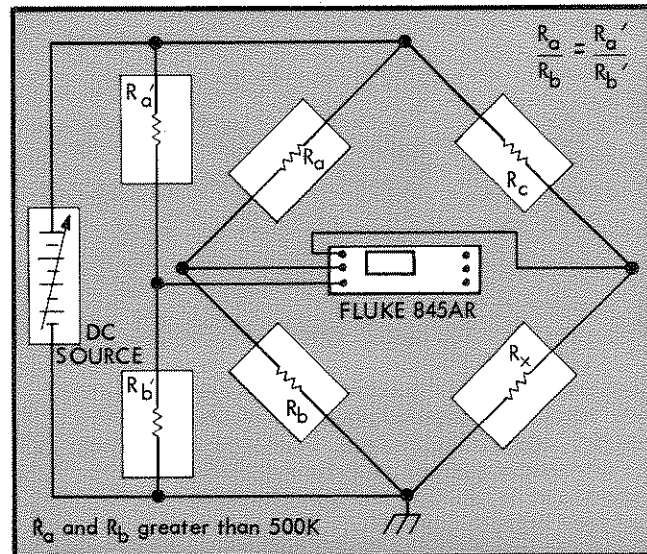

Figure 2-3. BRIDGE DETECTOR - HIGH RESISTANCE

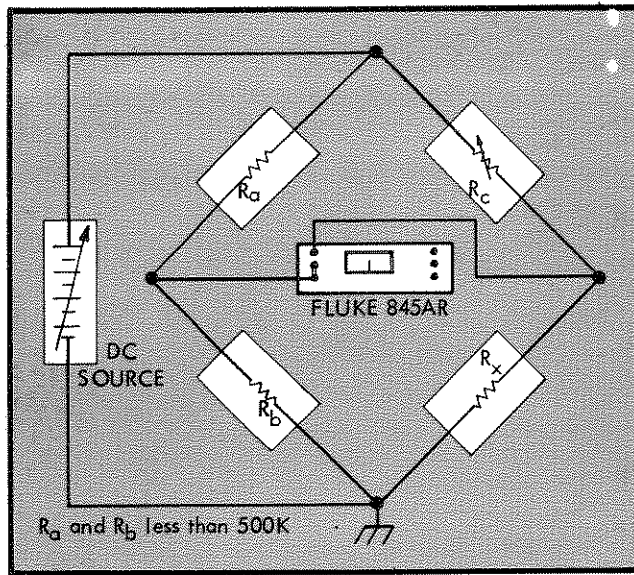

Figure 2-4. BRIDGE DETECTOR - FLOATING NULL DETECTOR

2-13. MEASURING VOLTAGES WITH A STANDARD CELL

2-14. The Model 845AR may be used with a voltage divider and a standard cell to calculate unknown voltages with a high degree of accuracy. Connect the equipment as illustrated in Figure 2-5. Perform the preliminary operation as outlined in paragraph 2-5 and proceed as follows:

- a. Place the Model 845AR controls as follows:

POWER	ON
OPR/ZERO	OPR
RANGE	as desired

- b. Adjust the voltage divider for zero or null deflection on the Model 845AR meter while placing the RANGE switch to successively more sensitive ranges.

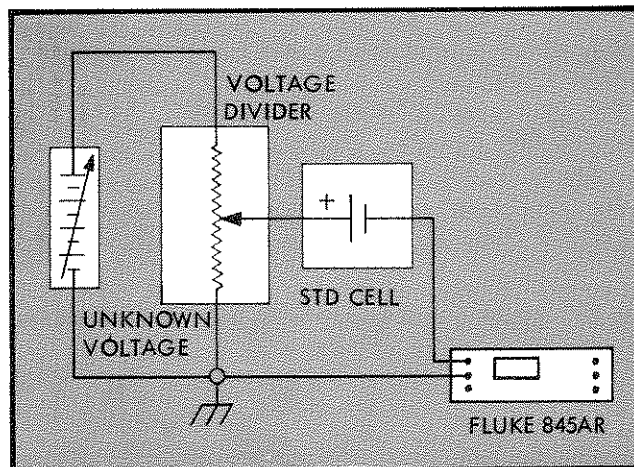

Figure 2-5. STANDARD CELL VOLTAGE MEASUREMENTS

- c. Calculate the unknown voltage by dividing the standard cell voltage by the final division ratio of the divider.

2-15. USE OF ISOLATED OUTPUT

2-16. DC ISOLATION AMPLIFIER

2-17. The Model 845AR may be used as a dc isolation amplifier having a voltage gain of up to 120 db, depending on the settings of the RANGE switch and the OUTPUT LEVEL control. To compute the maximum voltage gain on any range of the Model 845AR, use the following formula:

$$\text{Voltage gain in db} = 20 \log_{10} \frac{1 \text{ volt (maximum isolated output)}}{\text{Range (in volts)}}$$

2-18. RECORDER OUTPUT

2-19. The Model 845AR ISOLATED OUTPUT may be used to provide an output voltage, adjustable from zero to one volt for a full-scale meter deflection for use with a recorder. Since the output is isolated from the input, floating measurements can be made without the use of a floating recorder. To use the adjustable recorder output, proceed as follows:

- a. Connect the recorder to the ISOLATED OUTPUT terminals.

Note!

The lower ISOLATED OUTPUT terminal is connected to chassis ground. If a ground reference is undesirable, remove the jumper wire above R202 on the power supply circuit board. Refer to Figure 2-6 for jumper wire location.

- b. Turn the recorder on.
 c. Proceed as outlined in paragraph 2-9 or 2-11, as desired.
 d. Adjust the ISOLATED OUTPUT LEVEL control for the desired output to the recorder. This control has a log taper so that smooth control is possible at both high and low settings.

Note!

The ISOLATED OUTPUT current capability is 100 microamperes with a 5 kilohm source impedance.

2-20. OPERATING NOTES

2-21. SPURIOUS VOLTAGES AND CURRENTS

2-22. Voltage measurements at the microvolt level involve the persistent problems of thermoelectric effects. These effects may be compensated for by temporarily disconnecting the voltage from the circuit under measurement and noting the meter deflection of the

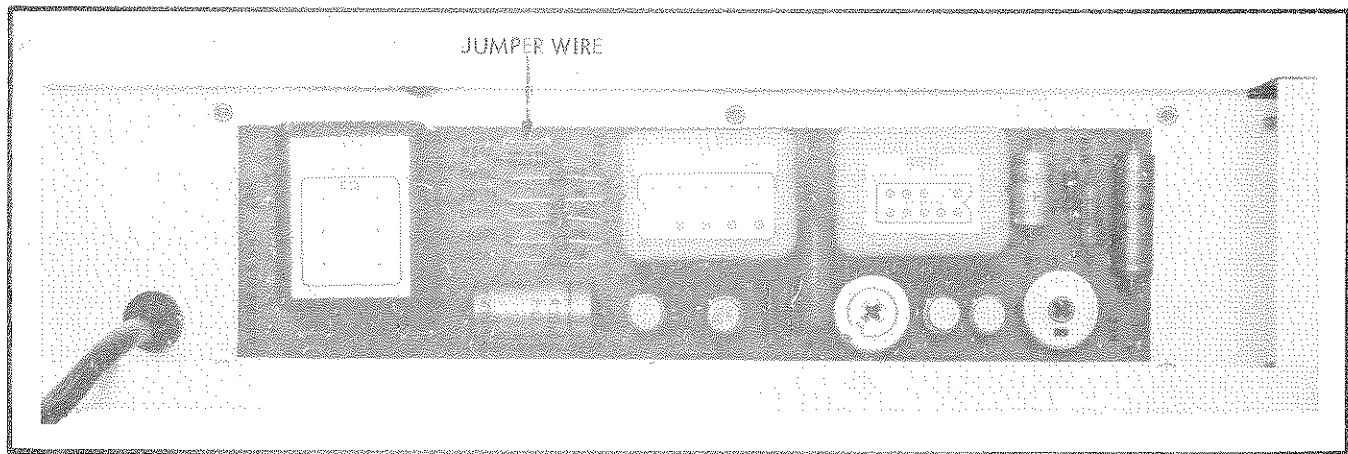

Figure 2-6. CHASSIS GROUND - JUMPER WIRE LOCATION

Model 845AR on the desired range. This reading must then be subtracted from all subsequent voltage measurements. A thorough understanding of these effects can lead to reducing or eliminating them completely.

2-23. THERMOELECTRIC VOLTAGES

2-24. If a circuit is composed of two dissimilar metals, a net voltage will result if the two dissimilar junctions are maintained at different temperatures. These thermoelectric voltages, also known as thermals, thermocouple voltages, or Seebeck voltages, can be reduced by using metals having low thermoelectric potentials, and keeping all junctions at the same temperature. The terminals of the Model 845AR are made of pure copper, gold-flashed to prevent tarnish. For lowest thermal voltages, all connections to the Model 845AR should be made with pure copper wire. Silver plated copper or solder coated copper also produce satisfactory results. Tinned copper is less satisfactory than silver plated or copper coated copper. Nickel and nickel-based alloys are not suitable for connections to the instrument. Excellent results can be obtained using ordinary TV twin lead, or even lamp cord if high insulation resistance is not required. If shielding is necessary, use a length of flat braid over the cable.

2-25. HIGH SOURCE IMPEDANCE

2-26. Due to the very high input resistance and extreme sensitivity of the Model 845AR, it is charge sensitive. Thus, a person's body potential, an electrostatic voltage, can cause charge redistribution at the input to the instrument and result in meter needle deflection as a hand approaches the input terminals. Careful shielding will eliminate this problem. Also, due to charges that may be deposited on the input terminals when the OPR-ZERO switch is set to ZERO, an appreciable transient will result when the switch is set to OPR if nothing is connected to the input terminals. Turning the switch back and forth will dissipate this charge, eliminating the problem. With a high source impedances, the response of the instrument is unavoidably slow due to the low pass filter used to suppress superimposed noise. However, the design of the low pass filter is such that common mode rejection is extremely high while the response time for the normally encountered low source impedances is very fast.

2-4

2-27. OVERLOAD VOLTAGES

2-28. The instrument is designed to withstand up to 1100 volts dc or 1100 volts peak ac continuously applied between any two of the three input terminals or between cabinet ground and any of the three input terminals regardless of the setting of the RANGE or OPR-ZERO switch. However, repeated or continuous overloads above 200 volts in the ranges below 3 millivolts will result in dissipation in protective, low-pass-filter resistor R110. This will result in thermal voltages which may take several minutes to subside after the overload is removed.

2-29. GUARDING

2-30. The instrument has an inner chassis connected to the GUARD terminal on the front panel. Ordinarily, this GUARD terminal is strapped to the COMMON terminal. When connected in this way the inner chassis serves as a shield. This greatly improves the leakage resistance to ground and the common mode rejection. However, since the inner chassis is available at the GUARD terminal, it may be driven at the same voltage as the COMMON terminal. This further increases the leakage resistance and common mode rejection by about ten times. The voltage used to drive the GUARD terminal should be obtained from a separate source or by means of a voltage divider connected directly across the source so that the leakage currents do not cause voltage drops across impedances in the circuit under measurement.

2-31. INCREASING INPUT RESISTANCE

2-32. In the 1 microvolt to 1 millivolt ranges, a 10^{10} megohm resistor is connected directly across the input of the instrument. The input resistance may be increased on these ranges by disconnecting the 10^{10} megohm resistor where it attaches to the RANGE switch. However, the input resistance will no longer be well defined. Typical input resistances with the 10^{10} megohm resistor removed are as follows:

Range	Input Resistance
1 uv	300 megohms
3 uv	1,000 megohms
10 uv	3,000 megohms
30 uv to 1 mv	10,000 megohms

PAR
19/3/82

SECTION III

THEORY OF OPERATION

3-1. INTRODUCTION

3-2. The Model 845AR High Impedance Voltmeter-Null Detector theory of operation is contained in this section of the manual. A block diagram is illustrated in Figure 3-1, and a functional schematic diagram is located at the end of Section V. The block diagram and functional schematic diagram are to be used as an aid in understanding circuit theory, and in troubleshooting.

3-3. BLOCK DIAGRAM ANALYSIS

3-4. The Model 845AR is a photo-chopper stabilized amplifier with the overall gain of the amplifier being

precisely controlled by negative feedback. The instrument's main circuits are an input range divider, a photocell modulator, an ac amplifier, a synchronous demodulator, a dc amplifier, a meter, an isolation converter, a neon drive, an 84 Hz multivibrator, a supply rectifier, and a rectifier filter.

3-5. The input range divider provides a fixed input impedance to signals of less than 1 millivolt while allowing reduction of input signals above 1 millivolt. Photochoppers modulate the input signal to the ac amplifier at 84 Hz. The drive signal for the photo modulator is provided by the neon drive which is composed of neon lamps driven alternately at 84 Hz by the 84 Hz

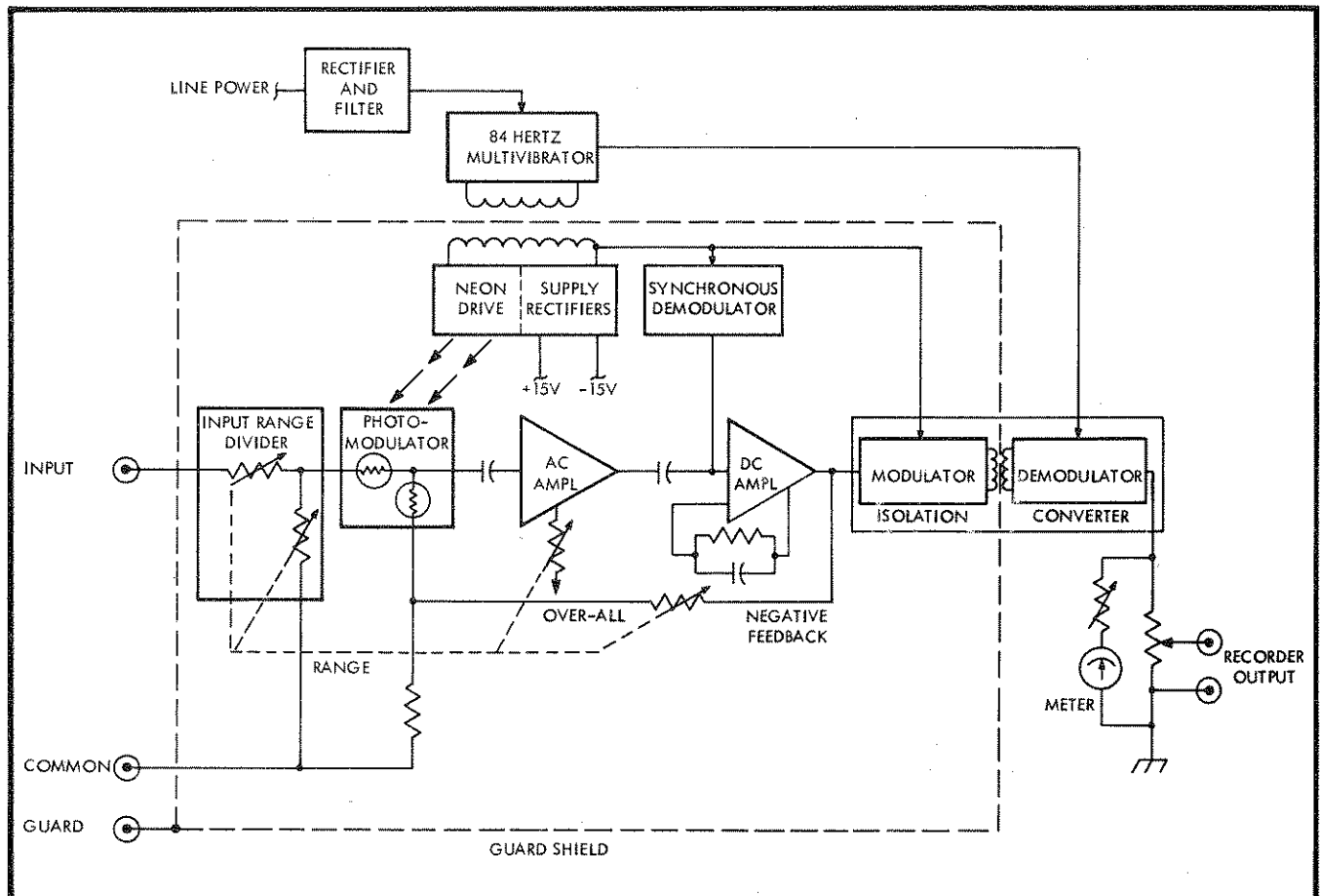

Figure 3-1. MODEL 845AR BLOCK DIAGRAM

DRS 10/12/66

multivibrator. Eighty four Hz is used to provide the Model 845 with an operating frequency asynchronous with the power line frequency and its harmonics. The 84 Hz multivibrator also drives the following circuits; (1) the supply rectifiers which provide operating voltages for the amplifiers, (2) the synchronous demodulator which demodulates the amplified ^{ac} dc signal, (3) the isolation converter which produces the meter and isolated recorder output. The entire amplifier and the secondaries of both transformers are surrounded by a guard shield which permits the use of external guard voltages.

3-6. The ac amplifier is a high impedance amplifier whose gain is controlled by the resistance selected by the RANGE control. The amplified ^{ac} dc signal is then detected by the synchronous demodulator.

3-7. The synchronous demodulator is driven by the 84 Hz reference signal and detects the amplified ^{ac} dc signal. The detected ^{ac} dc signal is then amplified by a dc amplifier whose gain is controlled by fixed feedback. The output signal of the dc amplifier is applied to the isolation converter which drives the isolated recorder output, and the meter which indicate the polarity and magnitude of the measured voltage. This same ^{ac} dc signal is also fed back to the input of the ac amplifier to control overall amplifier gain. The feedback ratio is determined by the setting of the RANGE control and allows overall amplifier gain to be precisely controlled.

3-8. CIRCUIT DESCRIPTION

3-9. POWER SUPPLY

3-10. Input power transformer T201 receives 115 volts ac, or 230 volts ac if the instrument is so wired, through the power switch, S1. The primary winding of T201 is constructed in such a manner as to utilize either 115 volts ac input, windings parallel, or 230 volts ac, windings in series. Fuse, F1, protects the Model 845AR circuitry from overloads.

3-11. The secondary voltage of T201 is rectified by bridge rectifier CR201 through CR204. The bridge rectifier output voltage is filtered by C201 and regulated by zener CR207. This regulated output voltage is used as the operating voltage for the 84 Hz multivibrator.

3-12. The 84 Hz multivibrator is used to provide synchronous drive voltages and dc operating voltages for the Model 845AR amplifier circuits free from any power line frequency variations and harmonics. The multivibrator is a transformer-coupled free running multivibrator composed of transistors Q201 and Q202, transformer T202, and frequency determining components C203 and R206 through R208. Variable resistor R206 is used to adjust the frequency of the multivibrator to 84 Hz. The voltage at the secondary of T202 is rectified by CR104 and CR105 to produce the positive and negative 15 volt dc operating voltages for the amplifier circuits. The same winding furnishes the synchronous demodulator and isolation converter drive signals and is tapped at a higher voltage level to drive the neon lamps DS101 and DS102. These neon lamps provide the drive signal for the photocell modulators V101 and V102.

3-2

3-13. INPUT DIVIDER

3-14. The basic full-scale sensitivity of the Model 845AR is limited to a maximum of 1 millivolt. Therefore, input signals above this value must be reduced. The input divider consists of R101 through R109 and RANGE switch S101A. On ranges being a multiple of 1, input voltages above 1 millivolt are divided down to 1 millivolt or less, upon selection of the proper range. On ranges being a multiple of 3, input voltages above 1 millivolt are divided down to 300 microvolts or less, upon selection of the proper range. On ranges of 1 millivolt and below, a 10 megohm resistor, R104, is connected across the input to provide a fixed value of input impedance.

3-15. AC AMPLIFIER

3-16. The input signal from the input divider is filtered by a three stage, low-pass filter composed of R110, C101, R111, C102, R112, and C103. This filter reduces any ac voltage having a frequency above 1 Hz. The filtered dc voltage is then square-wave modulated by photocell modulators V101 and V102, which are driven by DS101 and DS102. The resulting square-wave signal is coupled through C104 and amplified by Q101, Q102, and Q103 which form a three stage amplifier having a high input impedance. The gain of the ac amplifier is controlled by the common emitter resistance selected by the RANGE switch S101B. Maximum gain is used on the 1, 3, 10, and 30 microvolt ranges and is gradually reduced by the selection of R124 through R126 as the range is increased. The output of Q103 is capacitively coupled to a two stage current amplifier composed of Q104 and Q105. The current amplifiers have a constant gain controlled by fixed negative feedback through R130 and C111.

3-18. SYNCHRONOUS DEMODULATOR

3-19. The synchronous demodulator detects the magnitude and phase of the amplified signal. The 84 Hz drive signal is applied to the base of transistor Q106 which references the synchronous demodulator to the same phase as the photocell modulator. The demodulated signal is filtered by R134 and C114 before being applied to the dc amplifier.

3-20. DC AMPLIFIER

3-21. The dc amplifier amplifies the detected dc signal from the synchronous demodulator. Transistors Q107 through Q112 comprise a two-stage differential amplifier with a complementary emitter-follower output. Negative feedback through R149 and C116 is applied to the base of Q108 and controls the dc amplifier gain. The output from the common emitter of Q111 and Q112 is one volt dc for a full range input on any range, which drives the isolation converter. Overall negative feedback through the resistive network of R138 through R142 and R114 is controlled by the position of the RANGE switch S101C. This negative feedback allows precise control of the overall gain of the Model 845AR amplifiers.

3-22. ISOLATION CONVERTER

3-23. The isolation converter drives the recorder output and meter while providing isolation from the Model 845 amplifier circuitry. The output signal from the amplifier is applied to the transistors Q113 and Q114. An 84 Hz reference drive signal is applied to the bases of transistors Q113 and Q114 which causes modulation of the dc input signal to occur. The resulting modulated

signal is coupled to the secondary of T203 where transistors Q203 and Q204 demodulate secondary signals occurring at their 84 Hz base signal rate. Capacitor C204 charges to the peak of the demodulated signal and discharges through the OUTPUT LEVEL control R1, R211 through R213, and the meter M1. The meter M1 indicates the polarity and magnitude of the input voltage. Capacitor C3 and resistor R2 filter the resulting dc output voltage for the recorder output.

Free Manuals Download Website

<http://myh66.com>

<http://usermanuals.us>

<http://www.somanuals.com>

<http://www.4manuals.cc>

<http://www.manual-lib.com>

<http://www.404manual.com>

<http://www.luxmanual.com>

<http://aubethermostatmanual.com>

Golf course search by state

<http://golfingnear.com>

Email search by domain

<http://emailbydomain.com>

Auto manuals search

<http://auto.somanuals.com>

TV manuals search

<http://tv.somanuals.com>