

2765003

327233 G-3 S-4

# 341A/343A

## DC Voltage Calibrators

Instruction Manual

P/N 293951  
June 1969



# WARRANTY

Notwithstanding any provision of any agreement the following warranty is exclusive:

The JOHN FLUKE MFG. CO., INC., warrants each instrument it manufactures to be free from defects in material and workmanship under normal use and service for the period of 1-year from date of purchase. This warranty extends only to the original purchaser. This warranty shall not apply to fuses, disposable batteries (rechargeable type batteries are warranted for 90-days), or any product or parts which have been subject to misuse, neglect, accident, or abnormal conditions of operations.

In the event of failure of a product covered by this warranty, John Fluke Mfg. Co., Inc., will repair and calibrate an instrument returned to an authorized Service Facility within 1 year of the original purchase; provided the warrantor's examination discloses to its satisfaction that the product was defective. The warrantor may, at its option, replace the product in lieu of repair. With regard to any instrument returned within 1 year of the original purchase, said repairs or replacement will be made without charge. If the failure has been caused by misuse, neglect, accident, or abnormal conditions of operations, repairs will be billed at a nominal cost. In such case, an estimate will be submitted before work is started, if requested.

THE FOREGOING WARRANTY IS IN LIEU OF ALL OTHER WARRANTIES, EXPRESS OR IMPLIED, INCLUDING BUT NOT LIMITED TO ANY IMPLIED WARRANTY OF MERCHANTABILITY, FITNESS, OR ADEQUACY FOR ANY PARTICULAR PURPOSE OR USE. JOHN FLUKE MFG. CO., INC., SHALL NOT BE LIABLE FOR ANY SPECIAL, INCIDENTAL, OR CONSEQUENTIAL DAMAGES, WHETHER IN CONTRACT, TORT, OR OTHERWISE.

**If any failure occurs, the following steps should be taken:**

1. Notify the JOHN FLUKE MFG. CO., INC., or nearest Service facility, giving full details of the difficulty, and include the model number, type number, and serial number. On receipt of this information, service data, or shipping instructions will be forwarded to you.
2. On receipt of the shipping instructions, forward the instrument, transportation prepaid. Repairs will be made at the Service Facility and the instrument returned, transportation prepaid.

## **SHIPPING TO MANUFACTURER FOR REPAIR OR ADJUSTMENT**

All shipments of JOHN FLUKE MFG. CO., INC., instruments should be made via United Parcel Service or "Best Way" prepaid. The instrument should be shipped in the original packing carton; or if it is not available, use any suitable container that is rigid and of adequate size. If a substitute container is used, the instrument should be wrapped in paper and surrounded with at least four inches of excelsior or similar shock-absorbing material.

## **CLAIM FOR DAMAGE IN SHIPMENT TO ORIGINAL PURCHASER**

The instrument should be thoroughly inspected immediately upon original delivery to purchaser. All material in the container should be checked against the enclosed packing list. The manufacturer will not be responsible for shortages against the packing sheet unless notified immediately. If the instrument is damaged in any way, a claim should be filed with the carrier immediately. (To obtain a quotation to repair shipment damage, contact the nearest Fluke Technical Center.) Final claim and negotiations with the carrier must be completed by the customer.

The JOHN FLUKE MFG. CO., INC., will be happy to answer all applications or use questions, which will enhance your use of this instrument. Please address your requests or correspondence to: JOHN FLUKE MFG. CO., INC., P.O. BOX 43210, MOUNTLAKE TERRACE, WASHINGTON 98043, ATTN: Sales Dept. For European Customers: Fluke (Holland) B.V., P.O. Box 5053, 5004 EB, Tilburg, The Netherlands.

\*For European customers, Air Freight prepaid.

**John Fluke Mfg. Co., Inc., P.O. Box 43210, Mountlake Terrace, Washington 98043**

Rev. 4/80

# TABLE OF CONTENTS

Section	Title	Page
<b>I</b>	<b>INTRODUCTION AND SPECIFICATIONS</b>	<b>1-1</b>
1-1.	Introduction	1-1
1-5.	Electrical Specifications	1-1
1-6.	Environmental Specifications	1-2
1-7.	Mechanical Specifications	1-3
1-8.	General Specifications	1-3
<b>II</b>	<b>OPERATING INSTRUCTIONS</b>	<b>2-1</b>
2-1.	Introduction	2-1
2-4.	Operating Features	2-1
2-6.	Controls, Terminals and Indicators	2-1
2-8.	Input Power Requirements	2-1
2-10.	Preliminary Operation	2-1
2-12.	AC Line Connections	2-1
2-14.	Sense Connections	2-1
2-18.	Current Limit Operation	2-5
2-20.	Overload Protection	2-5
2-23.	Mechanical Zero Adjustment	2-5
2-25.	Operation as a Voltage Calibrator	2-5
2-27.	Applications	2-6
2-29.	Operation as a Differential Voltmeter	2-6
2-31.	Operation as a 10 ppm Source	2-6
<b>III</b>	<b>THEORY OF OPERATION</b>	<b>3-1</b>
3-1.	Introduction	3-1
3-3.	Block Diagram Analysis	3-1
3-12.	Circuit Analysis	3-3
3-13.	+15 Volt Reference and Auxiliary Supplies	3-3
3-16.	Chopper-Stabilized Amplifier	3-3
3-20.	Series Regulator	3-3
3-23.	Controlled Current Limiter	3-4
3-27.	Negative Voltage Limiter	3-4
3-29.	Sink Supply and Crowbar	3-4
3-34.	Control Circuit	3-5
3-38.	High Voltage Power Supply	3-6
3-40.	Meter Circuit	3-6
3-42.	Beta String	3-6

(continued on page ii)

TABLE OF CONTENTS, *continued*

Section	Title	Page
IV	MAINTENANCE .....	4-1
4-1.	Introduction .....	4-1
4-3.	Service Information .....	4-1
4-6.	Test Equipment .....	4-1
4-8.	General Maintenance .....	4-1
4-9.	Maintenance Access .....	4-1
4-13.	Adjustment Locations .....	4-3
4-15.	Cleaning .....	4-4
4-18.	115/230 Volt Conversion .....	4-5
4-20.	Fuse Replacement .....	4-5
4-22.	Lamp Replacement .....	4-5
4-24.	Performance Tests .....	4-6
4-26.	Line Regulation .....	4-6
4-28.	Load Regulation .....	4-6
4-30.	Ripple .....	4-7
4-32.	Output Voltage Accuracy .....	4-8
4-36.	Troubleshooting .....	4-8
4-39.	Test Point Resistance Check .....	4-8
4-41.	Standby Test .....	4-8
4-43.	Auxiliary Supply Voltages .....	4-9
4-45.	Power-On Test .....	4-10
4-47.	Chopper Amplifier .....	4-11
4-49.	Series Regulator .....	4-11
4-51.	Controlled Current Limiter .....	4-12
4-53.	Crowbar .....	4-12
4-55.	High Voltage Power Supply .....	4-12
4-57.	Beta String .....	4-13
4-59.	Panel Meter .....	4-13
4-61.	Model 341A Calibration .....	4-14
4-63.	Preliminary Operations .....	4-14
4-64.	Reference Voltage Adjustment .....	4-14
4-65.	Zero Output Adjustments .....	4-14
4-66.	Beta String Linearity Adjustments .....	4-14
4-67.	Range Adjustments .....	4-14
4-68.	Calibration Verification .....	4-15

*(continued on page iii)*

TABLE OF CONTENTS, *continued*

Section	Title	Page
4-70.	Model 343A Preliminary Calibration . . . . .	4-15
4-72.	Preliminary Operations . . . . .	4-15
4-73.	Reference Voltage Adjustment . . . . .	4-16
4-74.	Zero Output Adjustments . . . . .	4-16
4-75.	Beta String Linearity Adjustments . . . . .	4-16
4-76.	Temperature Stabilization . . . . .	4-17
4-77.	Model 343A Final Calibration . . . . .	4-17
4-79.	Zero Output Adjustments . . . . .	4-17
4-80.	Beta String Linearity Adjustments . . . . .	4-17
4-83.	Range Adjustments . . . . .	4-19
4-84.	Calibration Verifications . . . . .	4-20
<b>V</b>	<b>LIST OF REPLACEABLE PARTS . . . . .</b>	<b>5-1</b>
5-1.	Introduction . . . . .	5-1
5-3.	Column Description . . . . .	5-1
5-5.	How To Obtain Parts . . . . .	5-2
5-8.	List of Abbreviations . . . . .	5-2
5-9.	Serial Number Effectivity . . . . .	5-45
<b>7</b>	<b>GENERAL INFORMATION . . . . .</b>	<b>7-1</b>
<b>8</b>	<b>SCHEMATIC DIAGRAMS . . . . .</b>	<b>8-1</b>

## LIST OF ILLUSTRATIONS

Figure	Title	
Frontispiece	Model 341A and Model 343A DC Voltage Calibrators .....	vi
1-1.	Model 341A/343A Outline Drawing .....	1-3
2-1.	Controls, Terminals and Indicators (Sheet 1 of 2) .....	2-2
2-1.	Controls, Terminals and Indicators (Sheet 2 of 2) .....	2-3
2-2.	Nomograph of Voltage Drop in Load Wires .....	2-4
2-3.	Differential Voltmeter .....	2-6
2-4.	Operation as a 10 ppm Source .....	2-7
3-1.	Model 341A/343A Block Diagram .....	3-1
3-2.	Basic Instrument Circuitry .....	3-2
4-1.	Test and Calibration Equipment .....	4-2
4-2.	Model 341A Adjustment Locations .....	4-3
4-3.	Model 343A Adjustment Locations .....	4-4
4-4.	115/230 Volt Conversion .....	4-5
4-5.	Ripple Specifications .....	4-7
4-6.	Multivibrator Signal -- TP9 .....	4-10
4-7.	Chopper Amplifier Signal -- TP10 .....	4-11
4-8.	High Voltage Power Supply Output Voltages .....	4-13
4-9.	Beta String Switching Requirements .....	4-13
4-10.	341A Linearity Adjustments .....	4-15
4-11.	341A Output Voltage Requirements .....	4-15
4-12.	Model 343A Preliminary Linearity Adjustments (Sheet 1 of 2) .....	4-16
4-12.	Model 343A Preliminary Linearity Adjustments (Sheet 2 of 2) .....	4-17

*(continued on page v)*

LIST OF ILLUSTRATIONS, *continued*

Figure	Title	Page
4-13.	Beta String Linearity Test Setup . . . . .	4-17
4-14.	343A Linearity Adjustments - Deck B . . . . .	4-18
4-15.	343A Linearity Adjustments - Deck A . . . . .	4-18
4-16.	Range Adjustment and Calibration Verification Test Setup. . . . .	4-19
4-17.	Model 343A Output Voltage Requirements . . . . .	4-20
5-1.	341A DC Voltage Calibrator (Sheet 1 of 2) . . . . .	5-4
5-1.	341A DC Voltage Calibrator (Sheet 2 of 2) . . . . .	5-5
5-2.	Front Panel Assembly . . . . .	5-6
5-3.	Rear Panel Assembly (341A) . . . . .	5-7
5-4.	Main P/C Assembly (Left Hand Side) . . . . .	5-12
5-5.	Main P/C Assembly (Right Hand Side) . . . . .	5-13
5-6.	Reference P/C Assembly (341A) . . . . .	5-29
5-7.	Sample String P/C Assembly . . . . .	5-32
5-8.	343A DC Voltage Calibrator (Sheet 1 of 2) . . . . .	5-35
5-8.	343A DC Voltage Calibrator (Sheet 2 of 2) . . . . .	5-36
5-9.	Front Panel Assembly (343A) . . . . .	5-37
5-10.	Rear Panel Assembly (343A) . . . . .	5-38
5-11.	Reference P/C Assembly . . . . .	5-40
5-12.	Sample String P/C Assembly . . . . .	5-43

341A  
343A

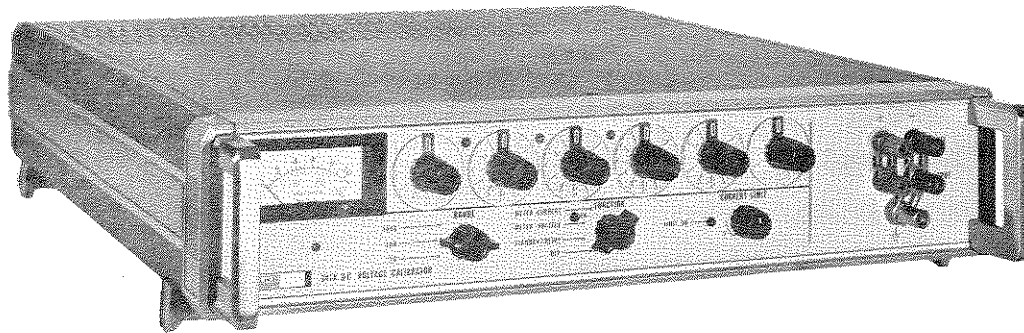

MODEL 341A

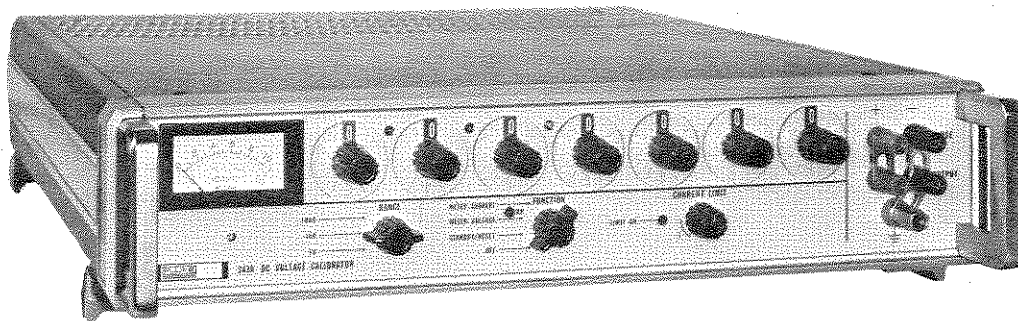

MODEL 343A

DC VOLTAGE CALIBRATORS



## SECTION I

# INTRODUCTION AND SPECIFICATIONS

### 1-1. INTRODUCTION

1-2. The Fluke Model 341A and Model 343A DC Voltage Calibrators provide dc voltages of 0 to 1100 volts in three ranges. Voltages are selected by eleven-position decade switches, which provide in-line, digital readout of the instrument output voltage. The Model 341A employs six-dial readout, with 1 ppm resolution, and the Model 343A employs seven-dial readout, with 0.1 ppm resolution.

1-3. A controlled current limiter, a fixed current limiter, and an electronic crowbar circuit provide protection against instrument malfunction and operator error. Output current or voltage, depending on function desired, are continuously monitored by a front panel meter.

1-4. The instruments are designed for rack-mount installation, using the mounting brackets supplied, and are equipped with resilient feet and tilt-down bail for field or bench use.

### 1-5. ELECTRICAL SPECIFICATIONS

#### OUTPUT VOLTAGE

Model 341A: 0 to 1111.110 volts dc  
Model 343A: 0 to 1111.1110 volts dc

#### VOLTAGE RANGES

Model 341A:  
Range (volts)      Output (volts)  
10                    0 to 11.11110 (10 uv steps)  
100                  0 to 111.1110 (100 uv steps)  
1000                0 to 1111.110 (1 mv steps)

#### Model 343A:

Range (volts)	Output (volts)
10	0 to 11.11110 (1 uv steps)
100	0 to 111.1110 (10 uv steps)
1000	0 to 1111.1110 (100 uv steps)

#### RESOLUTION

Model 341A:	1 ppm of range (10 uv maximum)
Model 343A:	0.1 ppm of range (1 uv maximum)

#### ACCURACY OF OUTPUT

*NOTE: The following accuracy specifications apply after (1 hour) warmup at standard reference conditions of 23°C ±5°C for the Model 341A and 23°C ±1°C for the Model 343A, up to 70% relative humidity, constant line voltage, and constant load.*

#### Model 341A:

Range	Accuracy (whichever is greater)
10 V	±0.01% of setting or ±0.0003% of range
100 V	±0.01% of setting or ±0.0002% of range
1000 V	±0.01% of setting or ±0.0002% of range

#### Model 343A:

Range	Accuracy (whichever is greater)
10 V	±0.003% of setting or ±0.0003% of range
100 V	±0.003% of setting or ±0.0001% of range
1000 V	±0.003% of setting or ±0.0001% of range

#### TEMPERATURE COEFFICIENT OF OUTPUT

Model 341A: Less than (5 ppm of setting +0.1 ppm of range +2 uv) per °C from +15° to +35°C. Less than (8 ppm of setting +0.1 ppm of range +2 uv) per °C from 0° to +50°C.

341A  
343A

**Model 343A:** Less than (3 ppm of setting +0.1 ppm of range +2 uv) per °C from +15° to +35°C. Less than (5 ppm of setting +0.1 ppm of range +2 uv) per °C from 0° to +50°C.

#### STABILITY OF OUTPUT

The following stability specifications apply at the standard reference conditions noted under ACCURACY OF OUTPUT:

##### Model 341A:

10V range (whichever is greater)  
±0.0007% of setting or 5 uv per hour  
±0.003% of setting or 15 uv per month

100V range (whichever is greater)  
±0.0007% of setting or 10 uv per hour  
±0.003% of setting or 25 uv per month

1000V range (whichever is greater)  
±0.0007% of setting or 20 uv per hour  
±0.003% of setting or 50 uv per month

##### Model 343A:

10V range (whichever is greater)  
±0.0005% of setting or 5 uv per hour  
±0.0015% of setting or 15 uv per month

100V range (whichever is greater)  
±0.0005% of setting or 10 uv per hour  
±0.0015% of setting or 25 uv per month

1000V range (whichever is greater)  
±0.0005% of setting or 20 uv per hour  
±0.0015% of setting or 50 uv per month

#### OUTPUT CURRENT

0 to 25 milliamps at any output voltage.

#### OVERCURRENT PROTECTION

Automatically limits output current at any present level between 1 and 25 milliamps via continuously variable front panel control. Panel lamp illuminates during limiting.

#### SHORT-CIRCUIT PROTECTION

At output voltage dial settings of 299.99X (299.999X on the Model 343A) or less, normal operation is restored upon removal of overload. At output voltage dial settings of 300.000 (300.0000 on the Model 343A) or above, the instrument trips to STANDBY when the output is short-circuited.

#### RIPPLE AND NOISE (all frequencies)

##### Model 341A:

60 Hz Line - Less than 100 uv rms or 1 mv p-p.  
400 Hz Line - Less than 100 uv rms or 2 mv p-p.

##### Model 343A:

60 Hz Line - Less than 50 uv rms or 400 uv p-p.  
400 Hz Line - Less than 100 uv rms or 2 mv p-p.

#### SETTLING TIME

**Model 341A:** Within 50 ppm of final output in 5 seconds.

**Model 343A:** Within 25 ppm of final output in 5 seconds.

#### LINE REGULATION

0.0005% of setting + 25 uv for a 10% line voltage change from nominal.

#### LOAD REGULATION

0.0005% of setting + 25 uv for a full load change.

#### ISOLATION

Either output terminal may be floated up to 500 volts dc from chassis ground.

#### REMOTE SENSE

Separate terminals are provided for sensing the output voltage directly at the load, thereby eliminating errors due to voltage drop in the instrument-to-load connecting wires.

#### WARM-UP TIME

**Model 341A:** Within 50 ppm of final output at turn-on.  
Within 15 ppm of final output in 30 minutes.

**Model 343A:** Within 25 ppm of final output at turn-on.  
Within 5 ppm of final output in 30 minutes.

#### INPUT POWER

115/230 volts ac ±10%, 50 to 440 Hz, single phase.  
Approximately 70 volt-amperes fully loaded.

## 1-6. ENVIRONMENTAL SPECIFICATIONS

#### TEMPERATURE RANGE

Operating: 0° to +50°C  
Storage: -40° to +65°C

#### RELATIVE HUMIDITY

0 to 70%

#### SHOCK

Withstands 15 g, 11 millisecond, half sine wave shock per MIL-T-21200.

**VIBRATION**

Withstands 10 Hz to 55 Hz, 4.5 g maximum per MIL-T-21200.

**ALTITUDE**

Up to 10,000 feet operating and 50,000 feet non-operating, per MIL-T-21200.

**1-7. MECHANICAL SPECIFICATIONS**

**SIZE**

3½ inches high by 17 inches wide by 18 inches deep.

**MOUNTING**

Mounting brackets provided for standard EIA 19-inch rack mount, and resilient feet provided for bench use. Tapped

holes also provided for attaching chassis slides. The instrument outline drawing is shown in Figure 1-1.

**WEIGHT**

23 pounds

**1-8. GENERAL SPECIFICATIONS**

**DESIGN**

Solid-state throughout

**FUSES**

Single-fused ac line and high voltage

**METER**

Monitors output voltage and current

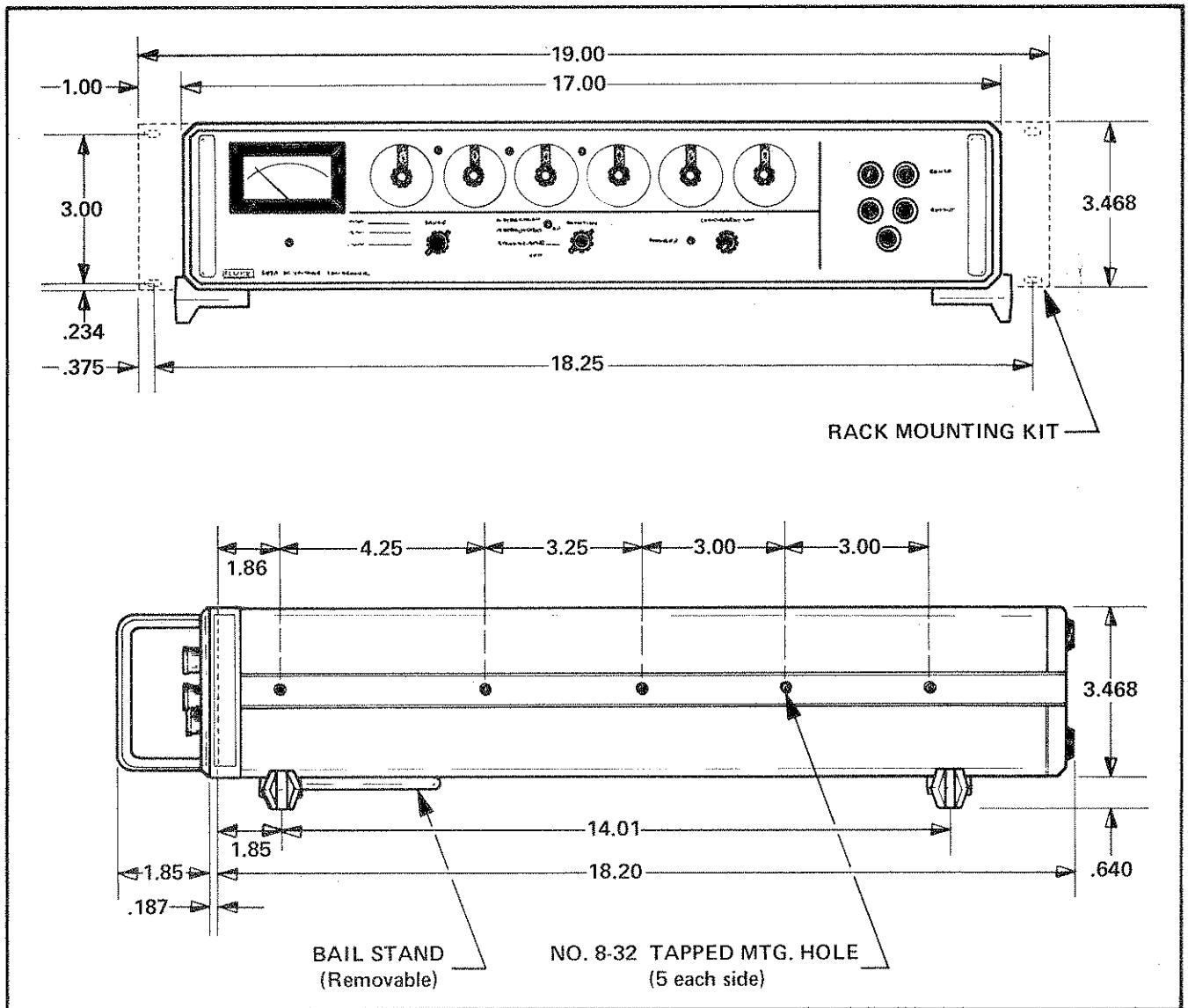

Figure 1-1. MODEL 341A/343A OUTLINE DRAWING



# static awareness



A Message From  
**John Fluke Mfg. Co., Inc.**

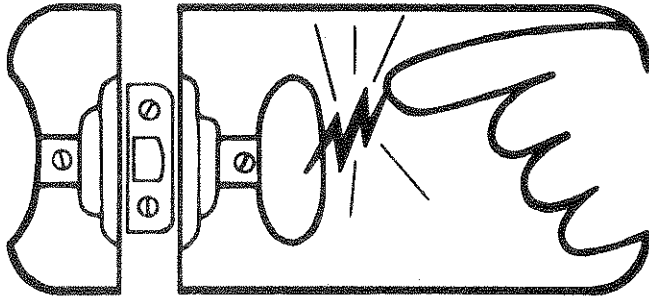

Some semiconductors and custom IC's can be damaged by electrostatic discharge during handling. This notice explains how you can minimize the chances of destroying such devices by:

1. Knowing that there is a problem.
2. Learning the guidelines for handling them.
3. Using the procedures, and packaging and bench techniques that are recommended.

The Static Sensitive (S.S.) devices are identified in the Fluke technical manual parts list with the symbol



The following practices should be followed to minimize damage to S.S. devices.

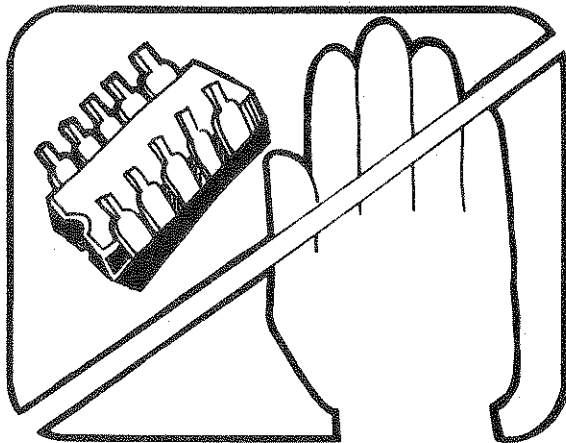

1. MINIMIZE HANDLING

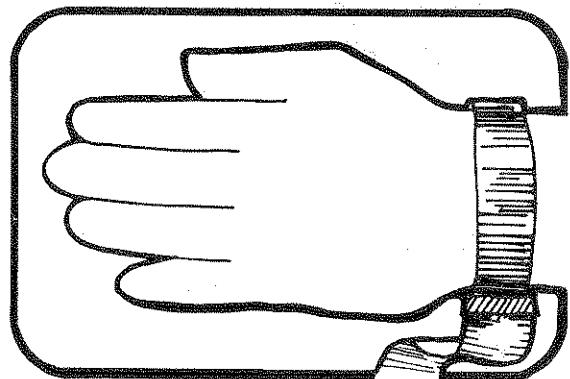

3. DISCHARGE PERSONAL STATIC BEFORE HANDLING DEVICES

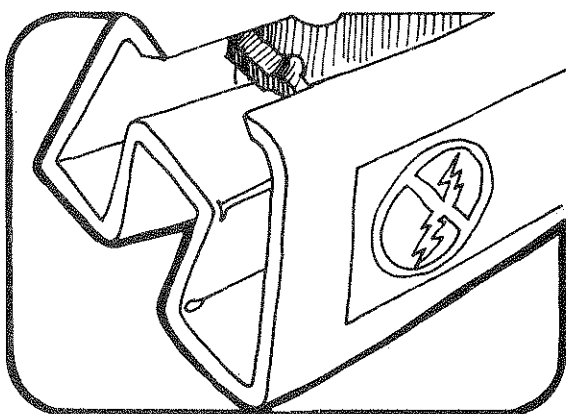

2. KEEP PARTS IN ORIGINAL CONTAINERS UNTIL READY FOR USE.

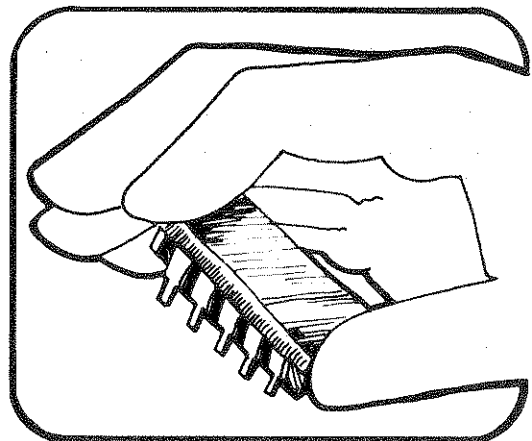

4. HANDLE S.S. DEVICES BY THE BODY

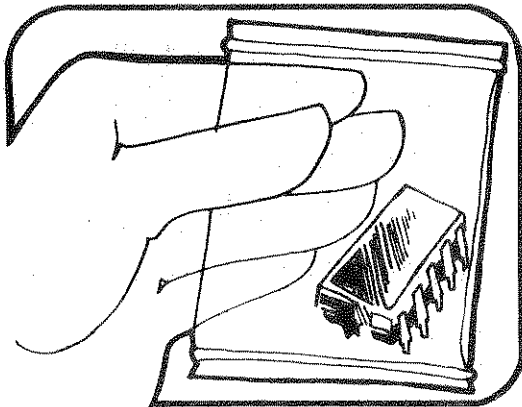

5. USE ANTI-STATIC CONTAINERS FOR HANDLING AND TRANSPORT

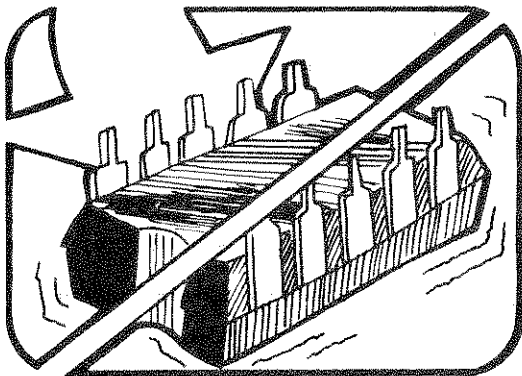

6. DO NOT SLIDE S.S. DEVICES OVER ANY SURFACE

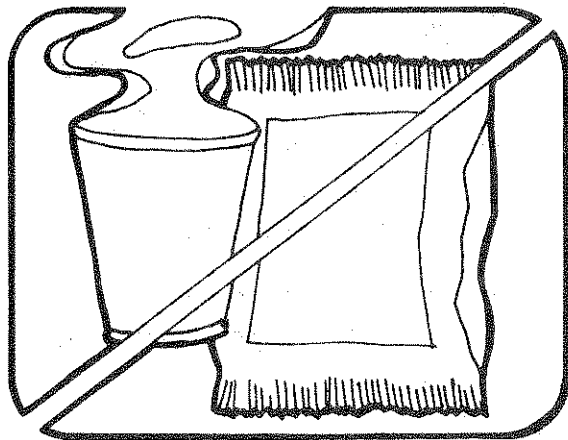

7. AVOID PLASTIC, VINYL AND STYROFOAM® IN WORK AREA

PORTIONS REPRINTED  
WITH PERMISSION FROM TEKTRONIX, INC.  
AND GENERAL DYNAMICS, POMONA DIV.

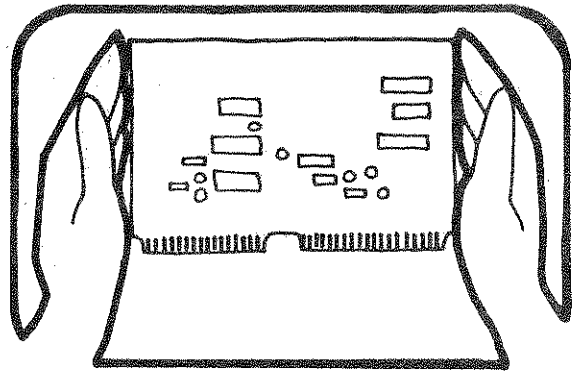

8. WHEN REMOVING PLUG-IN ASSEMBLIES, HANDLE ONLY BY NON-CONDUCTIVE EDGES AND NEVER TOUCH OPEN EDGE CONNECTOR EXCEPT AT STATIC-FREE WORK STATION. PLACING SHORTING STRIPS ON EDGE CONNECTOR USUALLY PROVIDES COMPLETE PROTECTION TO INSTALLED SS DEVICES.

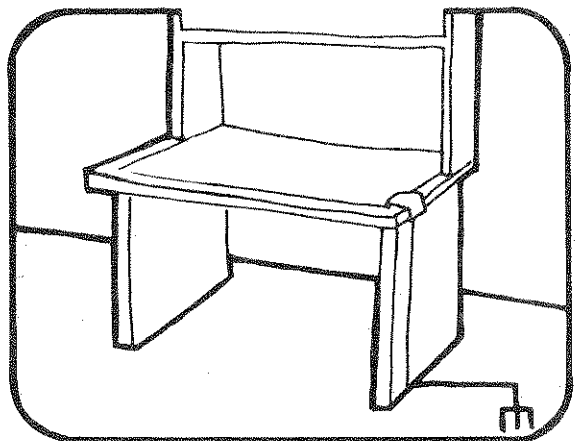

9. HANDLE S.S. DEVICES ONLY AT A STATIC-FREE WORK STATION  
10. ONLY ANTI-STATIC TYPE SOLDER-SUCKERS SHOULD BE USED.  
11. ONLY GROUNDED TIP SOLDERING IRONS SHOULD BE USED.

Anti-static bags, for storing S.S. devices or pcbs with these devices on them, can be ordered from the John Fluke Mfg. Co., Inc.. See section 5 in any Fluke technical manual for ordering instructions. Use the following part numbers when ordering these special bags.

John Fluke Part No.	Description
453522	6" X 8" Bag
453530	8" X 12" Bag
453548	16" X 24" Bag
454025	12" X 15" Bag
Pink Poly Sheet	Wrist Strap
30"x60"x60 Mil	P/N TL6-60
P/N RC-AS-1200	\$7.00
\$20.00	

## SECTION II

# OPERATING INSTRUCTIONS

### 2-1. INTRODUCTION

2-2. This section contains operating instructions and applications information for the Model 341A and Model 343A Voltage Calibrators. Unless otherwise specified, all instructions apply to both instruments.

2-3. If any problem is encountered in operating the instrument, contact the nearest John Fluke Sales Representative or write directly to the John Fluke Manufacturing Company. Please include the instrument serial number when writing.

### 2-4. OPERATING FEATURES

2-5. The following paragraphs describe instrument controls and power requirements.

### 2-6. CONTROLS, TERMINALS, AND INDICATORS

2-7. The name and function of the front and rear panel controls, terminals, and indicators are shown in Figure 2-1.

### 2-8. INPUT POWER REQUIREMENTS

2-9. The instrument operates on either 115 or 230 volt ac power, and is normally supplied with connections for 115 volt use. Dual primary windings in the power transformer permit ready conversion from one operating voltage to the other. The conversion procedure is described in section IV, paragraph 4-18.

### 2-10. PRELIMINARY OPERATION

2-11. The following paragraphs describe preliminary connections, control settings, adjustments and safety precautions, which should be observed before operating the instrument.

### 2-12. AC LINE CONNECTIONS

2-13. Connect the Model 341A/343A line plug to a 115 volt ac (or to 230 volts ac if the instrument is so wired), 50 to 440 Hz, single phase, three-wire outlet.

#### WARNING!

The round pin on the polarized three-prong plug connects the instrument case to power system ground. Verify that the ac outlet is provided with the earth ground wire normally found in a three wire single-phase connector. If the third wire is not present in the outlet or if a three-to-two-wire adapter is used, ensure that the instrument ground wire is connected to a high quality earth ground.

### 2-14. SENSE CONNECTIONS

2-15. When a load is connected to the Model 341A/343A, there may be an appreciable voltage drop between the instrument and the load due to the resistance of the connecting leads. The nomograph shown in Figure 2-2 can be used to determine the approximate voltage developed in the leads. If the voltage drop is excessive, the instrument can then be connected for remote sensing.

2-16. **Using The Nomograph.** With a straight edge, connect the point representing output current on scale 1 to the point representing the gauge of the connecting wires on scale 2. The voltage developed in the connecting wires, expressed in millivolts per foot, is read on scale 3. To determine the total voltage developed in the connecting leads, multiply the total length in feet by the value obtained from scale 3. For example, assume that two AWG

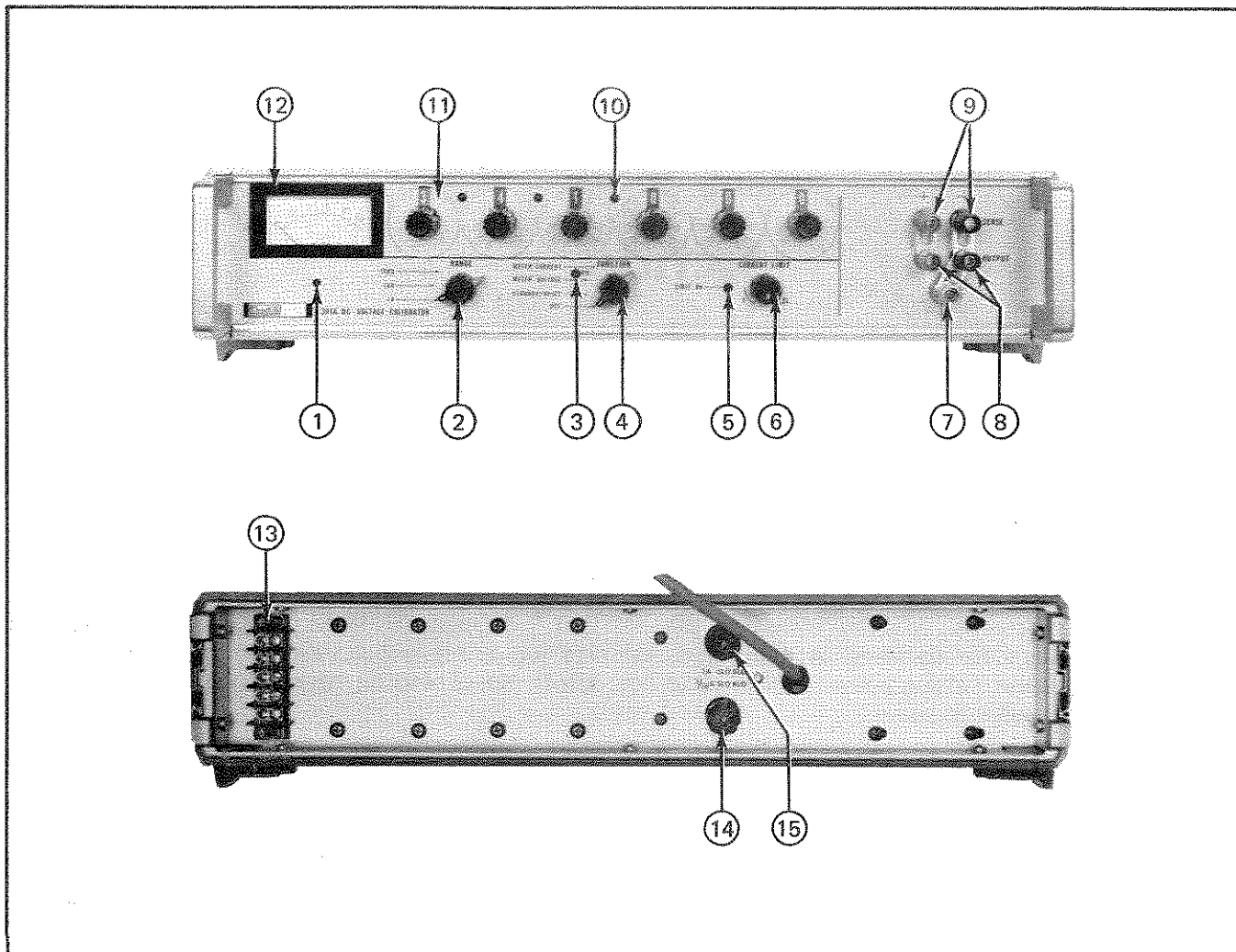

REF. NO.	NAME	FUNCTION
1	Mechanical zero adjust	Sets the meter mechanical zero. Adjust only after instrument has been turned off for at least 3 minutes.
2	RANGE switch	Selects one of three full-scale voltage ranges: 10, 100 or 1000 volts dc.
3	Power ON indicator	Illuminates when instrument is fully operable.
4	FUNCTION switch	Controls instrument input power and output monitoring functions. In STANDBY/RESET position, all circuitry except the high voltage power supply is energized. In power ON position, the instrument is fully operable. When instrument is ON, output voltage is monitored in METER VOLTAGE position and output current in METER CURRENT position.
5	LIMIT ON indicator	Illuminates when the controlled current limiter is activated. When lit, output current is limited to a preset value.

Figure 2-1. CONTROLS, TERMINALS AND INDICATORS (Sheet 1 of 2)

REF. NO.	NAME	FUNCTION
6	CURRENT LIMIT control	Sets operating point of controlled current limiter, which limits maximum output current to any value from zero to about 25 milliamps.
7	Ground Terminal	Connection for grounding either positive or negative OUTPUT terminal to power line ground.
8	OUTPUT terminals	Output voltage connections, with both terminal isolated from instrument case and power line ground. Terminals may be floated up to 500 volts dc from chassis.
9	SENSE terminals	Direct connection to instrument regulating circuitry. Connected to OUTPUT terminals or remote load to provide optimum load regulation.
10	Decimal lamps	Indicate location of decimal point for voltage dial readout, and are controlled by the RANGE switch.
11	Voltage dials	Six voltage dials (seven dials on the 343A) set output voltage and provide in-line digital readout from 0 to 1111.110 volts dc (0 to 1111.1110 volts dc for the Model 343A). A dial set to "X" (10) represents 0 with a carry of 1 to the left, thus 11.11110 would be dialed as <u>10</u> .XXXXX. NOTE: In dial readout notation, the underscore (10) denotes a single dial that is displaying two significant digits.
12	Meter	Indicates OUTPUT voltage or load current, depending on setting of FUNCTION switch. The meter voltage range corresponds to the setting of the RANGE switch. Voltage is indicated on a 0 to 10 scale, with 10% over-ranging. The meter current range is fixed at 0 to 30 milliamps. NOTE: Meter current includes beta string current. This introduces a small error, which is negligible on the 10 and 100 volt ranges; in the 1000 volt range, the error will be equal to + 1 milliamp.
13	Terminal strip	Provides output, sense, and ground connections for rack-mount installations. Standard on the Model 343A and option only on the Model 341A.
14	Fuse, high voltage	High voltage power supply output fuse, rated at 1/16 amp, slow blow.
15	Fuse, line	Power line fuse, 1 amp slow blow for 115 volts ac operation and 1/2 amp slow blow for 230 volts ac operation.

Figure 2-1. CONTROLS, TERMINALS AND INDICATORS (Sheet 2 of 2)

No. 28 wires, each 3 ft long, are used to connect a load, requiring 25 milliamps to the OUTPUT terminals of the Model 341A/343A. With a straight edge, connect the known current on scale 1 (25 ma) and the wire size on scale 2 (No. 28). The resulting IR drop on scale 3 is

approximately 1.65 millivolts per foot. Therefore, the connecting wires develop a total voltage of 12 millivolts ( $2 \times 3\text{ft} \times 1.65 \text{ mv/ft} = 9.9 \text{ mv}$ ), which is more than one and one-half times the published load regulation of the instrument at 1000 volts output. To compensate for this,



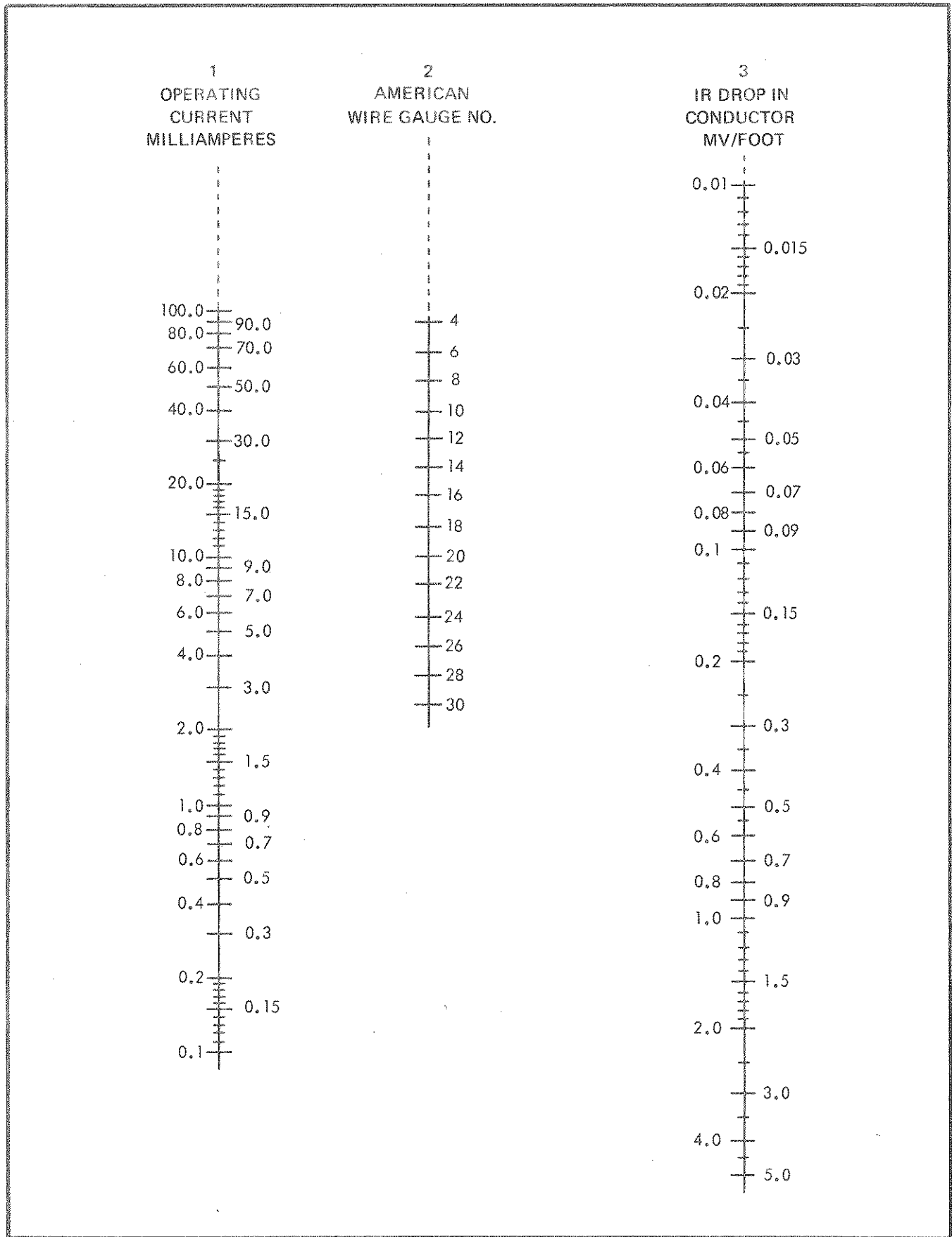

Figure 2-2. NOMOGRAPH OF VOLTAGE DROP IN LOAD WIRES

the Model 341A/343A is equipped with remote sensing, which maintains regulation at the load independent of lead length.

**2-17. Remote Sensing.** If the voltage developed in the load connecting leads is found to be excessive, proceed as follows:

- a. With the FUNCTION switch set to OFF or to STANDBY/RESET, remove the front-panel shorting links between the SENSE and OUTPUT terminals.
- b. Using a twisted pair of insulated wires, connect the + SENSE terminal to the positive side of the load, and connect the - SENSE terminal to the negative side of the load.

#### CAUTION!

Ensure that the SENSE terminals are connected to the load in the proper polarity. Incorrect connections will result in loss of regulation and possible damage to the instrument. When remote sensing is not used, the SENSE terminals must be connected to the OUTPUT terminals with the front-panel shorting links.

#### 2-18. CURRENT LIMIT OPERATION

**2-19.** The CURRENT LIMIT control sets the operating point of the controlled current limiter, which limits the instrument output current to any value between 1 and 25 milliamps. The approximate value of limiting current is indicated by a 1 to 25 scale circumscribed about the CURRENT LIMIT control on the front panel. If no current limiting is desired, set the CURRENT LIMIT control fully clockwise (25). In this position, maximum instrument output current is available at all voltage settings. If some degree of current limiting is desired, proceed as follows:

- a. Set the Model 341A/343A control as follows:

FUNCTION	STANDBY/RESET
RANGE	10
Voltage dials	1.00000 (Model 341A) 1.000000 (Model 343A)
CURRENT LIMIT	Fully clockwise

- b. Place a short across the + and - OUTPUT terminals.
- c. Set the FUNCTION switch to METER CURRENT.
- d. Set the output current limit by rotating the CURRENT LIMIT control counterclockwise until the panel meter indicates the desired limiting current.

- e. Set the FUNCTION switch to STANDBY/RESET and remove the short from across the OUTPUT terminals.

#### 2-20. OVERLOAD PROTECTION

**2-21.** The Model 341A/343A is automatically protected against current overload, and a continuous short circuit will in no way harm the unit. At output voltage dial settings of 299.99X (299.999X on the Model 343A) or less, the output voltage will return quickly upon removal of the overload. At voltage dial settings of 300.000 (300.0000 on the Model 343A) and above, a short circuit at the output will trip the instrument to STANDBY. Trip is evidenced by illumination of the CURRENT LIMIT lamp and extinction of the ON lamp. After the overload condition is corrected, the instrument may be reset by setting the FUNCTION switch to the STANDBY/RESET position momentarily and then back to ON.

**2-22.** Output voltages are fully controlled when downranging or switching to STANDBY. This is accomplished by a pair of crowbar relays, which discharge the high voltage filter capacitors in a series of steps. The action of the crowbar relays is very rapid and is audible to the user. When downranging from the 1000 volt range (500 to 1000 volt dial settings) to the 100 or 10 volt ranges, crowbar operation can be heard as a rattle as the switch position is changed. The crowbar circuit provides continuous protection as long as downranging is not excessive; however, if downranging occurs consistently at intervals less than 5 seconds, the instrument will automatically trip to STANDBY.

#### 2-23. MECHANICAL ZERO ADJUSTMENT

**2-24.** When necessary, mechanically zero the meter with the adjustment screw on the front panel. If the instrument has been operating, it must be turned off for at least 3 minutes prior to this adjustment.

#### 2-25. OPERATION AS A VOLTAGE CALIBRATOR

**2-26.** To use the Model 341A/343A as a voltage source, proceed as follows:

- a. Set the FUNCTION switch to STANDBY/RESET. Allow at least a 10-minute warm-up period if the instrument has just been energized.
- b. Connect the SENSE terminals to the OUTPUT terminals with the shorting links provided and connect the load. If remote sensing is desired, connect the SENSE terminals to the load as described in paragraph 2-17.

- c. Set the CURRENT LIMIT control fully clockwise (25) or to a predetermined value, using the procedure of paragraph 2-17.
- d. Set the RANGE switch and voltage dials to the value of the desired output voltage.
- e. Set the FUNCTION switch to ON.
- f. The output voltage delivered to the load will correspond to the voltage indicated on the voltage dials. To monitor output voltage or current, place the FUNCTION switch in either the METER VOLTAGE or METER CURRENT position.

## 2-27. APPLICATIONS

2-28. The Model 341A/343A Voltage Calibrators provide parameters of stability, accuracy, temperature coefficient and response required by a broad range of laboratory and production applications. The following paragraphs describe a method of using the instrument as a differential voltmeter and, in conjunction with a reference divider, as a precision voltage source with traceability to the National Bureau of Standards.

### 2-29. OPERATION AS A DIFFERENTIAL VOLTMETER

2-30. The Model 341A/343A can be used in combination with a null detector, such as the Fluke Model 845AB, as a differential voltmeter. Connection of the equipment for measurement of a positive voltage is shown in Figure 2-3. Proceed as follows:

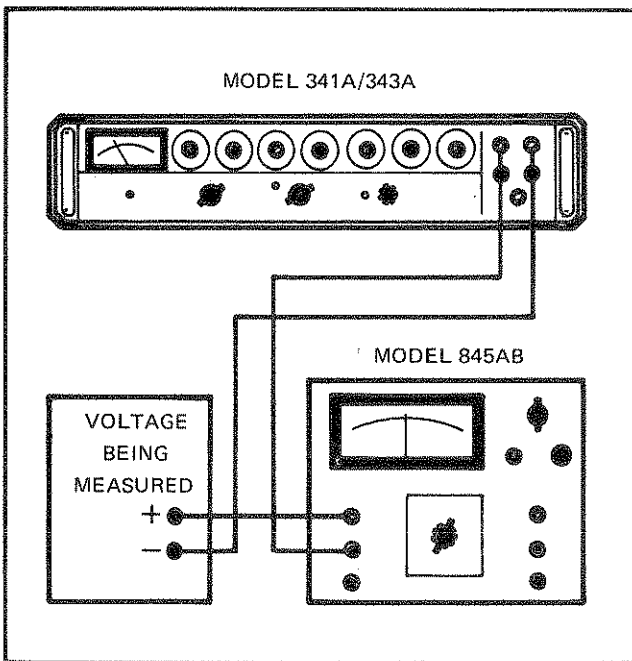

Figure 2-3. DIFFERENTIAL VOLTMETER

- a. Connect the null detector INPUT terminal to the positive terminal of the voltage to be measured, and connect the null detector COMMON terminal to the Model 341A/343A + OUTPUT terminal. Connect the Model 341A/343A - OUTPUT terminal to the negative side of the voltage being measured.

### WARNING!

To eliminate shock hazard, leave the ground terminals of the Model 341A/343A and null detector disconnected.

- b. Set the null detector voltage range and Model 341A/343A voltage dials to approximately the voltage being measured. If the voltage being measured is not known, set the null detector to the 1000 volt range initially.
- c. Set the Model 341A/343A FUNCTION switch to ON, and set the CURRENT LIMIT control as desired.
- d. Set the Model 341A/343A RANGE switch and voltage dials to the approximate voltage indicated by the null detector. The null detector should then indicate a null.
- e. Set the null detector for increased sensitivity, and adjust the voltage dials for zero deflection on the null detector.
- f. The value of the voltage being measured is indicated by the Model 341A/343A voltage dial setting at zero deflection of the null detector.
- g. To measure a negative voltage, reverse the connections at the Model 341A/343A OUTPUT terminals.

### 2-31. OPERATION AS A 10 PPM SOURCE

2-32. The Model 341A/343A together with a reference divider such as the Fluke Model 750A can provide voltages of 0.1, 0.5, 1, 1.1, 5, 10, 50, 100, 500, 1000, and 1100 volts dc, which have an accuracy of 10 ppm and are traceable to the National Bureau of Standards. Equipment connection is shown in Figure 2-4. Proceed as follows:

- a. Set the Model 750A input switch to RESET. Adjust the Model 341A/343A CURRENT LIMIT control for 2 milliamps, using the procedure of paragraph 2-18.
- b. Set the Model 341A/343A FUNCTION switch to STANDBY/RESET. Set the Model 750A standard cell voltage dials to the voltage of the standard cell.

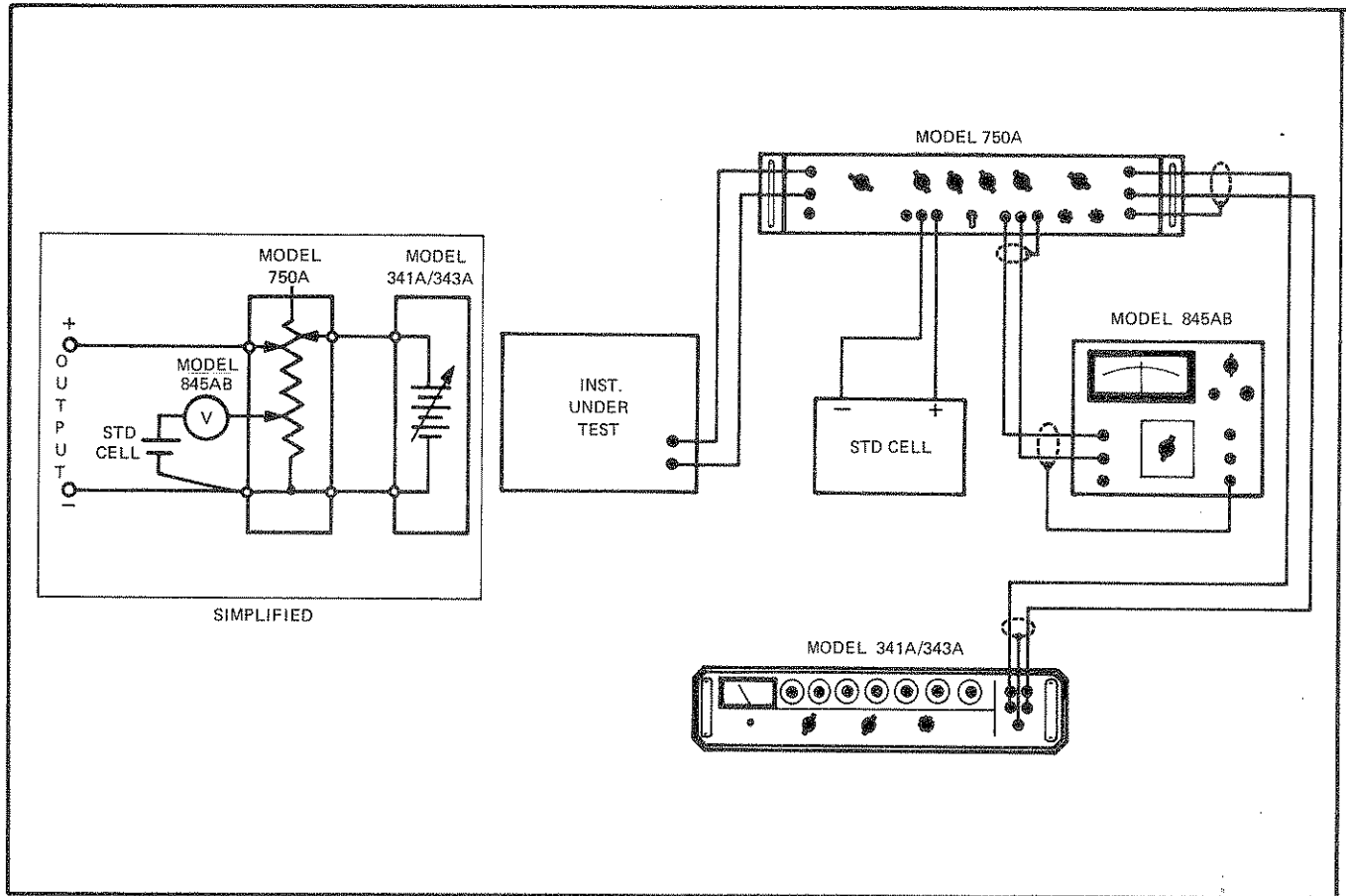

Figure 2-4. OPERATION AS A 10 PPM SOURCE

- c. Set the input voltage switch of the Model 750A as desired. Set the Model 341A/343A output to the same voltage.
- d. Set the Model 341A/343A FUNCTION switch to ON and set the Model 845AB for 100 microvolts sensitivity.
- e. Adjust the voltage dials of the Model 341A/343A and the coarse and fine dials of the Model 750A for a null on successively more sensitive null ranges of the Model 845AB. Final null should be on the 10 microvolt range.
- f. The output voltage of the Model 750A corresponds to the output voltage switch setting.

## SECTION III

### THEORY OF OPERATION

#### 3-1. INTRODUCTION

3-2. The following paragraphs describe the theory of operation of the Model 341A and 343A Voltage Calibrators. For the block diagram analysis, refer to the block diagram shown in Figure 3-1, and for the detailed circuit analysis, refer to the detailed circuit schematic at the end of Section V.

#### 3-3. BLOCK DIAGRAM ANALYSIS

3-4. The instrument circuitry is basically that of a high gain operational amplifier, as shown in Figure 3-2. The driving signal is generated in a precision voltage reference and applied through a range control network to the amplifier input. The series regulator, which is the output stage of the amplifier, provides the high voltage capability.

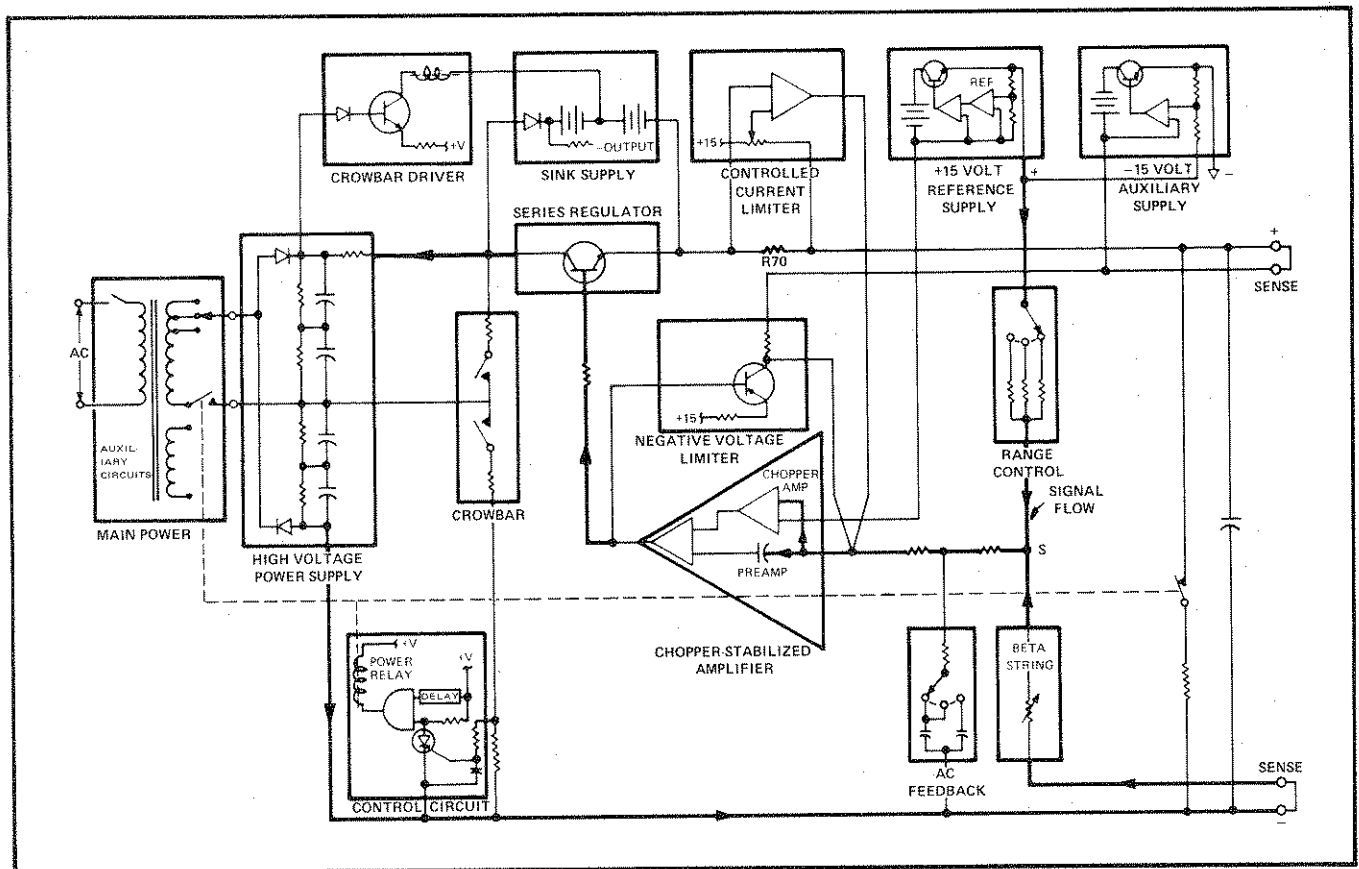

Figure 3-1. MODEL 341A/343A BLOCK DIAGRAM

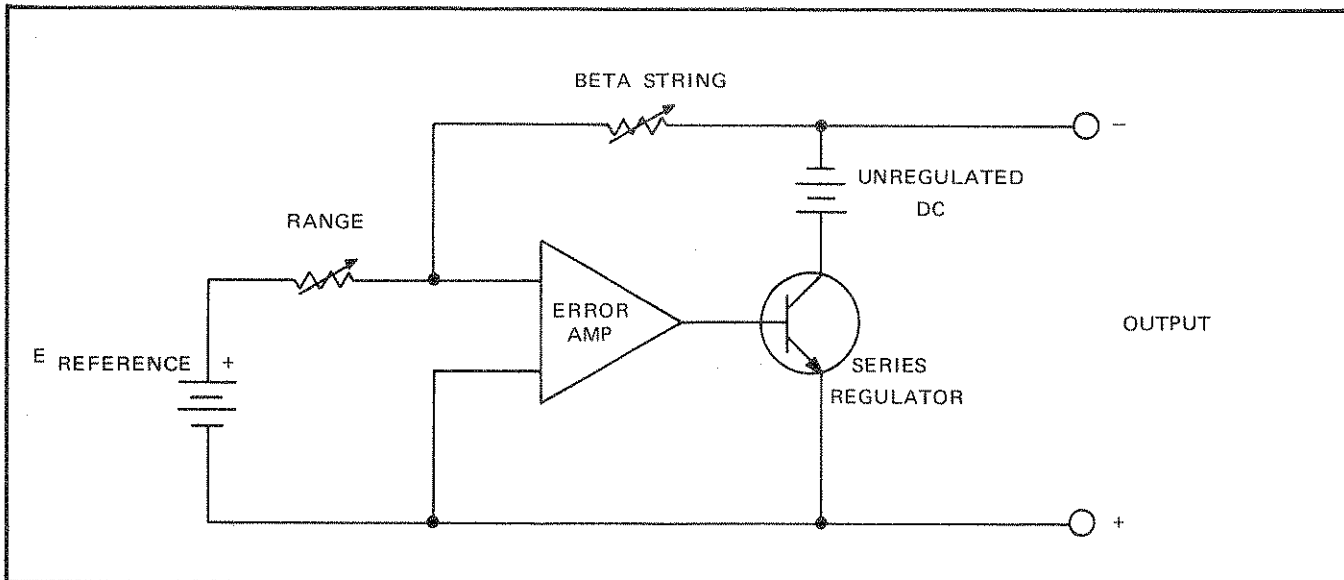

Figure 3-2. BASIC INSTRUMENT CIRCUITRY

Amplifier output is controlled by the range and beta string resistors, which control the input signal and the negative feedback.

3-5. The signal source is the +15 volt reference supply. A reference amplifier within the supply assures high stability with respect to time and temperature. An output current of 10 microamps, 100 microamps, or 1 milliamp for the 10 volt, 100 volts, and 1000 volt ranges respectively is selected by the range control switch. The resulting voltage at the summing junction S is applied to the input of the chopper-stabilized amplifier. The function of this amplifier is to control conduction of the series regulator so that the resulting voltage at S approaches zero. As shown on the signal flow line, signal current from the series regulator passes through the rectifier and filter and through the voltage control network into the summing junction, thereby completing the servo loop.

3-6. The chopper-stabilized amplifier consists of a chopper amplifier and a preamplifier. The chopper amplifier amplifies all frequencies from dc to approximately 30 Hz; the preamplifier is used principally for frequencies from 30 to approximately 500 kHz.

3-7. The controlled current limiter together with the chopper-stabilized amplifier and series regulator comprise a second servo loop, which operates under abnormal loading conditions, such as short circuited output, to ensure linear operation of the amplifier. The controlled current limiter continuously monitors output current and compares it to the setting of the current limit control. When the voltage across current sensing resistor R70 exceeds the refer-

ence voltage set by the current limit control, the limiter generates a current, which subtracts from the +15 volt reference current. Thus, the output is limited or clamped to the preset value.

3-8. The function of the negative voltage limiter is to ensure linear operation of the chopper-stabilized amplifier during periods, such as downranging, when the series regulator is cut off and the main servo loop is opened. The negative voltage limiter is activated when the amplifier output attempts to go below -2.5 volts. The limiter then generates a current into the summing junction, which balances the input reference and beta string currents, thereby limiting the negative output of the amplifier. The action of the limiter thus assures fast recovery and settling time for the amplifier.

3-9. The primary function of the sink supply and crowbar circuitry is to quickly discharge the output capacitor and the high voltage filter capacitors when downranging the instrument. These circuits also provide protection for the instrument during abnormal load conditions, such as short circuited output. The sink supply serves two purposes: It discharges the output capacitor, and it protects the series regulator transistors by temporarily clamping the voltage across them to a safe value. The crowbar circuit protects the series regulator transistors by discharging the high voltage filter capacitors. It also generates a signal for the control circuit, which, under certain conditions, is used to trip the instrument to standby.

3-10. The control circuit provides a fixed delay of 3 to 5 seconds, following initial turn-on, before ac is connected

to the high voltage power supply. This allows the auxiliary power supplies time to stabilize and reach equilibrium before high voltage is applied. Secondly, the control circuit acts to trip the instrument to STANDBY when the output terminals are shorted at voltage settings of 300 or above on the 1000 volt range. The control circuit consists of an AND gate, which maintains the high voltage relay in an energized condition as long as both the delay and trip inputs are present.

3-11. The high voltage power supply is a conventional full-wave voltage doubler. Output voltage is determined by the range switch and most significant decade control switch, which select one of six voltage taps at the power transformer secondary.

### 3-12. CIRCUIT ANALYSIS

#### 3-13. +15 VOLT REFERENCE AND AUXILIARY SUPPLIES

3-14. The +15 volt reference supply is a conventional series regulated power supply, employing a reference amplifier and an error amplifier to provide a stable, well regulated output. Filtered, unregulated dc voltage for the +15 volt supply is provided by CR22, CR25, and C23. Darlington amplifier Q15, Q23 together with zener diodes CR19 and CR20 form a simple preregulator. The preregulator improves line regulation and reduces noise due to power line transients. Reference amplifier Q14 is a single device containing matched zener reference and amplifier elements, thereby providing a voltage reference that is extremely stable with respect to temperature variations. Output voltage variations are sensed at the input of differential amplifier Q15, Q17. The amplified output of the differential amplifier is applied to the input of the Darlington amplifier pair Q20, Q19, which varies the conduction of Q19 to maintain a constant output voltage. Frequency response for the overall servo loop is controlled by R14 and C20.

3-15. Filtered dc voltage for the -15 volt auxiliary supply is provided by CR23, CR24, and C22. The voltage reference for this supply is the +15 volt reference supply output. The error amplifier consists of differential amplifier Q16, Q18. Series control of the output is provided by Darlington amplifier Q22, Q21. Transistor Q24 and associated components comprise a constant current source for Q16, thus achieving a high overall loop gain. Capacitor C21 and resistor R6 control the frequency for this servo loop.

#### 3-16. CHOPPER-STABILIZED AMPLIFIER

3-17. The chopper amplifier consists of an input modulator, a high gain amplifier, a synchronous demodulator, and an output filter network. Input signals are restricted to less than 30 Hz by a low-pass filter consisting of R172, R171, and C47. The resulting baseband signal, dc to 30 Hz, is applied through R170 to the drain of MOS FET chopper Q39. Q39 is switched off and on at a 215 Hz rate by a squarewave signal applied to its gate, thus modulating the input signal and producing a squarewave output signal having an amplitude proportional to the amplitude of the baseband signal. The resulting signal is coupled to the input of JFET amplifier Q38. Use of the JFET as an input amplifier provides high input impedance and assures low noise operation. From Q39, the signal passes through IC1, an operational amplifier having a gain of approximately 420 and a frequency response of 20 Hz to 10 kHz. The output of IC1 is inverted in Q37 and appears with approximately equal amplitude at both collector and emitter of Q37. The collector signal is synchronously demodulated by shunt switch Q36. The resulting voltage is filtered by R129 and C31, leaving only the amplified dc and low frequency signals. The Q37 emitter signal is applied through a filter network to C31 to assist in reducing chopper ripple and to cancel any base band signal that is present. The purpose of CR57 is to assist in stabilization and quick recovery of the amplifier by providing a quick charge path for C36. Diode CR56 clamps the voltage at the emitter of Q36 to a safe value.

3-18. The source of the 215 Hz chopper drive signal is multivibrator Q2, Q3 and driver Q1. The signal at the collector of Q1 is coupled to the drain of Q39 to compensate for the dc error introduced by the gate-to-drain capacitance of Q39 and is adjusted by R162.

3-19. The preamplifier consists of two differential amplifiers and an output emitter follower. The signal passes through the input FET amplifier Q35, through a second differential pair Q33, Q34, and out the emitter of Q32 to the series regulator. The purpose of C1 and C2 on the reference board assembly is to reduce noise, principally 60 Hz ripple, by increasing the ac feedback at the undesired frequency.

#### 3-20. SERIES REGULATOR

3-21. The series regulator is composed of a preregulator, a control transistor, and a fixed current limiter. The preregulator consists of four Darlington amplifiers in series Q42 through Q49. Resistors R58, R60, R61, and R64 divide the high voltage equally among the four amplifiers

so that each preregulator control transistor feels one-fourth of the high voltage. The base of the final preregulator control transistor Q42 is held at 12.4 volts by zener diode CR48. Consequently, the emitter of Q42 will be constant at approximately 11.6 volts, and the main control transistor Q40 will see no more than 11.6 volts for any value of high voltage output. The control transistor Q40 together with Q41 form a Darlington pair. The purpose of diode CR65 is twofold: It prevents breakdown of Q42 when Q40 is suddenly cut off, and it clamps the voltage at the collector of Q40 to a safe value. Diodes CR41 through CR45 prevent excessive voltage drops across current sensing resistor R70, which could occur under certain output load conditions, such as short circuited output.

3-22. Fixed current limiting is provided by Q50 and associated components and is designed to protect the series regulator against catastrophic failure. Q50 is connected as a shunt regulator across the base of Q41 and limits control transistor current to a maximum of 60 ma. When the current through R70 exceeds 60 ma, transistor Q50 conducts, drawing current away from the base of Q41, thereby limiting output current to 60 ma. The purpose of diode CR50 is to permit the preamplifier output voltage to swing below zero volts.

### 3-23. CONTROLLED CURRENT LIMITER

3-24. The controlled current limiter utilizes a differential amplifier Q11, Q12, a voltage amplifier Q10, and a diode-connected transistor Q8 to accomplish the current limit function. The voltage developed across current sensing resistor R70 is applied to the base of Q12. The base of Q11, which is the other input to the differential amplifier, is connected to the current control potentiometer R41. When the voltage developed across R70 exceeds the voltage set by R41, transistor Q12 ceases conduction. When Q12 stops conducting, a shunt current path is offered to the reference current flowing into the summing junction. This path is through Q8 and Q10 and into the -15 volt supply. The main amplifier input current is reduced accordingly, and the instrument output current is thus limited to the preset value. Resistor R44 and transistor Q8 form a coupling network, which prevents the leakage current of Q10 from affecting the summing junction current. Transistor Q8 is used as a diode because of its inherently low leakage.

3-25. Transistor Q13 is used to activate the controlled current limiter during instrument warmup and STANDBY conditions. The base of Q13 is connected to CR48, and cutoff bias is applied to Q13 as long as the voltage across

CR48 exceeds 8 volts. When the voltage across CR48 drops below 8 volts, Q13 conducts, cutoff bias is applied to Q12, and the current limiter is activated. The purpose of Q13 is covered in the control circuit discussion, paragraph 3-36.

3-26. The current limit lamp driver turns on the current limit light whenever the controlled current limiter is activated. When the current through Q12 is reduced at the beginning of the current limit operation, the current in Q11 increases. The current change in Q11 is amplified by Q9, which turns on switch Q7, lighting the current limit lamp DSI.

### 3-27. NEGATIVE VOLTAGE LIMITER

3-28. The negative voltage limiter consists of a two-stage inverting amplifier Q5, Q6, and a coupling diode Q4. The limiter is connected between the output and input of the chopper-stabilized amplifier. When the output of the chopper-stabilized amplifier attempts to go more negative than approximately -2.5 volts, transistor Q6 conducts hard enough to turn on Q5; and current flows from the +15 volt supply through Q5, through the coupling diode Q4, and into the summing junction at the input to the amplifier. This limiting current balances the input reference and beta string currents, thereby limiting the output of the amplifier to approximately -2.5 volts. Coupling diode Q4 and resistor R52 are used to limit the effects of leakage current in Q5. Resistor R51 and capacitor C14 control the frequency response of this servo loop. Again, transistor Q4 is used as a diode, because of its inherently low leakage.

### 3-29. SINK SUPPLY AND CROWBAR

3-30. The 730 volt sink supply is composed of two power supplies connected in series. The 570 volt supply is a full-wave voltage doubler consisting of diodes CR1, CR2, CR4, CR5 and capacitors C1 and C2. The 160 volt supply is a half-wave rectifier consisting of diode CR3 and capacitor C3. The load resistors for the sink supply are R96 and R97. The sink supply is connected through R96 and R97 across output capacitor C49. When the instrument is downranged, current flows through the sink supply and its load resistors to quickly discharge C49 to the selected downrange voltage.

3-31. When the instrument is downranged or the output is short circuited, the voltage across the series regulator will attempt to rise, because of the charge on the high voltage filter capacitors. The charge on these capacitors can be as high as 1500 volts. The sink supply clamps the voltage across the series regulator to a safe value until the crowbar



circuit is activated, which occurs in less than 100 milliseconds. The sink supply is connected across the series regulator, through diodes CR32 and CR33. When the voltage across the series regulator approaches 730 volts, CR32 and CR33 conduct, and the sink supply clamps the voltage across the regulator to 730 volts. As soon as the crowbar circuit is activated, the crowbar discharges the high voltage filter capacitors and the clamping function of the sink supply ceases.

3-32. The crowbar circuit consists of Schmitt trigger Q28, Q29, relay driver Q30, series regulator Q31, crowbar relays K2A and K3A and associated components. Under normal conditions, Q28 is cutoff and Q29 is conducting. Thus, Q30 is also off and the crowbar relays are de-energized. Assume the instrument is downranged. The output capacitor C49 begins to discharge and the voltage across the series regulator begins to rise. As this voltage rises, current flow increases through CR51, CR52, R88, and R89, thereby increasing the positive voltage at the base of Q28. When the voltage across the series regulator rises to within 40 volts of the sink supply voltage, Q28 is biased on and the Schmitt trigger changes state. This turns on the relay driver Q30, which activates the crowbar relays. The crowbar relays place R81 and R84 directly across filter capacitors C55 through C58, and the capacitors quickly begin to discharge. When the voltage across the filter capacitors has decreased by approximately 80 volts, the decreased voltage at the base of Q28 resets the Schmitt trigger, and the crowbar relays deenergize. The continued discharge of C49, however, causes the voltage across the series regulator to rise again. When the voltage rises to within 40 volts of the sink supply voltage, the crowbar circuit is again activated, and the filter capacitors are discharged another 80 volt step. This action continues until C49 and C55 through C58 have stabilized at the selected downrange voltage. The step discharge of the filter capacitors is a function of the hysteresis exhibited by the Schmitt trigger, that is, the Schmitt trigger is activated by a much higher voltage than is required to deactivate it. Thus, the crowbar relays are energized for a finite time period, which contributes greatly to minimum arcing at the contacts and, consequently, long contact life. Transistor Q31 is a series regulator for the Schmitt trigger and relay driver stages.

3-33. A second function of the crowbar circuit is to provide a trip signal to the control circuit whenever crowbar relay closure time becomes excessive. This will occur if the instrument output is short-circuited at voltage settings above 300 on the 1000 volt range. It will also occur if the instrument is downranged excessively. Closure of the crowbar relays applies a voltage to the RC time constant circuit

consisting of R101, R102, and C5, which determines the crowbar relay closure limits. When crowbar operation exceeds this limit, a positive trip voltage is coupled through CR67 to the control circuit.

### 3-34. CONTROL CIRCUIT

3-35. The control circuit consists of AND gate Q26, Q27, high voltage relay K1C, silicon controlled rectifier CR29, and associated components. When the instrument FUNCTION switch is set from OFF to STANDBY/RESET, voltage is applied to the control circuit, to the +15 volt reference supply, and to the auxiliary power supplies. At this time, the high voltage is disabled by contacts K1A of the high voltage relay; and the instrument output terminals are shorted by contacts K1B of the high voltage relay, which prevents any uncontrolled voltage from appearing on the output terminals while the amplifiers are stabilizing. Rectified voltage for the control circuit is provided by CR26, CR27, and CR24. This voltage is applied to the base of Q51 through a time constant circuit consisting of R86 and C25, thus delaying turn-on of Q51 for 3 to 5 seconds. This delay ensures that the auxiliary power supplies will be on and stabilized before high voltage is applied. The delayed voltage then turns on Q51 and Q27. The other input to the AND gate is controlled by the FUNCTION switch and is not present until the FUNCTION switch is set to ON. A positive voltage is then applied through R87 to the base of Q26, turning it on. The high voltage relay then operates, high voltage is applied to the main rectifier and filter, and normal operation ensues. The purpose of diode CR68 is to discharge C25 quickly in the event of power failure or other interruption of main power, thus assuring a full 3 to 5 second delay cycle.

3-36. In the STANDBY/RESET condition, the series regulator is cut off to ensure that the main control amplifier is within its linear operating range when the high voltage is applied. This is accomplished by Q13, which activates the controlled current limiter as described in paragraph 3-25. When the high voltage is off, there is no zener current for CR48. Consequently, transistor Q13 will be on and the controlled current limiter will be activated. The main feedback loop at this time is provided by the negative limiter, which clamps the output of the differential amplifier to -2.5 volts.

3-37. The trip function of the control circuit is accomplished by silicon controlled rectifier CR29. CR29 receives an enabling trigger under two conditions. When the crowbar relay closure is excessively long, a trigger voltage is developed as described in paragraph 3-33. A second means of triggering CR29 is provided by the circuit consisting of

neon lamps DS1 and DS2 and resistor R98. This circuit is activated if the instrument output voltage becomes excessively high on the 10 or 100 volt ranges, for example, if the main amplifier opened and the series regulator were driven fully on. Under these conditions, DS1 and DS2 would fire and a positive trigger voltage would be developed at the anode of CR67. When the voltage at the gate of CR29 is sufficiently high, CR29 conducts and removes one input to the AND gate. This de-energizes the high voltage relay and places the instrument in STANDBY. To reset the relay, it is necessary to momentarily set the FUNCTION switch to STANDBY/RESET and back to ON.

### 3-38. HIGH VOLTAGE POWER SUPPLY

3-39. Diodes CR53 and CR54 and capacitors C55 through C58 comprise a full-wave voltage doubler. The voltage supplied to the doubler depends on the setting of the range switch and the most significant decade switch. On the 10 and 100 volt ranges, the high voltage output is fixed at about 500 volts. On the 1000 volt range, the eleven position decade switch selects a voltage ranging from 500 to 1500 volts.

### 3-40. METER CIRCUIT

3-41. The meter circuit is connected between + and - SENSE for voltage readings and is connected in shunt with R70 for output current readings. In current measurement mode, the meter current includes beta string current. This introduces a small error, which is negligible on the 10 and 100 volt ranges. On the 1000 volt range, the error will be equal to +1 milliamp.

### 3-42. BETA STRING

3-43. The beta string is a six-decade resistive network (seven decades on the 343A), which provides precise control of feedback to the chopper-stabilized amplifier, thereby controlling instrument output. The first decade of the 341A and the first and second decades of the 343A incorporate linearity adjustments, which are adjusted during calibration to ensure exact resistance ratios. The resistors and switches which comprise the beta string are located on reference board and sample string assemblies.

## SECTION IV

# MAINTENANCE

### 4-1. INTRODUCTION

4-2. This section contains information concerning preventive and remedial maintenance for the Model 341A/343A Voltage Calibrators. Preventive maintenance consists primarily of cleaning the instrument, which is performed periodically to sustain the instrument in peak operating condition. Remedial maintenance consists of troubleshooting, calibration, and performance test procedures, which are designed to aid in maintaining instrument operation within specifications. Section III of the instruction manual is an important supplement to the troubleshooting section, since a thorough knowledge of instrument theory is indispensable in troubleshooting.

### 4-3. SERVICE INFORMATION

4-4. Each instrument manufactured by the John Fluke Manufacturing Company is warranted for a period of one year upon delivery to the original purchaser. Complete warranty information is contained in the Warranty page located at the rear of this manual.

4-5. Factory authorized calibration and repair service for all Fluke Instruments is available at various world wide locations. A complete list of factory authorized service centers is located at the rear of the manual. If requested, an estimate will be provided to the customer before any repair work is begun on instruments which are beyond the warranty period.

### 4-6. TEST EQUIPMENT

4-7. Figure 4-1 lists the equipment recommended for performance testing, troubleshooting, and calibration. If the recommended equipment is not available, other equipment which meets the required specifications may be used.

### 4-8. GENERAL MAINTENANCE

#### 4-9. MAINTENANCE ACCESS

4-10. Main circuit board components are accessible from the top of the instrument after removing the top cover, which is held in place with six Dzus fasteners.

4-11. The reference board and sample string assemblies are located in the compartment just forward of the main circuit board. The compartment covers are each held in place with two machine screws. To replace components on the reference board assembly, sample string assembly, or front panel assembly, proceed as follows:

- a. Remove top and bottom instrument covers.
- b. Remove the reference and sample string assembly compartment covers.
- c. Remove the narrow front covers just above and below the meter.
- d. Remove the front panel and first bulkhead assemblies as a unit by removing the eight screws which hold the assemblies to the side rails, disconnecting the leads to pin 1 and 6 of the sample string assembly, and sliding the assemblies carefully forward, away from the main unit, as far as the wiring harness will permit.

#### NOTE

*The shafts of the RANGE and first decade switches will disengage from the switch rotors as the front panel is removed. To ensure proper shaft orientation when replacing the front panel, be sure to note the switch positions before disassembly.*

EQUIPMENT NOMENCLATURE	SPECIFICATIONS REQUIRED	RECOMMENDED EQUIPMENT
DC Differential Voltmeter	Range: 0 to +1100 vdc Accuracy: $\pm 0.0025\%$ of input	Fluke Model 895A <i>335D</i>
Oscilloscope	Sensitivity: 20 mv/cm Sweep: 1 msec/cm	Tektronix Model 541
True RMS Voltmeter	Range: 10 to 100 mv Accuracy: 0.05%	Fluke Model 931B
Preamplifier	Gain: 1000 Bandpass: 5 Hz to 100 kHz	
Autotransformer	Voltage: 0 to 130 vac Current: 3 amp	General Radio Model W5MT3AW
Wattmeter	0 to 200w	
Multimeter	Accuracy: $\pm 2\%$ dc $\pm 3\%$ ac Input Impedance: 11 megohms dc 1 megohm ac	Fluke Model 853A
Load Resistors	40 ohms, $\pm 5\%$ , 1/2w 400 ohms, $\pm 5\%$ , 1w 4k, $\pm 5\%$ , 10w 40k, $\pm 5\%$ , 50w	Clarostat Model 240C
	400 ohms, $\pm 1\%$ , 1w	
Null Detector (Model 343A only)	Sensitivity: 1 uv	Fluke Model 845AR or 845AB
Standard Cell (Model 343A only)	Accuracy: $\pm 0.0005\%$	Guildline Instruments Model 9152/P4
DC Voltage Calibration System (343A only)  Reference Divider DC Voltage Source Null Detector	Range: 0.1 to 1100 vdc Accuracy: 10 ppm	Fluke Model 7100B, consisting of the following equipment: Fluke Model 750A Fluke Model 332B Fluke Model 845AR

Figure 4-1. TEST AND CALIBRATION EQUIPMENT

- e. Remove the nine screws which hold the sample string assembly in place on the rear of the first bulkhead. The reference board assembly is held in place on the front of the second bulkhead by six screws.
- f. Separate the front panel from the first bulkhead by removing the RANGE, FUNCTION, CURRENT LIMIT, and voltage control knobs and unsoldering the wires which connect to the output terminals.

- c. Remove the eight screws which hold the rear panel to the side rails.
- d. Remove the four transformer screws, which are located on the rear panel.
- e. Remove the two screws which hold the rear panel to the center bulkhead.
- f. Separate the rear panel from the main unit to the extent permitted by the wiring.

4-12. To gain access to rear-panel-mounted components, proceed as follows:

- a. Remove the top and bottom covers.
- b. Remove the narrow covers located immediately above and below the rear panel.

4-13. ADJUSTMENT LOCATIONS

4-14. All controls required for calibration and troubleshooting are accessible from the top of the instrument after removing the top cover. See Figure 4-2 for Model 341A adjustment locations and Figure 4-3 for Model 343A adjustment locations.

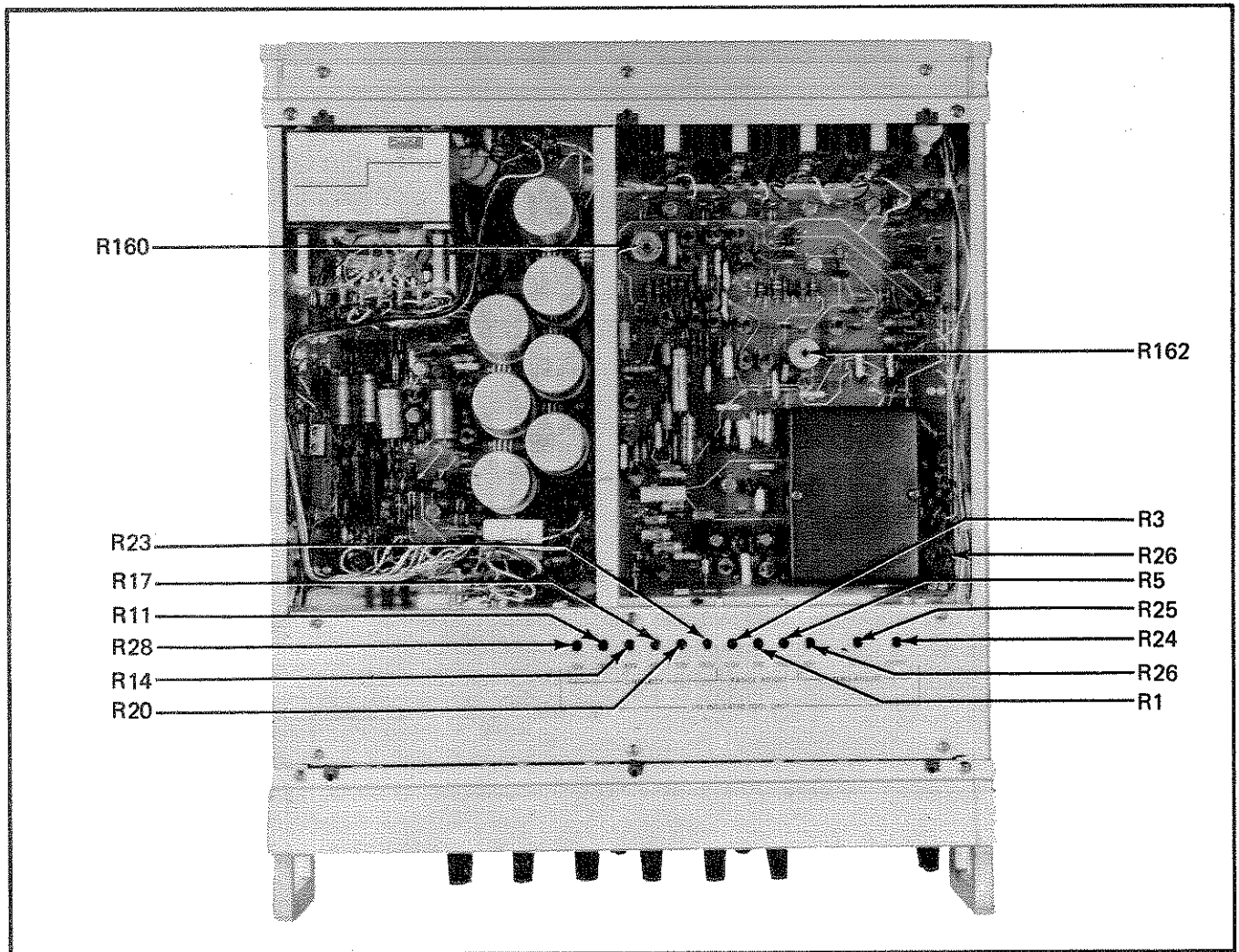

Figure 4-2. MODEL 341A ADJUSTMENT LOCATIONS

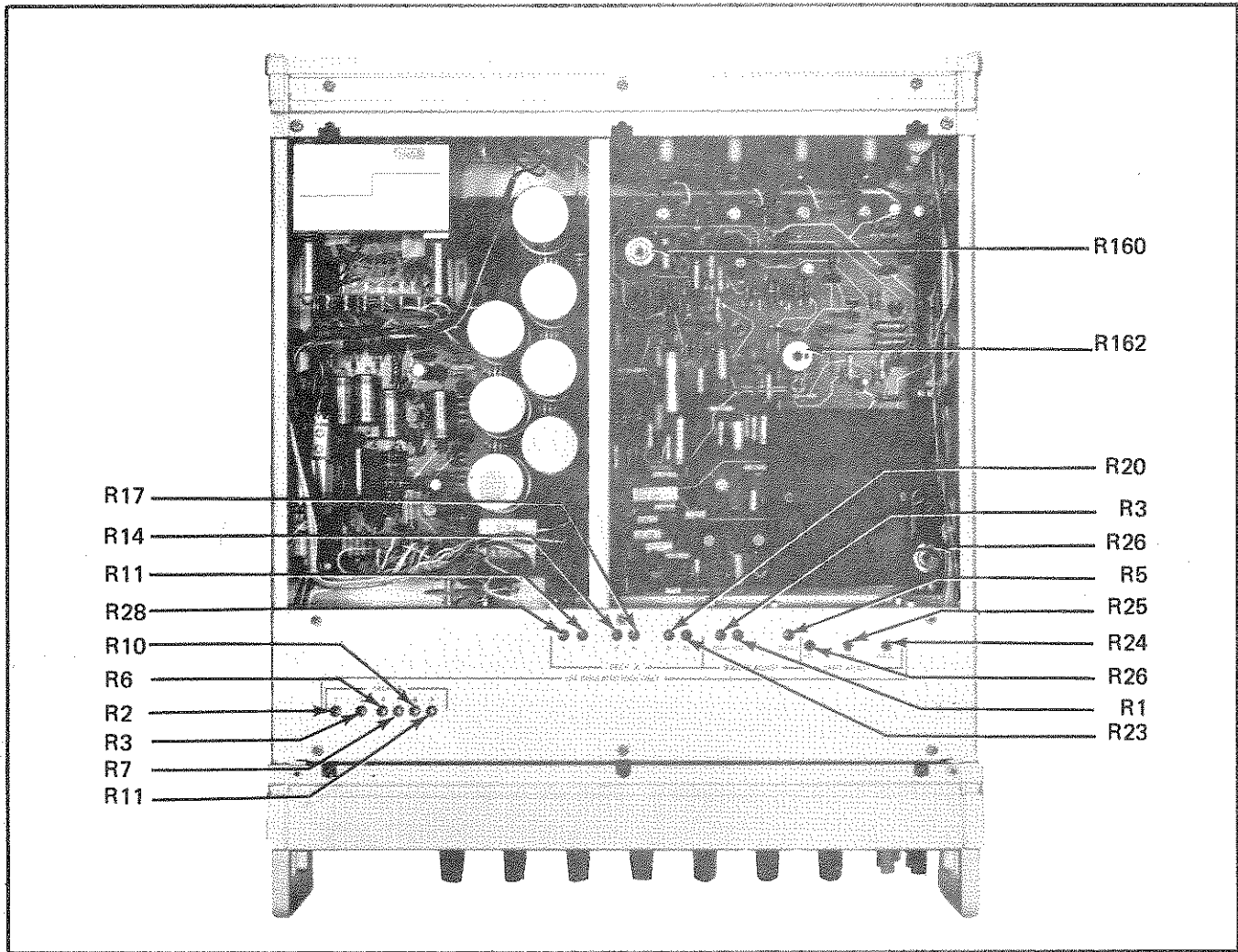

Figure 4-3. MODEL 343A ADJUSTMENT LOCATIONS

#### 4-15. CLEANING

4-16. The instrument should be cleaned periodically to remove dust, grease, and other contamination. Since the instrument is completely enclosed, having no fans, the need for cleaning is reduced. Care has been taken to prevent leakage, through the use of high quality insulating materials in all switches and through special attention to component layout. In addition, all circuit boards are coated with a moisture sealant.

4-17. To clean the instrument, proceed as follows:

#### CAUTION!

Avoid touching the polyethelene grommets; contamination can cause excessive electrical leakage.

- a. Remove loose contamination from the instrument with low-pressure, clean, dry air. Pay particular attention to the front panel binding posts, binding post wiring, switches, and polyethelene grommets.
- b. Clean the polyethelene binding posts and the front panel with anhydrous ethyl alcohol or an aerosol can of Freon TF Degreaser (Miller-Stephenson Chemical Co., Inc.). When necessary, clean the exposed dielectric surfaces of switches with anhydrous alcohol, using a small, stiff-bristled brush which has been wrapped with a clean cloth to prevent saturating the switch contacts. After cleaning, recoat the exposed dielectric surfaces with silicon fluid. This will prevent leakage along these surfaces due to moisture.

#### CAUTION!

Do not use Metriolene, acetone, lacquer thinner, Freon TF Degreaser, or any ketone on the

Lexan switch shafts and spacers, because they will react with the Lexan. Also, do not saturate the switch contacts, which have been permanently lubricated.

- c. Printed circuit boards have been coated with epocast (a polyurethane resin) to inhibit fungus growth and moisture absorption. When soldering to a printed circuit land, the heat from the soldering iron decomposes the epocast resin, leaving a charred residue. Upon completion of soldering, this residue should be removed with a solvent, such as toluol.

**CAUTION!**

The following precautions should be adhered to when using toluol: Avoid inhaling the vapors, avoid excessive contact with the skin, and keep away from open flames. Ensure that plastic components do not come into contact with toluol, since it will dissolve most types of plastic.

- d. After removal of the epocast residue, the affected area should be recoated with a sealant. A spray can of Circuit Coat (Furane Plastic Inc., 4516 Brazil Street, Los Angeles, California or 16 Spielman Road, Fairfield, New Jersey) may be used for recoating.

**4-18. 115/230 VOLT CONVERSION**

4-19. The Model 341A/343A may be operated from either a 115 or 230 volt ac power line, depending upon the connection of the power transformer primary winding. Convert the instrument from one type of power line operation to the other by the following procedure:

- a. Disconnect the instrument from the power line.
- b. Remove the top cover. The power transformer is located in the rear of the instrument, near the point of line cord entry.
- c. Orient the instrument and perform the appropriate electrical connections as shown in Figure 4-4.
- d. Use the proper fuse for the selected voltage, as specified in paragraph 4-20.

**4-20. FUSE REPLACEMENT**

4-21. Instrument fuses are contained in bayonet type fuse holders located at the rear of the instrument. Correct values for the fuses are as follows:

<u>REFERENCE DESIGNATION</u>	<u>FUNCTION</u>	<u>RATING</u>
F1	Line fuse	115 volt connections 1 amp, slow-blow
		230 volt connections 1/2 amp, slow-blow
F2	High voltage fuse	1/16 amp, slow-blow fuse

**4-22. LAMP REPLACEMENT**

4-23. RANGE, LIMIT ON, and power ON lamps are located immediately behind the front panel. They are accessible from the top of the instrument after removing the top instrument cover and the narrow front cover just

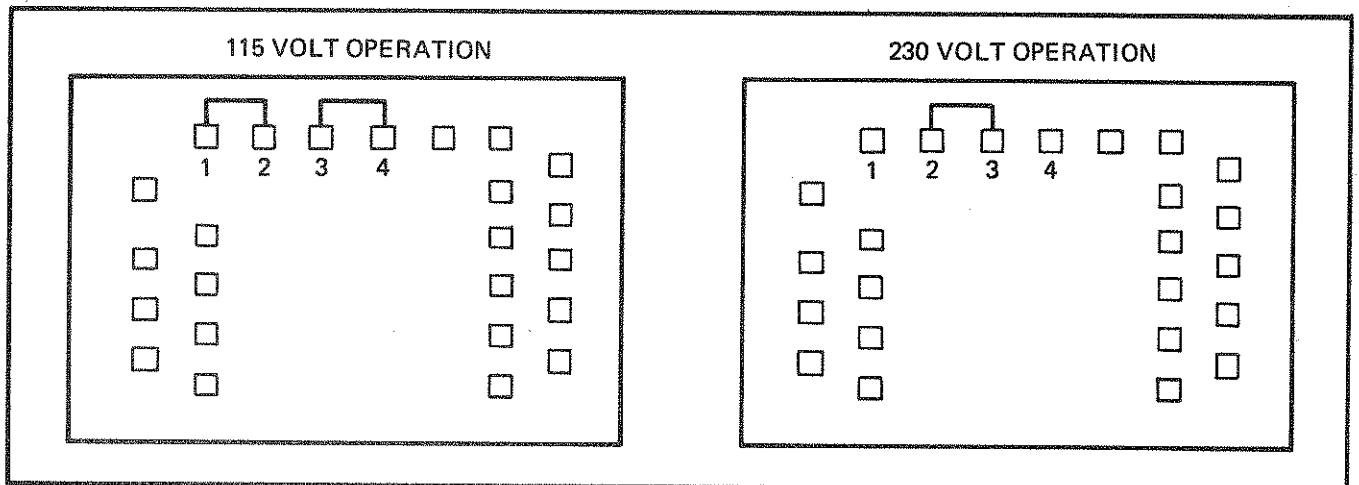

Figure 4-4. 115/230 VOLT CONVERSION

above the meter. The lamps are easily removeable without special tools. The two control circuit lamps, DS1 and DS2 are located on the main circuit board and are accessible after removing the top cover.

**4-24. PERFORMANCE TESTS**

4-25. Performance tests consist of line regulation, load regulation, ripple, and output voltage accuracy tests, and are designed to compare instrument performance to specifications. The tests may be used during maintenance or for receiving inspection. Test should be performed under standard test conditions: ambient temperature  $23 \pm 1^{\circ} \text{C}$ , relative humidity less than 70%. Allow instrument to warm up for at least 1 hour before testing. An instrument that fails any of the performance tests may require corrective maintenance or calibration. In case of trouble, analysis of the tests results, with reference to the troubleshooting section, should help to locate the trouble.

*NOTE!*

*Unless otherwise specified, the following tests apply to both Model 341A and Model 343A instruments.*

**4-26. LINE REGULATION**

4-27. The line regulation test determines whether the output voltage of the instrument will remain constant, within specified limits, for low and high line voltages.

a. Connect the autotransformer to the line, and connect the Model 341A to the autotransformer. Adjust the autotransformer for 115 volts output.

b. Set the Model 341A/343A controls as follows:

FUNCTION	STANDBY/RESET
RANGE	10
Voltage Dials	1.00000 (Model 341A) 1.000000 (Model 343A)
CURRENT LIMIT	Fully clockwise

c. Connect a 40 ohm  $\pm 5\%$ , 1/2 watt resistor to the Model 341A/343A OUTPUT terminals.

d. Connect the 895A differential voltmeter to the OUTPUT terminals, and set the FUNCTION switch to ON.

- e. Vary the line voltage from 115 volts to 103.5 volts. The 895A should indicate a voltage change of less than 30 microvolts.
- f. Vary the line voltage from 115 volts to 126.5 volts. The 895A should indicate a voltage change of less than 30 microvolts.
- g. Repeat steps c through f with loads and instrument settings as follows. The maximum voltage changes should be as indicated.

LOAD	RANGE	VOLTAGE DIALS	MAXIMUM VOLTAGE CHANGE
400 ohms $\pm 5\%$ 1 w	10	10.00000 (341A)	75 uv
		10.000000 (343A)	
4k $\pm 5\%$ 10 w	100	100.0000 (341A)	525 uv
		100.00000 (343A)	
40k $\pm 5\%$ 50 w	1000	1000.000 (341A)	5 mv
		1000.0000 (343A)	

**FAULT ANALYSIS**

If the line regulation is not within limits, it is likely that the chopper amplifier or preamplifier gain is too low. Check chopper amplifier performance as described in paragraph 4-47. Check test point 8 (TP8) voltages in the preamplifier as described in paragraph 4-45.

**4-28. LOAD REGULATION**

4-29. The load regulation test determines if the instrument output voltage will remain constant, within specified limits, under no-load to full-load conditions.

a. Connect the autotransformer to the line, and connect the Model 341A/343A to the autotransformer. Adjust the autotransformer for 115 volts output.

b. Set the Model 341A/343A controls as follows:

FUNCTION	STANDBY/RESET
RANGE	10
Voltage dials	1.00000 (Model 341A) 1.000000 (Model 343A)
CURRENT LIMIT	Fully clockwise



- c. Jumper the SENSE terminals to the output terminals.
- d. Connect the 895A differential voltmeter to the SENSE terminals, and set the FUNCTION switch to ON.
- e. Record the voltage indicated by the 895A.
- f. Connect a 40 ohm  $\pm 5\%$ , 1/2 watt resistor to the OUTPUT terminals. The voltmeter should indicate a voltage change of less than 30 microvolts.
- g. Remove the 40 ohm resistor, and set the voltage dials to 10.00000 (10.000000 for the Model 343A). Record the voltage indicated by the 895A.
- h. Connect a 400 ohm  $\pm 5\%$ , 1 watt resistor to the OUTPUT terminals. The 895A should indicate a voltage change of less than 75 microvolts.
- i. Remove the 400 ohm resistor. Set the RANGE switch to 100 and the voltage dials to 100.0000 (100.00000 on Model 343A). Record the voltage indicated by the 895A.
- j. Connect a 4k  $\pm 5\%$ , 10 watt resistor to the OUTPUT terminals. The 895A should indicate a voltage change of less than 525 microvolts.
- k. Remove the 4 k resistor. Set the RANGE switch to 1000 and the voltage dials to 1000.000 (1000.0000 on the Model 343A). Record the voltage indicated by the 895A.

- l. Connect a 40k  $\pm 5\%$ , 50 watt resistor to the OUTPUT terminals. The 895A should indicate a voltage change of less than 5 millivolts.
- m. Repeat steps a. through m. for line voltages of 103.5 volts ac and 126.5 volts ac.

**FAULT ANALYSIS**

If load regulation is poor, check for proper operation of the preamplifier and chopper amplifier as described in paragraph 4-45 and 4-47. Also, ensure that SENSE terminals are connected properly. See paragraph 2-14.

**4-30. RIPPLE**

- 4-31. The ripple test determines if the ac ripple present on the instrument dc output is within specified limits.
- a. Install top and bottom instrument covers, and connect + OUTPUT to chassis ground.
  - b. Connect the preamplifier to the OUTPUT terminals, and connect the 931B true rms voltmeter to the output of the preamplifier.
  - c. Set the FUNCTION switch to on, and set the RANGE switch and voltage dials as shown in Figure 4-5. The rms ripple should not exceed the values shown.

RANGE	VOLTAGE DIALS	MAXIMUM RIPPLE					
		115 VAC 50-60 HZ LINE				115 VAC 400 HZ LINE	
		341A		343A		341A / 343A	
		RMS	P-P	RMS	P-P	RMS	P-P
10	<u>10.00000</u> (341A) <u>10.000000</u> (343A)	100 uv	1 mv	50 uv	400 uv	100 uv	2 mv
100	<u>100.0000</u> (341A) <u>100.00000</u> (343A)	100 uv	1 mv	50 uv	400 uv	100 uv	2 mv
1000	<u>1000.000</u> (341A) <u>1000.0000</u> (343A)	100 uv	1 mv	50 uv	400 uv	100 uv	2 mv

Figure 4-5. RIPPLE SPECIFICATIONS

- d. Remove the 931B from the output of the preamplifier and connect the oscilloscope in its place.
- e. Repeat step c. The p-p ripple should not exceed the values shown.

— FAULT ANALYSIS —

If ripple is excessive, check for ground loops in equipment connections and check for proper operation of the preamplifier and chopper amplifier, paragraphs 4-45 and 4-47.

**4-32. OUTPUT VOLTAGE ACCURACY**

4-33. If the instrument has successfully passed the line, load, and ripple tests, it can be assumed to be operating correctly. The output voltage accuracy test compares the instrument output voltage to the accuracy specifications given in Section I.

**4-34. Model 341A Output Voltage Test.**

- a. Connect the 895A to the Model 341A OUTPUT terminals, with the negative OUTPUT terminal connected to chassis ground.
- b. Set the Model 341A controls as shown in Figure 4-11. The output voltages should be as indicated in column 2.

— FAULT ANALYSIS —

If output voltages are incorrect, check the +15 volt reference adjustment, paragraph 4-64; the zero output adjustments, paragraph 4-65; the range adjustments, paragraph 4-67; and the beta string, paragraph 4-57.

**4-35. Model 343A Output Voltage Test.** To check the Model 343A output voltage accuracy, perform the Model 343A calibration verification procedure, paragraph 4-84, steps a through h. The output voltages should be as indicated in Figure 4-17, column 2.

— FAULT ANALYSIS —

If output voltages are incorrect, check the +15 volt reference adjustment, paragraph 4-73; the zero output adjustments, paragraphs 4-74 and 4-79; the range adjustments, paragraph 4-82; and the beta string, paragraph 4-57.

**4-36. TROUBLESHOOTING**

4-37. In the following checks, paragraphs 4-39 through 4-59, the performance of the major functional circuitry is examined by an appropriate test. These tests together with specific troubleshooting, information are intended to aid in locating instrument malfunctions. The tests begin with power-off resistance checks, proceed to standby and power-on checks, and conclude with specific functional circuit checks. The tests should be performed in the order given, unless the general trouble location is suspected beforehand.

4-38. When measuring voltages on the circuit boards, it is recommended that the major portion of the voltage probe be wrapped with insulating tape. This will reduce the possibility of damaging a transistor due to an accidental short circuit. For component locations, refer to the illustrated parts breakdown in Section V.

**WARNING!**

Voltages hazardous to life will be present. Use extreme caution. When troubleshooting, it is recommended that the + OUTPUT terminal be jumpered to the chassis ground terminal to reduce shock hazard.

**4-39. TEST POINT RESISTANCE CHECK**

4-40. This test consists of a resistance check of all power supply outputs within the instrument.

- a. Set Model 341A/343A controls as follows:

FUNCTION	OFF
RANGE	10
Voltage Dials	10.00000 (Model 341A) 10.000000 (Model 343A)
CURRENT LIMIT	Fully clockwise

- b. Connect 853A common to + SENSE. Measure the resistance between the following points and the + SENSE terminal. Resistance should be as indicated.

TEST POINT	APPROXIMATE RESISTANCE IN OHMS
TP2	2500
TP3	3700
TP5	>100k
TP6	340
TP7	>100k
- SENSE	58

**FAULT ANALYSIS**

If there are errors in test point resistance readings, check the following components.

<u>TEST POINT</u>	<u>POSSIBLE TROUBLE</u>
TP2	Defective diode CR17 Defective transistor Q6 or Q11
TP3	Defective transistor Q9, Q11, or Q18
TP5	Defective diode CR1, CR2, CR3, CR4 or CR5
TP6	Defective diode CR26 or CR27 Defective lamp DS5, DS6 or DS7
TP7	Defective capacitor C54 Shorted relay K2A and K3A
- SENSE	Resistor R169 changed value

**4-41. STANDBY TEST**

4-42. This test determines instrument power consumption and verifies proper operation of the controlled current limiter under standby conditions.

a. Set Model 341A/343A controls as follows:

FUNCTION	OFF
RANGE	10
Voltage dials	10.00000 (Model 341A) 10.000000 (Model 343A)
CURRENT LIMIT	Fully clockwise

b. Connect the instrument through the wattmeter to a 115 volt  $\pm 1\%$ , 60 Hz source.

c. Set FUNCTION switch to STANDBY/RESET. The wattmeter should indicate approximately 10 watts and the LIMIT ON lamp should illuminate.

**FAULT ANALYSIS**

(1) If the LIMIT ON lamp does not light in STANDBY, check the following: lamp DS3 for continuity, test point 2 (TP2) and TP3 for proper +15 and -15 volt outputs, Q13 for proper operation, and controlled current limiter for proper operation.

**4-43. AUXILIARY SUPPLY VOLTAGES**

4-44. In the following test, the auxiliary supplies are tested by measuring their respective output voltages.

a. Set Model 341A/343A controls as follows:

FUNCTION	STANDBY/RESET
RANGE	10
Voltage Dials	10.00000 (Model 341A) 10.000000 (Model 343A)
CURRENT LIMIT	Fully clockwise

b. Connect the 895A common to the + SENSE terminal, and measure the following test point voltages. Voltages should be as indicated.

<u>TEST POINT</u>	<u>DC VOLTS</u>
TP1	21 to 24
TP2	14.999 to 15.001
TP3	-14.5 to -15.5
TP4	540 to 600
TP5	690 to 760

**FAULT ANALYSIS**

If the auxiliary supply voltages are not correct, check for possible defective components as follows:

<u>TEST POINT</u>	<u>POSSIBLE TROUBLE</u>
TP1	Defective diode CR19, CR20 Defective transistor Q23 or Q24
TP2	Defective transistor Q19, Q20 or Q14
TP3	Defective +15 volt supply Defective transistor Q21 or Q22 Defective diode CR21
TP4	Defective diode CR1, CR2, CR4 or CR5
TP5	Defective diode CR3

4-45. POWER-ON TEST

4-46. This test determines instrument power consumption under power-on conditions and verifies proper operation of the chopper-stabilized amplifier.

a. Set Model 341A/343A control as follows:

FUNCTION	OFF
RANGE	10
Voltage dials	<u>10.00000</u> (Model 341A) <u>10.000000</u> (Model 343A)
CURRENT LIMIT	Fully clockwise

b. Connect the instrument through the wattmeter to a 115 volt  $\pm 1\%$ , 60 Hz source.

c. Set FUNCTION switch to STANDBY/RESET.

d. Measure the voltage at TP8 with the 895A, using + SENSE as common. The voltmeter should indicate between  $-1.7$  and  $-2.1$  volts.

e. Set FUNCTION switch to ON. The wattmeter should indicate approximately 15 watts and the LIMIT ON lamp should extinguish.

f. Repeat step d. The 895A should indicate between  $+2.3$  and  $+2.7$  volts.

g. Connect the 895A to the OUTPUT terminals. The 895A should indicate between 9.999 and 10.001 volts dc (9.9997 to 10.0003 volts dc for the Model 343A).

FAULT ANALYSIS

(1) If the ON lamp does not light in the FUNCTION-ON position, check for possible defective lamp DS4 and for proper operation of the control circuit.

(2) If the TP8 voltages are not within limits, the trouble is probably in the negative voltage limiter. It may also be due to preamplifier imbalance or improper chopper amplifier operation. Check the input voltage to the controlled current limiter; in STANDBY, it should be approximately zero volts. Check Q35 for balance; with C31 shorted, the drain voltages of Q35 should be equal within 0.5 volts. Check the chopper amplifier as described in paragraph 4-47.

(3) If the LIMIT ON lamp does not extinguish in FUNCTION-ON position, check the high voltage fuse F2, check for proper control circuit operation, and check controlled current limiter operation, paragraph 4-51.

(4) If the output voltage is not within limits, check as described in paragraph 4-34 (paragraph 4-35 for the Model 343A).

4-47. CHOPPER AMPLIFIER *OK*

4-48. This test verifies proper chopper amplifier operation by examining multivibrator and chopper amplifier signal characteristics.

a. Set Model 341A/343A controls as follows:

FUNCTION	ON
RANGE	10
Voltage dials	<u>10.00000</u> (Model 341A) <u>10.000000</u> (Model 343A)
CURRENT LIMIT	Fully clockwise

b. Connect the oscilloscope 10:1 attenuator probe to test point TP9, using + SENSE as common.

c. Set the oscilloscope input to dc, vertical sensitivity to 0.2 volts per centimeter, and sweep speed to 1 millisecond per centimeter.

d. Compare the oscilloscope display with the waveform shown in Figure 4-6 for amplitude, period, and symmetry. The observed signal parameters should be equal to those of the given signal within  $\pm 10\%$ .

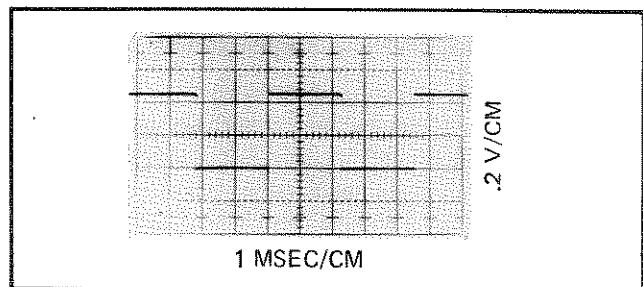

Figure 4-6. MULTIVIBRATOR SIGNAL -- TP9

e. Connect the oscilloscope 10:1 attenuator probe to TP10, using + SENSE as common.

**NOTE**

Ensure that the bottom cover is in place on the instrument when observing the signal at TP10. The top cover should be slid back just far enough to admit the probe.

- f. Set the oscilloscope input to ac, vertical sensitivity to 0.02 volts per centimeter and sweep speed to 1 milli-second per centimeter.
- g. Compare display with the waveform shown in Figure 4-7, which indicates proper adjustment of spike compensation control R162. The signal is acceptable if the positive and negative spike amplitudes are less than 0.3 volts.

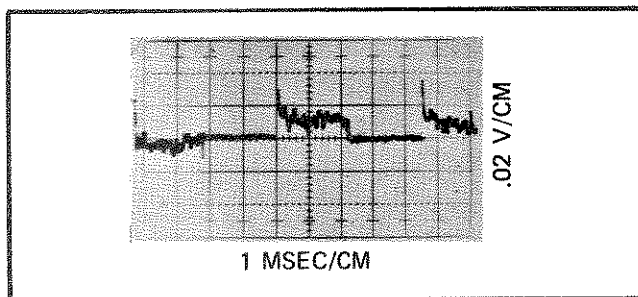

Figure 4-7. CHOPPER AMPLIFIER SIGNAL -- TP10

- h. If the signal obtained in step g. is not acceptable, it will be necessary to adjust R160 and R162. Proceed as follows:
  - (1) Set chopper drive control R160 fully clockwise.
  - (2) Adjust R162 for minimum spike amplitude. A point should be found where the positive and negative spike amplitudes are approximately equal and nulled.
  - (3) Rotate chopper drive control R160 counterclockwise until noise spikes begin to appear in the formerly quiet regions.
  - (4) Reverse the adjustment of R160 just far enough to restore the quiet region.
  - (5) Repeat step g.

**NOTE!**

Adjustment of R160 and R162 affects the output zero on the 10 volt range; therefore, it will

be necessary to perform the 10 volt zero and range adjustments, paragraphs 4-65 and 4-67 (paragraphs 4-74, 4-79, and 4-83 for the Model 343A).

**FAULT ANALYSIS**

- (1) If signal at TP9 is not correct, check for square wave signal at the collector of Q2. Transistor Q39, Q1, Q2 or Q3 may be defective.
- (2) If the signal at TP10 is not correct, integrated circuit IC1 or MOS FET transistor Q38 or Q39 may be defective.

**4-49. SERIES REGULATOR**

4-50. This test verifies proper operating voltages for the control transistor and preregulator transistors.

- a. Set Model 341A/343A controls as follows:

FUNCTION	ON
RANGE	10
Voltage dials	<u>10.00000</u> (Model 341A) <u>10.000000</u> (Model 343A)

CURRENT LIMIT Fully clockwise

- b. Connect the 895A between the metal case (collector) of Q40 and the + OUTPUT terminal. The voltmeter should indicate between 10 and 13.5 volts dc.
- c. Connect a 400 ohm  $\pm 5\%$ , 1 watt resistor to the OUTPUT terminals and connect the positive OUTPUT terminal to chassis ground.
- d. Using the 853A multimeter, measure and record the collector-to-emitter voltages of each series regulator transistor, Q48, Q46, Q44, and Q42. The voltages should differ by less than 25 volts dc.

**FAULT ANALYSIS**

- (1) If the collector voltage of Q40 is not within limits, zener diode CR48 is probably defective. Also check transistors Q40, Q42 and Q43.
- (2) If the voltage division across the preregulator is not equal within 25 volts, check transistors Q42 through Q49 and check for a change in value of resistors R58, R60, R61, or R64.

**4-51. CONTROLLED CURRENT LIMITER**

4-52. This test verifies proper limiter operation and determines the current control range.

a. Set Model 341A/343A controls as follows:

FUNCTION	ON
RANGE	10
Voltage dials	10.00000 (Model 341A) 10.000000 (Model 343A)
CURRENT LIMIT	Fully clockwise

b. Connect the 853A, set to the 100 milliamp range, to the OUTPUT terminals. The LIMIT ON lamp should illuminate and the 853A should indicate between 25 and 36 milliamps.

c. Set the CURRENT LIMIT control fully counter-clockwise. The range of adjustment should be approximately 30 milliamps.

d. Set Model 341A/343A controls as follows:

FUNCTION	ON
RANGE	1000
Voltage dials	100.0000 (Model 341A) 100.00000 (Model 343A)

e. Adjust the CURRENT LIMIT control through its range, while observing the 853A. The range of adjustment should be approximately 34 milliamps.

**FAULT ANALYSIS**

If controlled current range is not sufficient, check +15 and -15 volt supply output voltages and check transistors Q11 and Q12.

**4-53. CROWBAR**

4-54. In the following test, crowbar circuitry is exercised by short-circuiting the output and by down ranging the instrument excessively.

a. Set Model 341A/343A controls as follows:

FUNCTION	METER VOLTAGE
RANGE	1000
Voltage dials	100.000 (Model 341A) 100.0000 (Model 343A)
CURRENT LIMIT	Fully clockwise

b. Short circuit the OUTPUT terminals, and set the voltage dials to 300.000 (300.0000 on the Model 343A). The LIMIT ON lamp should illuminate, and the instrument should trip to STANDBY.

c. Remove the short from the OUTPUT terminals and reset the instrument. The LIMIT ON lamp should extinguish, and the ON lamp should illuminate.

d. Set the voltage dials to 1000.000 (1000.0000 on Model 343A), and then downrange the instrument by setting the RANGE switch to 100. The crowbar relays K2A and K3A should operate several times very rapidly, or rattle, as the RANGE switch is changed.

e. Repeat step d several times, allowing at least 5 seconds between range changes.

f. Repeat step e several times, allowing only 2 seconds or less between range changes. The instrument should trip to standby.

**FAULT ANALYSIS**

(1) If instrument does not trip to STANDBY when the OUTPUT terminals are shorted at 300 volts output, check the Schmitt trigger input (voltage across R89). This voltage should be at least 6 volts to trigger the Schmitt circuit. If input is correct, check other Schmitt trigger components, especially transistor Q31, zener diode CR55, and relays K2B and K3B. Also, check diodes CR6, CR8, CR29, CR66 and CR67.

(2) If the crowbar relays do not rattle when the instrument is downranged from 1000 volts, check for proper operation of the Schmitt trigger circuit.

(3) If instrument does not trip to STANDBY when it is downranged repeatedly as described in step f, check for defective components in the gate circuit of CR29.

**4-55. HIGH VOLTAGE POWER SUPPLY**

4-56. This test verifies proper operations of the high voltage power supply by measuring rectifier output voltages for all instrument voltage ranges.

- a. Connect the 895A to TP7, using + OUTPUT as common.
- b. Set FUNCTION switch to ON and RANGE switch to 1000.
- c. Set the voltage dials as shown in Figure 4-8, and verify the voltages are as indicated.

VOLTAGE DIALS		TP7 VOLTS
341A	343A	
200.000	200.0000	300 to 360
500.000	500.0000	360 to 420
700.000	700.0000	410 to 480
800.000	800.0000	450 to 520
900.000	900.0000	450 to 520
1000.000	1000.0000	470 to 540

Figure 4-8. HIGH VOLTAGE POWER SUPPLY OUTPUT VOLTAGES

**FAULT ANALYSIS**

If the high voltage power supply voltages are not correct, check diodes CR53 and CR54, capacitors C55 through C58, and transformer T1.

**4-57. BETA STRING**

4-58. The following sequence of tests is intended to detect gross errors in the beta string resistors or their switching patterns.

- a. Connect the 895A to the OUTPUT terminals. Set the 895A to TVM mode, with readout dials at zero.
- b. Set the Model 341A/343A controls as follows:  

FUNCTION	ON
RANGE	100
Voltage dials	Zero
CURRENT LIMIT	Fully clockwise
- c. Null the 895A on the 100 uV range.
- d. Set the Model 341A/343A and 895A controls as shown in Figure 4-9. The voltage increments should correspond to the values shown.

VOLTAGE DIAL TESTED		895A		OUTPUT VOLTAGE INCREMENT
341A	343A	RANGE	NULL	
00.0000	00.00000	100	TVM	10v
00.0000	00.00000	10	TVM	1v
00.0000	00.00000	1	TVM	0.1v
00.0000	00.00000	1	.1	10 mv
00.0000	00.00000	1	.01	1.0 mv
00.0000	00.00000	1	1 MV	100 uv
	00.00000	1	100uV	10 uv

Figure 4-9. BETA STRING SWITCHING REQUIREMENTS

**FAULT ANALYSIS**

If the beta string switching is incorrect, it is likely that one or more beta string resistors, has changed value. Check for defective resistors, and perform the zero output adjustments and beta string calibration, paragraphs 4-65 and 4-66 (paragraphs 4-74, 4-75, 4-79, and 4-80 for the Model 343A).

**4-59. PANEL METER**

4-60. The following test verifies proper operation of the meter circuit by comparing full-scale meter readings to instrument output voltages.

- a. Set the FUNCTION switch to METER VOLTAGE.
- b. Set RANGE switch to 10 and voltage dials to 10.00000 (10.000000 on Model 343A). The instrument meter should indicate 10 volts  $\pm 5\%$ .
- c. Set RANGE switch to 100 and voltage dials to 100.0000 (100.00000 on Model 343A). The instrument meter should indicate 100 volts  $\pm 5\%$ .
- d. Set RANGE switch to 1000 and voltage dials to 1000.000 (1000.0000 on Model 343A). The instrument meter should indicate 1000 volts  $\pm 5\%$ .
- e. Set RANGE switch to 10 and voltage dials to 10.00000 (10.000000 on Model 343A).
- f. Set CURRENT LIMIT control maximum clockwise, and connect the 400 ohm  $\pm 1\%$ , 1 watt resistor to the OUTPUT terminals.

- g. Set FUNCTION switch to METER CURRENT. The Model 341A/343A meter should indicate between 23.7 and 26.3 milliamps.

— FAULT ANALYSIS —

- (1) If voltage readings are incorrect on one range only, check corresponding range resistor R71, R72, R73 or R74. If voltage readings are incorrect on all ranges, check meter M1 and resistors R44 and R45.
- (2) If current readings are incorrect, check current sensing resistor R70 and associated components.

**4-61. MODEL 341A CALIBRATION**

4-62. Calibration of the Model 341A consists of five ordered steps: (1) reference voltage adjustment, (2) zero output adjustment, (3) beta string linearity adjustments, (4) range adjustments, and (5) verification of calibration. Before attempting calibration, instrument performance should be examined according to the performance tests in paragraph 4-24 to ensure that no malfunctions exist.

**4-63. PRELIMINARY OPERATIONS**

- a. Connect the Model 341A to the autotransformer, and adjust the autotransformer for 115 volts output.
- b. Set Model 341A controls as follows:

FUNCTION	ON
RANGE	10
Voltage Dials	<u>10.00000</u>

- c. Attach all covers, and allow instrument to operate for at least 1 hour.

**4-64. REFERENCE VOLTAGE ADJUSTMENT**

- a. Unfasten the top cover and slide back just far enough to expose REF ADJUST control R26 and test point TP2.
- b. Connect the 895A differential voltmeter to TP2, using + SENSE as common.

- c. Adjust R26 for an 895A indication of  $15 \pm 0.0001$  volts dc.
- d. Disconnect the 895A, and position the top cover so that only the beta string calibration controls are exposed.

**4-65. ZERO OUTPUT ADJUSTMENTS**

- a. Set Model 341A voltage dials to zero, and connect the negative OUTPUT terminal to chassis ground.
- b. Zero the 895A on the 1, volt range, with null sensitivity set to 100 microvolts, then connect the 895A to the Model 341A OUTPUT terminals using low-thermal copper leads.
- c. Set RANGE switch to 10, and adjust the 10V ZERO ADJUST control for zero ( $\pm 5$  microvolts) indication on the 895A.

**WARNING!**

Use only an insulated tool for all adjustments within the beta string compartment.

- d. Set RANGE switch to 100, and adjust the 100V ZERO ADJUST control for zero ( $\pm 10$  microvolts) indication on the 895A
- e. Set RANGE switch to 1000, and adjust the 1000V ZERO ADJUST control for zero ( $\pm 10$  microvolts) indication on the 895A.

**4-66. BETA STRING LINEARITY ADJUSTMENTS**

- a. Set RANGE switch to 100, and connect the 895A to the Model 341A OUTPUT terminals, with the Model 341A negative OUTPUT terminal connected to chassis ground.
- b. Set the Model 341A controls as shown in Figure 4-10 and perform the indicated operations (step c. through step n.).

**4-67. RANGE ADJUSTMENTS**

- a. Connect the 895A to the OUTPUT terminals, with the Model 341A negative OUTPUT terminal connected to chassis ground.
- b. Set the Model 341A controls as follows:
- |               |                 |
|---------------|-----------------|
| FUNCTION      | ON              |
| RANGE         | 10              |
| Voltage dials | <u>10.00000</u> |



STEP	VOLTAGE DIAL POSITION	OPERATION
c.	0X.0000	Record voltage indication within 10 uv.
d.	10.0000	Adjust 10V LINEARITY to within 50 uv of step c.
e.	1X.0000	Record voltage indication within 40 uv.
f.	20.0000	Adjust 20V LINEARITY to within 70 uv of step e.
g.	3X.0000	Record voltage indication within 40 uv.
h.	40.0000	Adjust 40V LINEARITY to within 70 uv of step g.
i.	5X.0000	Record voltage indication within 40 uv.
j.	60.0000	Adjust 60V LINEARITY to within 70 uv of step i.
k.	7X.0000	Record voltage indication within 40 uv.
l.	80.0000	Adjust 80V LINEARITY to within 70 uv of step k.
m.	9X.0000	Record voltage indication within 40 uv.
n.	100.0000	Adjust 100V LINEARITY to within 70 uv of step m.

Figure 4-10. 341A LINEARITY ADJUSTMENTS

- c. Adjust 10V RANGE ADJUST for  $10 \pm 0.00003$  volts indication on the 895A.
- d. Set RANGE switch to 100, and adjust 100V RANGE ADJUST for  $100 \pm 0.0004$  volts indication on the 895A.
- e. Set RANGE switch to 1000 and adjust 1000V RANGE ADJUST for  $1000 \pm 0.004$  volts indication on the 895A.

#### 4-68. CALIBRATION VERIFICATION

4-69. The following measurements should be made immediately following the range adjustments, paragraph 4-67.

- a. Connect the 895A to the OUTPUT terminals, with the Model 341A negative OUTPUT terminal connected to chassis ground.

**NOTE!**

*Use the same 895A that was used for the range adjustments.*

- b. Set the Model 341A voltage dials as shown in Figure 4-11. The output voltages should be as indicated in column 1 for an instrument that has just been calibrated. In no case should the output error exceed the tolerances given in column 2, which are derived from instrument specifications found in Section I of the manual.

RANGE	VOLTAGE DIAL POSITION	OUTPUT-- VDC	
		1	2
10	0.00000	$0 \pm 0.00001$	$0 \pm 0.00002$
100	00.0000	$0 \pm 0.00002$	$0 \pm 0.0001$
1000	000.000	$0 \pm 0.00006$	$0 \pm 0.001$
10	10.00000	$10 \pm 0.0002$	$10 \pm 0.001$
10	5.00000	$5 \pm 0.0002$	$5 \pm 0.0005$
100	100.0000	$100 \pm 0.002$	$100 \pm 0.01$
100	50.0000	$50 \pm 0.002$	$50 \pm 0.005$
100	10.0000	$10 \pm 0.0005$	$10 \pm 0.001$
100	05.0000	$5 \pm 0.0003$	$5 \pm 0.0005$
1000	1000.000	$1000 \pm 0.02$	$1000 \pm 0.1$
1000	500.000	$500 \pm 0.02$	$500 \pm 0.05$
1000	100.000	$100 \pm 0.005$	$100 \pm 0.01$
100	050.000	$50 \pm 0.003$	$50 \pm 0.005$

Figure 4-11. 341A OUTPUT VOLTAGE REQUIREMENTS

- c. Calibration of the Model 341A is complete. Set the FUNCTION switch to OFF and disconnect equipment.

#### 4-70. MODEL 343A PRELIMINARY CALIBRATION

4-71. Preliminary calibration of the Model 343A consists of three main steps, ordered as follows: (1) reference voltage adjustment, (2) preliminary zero output and beta string adjustments, and (3) temperature stabilization. Before attempting calibration, instrument performance should be examined according to the performance tests of paragraph 4-24 to ensure that no malfunctions exist.

#### 4-72. PRELIMINARY OPERATIONS

- a. Connect the Model 343A to the autotransformer, and adjust the autotransformer for 115 volts output.
- b. Set the Model 343A controls as follows:

FUNCTION	ON
RANGE	10
Voltage dials	10.000000
CURRENT LIMIT	Fully clockwise

c. Attach all covers, and allow instrument to operate for at least 1 hour.

b. Set the Model 343A controls as shown in Figure 4-12, and perform the indicated operations.

**4-73. REFERENCE VOLTAGE ADJUSTMENT**

- a. Unfasten the top cover and slide back just far enough to expose REF ADJUST control R26 and test point TP2.
- b. Connect the 895A differential voltmeter to TP2, using + SENSE as common.
- c. Adjust R26 for an 895A indications of  $15 \pm 0.0001$  volts dc.
- d. Disconnect the 895A, and position the top cover so that only the beta string calibration controls are exposed.

**4-74. ZERO OUTPUT ADJUSTMENTS**

- a. Set Model 343A voltage dials to zero, and connect the negative OUTPUT terminal to chassis ground.
- b. Zero the 895A on the 1 volt range, with null sensitivity set to 100 microvolts, then connect the 895A to the Model 343A OUTPUT terminals using low-thermal copper leads.
- c. Set RANGE switch to 10, and adjust the 10V ZERO ADJUST control for zero ( $\pm 4$  microvolts) indication on the 895A.

**WARNING!**

Use only an insulated tool for all adjustments within the beta string compartment.

- d. Set RANGE switch to 100, and adjust the 100V ZERO ADJUST control for zero ( $\pm 10$  microvolts) indication on the 895A.
- e. Set RANGE switch to 1000, and adjust the 1000V ZERO ADJUST control for zero ( $\pm 10$  microvolts) indication on the 895A.

**4-75. BETA STRING LINEARITY ADJUSTMENTS**

- a. Set RANGE switch to 1000, and connect the 895A to the Model 343A OUTPUT terminals, with the Model 343A negative OUTPUT terminal connected to chassis ground.

STEP	RANGE	VOLTAGE DIAL POSITION	OPERATION
c.	1000	00X.0000	Record voltage indication within 10 uv.
d.	1000	010.0000	Adjust DECK B 1 to within 10 uv of step c.
e.	1000	01X.0000	Record voltage indication within 30 uv.
f.	1000	020.0000	Adjust DECK B 2 to within 30 uv of step e.
g.	1000	03X.0000	Record voltage indication within 30 uv.
h.	1000	040.0000	Adjust DECK B 4 to within 30 uv of step g.
i.	1000	05X.0000	Record voltage indication within 30 uv.
j.	1000	060.0000	Adjust DECK B 6 to within 40 uv of step i.
k.	1000	07X.0000	Record voltage indication within 40 uv.
l.	1000	080.0000	Adjust DECK B 8 to within 40 uv of step k.
m.	1000	09X.0000	Record voltage indication within 60 uv.
n.	1000	0X0.0000	Adjust DECK B X to within 60 uv of step m.
o.	100	0X.00000	Record voltage indication within 10 uv.
p.	100	10.00000	Adjust DECK A 1 to within 10 uv of step o.
q.	100	1X.00000	Record voltage indication within 30 uv.
r.	100	20.00000	Adjust DECK A 2 to within 30 uv of step q.
s.	100	3X.00000	Record voltage indication within 30 uv.

Figure 4-12. MODEL 343A PRELIMINARY LINEARITY ADJUSTMENTS (Sheet 1 of 2)

STEP	RANGE	VOLTAGE DIAL		OPERATION
		POSITION		
t.	100	40.00000		Adjust DECK A 4 to within 30 uv of step s.
u.	100	5X.00000		Record voltage indication within 30 uv.
v.	100	60.00000		Adjust DECK A 6 to within 40 uv of step u.
w.	100	7X.00000		Record voltage indication within 40 uv.
x.	100	80.00000		Adjust DECK A 8 to within 40 uv of step w.
y.	100	9X.00000		Record voltage indication within 60 uv.
z.	100	100.00000		Adjust DECK A 10 to within 60 uv of step y.

Figure 4-12. MODEL 343A PRELIMINARY LINEARITY ADJUSTMENTS (Sheet 2 of 2)

#### 4-76. TEMPERATURE STABILIZATION

- Install all instrument covers.
- Set RANGE to 100 and voltage dials to 100.00000.
- Operate the instrument continuously for at least 2 hours in an ambient temperature of  $23^{\circ}\text{C} \pm 1^{\circ}\text{C}$ , prior to beginning final calibration.

#### 4-77. MODEL 343A FINAL CALIBRATION

4-78. Final calibration of the Model 343A consists of the tests and adjustments of paragraphs 4-79 through 4-84. Calibration should be completed without interruption, and control positions should be maintained from step to step unless otherwise instructed.

#### NOTE!

*Ensure that the ambient temperature conditions specified in paragraph 4-76 are maintained throughout the remainder of the Model 343A calibration.*

#### 4-79. ZERO OUTPUT ADJUSTMENTS

- Unfasten the top cover and slide back just far enough to expose the beta string calibration controls.

- Connect the 845AR to the Model 343A output terminals, with the Model 343A negative OUTPUT terminal connected to chassis ground.
- Set the Model 343A RANGE to 10 and voltage dials to zero.
- Zero the 845AR on the 1 microvolt range.
- Adjust the 10V ZERO ADJUST control for a null indication ( $\pm 2$  microvolts) on the 845AR.
- Set the Model 343A RANGE to 100, and adjust the 100V ZERO ADJUST control for a null indication ( $\pm 2$  microvolts) on the 845AR.
- Set the Model 343A RANGE to 1000, and adjust the 1000V ZERO ADJUST control for a null indication ( $\pm 10$  microvolts) on the 845AR.

#### 4-80. BETA STRING LINEARITY ADJUSTMENTS

##### 4-81. Deck "B" Adjustments.

- Connect the equipment as shown in Figure 4-13.

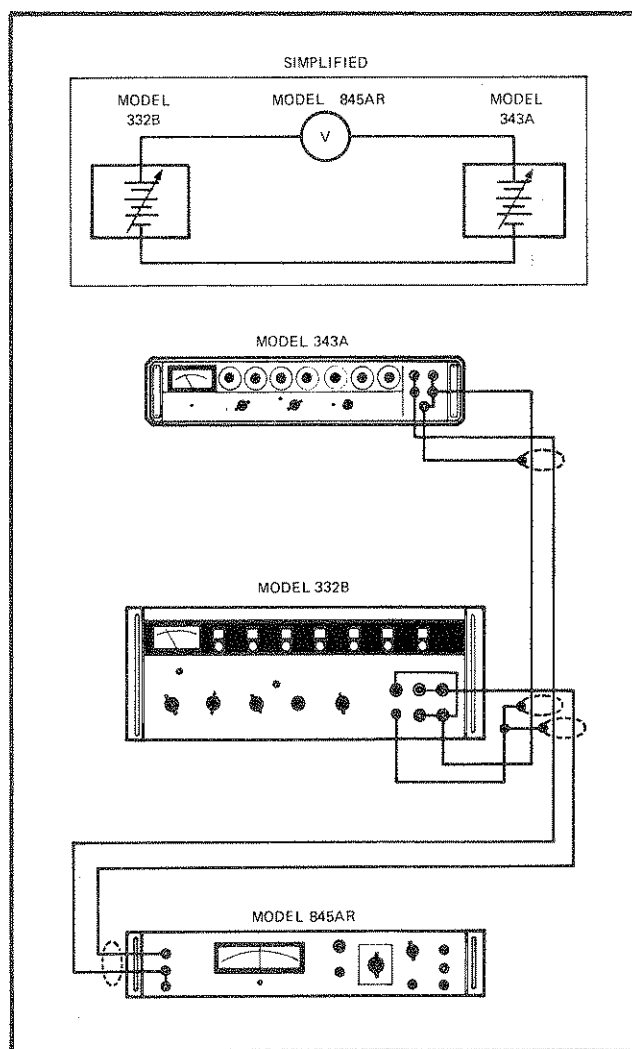

Figure 4-13. BETA STRING LINEARITY TEST SETUP.

- b. Set the 332B VOLTAGE RANGE to 100.
- c. Set the Model 343A and 332B voltage dials as shown in Figure 4-14 and perform the indicated operations.

STEP	332B VOLTAGE DIALS	343A VOLTAGE DIALS	OPERATION
d.	10.00000	00X.0000	Adjust the 332B dials for zero ( $\pm 10$ uv) on the 845AR.
e.	10.00000	010.0000	Adjust DECK B 1 for an 845AR indication within 10 uv of step d.
f.	20.00000	01X.0000	Adjust the 332B dials for zero ( $\pm 10$ uv) on the 845AR.
g.	20.00000	020.0000	Adjust DECK B 2 for an 845AR indication within 10 uv of step f.
h.	40.00000	03X.0000	Adjust the 332B dials for zero ( $\pm 20$ uv) on the 845AR.
i.	40.00000	040.0000	Adjust DECK B 4 for an 845AR indication within 20 uv of step h.
j.	60.00000	05X.0000	Adjust the 332B dials for zero ( $\pm 20$ uv) on the 845AR.
k.	60.00000	060.0000	Adjust DECK B 6 for an 845AR indication within 20 uv of step j.
l.	80.00000	07X.0000	Adjust the 332B dials for zero ( $\pm 40$ uv) on the 845AR.
m.	80.00000	080.0000	Adjust DECK B 8 for an 845AR indication within 40 uv of step l.
n.	100.00000	09X.0000	Adjust the 332B dials for zero ( $\pm 40$ uv) on the 845AR
o.	100.00000	0X0.0000	Adjust DECK B X for an 845AR indication within 40 uv of step n.

Figure 4-14. 343A LINEARITY ADJUSTMENTS - DECK B

4-82. Deck "A" Adjustments

- a. Set the Model 343A and 332B RANGE to 100.
- b. Set the Model 343A and 332B voltage dials as shown in Figure 4-15 and perform the indicated operations.

STEP	332B VOLTAGE DIALS	343A VOLTAGE DIALS	OPERATION
c.	10.00000	0X.0000	Adjust the 332B dials for zero ( $\pm 10$ uv) on the 845AR.
d.	10.00000	10.0000	Adjust DECK A 1 for an 845AR indication within 10 uv of step c.
e.	20.00000	1X.0000	Adjust the 332B dials for zero ( $\pm 10$ uv) on the 845AR.
f.	20.00000	20.0000	Adjust DECK A 2 for an 845AR indication within 10 uv of step e.
g.	40.00000	3X.0000	Adjust the 332B dials for zero ( $\pm 20$ uv) on the 845AR.
h.	40.00000	40.0000	Adjust DECK A 4 for an 845AR indication within 20 uv of step g.
i.	60.00000	5X.0000	Adjust the 332B dials for zero ( $\pm 20$ uv) on the 845AR.
j.	60.00000	60.0000	Adjust DECK A 6 for an 845AR indication within 20 uv of step i.
k.	80.00000	7X.0000	Adjust the 332B dials for zero ( $\pm 40$ uv) on the 845AR.
l.	80.00000	80.0000	Adjust DECK A 8 for an 845AR indication within 40 uv of step k.
m.	100.00000	9X.0000	Adjust the 332B dials for zero ( $\pm 40$ uv) on the 845AR
n.	100.00000	<u>100.0000</u>	Adjust DECK A10 for an 845AR indication within 40 uv of step m.

Figure 4-15. 343A LINEARITY ADJUSTMENTS - DECK A

o. Set Model 343A and 332B voltage controls for zero volts output.

**4-83. RANGE ADJUSTMENTS**

a. Connect equipment as shown in Figure 4-16.  
b. Set the Model 343A controls as follows:

RANGE	10
Voltage dials	<u>10.000000</u>
CURRENT LIMIT	Approximately 5 ma

c. Set the 750A input and output switches to 10.

d. Adjust the 332B controls for 10 volts output.  
e. Set the 750A standard cell circuit switch to MOMENTARY and adjust the 332B controls for zero ( $\pm 1$  microvolt) on 845AR No. 1.  
f. Adjust the 10V RANGE ADJUST control for zero ( $\pm 10$  microvolts) on 845AR No. 2.  
g. Set the Model 343A RANGE to 100 and voltage dials to 100.00000.  
h. Set the 750A input and output switches to 100.  
i. Adjust the 332B controls for 100 volts output.

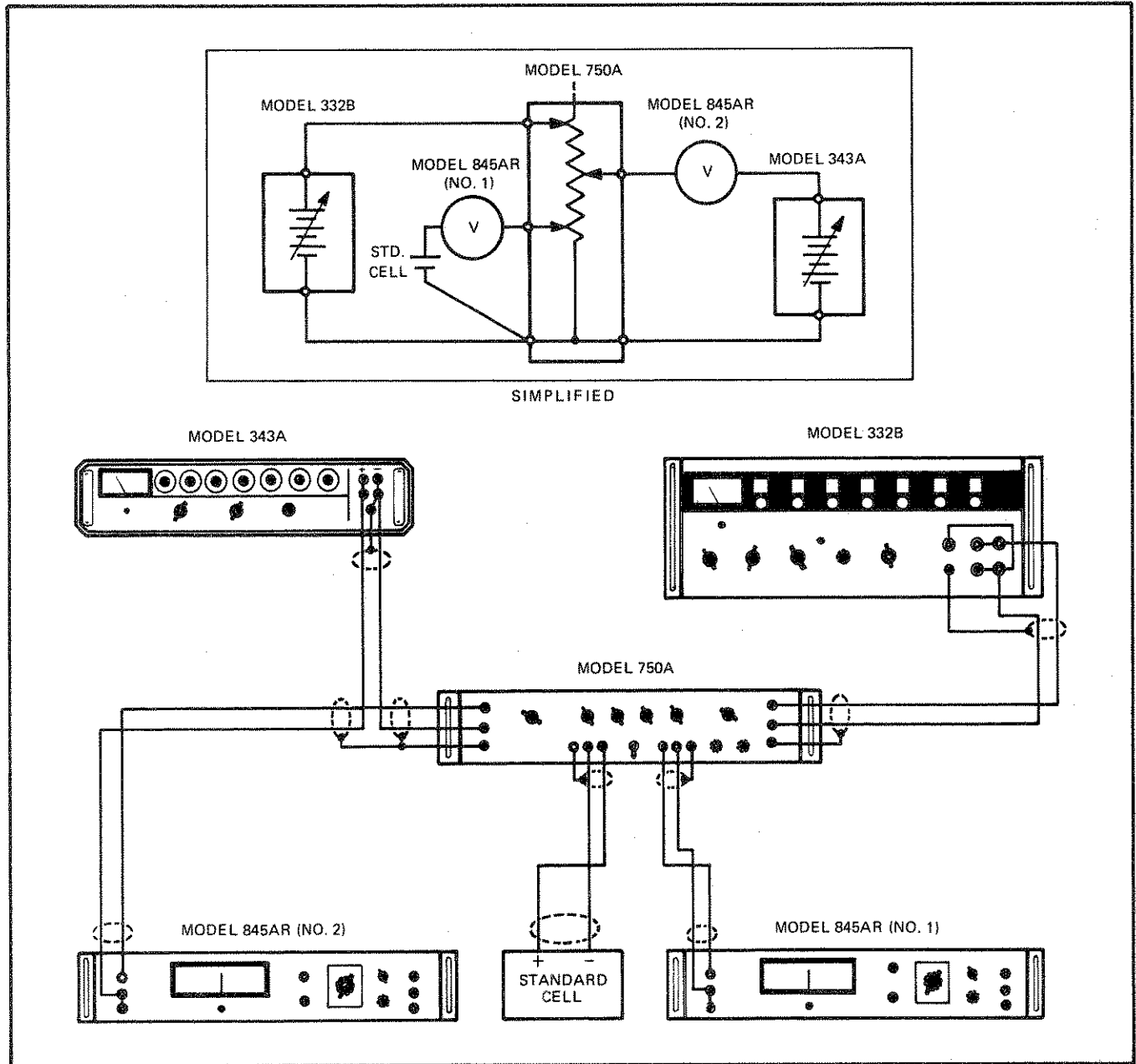

Figure 4-16. RANGE ADJUSTMENT AND CALIBRATION VERIFICATION TEST SETUP

- j. Repeat step e.
- k. Adjust the 100V RANGE ADJUST control for zero ( $\pm 100$  microvolts) on 845AR No. 2.
- l. Set the 343A RANGE to 1000 and voltage dials to 1000.0000.
- m. Set the 750A input and output switches to 1000.
- n. Adjust the 332B controls for 1000 volts output.
- o. Repeat step e.
- p. Adjust the 1000V RANGE ADJUST control for zero ( $\pm 1$  millivolt) on 845AR No. 1.

**NOTE!**

*Allow the Model 343A to stabilize (approximately 5 minutes) before making the 1000 volt range adjustment.*

**4-84. CALIBRATION VERIFICATION**

4-85. The following test should be performed immediately following Model 343A calibration.

- a. Leave equipment connected as shown in Figure 4-16.
- b. Perform the 750A standardization, paragraph 4-83, step e. Set the equipment controls as shown in Figure 4-17. The null indication obtained in each step should be within the indicated tolerance.

**NOTE!**

*The null tolerances listed in column 1 (Figure 4-17) apply to those instruments which have just been calibrated; in no case should the output error exceed the tolerances given in column 2, which are derived from instrument specifications found in Section I of the manual.*

- c. Set the Model 343A voltage dials to zero.
- d. Disconnect the 750A from the Model 343A OUTPUT terminals, and connect the 845AR directly to the Model 343A OUTPUT terminals. Ensure that the negative OUTPUT terminal is connected to chassis ground.
- e. Zero the 845AR on the 1 microvolt range.
- f. Set the Model 343A RANGE to 10 and voltage dials to zero. The 845AR should indicate zero ( $\pm 5$  microvolts).
- g. Set the Model 343A RANGE to 100. The 845AR should indicate zero ( $\pm 5$  microvolts).
- h. Set the Model 343A RANGE to 1000. The 845AR should indicate zero ( $\pm 20$  microvolts).
- i. Calibration of the Model 343A is complete. Set the FUNCTION switch to OFF and disconnect equipment.

750A		332B OUTPUT VOLTS	343A		845AR NO. 2 NULL TOLERANCE	
INPUT	OUTPUT		RANGE	VOLTAGE DIALS	1	2
10	1.0	10	10	1.000000	10 uv	30 uv
10	5	10	10	5.000000	50 uv	150 uv
10	10	10	10	<u>10.000000</u>	100 uv	300 uv
100	10	100	100	0X.000000	100 uv	300 uv
100	50	100	100	50.000000	100 uv	1.5 mv
100	100	100	100	<u>100.000000</u>	100 uv	3 mv
1000	100	1000	1000	100.0000	100 uv	3 mv
1000	500	1000	1000	500.0000	100 uv	15 mv
1000	1000	1000	1000	<u>1000.0000</u>	100 uv	30 mv

Figure 4-17. MODEL 343A OUTPUT VOLTAGE REQUIREMENTS

## SECTION V

### LIST OF REPLACEABLE PARTS

#### 5-1. INTRODUCTION

5-2. This section of the manual contains a listing of replaceable components for this instrument. The first listing contains a complete breakdown of all the major assemblies followed by subsequent listings that itemize the components on each major assembly. An illustration accompanies each major assembly listing to aid in locating the listed components.

5-3. Assemblies and subassemblies are identified by a reference designation beginning with the letter A followed by a number (e.g., A1 etc.). Electrical components appearing on the schematic diagram are identified by their schematic diagram reference designation. Components not appearing on the schematic diagram are consecutively numbered throughout the parts list. These components are identified with whole numbers on the arrow call-out illustrations and by index numbers on the grid illustrations. Flagnotes are used throughout the parts list and refer to special ordering explanations that are located in close proximity to the flagnotes.

#### 5-4. COLUMN DESCRIPTION

- a. The REF DESIG column indexes the item description to the associated illustration. In general the reference designations are listed under each assembly in alpha-numeric order. Subassemblies of minor proportions are sometimes listed with the assembly of which they are a part. In this case, the reference designations for the components of the subassembly may appear out of order.
- b. The INDEX NO. column lists coordinates which locate the designated part on the associated grid illustrations.
- c. The DESCRIPTION column describes the salient characteristics of the component. Indentation of the description indicates the relationship to other assemblies, components, etc. In many cases it is necessary to abbreviate in this column. For abbreviations and symbols used, see the following page.
- d. The ten-digit part number, by which the item is identified at the John Fluke Mfg. Co., is listed in the STOCK NO. column. Use this number when ordering parts from the factory or authorized representatives.
- e. The Federal Supply Code for the item manufacturer is listed in the MFR column. An abbreviated list of Federal Supply Codes is included in the Appendix.
- f. The part number which uniquely identifies the item to the original manufacturer is listed in the MFR PART NO. column. If a component must be ordered by description, the type number is listed.
- g. The TOT QTY column lists the total quantity of the items used in the instrument and reflects the latest Use Code. Second and subsequent listings of the same item are referenced to the first listing with the abbreviation REF. In the case of optional subassemblies, plug ins, etc. that are not always part of the instrument, or are deviations from the basic instrument model, the TOT QTY column lists the total quantity of the item in that particular assembly.
- h. Entries in the REC QTY column indicate the recommended number of spare parts necessary to support one to five instruments for a period of two years. This list presumes an availability of common electronic parts at the maintenance site. For maintenance for one year or more at an isolated site, it is recommended that at least one of every part in the instrument be stocked. In the case of optional subassemblies, plug-ins, etc. that are not always part of the instrument, or are deviations from the basic instrument model, the REC QTY column lists the recommended quantity of the item in that particular assembly.
- i. The USE CODE column identifies certain parts which have been added, deleted or modified during the production of the instrument. Each part for which a Use Code has been assigned may be identified with a particular instrument serial number

by consulting the Serial Number Effectivity List at the end of the parts list. Sometimes when a part is changed, the new part can and should be used as a replacement for the original part. In this event a parenthetical note is added in the DESCRIPTION column.

### 5-5. HOW TO OBTAIN PARTS

5-6. Standard components have been used wherever possible. Standard components may be ordered directly from the manufacturer by using the manufacturer's part number, or parts may be ordered from the John Fluke Mfg. Co. factory or authorized representative by using the Fluke part number. In the event the part you order has been replaced by a new or improved part, the replacement will be accompanied by an explanatory note and installation instructions, if necessary.

5-7. You can insure prompt and efficient handling of your order to the John Fluke Mfg. Co. if you include the following information:

- a. Quantity.
- b. FLUKE Stock Number.
- c. Description.
- d. Reference Designation.
- e. Instrument model and serial number.

Example: 2 each, 4805-177105, Transistors, 2N3565, Q107-108 for 845AR, s/n 168.

If you must order structural parts not listed in the parts list, describe the part as completely as possible. A sketch of the part, showing its location to other parts of the instrument, is usually most helpful.

---

### 5-8. LIST OF ABBREVIATIONS

ac	alternating current	MHz	megahertz	rf	radio frequency
Al	Aluminum	M	megohm	rfi	radio frequency interference
amp	ampere	met flm	metal film	res	resistor
assy	assembly	ua	microampere	rms	root mean square
cap	capacitor	uf	microfarad	rtry	rotary
car flm	carbon film	uh	microhenry	sec	second
C	centigrade	usec	microsecond	sect	section
cer	ceramic	uv	microvolt	S/N	serial number
comp	composition	ma	millampere	Si	silicon
conn	connector	mh	millihenry	scr	silicon controlled rectifier
db	decibel	m	milliohms	spdt	single-pole, double-throw
dc	direct current	msec	millisecond	spst	single-pole, single-throw
dpdt	double-pole, double-throw	mv	millivolt	sw	switch
dpst	double-pole, single-throw	mw	milliwatt	Ta	tantalum
elect	electrolytic	na	nanoampere	tstr	transistor
F	fahrenheit	nsec	nanosecond	tvm	transistor voltmeter
Ge	germanium	nv	nanovolt	uhf	ultra high frequency
gmV	guaranteed minimum value	$\Omega$	ohm	vtvm	vacuum tube voltmeter
h	henry	ppm	parts per million	var	variable
Hz	hertz	piv	peak inverse voltage	vhf	very high frequency
hf	high frequency	p-p	peak to peak	vlf	very low frequency
IC	integrated circuit	pf	picofarad	v	volt
if	intermediate frequency	plstc	plastic	va	voltampere
k	kilohm	p	pole	vac	volts, alternating current
kHz	kilohertz	pos	position	vdc	volts, direct current
kv	kilovolt	P/C	printed circuit	w	watt
lf	low frequency			ww	wire wound



REF DESIG	INDEX NO	DESCRIPTION	STOCK NO	MFR	MFR PART NO	TOT QTY	REC QTY	USE CODE
		<b>DC VOLTAGE CALIBRATOR</b> Figure 5-1	341A					
A1		Front Panel Assembly (See Figure- 5-2)						
A2		Rear Panel Assembly (See Figure 5-3)						
A3		Main P/C Assembly (See Figures 5-4 & 5-5)	1702-240143	89536	1702-240143	1		
A4		Reference P/C Assembly (See Figure 5-6)	3158-240101	89536	3158-240101	1		
A5		Sample String P/C Assembly (See Figure 5-7)	3158-263012	89536	3158-263012	1		
C49		Cap, oil, 1 uf $\pm 10\%$ , 1500v	1505-247023	56289	264P70	1		
C62		Cap, cer, 1 uf, gm, 3v	1501-106567	14655	HCC3105P	3		
C66		Cap, plstc, 0.047 uf $\pm 20\%$ , 1600v	1507-246694	84411	Type 663 UW	1		
CR58		Diode, silicon, 1 amp, 100 piv	4802-116111	05277	IN4817	25		
M1		Meter, 0-1.0v, 0-30 ma	2901-246942	89536	2901-246942	1		
R41		Res, var, comp, 5k $\pm 10\%$ , 3w	4701-247031	71450	321S502A	1		
R177		Res, comp, 1 $\Omega$ $\pm 5\%$ , 1/2w	4704-218693	01121	EB10G5	1		
S1		Switch, rotary, Decade 1 Switch section, decks A & B Switch section, decks C & D	5105-257238 5105-257246	89536 89536	5105-257238 5105-257246	1 1		
S8		Switch, rotary, FUNCTION	5105-257261	89536	5105-257261	1		
S9		Switch, rotary, RANGE Switch section, decks A & B Switch section, decks C & D	5105-257212 5105-257220	89536 89536	5105-257212 5105-257220	1 1		
T1		Transformer, power	5602-240465	89536	5602-240465	1		
1		Bail, tilt-down (not illustrated)	3154-231407	89536	3154-231407	1		
2		Cover, bottom (not illustrated)	3156-240382	89536	3156-240382	1		
3		Cover, top (not illustrated)	3156-240374	89536	3156-240374	1		
4		Detent, switch, S1	5105-257287	89536	5105-257287	1		
5		Detent, switch, S2 thru S6	5105-257295	89536	5105-257295	5		
6		Detent, switch, S9	5105-257279	89536	5105-257279	1		
7		Foot (not illustrated)	3155-230037	89536	3155-230037	4		
8		Shaft extension, S2 thru S6	3155-240457	89536	3155-240457	5		

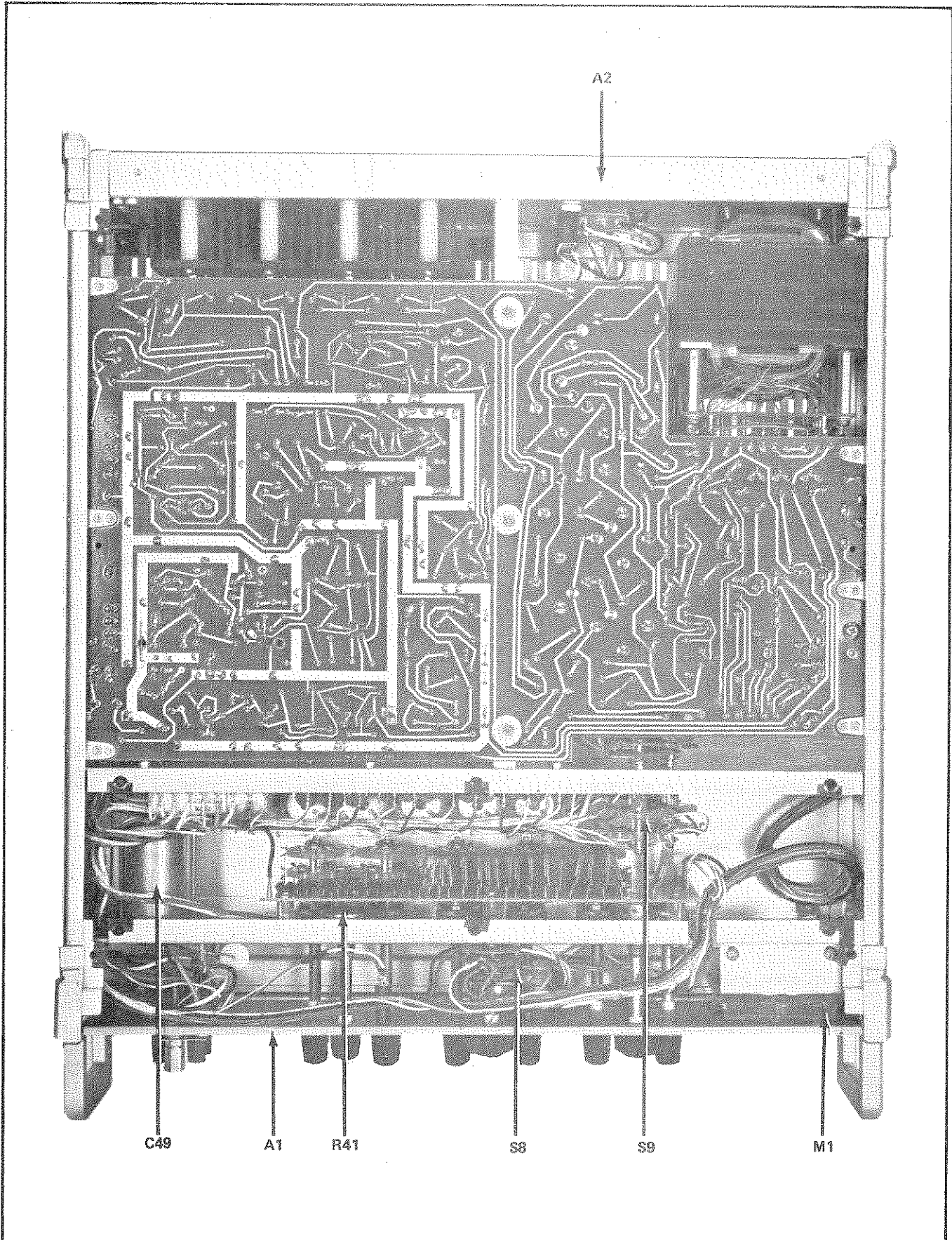

Figure 5-1. 341A DC VOLTAGE CALIBRATOR (Sheet 1 of 2)

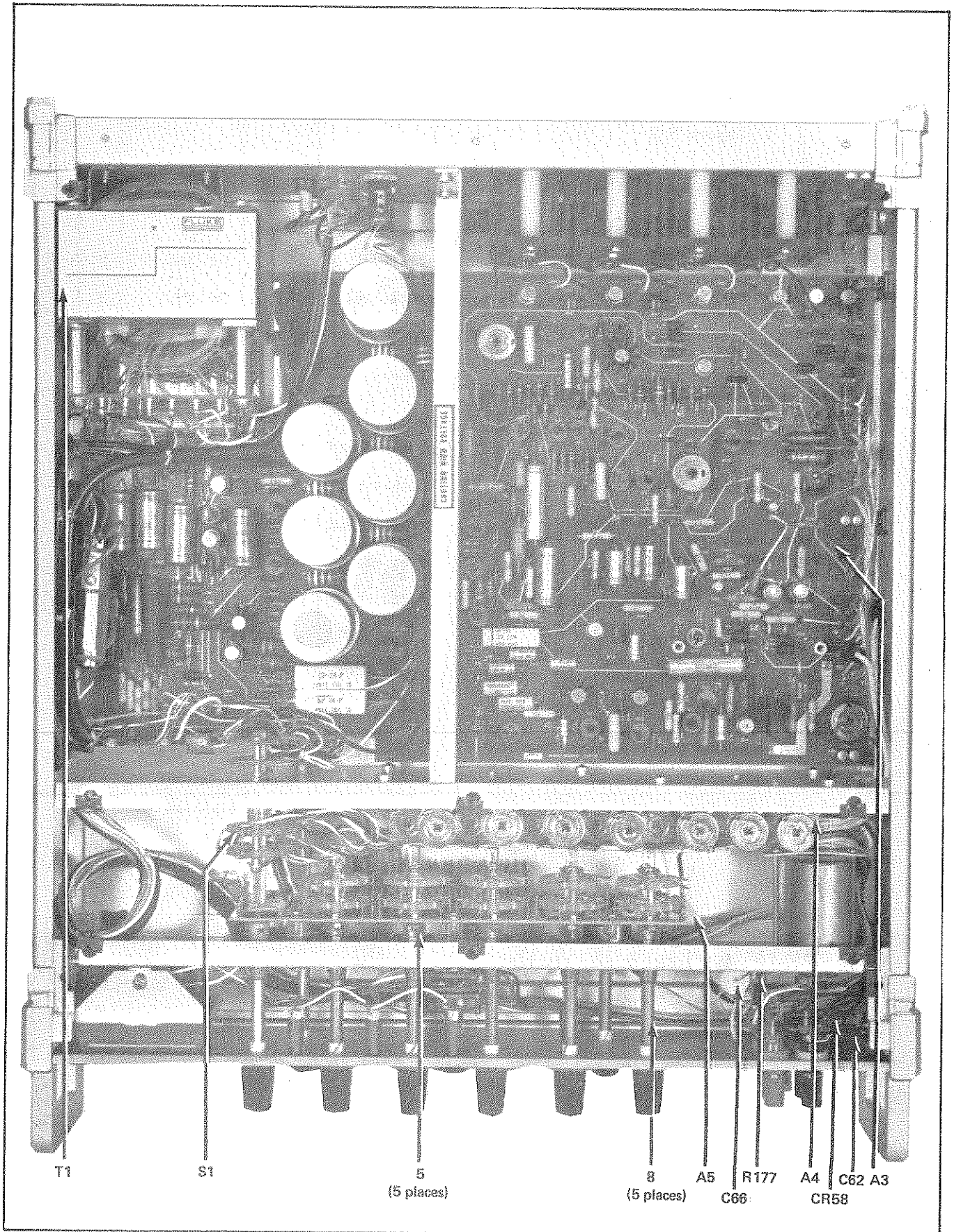

Figure 5-1. 341A DC VOLTAGE CALIBRATOR (Sheet 2 of 2)

REF DESIG	INDEX NO	DESCRIPTION	STOCK NO	MFR	MFR PART NO	TOT QTY	REC QTY	USE CODE
A1		<b>FRONT PANEL ASSEMBLY (341A)</b> Figure 5-2						
DS3 thru DS7		Lamp, incandescent, 28v	3901-246686	08806	7387	5	2	
J1, J2		Binding post, red	2811-226308	58474	DF21RC	2		
J3, J4		Binding post, black	2811-226282	58474	DF21BC	2		
J5		Binding post, white	2811-261156	58474	DF21WTC	1		
XDS3 thru XDS7		Holder, lamp	3155-252411	89536	3155-252411	5		
9		Handle	2404-246306	89536	2404-246306	2		
10		Knob, CURRENT LIMIT	2405-190249	89536	2405-190249	1		
11		Knob, DIGIT, 0-X	3155-252353	89536	3155-252353	5		
12		Knob, DIGIT, 0-10	3155-252361	89536	3155-252361	1		
13		Knob, FUNCTION, RANGE	2405-158956	89536	2405-158956	2		
14		Lens, lamp, clear	3155-222596	89536	3155-222596	3		
15		Lens, lamp, red	3155-228056	89536	3155-228056	2		
16		Link, Shorting	2811-101220	24655	0938-9712	3		
17		Panel, Front	1406-240267	89536	1406-240267	1		

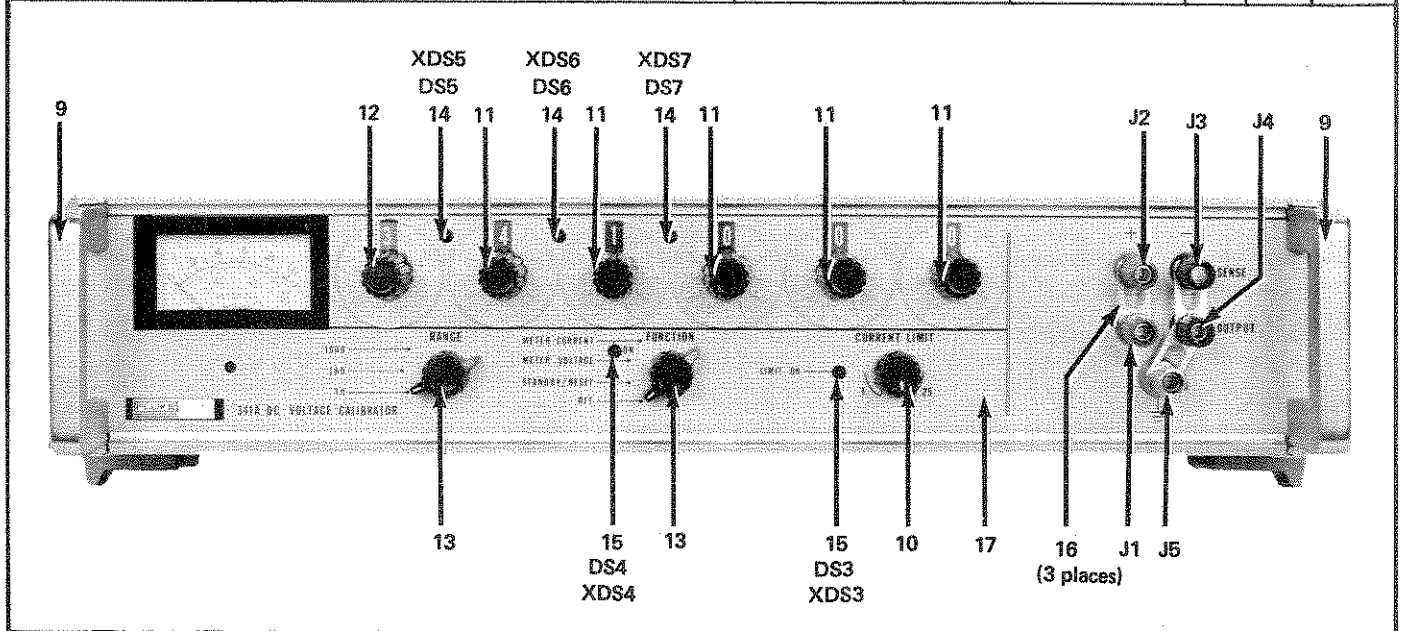

Figure 5-2. FRONT PANEL ASSEMBLY (341A)

REF DESIG	INDEX NO	DESCRIPTION	STOCK NO	MFR	MFR PART NO	TOT QTY	REC QTY	USE CODE
A2		<b>REAR PANEL ASSEMBLY (341A)</b> Figure 5-3						
C59, C60		Cap, cer, 0.01 uf +80/-20%, 500v	1501-105668	56289	29C9B5	3		
F1		Fuse, slow blow, 1 amp, 250v (for 115v operation)	5101-109272	71400	Type MDL	1	3	
F1		Fuse, slow blow, 1/2 amp, 250v (for 230v operation)	5101-109322	71400	Type MDL	1	3	
F2		Fuse, slow blow, 1/16 amp, 250v	5101-163030	71400	Type MDL	1	3	
Q42, Q44, Q46, Q48		Tstr, silicon, NPN (behind heat sinks)	4811-190710	04713	2N3739	4	4	
W1		Line cord	6005-226027	89536	6005-226027	1		
XF1, XF2		Holder, Fuse	2102-160846	75915	342004	2		
18		Heat sink	3156-240432	89536	3156-240432	4		
19		Panel, rear	3156-240309	89536	3156-240309	1		

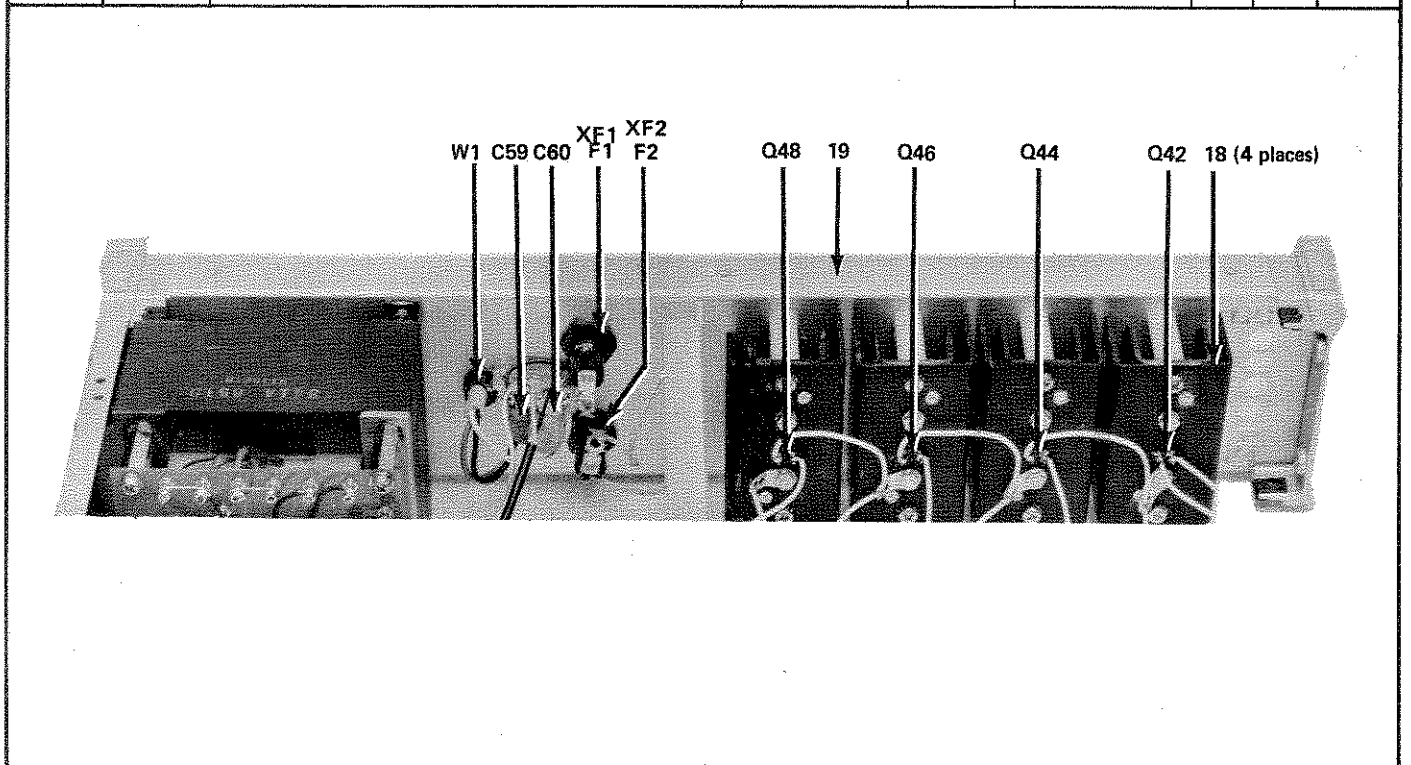

Figure 5-3. REAR PANEL ASSEMBLY (341A)

REF DESIG	INDEX NO	DESCRIPTION	STOCK NO	MFR	MFR PART NO	TOT QTY	REC QTY	USE CODE
A3		<b>MAIN P/C ASSEMBLY</b> Figure 5-4 & 5-5						
		Model 341A only	1702-240143	89536	1702-240143	REF		
		Model 343A only	1702-265322	89536	1702-265322	REF		
C1	B3-U3	Cap, elect, 80 uf +50/-10%, 450v (Fig. 5-4)	1502-246819	56289	Type 68D	6	1	
C2	K3-U3	Cap, elect, 80 uf +50/-10%, 450v (Fig. 5-4)	1502-246819	56289	Type 68D	REF		
C3	H3-T1	Cap, elect, 200 uf +50/-10%, 250v (Fig. 5-4)	1502-246827	56289	Type 68D	1		
C4	H1-Q5	Cap, cer, 1 uf, gm, 3v (Fig. 5-4)	1501-106567	14655	HCC3105P	REF		
C5	E1-P1	Cap, elect, 250 uf +50/-10%, 16v (Fig. 5-4)	1502-187765	73445	C437ARE250	2		
C7	G4-M5	Cap, elect, 10 uf +50/-10%, 25v (Fig. 5-5)	1502-170266	73445	C426ARF10	4		
C8	E3-S1	Cap, mica, 4 pf ±5%, 500v (Fig. 5-5)	1504-190397	14655	CD15C040K	1		
C9	G3-R3	Cap, plstc, 0.1 uf ±20%, 250v (Fig. 5-5)	1507-161992	73445	C280AE/ P100K	3		
C10	H3-M3	Cap, plstc, 0.015 uf ±2%, 100v (Fig. 5-5)	1507-233577	02799	1PC153G	2		
C11	F3-N3	Cap, plstc, 0.015 uf ±2%, 100v (Fig. 5-5)	1507-233577	02799	1PC153G	REF		
C14	G4-Q1	Cap, plstc, 0.47 uf ±20%, 250v (Fig. 5-5)	1507-184366	73445	C280AE/ P470K	3		
C15	H1-N3	Cap, plstc, 0.22 uf ±20%, 250v (Fig. 5-5)	1507-194803	73445	C230AE/ P220K	1		
C16	D1-S3	Cap, elect, 100 uf +75/-10%, 25v (Fig. 5-5)	1502-106518	80183	TE1211	2		
C17	G2-N5	Cap, elect, 100 uf +75/-10%, 25v (Fig. 5-5)	1502-106518	80183	TE1211	REF		
C18	B5-S4	Cap, elect, 5 uf +75/-10%, 25v (Fig. 5-5)	1502-152009	80183	TE1202	3		
C19	J1-P3	Cap, elect, 10 uf +50/-10%, 25v (Fig. 5-5)	1502-170266	73445	C426ARF10	REF		
C20	B4-Q3	Cap, plstc, 0.47uf ±20%, 250v (Fig. 5-5)	1507-184366	73445	C230AE/ P470K	REF		

REF DESIG	INDEX NO	DESCRIPTION	STOCK NO	MFR	MFR PART NO	TOT QTY	REC QTY	USE CODE
C21	J3-N4	Cap, plstc, 0.47 uf $\pm 20\%$ , 250v (Fig. 5-5)	1507-184366	73445	C280AE/ P470K	REF		
C22	F4-P2	Cap, elect, 250 uf $+50/-10\%$ , 40v (Fig. 5-4)	1502-178616	73445	C437ARG250	3	1	
C23	F4-N4	Cap, elect, 250 uf $+50/-10\%$ , 40v (Fig. 5-4)	1502-178616	73445	C437ARG250	REF		
C24	F3-Q1	Cap, elect, 250 uf $+50/-10\%$ , 40v (Fig. 5-4)	1502-178616	73445	C437ARG250	REF		
C25	F3-R3	Cap, elect, 400 uf $+50/-10\%$ , 25v (Fig. 5-4)	1502-168153	73445	C437ARF400	1		
C26	G5-U3	Cap, mica, 220 pf $\pm 5\%$ , 500v (Fig. 5-5)	1504-170423	14655	CD15F221J	2		
C27	I5-S5	Cap, mica, 68 pf $+5\%$ , 500v (Fig. 5-5)	1504-148510	14655	CD15F680J	1		
C28	H2-U3	Cap, elect, 10 uf $+50/-10\%$ , 25v (Fig. 5-5)	1502-170266	73445	C426ARF10	REF		
C29	H4-U3	Cap, elect, 10 uf $+50/10\%$ , 25v (Fig. 5-5)	1502-170266	73445	C426ARF10	REF		
C30	E4-T2	Cap, plstc, 0.1 uf $\pm 20\%$ , 250v (Fig. 5-5)	1507-161992	73445	C280AE/ P100K	REF		
C31	F1-P1	Cap, elect, 250 uf $+50/-10\%$ , 16v (Fig. 5-5)	1502-187765	73445	C437ARE250	REF		
C32	D4-N2	Cap, plstc, 0.33 uf $\pm 10\%$ , 200v (Fig. 5-5)	1507-106047	72928	355C334K	1		
C33	D2-N4	Cap, elect, 15 uf $+75/-10\%$ , 6v (Fig. 5-5)	1502-105700	80183	TE1089	2		
C34	D1-N2	Cap, elect, 15 uf $+75/-10\%$ , 6v (Fig. 5-5)	1502-105700	80183	TE1089	REF		
C35	C2-N3	Cap, elect, 30 uf $+75/-10\%$ , 15v (Fig. 5-5)	1502-106492	80183	TE1158	2		
C36	C4-N2	Cap, elect, 30 uf $+75/-10\%$ , 15v (Fig. 5-5)	1502-106492	80183	TE1158	REF		
C37	D1-P3	Cap, elect, 5 uf $+75/-10\%$ , 25v (Fig. 5-5)	1502-152009	80183	TE1202	REF		
C38	E5-P5	Cap, mica, 5 pf $\pm 10\%$ , 500v (Fig. 5-5)	1504-148577	14655	CD15C050K	1		
C39	E5-Q2	Cap, mica, 220 pf $\pm 5\%$ , 500v (Fig. 5-5)	1504-170423	14655	CD15F221J	REF		

REF DESIG	INDEX NO	DESCRIPTION	STOCK NO	MFR	MFR PART NO	TOT QTY	REC QTY	USE CODE
C40	D4-Q4	Cap, mica, 100 pf $\pm 5\%$ , 500v (Fig. 5-5)	1504-148494	14655	CD15F101J	2		
C41	E3-R1	Cap, mica, 620 pf $\pm 5\%$ , 500v (Fig. 5-5)	1504-215244	14655	CD19F621J	1		
C42	D3-Q5	Cap, elect, 5 uf +75/-10%, 25v (Fig. 5-5)	1502-152009	80183	TE1202	REF		
C43	F1-Q3	Cap, elect, 100 uf +75/-10%, 3v (Fig. 5-5)	1502-106534	80183	TE1059-5	2		
C44	F1-R1	Cap, elect, 50 uf +50/-10%, 25v (Fig. 5-5)	1502-168823	73445	C426ARF50	1		
C45	E4-R5	Cap, elect, 100 uf +75/-10%, 3v (Fig. 5-5)	1502-106534	80183	TE1059-5	REF		
C46	D5-S3	Cap, plstc, 0.047 uf $\pm 20\%$ , 200v (Fig. 5-5)	1507-162008	73445	C280AE/ P47K	1		
C47	E2-U3	Cap, plstc, 0.1 uf $\pm 20\%$ , 250v (Fig. 5-5)	1507-161992	73445	C280AE/ P100K	REF		
C48	G2-M5	Cap, cer, 0.01 uf, gm, 1.6 kv (Fig. 5-4)	1501-106930	71590	DD16-103	4		
C51	J5-U2	Cap, cer, 0.0012 uf $\pm 10\%$ , 500v (Fig. 5-5)	1501-106732	71590	CF-22	1		
C52	B4-U3	Cap, cer, 0.01 uf, gm, 1.6kv (Fig. 5-4)	1501-106930	71590	DD16-103	REF		
C53	A5-V1	Cap, cer, 0.01 uf, gm, 1.6kv (Fig. 5-4)	1501-106930	71590	DD16-103	REF		
C54	H3-V1	Cap, cer, 0.005 uf $\pm 20\%$ , 3kv (Fig. 5-4)	1501-188003	71590	2DDH6R502M	1		
C55	G3-U3	Cap, elect, 80 uf +50/-10%, 450v (Fig. 5-4)	1502-246819	56289	Type 68D	REF		
C56	F3-T1	Cap, elect, 80 uf +50/-10%, 450v (Fig. 5-4)	1502-246819	56289	Type 68D	REF		
C57	E3-U3	Cap, elect, 80 uf +50/-10%, 450v (Fig. 5-4)	1502-246819	56289	Type 68D	REF		
C58	D3-T1	Cap, elect, 80 uf +50/-10%, 450v (Fig. 5-4)	1502-246819	56289	Type 68D	REF		
C61	E4-R5	Cap, mica, 100 pf $\pm 5\%$ , 500v (Fig. 5-4)	1504-148494	14655	CD15F101J	REF		
C63	C4-V2	Cap, cer, 1 uf, gm, 3v(Fig. 5-5)	1501-106567	14655	HCC3105P	REF		
C64	J2-T4	Cap, cer, 0.01 uf +80/-10%, 500v (Fig. 5-4)	1501-105668	56289	29C9B5	REF		



REF DESIG	INDEX NO	DESCRIPTION	STOCK NO	MFR	MFR PART NO	TOT QTY	REC QTY	USE CODE
C65	K3-S1	Cap, cer, 0.01 uf, gm, 1.6 kv (Fig. 5-4)	1501-106930	71590	DD16-103	REF		
C67	C2-Q2	Cap, cer, 500 pf $\pm 10\%$ , 1 kv (Fig. 5-5)	1501-105692	71590	2DDH60N501K	1		
CR1	J2-S2	Diode, silicon, 1 amp, 600 piv (Fig. 5-4)	4802-112383	05277	1N4822	12	2	
CR2	K1-S2	Diode, silicon, 1 amp, 600 piv (Fig. 5-4)	4802-112383	05277	1N4822	REF		
CR3	H3-R1	Diode, silicon, 1 amp, 600 piv (Fig. 5-4)	4802-112383	05277	1N4822	REF		
CR4	I4-S2	Diode, silicon, 1 amp, 600 piv (Fig. 5-4)	4802-112383	05277	1N4822	REF		
CR5	K5-S2	Diode, silicon, 1 amp, 600 piv (Fig. 5-4)	4802-112383	05277	1N4822	REF		
CR6	G3-Q3	Diode, silicon, 150 ma (Fig. 5-4)	4805-203323	03508	DHD1105	10		
CR7	H5-Q1	Diode, silicon, 150 ma (Fig. 5-5)	4805-203323	03508	DHD1105	REF		
CR8	D4-N5	Diode, silicon, 150 ma (Fig. 5-4)	4805-203323	03508	DHD1105	REF		
CR9	F4-M4	Diode, silicon, 150 ma (Fig. 5-5)	4805-203323	03508	DHD1105	REF		
CR10	I4-M3	Diode, silicon, 150 ma (Fig. 5-5)	4805-203323	03508	DHD1105	REF		
CR11	F4-N1	Diode, silicon, 150 ma (Fig. 5-5)	4805-203323	03508	DHD1105	REF		
CR12	F2-M4	Diode, silicon, 150 ma (Fig. 5-5)	4805-203323	03508	DHD1105	REF		
CR17	B5-P3	Diode, zener, 18v (Fig. 5-5)	4809-113365	04713	1N3026A	1	1	
CR19	B5-Q2	Diode, zener, 12v (Fig. 5-5)	4809-249052	07910	1N963B	2		
CR20	B4-Q2	Diode, zener, 12v (Fig. 5-5)	4809-249052	07910	1N963B	REF		
CR21	J5-N3	Diode, zener, 6.8v (Fig. 5-5)	4809-166199	07910	1N754	1		
CR22	H2-N5	Diode, silicon, 1 amp, 100 piv (Fig. 5-4)	4802-116111	05277	1N4817	REF		
CR23	H2-P4	Diode, silicon, 1 amp, 100 piv (Fig. 5-4)	4802-116111	05277	1N4817	REF		



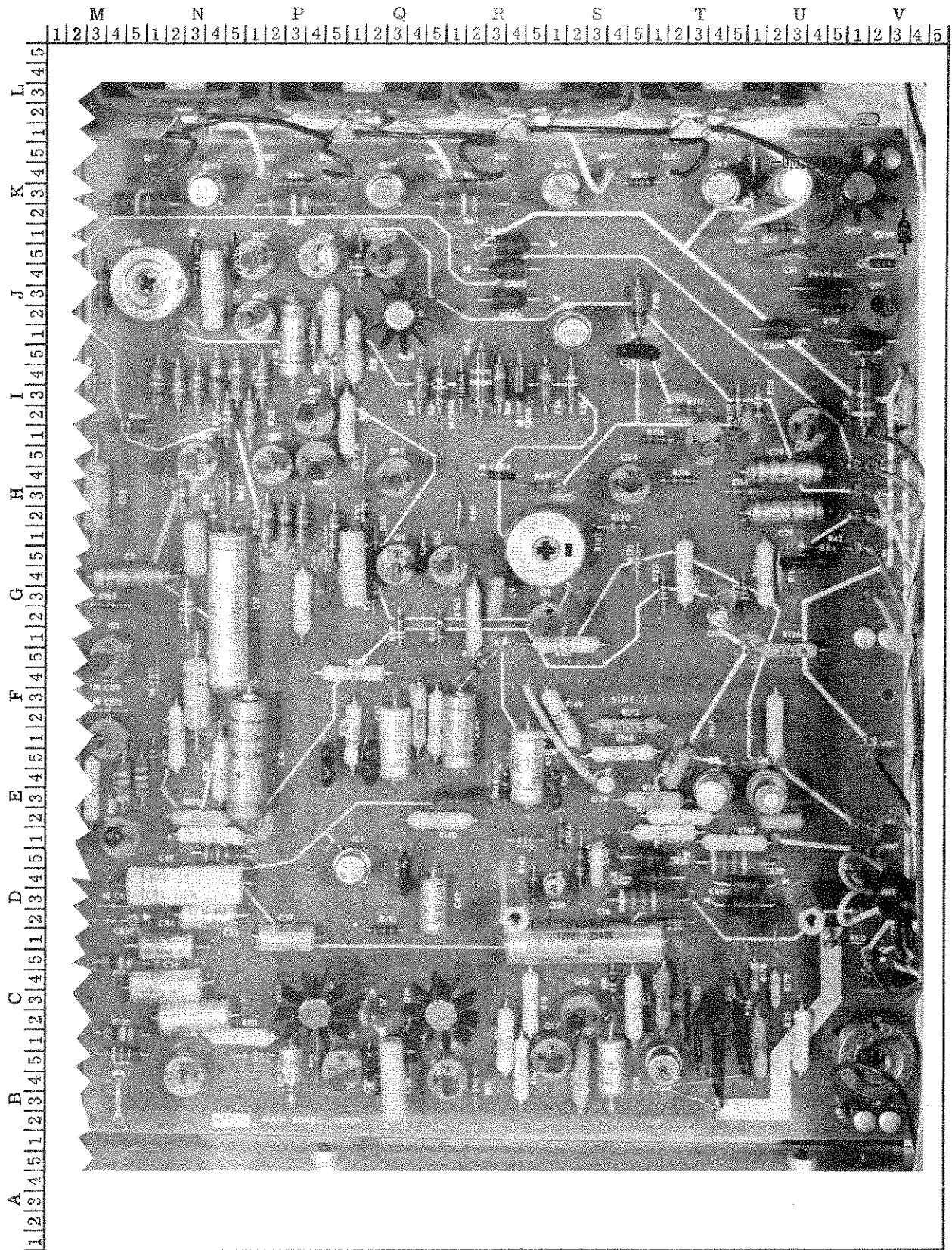



Figure 5-5. MAIN P/C ASSEMBLY (Right Hand Side)

REF DESIG	INDEX NO	DESCRIPTION	STOCK NO	MFR	MFR PART NO	TOT QTY	REC QTY	USE CODE
CR24	H2-P3	Diode, silicon, 1 amp, 100 piv (Fig. 5-4)	4802-116111	05277	1N4817	REF		
CR25	H2-P1	Diode, silicon, 1 amp, 100 piv (Fig. 5-4)	4802-116111	05277	1N4817	REF		
CR26	H2-Q1	Diode, silicon, 1 amp, 100 piv (Fig. 5-4)	4802-116111	05277	1N4817	REF		
CR27	H2-Q2	Diode, silicon, 1 amp, 100 piv (Fig. 5-4)	4802-116111	05277	1N4817	REF		
CR28	F2-R1	Diode, zener, 10v (Fig. 5-4)	4809-246611	07910	1N961B	2		
CR29	G4-R2	Diode, thyristor (Fig. 5-4)	4837-192567	03508	C-6F	1	1	
CR30	F1-Q3	Diode, silicon, 1 amp, 100 piv (Fig. 5-4)	4802-116111	05277	1N4817	REF		
CR31	F1-Q5	Diode, silicon, 1 amp, 100 piv (Fig. 5-4)	4802-116111	05277	1N4817	REF		
CR32	C5-T5	Diode, silicon, 1 amp, 600 piv (Fig. 5-4)	4802-112383	05277	1N4822	REF		
CR33	C4-U4	Diode, silicon, 1 amp, 600 piv (Fig. 5-4)	4802-112383	05277	1N4822	REF		
CR34	E2-S1	Diode, zener, 16v (Fig. 5-4)	4809-113332	07910	1N966A	1		
CR35	C2-S1	Diode, silicon, 1 amp, 600 piv (Fig. 5-4)	4802-112383	05277	1N4822	REF		
CR37	D4-T1	Diode, silicon, 1 amp, 100 piv (Fig. 5-5)	4802-116111	05277	1N4817	REF		
CR38	D5-T1	Diode, silicon, 1 amp, 100 piv (Fig. 5-5)	4802-116111	05277	1N4817	REF		
CR39	D4-U1	Diode, silicon, 1 amp, 100 piv (Fig. 5-5)	4802-116111	05277	1N4817	REF		
CR40	D3-U1	Diode, silicon, 1 amp, 100 piv (Fig. 5-5)	4802-116111	05277	1N4817	REF		
CR41	J5-R4	Diode, silicon, 1 amp, 100 piv (Fig. 5-5)	4802-116111	05277	1N4817	REF		
CR42	J4-R4	Diode, silicon, 1 amp, 100 piv (Fig. 5-5)	4802-116111	05277	1N4817	REF		
CR43	J3-R4	Diode, silicon, 1 amp, 100 piv (Fig. 5-5)	4802-116111	05277	1N4817	REF		
CR44	J1-U2	Diode, silicon, 1 amp, 100 piv (Fig. 5-5)	4802-116111	05277	1N4817	REF		
CR45	J1-V1	Diode, silicon, 1 amp, 100 piv (Fig. 5-5)	4802-116111	05277	1N4817	REF		
CR47	K4-U1	Diode, silicon, 1 amp, 100 piv (Fig. 5-5)	4802-116111	05277	1N4817	REF		
CR48	I3-R1	Diode, zener, 13v (Fig. 5-5)	4809-110726	07910	1N964B	1	2	
CR50	J3-U4	Diode, silicon, 1 amp, 100 piv (Fig. 5-5)	4802-116111	05277	1N4817	REF		
CR51	I3-T1	Diode, silicon, 1 amp, 600 piv (Fig. 5-4)	4802-112383	05277	1N4822	REF		





REF DESIG	INDEX NO	DESCRIPTION	STOCK NO	MFR	MFR PART NO	TOT QTY	REC QTY	USE CODE
CR52	H2-R5	Diode, silicon, 1 amp, 600 piv (Fig. 5-4)	4802-112383	05277	1N4822	REF		
CR53	D3-U4	Diode, silicon, 350 ma, 3000 piv (Fig. 5-4)	4801-246652	17545	35ST3	2	2	
CR54	D1-U4	Diode, silicon, 350 ma, 3000 piv (Fig. 5-4)	4801-246652	17545	35ST3	REF		
CR55	G3-R5	Diode, zener, 10v (Fig. 5-4)	4809-246611	07910	1N961B	REF		
CR56	D3-M4	Diode, silicon, 150 ma (Fig. 5-5)	4805-203323	03508	DHD1105	REF		
CR57	D2-M4	Diode, silicon, 150 ma (Fig. 5-5)	4805-203323	03508	DHD1105	REF		
CR59	D1-V4	Diode, silicon, 1 amp, 100 piv (Fig. 5-5)	4802-116111	05277	1N4817	REF		
CR60	G4-N2	Diode, silicon, 1 amp, 600 piv (Fig. 5-4)	4802-112383	05277	1N4822	REF		
CR61	F5-N2	Diode, silicon, 1 amp, 600 piv (Fig. 5-4)	4802-112383	05277	1N4822	REF		
CR64	H4-R3	Diode, zener, 6.2v (Fig. 5-5)	4809-180497	07910	1N753	1		
CR65	I4-R4	Diode, silicon, 1 amp, 100 piv (Fig. 5-5)	4802-116111	05277	1N4817	REF		
CR66	D1-P2	Diode, zener, 10v (Fig. 5-4)	4809-246611	07910	1N961B	REF		
CR67	E4-Q1	Diode, silicon, 150 ma (Fig. 5-4)	4805-203323	03508	DHD1105	REF		
CR68	C3-Q2	Diode, silicon, 1 amp, 100 piv (Fig. 5-4)	4802-116111	05277	1N4817	REF		
CR69	K1-V3	Diode, silicon, 1 amp, 100 piv (Fig. 5-5)	4802-116111	05277	1N4817	REF		
CR70	C1-T3	Diode, silicon, 150 ma, 6 piv (Fig. 5-5)	4805-113308	07910	CD13161	1		
DS1	D1-P5	Lamp, neon (Figure 5-4)	3902-100347	71744	NE2E	2		
DS2	C5-P5	Lamp, neon (Figure 5-4)	3902-100347	71744	NE2E	REF		
IC1	D5-Q1	IC, operational amplifier (Fig. 5-5)	3140-246603	04713	MC1709CG	1		
K1	E1-N2	Relay, dpdt, 115v, 15 amp (Fig. 5-4)	4504-246678	73949	245U2C24D	1		
K2	C3-S2 C2-T2	Relay (Fig. 5-4) Switch, dry reed Coil, reed switch, 24v	5103-184440 1802-186155	12617 71707	DRVT1 SP24P	2 2		
K3	B5-S2 B5-T2	Relay (Fig. 5-4) Switch, dry reed Coil, reed switch, 24v	5103-184440 1802-186155	12617 71701	DRVT1 SP24P	REF REF		

REF DESIG	INDEX NO	DESCRIPTION	STOCK NO	MFR	MFR PART NO	TOT QTY	REC QTY	USE CODE
L1	G5-Q4	Choke, RF, 1,000 uh, 140 ma (Fig. 5-4)	1801-147819	72259	WEE1000	1		
Q1	G2-S1	Tstr, silicon, NPN (Fig. 5-5)	4819-218396	04713	2N3904	14	3	
Q2	F5-M3	Tstr, silicon, NPN (Fig. 5-5)	4819-218396	04713	2N3904	REF		
Q3	F1-M3	Tstr, silicon, NPN (Fig. 5-5)	4819-218396	04713	2N3904	REF		
Q4	E3-U2	Tstr, silicon, NPN (Fig. 5-5)	4819-179374	04713	2N2218	2		
Q5	G4-Q3	Tstr, silicon, PNP (Fig. 5-5)	4818-195974	04713	2N3906	10	3	
Q6	G4-R1	Tstr, silicon, NPN (Fig. 5-5)	4819-218396	04713	2N3904	REF		
Q7	J1-S2	Tstr, silicon, PNP (Fig. 5-5)	4818-190389	04713	SM4144	2		
Q8	E3-T4	Tstr, silicon, NPN (Fig. 5-5)	4819-179374	04713	2N2218	REF		
Q9	I2-P4	Tstr, silicon, NPN (Fig 5-5)	4819-218396	04713	2N3904	REF		
Q10	H5-N3	Tstr, silicon, NPN (Fig. 5-5)	4819-218396	04713	2N3904	REF		
Q11	H5-P2	Tstr, silicon, PNP (Fig. 5-5)	4818-195974	04713	2N3906	REF		
Q12	H5-P4	Tstr, silicon, PNP (Fig. 5-5)	4818-195974	04713	2N3906	REF		
Q13	H4-Q3	Tstr, silicon, PNP (Fig. 5-5)	4818-195974	04713	2N3906	REF		
Q14	B5-T2	Tstr, Factory matched (Fig. 5-5)						
Q15	C2-S2	Tstr, silicon, NPN (Fig. 5-5)	4819-168708	03508	2N3391	2		
Q16	J5-P4	Tstr, silicon, PNP (Fig. 5-5)	4818-195974	04713	2N3906	REF		
Q17	B5-S1	Tstr, silicon, NPN (Fig. 5-5)	4819-168708	03508	2N3391	REF		
Q18	J2-P1	Tstr, silicon, PNP (Fig. 5-5)	4818-195974	04713	2N3906	REF		
Q19	C2-Q5	Tstr, silicon, NPN (Fig. 5-5)	4819-203489	07910	CDQ10656	4	2	

REF DESIG	INDEX NO	DESCRIPTION	STOCK NO	MFR	MFR PART NO	TOT QTY	REC QTY	USE CODE
Q20	B4-R1	Tstr, silicon, NPN (Fig. 5-5)	4819-218396	04713	2N3904	REF		
Q21	J2-Q3	Tstr, silicon, PNP (Fig. 5-5)	4818-190389	04713	SM4144	REF		
Q22	J5-Q2	Tstr, silicon, PNP (Fig. 5-5)	4818-195974	04713	2N3906	REF		
Q23	C2-P4	Tstr, silicon, NPN (Fig. 5-5)	4819-203489	07910	CDQ10656	REF		
Q24	J5-P1	Tstr, silicon, NPN (Fig. 5-5)	4819-218396	04713	2N3904	REF		
Q25	B4-P5	Tstr, silicon, NPN (Fig. 5-5)	4819-218396	04713	2N3904	REF		
Q26	G4-Q5	Tstr, silicon, NPN (Fig. 5-4)	4819-150359	95303	2N3053	2	1	
Q27	F3-Q4	Tstr, silicon, NPN (Fig. 5-4)	4819-150359	95303	2N3053	REF		
Q28	G2-S1	Tstr, silicon, NPN (Fig. 5-4)	4819-218396	04713	2N3904	REF		
Q29	E5-S1	Tstr, silicon, NPN (Fig. 5-4)	4819-218396	04713	2N3904	REF		
Q30	C5-R1	Tstr, silicon, NPN (Fig. 5-4)	4819-218511	95303	40327	6	4	
Q31	D3-R2	Tstr, silicon, NPN (Fig. 5-4)	4819-218511	95303	40327	REF		
Q32	I1-U4	Tstr, silicon, NPN (Fig. 5-5)	4819-218396	04713	2N3904	REF		
Q33	I1-T4	Tstr, silicon, PNP (Fig. 5-5)	4818-195974	04713	2N3906	REF		
Q34	H4-S5	Tstr, silicon, PNP (Fig. 5-5)	4818-195974	04713	2N3906	REF		
Q35	G2-T4	Tstr, Dual FET, N-channel (Fig. 5-5)	4828-248005	05397	2N3958	1	1	
Q36	E1-M4	Tstr, silicon, PNP (Fig. 5-5)	4818-225599	07263	S-22650	1		
Q37	B4-N2	Tstr, silicon, PNP (Fig. 5-5)	4818-195974	04713	2N3906	REF		
Q38	D4-S1	Tstr, FET, N-channel (Fig. 5-5)	4826-257121	07263	FE0654C	1	1	
Q39	E4-S4	Tstr, MOS FET, P-channel (Fig. 5-5)	4831-226043	07263	FT704	1	1	

REF DESIG	INDEX NO	DESCRIPTION	STOCK NO	MFR	MFR PART NO	TOT QTY	REC QTY	USE CODE
Q40	K3-V1	Tstr, silicon, NPN (Fig. 5-5)	4819-203489	07910	CDQ10656	REF		
Q41	K3-U3	Tstr, silicon, NPN (Fig. 5-5)	4819-203489	07910	CDQ10656	REF		
Q43	K3-T4	Tstr, silicon, NPN (Fig. 5-5)	4819-218511	95303	40327	REF		
Q45	K3-S1	Tstr, silicon, NPN (Fig. 5-5)	4819-218511	95303	40327	REF		
Q47	K3-Q2	Tstr, silicon, NPN (Fig. 5-5)	4819-218511	95303	40327	REF		
Q49	K3-N3	Tstr, silicon, NPN (Fig. 5-5)	4819-218511	95303	40327	REF		
Q50	J3-V2	Tstr, silicon, NPN (Fig. 5-5)	4819-218396	04713	2N3904	REF		
Q51	G1-Q4	Tstr, silicon, NPN (Fig. 5-4)	4819-218396	04713	2N3904	REF		
R1	G5-P4	Res, comp, 10 $\Omega$ $\pm$ 5%, 1/4w (Fig. 5-4)	4704-147868	01121	CB1005	2		
R2	G5-P1	Res, comp, 10 $\Omega$ $\pm$ 5%, 1/4w (Fig. 5-4)	4704-147868	01121	CB1005	REF		
R3	J4-Q1	Res, comp, 390 $\Omega$ $\pm$ 5%, 1/2w (Fig. 5-5)	4704-109082	01121	EB3915	1		
R4	J5-N5	Res, comp, 27k $\pm$ 5%, 1/4w (Fig. 5-5)	4704-148148	01121	CB2735	2		
R5	I4-N3	Res, comp, 5.6k $\pm$ 5%, 1/2w (Fig. 5-5)	4704-187880	01121	EB5625	1		
R6	I4-N4	Res, comp, 22 $\Omega$ $\pm$ 5%, 1/2w (Fig. 5-5)	4704-169847	01121	EB2205	1		
R7	I4-P1	Res, comp, 75k $\pm$ 5%, 1/2w (Fig. 5-5)	4704-108928	01121	EB7535	1		
R8	I4-N5	Res, comp, 7.5k $\pm$ 5%, 1/2w (Fig. 5-5)	4704-108910	01121	EB7525	2		
R9	J1-P4	Res, comp, 33k $\pm$ 5%, 1/4w (Fig. 5-5)	4704-148155	01121	CB3335	1		
R10	J2-P5	Res, met flm, 15k $\pm$ 1%, 1/2w (Fig. 5-5)	4705-151498	19701	Type MF7C	2		
R11	I5-Q1	Res, met flm, 15k $\pm$ 1%, 1/2w (Fig. 5-5)	4705-151498	19701	Type MF7C	REF		
R12	B5-P4	Res, comp, 2k $\pm$ 5%, 1/4w (Fig. 5-5)	4704-202879	01121	CB2025	3		



REF DESIG	INDEX NO	DESCRIPTION	STOCK NO	MFR	MFR PART NO	TOT QTY	REC QTY	USE CODE
R13	C1-R4	Res, met flm, 75k $\pm 1\%$ , 1/2w (Fig. 5-5)	4705-193961	19701	Type MF7C	1		
R14	C1-Q4	Res, comp, 1.5 $\Omega$ $\pm 5\%$ , 1/2w (Fig. 5-5)	4704-246793	01121	EB15G5	1		
R15	B4-R2	Res, comp, 75k $\pm 5\%$ , 1/4w (Fig. 5-5)	4704-220525	01121	CB7535	1		
R16	B4-R5	Res, met flm, 8.25k $\pm 1\%$ , 1/2w (Fig. 5-5)	4705-192492	19701	Type MF7C	1		
R17	B4-S2	Res, met flm, 57.6k $\pm 1\%$ , 1/2w (Fig. 5-5)	4705-246777	19701	Type MF7C	1		
R18	C3-R5	Res, met flm, 6.04k $\pm 1\%$ , 1/2w (Fig. 5-5)	4705-162586	19701	Type MF7C	1		
R19	C4-S4	Res, comp, 10k $\pm 5\%$ , 1/4w (Fig. 5-5)	4704-148106	01121	CB1035	3		
R20	C3-T2	Res, met flm, 2.74k $\pm 1\%$ , 1/2w (Fig. 5-5)	4705-240614	19701	Type MF7C	1		
R21	C3-S5	Res, met flm, factory matched (Fig. 5-5)						
R22	C3-T3	Res, ww, factory matched (Fig. 5-5)						
R23	B5-T4	Res, ww, factory matched (Fig. 5-5)						
R24	C2-T5	Res, factory matched (Fig. 5-5)						
R25	C1-U3	Res, met flm, 499 $\Omega$ $\pm 1\%$ , 1/2w (Fig. 5-5)	4705-151514	19701	Type MF7C	1		
R26	C1-V2	Res, var, ww, 100 $\Omega$ $\pm 20\%$ , 1-1/4w (Fig. 5-5)	4702-112797	71450	Type 110	1		
R27	C1-U1	Res, met flm, 178 $\Omega$ $\pm 0.5\%$ , 1/2w (Fig. 5-5)	4705-256255	19701	Type MF7C	1		
R28	D2-T2	Res, comp, 2.7 $\Omega$ $\pm 5\%$ , 1/4w (Fig. 5-5)	4704-246744	01121	CB27G5	1		
R29	H1-P5	Res, comp, 8.2k $\pm 5\%$ , 1/2w (Fig. 5-5)	4704-147777	01121	EB8225	2		
R30	H2-Q1	Res, comp, 10k $\pm 5\%$ , 1/4w (Fig. 5-5)	4704-148106	01121	CB1035	REF		
R31	I2-Q1	Res, met flm, 11k $\pm 1\%$ , 1/2w (Fig. 5-5)	4705-222216	19701	Type MF7C	2		
R32	I2-P1	Res, comp, 5.1k $\pm 5\%$ , 1/2w (Fig. 5-5)	4704-109108	01121	EB5125	4		

REF DESIG	INDEX NO	DESCRIPTION	STOCK NO	MFR	MFR PART NO	TOT QTY	REC QTY	USE CODE
R33	I2-N5	Res, comp, 16k $\pm 5\%$ , 1/2w (Fig. 5-5)	4704-159632	01121	EB1635	1		
R34	I4-S1	Res, comp, 5.1k $\pm 5\%$ , 1/2w (Fig. 5-5)	4704-109108	01121	EB5125	REF		
R35	I4-S2	Res, comp, 15k $\pm 10\%$ , 1/2w (Fig. 5-5)	4704-108530	01121	EB1531	1		
R36	H1-P3	Res, comp, 75 $\Omega$ $\pm 5\%$ , 1/2w (Fig. 5-5)	4704-108753	01121	EB7505	2		
R37	H1-P3	Res, comp, 75 $\Omega$ $\pm 5\%$ , 1/2w (Fig. 5-5)	4704-108753	01121	EB7505	REF		
R38	G3-P3	Res, met flm, 11k $\pm 1\%$ , 1/2w (Fig. 5-5)	4705-222216	19701	Type MF7C	REF		
R39	I3-Q4	Res, comp, 5.1k $\pm 5\%$ , 1/2w (Fig. 5-5)	4704-109108	01121	EB5125	REF		
R40	H1-P2	Res, comp, 5.1k $\pm 5\%$ , 1/2w (Fig. 5-5)	4704-109108	01121	EB5125	REF		
R42	G5-U5	Res, met flm, 34.8k $\pm 1\%$ , 1/8w (Fig. 5-5)	4705-261487	19701	Type MF5C	1		
R43	H3-N5	Res, comp, 5.1k $\pm 5\%$ , 1/4w (Fig. 5-5)	4704-193342	01121	CB5125	2		
R44	H2-N4	Res, comp, 3.9k $\pm 5\%$ , 1/4w (Fig. 5-5)	4704-148064	01121	CB3925	1		
R45	H3-N2	Res, comp, 8.2 $\Omega$ $\pm 5\%$ , 1/4w (Fig. 5-5)	4704-246751	01121	CB82G5	1		
R46	G1-Q5	Res, comp, 8.2k $\pm 5\%$ , 1/4w (Fig. 5-5)	4704-160796	01121	CB8225	2		
R47	G1-Q3	Res, comp, 4.7k $\pm 5\%$ , 1/4w (Fig. 5-5)	4704-148072	01121	CB4725	1		
R48	H2-R1	Res, comp, 5.1k $\pm 5\%$ , 1/4w (Fig. 5-5)	4704-193342	01121	CB5125	REF		
R49	H4-R5	Res, comp, 2k $\pm 5\%$ , 1/4w (Fig. 5-5)	4704-202879	01121	CB2025	REF		
R50	G5-Q4	Res, comp, 27k $\pm 5\%$ , 1/4w (Fig. 5-5)	4704-148148	01121	CB2735	REF		
R51	G3-Q2	Res, comp, 20 $\Omega$ $\pm 5\%$ , 1/4w (Fig. 5-5)	4704-246728	01121	CB2005	1		
R52	H1-Q2	Res, comp, 2k $\pm 5\%$ , 1/4w (Fig. 5-5)	4704-202879	01121	CB2025	REF		
R53	H3-U2	Res, comp, 390k $\pm 10\%$ , 2w (Fig. 5-4)	4704-246801	01121	HB3941	6		

REF DESIG	INDEX NO	DESCRIPTION	STOCK NO	MFR	MFR PART NO	TOT QTY	REC QTY	USE CODE
R54	G3-S5	Res, comp, 390k $\pm$ 10%, 2w (Fig. 5-4)	4704-246801	01121	HB3941	REF		
R55	D3-V2	Res, ww, 1k $\pm$ 5%, 5w (Fig. 5-4)	4706-246835	91637	Type CW10	2		
R56	F3-U2	Res, comp, 390k $\pm$ 10%, 2w (Fig. 5-4)	4704-246801	01121	HB3941	REF		
R57	E3-S5	Res, comp, 390k $\pm$ 10%, 2w (Fig. 5-4)	4704-246801	01121	HB3941	REF		
R58	K3-M5	Res, comp, 150k $\pm$ 5%, 1w (Fig. 5-5)	4704-153122	01121	GB1545	4		
R59	K4-P3	Res, comp, 620 $\Omega$ $\pm$ 5%, 1/4w (Fig. 5-5)	4704-221903	01121	CB6215	6		
R60	K3-P3	Res, comp, 150k $\pm$ 5%, 1w (Fig. 5-5)	4704-153122	01121	GB1545	REF		
R61	K3-R1	Res, comp, 150k $\pm$ 5%, 1w (Fig. 5-5)	4704-153122	01121	GB1545	REF		
R62	K4-R2	Res, comp, 620 $\Omega$ $\pm$ 5%, 1/4w (Fig. 5-5)	4704-221903	01121	CB6215	REF		
R63	K4-S5	Res, comp, 620 $\Omega$ $\pm$ 5%, 1/4w (Fig. 5-5)	4704-221903	01121	CB6215	REF		
R64	I4-R2	Res, comp, 150k $\pm$ 5%, 1w (Fig. 5-5)	4704-153122	01121	GB1545	REF		
R65	K1-U2	Res, comp, 620 $\Omega$ $\pm$ 5%, 1/4w (Fig. 5-5)	4704-221903	01121	CB6215	REF		
R66	I4-R3	Res, comp, 7.5k $\pm$ 5%, 1/2w (Fig. 5-5)	4704-108910	01121	EB7525	REF		
R67	K5-U3	Res, comp, 6.8k $\pm$ 5%, 1/4w (Fig. 5-5)	4704-148098	01121	CB6825	1		
R68	I4-Q5	Res, comp, 150k $\pm$ 5%, 1/2w (Fig. 5-5)	4704-150177	01121	EB1545	1		
R70	I2-V3	Res, met flm, 56.2 $\Omega$ $\pm$ 1%, 1/2w (Fig. 5-5)	4705-150938	19701	Type MF7C	1		
R71	C1-P3	Res, met flm, 46.4k $\pm$ 1%, 1/2w (Fig. 5-4)	4705-247767	19701	Type MF7C	1	1	
R72	C1-P2	Res, met flm, 536k $\pm$ 1%, 1/2w (Fig. 5-4)	4705-233874	19701	Type MF7C	1		
R73	C2-P1	Res, met flm, 2.26M $\pm$ 1%, 1/2w (Fig. 5-4)	4705-221564	19701	Type MF7C	2		
R74	C3-N5	Res, met flm, 2.26M $\pm$ 1%, 1/2w (Fig. 5-4)	4705-221564	19701	Type MF7C	REF		

REF DESIG	INDEX NO	DESCRIPTION	STOCK NO	MFR	MFR PART NO	TOT QTY	REC QTY	USE CODE
R75	B5-P1	Res, met flm, 1M $\pm 1\%$ , 1/2w (Fig. 5-4)	4705-161075	19701	Type MF7C	1		
R78	J5-V2	Res, comp, 620 $\Omega$ $\pm 5\%$ , 1/4w (Fig. 5-5)	4704-221903	01121	CB6215	REF		
R79	J2-U5	Res, comp, 620 $\Omega$ $\pm 5\%$ , 1/4w (Fig. 5-5)	4704-221903	01121	CB6215	REF		
R80	J3-S5	Res, comp, 2k $\pm 5\%$ , 1/2w (Fig. 5-5)	4704-169854	01121	EB2025	1		
R81	C1-V2	Res, ww, 1k $\pm 5\%$ , 5w (Fig. 5-4)	4706-246835	91637	Type CW5	REF		
R82	B3-V1	Res, comp, 750 $\Omega$ $\pm 5\%$ , 1/4w (Fig. 5-4)	4704-218024	01121	CB7515	2		
R83	B3-R5	Res, comp, 750 $\Omega$ $\pm 5\%$ , 1/4w (Fig. 5-4)	4704-218024	01121	CB7515	REF		
R84	D3-P3	Res, ww, 2k $\pm 5\%$ , 10w (Fig. 5-4)	4706-246843	91637	Type CW10	1		
R85	G4-Q1	Res, comp, 5.1 $\Omega$ $\pm 5\%$ , 1w (Fig. 5-4)	4704-219071	01121	GB51G5	1		
R86	E5-Q4	Res, comp, 12k $\pm 5\%$ , 1/4w (Fig. 5-4)	4704-159731	01121	CB1235	1		
R87	D5-Q1	Res, comp, 2.2k $\pm 10\%$ , 1w (Fig. 5-4)	4704-109843	01121	GB2221	1		
R88	H1-R5	Res, met flm, 169k $\pm 1\%$ , 1/2w (Fig. 5-4)	4705-176206	19701	Type MF7C	2		
R89	G4-R5	Res, met flm, 9.09k $\pm 1\%$ , 1/2w (Fig. 5-4)	4705-151258	19701	Type MF7C	2		
R90	F5-R1	Res, comp, 15k $\pm 5\%$ , 1/4w (Fig. 5-4)	4704-148114	01121	CB1535	4		
R91	D4-Q1	Res, comp, 1.8k $\pm 10\%$ , 2w (Fig. 5-4)	4704-185983	01121	HB1821	1		
R92	H1-Q5	Res, comp, 18k $\pm 5\%$ , 1/4w (Fig. 5-4)	4704-148122	01121	CB1835	2		
R93	J3-U3	Res, comp, 390k $\pm 10\%$ , 2w (Fig. 5-4)	4704-246801	01121	HB3941	REF		
R94	J4-V1	Res, comp, 390k $\pm 10\%$ , 2w (Fig. 5-4)	4704-246801	01121	HB3941	REF		
R95	H3-R5	Res, comp, 33 $\Omega$ $\pm 5\%$ , 1/4w (Fig. 5-4)	4704-175034	01121	CB3305	1		
R96	K1-S4	Res, ww, 200k $\pm 5\%$ , 10w (Fig. 5-4)	4706-246850	91637	Type CW10	2		

REF DESIG	INDEX NO	DESCRIPTION	STOCK NO	MFR	MFR PART NO	TOT QTY	REC QTY	USE CODE
R97	K1-T1	Res, ww, 200k $\pm 5\%$ , 10w (Fig. 5-4)	4706-246850	91637	Type CW10	REF		
R98	D1-Q2	Res, comp, 1M $\pm 10\%$ , 1w (Fig. 5-4)	4704-109793	01121	GB1051	1		
R99	D1-N5	Res, comp, 820 $\Omega$ $\pm 5\%$ , 1/4w (Fig. 5-4)	4704-148015	01121	CB8215	1		
R100	E2-N5	Res, comp, 51 $\Omega$ $\pm 5\%$ , 1w (Fig. 5-4)	4704-157586	01121	GB5105	1		
R101	E5-P3	Res, comp, 15k $\pm 5\%$ , 1/4w (Fig. 5-4)	4704-148114	01121	CB1535	REF		
R102	D1-P1	Res, comp, 3.3k $\pm 5\%$ , 1/4w (Fig. 5-4)	4704-148056	01121	CB3325	1		
R103	F3-R5	Res, comp, 1k $\pm 5\%$ , 1/4w (Fig. 5-4)	4704-148023	01121	CB1025	1		
R104	F2-R5	Res, comp, 10k $\pm 5\%$ , 1/4w (Fig. 5-4)	4704-148106	01121	CB1035	REF		
R105	D5-R5	Res, comp, 2.7k $\pm 5\%$ , 1/4w (Fig. 5-4)	4704-170720	01121	CB2725	2		
R106	E1-R5	Res, comp, 15k $\pm 5\%$ , 1/4w (Fig. 5-4)	4704-148114	01121	CB1535	REF		
R107	F4-R5	Res, comp, 8.2k $\pm 5\%$ , 1/4w (Fig. 5-4)	4704-160796	01121	CB8225	REF		
R108	F5-R5	Res, comp, 22k $\pm 5\%$ , 1/4w (Fig. 5-4)	4704-148130	01121	CB2235	3		
R109	E3-R5	Res, comp, 2.7k $\pm 5\%$ , 1/4w (Fig. 5-4)	4704-170720	01121	CB2725	REF		
R110	C4-R5	Res, comp, 5.6k $\pm 5\%$ , 2w (Fig. 5-4)	4704-218842	01121	HB5625	1		
R111	D3-S1	Res, comp, 62k $\pm 5\%$ , 1/2w (Fig. 5-4)	4704-108522	01121	EB6235	1		
R112	D1-R5	Res, comp, 15k $\pm 10\%$ , 2w (Fig. 5-4)	4704-110080	01121	HB1531	1		
R113	G4-U2	Res, comp, 510 $\Omega$ $\pm 5\%$ , 1/4w (Fig. 5-5)	4704-218032	01121	CB5115	1		
R114	H3-T5	Res, comp, 6.2k $\pm 5\%$ , 1/4w (Fig. 5-5)	4704-221911	01121	CB6225	1		
R115	I1-T1	Res, comp, 560 $\Omega$ $\pm 5\%$ , 1/4w (Fig. 5-5)	4704-147991	01121	CB5615	2		
R116	H4-T2	Res, comp, 560 $\Omega$ $\pm 5\%$ , 1/4w (Fig. 5-5)	4704-147991	01121	CB5615	REF		

REF DESIG	INDEX NO	DESCRIPTION	STOCK NO	MFR	MFR PART NO	TOT QTY	REC QTY	USE CODE
R117	I2-T3	Res, comp, 680Ω ±5%, 1/4w (Fig. 5-5)	4704-148007	01121	CB6815	1		
R118	I3-U1	Res, comp, 30k ±5%, 1/4w (Fig. 5-5)	4704-193417	01121	CB3035	1		
R119	I3-T5	Res, comp, 11k ±5%, 1/4w (Fig. 5-5)	4704-221580	01121	CB1135	1		
R120	H1-S4	Res, comp, 1.3k ±5%, 1/4w (Fig. 5-5)	4704-234252	01121	CB1325	1		
R121	G5-S5	Res, comp, 18k ±5%, 1/4w (Fig. 5-5)	4704-148122	01121	CB1835	REF		
R122	G3-T5	Res, comp, 180Ω ±5%, 1/4w (Fig. 5-5)	4704-147942	01121	CB1815	2		
R123	G3-T1	Res, comp, 180Ω ±5%, 1/4w (Fig. 5-5)	4704-147942	01121	CB1815	REF		
R124	G4-U1	Res, met flm, 20k ±1%, 1/2w (Fig. 5-5)	4705-162438	19701	Type MF7C	2		
R125	G4-T2	Res, met flm, 20k ±1%, 1/2w (Fig. 5-5)	4705-162438	19701	Type MF7C	REF		
R126	F5-U3	Res, met flm, 2M ±1%, 1/2w (Fig. 5-5)	4705-217760	19701	Type MF7C	1		
R127	D5-N4	Res, comp, 36k ±5%, 1/2w (Fig. 5-5)	4704-185991	01121	EB3635	1		
R128	E1-N4	Res, met flm, 34k ±1%, 1/2w (Fig. 5-5)	4705-151241	19701	Type MF7C	3		
R129	E2-N4	Res, met flm, 28.7k ±1%, 1/2w (Fig. 5-5)	4705-193987	19701	Type MF7C	1		
R130	C1-M4	Res, comp, 100k ±5%, 1/2w (Fig. 5-5)	4704-168054	01121	EB1045	1		
R131	C1-P1	Res, met flm, 10k ±1%, 1/2w (Fig. 5-5)	4705-151274	19701	Type MF7C	3		
R132	C5-M4	Res, comp, 100k ±5%, 1/2w (Fig. 5-5)	4704-168054	01121	EB1045	1		
R133	E4-N4	Res, met flm, 10k ±1%, 1/2w (Fig. 5-5)	4705-151274	19701	Type MF7C	REF		
R134	B5-M4	Res, comp, 24k ±5%, 1/2w (Fig. 5-5)	4704-108654	01121	EB2435	1		
R135	B5-P1	Res, comp, 62k ±5%, 1/4w (Fig. 5-5)	4704-220053	01121	CB6235	1		
R136	F1-Q1	Res, met flm, 68.1k ±1%, 1/2w (Fig. 5-5)	4705-161083	19701	Type MF7C	1		

REF DESIG	INDEX NO	DESCRIPTION	STOCK NO	MFR	MFR PART NO	TOT QTY	REC QTY	USE CODE
R137	F4-Q1	Res, met flm, 8.06k $\pm$ 1%, 1/2w (Fig. 5-5)	4705-159467	19701	Type MF7C	1		
R138	F2-Q5	Res, met flm, 34k $\pm$ 1%, 1/2w (Fig. 5-5)	4705-151241	19701	Type MF7C	REF		
R139	F3-Q4	Res, met flm, 162 $\Omega$ $\pm$ 1%, 1/2w (Fig. 5-5)	4705-151175	19701	Type MF7C	1		
R140	E2-Q5	Res, met flm, 34k $\pm$ 1%, 1/2w (Fig. 5-5)	4705-151241	19701	Type MF7C	REF		
R141	D1-Q3	Res, comp, 1.5k $\pm$ 5%, 1/4w (Fig. 5-5)	4704-148031	01121	CB1525	1		
R142	D4-R5	Res, comp, 220 $\Omega$ $\pm$ 5%, 1/4w (Fig. 5-5)	4704-147959	01121	CB2215	1		
R143	E1-R5	Res, comp, 13k $\pm$ 5%, 1/4w (Fig. 5-5)	4704-221598	01121	CB1335	1		
R144	E1-S1	Res, comp, 200 $\Omega$ $\pm$ 5%, 1/4w (Fig. 5-5)	4704-193482	01121	CB2015	3		
R145	E4-R4	Res, comp, 22k $\pm$ 5%, 1/4w (Fig. 5-5)	4704-148130	01121	CB2235	REF		
R146	D5-S2	Res, comp, 3.3M $\pm$ 5%, 1/4w (Fig. 5-5)	4704-208389	01121	CB3355	1		
R147	F2-U2	Res, met flm, 9.09k $\pm$ 1%, 1/2w (Fig. 5-5)	4705-151258	19701	Type MF7C	REF		
R148	E5-S4	Res, met flm, 249k $\pm$ 1%, 1/2w (Fig. 5-5)	4705-218685	19701	Type MF7C	1		
R149	F3-S1	Res, met flm, 383k $\pm$ 1%, 1/2w (Fig. 5-5)	4705-176388	19701	Type MF7C	1		
R150	E4-M4	Res, comp, 47k $\pm$ 5%, 1/2w (Fig. 5-5)	4704-108738	01121	EB4735	1		
R151	E4-M5	Res, comp, 180k $\pm$ 10%, 1/2w (Fig. 5-5)	4704-108431	01121	EB1841	1		
R152	E5-N1	Res, comp, 22k $\pm$ 5%, 1/4w (Fig. 5-5)	4704-148130	01121	CB2235	REF		
R153	G3-N3	Res, comp, 22k $\pm$ 5%, 1/2w (Fig. 5-5)	4704-186064	01121	EB2235	3		
R154	F1-N2	Res, met flm, 253k $\pm$ 1%, 1/2w (Fig. 5-5)	4705-247452	19701	Type MF7C	2		
R155	E3-M3	Res, met flm, 243k $\pm$ 1%, 1/2w (Fig. 5-5)	4705-247452	19701	Type MF7C	REF		
R156	I2-M5	Res, comp, 22k $\pm$ 5%, 1/2w (Fig. 5-5)	4704-186064	01121	EB2235	REF		

REF DESIG	INDEX NO	DESCRIPTION	STOCK NO	MFR	MFR PART NO	TOT QTY	REC QTY	USE CODE
R157	I3-N2	Res, comp, 22k $\pm 5\%$ , 1/2w (Fig. 5-5)	4704-186064	01121	EB2235	REF		
R158	I3-N1	Res, comp, 8.2k $\pm 5\%$ , 1/2w (Fig. 5-5)	4704-147777	01121	EB8225	REF		
R159	J3-M3	Res, comp, 15k $\pm 5\%$ , 1/4w (Fig. 5-5)	4704-148114	01121	CB1535	REF		
R160	J4-M5	Res, var, ww, 10k $\pm 20\%$ , 1-1/4w (Fig. 5-5)	4702-112862	71450	Type 110	1		
R161	G1-S2	Res, met flm, 24.3k $\pm 1\%$ , 1/2w (Fig. 5-5)	4705-217430	19701	Type MF7C	1		
R162	H1-S1	Res, var, ww, 5k $\pm 5\%$ , 2w (Fig. 5-5)	4702-111609	71450	Type E115	1		
R163	G2-R2	Res, met flm, 4.22k $\pm 1\%$ , 1/2w (Fig. 5-5)	4705-223396	19701	Type MF7C	1		
R164	F4-R2	Res, comp, 10M $\pm 10\%$ , 1/2w (Fig. 5-5)	4704-108142	01121	EB1061	1		
R165	G3-M4	Res, comp, 200 $\Omega$ $\pm 5\%$ , 1/4w (Fig. 5-5)	4704-193482	01121	CB2015	REF		
R166	D5-T5	Res, comp, 470 $\Omega$ $\pm 10\%$ , 1w (Fig. 5-5)	4704-109710	01121	GB4711	2		
R167	E1-T5	Res, met flm, 10k $\pm 1\%$ , 1/2w (Fig. 5-5)	4705-151274	19701	Type MF7C	REF		
R168	G4-M5	Res, comp, 200 $\Omega$ $\pm 5\%$ , 1/4w (Fig. 5-4)	4704-193482	01121	CB2015	REF		
R169	F2-M5	Res, comp, 56 $\Omega$ $\pm 10\%$ , 2w (Fig. 5-4)	4704-110221	01121	HB5601	1		
R170	E3-T1	Res, met flm, 169k $\pm 1\%$ , 1/2w (Fig. 5-5)	4705-176206	19701	Type MF7C	REF		
R171	E2-T2	Res, met flm, 51.1k $\pm 1\%$ , 1/2w (Fig. 5-5)	4705-159665	19701	Type MF7C	1		
R172	E1-T2	Res, met flm, 2k $\pm 1\%$ , 1/2w (Fig. 5-5)	4705-151266	19701	Type MF7C	1		
R173	F2-S5	Res, met flm, 10 $\Omega$ $\pm 1\%$ , 1/2w (Fig. 5-5)	4705-151043	19701	Type MF7C	1		
R174	D3-S5	Res, comp, 470 $\Omega$ $\pm 10\%$ , 1w (Fig. 5-5)	4704-109710	01121	GB4711	REF		
R178	C4-U2	Res, met flm, 2.1k $\pm 1\%$ , 1/8w (Fig. 5-5)	4705-168237	19701	Type MF5C	1		
R179	C4-U1	Res, met flm, 4.02k $\pm 1\%$ , 1/8w (Fig. 5-5)	4705-235325	19701	Type MF5C	1		















REF DESIG	INDEX NO	DESCRIPTION	STOCK NO	MFR	MFR PART NO	TOT QTY	REC QTY	USE CODE
R180	E2-Q1	Res, comp, 240Ω ±5%, 1w (Fig. 5-4)	4704-190587	01121	GB2415	3		
R181	E3-Q1	Res, comp, 240Ω ±5%, 1w (Fig. 5-4)	4704-190587	01121	GB2415	REF		
R239	I3-V1	Res, comp, 240Ω ±5%, 1w (Fig. 5-5)	4704-190587	01121	GB2415	REF		
		Cover, thermal (not illustrated)	3155-240390	89536	3155-240390	1		
	C2-R2	Heat sink, transistor	4841-104646	05820	NF207	5		



Q14, R21 and R24 are a factory selected and matched Reference Amplifier set. For Model 341A, replace the entire set, part number 4842-264044. For Model 343A, replace the entire set, part number 4842-264051.



R22 and R23 are a factory matched set. For replacement in the Model 341A, order part number 4707-265116. For replacement in the Model 343A, order part number 4707-265348.

REF DESIG	INDEX NO	DESCRIPTION	STOCK NO	MFR	MFR PART NO	TOT QTY	REC QTY	USE CODE
A4		<b>REFERENCE P/C ASSEMBLY</b> <b>Figure 5-6</b>	3158-240101	89536	3158-240101	REF		
		NOTE: The Reference P/C Assembly (A4), the Sample String P/C Assembly (A5) and their intermatched resistors can be ordered under one part number, 3158-252312.						
C1	C2-R4	Cap, plstc, 0.1 uf $\pm 10\%$ , 1, 200v	1507-233718	84411	JF 15	2		
C2	C2-Q5	Cap, plstc, 0.1 uf $\pm 10\%$ , 1, 200v	1507-233718	84411	JF 15	REF		
R1	F3-T1	Res, var, ww, 1k $\pm 20\%$ , 1-1/4w	4702-113266	71450	Type 110	1		
R2	F3-Q5	Res, ww, 1.4995M, matched						
R3	G2-R5	Res, var, ww, 100 $\Omega$ $\pm 10\%$ , 1-1/4w	4702-208785	71450	Type 110	7		
R4	G1-Q5	Res, ww, 149.95k, matched						
R5	E4-S1	Res, var, ww, 100 $\Omega$ $\pm 10\%$ , 1-1/4w	4702-208785	71450	Type 110	REF		
R6	E3-Q5	Res, met flm, 100 $\Omega$ $\pm 0.5\%$ , 1/2w	4705-256248	19701	Type MF7C	1		
R7	E1-Q5	Res, met flm, 200 $\Omega$ $\pm 1\%$ , 1/2w	4705-151480	19701	Type MF7C	1		
R8	E5-Q5	Res, ww, 14.9286k, matched						
R9	K1-Q5	Res, ww, 99.975k, matched						
R10	K1-R5	Res, ww, 99.975k, matched						
R11	K1-T1	Res, var, ww, 100 $\Omega$ $\pm 10\%$ , 1-1/4w	4702-208785	71450	Type 110	REF		
R12	J1-Q5	Res, ww, 99.975k, matched						
R13	J3-Q5	Res, ww, 99.975k, matched						
R14	J2-S1	Res, var, ww, 100 $\Omega$ $\pm 10\%$ , 1-1/4w	4702-208785	71450	Type 110	REF		
R15	I3-Q5	Res, ww, 99.975k, matched						
R16	I3-R5	Res, ww, 99.975k, matched						
R17	I3-T1	Res, var, ww, 100 $\Omega$ $\pm 10\%$ , 1-1/4w	4702-208785	71450	Type 110	REF		
R18	H3-Q5	Res, ww, 99.975k, matched						
R19	H5-Q5	Res, ww, 99.975k, matched						
R20	H5-S1	Res, var, ww, 100 $\Omega$ $\pm 10\%$ , 1-1/4w	4702-208785	71450	Type 110	REF		
R21	G5-Q5	Res, ww, 99.975k, matched						
R22	H1-S1	Res, ww, 99.975k, matched						
R23	H1-T1	Res, var, ww, 100 $\Omega$ $\pm 10\%$ , 1-1/4w	4702-208785	71450	Type 110	REF		

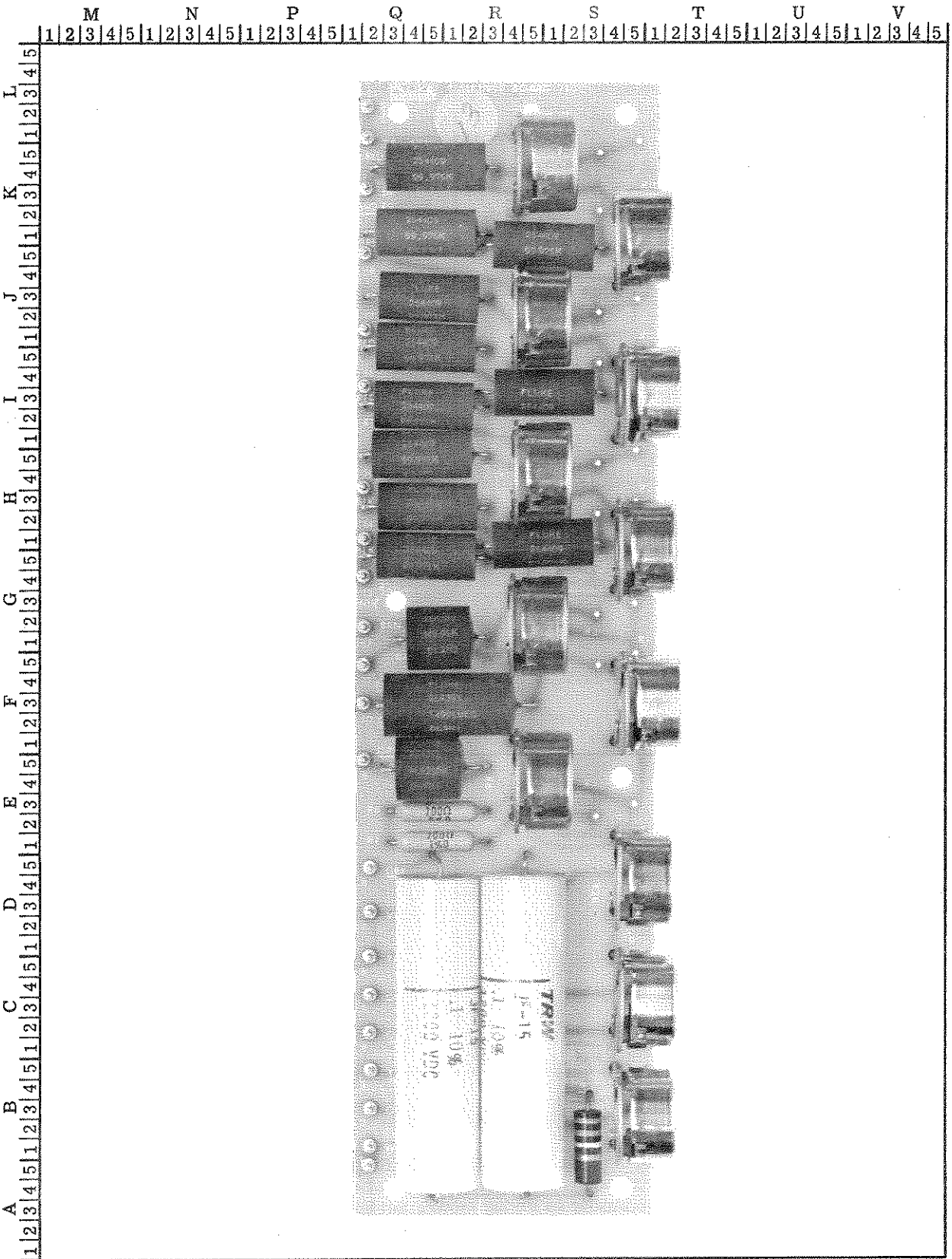















Figure 5-6. REFERENCE P/C ASSEMBLY (341A)

REF DESIG	INDEX NO	DESCRIPTION	STOCK NO	MFR	MFR PART NO	TOT QTY	REC QTY	USE CODE
R24	B3-T1	Res, var, ww, 10k $\pm$ 10%, 1-1/4w	4702-162115	71450	Type 110	3		
R25	C3-T1	Res, var, ww, 10k $\pm$ 10%, 1-1/4w	4702-162115	71450	Type 110	REF		
R26	D4-T1	Res, var, ww, 10k $\pm$ 10%, 1-1/4w	4702-162115	71450	Type 110	REF		
R27	K4-Q5	Res, ww, 99.975k, matched						
R28	K4-S1	Res, var, ww, 50 $\Omega$ $\pm$ 10%, 1-1/4w	4702-144782	71450	Type 110	1		
R29	B1-S3	Res, comp, 330k $\pm$ 5%, 1w	4704-109777	01121	GB3345	1		



R2, R4, R8, R9/R10, R12/R13, R15/R16, R18/R19, R21/R22, R27 and A5R1 through A5R12 are an intermatched resistor set, part number 4710-252445. The resistors may be replaced individually by giving model, serial number, full reference designation, and all markings on the old resistor. However, R9/R10, R12/R13, R15/R16, R18/R19 and R21/R22 must be ordered and replaced in pairs.

REF DESIG	INDEX NO	DESCRIPTION	STOCK NO	MFR	MFR PART NO	TOT QTY	REC QTY	USE CODE
A5		<b>SAMPLE STRING P/C ASSEMBLY</b> Figure 5-7  NOTE: The Reference P/C Assembly, (A4), the Sample String P/C Assembly (A5) and their intermatched resistors can be ordered under one part number, 3158-252312.	3158-263012	89536	3158-263012	REF		
CR1	B3-T2	Diode, silicon, 200 ma, 25 piv	4805-190272	93332	1N456A	2		
CR2	A5-T2	Diode, silicon, 200 ma, 25 piv	4805-190272	93332	1N456A	REF		
R1	E2-Q4	Res, ww, 10k, matched						
R2	B4-Q2	Res, ww, 20k, matched						
R3	C2-Q4	Res, ww, 20k, matched						
R4	C5-Q4	Res, ww, 20k, matched						
R5	D2-Q4	Res, ww, 20k, matched						
R6	D4-Q4	Res, ww, 20k, matched						
R7	E5-Q4	Res, ww, 1k, matched						
R8	E1-Q4	Res, ww, 2k, matched						
R9	E4-Q4	Res, ww, 2k, matched						
R10	F1-Q4	Res, ww, 2k, matched						
R11	F3-Q4	Res, ww, 2k, matched						
R12	F3-Q4	Res, ww, 2k, matched						
R13	H4-Q4	Res, ww, 100Ω ±0.03%, 1/2w	4707-155846	89536	4707-155846	1		
R14	G1-Q4	Res, ww, 200Ω ±0.01%, 1/2w	4707-178988	89536	4707-178988	5		
R15	G3-Q4	Res, ww, 200Ω ±0.01%, 1/2w	4707-178988	89536	4707-178988	REF		
R16	G5-Q4	Res, ww, 200Ω ±0.01%, 1/2w	4707-178988	89536	4707-178988	REF		
R17	H1-Q4	Res, ww, 200Ω ±0.01%, 1/2w	4707-178988	89536	4707-178988	REF		
R18	H3-Q4	Res, ww, 200Ω ±0.01%, 1/2w	4707-178988	89536	4707-178988	REF		
R19	J3-Q5	Res, ww, 10Ω ±0.5%, 0.7w	4707-248732	01686	Type T2	1		
R20	H5-Q5	Res, ww, 20Ω ±0.5%, 0.7w	4707-248724	01686	Type T2	5		
R21	I2-Q5	Res, ww, 20Ω ±0.5%, 0.7w	4707-248724	01686	Type T2	REF		
R22	I4-Q5	Res, ww, 20Ω ±0.5%, 0.7w	4707-248724	01686	Type T2	REF		
R23	I5-Q5	Res, ww, 20Ω ±0.5%, 0.7w	4707-248724	01686	Type T2	REF		

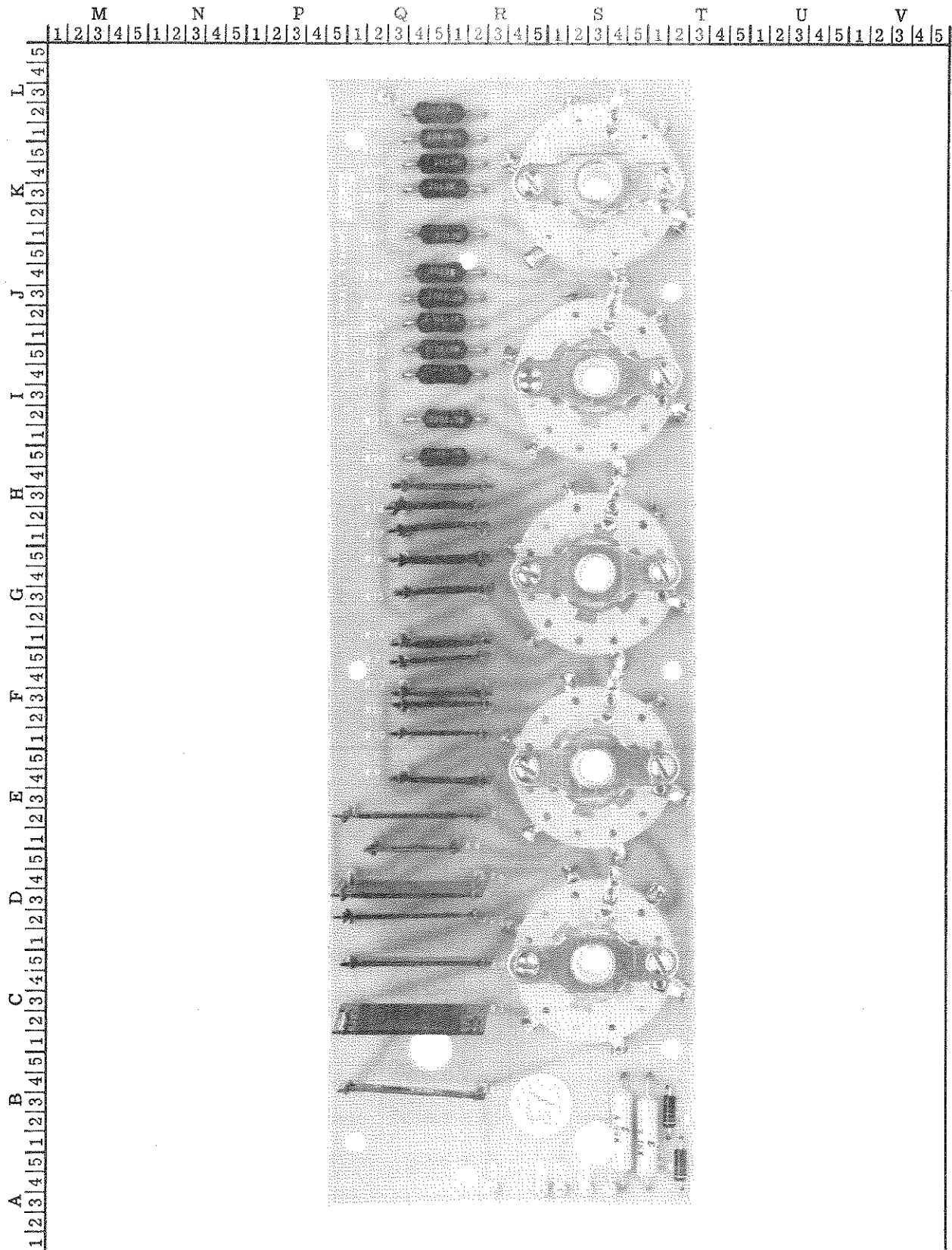



Figure 5-7. SAMPLE STRING P/C ASSEMBLY (341A)

REF DESIG	INDEX NO	DESCRIPTION	STOCK NO	MFR	MFR PART NO	TOT QTY	REC QTY	USE CODE
R24	J2-Q5	Res, ww, $20\Omega \pm 0.5\%$ , 0.7w	4707-248724	01686	Type T2	REF		
R25	L2-Q5	Res, ww, $1\Omega \pm 3\%$ , 0.7w	4707-248757	01686	Type T2	1		
R26	J4-Q5	Res, ww, $2\Omega \pm 3\%$ , 0.7w	4707-248740	01686	Type T2	5		
R27	K1-Q5	Res, ww, $2\Omega \pm 3\%$ , 0.7w	4707-248740	01686	Type T2	REF		
R28	K3-Q5	Res, ww, $2\Omega \pm 3\%$ , 0.7w	4707-248740	01686	Type T2	REF		
R29	K5-Q5	Res, ww, $2\Omega \pm 3\%$ , 0.7w	4707-248740	01686	Type T2	REF		
R30	L1-Q5	Res, ww, $2\Omega \pm 3\%$ , 0.7w	4707-248740	01686	Type T2	REF		
R31	B1-T1	Res, met flm, $3.16k \pm 1\%$ , 1/2w	4705-187781	19701	Type MF7C	1		
R32	B2-S4	Res, met flm, $4.99k \pm 1\%$ , 1/2w	4705-148890	19701	Type MF7C	1		
S2	D1-S2	Switch, rotary, Decade 2	5105-257253	89536	5105-257253	5		
S3	F1-S2	Switch, rotary, Decade 3	5105-257253	89536	5105-257253	REF		
S4	H1-S2	Switch, rotary, Decade 4	5105-257253	89536	5105-257253	REF		
S5	I5-S2	Switch, rotary, Decade 5	5105-257253	89536	5105-257253	REF		
S6	K5-S2	Switch, rotary, Decade 6	5105-257253	89536	5105-257253	REF		



R1 Thru R12 are part of an intermatched resistor set, part number 4710-252445 (See , p. 5-30). The resistors may be replaced individually by giving model, serial number, full reference designation, and all markings on the old resistor, when ordering.

REF DESIG	INDEX NO	DESCRIPTION	STOCK NO	MFR	MFR PART NO	TOT QTY	REC QTY	USE CODE
		<b>DC VOLTAGE CALIBRATOR</b> Figure 5-8	343A					
A1		Front Panel Assembly (See Figure 5-9)						
A2		Rear Panel Assembly (See Figure 5-10)						
A3		Main P/C Assembly (See Figures 5-4 & 5-5)	1702-265322	89536	1702-265322	1		
A4		Reference P/C Assembly (See Figure 5-11)	3158-252437	89536	3158-252437	1		
A5		Sample String P/C Assembly (See Figure 5-12)	3158-252429	89536	3158-252429	1		
C49		Cap, oil, 1 uf ± 10%, 1500v	1505-247023	56289	264P70	1		
C62		Cap, cer, 1 uf, gm, 3v	1501-106567	14655	HCC3105P	3		
CR58		Diode, silicon, 1 amp, 100 piv	4802-116111	05277	1N4817	25		
M1		Meter, 0-1.0v, 0-30 ma	2901-246942	89536	2901-246942	1		
R41		Res, var, comp, 5k ±10%, 3w	4701-247031	71450	321S502A	1		
R177		Res, comp, 1Ω ±5%, 1/2 w	4704-218693	01121	EB10G5	1		
S1		Switch, rotary, Decade 1 Switch section, decks A & B Switch section, decks C & D	5105-257238 5105-257246	89536 89536	5105-257238 5105-257246	1 1		
S8		Switch, rotary, FUNCTION	5105-257261	89536	5105-257261	1		
S9		Switch, rotary, RANGE Switch section, decks A & B Switch section, decks C & D	5105-257212 5105-257220	89536 89536	5105-257212 5105-257220	1 1		
T1		Transformer, power	5602-240465	89536	5602-240465	1		
20		Bail, tilt-down (not illustrated)	3154-231407	89536	3154-231407	1		
21		Cover, bottom (not illustrated)	3156-240382	89536	3156-240382	1		
22		Cover, top (not illustrated)	3156-240374	89536	3156-240374	1		
23		Detent, switch, S1	5105-257287	89536	5105-257287	1		
24		Detent, switch, S2 thru S7	5105-257295	89536	5105-257295	1		
25		Detent, switch, S9	5105-257279	89536	5105-257279	1		
26		Foot (not illustrated)	3155-230037	89536	3155-230037	4		
27		Shaft extension, S2 thru S7	3155-240457	89536	3155-240457	6		



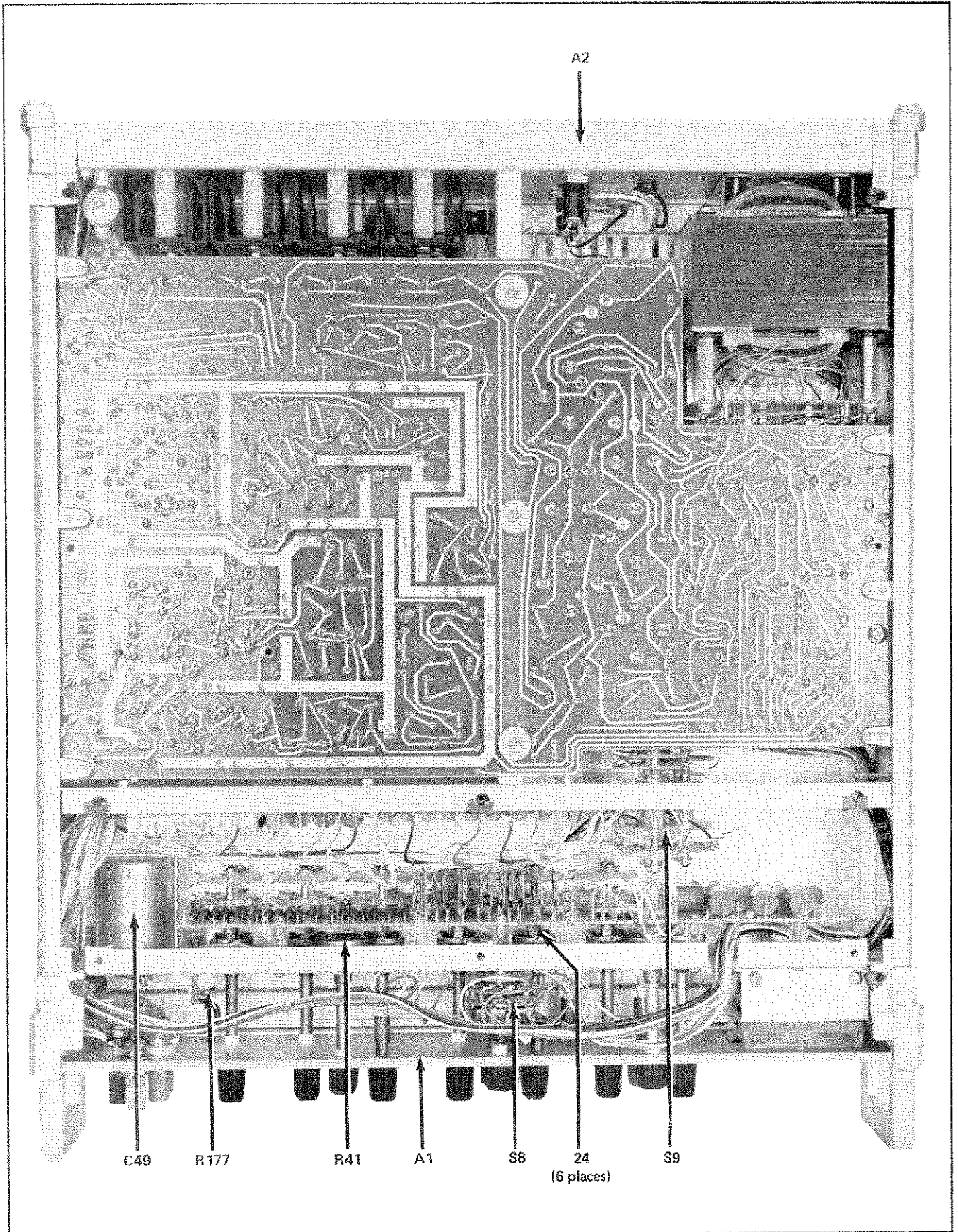

Figure 5-8. 343A DC VOLTAGE CALIBRATOR (Sheet 1 of 2)

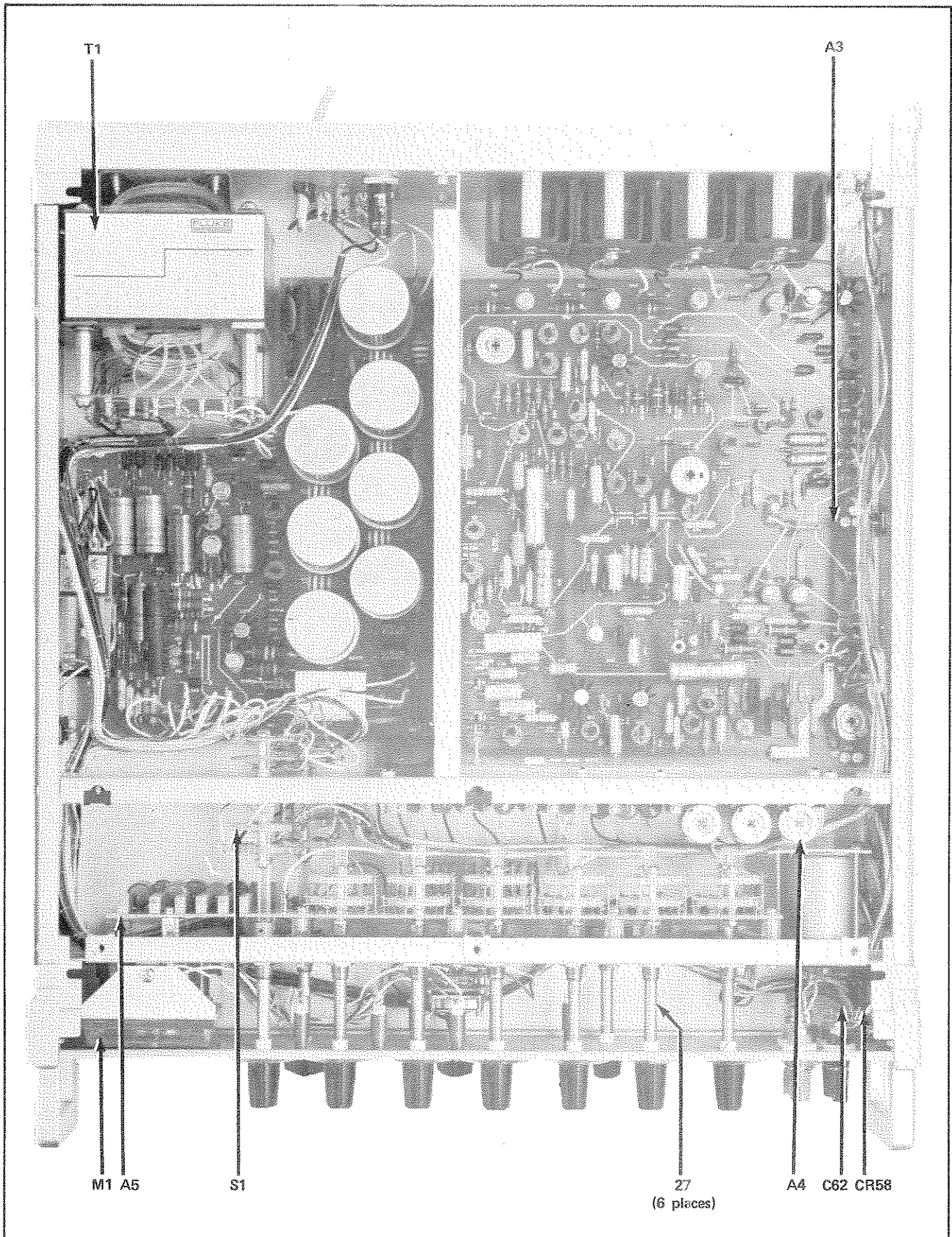

Figure 5-8. 343A DC VOLTAGE CALIBRATOR (Sheet 2 of 2)

REF DESIG	INDEX NO	DESCRIPTION	STOCK NO	MFR	MFR PART NO	TOT QTY	REC QTY	USE CODE
A1		<b>FRONT PANEL ASSEMBLY (343A)</b> Figure 5-9						
DS3 thru DS7		Lamp, incandescent, 28v	3901-246686	08806	7387	5	2	
J1, J2		Binding post, red	2811-226308	58474	DF21RC	2		
J3, J4		Binding post, black	2811-226282	58474	DF21BC	2		
J5		Binding post, white	2811-261156	58474	DF21WTC	1		
XDS3 thru XDS7		Holder, lamp	3155-252411	89536	3155-252411	5		
28		Handle	2404-246306	89536	2404-246306	2		
29		Knob, CURRENT LIMIT	2405-190249	89536	2405-190249	1		
30		Knob, DIGIT, 0-X	3155-252353	89536	3155-252353	6		
31		Knob, DIGIT, 0-10	3155-252361	89536	3155-252361	1		
32		Knob, FUNCTION, RANGE	2405-158956	89536	2405-158956	2		
33		Lens, lamp, clear	3155-222596	89536	3155-222596	3		
34		Lens, lamp, red	3155-228056	89536	3155-228056	2		
35		Link, shorting	2811-101220	24655	0938-9712	3		
36		Panel, front	1406-252403	89536	1406-252403	1		

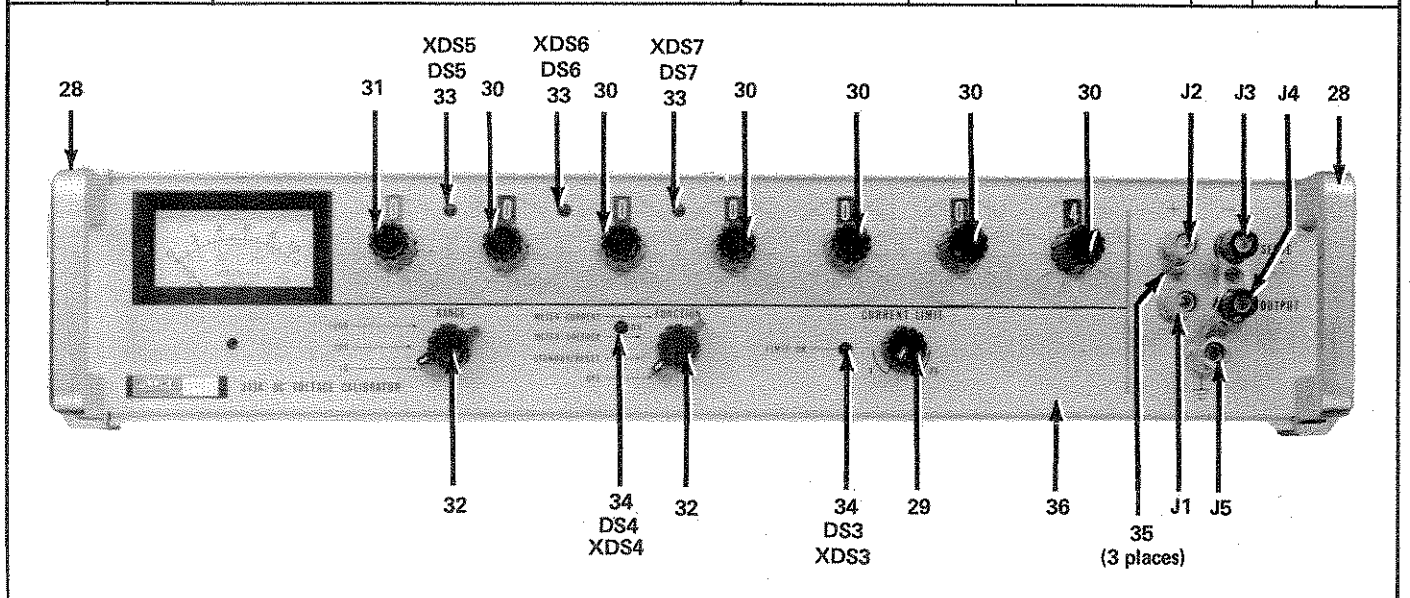

Figure 5-9. FRONT PANEL ASSEMBLY (343A)

REF DESIG	INDEX NO	DESCRIPTION	STOCK NO	MFR	MFR PART NO	TOT QTY	REC QTY	USE CODE
A2		<b>REAR PANEL ASSEMBLY (343A)</b> <b>Figure 5-10</b>						
C59, C60		Cap, cer, 0.01 uf +80/-20%, 500v	1501-105668	56289	29C9B5	3		
C66		Cap, plstc, 0.1 uf ±20%, 1600v	1507-261073	84411	Type 663UW	1		
F1		Fuse, slow blow, 1 amp, 250v (for 115v operation)	5101-109272	71400	Type MDL	1	3	
F1		Fuse, slow blow, 1/2 amp, 250v (for 230v operation)	5101-109322	71400	Type MDL	1	3	
F2		Fuse, slow blow, 1/16 amp, 250v	5101-163030	71400	Type MDL	1	3	
Q42, Q44, Q46, Q48		Tstr, silicon, NPN (behind heat sinks)	4811-190710	04713	2N3739	4	4	
W1		Line cord	6005-226027	89536	6005-226027	1		
XF1, XF2		Holder, Fuse	2102-160846	75915	342004	2		
37		Heat sink	3156-240432	89536	3156-240432	4		
38		Panel, rear	3156-240309	89536	3156-240309	1		

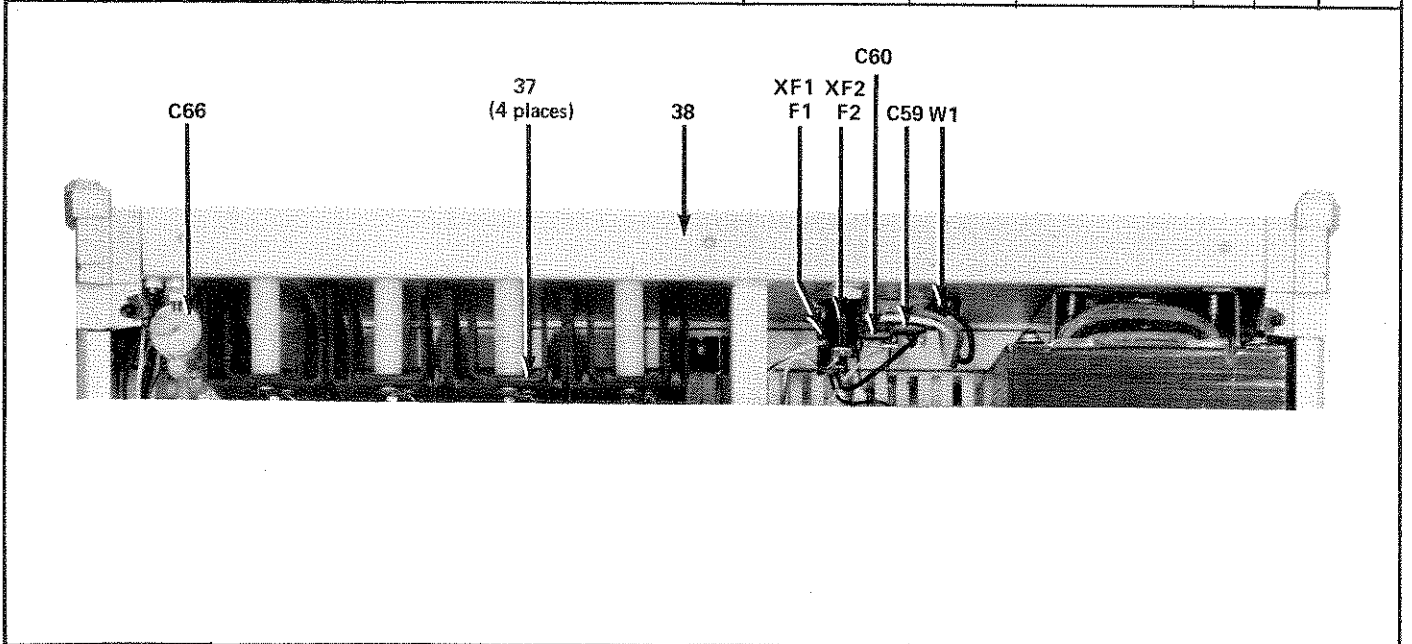















Figure 5-10. REAR PANEL ASSEMBLY (343A)

REF DESIG	INDEX NO	DESCRIPTION	STOCK NO	MFR	MFR PART NO	TOT QTY	REC QTY	USE CODE
A4		<b>REFERENCE P/C ASSEMBLY</b> <b>Figure 5-11</b>	3158-252437	89536	3158-252437	REF		
		NOTE: The Reference P/C Assembly (A4), the Sample String P/C Assembly (A5) and their inter-matched resistors can be ordered under one part number, 3158-265314.						
C1		Cap, plstc, 0.1 uf $\pm 10\%$ , 1,200v	1507-233718	84411	JF15	2		
C2		Cap, plstc, 0.1 uf $\pm 10\%$ , 1,200v	1507-233718	84411	JF15	REF		
R1		Res, var, cermet, 1k $\pm 20\%$ , 3/4w	4713-190538	73138	Type 78P	1		
R2		Res, ww, 1.4995M, matched						
R3		Res, var, cermet, 100 $\Omega$ $\pm 20\%$ , 3/4w	4713-159889	73138	Type 78P	3		
R4		Res, ww, 149.95k, matched						
R5		Res, var, cermet, 100 $\Omega$ $\pm 20\%$ , 3/4w	4713-159889	73138	Type 78P	REF		
R6		Res, met flm, 200 $\Omega$ $\pm 0.5\%$ , 1/2w	4705-246248	19701	Type MF7C	1		
R7		Res, met flm, 200 $\Omega$ , $\pm 1\%$ , 1/2w	4705-151480	19701	Type MF7C	1		
R8		Res, ww, 14.9286k, matched						
R9		Res, ww, 99.955k, matched						
R10		Res, ww, 99.955k, matched						
R11		Res, var, cermet, 200 $\Omega$ $\pm 20\%$ , 3/4w	4713-186213	73138	Type 78P	5		
R12		Res, ww, 99.955k, matched						
R13		Res, ww, 99.955k, matched						
R14		Res, var, cermet, 200 $\Omega$ $\pm 20\%$ , 3/4w	4713-186213	73138	Type 78P	REF		
R15		Res, ww, 99.955k, matched						
R16		Res, ww, 99.955k, matched						
R17		Res, var, cermet, 200 $\Omega$ $\pm 20\%$ , 3/4w	4713-186213	73138	Type 78P	REF		
R18		Res, ww, 99.955k, matched						
R19		Res, ww, 99.955k, matched						
R20		Res, var, cermet, 200 $\Omega$ $\pm 20\%$ , 3/4w	4713-186213	73138	Type 78P	REF		
R21		Res, ww, 99.955k, matched						
R22		Res, ww, 99.955k, matched						

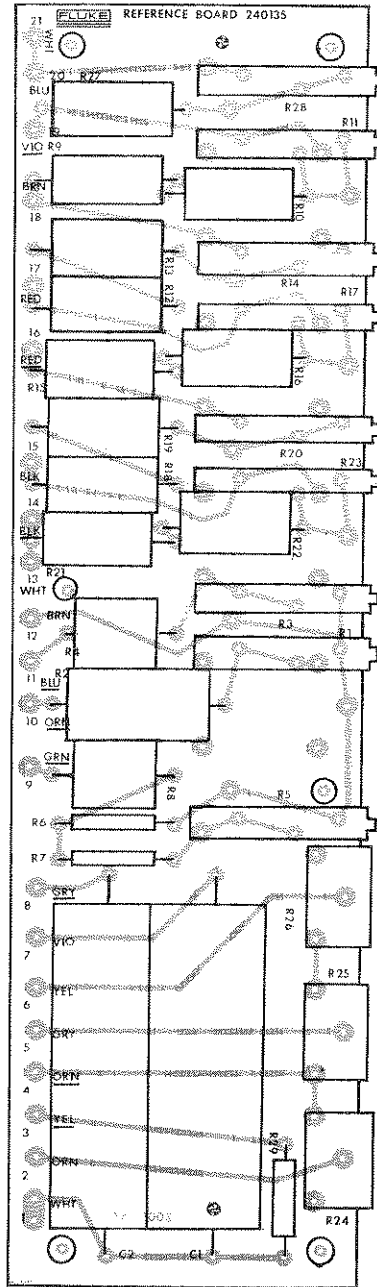





















Figure 5-11. REFERENCE P/C ASSEMBLY (343A)

REF DESIG	INDEX NO	DESCRIPTION	STOCK NO	MFR	MFR PART NO	TOT QTY	REC QTY	USE CODE
R23		Res, var, cermet, 200Ω ±20%, 3/4w	4713-186213	73138	Type 78P	REF		
R24		Res, var, ww, 10k ±10%, 1-1/4w	4702-162115	71450	Type 110	3		
R25		Res, var, ww, 10k ±10%, 1-1/4w	4702-162115	71450	Type 110	REF		
R26		Res, var, ww, 10k ±10%, 1-1/4w	4702-162115	71450	Type 110	REF		
R27		Res, ww, 99.955k, matched						
R28		Res, var, cermet, 100Ω ±20%, 3/4w	4713-159889	73138	Type 78P	REF		
R29		Res, comp, 330k ±5%, 1w	4704-109777	01121	GB3345	1		



R2, R4, R8, R9/R10, R12/R13, R15/R16, R18/R19, R21/R22, R27 and A5R1, A5R4, A5R5, A5R8, A5R9, and A5R12 thru A5R25 are an intermatched resistor set, part number 4710-265330. The resistors may be replaced individually by giving model, serial number, full reference designation, and all markings on the old resistor. However, R9/R10, R12/R13, R15/R16, R18/R19 and R21/R22 must be ordered and replaced in pairs.

REF DESIG	INDEX NO	DESCRIPTION	STOCK NO	MFR	MFR PART NO	TOT QTY	REC QTY	USE CODE
A5		<b>SAMPLE STRING P/C ASSEMBLY</b> <b>Figure 5-12</b>  NOTE: The Reference P/C Assembly(A4), the Sample String P/C Assembly (A5) and their intermatched re- sistors can be ordered under one part number, 3158-265314.	3158-252429	89536	3158-252429	REF		
CR1		Diode, silicon, 200 ma, 25 piv	4805-190272	93332	IN456A	2		
CR2		Diode, silicon, 200 ma, 25 piv	4805-190272	93332	IN456A	REF		
R1		Res, ww, 19. 991k, matched						
R2		Res, var, cermet, 20Ω ±30%, 3/4w	4713-186197	73138	Type 78P	5		
R3		Res, var, cermet, 20Ω ±30%, 3/4w	4713-186197	73138	Type 78P	REF		
R4		Res, ww, 19. 991k, matched						
R5		Res, ww, 19. 991k, matched						
R6		Res, var, cermet, 20Ω ±30%, 3/4w	4713-186197	73138	Type 78P	REF		
R7		Res, var, cermet, 20Ω ±30%, 3/4w	4713-186197	73138	Type 78P	REF		
R8		Res, ww, 19. 991k, matched						
R9		Res, ww, 19. 991k, matched						
R10		Res, var, cermet, 20Ω ±30%, 3/4w	4713-186197	73138	Type 78P	REF		
R11		Res, var, cermet, 10Ω ±30%, 3/4w	4713-186205	73138	Type 78P	1		
R12		Res, ww, 19. 991k, matched						
R13		Res, ww, 19. 991k, matched						
R14		Res, ww, 2k, matched						
R15		Res, ww, 2k, matched						
R16		Res, ww, 2k, matched						
R17		Res, ww, 2k, matched						
R18		Res, ww, 2k, matched						
R19		Res, ww, 1k, matched						
R20		Res, ww, 200Ω, matched						
R21		Res, ww, 200Ω, matched						
R22		Res, ww, 200Ω, matched						
R23		Res, ww, 200Ω, matched						
R24		Res, ww, 200Ω, matched						



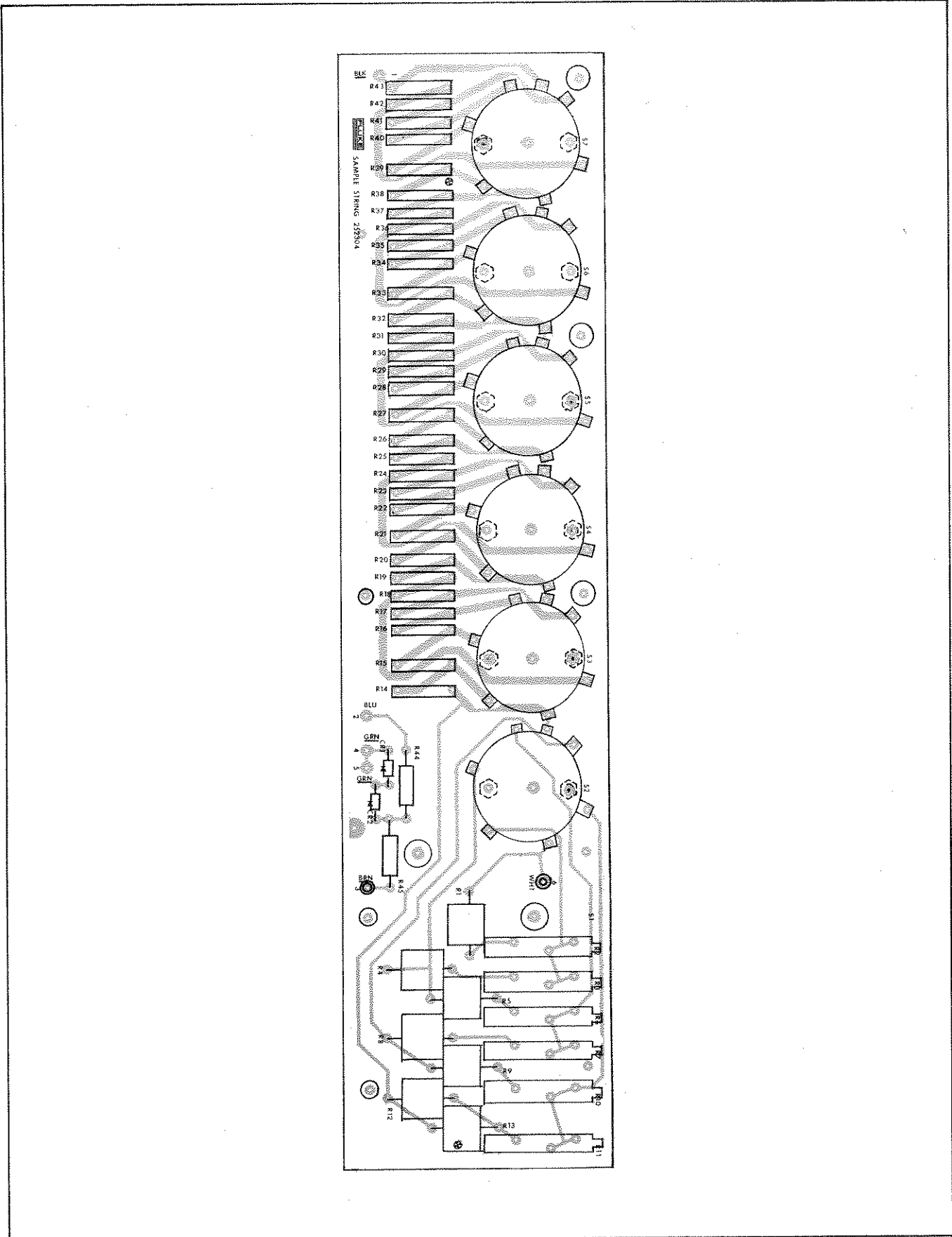



Figure 5-12. SAMPLE STRING P/C ASSEMBLY (343A)

REF DESIG	INDEX NO	DESCRIPTION	STOCK NO	MFR	MFR PART NO	TOT QTY	REC QTY	USE CODE
R25		Res, ww, 100Ω, matched						
R26		Res, ww, 20Ω±0.25%, 0.7w	4707-255620	01686	Type T2	5		
R27		Res, ww, 20Ω ±0.25%, 0.7w	4707-255620	01686	Type T2	REF		
R28		Res, ww, 20Ω ±0.25%, 0.7w	4707-255620	01686	Type T2	REF		
R29		Res, ww, 20Ω ±0.25%, 0.7w	4707-255620	01686	Type T2	REF		
R30		Res, ww, 20Ω ±0.25%, 0.7w	4707-255620	01686	Type T2	REF		
R31		Res, ww, 10Ω ±0.25%, 0.7w	4707-255638	01686	Type T2	1		
R32		Res, ww, 2Ω ±1%, 0.7w	4707-255646	01686	Type T2	5		
R33		Res, ww, 2Ω ±1%, 0.7w	4707-255646	01686	Type T2	REF		
R34		Res, ww, 2Ω ±1%, 0.7w	4707-255646	01686	Type T2	REF		
R35		Res, ww, 2Ω ±1%, 0.7w	4707-255646	01686	Type T2	REF		
R36		Res, ww, 2Ω ±1%, 0.7w	4707-255646	01686	Type T2	REF		
R37		Res, ww, 1Ω ±1%, 0.7w	4707-255653	01686	Type T2	1		
R38		Res, ww, 0.2Ω ±3%, 0.7w	4707-255661	01686	Type T2	5		
R39		Res, ww, 0.2Ω ±3%, 0.7w	4707-255661	01686	Type T2	REF		
R40		Res, ww, 0.2Ω ±3%, 0.7w	4707-255661	01686	Type T2	REF		
R41		Res, ww, 0.2Ω ±3%, 0.7w	4707-255661	01686	Type T2	REF		
R42		Res, ww, 0.2Ω ±3%, 0.7w	4707-255661	01686	Type T2	REF		
R43		Res, ww, 0.1Ω ±3%, 0.7w	4707-255679	01686	Type T2	1		
R44		Res, met flm, 4.99k ±1%, 1/2w	4705-148890	19701	Type MF7C	1		
R45		Res, met flm, 3.16k ±1%, 1/2w	4705-187781	19701	Type MF7C	1		
S2		Switch, rotary, Decade 2	5105-257253	89536	5105-257253	6		
S3		Switch, rotary, Decade 3	5105-257253	89536	5105-257253	REF		
S4		Switch, rotary, Decade 4	5105-257253	89536	5105-257253	REF		
S5		Switch, rotary, Decade 5	5105-257253	89536	5105-257253	REF		
S6		Switch, rotary, Decade 6	5105-257253	89536	5105-257253	REF		
S7		Switch, rotary, Decade 7	5105-257253	89536	5105-257253	REF		



R1, R4, R5, R8, R9 and R12 thru R25 are part of an intermatched resistor set, part number 4710-265330 (See , page 5-41). The resistors may be replaced individually by giving model, serial number, full reference designation, and all markings on the old resistor. However, R12/R13 must be ordered and replaced as a pair.

## 5-9. SERIAL NUMBER EFFECTIVITY

5-10. A Use Code column is provided to identify certain parts that have been added, deleted, or modified during production of the Model 341A and 343A. Each part for which a use code has been assigned may be identified with a particular instrument serial number by consulting the Use Code Effectivity List below. All parts with no code are used on all instruments with serial numbers above 123.

USE CODE	EFFECTIVITY
NO CODE	Model 341A serial number 123 and on. Model 343A serial number 123 and on.

## Section 7

# General Information

7-1. This section of the manual contains generalized user information as well as supplemental information to the List of Replaceable Parts contained in Section 5. The following information is presented in this section:

List of Abbreviations

Federal Supply Codes for Manufacturers

Fluke Technical Service Centers - U.S. and Canada

Fluke Technical Service Centers - International

Sales Representatives - U.S. and Canada

Sales Representatives - International

## List of Abbreviations and Symbols

<b>A or amp</b>	ampere	<b>hf</b>	high frequency	<b>(+) or pos</b>	positive
<b>ac</b>	alternating current	<b>Hz</b>	hertz	<b>pot</b>	potentiometer
<b>af</b>	audio frequency	<b>IC</b>	integrated circuit	<b>p-p</b>	peak-to-peak
<b>a/d</b>	analog-to-digital	<b>if</b>	intermediate frequency	<b>ppm</b>	parts per million
<b>assy</b>	assembly	<b>in</b>	inch(es)	<b>PROM</b>	programmable read-only memory
<b>AWG</b>	american wire gauge	<b>intl</b>	internal	<b>psi</b>	pound-force per square inch
<b>B</b>	bel	<b>I/O</b>	input/output	<b>RAM</b>	random-access memory
<b>bcd</b>	binary coded decimal	<b>k</b>	kilo (10 <sup>3</sup> )	<b>rf</b>	radio frequency
<b>°C</b>	Celsius	<b>kHz</b>	kilohertz	<b>rms</b>	root mean square
<b>cap</b>	capacitor	<b>kΩ</b>	kilohm(s)	<b>ROM</b>	read-only memory
<b>ccw</b>	counterclockwise	<b>kV</b>	kilovolt(s)	<b>s or sec</b>	second (time)
<b>cer</b>	ceramic	<b>lf</b>	low frequency	<b>scope</b>	oscilloscope
<b>cermet</b>	ceramic to metal(seal)	<b>LED</b>	light-emitting diode	<b>SH</b>	shield
<b>ckt</b>	circuit	<b>LSB</b>	least significant bit	<b>Si</b>	silicon
<b>cm</b>	centimeter	<b>LSD</b>	least significant digit	<b>serno</b>	serial number
<b>cmrr</b>	common mode rejection ratio	<b>M</b>	mega (10 <sup>6</sup> )	<b>sr</b>	shift register
<b>comp</b>	composition	<b>m</b>	milli (10 <sup>-3</sup> )	<b>Ta</b>	tantalum
<b>cont</b>	continue	<b>mA</b>	milliampere(s)	<b>tb</b>	terminal board
<b>crt</b>	cathode-ray tube	<b>max</b>	maximum	<b>tc</b>	temperature coefficient or temperature compensating
<b>cw</b>	clockwise	<b>mf</b>	metal film	<b>tcxo</b>	temperature compensated crystal oscillator
<b>d/a</b>	digital-to-analog	<b>MHz</b>	megahertz	<b>tp</b>	test point
<b>dac</b>	digital-to-analog converter	<b>min</b>	minimum	<b>u or μ</b>	micro (10 <sup>-6</sup> )
<b>dB</b>	decibel	<b>mm</b>	millimeter	<b>uhf</b>	ultra high frequency
<b>dc</b>	direct current	<b>ms</b>	millisecond	<b>us or μs</b>	microsecond(s) (10 <sup>-6</sup> )
<b>dmm</b>	digital multimeter	<b>MSB</b>	most significant bit	<b>uut</b>	unit under test
<b>dvm</b>	digital voltmeter	<b>MSD</b>	most significant digit	<b>V</b>	volt
<b>elect</b>	electrolytic	<b>MTBF</b>	mean time between failures	<b>v</b>	voltage
<b>ext</b>	external	<b>MTTR</b>	mean time to repair	<b>var</b>	variable
<b>F</b>	farad	<b>mV</b>	millivolt(s)	<b>vco</b>	voltage controlled oscillator
<b>°F</b>	Fahrenheit	<b>mv</b>	multivibrator	<b>vhf</b>	very high frequency
<b>FET</b>	Field-effect transistor	<b>MΩ</b>	megohm(s)	<b>vlf</b>	very low frequency
<b>ff</b>	flip-flop	<b>n</b>	nano (10 <sup>-9</sup> )	<b>W</b>	watt(s)
<b>freq</b>	frequency	<b>na</b>	not applicable	<b>ww</b>	wire wound
<b>FSN</b>	federal stock number	<b>NC</b>	normally closed	<b>xfmr</b>	transformer
<b>g</b>	gram	<b>(-) or neg</b>	negative	<b>xstr</b>	transistor
<b>G</b>	giga (10 <sup>9</sup> )	<b>NO</b>	normally open	<b>xtal</b>	crystal
<b>gd</b>	guard	<b>ns</b>	nanosecond	<b>xtlo</b>	crystal oscillator
<b>Ge</b>	germanium	<b>opnl amp</b>	operational amplifier	<b>Ω</b>	ohm(s)
<b>GHz</b>	gigahertz	<b>p</b>	pico (10 <sup>-12</sup> )	<b>μ</b>	micro (10 <sup>-6</sup> )
<b>gmV</b>	guaranteed minimum value	<b>para</b>	paragraph		
<b>gnd</b>	ground	<b>pcb</b>	printed circuit board		
<b>H</b>	henry	<b>pF</b>	picofarad		
<b>hd</b>	heavy duty	<b>pn</b>	part number		

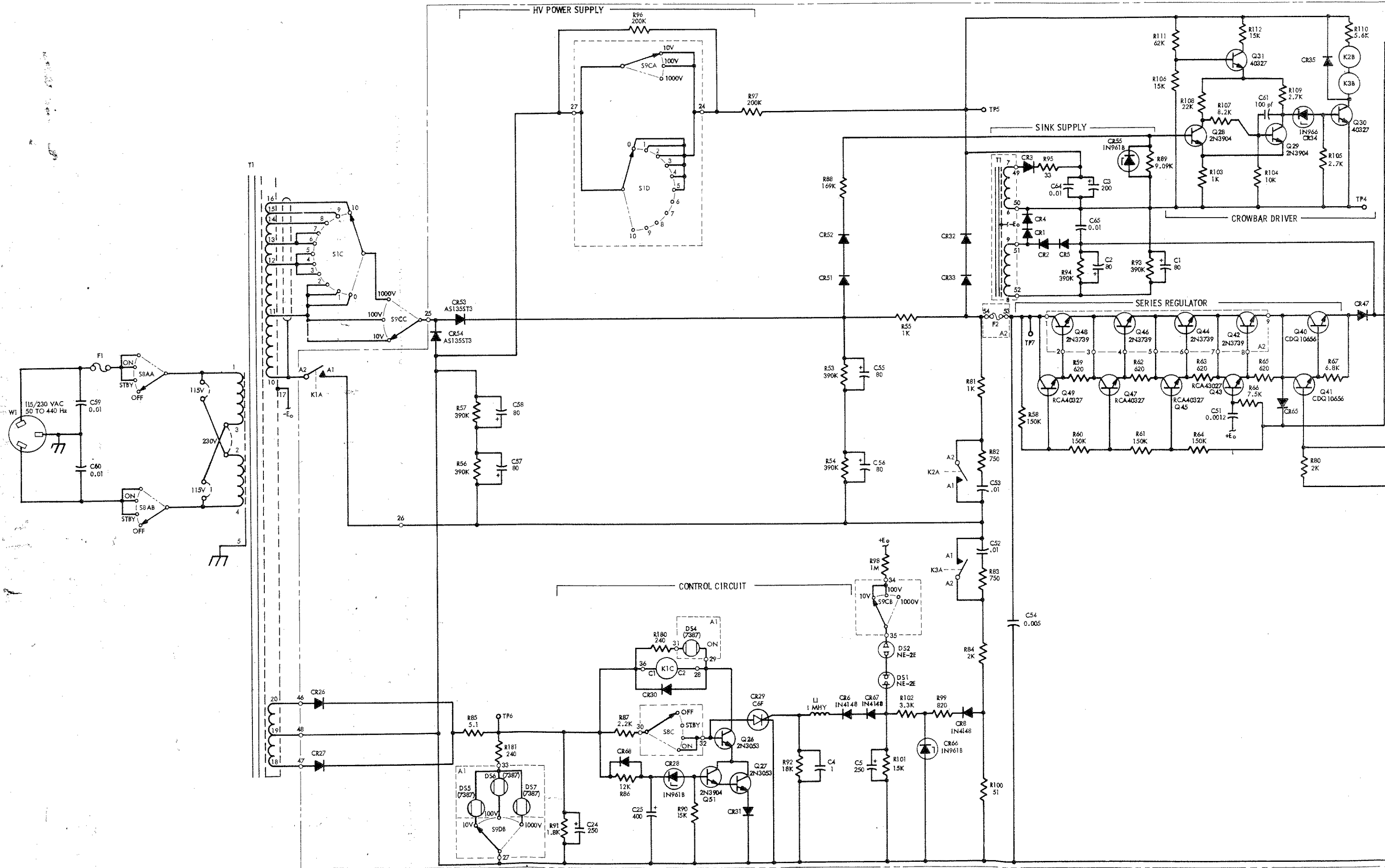

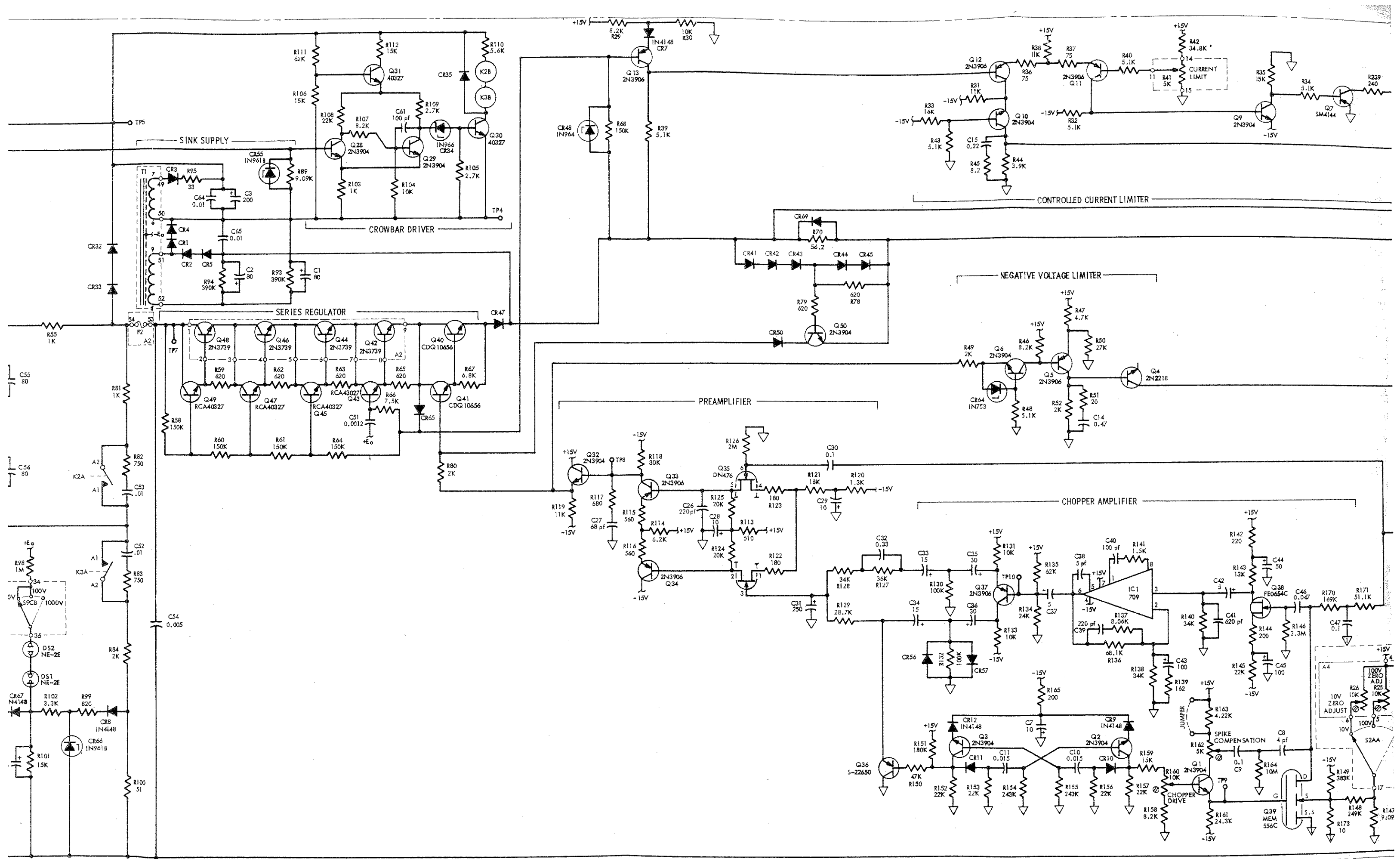

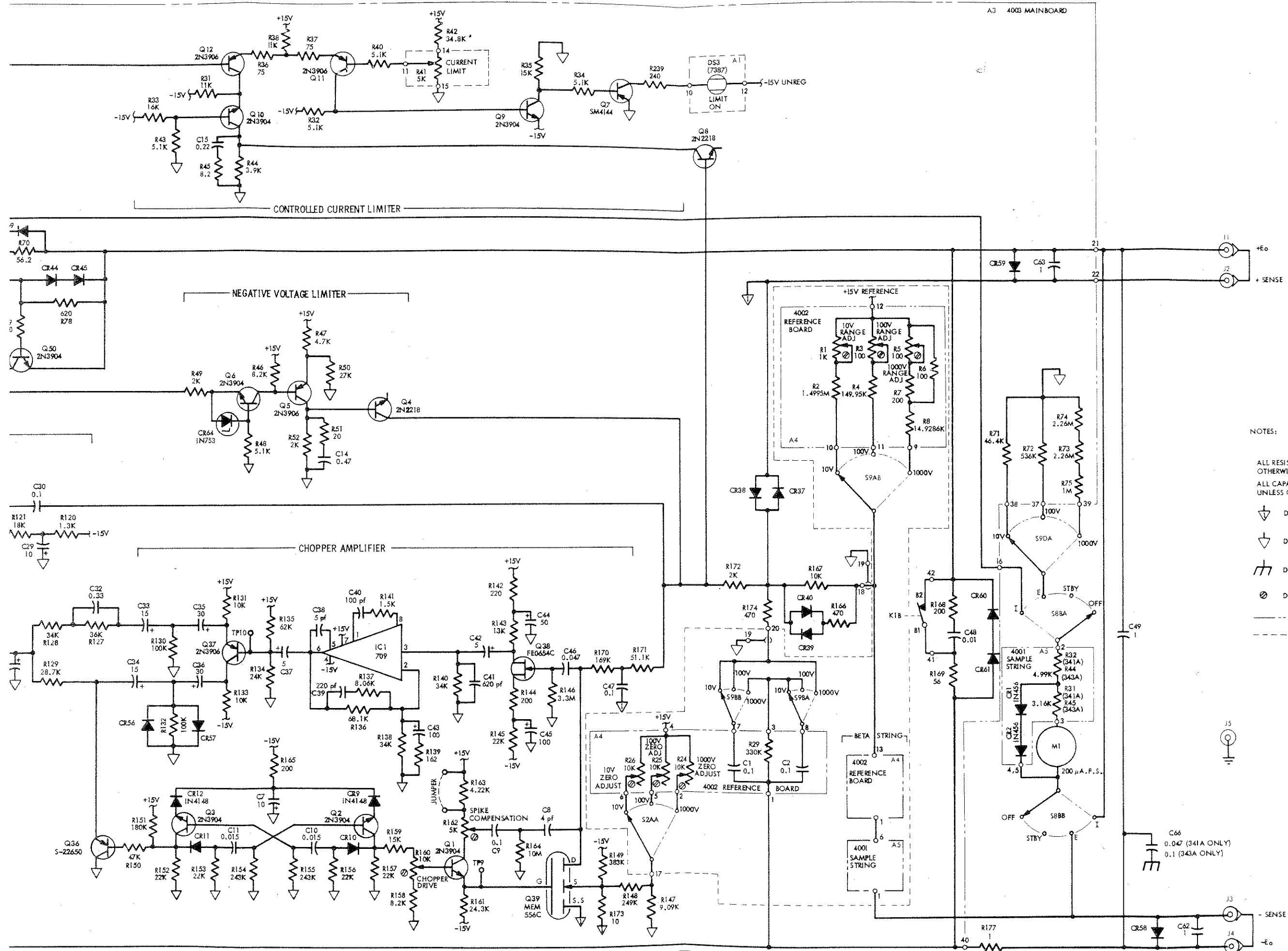

NOTES:

- ALL RESISTANCES IN OHMS UNLESS OTHERWISE NOTED.
- ALL CAPACITANCES IN MICROFARADS UNLESS OTHERWISE NOTED.
- ⏏ DENOTES + SENSE
- ⏏ DENOTES CIRCUIT GROUND
- ⏏ DENOTES CHASSIS GROUND
- ⊗ DENOTES INTERNAL ADJUSTMENT
- DENOTES ASSEMBLY
- - - DENOTES COMPONENTS NOT MOUNTED ON ASSEMBLY

FUNCTIONAL SCHEMATIC DIAGRAM	
MODEL 341A/MODEL 343A	
DC VOLTAGE CALIBRATOR	
SCHEMATIC NO. 1	
SER. NO. 123 & ON	REV. 2
JOHN FLUKE MFG. CO., INC. P.O. Box 7428 Seattle, Washington 98133	



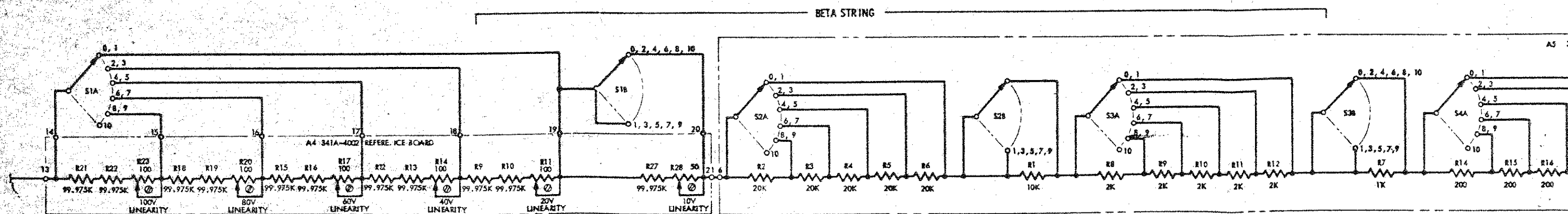
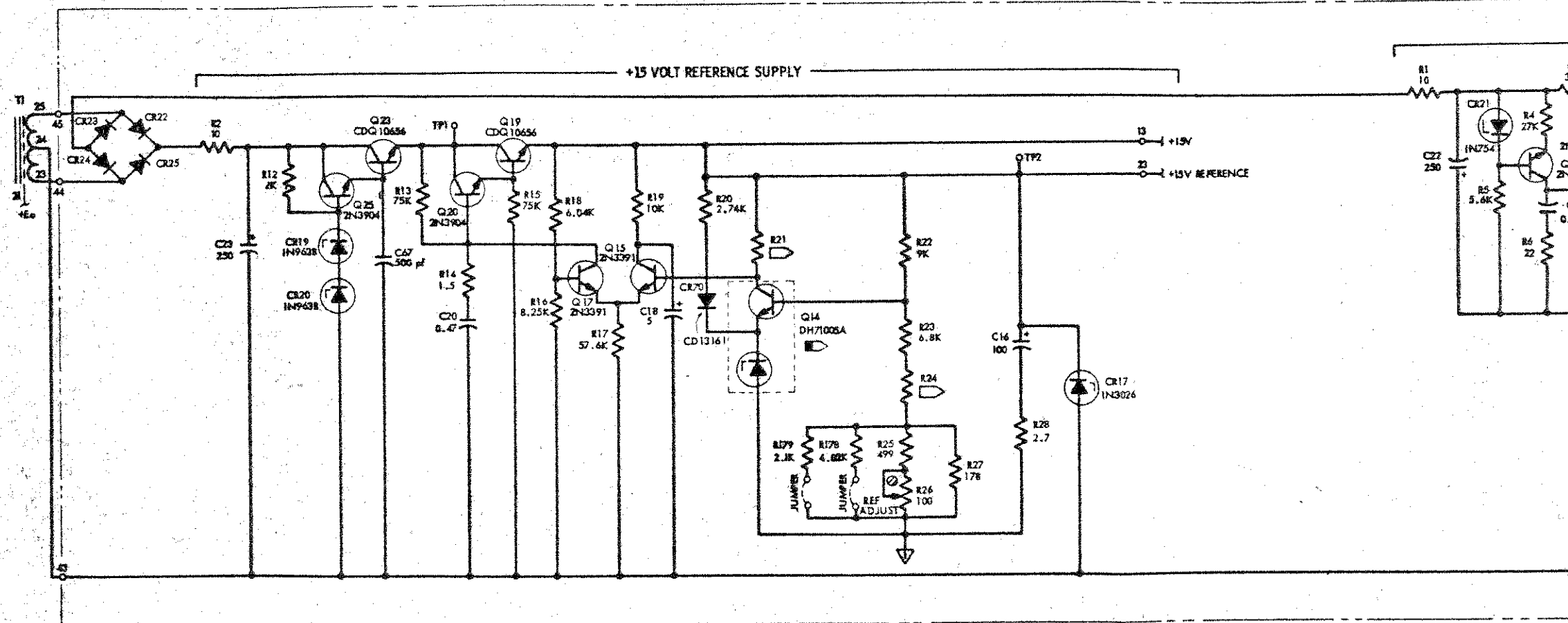
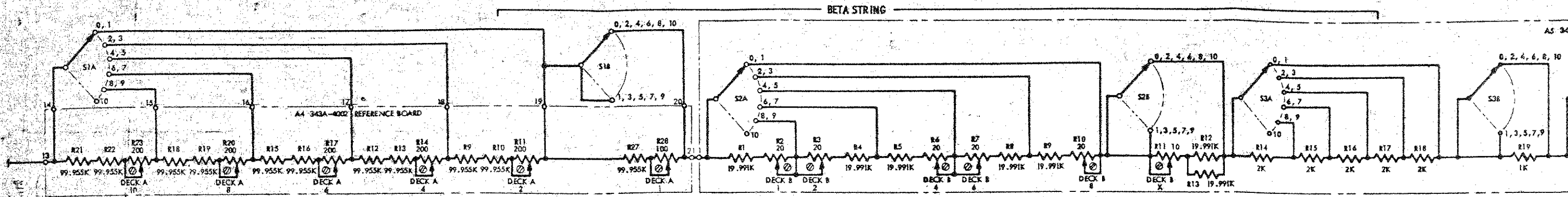

AS 343A-4001 SAMPLE STRING

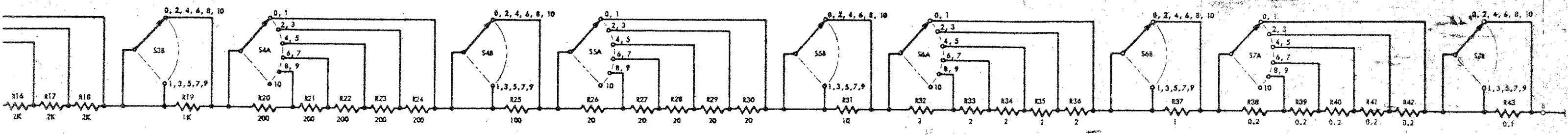

-15 VOLT AUXILIARY SUPPLY

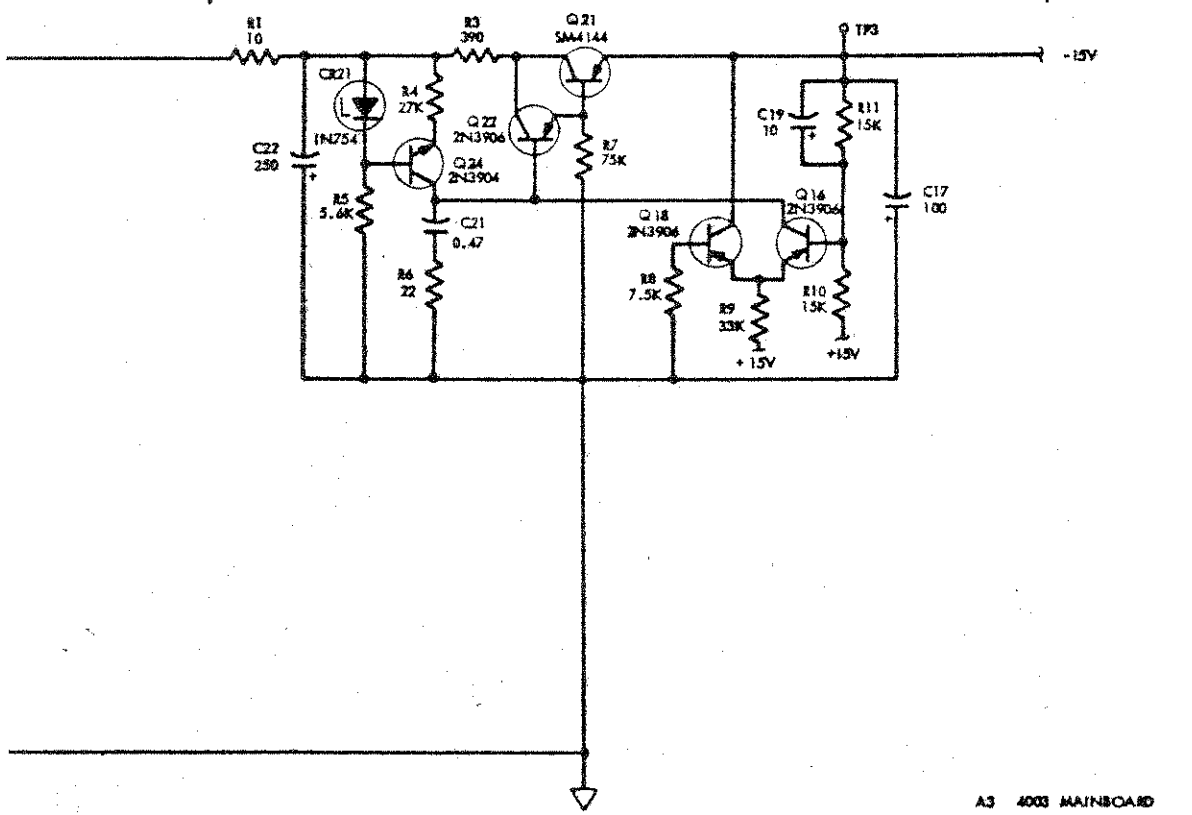

A3 4003 MAINBOARD

- NOTES:
- ALL RESISTANCES IN OHMS UNLESS OTHERWISE AS NOTED.
  - ALL CAPACITANCES IN MICROFARADS UNLESS OTHERWISE AS NOTED
  - ◊ SELECTED WITH Q14
  - ◻ DENOTES FACTORY SELECTED COMPONENT
  - ▽ DENOTES + SENSE
  - ▽ DENOTES CIRCUIT GROUND
  - ⊗ DENOTES INTERNAL ADJUSTMENT
  - DENOTES ASSEMBLY

AS 341A-4001 SAMPLE STRING

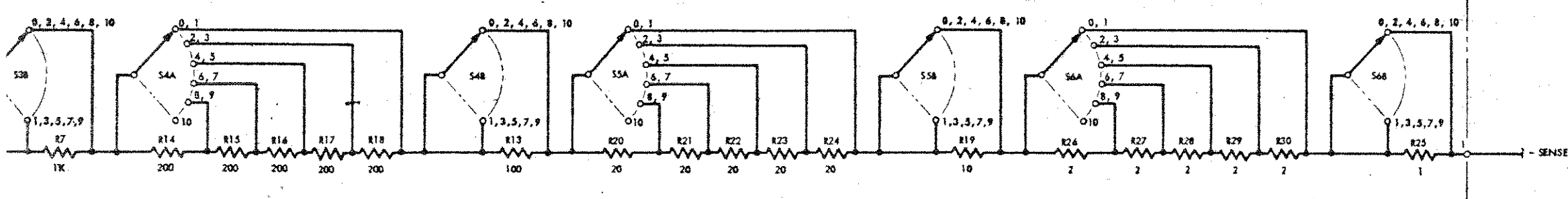

FUNCTIONAL SCHEMATIC DIAGRAM

MODEL 341A/MODEL 343A

DC VOLTAGE CALIBRATOR

SCHEMATIC NO 2

SER. NO. 123 & ON

FLUKE JOHN FLUKE MFG. CO., INC.  
P.O. Box 7428 Seattle, Washington 98122

## Free Manuals Download Website

<http://myh66.com>

<http://usermanuals.us>

<http://www.somanuals.com>

<http://www.4manuals.cc>

<http://www.manual-lib.com>

<http://www.404manual.com>

<http://www.luxmanual.com>

<http://aubethermostatmanual.com>

Golf course search by state

<http://golfingnear.com>

Email search by domain

<http://emailbydomain.com>

Auto manuals search

<http://auto.somanuals.com>

TV manuals search

<http://tv.somanuals.com>