



# IP to RS-232 Converter

EXT-IP-2-RS2322

User Manual



Release A1

# Important Safety Instructions

1. Read these instructions.
2. Keep these instructions.
3. Heed all warnings.
4. Follow all instructions.
5. Do not use this product near water.
6. Clean only with a dry cloth.
7. Do not block any ventilation openings. Install in accordance with the manufacturer's instructions.
8. Do not install or place this product near any heat sources such as radiators, heat registers, stoves, or other apparatus (including amplifiers) that produce heat.
9. Do not defeat the safety purpose of the polarized or grounding-type plug. A polarized plug has two blades with one wider than the other. A grounding type plug has two blades and a third grounding prong. The wide blade or the third prong are provided for your safety. If the provided plug does not fit into your outlet, consult an electrician for replacement of the obsolete outlet.
10. Protect the power cord from being walked on or pinched particularly at plugs, convenience receptacles, and the point where they exit from the apparatus.
11. Only use attachments/accessories specified by the manufacturer.
12. To reduce the risk of electric shock and/or damage to this product, never handle or touch this unit or power cord if your hands are wet or damp. Do not expose this product to rain or moisture.
13. Unplug this apparatus during lightning storms or when unused for long periods of time.
14. Refer all servicing to qualified service personnel. Servicing is required when the apparatus has been damaged in any way, such as power-supply cord or plug is damaged, liquid has been spilled or objects have fallen into the apparatus, the apparatus has been exposed to rain or moisture, does not operate normally, or has been dropped.
15. Batteries that may be included with this product and/or accessories should never be exposed to open flame or excessive heat. Always dispose of used batteries according to the instructions.

# Warranty Information

Gefen warrants the equipment it manufactures to be free from defects in material and workmanship.

If equipment fails because of such defects and Gefen is notified within two (2) years from the date of shipment, Gefen will, at its option, repair or replace the equipment, provided that the equipment has not been subjected to mechanical, electrical, or other abuse or modifications. Equipment that fails under conditions other than those covered will be repaired at the current price of parts and labor in effect at the time of repair. Such repairs are warranted for ninety (90) days from the day of reshipment to the Buyer.

This warranty is in lieu of all other warranties expressed or implied, including without limitation, any implied warranty or merchantability or fitness for any particular purpose, all of which are expressly disclaimed.

1. Proof of sale may be required in order to claim warranty.
2. Customers outside the US are responsible for shipping charges to and from Gefen.
3. Copper cables are limited to a 30 day warranty and cables must be in their original condition.

The information in this manual has been carefully checked and is believed to be accurate. However, Gefen assumes no responsibility for any inaccuracies that may be contained in this manual. In no event will Gefen be liable for direct, indirect, special, incidental, or consequential damages resulting from any defect or omission in this manual, even if advised of the possibility of such damages. The technical information contained herein regarding the features and specifications is subject to change without notice.

For the latest warranty coverage information, refer to the Warranty and Return Policy under the Support section of the Gefen Web site at [www.gefen.com](http://www.gefen.com).

## Technical Support

(818) 772-9100      (800) 545-6900  
8:00 AM to 5:00 PM Monday - Friday, Pacific Time

## Fax

(818) 772-9120

## Email

support@gefen.com

## Web

<http://www.gefen.com>

## Mailing Address

Gefen, LLC  
c/o Customer Service  
20600 Nordhoff St.  
Chatsworth, CA 91311

## Product Registration

Register your product here: <http://www.gefen.com/kvm/Registry/Registration.jsp>

- When using the IP to 2 x RS-232 Converter for the first time, it is recommended that the unit be configured using the Gefen Discovery Tool. The Gefen Discovery Tool is free software that is available from the Support > Downloads section of the Gefen Web site.

**IP to 2 x RS-232 Converter** is a trademark of Gefen, LLC.

© 2014 Gefen, LLC. All Rights Reserved. All trademarks are the property of their respective owners.

Gefen, LLC reserves the right to make changes in the hardware, packaging, and any accompanying documentation without prior written notice.



This product uses UL or CE listed power supplies.

## Features

- Allows IP control of two RS-232-enabled devices
- Supports Telnet and UDP protocols
- Each of the RS-232 devices can be addressed independently
- Configurable via Web server interface
- Independently configurable RS-232 baud rate and line delay for each RS-232 port
- Gefen Discovery Tool-compatible
- Field-upgradable firmware via Web server interface
- Locking power supply connector
- Surface-mountable

## Packing List

The IP to 2 x RS-232 Converter ships with the items listed below. If any of these items are not present in your box when you first open it, immediately contact your dealer or Gefen.

- 1 x IP to 2 x RS-232 Converter
- 1 x 5V DC Power Supply
- 1 x Quick-Start Guide



## 1 Getting Started

Introduction.....	2
Installation .....	4
Connection Instructions.....	4
Sample Wiring Diagram .....	4

## 2 Advanced Operation

RS-232 and IP Configuration .....	8
Configuration using the Gefen Discovery Tool.....	8
Configuration using RS-232 .....	9
Commands.....	11
Web Interface .....	53
Using the built-in Web Interface .....	53
RS-232 .....	54
Network tab .....	60
System tab .....	66

## 3 Appendix

Default Settings .....	70
RS-232 .....	70
Network .....	71
Specifications .....	72







# IP to RS-232 Converter

## 1 Getting Started

Introduction.....	2
Installation .....	4
Connection Instructions.....	4
Sample Wiring Diagram .....	4

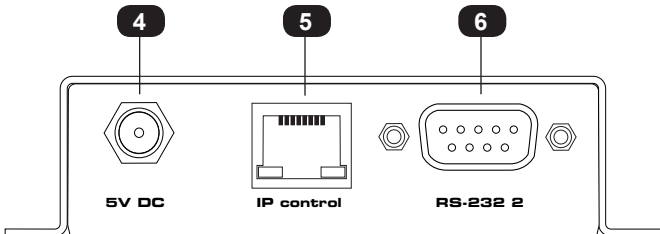
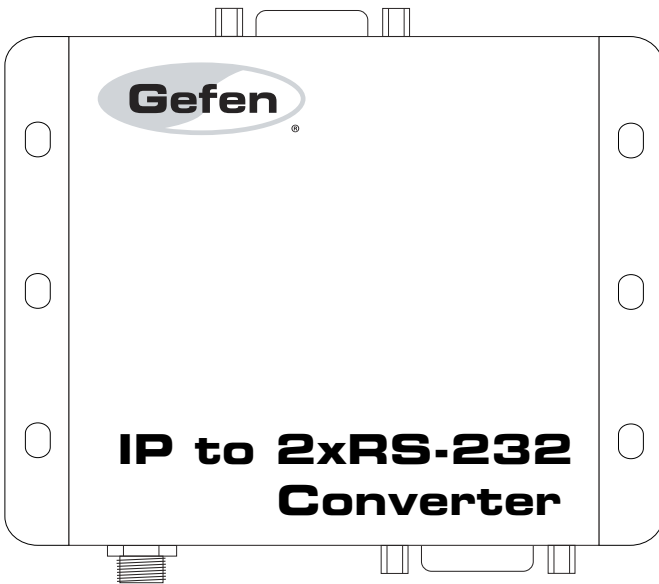
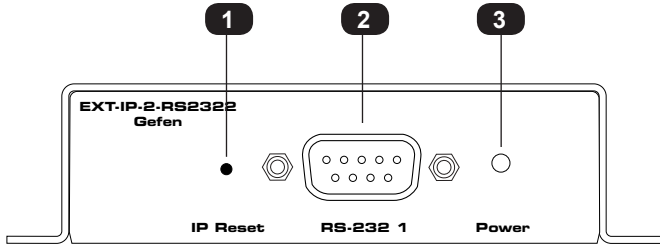

ID	Name	Description
1	IP Reset	Resets the unit to its default IP settings.
2	RS-232 1	Connect an RS-232 cable from this port to an RS-232 device. See <a href="#">Installation (page 4)</a> for more information.
3	Power	This LED will glow bright blue when the unit is powered.
4	5V DC	Connect the included 5V DC power supply to this power receptacle.
5	IP control	Connect an Ethernet cable between this jack and an IP-based automation control device
6	RS-232 2	Connect an RS-232 cable from this port to an RS-232 device. See <a href="#">Installation (page 4)</a> for more information.

## Connection Instructions

1. Connect an Ethernet cable between the IP-based control device and the **IP control** port on the IP to 2 x RS-232 Converter.

An Ethernet switch can also exist between the IP to 2 x RS-232 Converter and the IP-based control device (see Sample Wiring Diagram below).

2. Connect an RS-232 device to each of the RS-232 ports (RS-232 1 and RS-232 2) on the IP to 2 x RS-232 Converter.
3. Connect the included 5V DC locking power supply to the 5V DC power receptacle on the IP to 2 x RS-232 Converter. Do not overtighten the locking power connectors.
4. Connect the AC power cord from the power supply to an available electrical outlet.

## Sample Wiring Diagram



**DB-9 CABLE**   
**CAT-5 CABLE** 

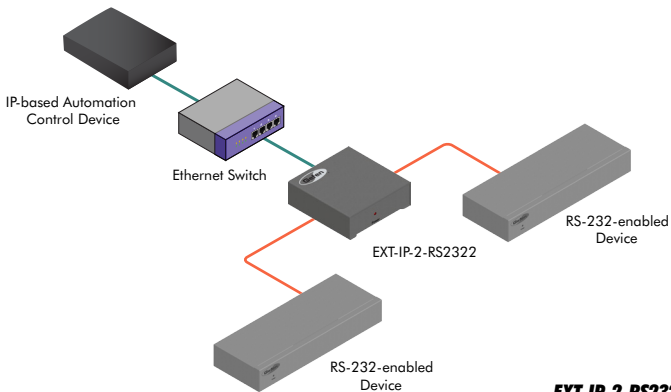

**EXT-IP-2-RS2322**







# IP to RS-232 Converter

## 2

## Advanced Operation

RS-232 and IP Configuration .....	8
Configuration using the Gefen Discovery Tool.....	8
Configuration using RS-232 .....	9
Commands .....	11
Web Interface .....	53
Using the built-in Web Interface .....	53
RS-232 .....	54
Network tab .....	60
System tab .....	66

## Configuration using the Gefen Discovery Tool

When using the IP to 2 x RS-232 Converter for the first time, it is recommended that the unit be configured using the Gefen Discovery Tool. The Gefen Discovery Tool is free software that is available from the Support > Downloads section of the Gefen Web site.

1. Download the Gefen Discovery Tool from the Gefen Web site. Extract the files from the .zip file and follow the installation and configuration instructions in the included User Manual.
2. Connect the IP to 2 x RS-232 Converter to the network.
3. Use the Gefen Discovery Tool to identify the unit on the network.
4. Refer to the Gefen Discovery Tool User Manual for important information on setting the IP address, subnet mask, gateway, HTTP listening port, and Telnet listening port.

The following table lists the default IP settings for the IP to 2 x RS-232 Converter.

Description	IP Address / Port	Description	IP Address / Port
IP Address	192.168.1.72	UDP Port	23
Subnet	255.255.255.0	Local UDP Port	50007
Gateway	192.168.1.254	Remote UDP IP	192.168.1.255
HTTP Port	80	Remote UDP Port	50008

5. After the IP settings have been set, make sure to click the Save button in the Gefen Discovery Tool to save the changes. After saving the changes, click the Reboot button to reboot the unit.
6. Launch a Web browser and enter the IP address, that was assigned to the IP to 2 x RS-232 Converter, in the address bar to access the Web interface.

## Configuration using RS-232

To configure the IP settings of the IP to 2 x RS-232 Converter using RS-232 commands, use the following procedure:

1. Connect a *null-modem* ("crossover") cable from the RS-232 port on the computer to the IP to 2 x RS-232 Converter.

The null-modem cable can be connected to either RS-232 1 or RS-232 2.

*Diagram 2.1 - Configuration using a null-modem cable.*

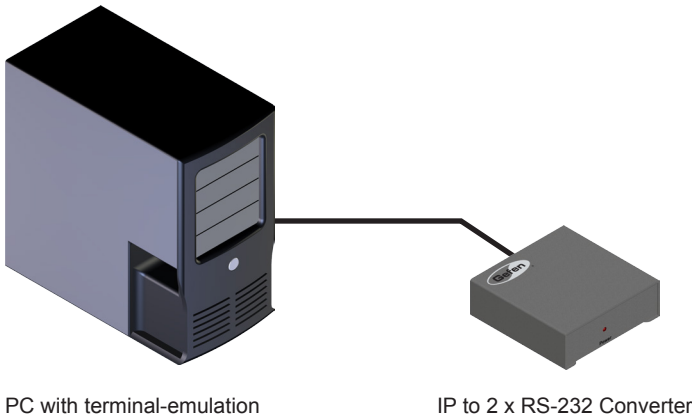

2. Use the following COM port settings in the terminal program:

Description	Setting
Baud rate	19200
Data bits	8
Parity	None
Stop bits	1
Hardware flow control	None

3. Set the IP address using the `#set_ipadd` command.
4. Set the subnet mask using the `#set_netmask` command.

(continued on next page)

5. Set the gateway (router) IP address using the `#set_gateway` command.
6. Set the Telnet listening port using the `#set_tcp_term_port` command.
7. Set the HTTP listening port using the `#set_http_port` command.
8. Set the UDP remote IP address using the `#set_udp_rip` command.
9. Set the UDP listening port using the `#set_udp_port` command.
10. Set the UDP remote port using the `#set_udp_rport` command.
11. Reboot the IP to 2 x RS-232 Converter to apply all changes.
12. Launch the desired Web browser and enter the IP address, specified in step 3, in the address bar to access the Web interface.



### Information

Depending upon the network, all related IP, Telnet, and UDP settings will need to be assigned. If necessary, consult your network administrator to obtain the proper settings.

Command	Description
#help	Displays a list of all available commands
#set_add_delim	Enables or disables option to add delimiter to data
#set_device_descr	Sets the device description
#set_end_del	Sets the end frame delimiter
#set_gateway	Sets the gateway (router) IP address
#set_http_port	Sets the HTTP listening port of the IP to RS-232 Converter
#set_ipadd	Sets the IP address of the IP to RS-232 Converter
#set_netmask	Sets the subnet mask of the IP to RS-232 Converter
#set_send_byte_cnt	Sets the send-byte count value for bridging mode
#set_send_time_out	Sets the time-out value for sending data
#set_serial_descr	Assigns a description to the specified RS-232 port
#set_serial_mode	Sets the serial mode (TCP, UDP, or Terminal)
#set_serial_params	Assigns the settings to the specified RS-232 port
#set_start_del	Sets the Start Frame delimiter
#set_tcp_br_port	Sets the TCP bridge listening port
#set_tcp_term_port	Sets the TCP terminal listening port
#set_telnet_pass	Sets the TCP terminal password
#set_udp_br_port	Sets the UDP bridge listening port
#set_udp_echo_br	Enables or disables UDP bridge echo
#set_udp_port	Sets the UDP listening port
#set_udp_remote_br	Assigns the UDP bridge settings for the specified RS-232 port
#set_udp_rip	Sets the remote UDP IP address
#set_udp_rport	Sets the UDP remote port
#show_del_prms	Dusplays the current delimiter parameters for the specified serial port
#show_device_descr	Displays the device description
#show_ipconfig	Displays the current TCP/IP and UDP settings of the IP to 2 x RS-232 Converter
#show_me	Enables or disables the flashing of the LED on the device
#show_serial_descr	Displays the current description of the specified RS-232 port
#show_serial_mode	Displays the mode of the specified RS-232 port

(continued on next page)

Command	Description
<code>#show_serial_params</code>	Displays the settings of the specified RS-232 port
<code>#show_telnet_pass</code>	Displays the current TCP terminal password
<code>#show_ver_data</code>	Displays the firmware and hardware version of the IP to RS-232 Converter
<code>#system_wide_reset</code>	Restarts the IP to 2 x RS-232 Converter according to the supplied parameter
<code>#use_discovery</code>	Enables or disables discovery mode
<code>#use_tcp_access</code>	Enables or disables TCP access mode
<code>#use_tcp_term_pass</code>	Enables or disables the password prompt at the beginning of a Telnet session
<code>#use_udp_access</code>	Enables or disables UDP access
<code>#use_udp_echo</code>	Enables or disables UDP echo

## #help

Displays help on a specific command. If no command is specified (*param1*), then a list of all available commands will be displayed. Set *param1* to "full" to display a list of all commands.

### Syntax

```
#help
```

### Parameters

*param1* Command (optional)

### Example

```
#help #set_add_delim
```

```
Cmd #set_add_delim: Set Add delimiter mode
Syntax: #set_add_delim [param1][param2]
Param1: Serial Port(1,2)
Param2: 1 - On , 0 - Off
e.g: #set_add_delim 1 0
```

```
#help full
```

```
...
```

```
Cmd #show_serial_params: Show Serial Port Parameters
Syntax: #show_serial_params
Param: Serial Port(1,2)
e.g: #show_serial_params 1
```

```
Cmd #set_serial_mode: Set Serial Port mode
Syntax: #set_uart_mode [param1][param2]
Param1: Serial Port(1,2)
Param2: 1 (Terminal) for Port1 only, 2 (TCP Bridge), 3 (UDP Bridge)
e.g: #set_serial_mode 1 2
```

```
...
```

```
...
```

(continued on next page)

```
#help
#show_ipconfig
#set_ipadd
#set_netmask
#set_gateway
#set_http_port
#set_tcp_term_port
#set_udp_port
#show_ver_data
#show_telnet_pass
#set_telnet_pass
#use_tcp_term_pass
#set_udp_rip
#set_udp_rport
#use_udp_access
#use_udp_echo
#use_tcp_access
#set_serial_params
#show_serial_params
#set_serial_mode
#show_serial_mode
#show_serial_connect
#set_serial_descr
#show_serial_descr
#set_tcp_br_port
#set_udp_br_port
#set_udp_remote_br
#set_udp_echo_br
#use_discovery
#set_add_delim
#set_start_del
#set_end_del
#set_send_time_out
#set_send_byte_cnt
#show_del_prms
#set_device_descr
#show_device_descr
#show_me
#system_wide_reset
```



## #set\_add\_delim

Enables or disables the option to include a delimiter as part of the data sent to the control system.

### Syntax

```
#set_add_delim param1 param2
```

### Parameters

<i>param1</i>	Value	[1 ... 2]
<i>param2</i>	State	[0 ... 1]

Value	Description
0	Off
1	On

### Example

```
#set_add_delim 1
Add delimiter mode to ON
```

### Related Commands

```
#set_end_del
#set_start_del
```

## #set\_device\_descr

Sets the device description. The device description cannot exceed 30 characters in length

### Syntax

```
#set_device_descr param1
```

### Parameters

<i>param1</i>	Description	[30 chars max.]
---------------	-------------	-----------------

### Example

```
#set_device_descr LivingRoom_Bridge2  
Device Description changed to: LivingRoom_Bridge2
```

### Related Commands

```
#show_device_descr
```

## #set\_end\_del

Sets the end-delimiter mode and value for the specified serial port. The End Delimiter value must be specified in hexadecimal. Before executing this command, the Start Delimiter must be set, using the `#set_start_del` command.

### Syntax

```
#set_end_del param1 param2 param3
```

### Parameters

<i>param1</i>	Serial port	[1 ... 2]
<i>param2</i>	State	[0 ... 1]

Value	Description
0	Off
1	On

<i>param3</i>	End delimiter	[00 ... FF]
---------------	---------------	-------------

### Example

```
#set_end_del 1 1 ba
End delimiter set to ON with a value of ba
```

### Related Commands

```
#set_add_delim
#set_start_del
```

## #set\_gateway

Sets the gateway address. The gateway must be typed using dot-decimal notation. The matrix must be rebooted after executing this command. The default gateway is 192.168.1.1.

### Syntax

```
#sgateway param1
```

### Parameters

*param1* Gateway

### Example

```
#set_gateway 10.5.64.1  
New IP Gateway set to: 10.5.64.1
```

### Related Commands

```
#set_add_delim  
#set_ipadd  
#set_netmask  
#show_ipconfig
```

## #set\_http\_port

Specifies the Web server listening port. The unit must be rebooted after executing this command. The default port setting is 80.

### Syntax

```
#set_http_port param1
```

### Parameters

<i>param1</i>	Port	[1 ... 1024]
---------------	------	--------------

### Example

```
#set_http_port 82  
New HTTP port set to: 82
```

### Related Commands

```
#set_gateway  
#set_ipadd  
#set_netmask  
#show_ipconfig
```

## #set\_ipadd

Specifies the IP address of the IP to 2 x RS-232 Converter. The IP address must be specified using dot-decimal notation. The unit must be rebooted after executing this command. The default IP address is 192.168.1.72.

### Syntax

```
#set_ipadd param1
```

### Parameters

*param1* IP address

### Example

```
#set_ipadd 10.5.64.187  
New IP set to: 10.5.64.187
```

### Related Commands

```
#set_gateway  
#set_http_port  
#set_end_del  
#show_ipconfig
```



## #set\_send\_byte\_cnt

Sets the send-byte count value for bridging mode.

### Syntax

```
#set_send_byte_cnt param1
```

### Parameters

<i>param1</i>	Serial port	[1 ... 2]
<i>param2</i>	Byte count	[0 ... 255]

### Example

```
#set_send_byte_cnt 1 100
UART 1 bridging send byte count limit is set to 100 bytes
```

### Related Commands

```
#set_add_delim
#set_end_del
#set_serial_mode
#set_start_del
```



## #set\_send\_time\_out

Sets the time-out value for sending data collected from a device to the control system in Bridging Mode when a Start Delimiter and End Delimiter have been set. If no data has been collected for the specified time, the data is sent without waiting for the End Delimiter.

### Syntax

```
#set_send_time_out param1
```

### Parameters

<i>param1</i>	Serial port	[1 ... 2]
<i>param2</i>	Time out (ms)	[0 ... 255]

### Example

```
#set_send_time_out 1 30
UART 1 bridging sent Time Out is set to 30 ms
```

### Related Commands

```
#set_add_delim
#set_end_del
#set_serial_mode
#set_start_del
```

## #set\_serial\_descr

Assigns a descriptor to the specified serial port. The serial port description cannot exceed 20 characters in length. The default description is `None`.

### Syntax

```
#set_serial_descr param1 param2
```

### Parameters

<i>param1</i>	Port	[1 ... 2]
<i>param2</i>	Description	[20 chars max.]

### Example

```
#set_serial_descr 1 DVD_Ctrl  
Serial port 1 Description: DVD_Ctrl
```

### Related Commands

```
#show_serial_descr
```

## #set\_serial\_mode

Sets the mode of the specified serial port. The default mode for all serial ports (1 - 2) is *TCP Bridge* mode.

### Syntax

```
#set_serial_mode param1 param2
```

### Parameters

<i>param1</i>	Port	[1 ... 2]
<i>param2</i>	State	[1 ... 3]

Mode	Description
1	TCP bridge
2	UDP bridge
3	Terminal mode

### Example

```
#set_serial_mode 1 2  
Serial port 1 working mode is: TCP Bridge Mode
```

### Related Commands

```
#show_serial_mode
```

## #set\_serial\_params

Assigns the settings to the specified serial port.

### Syntax

```
#set_serial_params param1 param2 param3 param4 param5 param6
```

### Parameters

<i>param1</i>	Port	[1 ... 3]
<i>param2</i>	Word length	[5 ... 8]
<i>param3</i>	Stop bits	[1 ... 2]
<i>param4</i>	Parity	

Parity	Description
n	None
e	Even
o	Odd
m	Mark
s	Space

*param5*

Baud rate

Baud rate	
110	4800
300	9600
600	14400
1200	19200
2400	28800

*param6*

Line delay (ms) [0 ... 10000]

(continued on next page)

## Example

```
#set_serial_params 1 8 1 N 19200 1000
Serial port 1 parameters:
  Word length = 8 bits
  Stop bits = 1 bit
  Parity = None
  Baud Rate = 19200 Bps
  Line Delay = 1000 ms
```

## Related Commands

```
#show_serial_params
```

## #set\_start\_del

Sets the Start Delimiter mode and value for the specified serial port. The Start Delimiter must always be specified before the End Delimiter.

### Syntax

```
#set_start_del param1 param2 param3
```

### Parameters

<i>param1</i>	Serial port	[1 ... 2]
<i>param2</i>	State	[0 ... 1]

Mode	Description
1	TCP bridge
2	UDP bridge
3	Terminal mode

<i>param3</i>	Start delimiter	[00 ... FF]
---------------	-----------------	-------------

### Example

```
#set_start_del 1 1 a0
Start delimiter set to ON with a value of a0
```

### Related Commands

```
#set_add_delim
#set_end_del
```

## #set\_tcp\_br\_port

Sets the TCP bridge listening port for the specified serial port. The default port settings for RS-232 1 and RS-232 2 ports are 49200 and 49201, respectively.

### Syntax

```
#set_tcp_br_port param1 param2
```

### Parameters

<i>param1</i>	Serial port	[1 ... 2]
<i>param2</i>	TCP port	[1 ... 65535]

### Example

```
#set_tcp_br_port 1 49200  
TCP Bridge 1, port set to: 49200
```

### Related Commands

```
#set_tcp_term_port  
#set_udp_br_port
```

## #set\_tcp\_term\_port

Sets the TCP terminal listening port. The default port settings is 23.

### Syntax

```
#set_tcp_term_port param1
```

### Parameters

<i>param1</i>	TCP port	[1 ... 65535]
---------------	----------	---------------

### Example

```
#set_tcp_term_port 23  
New TCP Terminal port set to: 23
```

### Related Commands

```
#set_tcp_br_port  
#set_udp_br_port
```



## #set\_telnet\_pass

Sets the TCP Terminal password. The password cannot exceed 20 characters in length. *param3* is used to verify the new password. The default password is `Admin`.

### Syntax

```
#set_telnet_pass param1 param2 param3
```

### Parameters

<i>param1</i>	Old password	[20 chars max.]
<i>param2</i>	New password	[20 chars max.]
<i>param3</i>	New password	[20 chars max.]

### Example

```
#set_telnet_pass Admin b055man b055man  
TCP Terminal password updated to: b055man
```

### Related Commands

```
#set_tcp_br_port
```

## #set\_udp\_br\_port

Sets the UDP bridge listening port. The default UDP bridge port settings for RS-232 1 and RS-232 2 ports are 50200 and 50201, respectively.

### Syntax

```
#set_udp_br_port param1 param2
```

### Parameters

<i>param1</i>	Serial port	[1 ... 2]
<i>param2</i>	Port	[1 ... 65535]

### Example

```
#set_udp_br_port 1 50200
UDP Bridge 1, port set to: 50200
```

### Related Commands

```
#set_tcp_br_port
#set_tcp_term_port
#set_start_del
#set_udp_remote_br
#set_udp_rip
#set_udp_rport
```

## #set\_udp\_echo\_br

Enables or disables UDP bridge echo.

### Syntax

```
#set_udp_echo_br param1 param2
```

### Parameters

param1	Serial port	[1 ... 2]
param2	State	[0 ... 1]

State	Description
0	Disabled
1	Enabled

### Example

```
#set_udp_echo_br 1 1
```

The echo of UDP Bridge port 1 is enabled

### Related Commands

```
#set_udp_br_port
#set_udp_remote_br
#set_udp_rip
#set_udp_rport
```

## #set\_udp\_port

Sets the UDP server listening port

### Syntax

```
#set_udp_port param1
```

### Parameters

<i>param1</i>	Serial port	[1 ... 65535]
---------------	-------------	---------------

### Example

```
#set_udp_port 50007  
New UDP server port set to: 50007
```

### Related Commands

```
#set_udp_br_port  
#set_udp_remote_br  
#set_udp_echo_br  
#set_udp_rip  
#set_udp_rport
```

## #set\_udp\_remote\_br

Assigns the UDP Bridge settings for the specified serial port. *param2* must be entered in dot-decimal notation.

### Syntax

```
#set_udp_remote_br param1 param2 param3
```

### Parameters

<i>param1</i>	Serial port	[1 ... 2]
<i>param2</i>	Address	
<i>param3</i>	Remote port	[1 ... 65535]

### Example

```
#set_udp_remote_br 1 192.168.1.70 51000
Remote UDP bridge 1 set to: IP=192.168.1.70 Port=51000
```

### Related Commands

```
#set_udp_port
#set_udp_br_port
#set_udp_echo_br
#set_udp_rip
#set_udp_rport
```

## #set\_udp\_rip

Sets the remote UDP IP address. The IP address must be entered using dot-decimal notation. Each digit can range between 0 and 255.

### Syntax

```
#set_udp_rip param1
```

### Parameters

*param1* IP address

### Example

```
#set_udp_rip 192.168.1.205  
New Remote UDP IP set to: 192.168.1.205
```

### Related Commands

```
#set_udp_br_port  
#set_udp_echo_br  
#set_udp_remote_br  
#set_udp_echo_br
```

## #set\_udp\_rport

Sets the remote UDP listening port. The default port settings is 50008.

### Syntax

```
#set_udp_rport param1
```

### Parameters

<i>param1</i>	Port	[1 ... 65535]
---------------	------	---------------

### Example

```
#set_udp_rport 50006  
New UDP Remote port set to: 50006
```

### Related Commands

```
#set_udp_br_port  
#set_udp_echo_br  
#set_udp_remote_br  
#set_udp_rip
```

## #show\_del\_prms

Displays the current delimiter parameters for the specified serial port.

### Syntax

```
#show_del_prms param1
```

### Parameters

<i>param1</i>	Port	[1 ... 2]
---------------	------	-----------

### Example

```
#show_del_prms 1
Delimiter Param's in bridge mode, UART 1
  Line Delay = 1000ms
  Time To Force Send = 30ms
  Count Byte To Force Send = 100
  Add Delimiters In Data = False
  Use Start Delimiter = False
  Start Delimiter Size = 1
  Start Delimiter Value = A0
  Use End Delimiter = True
  End Delimiter Size = 1
  Start Delimiter Value = B0
```

### Related Commands

```
#set_add_delim
#set_end_del
#set_send_byte_cnt
#set_send_time_out
#set_serial_params
#set_start_del
```



## #show\_device\_descr

Displays the device description.

### Syntax

```
#show_device_descr
```

### Parameters

*None*

### Example

```
#show_device_descr  
Device Description: IP_BRIDGE
```

### Related Commands

```
#set_device_descr
```

## #show\_ipconfig

Displays the current TCP/IP and UDP settings.

### Syntax

```
#show_ipconfig
```

### Parameters

*None*

### Example

```
#show_ipconfig

----- IP to 2 x RS-232 Converter settings -----
MAC addr = 00:1C:91:01:0F:FF
IP addr = 10.5.64.254
Net Mask = 255.255.255.0
Gateway = 192.168.1.254
Web Server Port = 80
TCP Terminal Server Port = 23
TCP Terminal Access = Enabled
TCP Terminal password at login is set to OFF
UDP Access = Disabled
UDP Server Port = 50007
Enable UDP Echo = Disabled
UDP Remote IP = 192.168.1.80
UDP Remote Port = 50008
TCP Bridge 1 Port = 49200
TCP Bridge 2 Port = 49201
UDP Local Bridge 1 Port = 50200
UDP Remote Bridge 1 IP = 192.168.1.180, Port = 50000
UDP Remote Bridge 1 Echo = Disabled
UDP Local Bridge 2 Port = 50201
UDP Remote Bridge 2 IP = 192.168.1.181, Port = 50001
UDP Remote Bridge 2 Echo = Disabled
Discovery Mode: Enabled
```

### Related Commands

#set_gateway	#set_udp_br_port	#use_discovery
#set_http_port	#set_udp_echo_br	#use_tcp_access
#set_ipadd	#set_udp_port	#use_tcp_term_pass
#set_netmask	#set_udp_remote_br	#use_udp_access
#set_tcp_br_port	#set_udp_rip	#use_udp_echo
#set_tcp_term_port	#set_udp_rport	

## #show\_me

Enables or disables the flashing of the LED on the device. When enabled, the LED indicator will flash red and blue. The default setting is disabled.

### Syntax

```
#show_me param1
```

### Parameters

*param1*

State

State	Description
0	Disabled
1	Enabled

### Example

```
#show_me 1  
Show me is Enabled
```

### Related Commands

```
#use_discovery
```

## #show\_serial\_descr

Displays the description of the specified serial port.

### Syntax

```
#show_serial_descr param1
```

### Parameters

<i>param1</i>	Port	[1 ... 2]
---------------	------	-----------

### Example

```
#show_serial_descr 1  
Serial port 1 Description: DVD_Ctrl
```

### Related Commands

```
#set_serial_descr
```

## #show\_serial\_mode

Displays the mode of the specified serial port.

### Syntax

```
#show_serial_mode param1
```

### Parameters

<i>param1</i>	Port	[1 ... 2]
---------------	------	-----------

### Example

```
#show_serial_mode 1  
Serial port 1 working mode is: TCP Bridge Mode
```

### Related Commands

```
#set_serial_mode
```

## #show\_serial\_params

Displays the current settings of the specified serial port.

### Syntax

```
#show_serial_params param1
```

### Parameters

<i>param1</i>	Port	[1 ... 2]
---------------	------	-----------

### Example

```
#show_serial_params 1
Serial port 1 parameters:
  Word length = 8 bits
  Stop bits = 1 bit
  Parity = None
  Baud Rate = 19200 Bps
  Line Delay = 1000 ms
```

### Related Commands

```
#set_serial_params
```

## #show\_telnet\_pass

Displays the current TCP terminal password.

### Syntax

```
#show_telnet_pass
```

### Parameters

*None*

### Example

```
#show_telnet_pass  
TCP Terminal password: b055man
```

### Related Commands

```
#set_telnet_pass
```

## #show\_ver\_data

Displays the current software and hardware version.

### Syntax

```
#show_ver_data
```

### Parameters

*None*

### Example

```
#show_ver_data  
Firmware version 1.48  
Release date: May 12 2014  
Release time: 14:09:37
```



## #system\_wide\_reset

Restarts the IP to 2 x RS-232 Converter according to the supplied parameter.

### Syntax

```
#system_wide_reset param1
```

### Parameters

*param1* Value [0 ... 3]

Value	Description
0	Reboot only
1	Reset IP settings
2	Reset serial port settings
3	Reset all and reboot

### Example

```
#system_wide_reset 3
```

```
System wide reset in progress.
```

```
Please wait...
```

```
Finish selected operation.
```

```
Device will be reset and all connections will be closed.
```

## #use\_discovery

Enables or disables discovery access mode. If this mode is disabled, then the IP to 2 x RS-232 Converter will not be discoverable when using the Gefen Discovery Tool. The default setting is *enabled*.

### Syntax

```
#use_discovery param1
```

### Parameters

param1 State

State	Description
0	Discovery access disabled
1	Discovery access enabled

### Example

```
#use_discovery 1  
Discovery Access is set to Enabled
```

### Related Commands

```
#show_me
```

## #use\_tcp\_access

Enables or disables TCP access mode. This mode must be enabled before using RS-232 command to configure the IP to 2 x RS-232 Converter.

### Syntax

```
#use_tcp_access param1
```

### Parameters

*param1* Value [0 ... 1]

Value	Description
0	Disable TCP access
1	Enable TCP access

### Example

```
#use_tcp_access 1
TCP Access is set to Enabled
```

### Related Commands

```
#set_tcp_br_port
#set_tcp_term_port
#set_telnet_pass
#use_tcp_term_pass
```

## #use\_tcp\_term\_pass

Enables or disables the use of the password during terminal sessions.

### Syntax

```
#use_tcp_term_pass param1
```

### Parameters

*param1* Value [0 ... 1]

Value	Description
0	Do not use password
1	Require password

### Example

```
#use_tcp_term_pass 1  
TCP Terminal password at login is set to ON
```

### Related Commands

```
#set_tcp_br_port  
#set_tcp_term_port  
#set_telnet_pass  
#use_discovery
```

## #use\_udp\_access

Enables or disables UDP access.

### Syntax

```
#use_udp_access param1
```

### Parameters

*param1* Value [0 ... 1]

Value	Description
0	Disable UDP access
1	Enable UDP access

### Example

```
#use_udp_access 1  
UDP Access is set to Enabled
```

### Related Commands

```
#set_udp_br_port  
#set_udp_echo_br  
#set_udp_remote_br  
#set_udp_rip  
#set_udp_rport
```

## #use\_udp\_echo

Enables or disables UDP echo.

### Syntax

```
#use_udp_echo param1
```

### Parameters

*param1* Value [0 ... 1]

Value	Description
0	Disable UDP echo
1	Enable UDP echo

### Example

```
#use_udp_echo 1
UDP echo is set to Enabled
```

### Related Commands

```
#set_udp_echo_br
```

## Using the built-in Web Interface

Access the built-in Web interface by entering the IP address of the IP to 2 x RS-232 Converter that was specified in step 3 under [Configuration using RS-232 \(page 9\)](#).

The built-in Web interface is divided into three pages: **RS-232**, **Network**, and **System**. Each main page is represented by a tab at the top of the screen. The RS-232 page will always be displayed first.

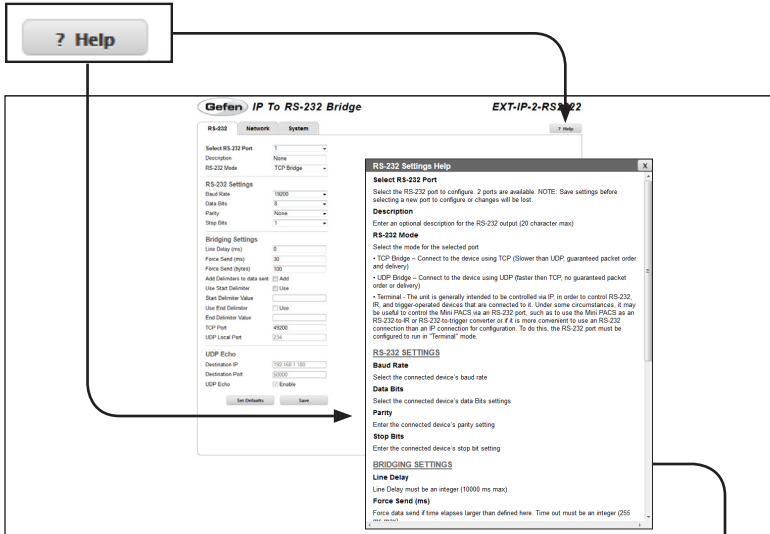

### Help

Click the **Help** button to display context-sensitive help for the current page. The help window can be moved to any position within the Web browser window.

### RS-232 Settings Help

**Select RS-232 Port**

Select the RS-232 port to configure. 2 ports are available. NOTE: Save settings before selecting a new port to configure or changes will be lost.

**Description**

Enter an optional description for the RS-232 output (20 character max)

**RS-232 Mode**

Select the mode for the selected port

- TCP Bridge – Connect to the device using TCP (Slower than UDP, guaranteed packet order and delivery)
- UDP Bridge – Connect to the device using UDP (faster than TCP, no guaranteed packet order or delivery)

**RS-232 SETTINGS**

**Baud Rate**

Select the connected device's baud rate

**Data Bits**

Select the connected device's data bits settings

**Parity**

Select the connected device's parity setting

**Stop Bits**

Select the connected device's stop bit setting

**BRIDGING SETTINGS**

**Line Delay**

Line Delay must be an integer (10000 ms max)

**Force Send (ms)**

Force data send if time elapses larger than defined here. Time out must be an integer (255 ms max)

## RS-232

Select RS-232 Port	1
Description	None
RS-232 Mode	TCP Bridge

The screenshot shows the 'System' configuration page for 'EXT-IP-2-RS232'. The 'RS-232 Settings' section is expanded, showing the following configuration:

- Select RS-232 Port: 1
- Description: None
- RS-232 Mode: TCP Bridge
- RS-232 Settings:
  - Baud Rate: 19200
  - Data Bits: 8
  - Parity: None
  - Stop Bits: 1
- Linking Settings:
  - Line Delay (ms): 0
  - Frame Send (ms): 30
  - Frame Send (bytes): 100
  - Add Delimiters to data sent:  Add
  - Use Start Delimiter:  Use
  - Start Delimiter Value:
  - Use End Delimiter:  Use
  - End Delimiter Value:
  - TCP Port: 43000
  - UDP Local Port: 231
- UDP Echo:
  - Destination IP: 192.168.1.100
  - Destination Port: 50000
  - UDP Echo:  Enable

Buttons for 'Set Defaults' and 'Save' are visible at the bottom of the configuration area.

**Select RS-232 Port**

Select the RS-232 port from the drop-down list.

Options: 1, 2

**Description**

Enter a description for the device that is connected to the selected RS-232 port.

**RS-232 Mode**

Select the desired mode from the drop-down list.

Options: TCP Bridge, UDP Bridge, Terminal



RS-232 Settings	
Baud Rate	19200
Data Bits	8
Parity	None
Stop Bits	1

**Gefen IP To RS-232 Bridge** EXT-IP-2-RS232

RS-002 Network System

Select RS-232 Port: 1

Description: None

RS-232 Mode: TCP Bridge

**RS-232 Settings**

Baud Rate: 19200

Data Bits: 8

Parity: None

Stop Bits: 1

**Bridging Settings**

Line Delay (ms): 0

Frame Send (ms): 30

Frame Send (bytes): 100

Add Delimiter to data send: [X] Add

Use Start Delimiter:  Use

Start Delimiter Value:

Use End Delimiter:  Use

End Delimiter Value:

UCP Port: 40000

UCP Link Port: 231

**UCP Echo**

Destination IP: 192.168.1.100

Destination Port: 8080

UCP Echo:  Enable

### Baud Rate

Select the baud rate used by the RS-232 device from this drop-down list.

Options: 110, 300, 600, 1200, 2400, 4800, 9600, 14400, 19200, 28800

### Data Bits

Select the number of data bits in each character from this drop-down list. For most applications, 8 data bits should be selected. 9 data bits are rarely used.

Options: 8, 9

### Parity

Select the parity bit type from this drop-down list.

Options: None, Even, Even Stick, Odd, Odd Stick

### Stop Bits

Select the number of stop bits from this drop-down list.

Options: 1, 2

### Bridging Settings

Line Delay (ms)

Force Send (ms)

Force Send (bytes)

Add Delimiters to data sent  Add

Use Start Delimiter  Use

Start Delimiter Value

Use End Delimiter  Use

End Delimiter Value

TCP Port

UDP Local Port

RS-232 Settings

RS-232 Mode: TCP Bridge

RS-232 Settings

Start Rate: 10000

Data Bits: 8

Parity: None

Stop Bits: 1

Bridging Settings

Line Delay (ms): 0

Force Send (ms): 30

Force Send (bytes): 100

Add Delimiters to data sent:  Add

Use Start Delimiter:  Use

Start Delimiter Value:

Use End Delimiter:  Use

End Delimiter Value:

TCP Port: 49200

UDP Local Port: 234

UDP Echo

Destination IP: 192.168.1.100

Destination Port: 8080

UDP Echo:  Enable

**Line Delay (ms)**

Enter the line delay in this field.

Range: 0 ... 10000

**Force Send (ms)**

If no data is received from the controlled device within the specified time interval, send the collected data to the control system.

Range: 0 ... 30

**Force Send (bytes)**

If the specified number of bytes is received from the controlled device, send the collected data to the control system.

Range: 0 ... 255

<b>Bridging Settings</b>	
Line Delay (ms)	<input type="text" value="0"/>
Force Send (ms)	<input type="text" value="30"/>
Force Send (bytes)	<input type="text" value="100"/>
Add Delimiters to data sent	<input checked="" type="checkbox"/> Add
Use Start Delimiter	<input checked="" type="checkbox"/> Use
Start Delimiter Value	<input type="text"/>
Use End Delimiter	<input type="checkbox"/> Use
End Delimiter Value	<input type="text"/>
TCP Port	<input type="text" value="49200"/>
UDP Local Port	<input type="text" value="234"/>

**Add Delimiters to data sent**

Include the delimiter characters in the data sent to the control system. Check the **Add** box to enable this feature.

Options: [Enable \(checked\)](#), [Disable \(unchecked\)](#)

**Use Start Delimiter**

Includes the Start Frame Delimiter, used at the end of the preamble of an Ethernet frame.

Options: [Enable \(checked\)](#), [Disable \(unchecked\)](#)

**Start Delimiter Value**

This value can be up to three ASCII characters (3 bytes), in length. The value must be entered in hexadecimal (e.g 0D0A, which is CR + LF). The Start (Frame) Delimiter Value is used by some control systems to filter incoming data. Contact Gefen Technical Support for details if you need to use them.

Range: 00 ... FF ("wildcard" characters, such as \*\*, are acceptable)

**Use End Delimiter**

Includes the End Frame Delimiter, used at the end of a transmission frame.

Options: [Enable \(checked\)](#), [Disable \(unchecked\)](#)

<b>Bridging Settings</b>	
Line Delay (ms)	<input type="text" value="0"/>
Force Send (ms)	<input type="text" value="30"/>
Force Send (bytes)	<input type="text" value="100"/>
Add Delimiters to data sent	<input checked="" type="checkbox"/> Add
Use Start Delimiter	<input checked="" type="checkbox"/> Use
Start Delimiter Value	<input type="text"/>
Use End Delimiter	<input type="checkbox"/> Use
End Delimiter Value	<input type="text"/>
TCP Port	<input type="text" value="49200"/>
UDP Local Port	<input type="text" value="234"/>

**End Delimiter Value**

This value can be up to three ASCII characters (3 bytes), in length. The value must be entered in hexadecimal

Range: 00 ... FF ("wildcard" characters, such as \*\*, are acceptable)

**TCP Port**

Enter the TCP port in this field.

Range: 0 ... 65535

**UDP Local Port**

Enter the UPD local port in this field.

Range: 1024 ... 65535

**Destination IP**

Enter the destination (where the data will be sent) IP address in this field.

Range (per byte): 0 ... 255

**Destination Port**

Enter the destination port in this field.

Range: 1024 ... 65535

**UDP Echo**

Useful in troubleshooting and measuring response times and end-to-end connectivity.

Options: [Enable \(checked\)](#), [Disable \(unchecked\)](#)

**Set Defaults**

Click this button to reset RS-232 settings to their default values.

**Save**

Click this button to save any changes.

## Network tab

**IP Settings**

MAC Address: 00:1C:91:02:20:03

Mode:

IP Address:

Subnet:

Gateway:

HTTP Port:

RS-232 Network System

IP Settings

MAC Address: 00:1C:91:02:20:03

Mode:

IP Address: 192.168.1.72

Subnet: 255.255.255.0

Gateway: 192.168.1.254

HTTP Port: 80

TCP/Telnet Settings

Enable TCP Access:

Require Password on Connect:

User Name: Admin

Old Password:

New Password:

Confirm New Password:

Terminal Port: 23

UDP Settings

Enable UDP Access:

UDP Port: 8

Enable UDP Echo:

Destination UDP IP Address: 192.168.1.129

Destination UDP Port: 50000

Discovery Protocol Settings

Enable Discovery:

**MAC Address**

The MAC address of the IP to RS-232 Converter. The MAC address cannot be changed.

**Mode**

Select the network mode from the drop-down list.

Options: [Static](#), [DHCP](#)

**IP Address**

Enter the IP address of the IP to 2 x RS-232 Converter.

Range (per byte): 0 ... 255

**Subnet**

Enter the subnet mask of the IP to 2 x RS-232 Converter.

Range (per byte): 0 ... 255

<b>IP Settings</b>	
MAC Address	00:1C:91:02:20:03
Mode	<input type="text" value="Static"/>
IP Address	<input type="text" value="192.168.1.72"/>
Subnet	<input type="text" value="255.255.255.0"/>
Gateway	<input type="text" value="192.168.1.254"/>
HTTP Port	<input type="text" value="80"/>

**Gateway**

The gateway (router) IP address to which the IP to 2 x RS-232 Converter is connected.

Range (per byte): 0 ... 255

**HTTP Port**

Select the network mode from the drop-down list.

Range (per byte): 1 ... 1024

### TCP/Telnet Settings

Enable TCP Access

Require Password on Connect

User Name

Old Password

New Password

Confirm New Password

Terminal Port

2322

1. Help

IP Address 192.168.1.2322

Mask 255.255.255.0

IP Address 192.168.1.72

Subnet 255.255.255.0

Gateway 192.168.1.254

HTTP Port 80

TCP/Telnet Settings

Enable TCP Access

Require Password on Connect

User Name

Old Password

New Password

Confirm New Password

Terminal Port

UDP Settings

Enable UDP Access

UDP Port

Enable UDP Echo

Destination UDP IP Address

Destination UDP Port

Discovery Protocol Settings

Enable Discovery

[View Network Configuration](#)

### Enable TCP Access

Enables or disables TCP access.

Options: [Enable \(checked\)](#), [Disable \(unchecked\)](#)

### Require Password on Connect

Forces password prompt for Telnet sessions.

Options: [Enable \(checked\)](#), [Disable \(unchecked\)](#)

### User Name

Displays the user name for TCP sessions. The user name cannot be changed.

### Old Password

Type the current (old) password in this field. The password is automatically masked when entered. The password is case-sensitive. The default password is `Admin`.

Maximum length: **8 characters**



TCP/Telnet Settings	
Enable TCP Access	<input checked="" type="checkbox"/>
Require Password on Connect	<input checked="" type="checkbox"/>
User Name	Admin
Old Password	<input type="text"/>
New Password	<input type="text"/>
Confirm New Password	<input type="text"/>
Terminal Port	23 <input type="text"/>

**New Password**

Type the new password in this field. The password is automatically masked when entered. The password is case-sensitive.

Maximum length: [8 characters](#)

**Confirm Password**

Re-type the new password in this field. The password *must* match the same password that was entered in the **New Password** field.

Maximum length: [8 characters](#)

**Terminal Port**

Type the Telnet listening port in this field.

Range: [1 ... 1024](#)

### UDP Settings

Enable UDP Access

UDP Port

Enable UDP Echo

Destination UDP IP Address

Destination UDP Port

---

### Discovery Protocol Settings

Enable Discovery

---

2322

File...

---

TCP/Telnet Settings

Enable Telnet Access

Require Password on Connect

User Name

Old Password

New Password

Confirm New Password

Terminal Port

---

UDP Settings

Enable UDP Access

UDP Port

Enable UDP Echo

Destination UDP IP Address

Destination UDP Port

---

Discovery Protocol Settings

Enable Discovery

### Enable UDP Access

Enables or disables UDP access.

Options: [Enable \(checked\)](#), [Disable \(unchecked\)](#)

### UDP Port

Sets the UDP port.

Range: 1 ... 1024

### Enable UDP Echo

Enables or disables UDP echo.

Options: [Enable \(checked\)](#), [Disable \(unchecked\)](#)

### UDP Settings

Enable UDP Access	<input checked="" type="checkbox"/>
UDP Port	<input type="text" value="8"/>
Enable UDP Echo	<input checked="" type="checkbox"/>
Destination UDP IP Address	<input type="text" value="192.168.1.129"/>
Destination UDP Port	<input type="text" value="50008"/>

---

### Discovery Protocol Settings

Enable Discovery	<input checked="" type="checkbox"/>
------------------	-------------------------------------

---

#### Destination UDP IP Address

Enter the remote UDP IP address in this field.

Range (per byte): 0 ... 255

#### Destination UDP Port

Type the remote UDP port in this field.

Range: 1 ... 1024

#### Enable Discovery

Enables or disables discovery mode. This feature must be enabled in order for the Gefen Discovery Tool to detect the unit on a network.

Options: [Enable \(checked\)](#), [Disable \(unchecked\)](#)

## System tab

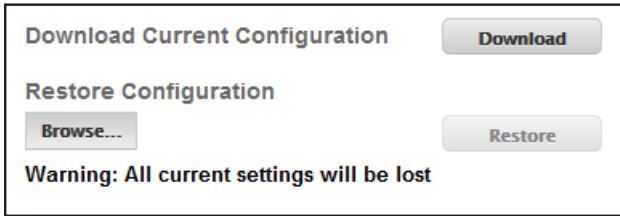
**Download (Download Current Configuration)**

Saves the current configuration of the IP to 2 x RS-232 Converter to a file.

**Browse... (Restore Configuration)**

Selects the configuration file to load. See the **Download** button, above.

**Restore**

Click this button to upload the selected configuration file to the IP to 2 x RS-232 Converter.

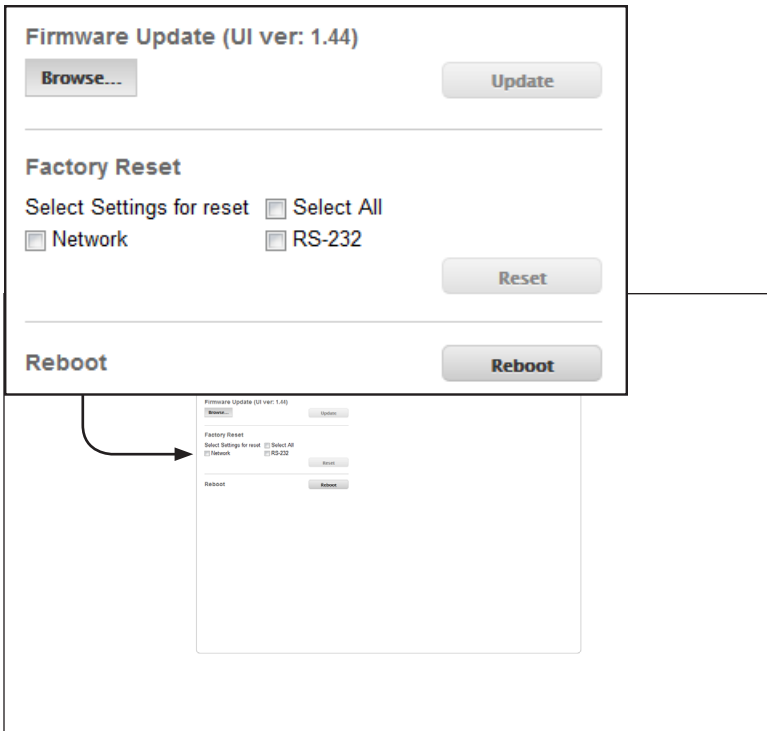

### Browse... (Firmware Update)

Click this button to select the firmware file to be uploaded.

### Update

Click this button to upload the selected firmware file. See the **Browse...** button, above.

### Factory Reset

Use these check boxes to select the type of factory-reset to perform. Placing a check mark in the desired check box will select the type of reset:

Options: [Select All](#) (resets network and RS-232 settings),  
[Network](#) (resets IP settings only), [RS-232](#) (resets RS-232 settings only)

### Reset

Click this button to reset the selected options to factory-default settings.

### Reboot

Click this button to reboot the IP to 2 x RS-232 Converter.



# IP to RS-232 Converter

## 3

## Appendix

Default Settings .....	70
RS-232 .....	70
Network .....	71
Specifications .....	72

The following table lists the default setting of the IP to 2 x RS-232 Converter, as displayed under the built-in Web interface.

## RS-232

RS-232 Settings	
Select RS-232 Port	• 1
Description	• None
RS-232 Mode	• TCP Bridge
Baud Rate	• 19200
Data Bits	• 8
Parity	• None
Stop Bits	• 1
Bridging Settings	
Line Delay (ms)	• 0
Force Send (ms)	• 30
Force Send (bytes)	• 100
Add Delimiters to data sent	• Disabled
Use Start Delimiter	• Disabled
Start Delimiter Value	• 0
Use End Delimiter	• Disabled
End Delimiter Value	• 0
TCP Port	• 49200
UDP Local Port	• 50200
UDP Echo	
Destination IP	• 192.168.1.180
Destination Port	• 50000
UDP Echo	• Disabled



## Network

IP Settings	
MAC Address	• Device-dependent (cannot be changed)
Mode	• Static
IP Address	• 192.168.1.72
Subnet	• 255.255.255.0
Gateway	• 192.168.1.254
HTTP Port	• 80
TCP / Telnet Settings	
Enable TCP Access	• Disabled
Require Password on Connect	• Disabled
User Name	• Admin (cannot be changed)
Old Password	• (default password is "Admin")
New Password	• ---
Confirm New Password	• ---
Terminal Port	• 23
UDP Settings	
Enable UDP Access	• Disabled
UDP Port	• 50007
Enable UDP Echo	• Disabled
Destination UDP IP Address	• 192.168.1.80
Destination UDP Port	• 50008
Enable Discovery	• Enabled

## Connectors, Indicators, and Controls

RS-232	<ul style="list-style-type: none"><li>• 2 x DB-9, male</li></ul>
IP control	<ul style="list-style-type: none"><li>• 1 x RJ-45</li></ul>
Power	<ul style="list-style-type: none"><li>• 1 x 5V DC, locking</li></ul>
Power indicator	<ul style="list-style-type: none"><li>• 1 x LED, blue</li></ul>
IP Reset button	<ul style="list-style-type: none"><li>• 1 x Tact-type, recessed</li></ul>

## Operational

Power	<ul style="list-style-type: none"><li>• 5V DC</li></ul>
Power consumption	<ul style="list-style-type: none"><li>• 1W (max.)</li></ul>

## Physical

Dimensions (W x H x D)	<ul style="list-style-type: none"><li>• 4.3" x 1" x 3.4" (110mm x 26mm x 86mm)</li></ul>
Unit Weight	<ul style="list-style-type: none"><li>• 0.35 lbs. (0.16 kg)</li></ul>





20600 Nordhoff St., Chatsworth CA 91311  
1-800-545-6900 818-772-9100 fax: 818-772-9120  
[www.gefen.com](http://www.gefen.com) [support@gefen.com](mailto:support@gefen.com)

## Free Manuals Download Website

<http://myh66.com>

<http://usermanuals.us>

<http://www.somanuals.com>

<http://www.4manuals.cc>

<http://www.manual-lib.com>

<http://www.404manual.com>

<http://www.luxmanual.com>

<http://aubethermostatmanual.com>

Golf course search by state

<http://golfingnear.com>

Email search by domain

<http://emailbydomain.com>

Auto manuals search

<http://auto.somanuals.com>

TV manuals search

<http://tv.somanuals.com>